

PB194 PROTON ACER TENDL-2023 LIBRARY; T=0.K  
Principal cross sections

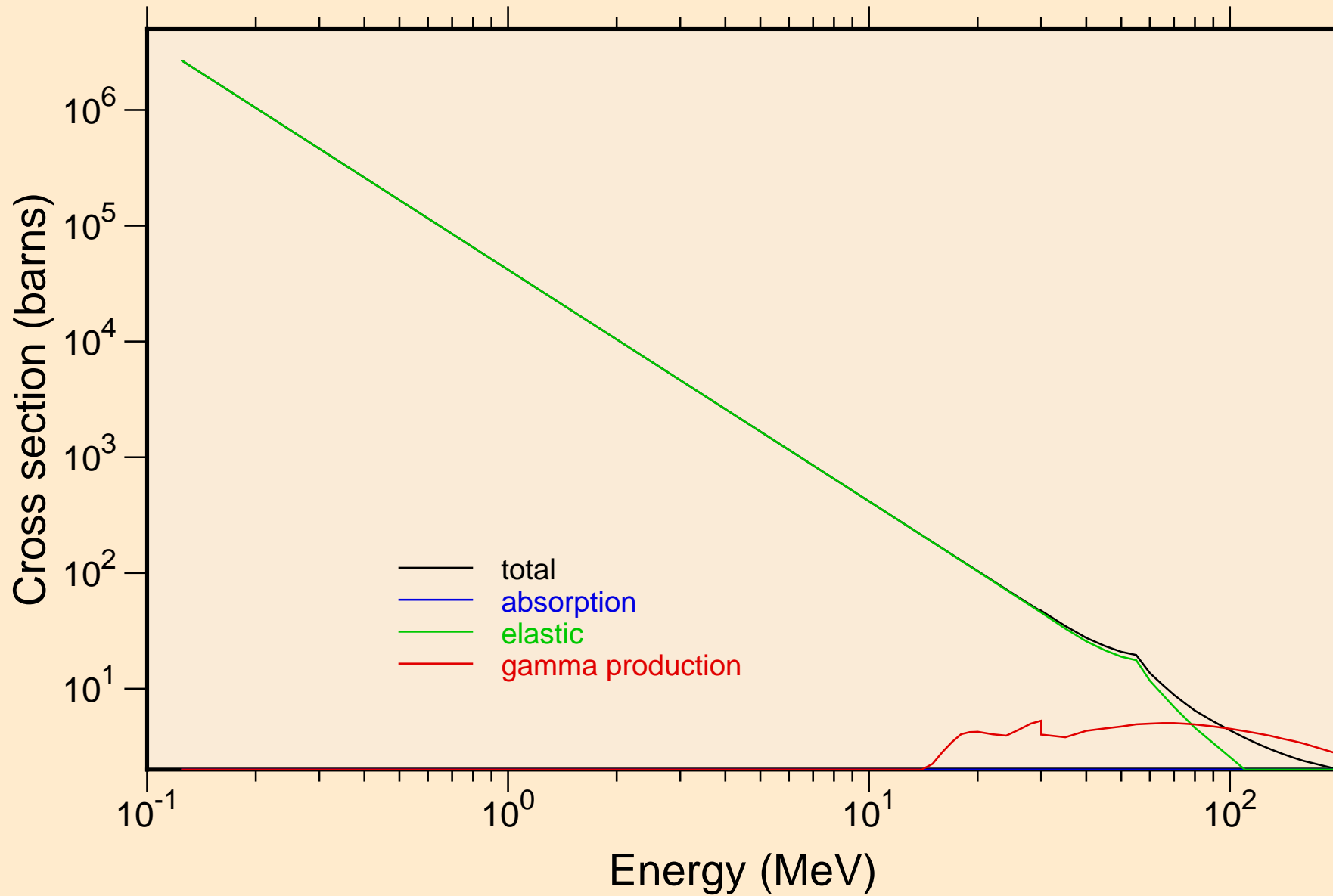

PB194 PROTON ACER TENDL-2023 LIBRARY; T=0.K  
Heating

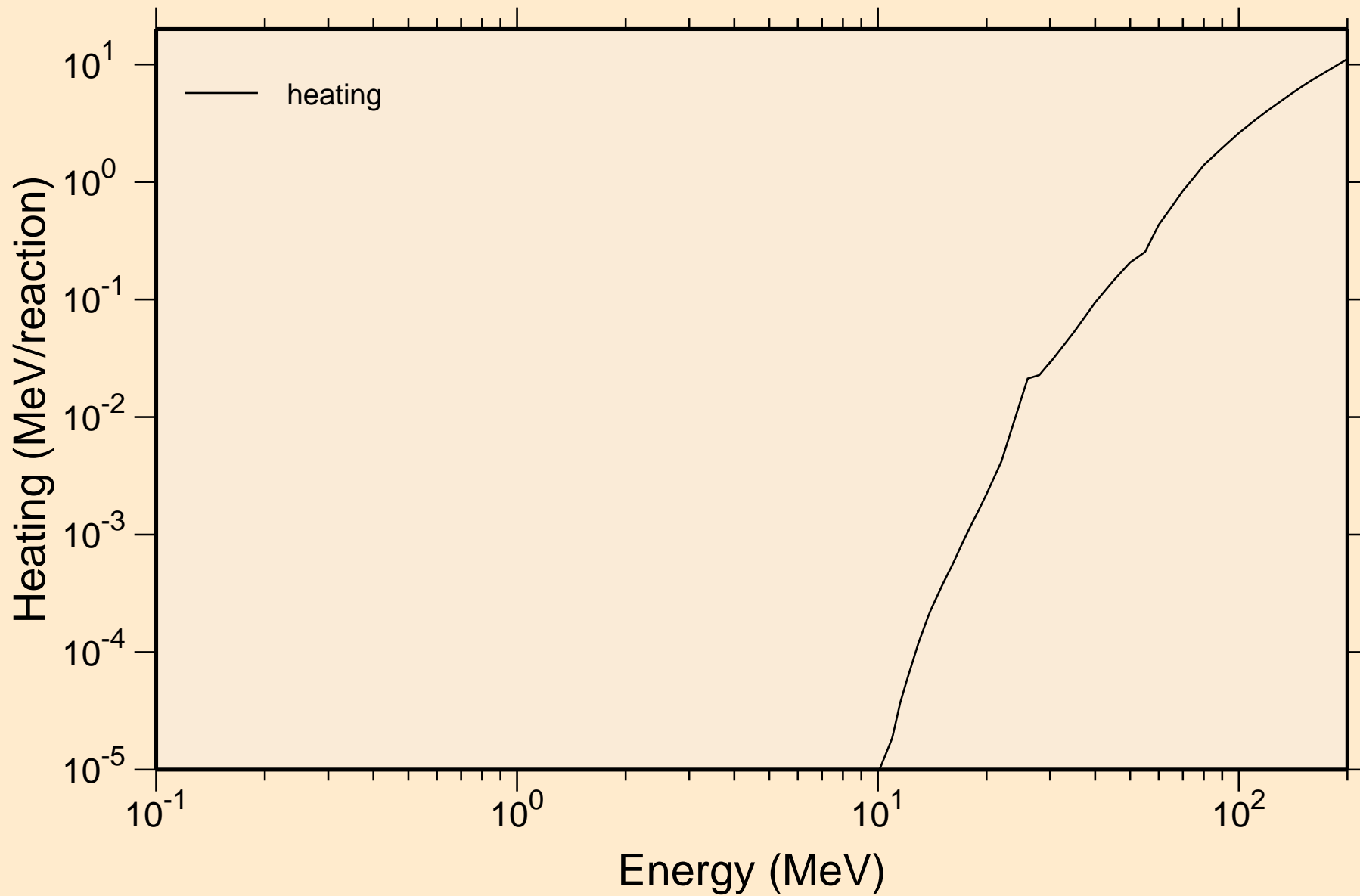

# PB194 PROTON ACER TENDL-2023 LIBRARY; T=0.K

## Principal cross sections

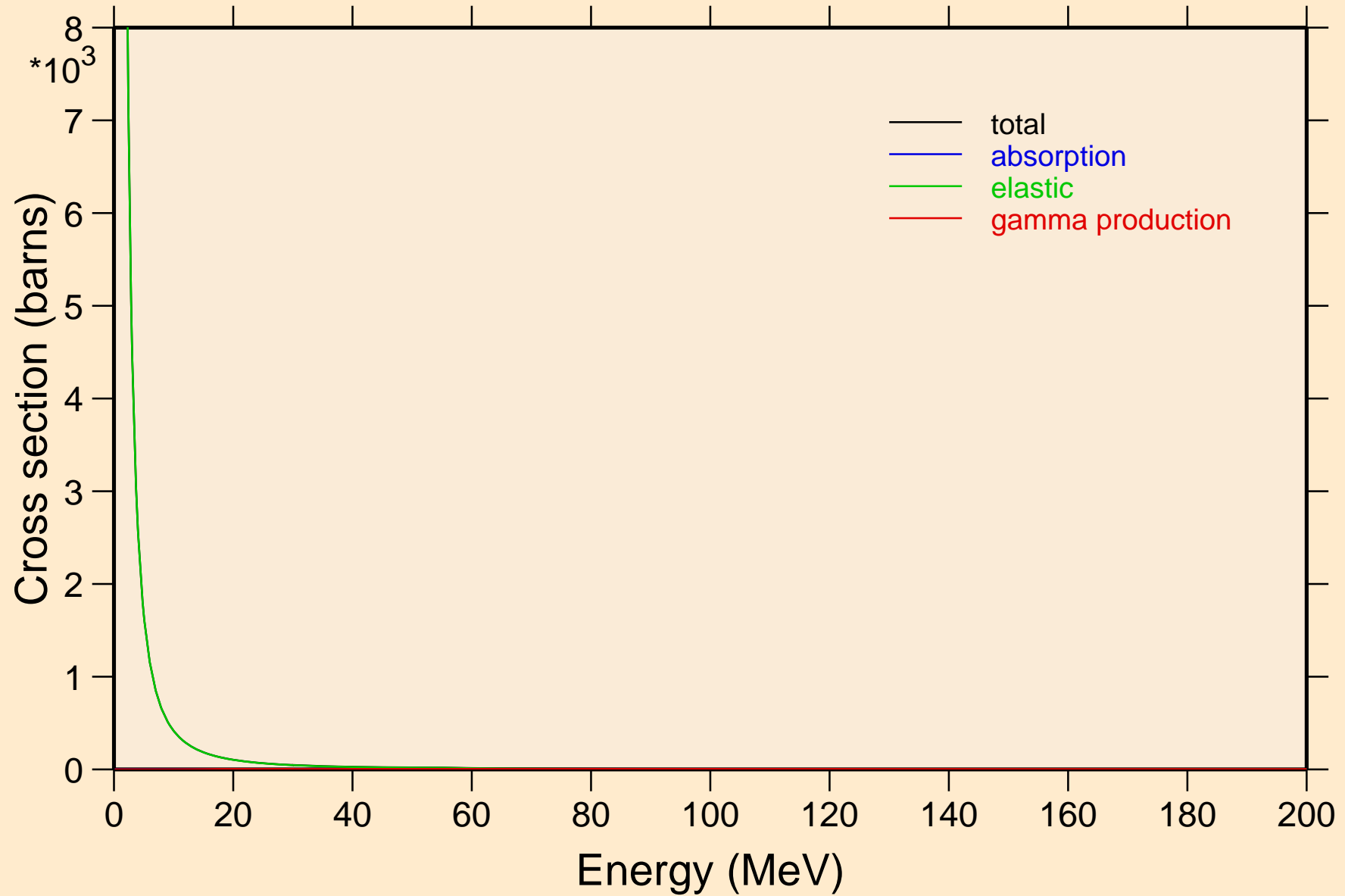

PB194 PROTON ACER TENDL-2023 LIBRARY; T=0.K

Heating

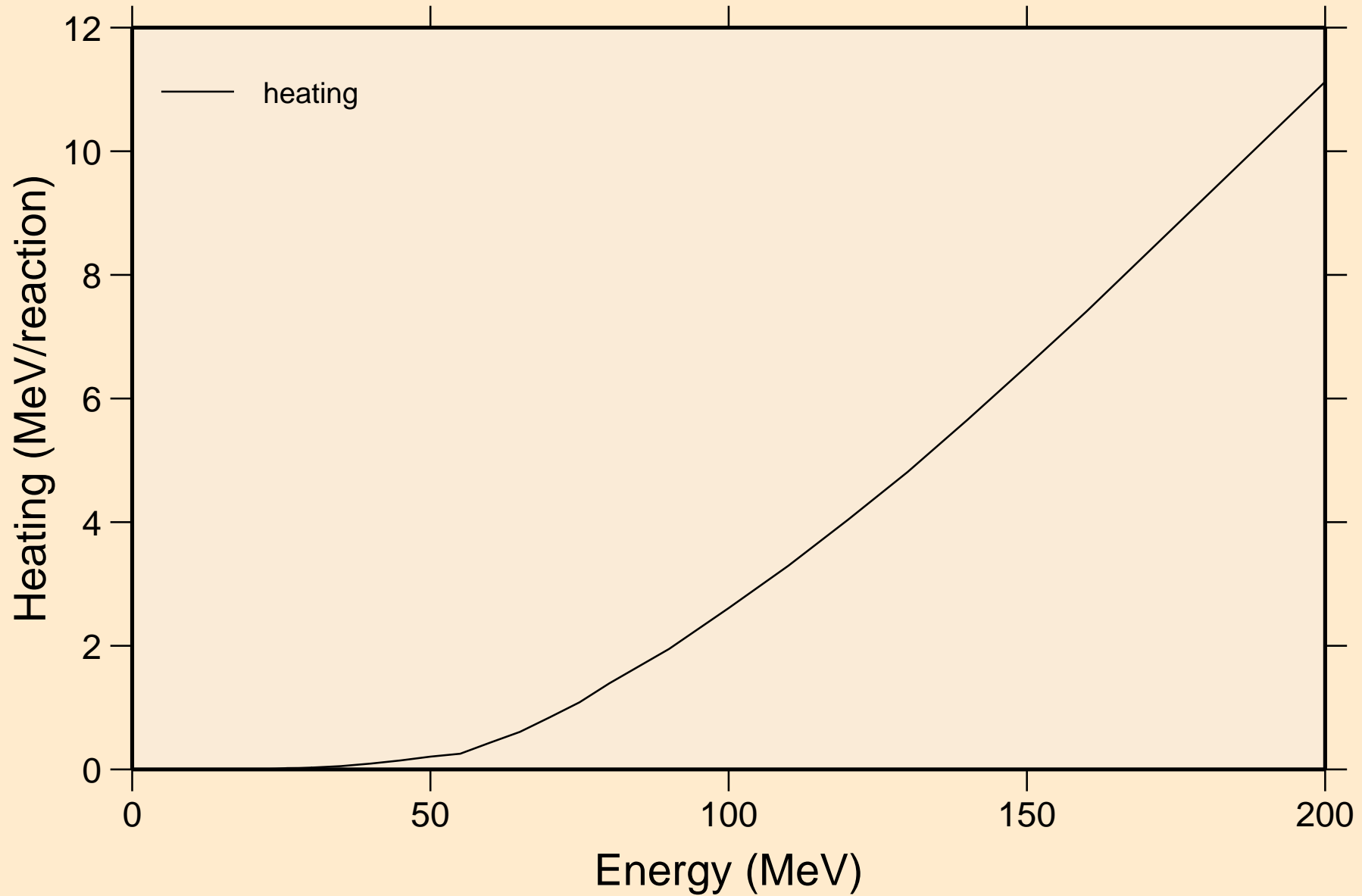

# PB194 PROTON ACER TENDL-2023 LIBRARY; T=0.K

## Threshold reactions

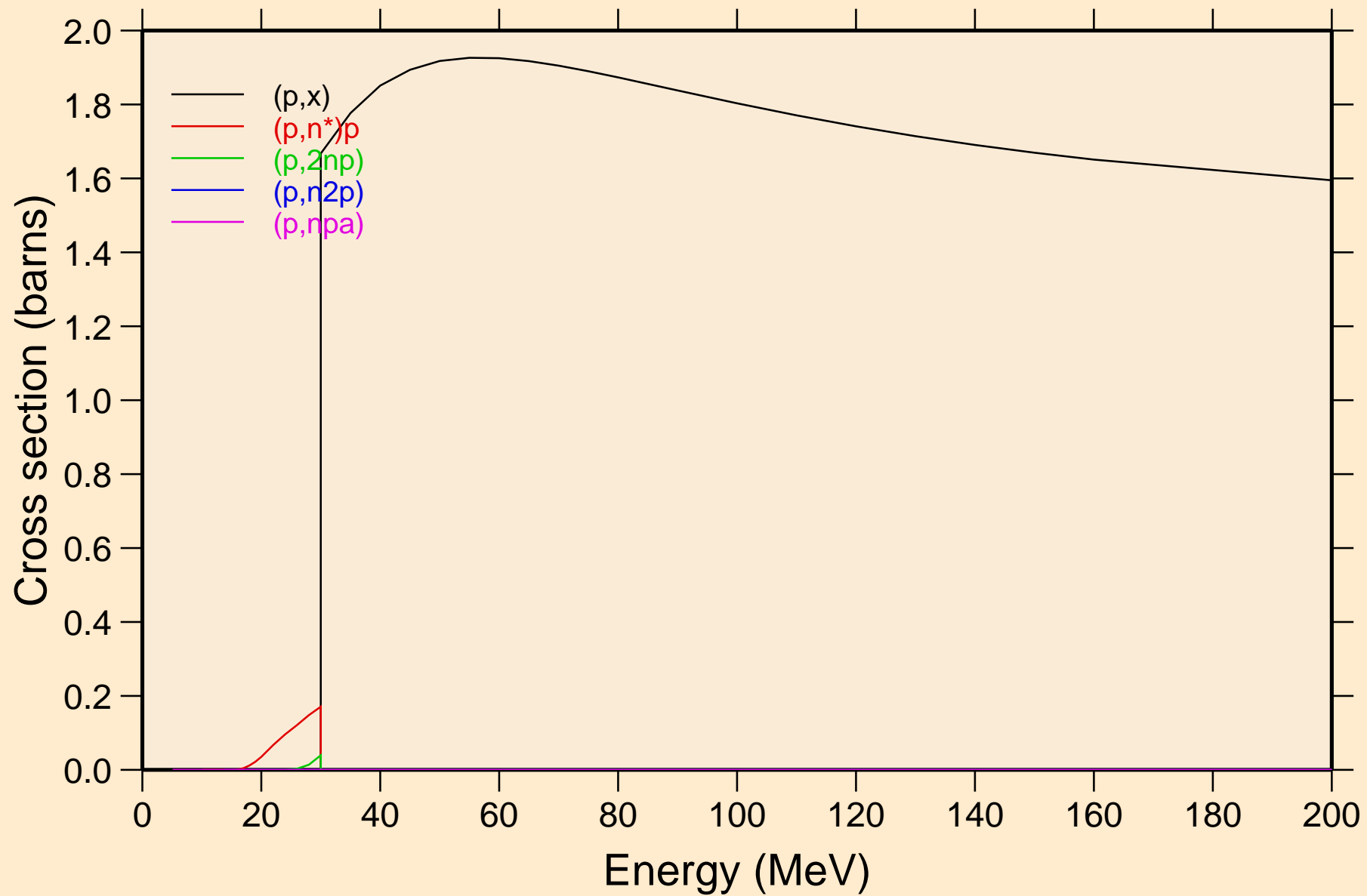

PB194 PROTON ACER TENDL-2023 LIBRARY; T=0.K  
Threshold reactions

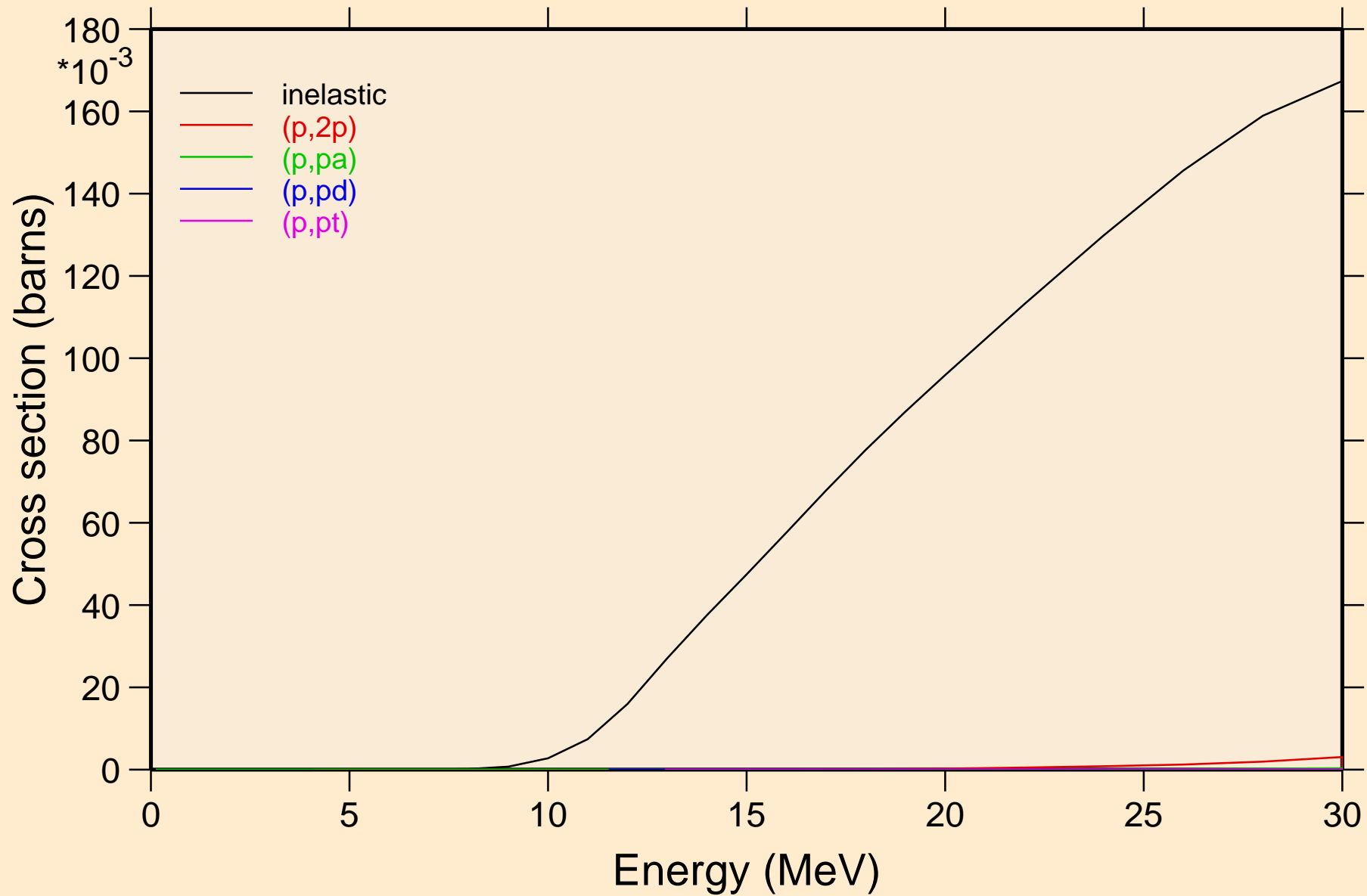

PB194 PROTON ACER TENDL-2023 LIBRARY; T=0.K  
Threshold reactions

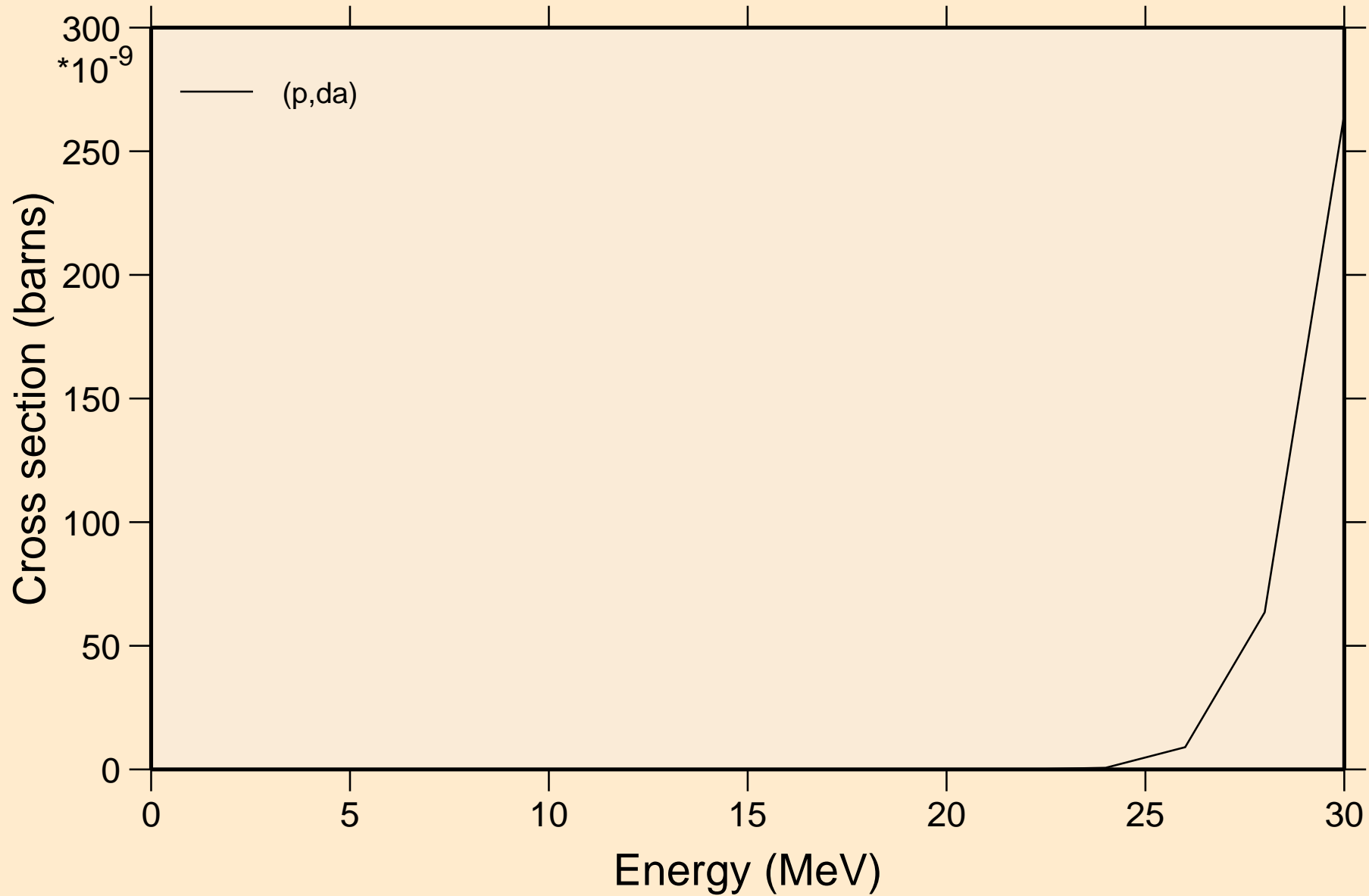

PB194 PROTON ACER TENDL-2023 LIBRARY; T=0.K  
angular distribution for elastic

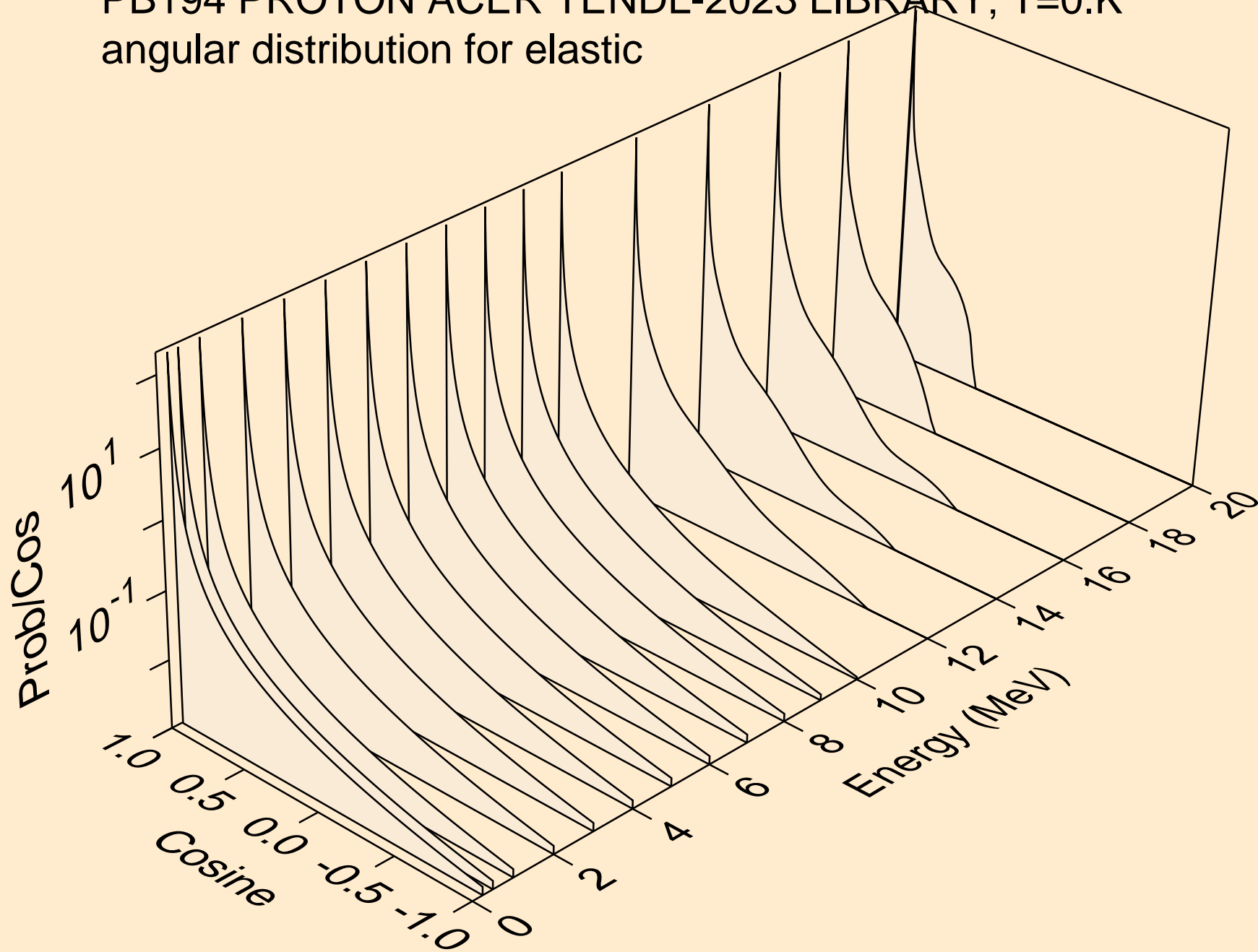



PB194 PROTON ACER TENDL-2023 LIBRARY; T=0.K  
angular distribution for elastic

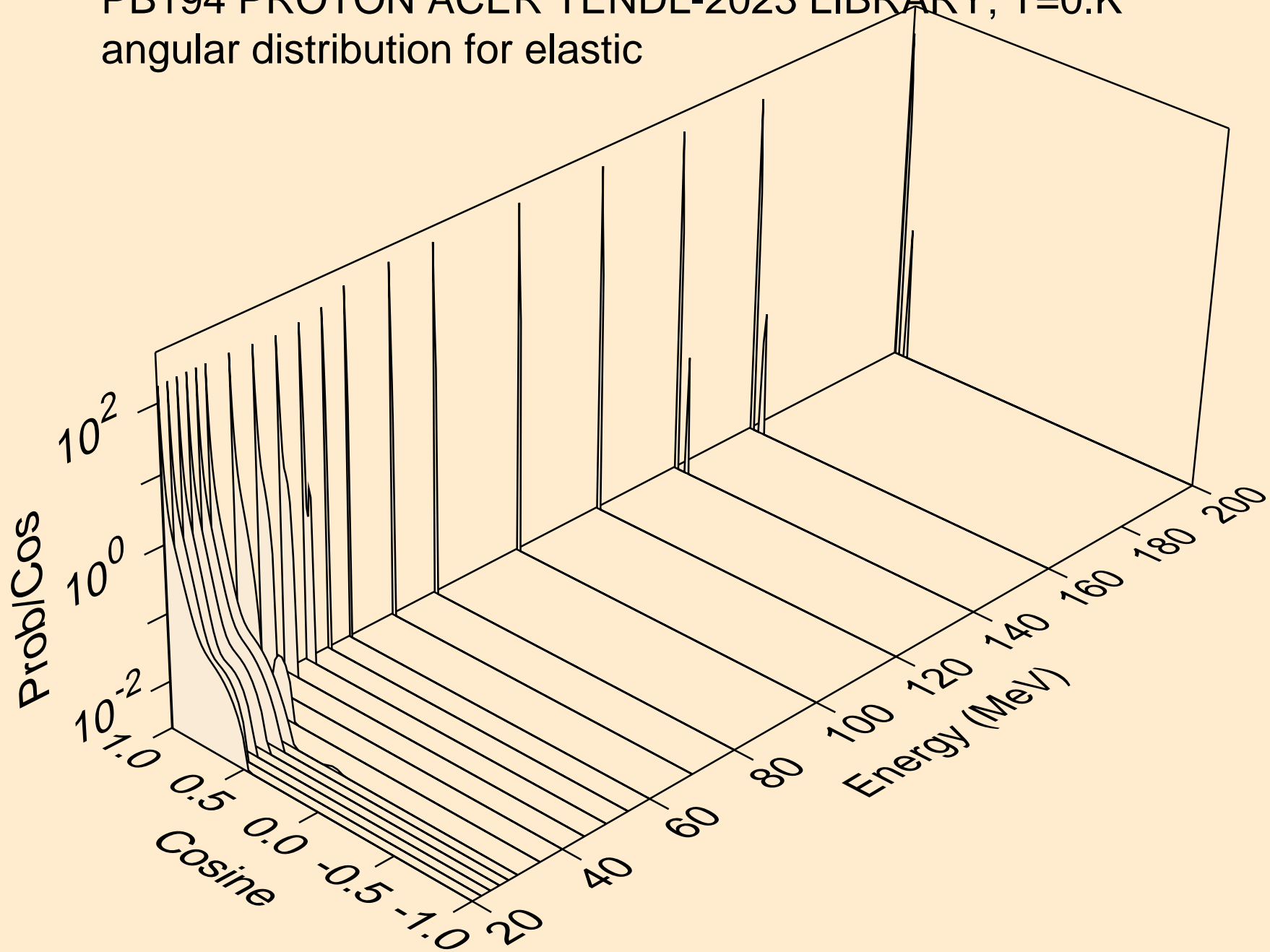

PB194 PROTON ACER TENDL-2023 LIBRARY; T=0.K  
Proton emission for (p,x)

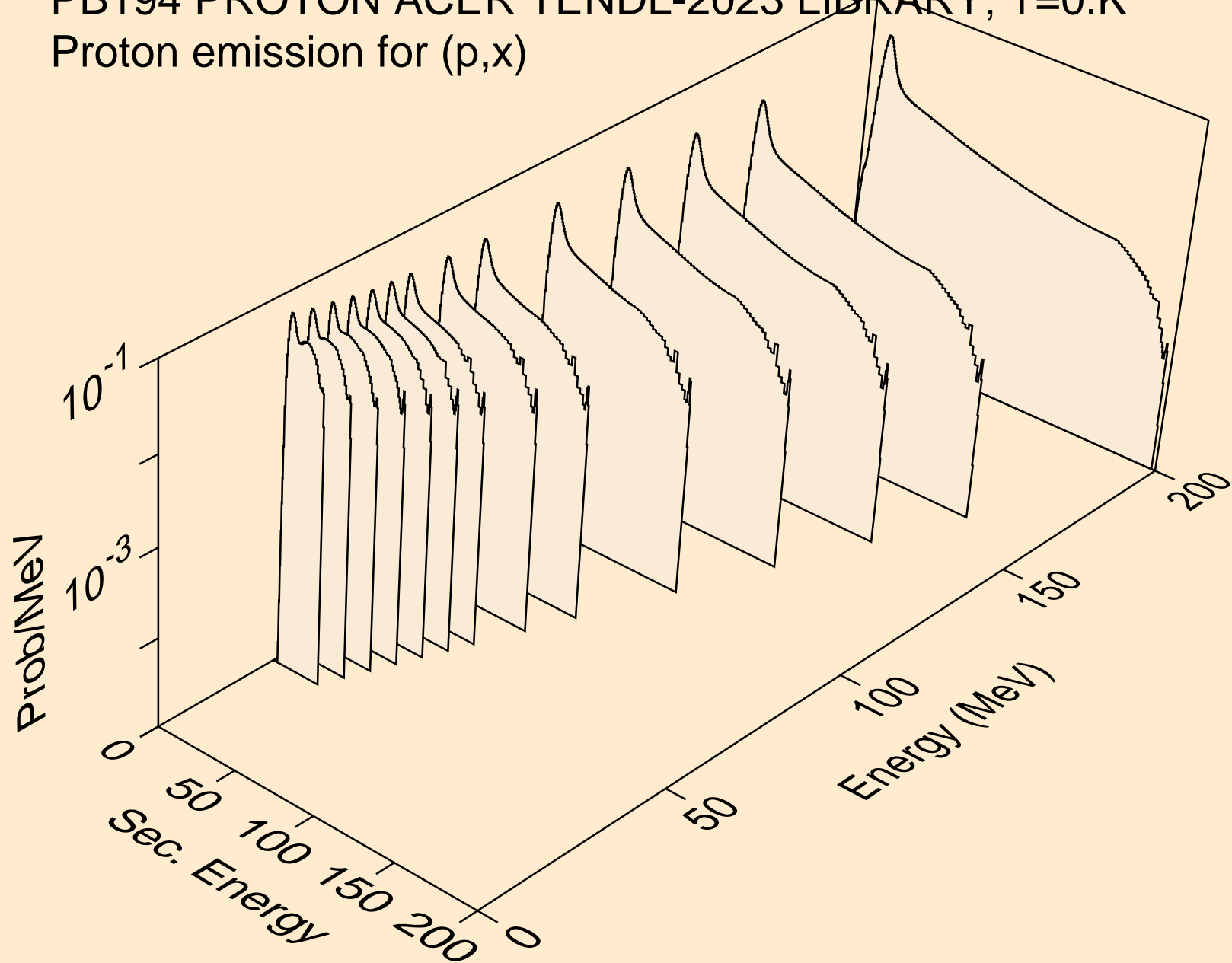

PB194 PROTON ACER TENDL-2023 LIBRARY; T=0.K  
Proton emission for (p,n\*)p

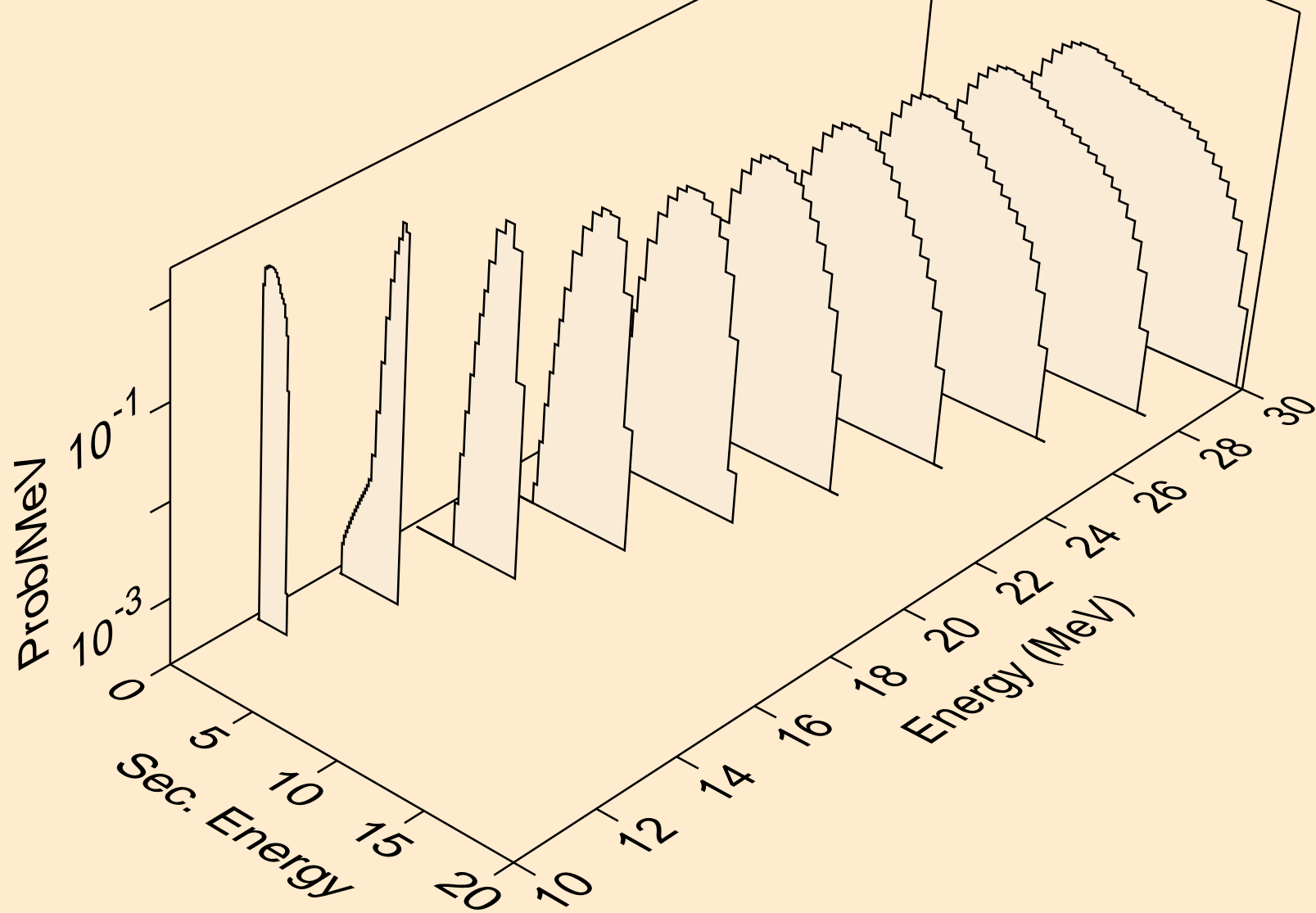

PB194 PROTON ACER TENDL-2023 LIBRARY; T=0.K  
Proton emission for (p,2np)

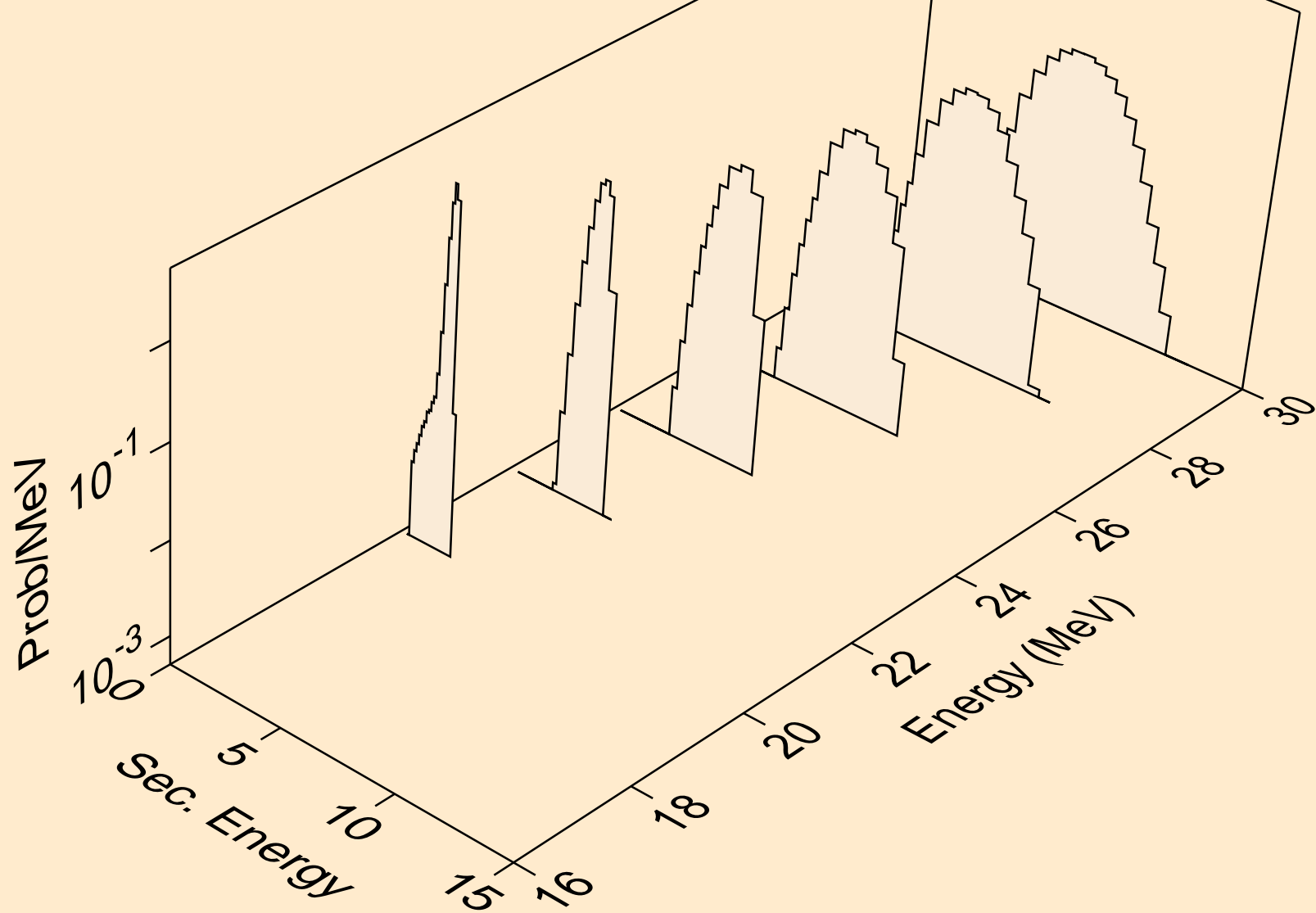

PB194 PROTON ACER TENDL-2023 LIBRARY; T=0.K  
Proton emission for (p,n2p)

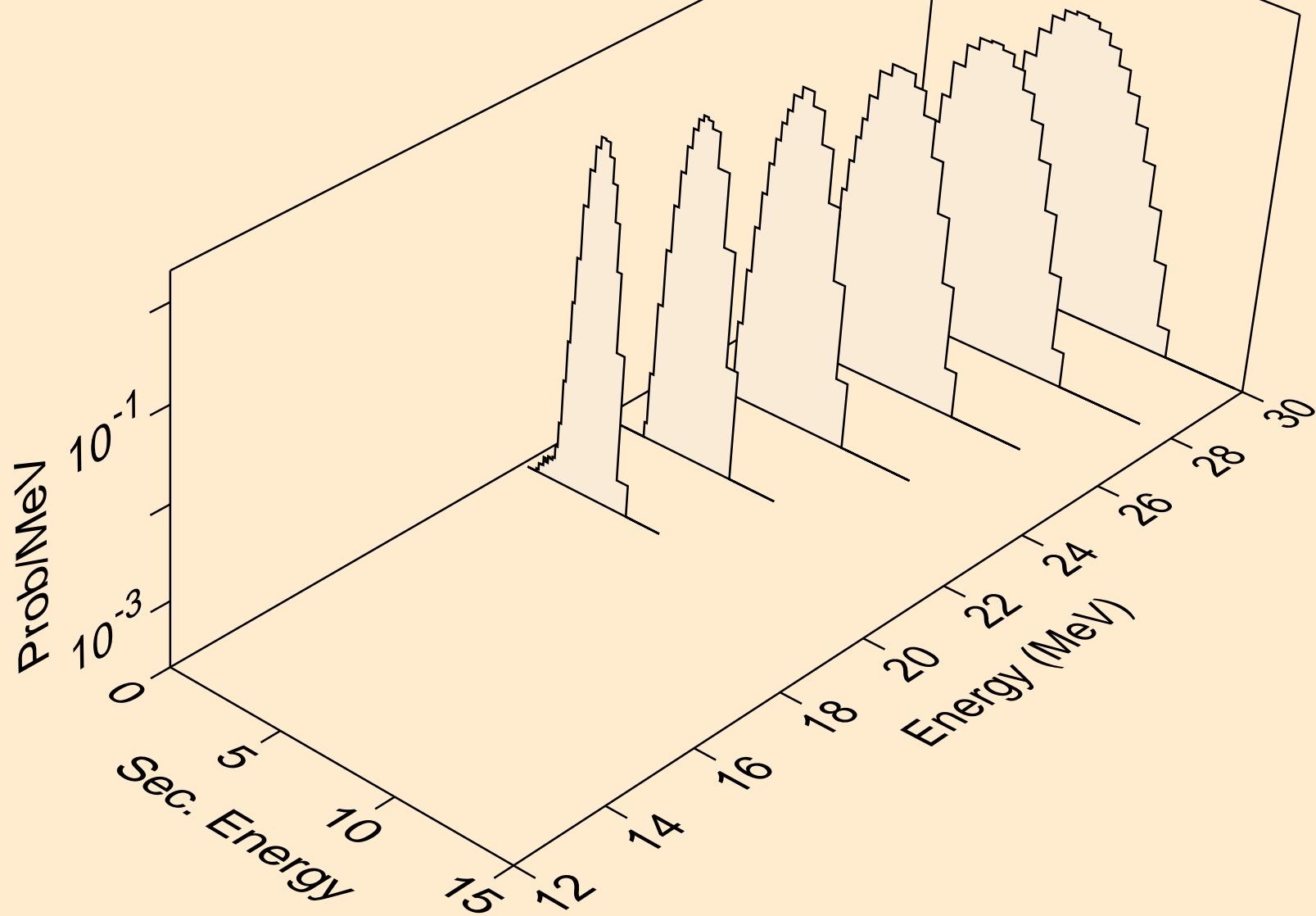

PB194 PROTON ACER TENDL-2023 LIBRARY; T=0.K  
Proton emission for (p,npa)

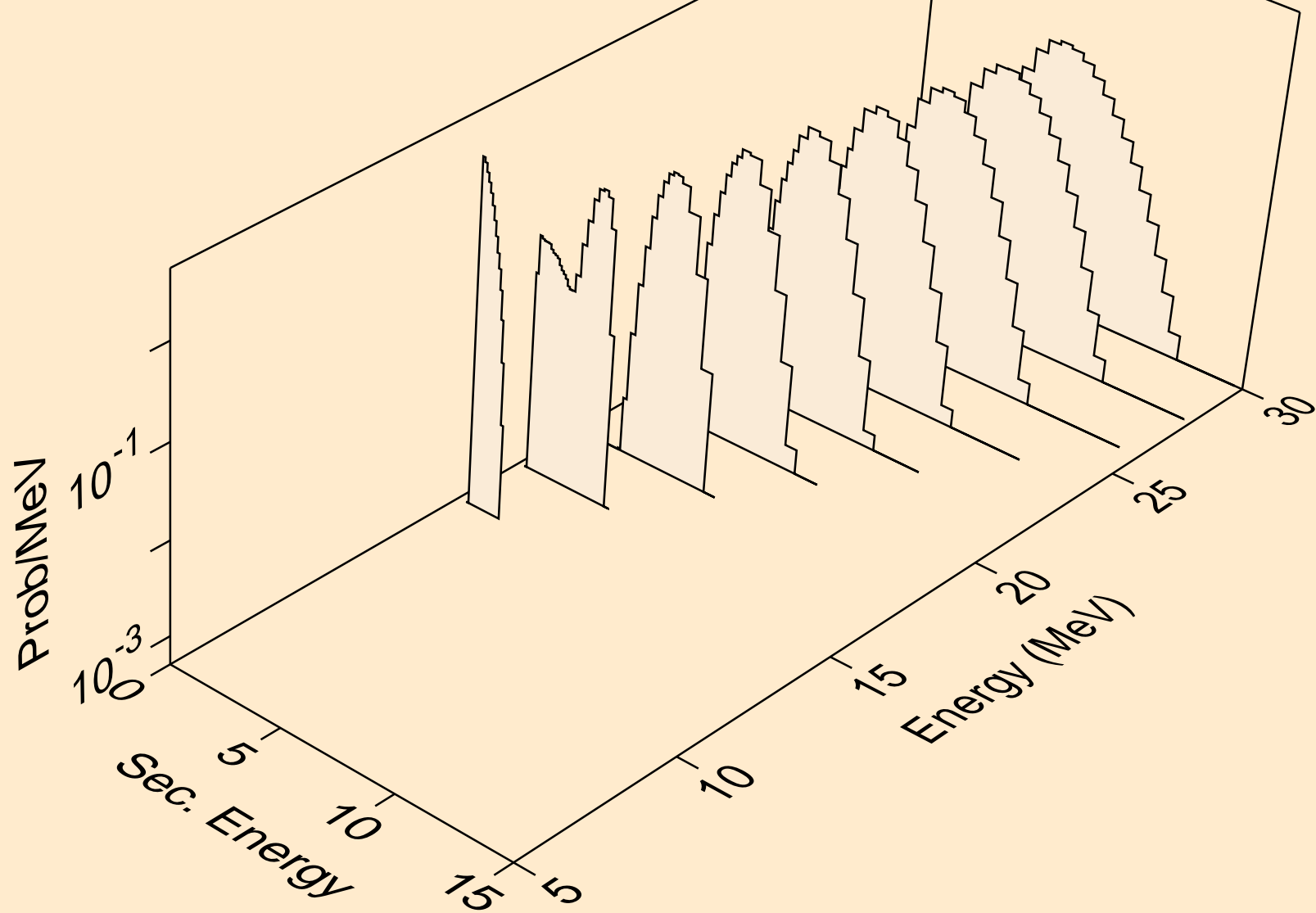

PB194 PROTON ACER TENDL-2023 LIBRARY; T=0.K  
Proton emission for inelastic

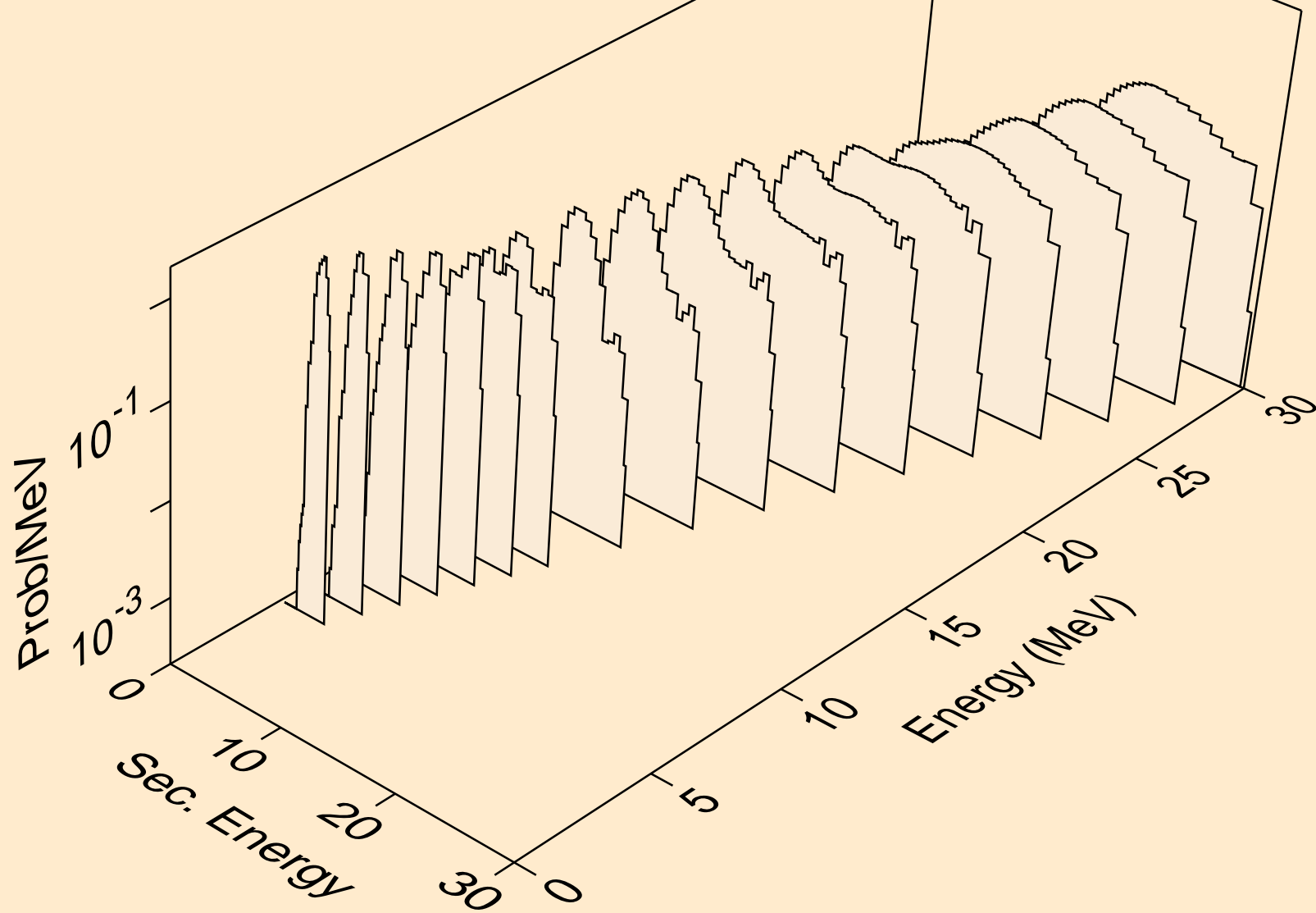

PB194 PROTON ACER TENDL-2023 LIBRARY; T=0.K  
Proton emission for (p,2p)

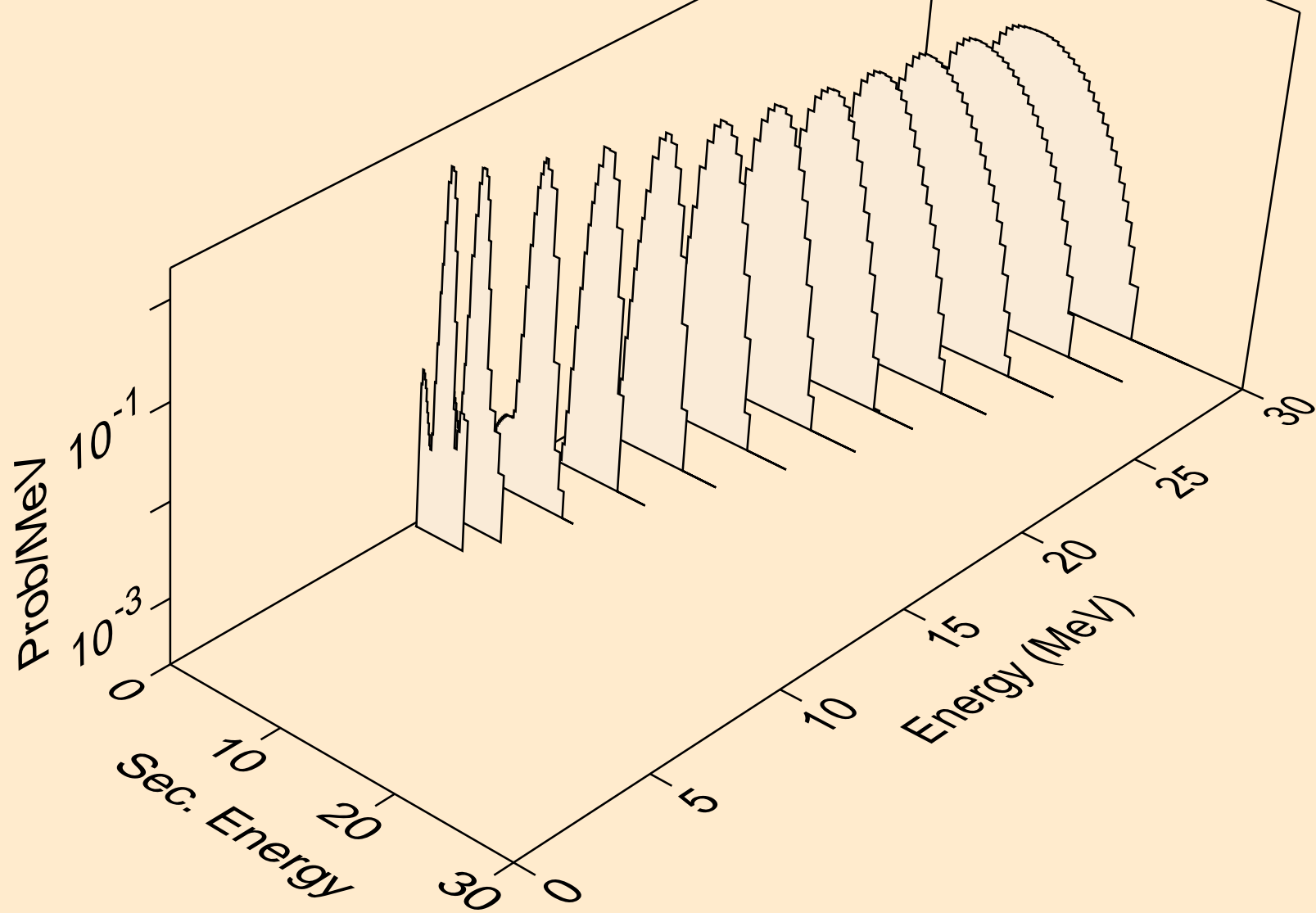



PB194 PROTON ACER TENDL-2023 LIBRARY; T=0.K  
Proton emission for (p,pa)

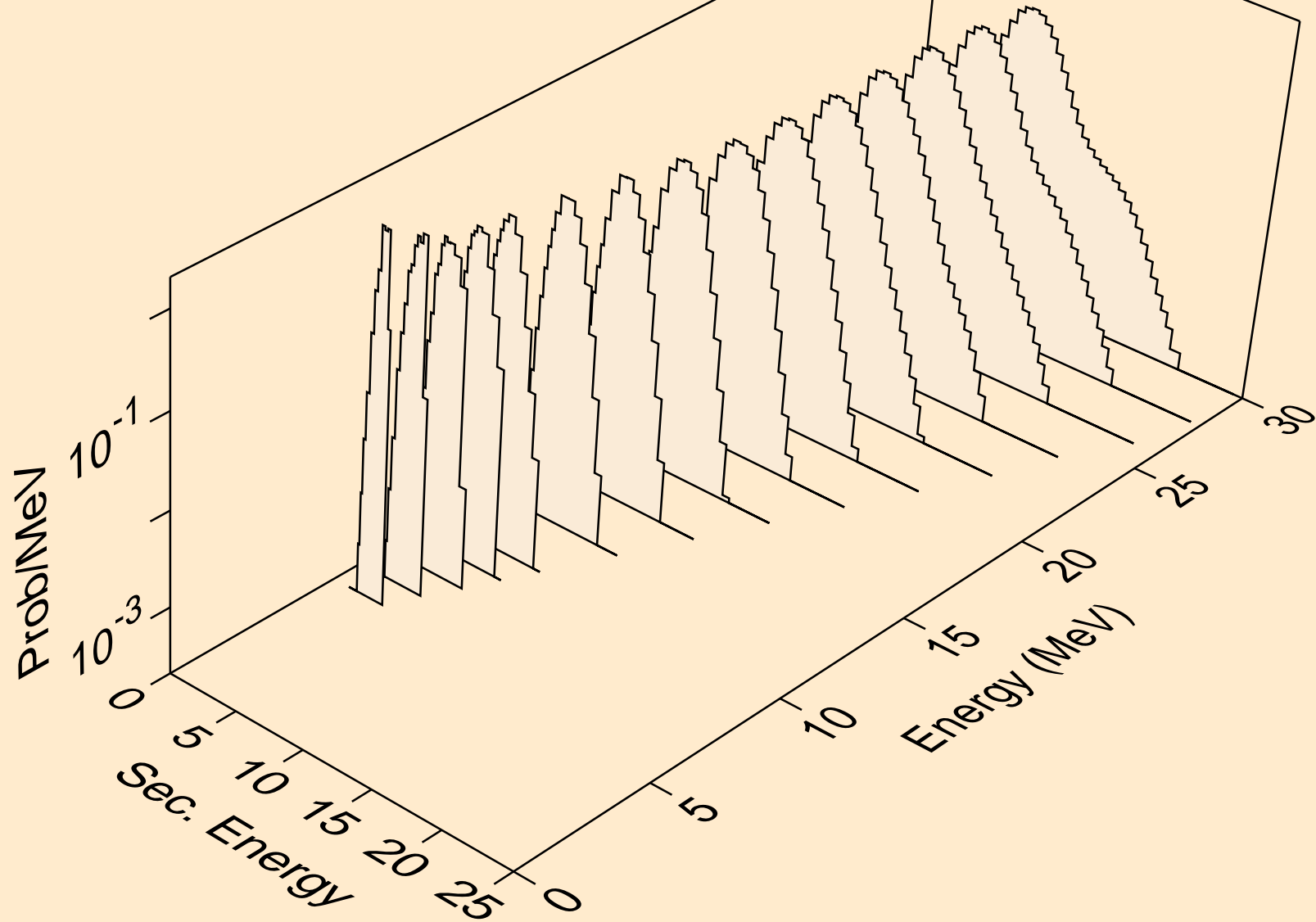

PB194 PROTON ACER TENDL-2023 LIBRARY; T=0.K  
Proton emission for (p,pd)

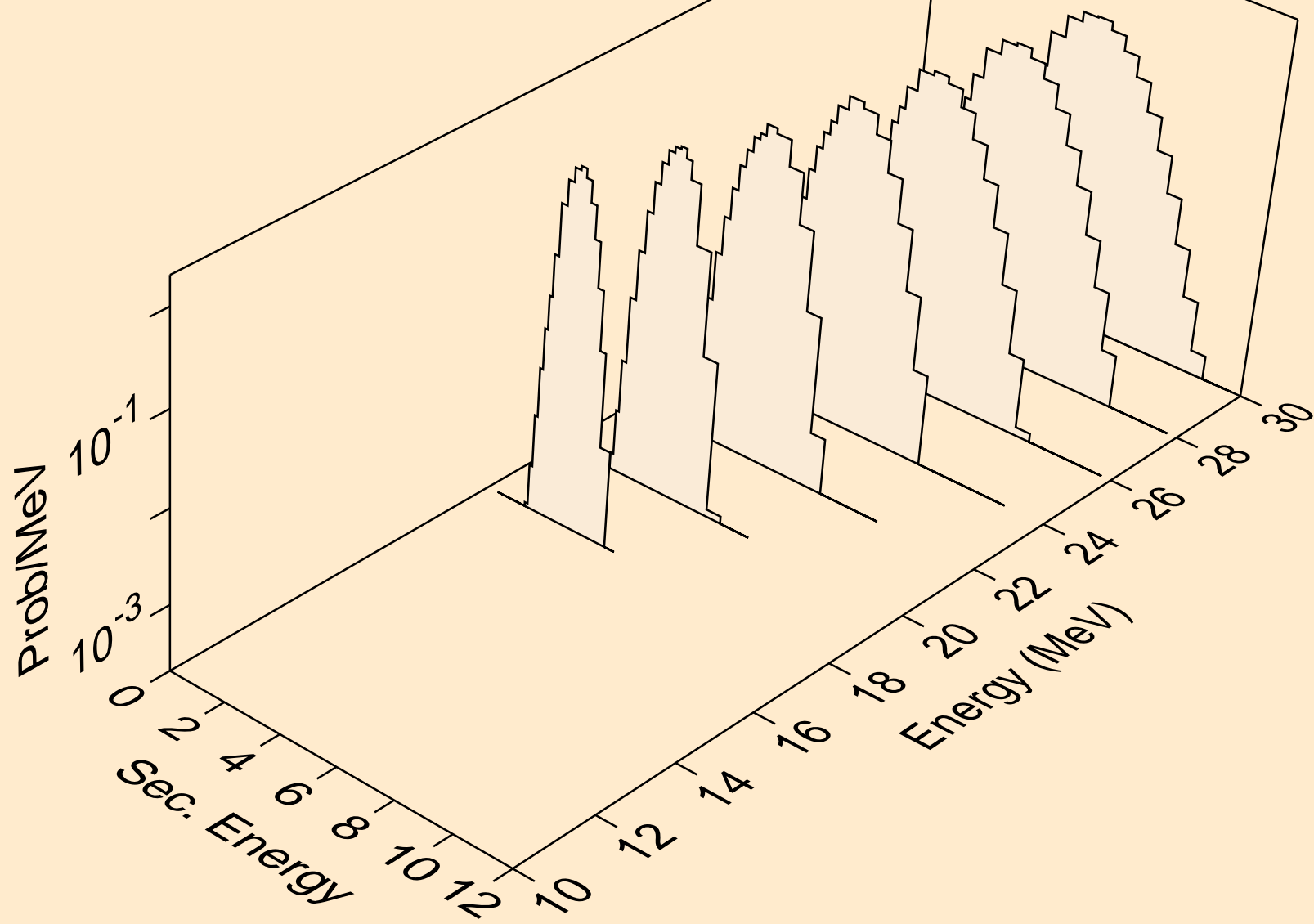

PB194 PROTON ACER TENDL-2023 LIBRARY; T=0.K  
Proton emission for (p,pt)

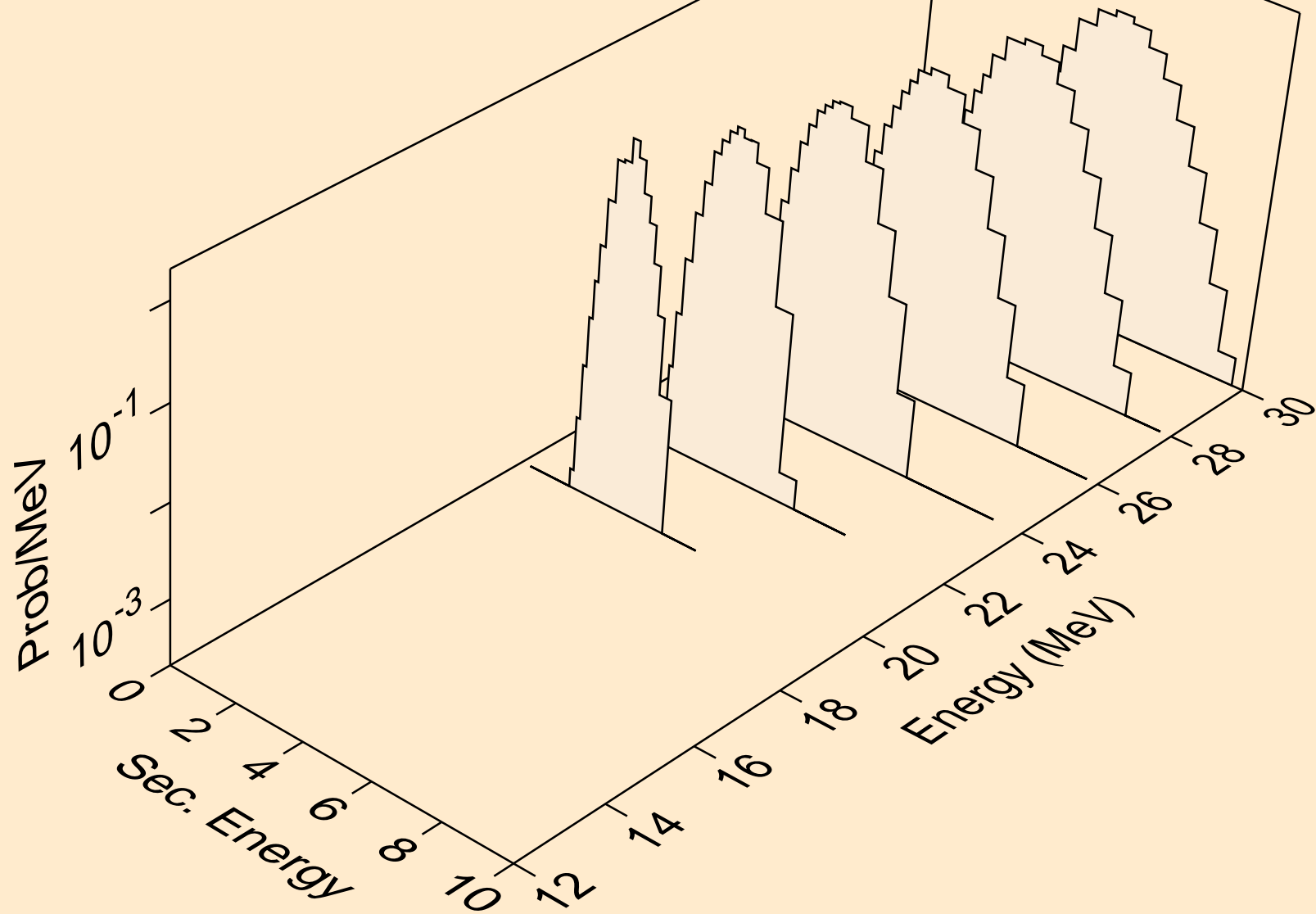

PB194 PROTON ACER TENDL-2023 LIBRARY; T=0.K  
Photon emission for (z,n)

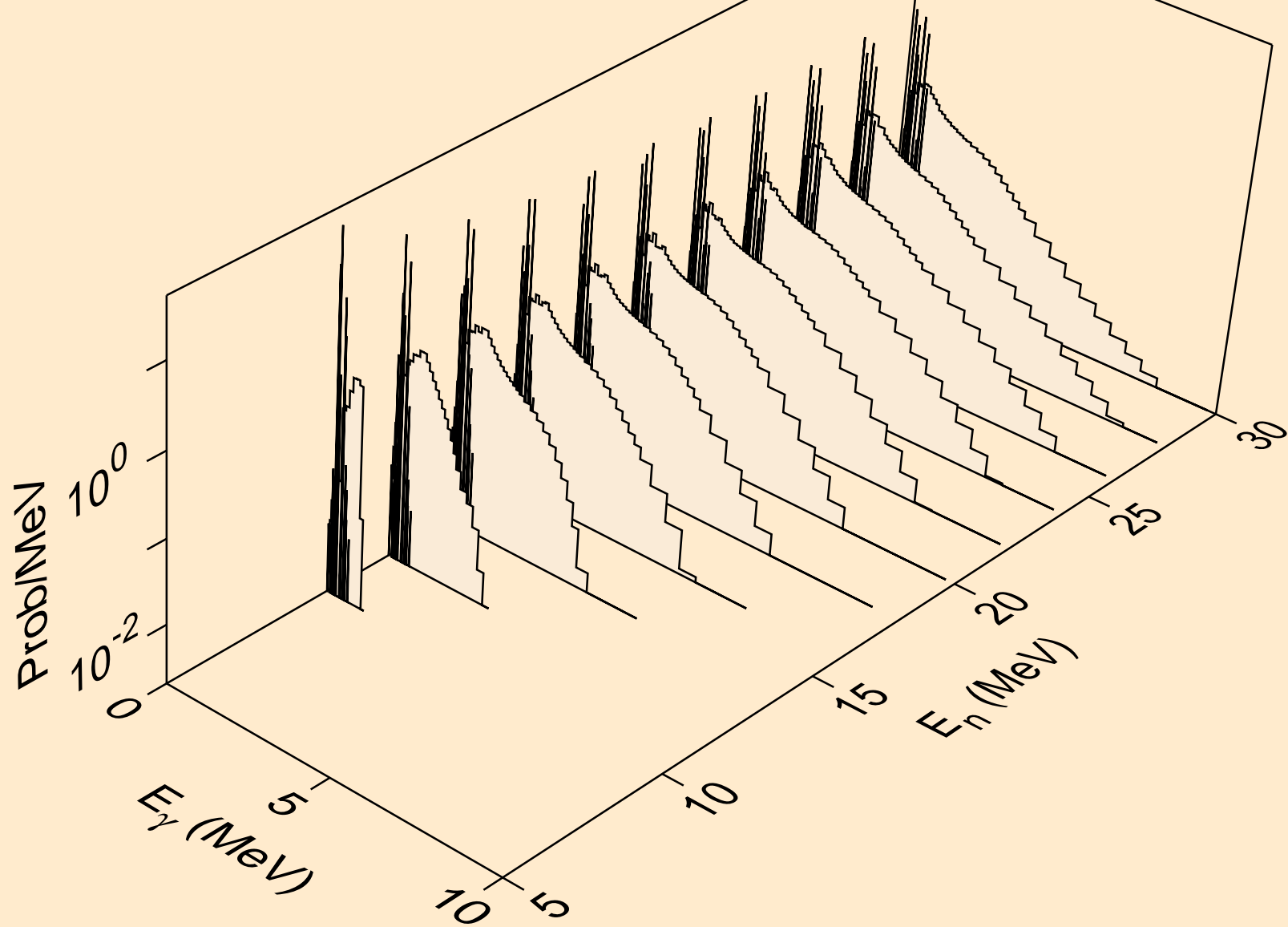

PB194 PROTON ACER TENDL-2023 LIBRARY; T=0.K  
Photon emission for (z,x)

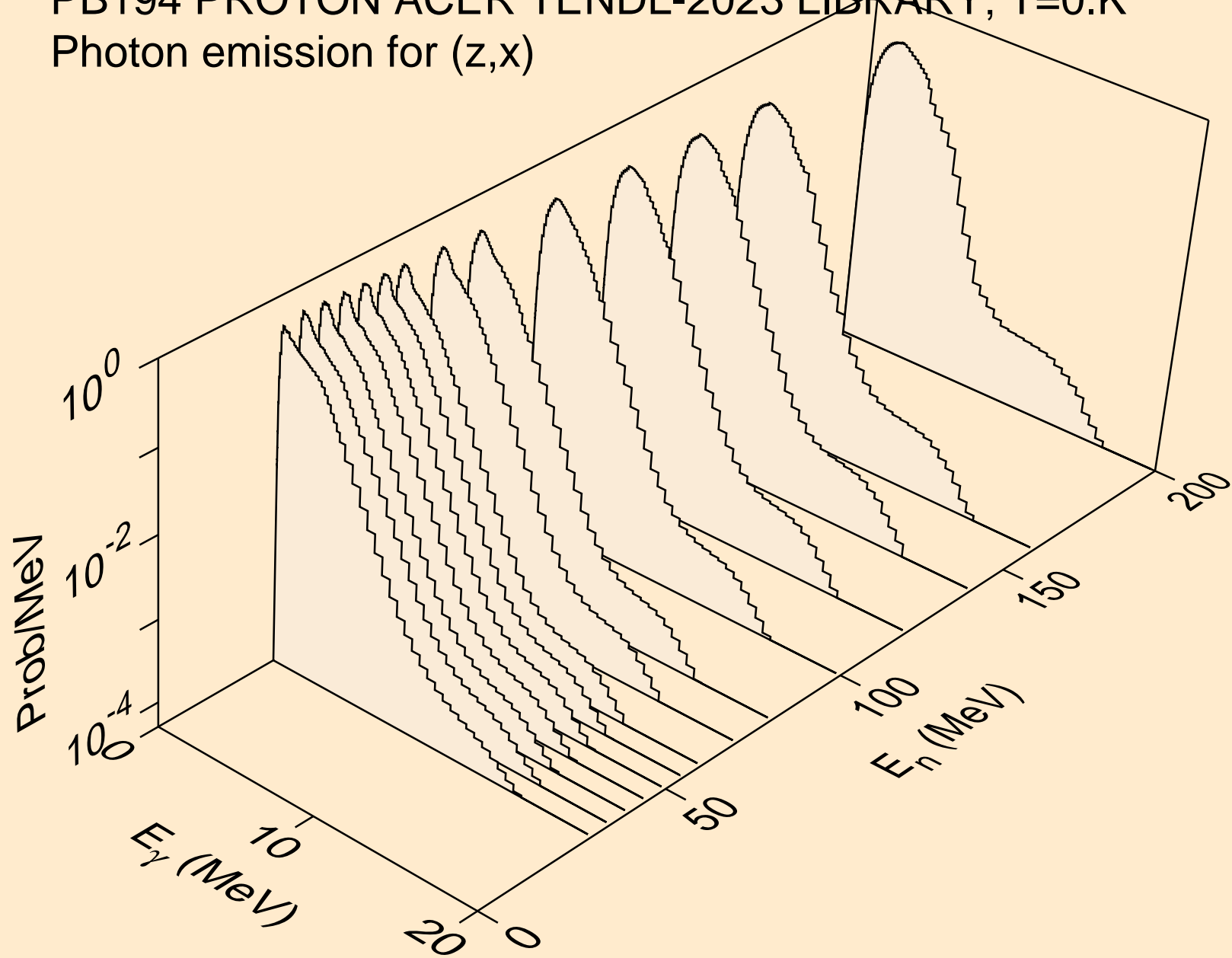

PB194 PROTON ACER TENDL-2023 LIBRARY; T=0.K  
Photon emission for (n,2n)

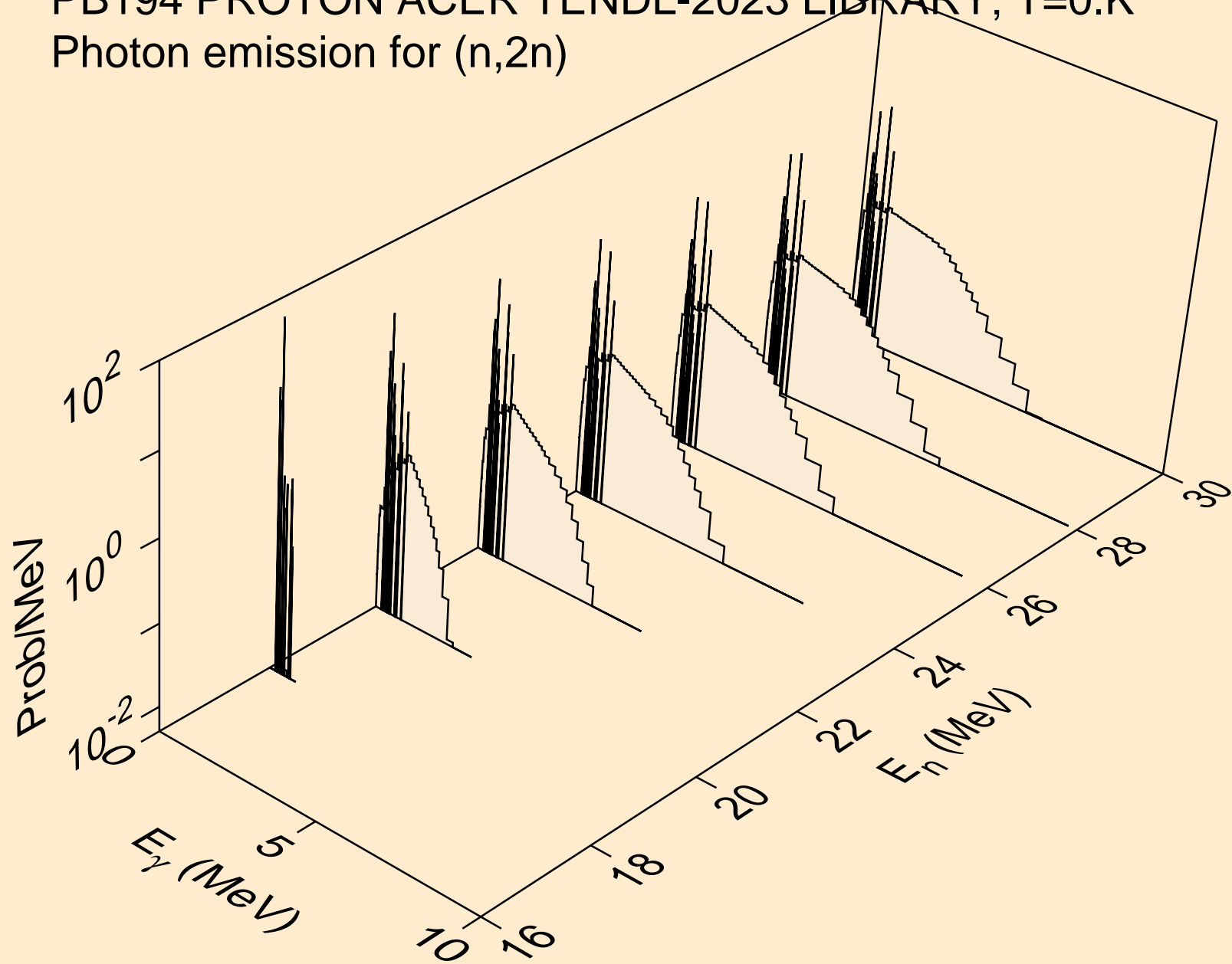

PB194 PROTON ACER TENDL-2023 LIBRARY; T=0.K  
Photon emission for (n,3n)

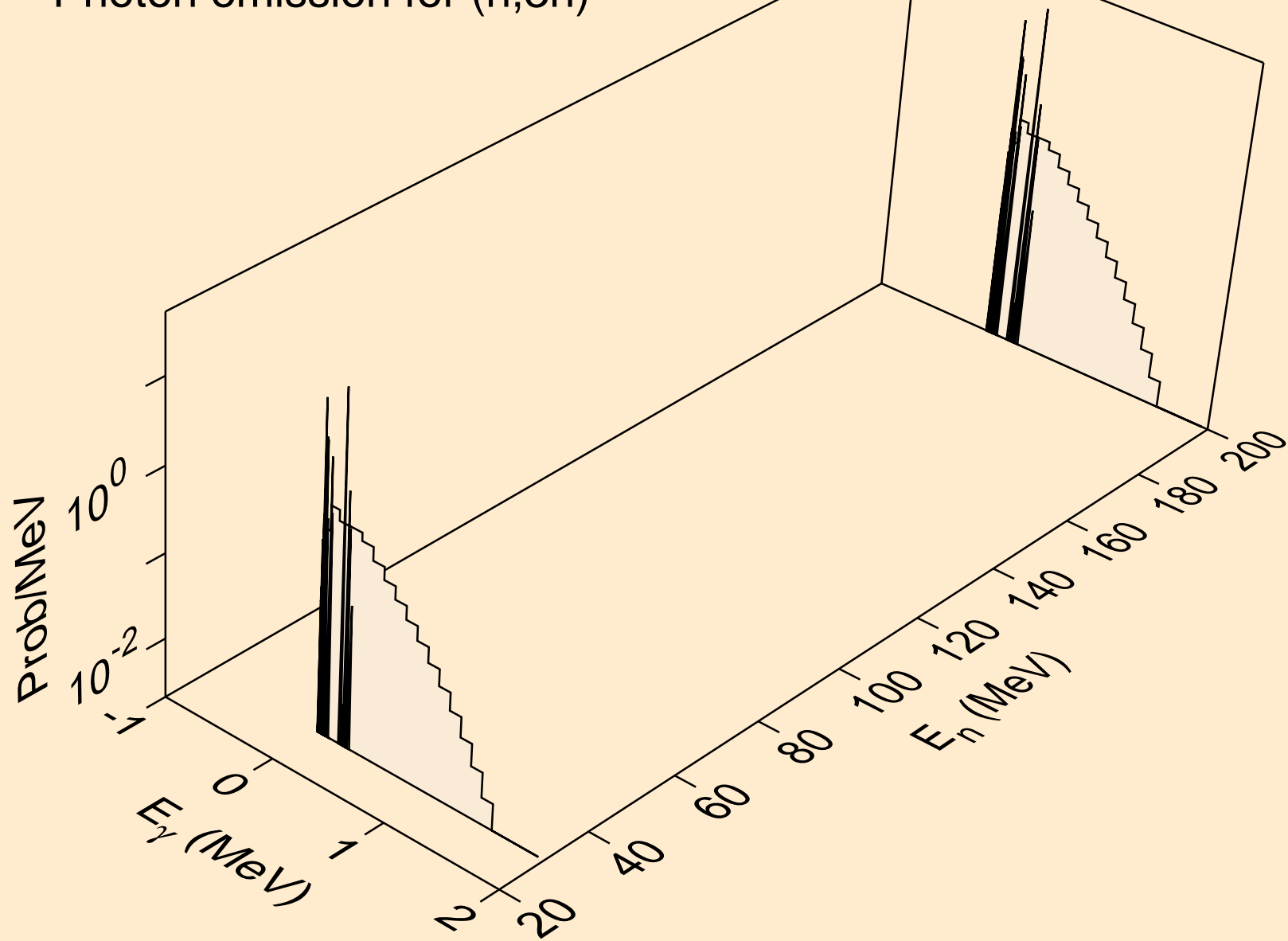

PB194 PROTON ACER TENDL-2023 LIBRARY; T=0.K  
Photon emission for (n,n\*)a

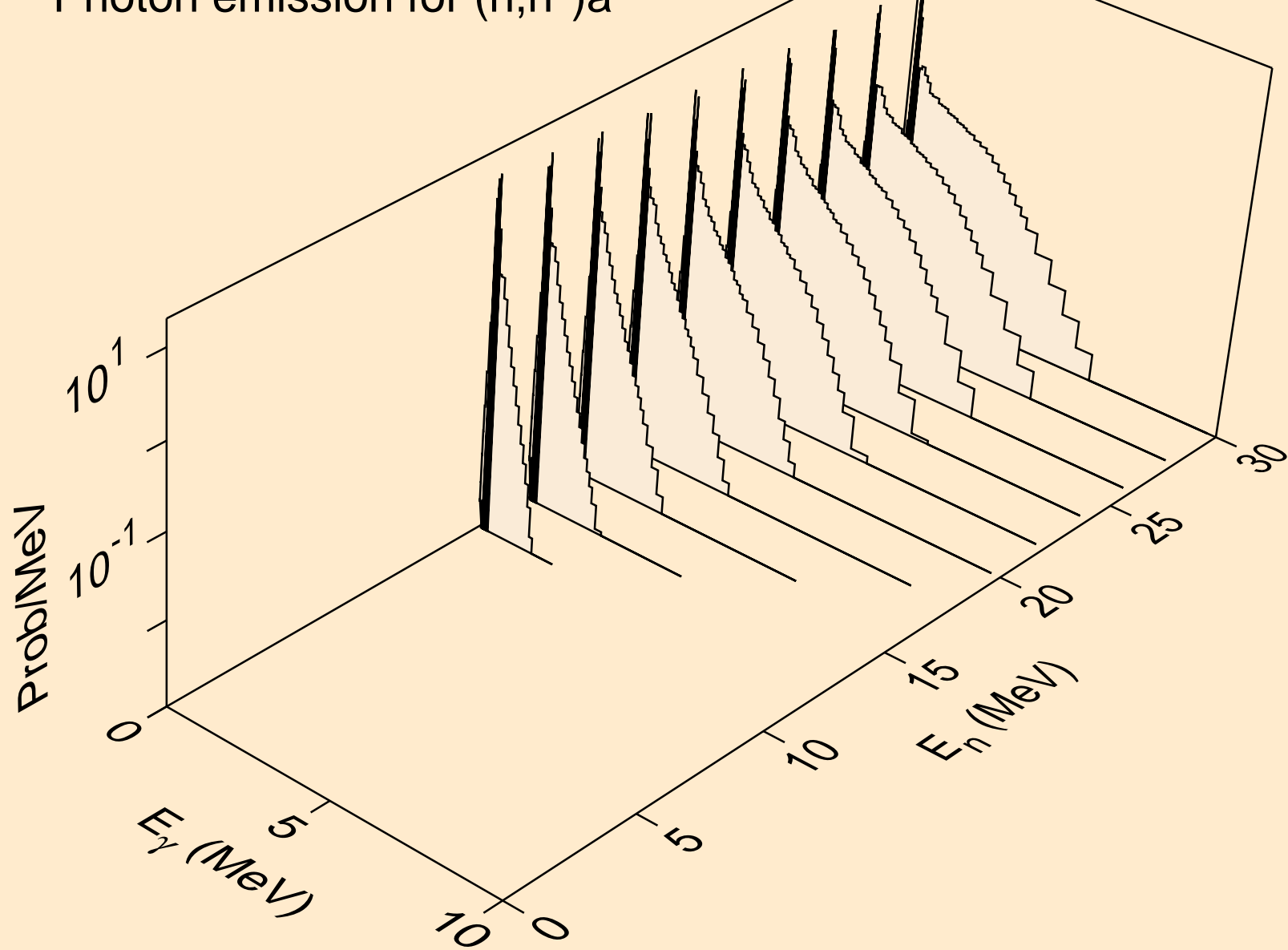



PB194 PROTON ACER TENDL-2023 LIBRARY; T=0.K  
Photon emission for (n,2n)a

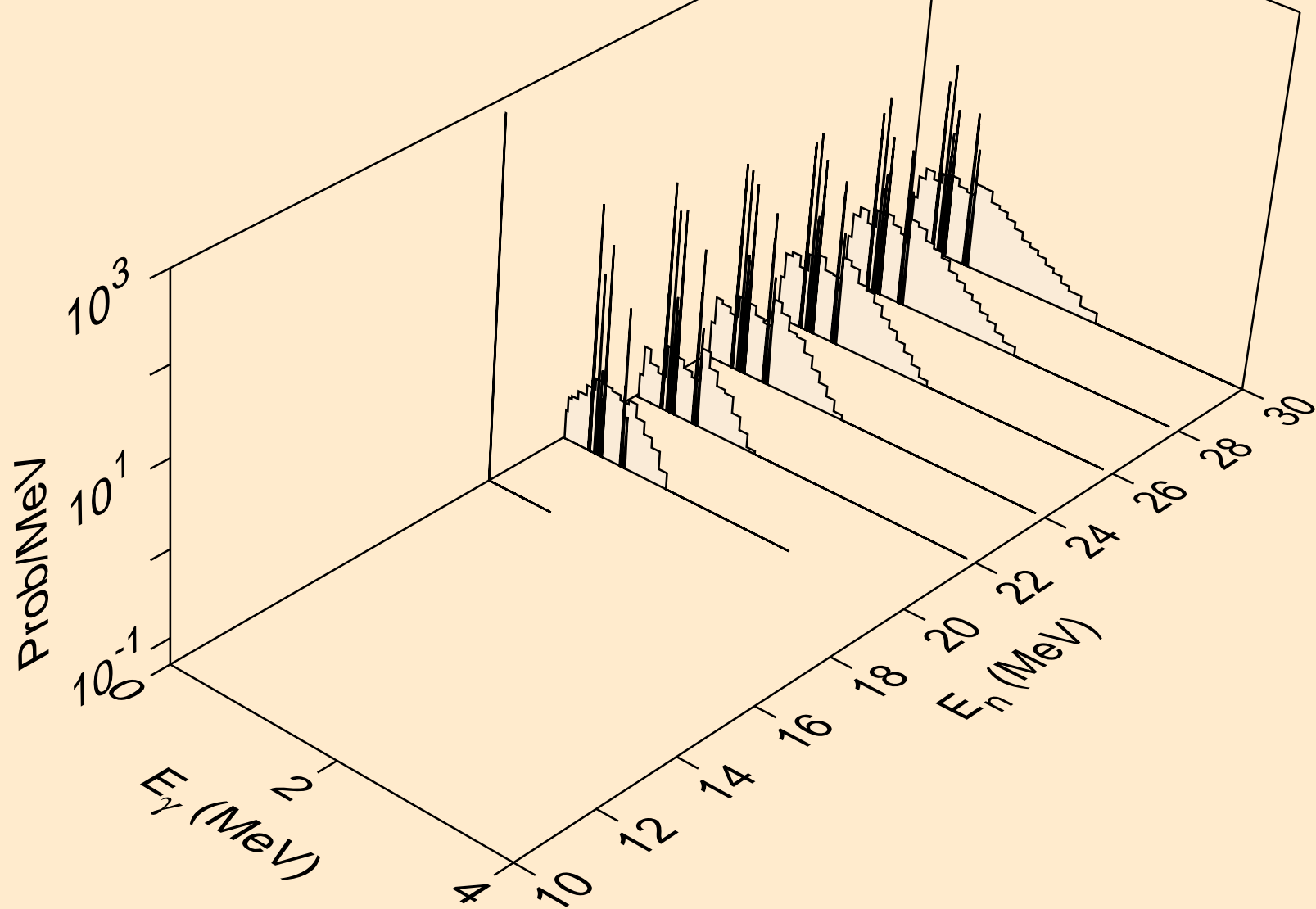

PB194 PROTON ACER TENDL-2023 LIBRARY; T=0.K  
Photon emission for (n,n\*)p

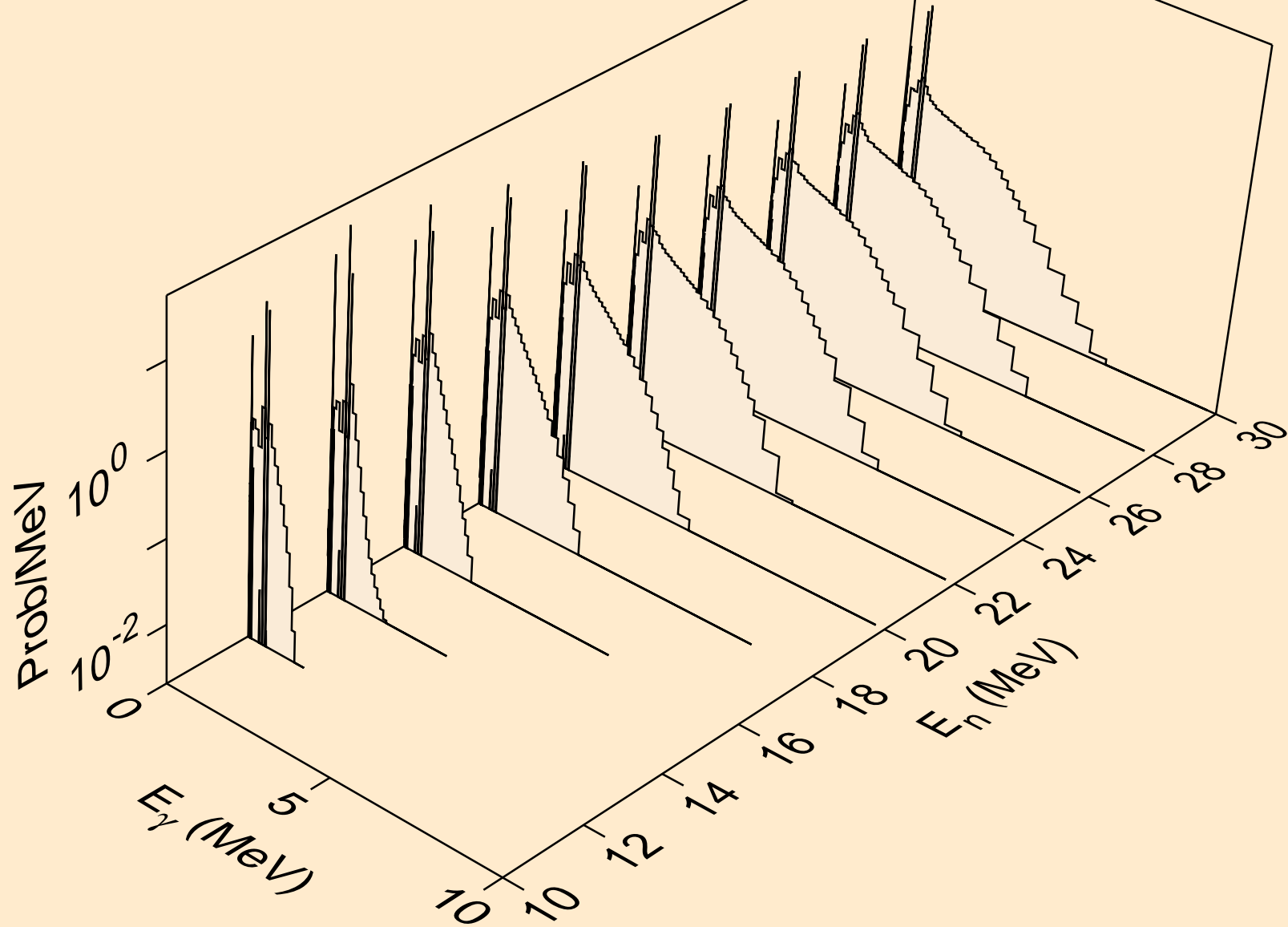

PB194 PROTON ACER TENDL-2023 LIBRARY; T=0.K  
Photon emission for (n,n\*)2a

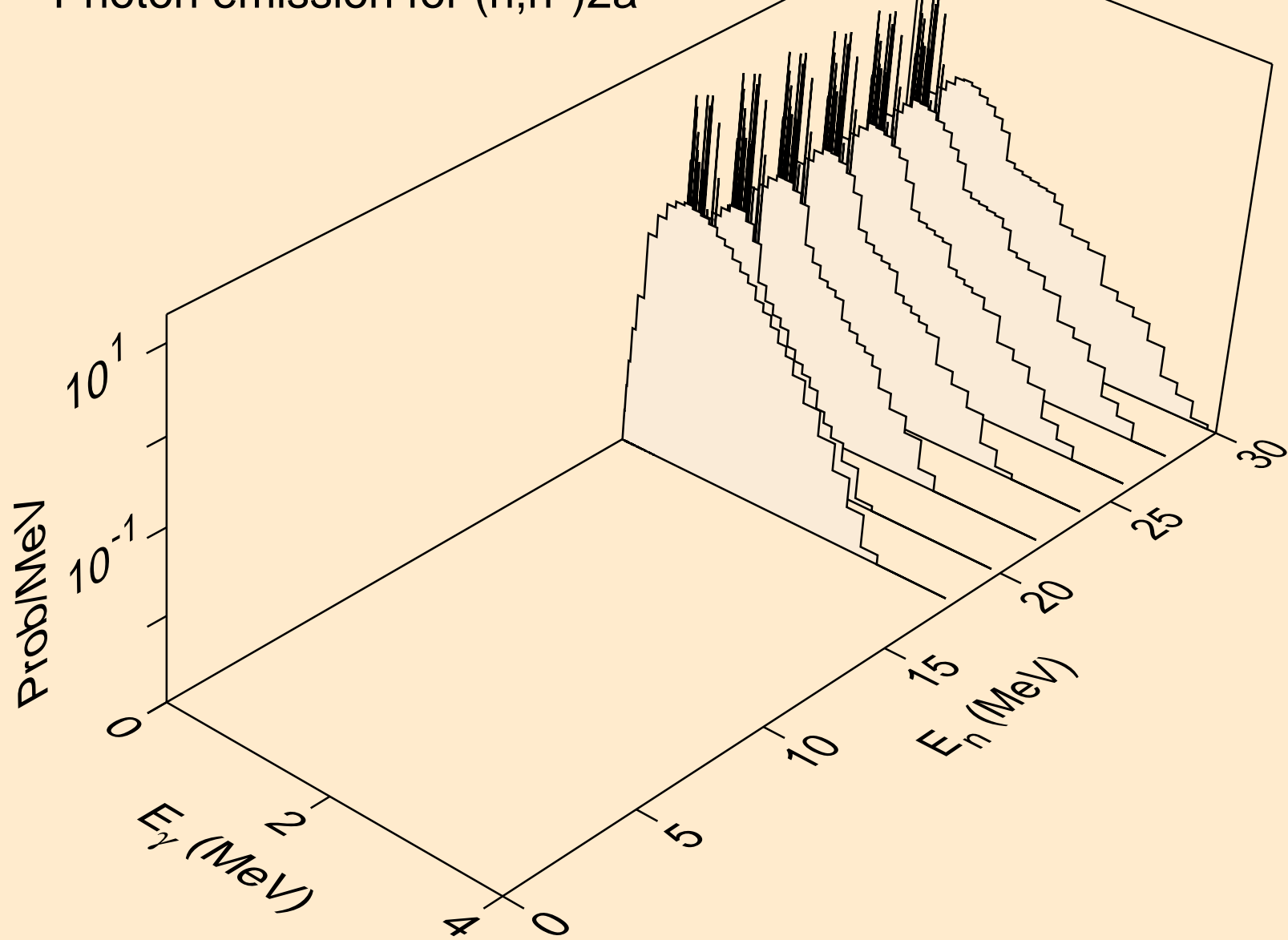

PB194 PROTON ACER TENDL-2023 LIBRARY; T=0.K  
Photon emission for (n,n\*)d

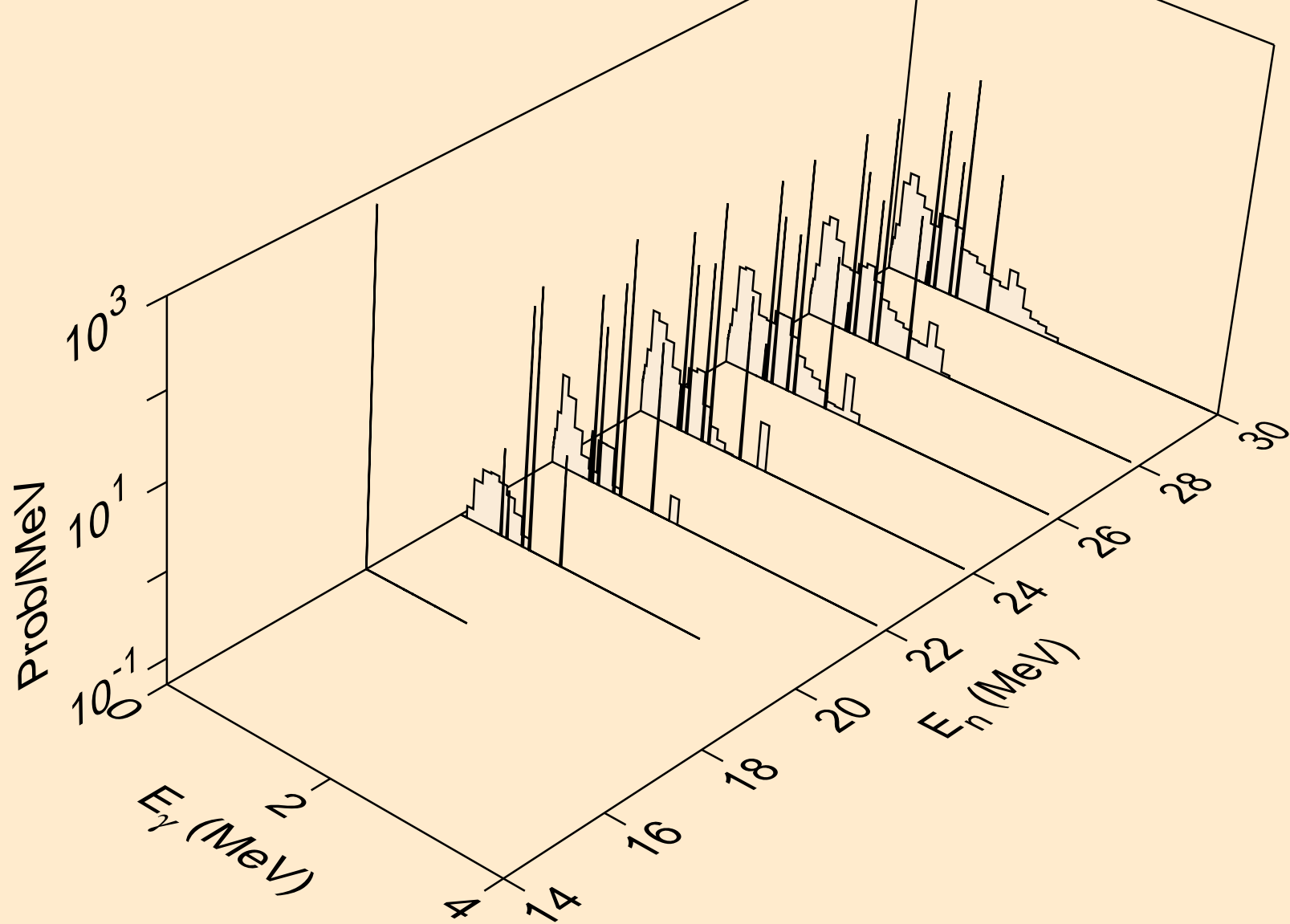

PB194 PROTON ACER TENDL-2023 LIBRARY; T=0.K  
Photon emission for (n,n\*)t

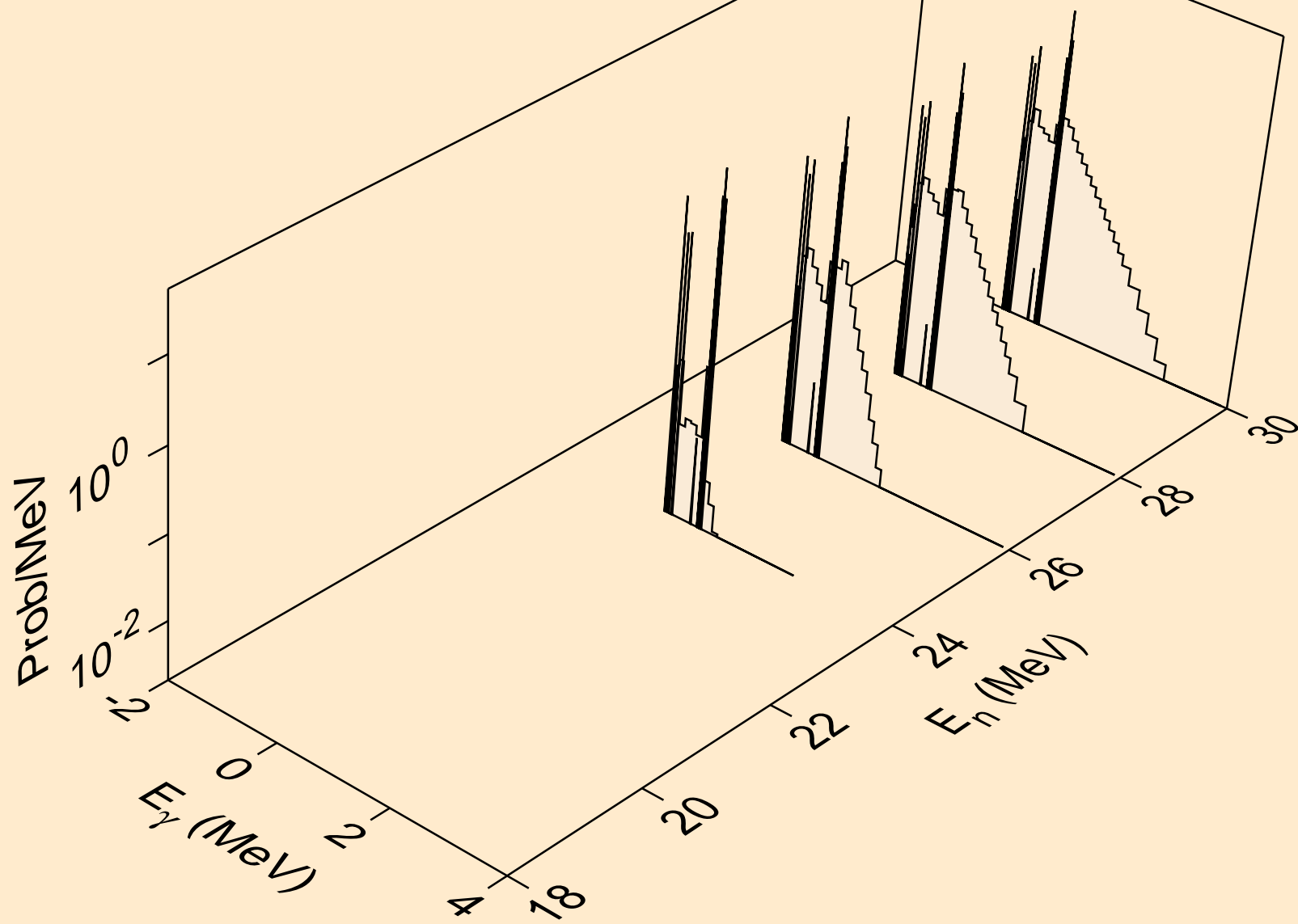

PB194 PROTON ACER TENDL-2023 LIBRARY; T=0.K  
Photon emission for (n,n\*)he3

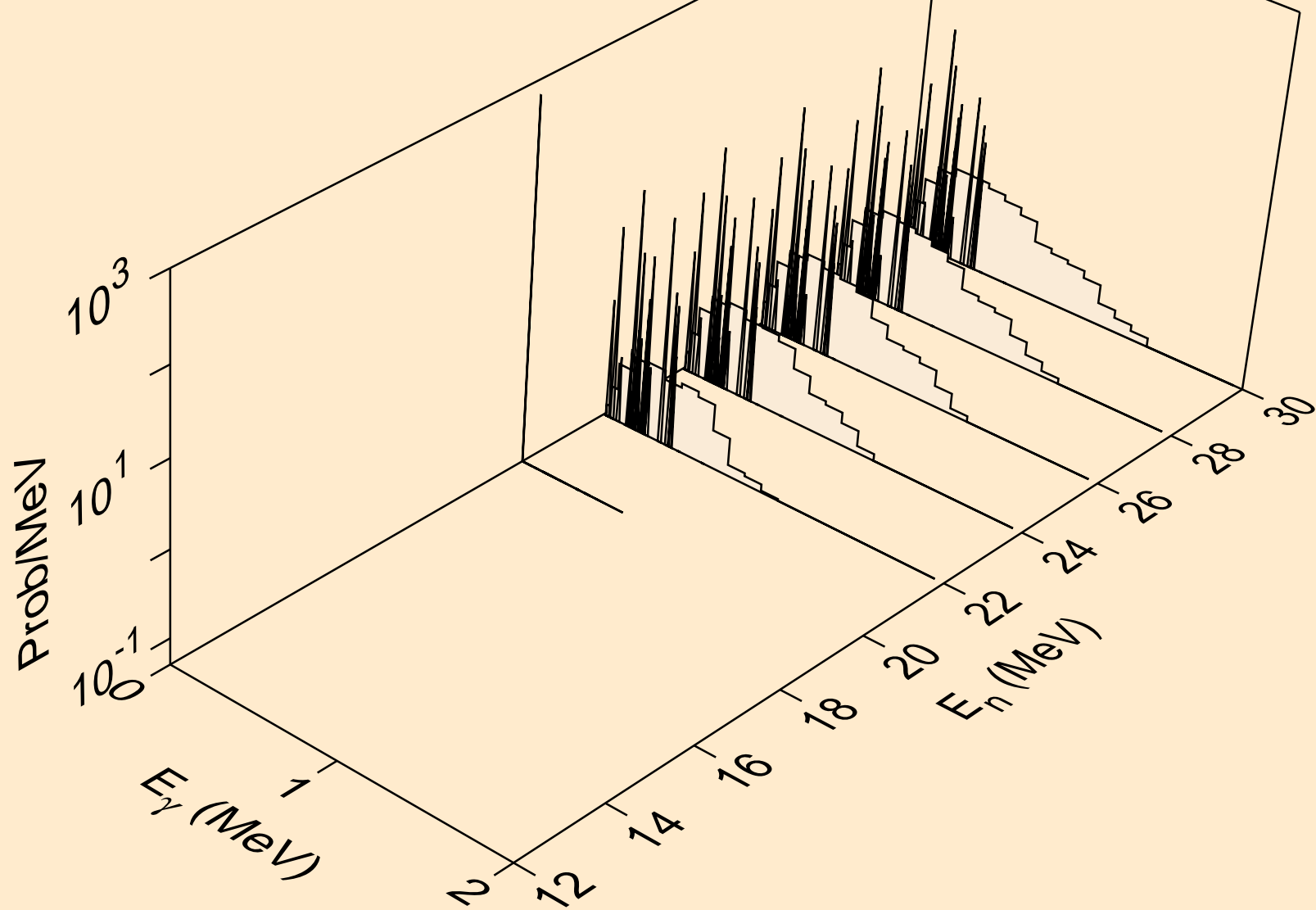

PB194 PROTON ACER TENDL-2023 LIBRARY; T=0.K  
Photon emission for (n,2np)

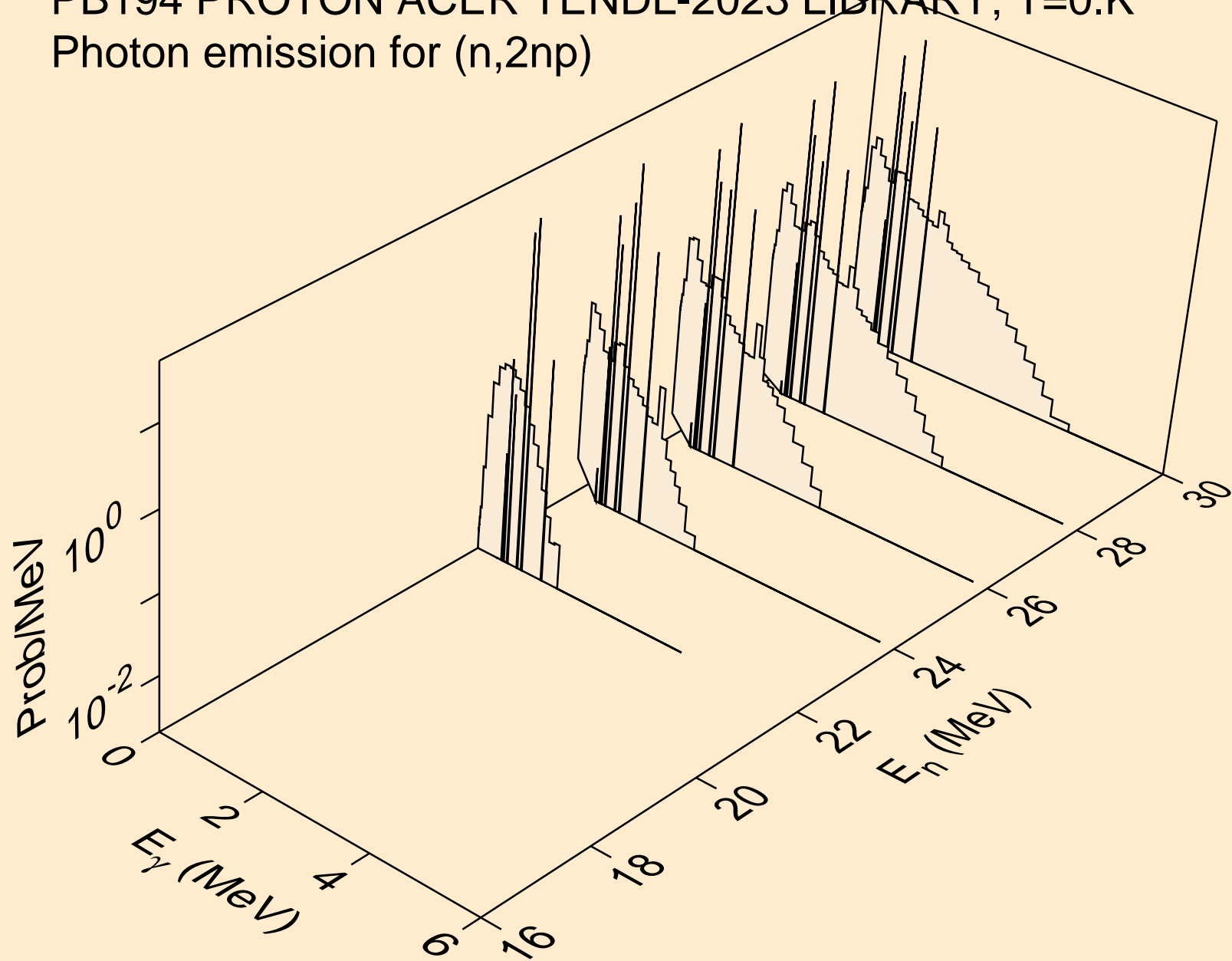

PB194 PROTON ACER TENDL-2023 LIBRARY; T=0.K  
Photon emission for (n,n2p)

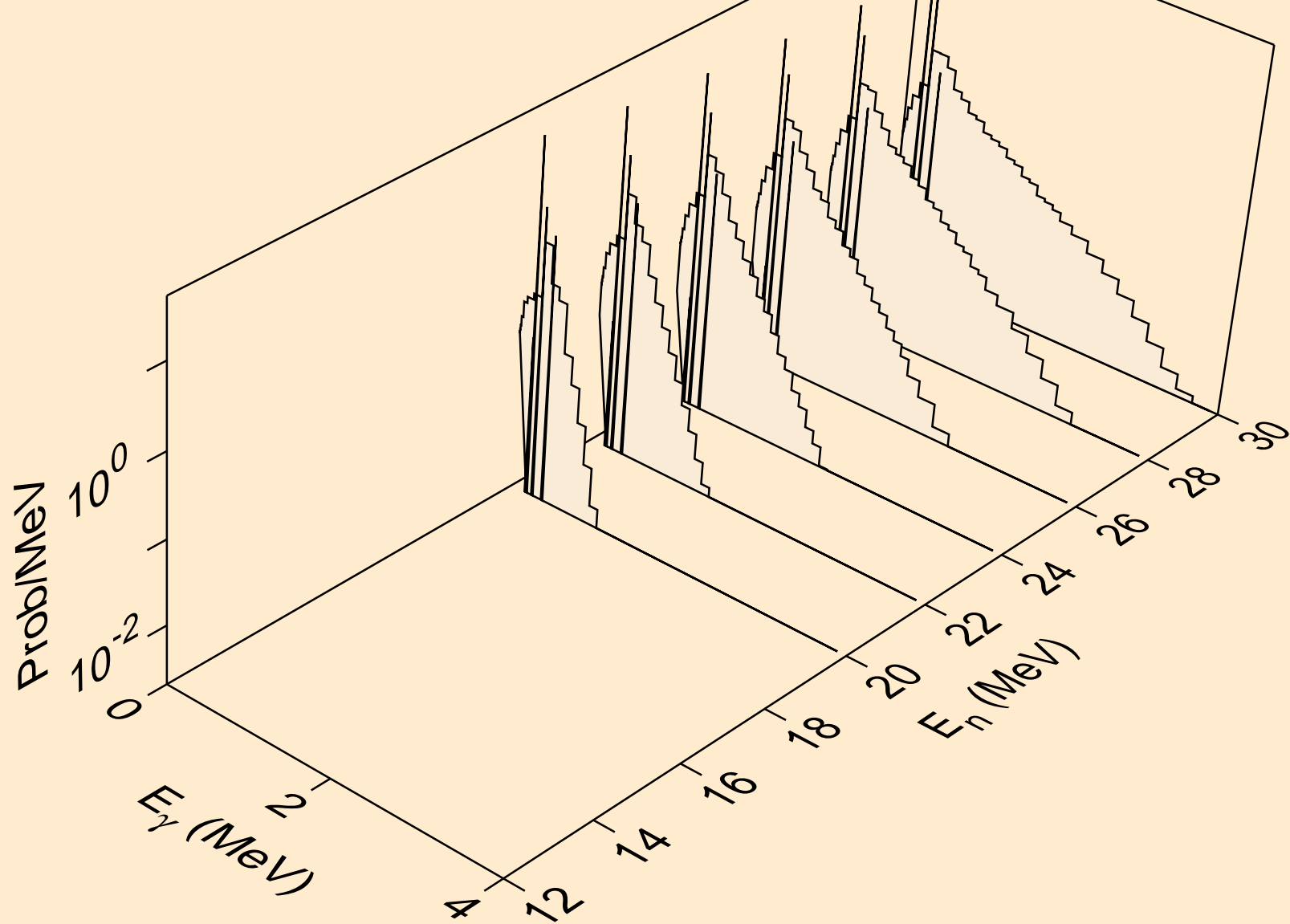



PB194 PROTON ACER TENDL-2023 LIBRARY; T=0.K  
Photon emission for (n,npa)

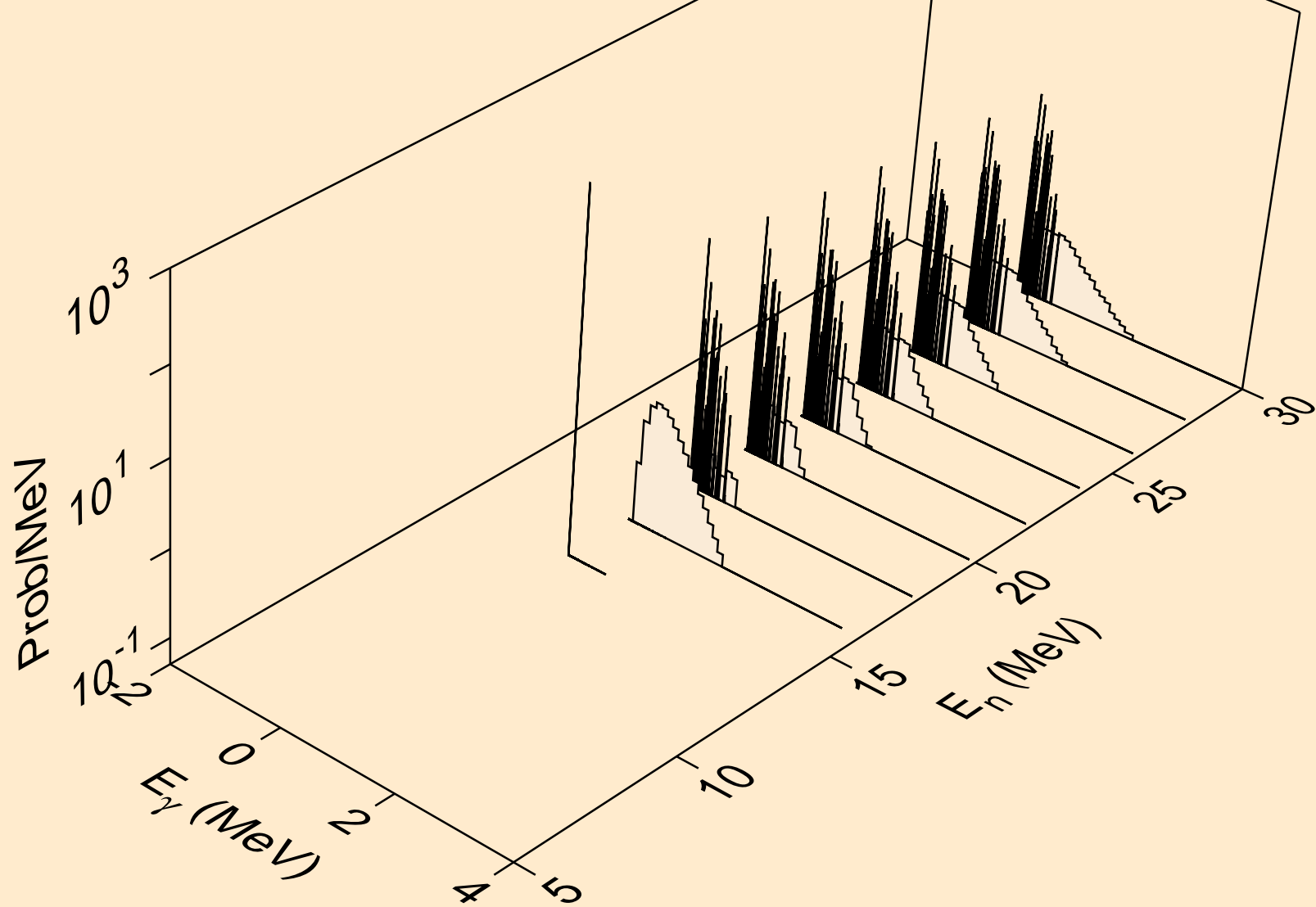

PB194 PROTON ACER TENDL-2023 LIBRARY; T=0.K  
Photon emission for (n,gma)

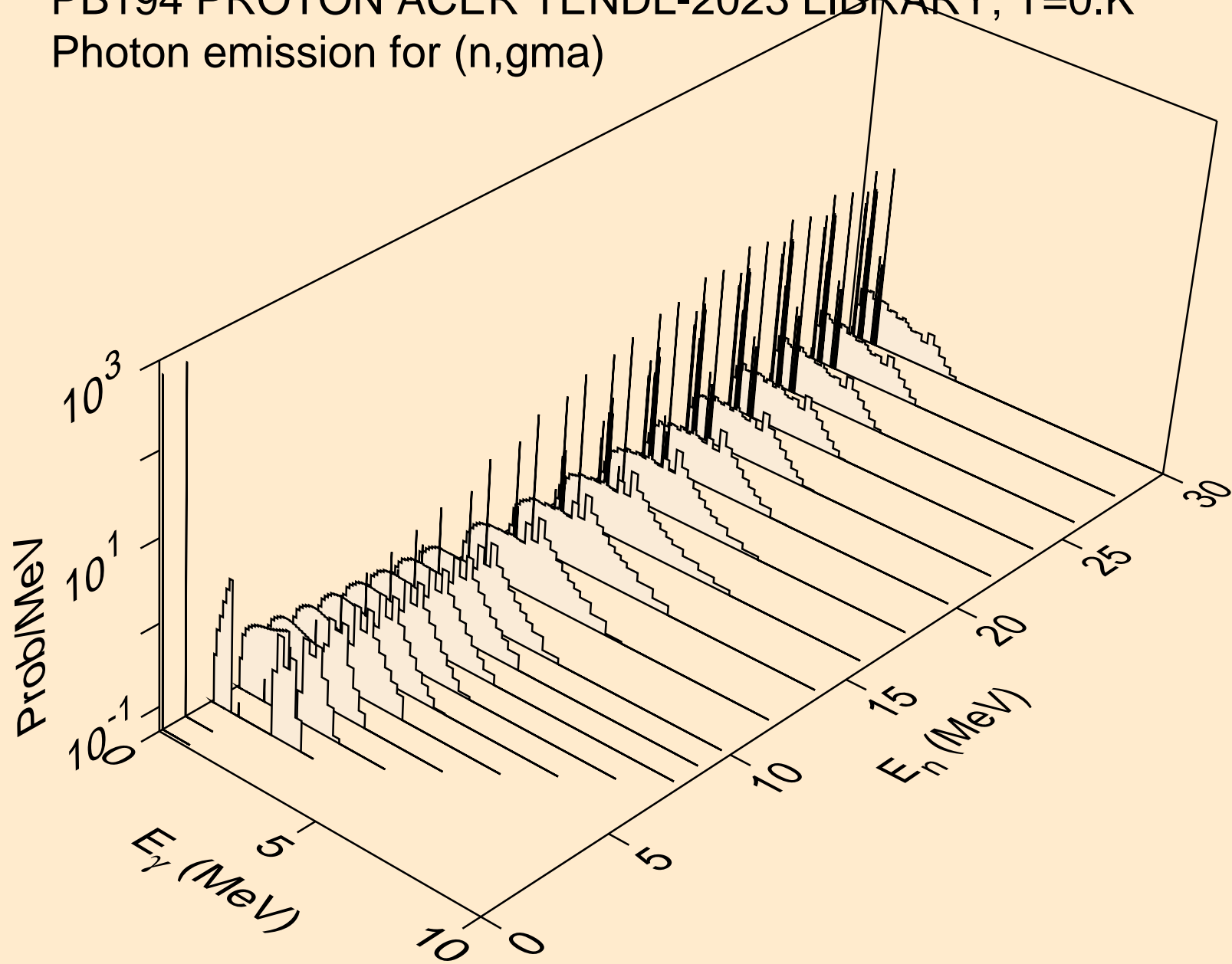

PB194 PROTON ACER TENDL-2023 LIBRARY; T=0.K  
Photon emission for inelastic

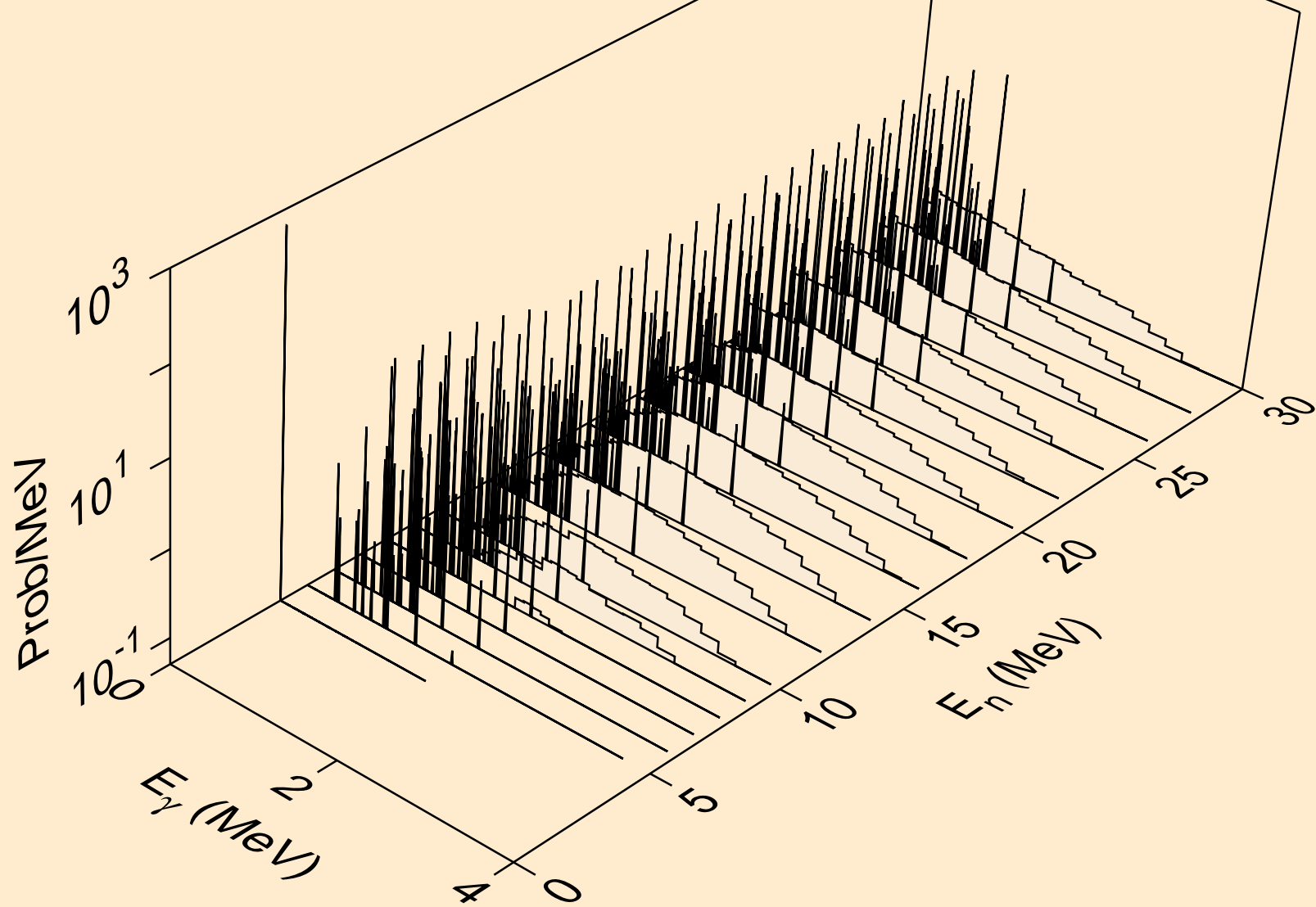

PB194 PROTON ACER TENDL-2023 LIBRARY; T=0.K  
Photon emission for (n,d)

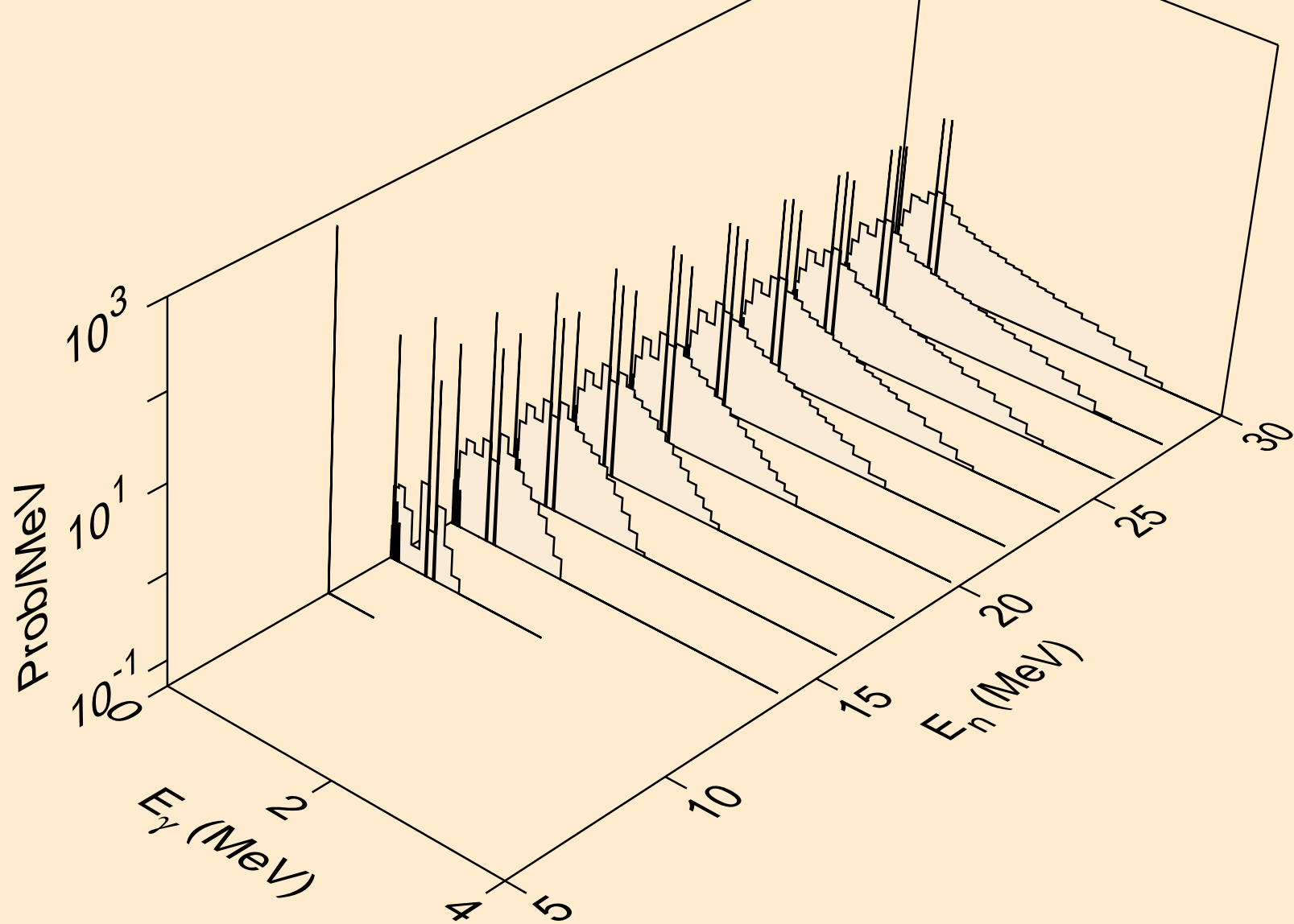

PB194 PROTON ACER TENDL-2023 LIBRARY; T=0.K  
Photon emission for (n,t)

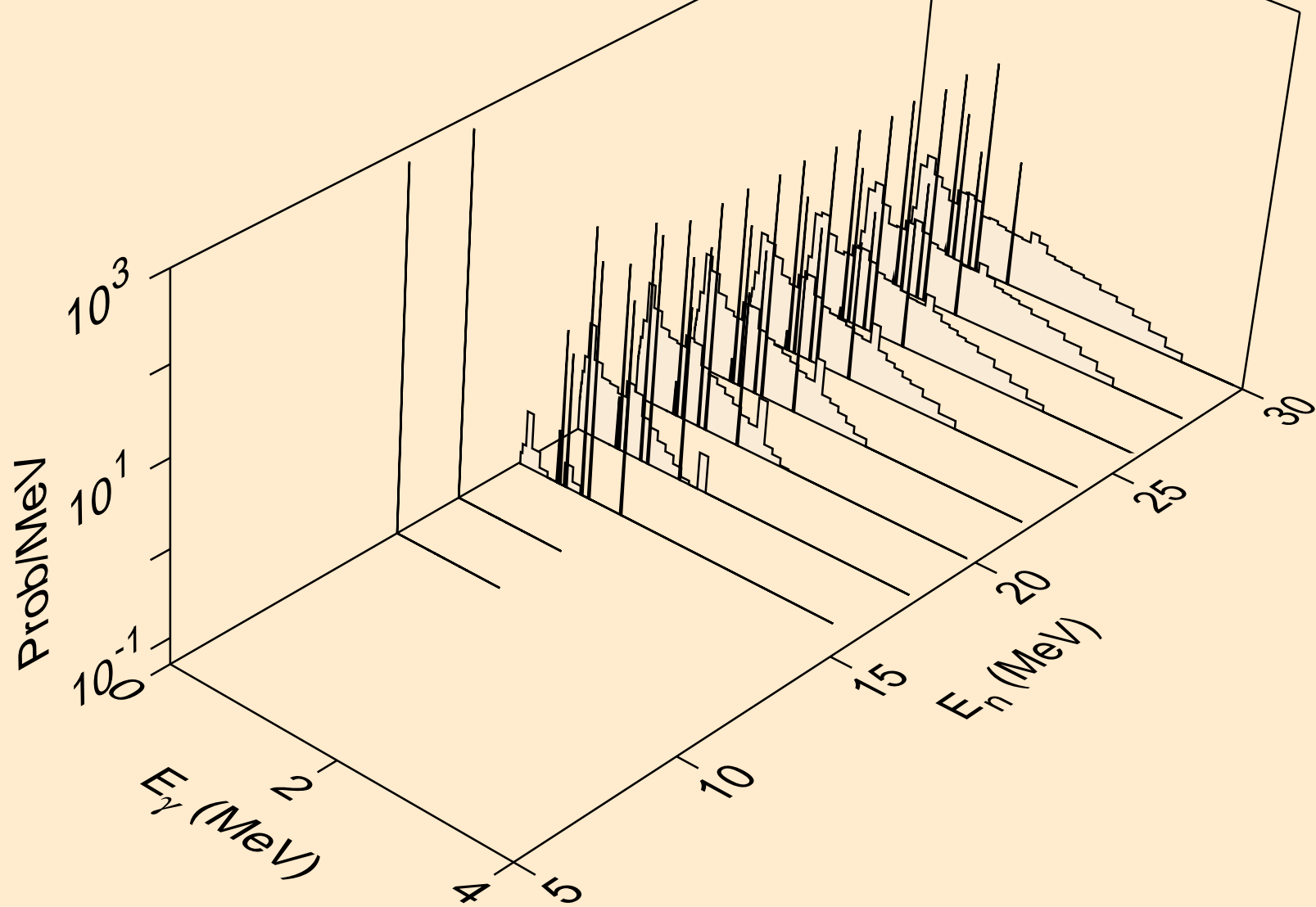

PB194 PROTON ACER TENDL-2023 LIBRARY; T=0.K  
Photon emission for (n,he3)

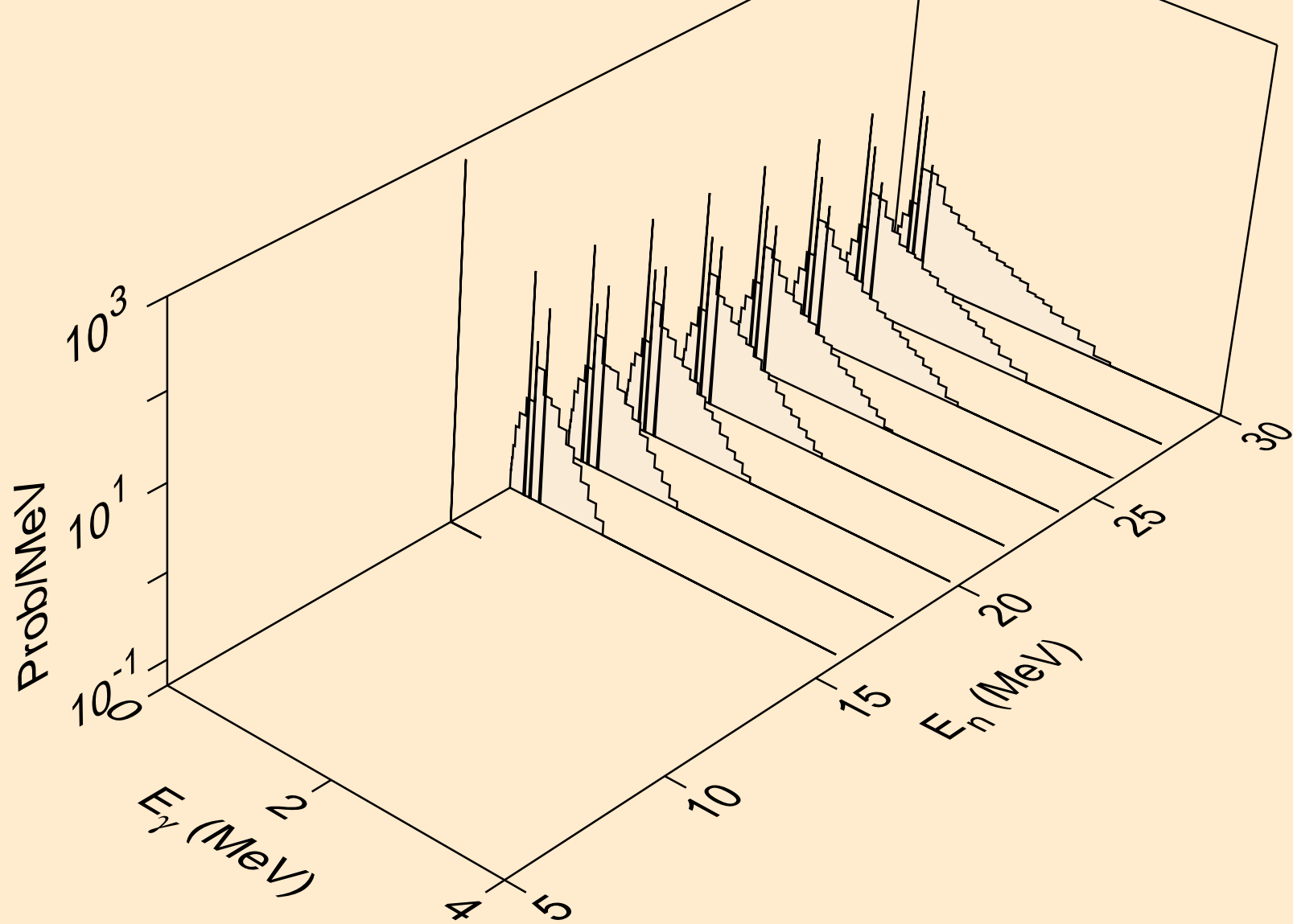

PB194 PROTON ACER TENDL-2023 LIBRARY; T=0.K  
Photon emission for (n,a)

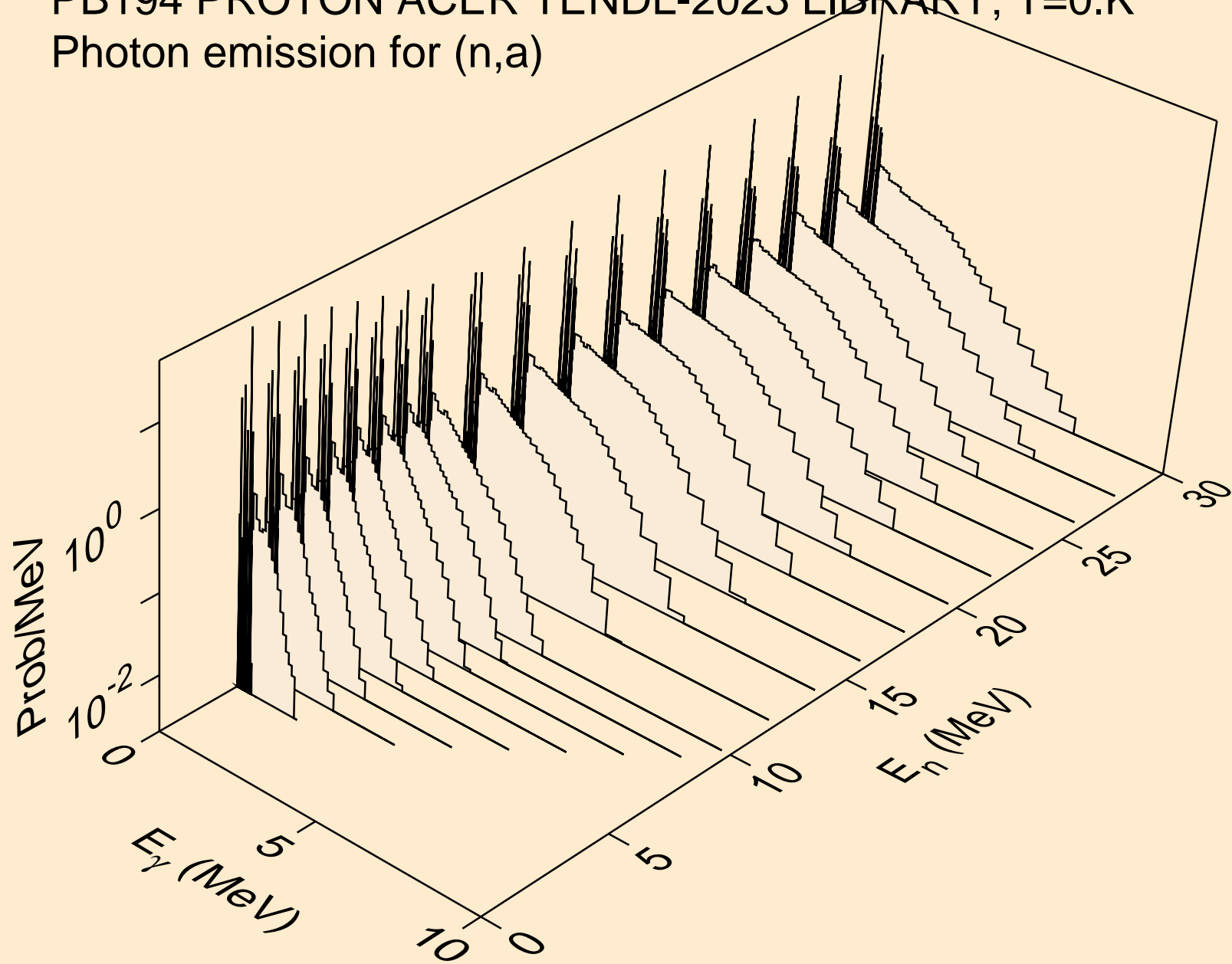

PB194 PROTON ACER TENDL-2023 LIBRARY; T=0.K  
Photon emission for (n,2a)

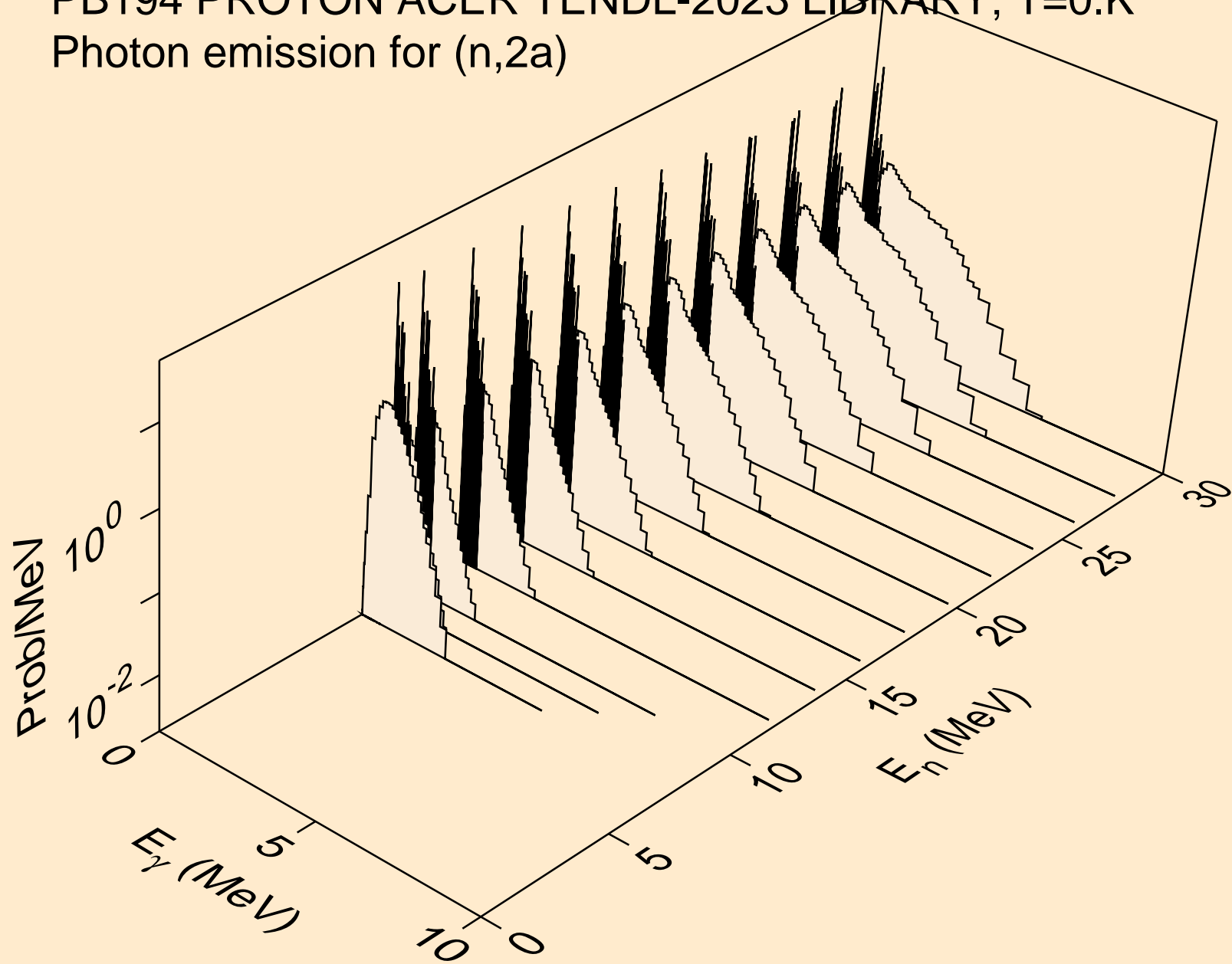



PB194 PROTON ACER TENDL-2023 LIBRARY; T=0.K  
Photon emission for (n,2p)

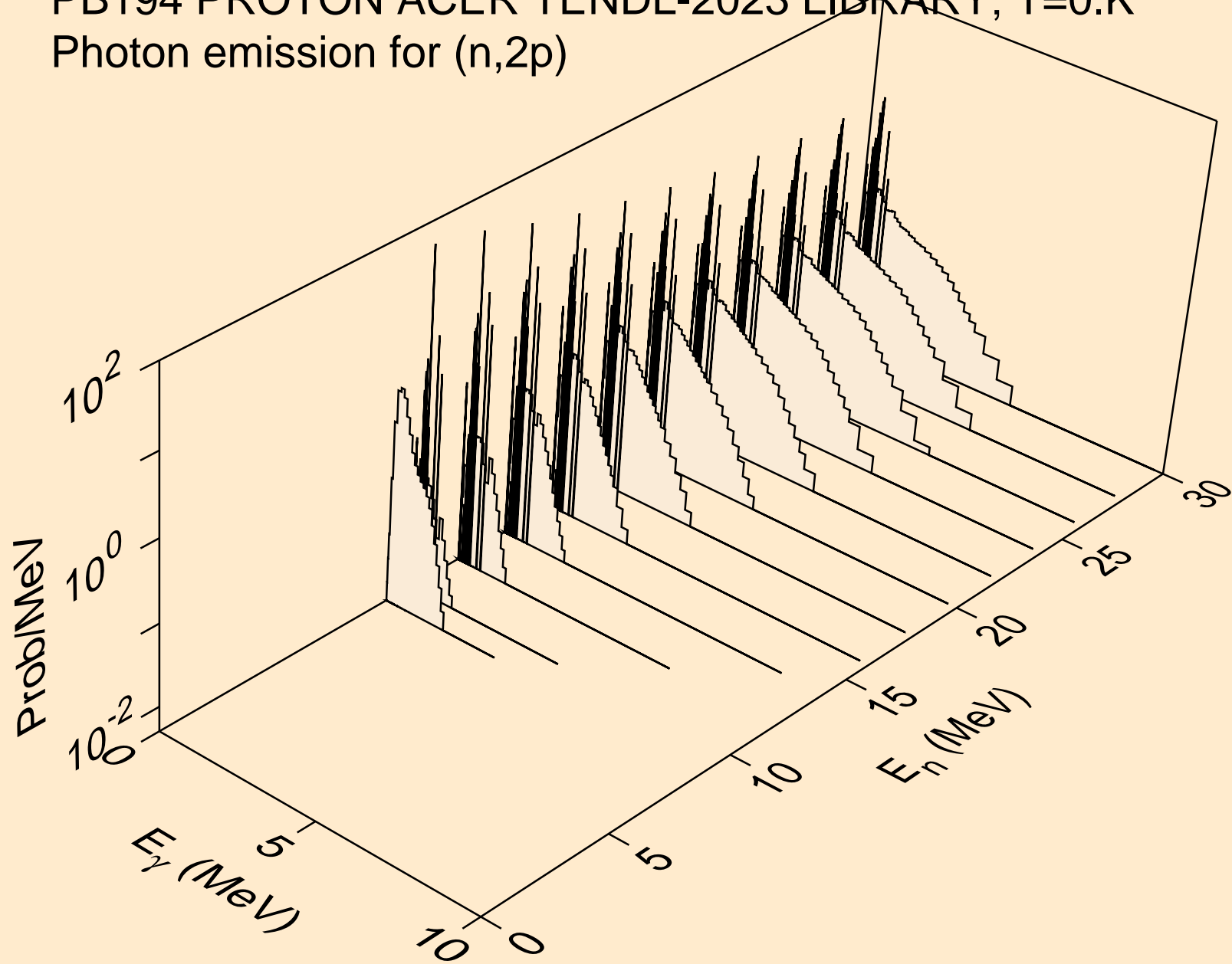

PB194 PROTON ACER TENDL-2023 LIBRARY; T=0.K  
Photon emission for (n,pa)

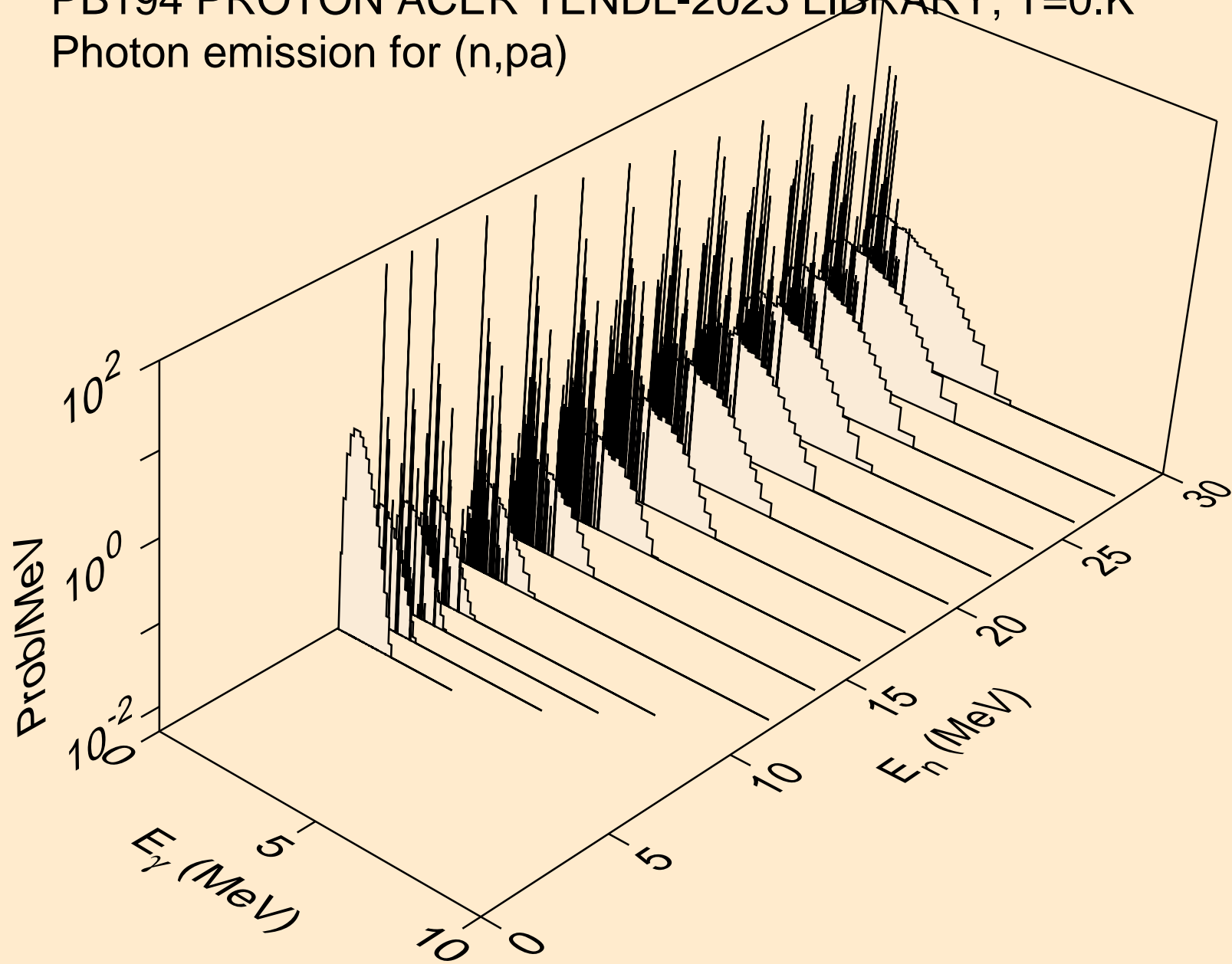

PB194 PROTON ACER TENDL-2023 LIBRARY; T=0.K  
Photon emission for (n,pd)

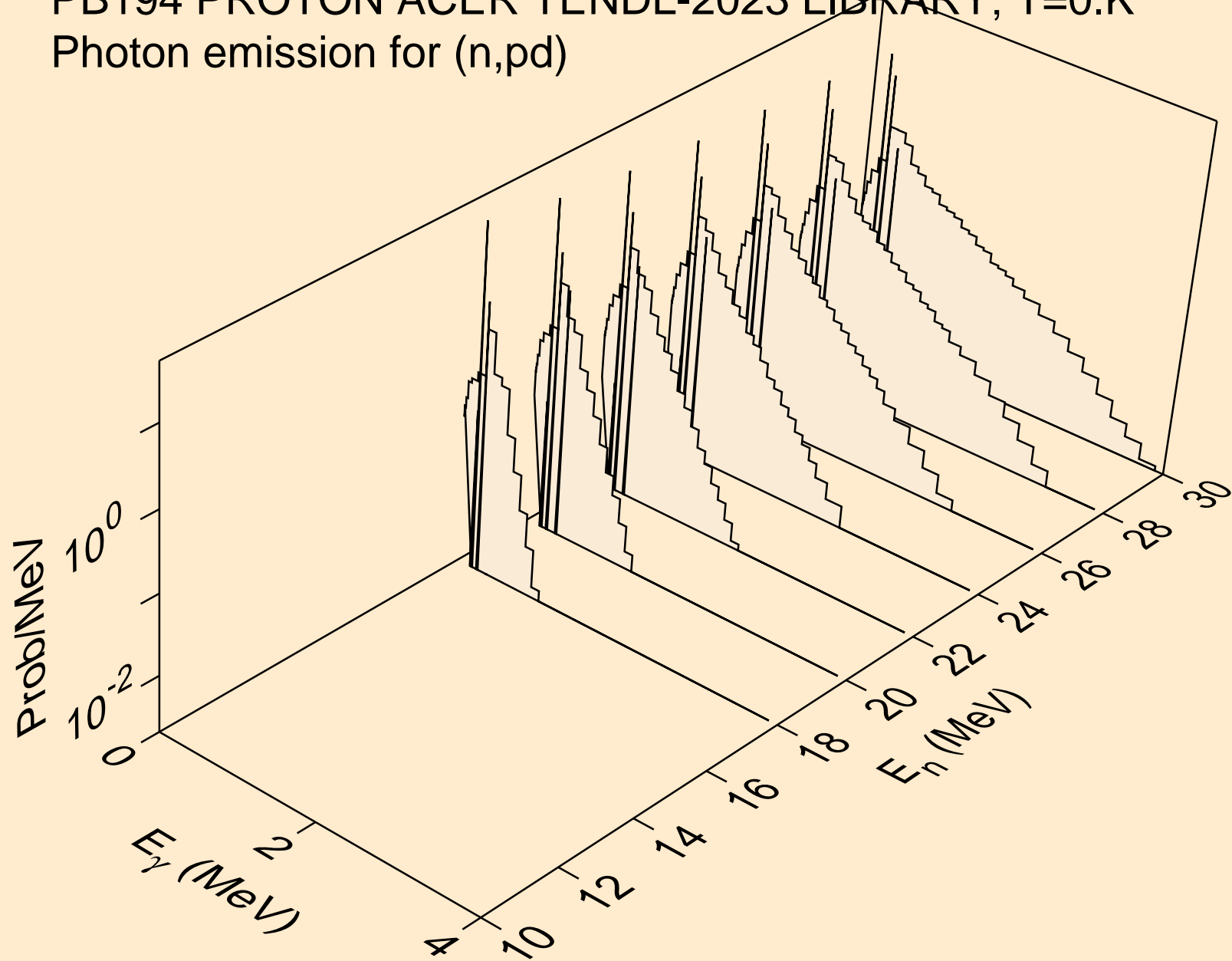

PB194 PROTON ACER TENDL-2023 LIBRARY; T=0.K  
Photon emission for (n,pt)

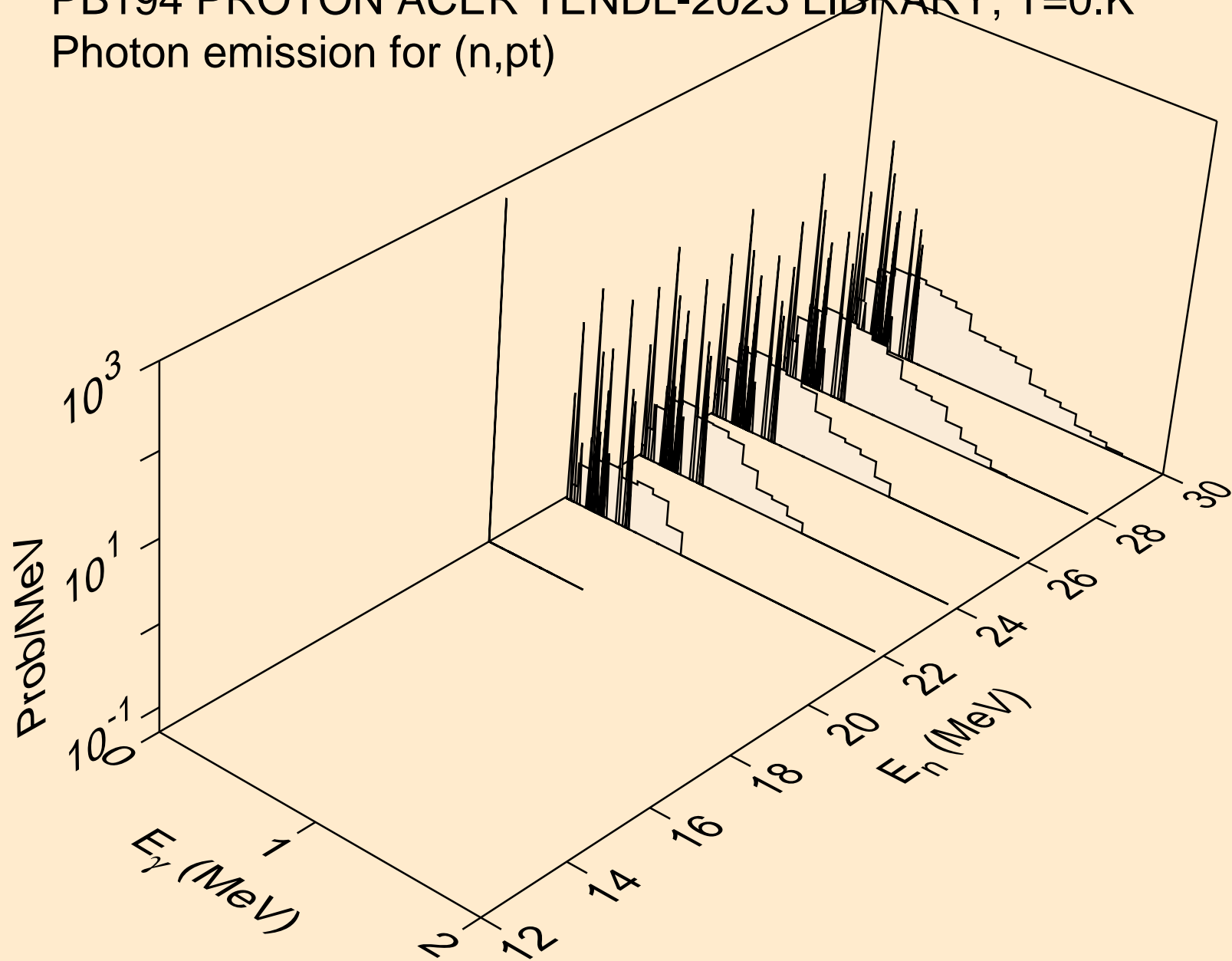

PB194 PROTON ACER TENDL-2023 LIBRARY; T=0.K  
Photon emission for (n,da)

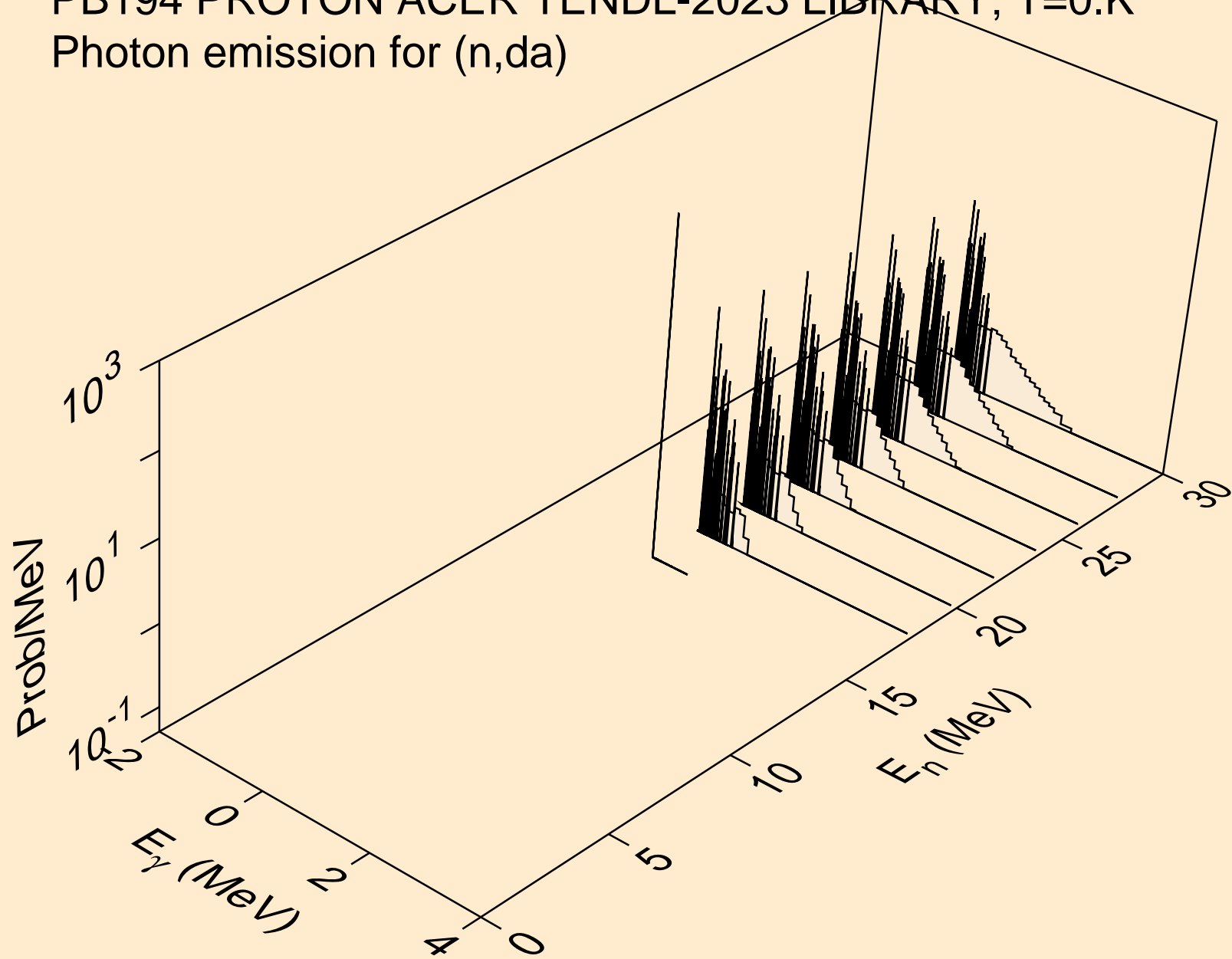

PB194 PROTON ACER TENDL-2023 LIBRARY; T=0.K  
Particle heating contributions

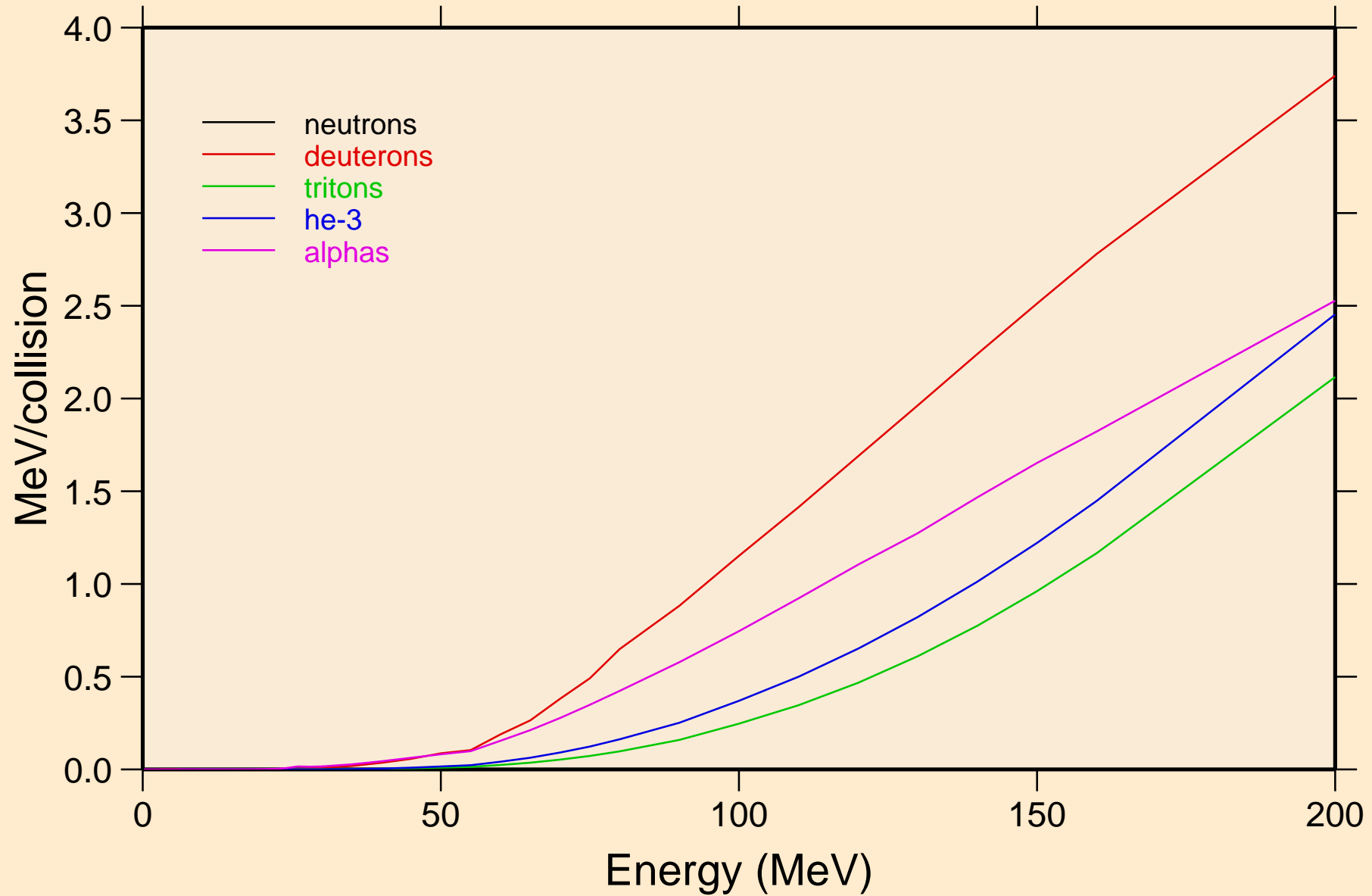

PB194 PROTON ACER TENDL-2023 LIBRARY; T=0.K  
Recoil Heating

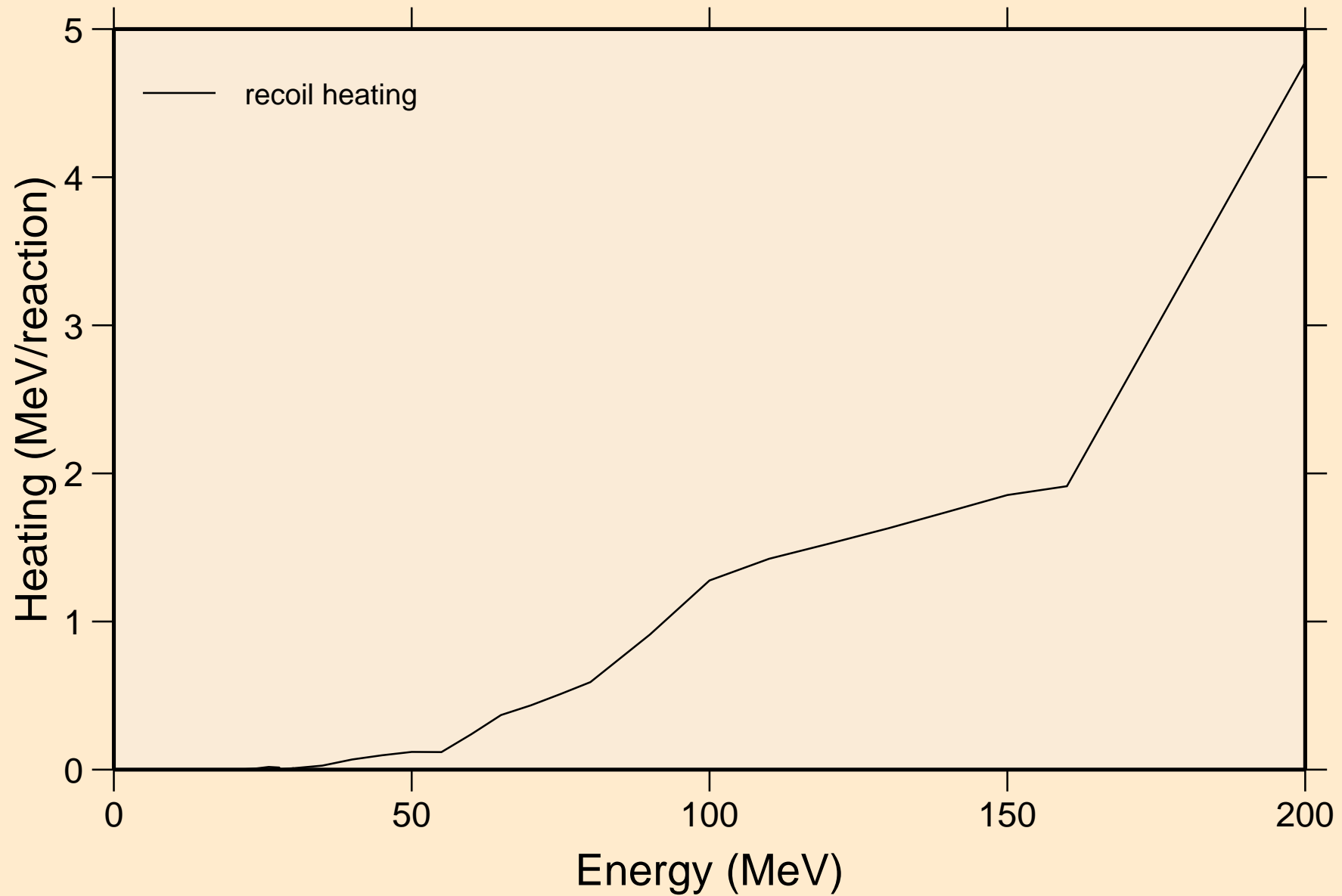

PB194 PROTON ACER TENDL-2023 LIBRARY; T=0.K  
Particle production cross sections

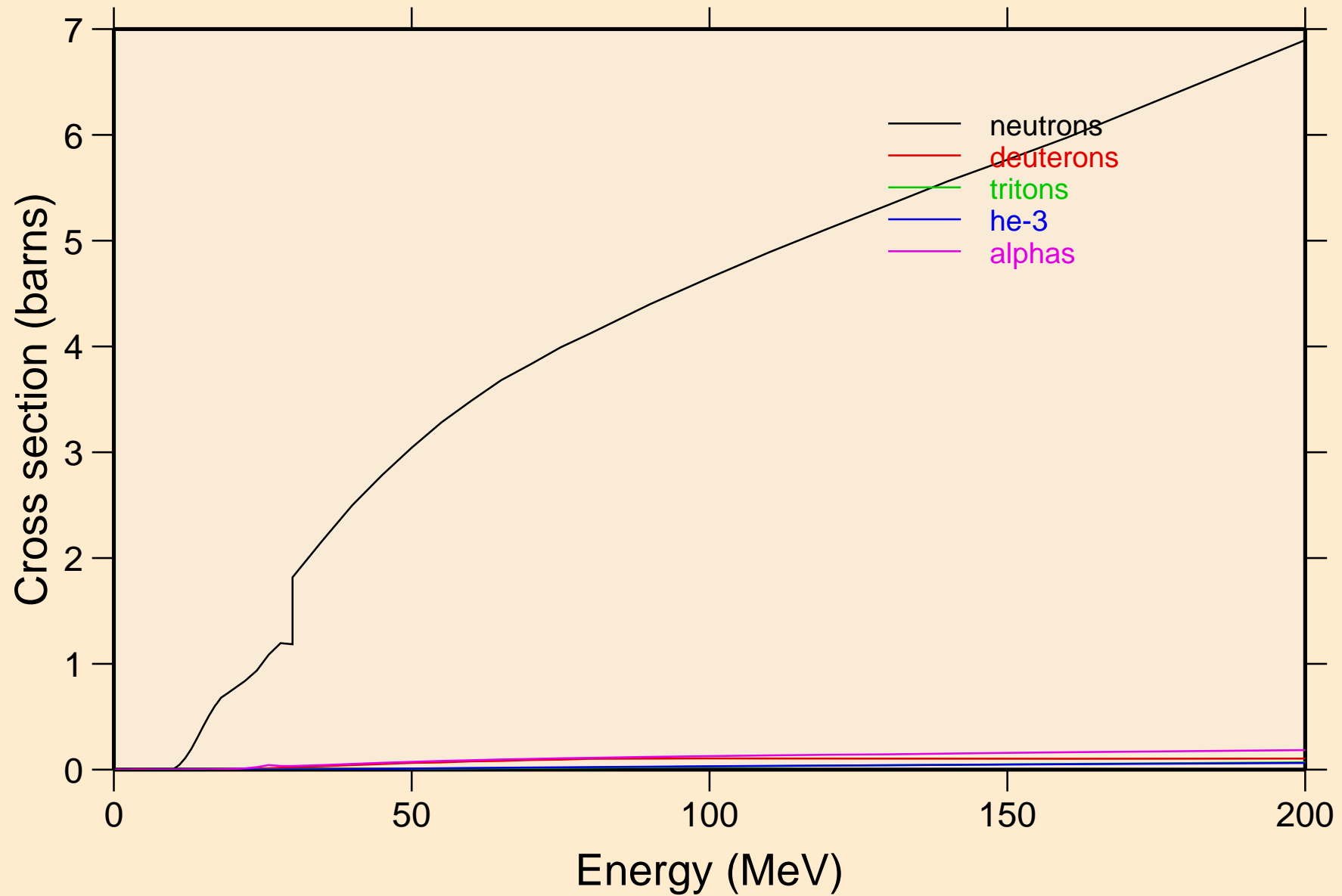



PB194 PROTON ACER TENDL-2023 LIBRARY; T=0.K  
neutrons from (p,n)

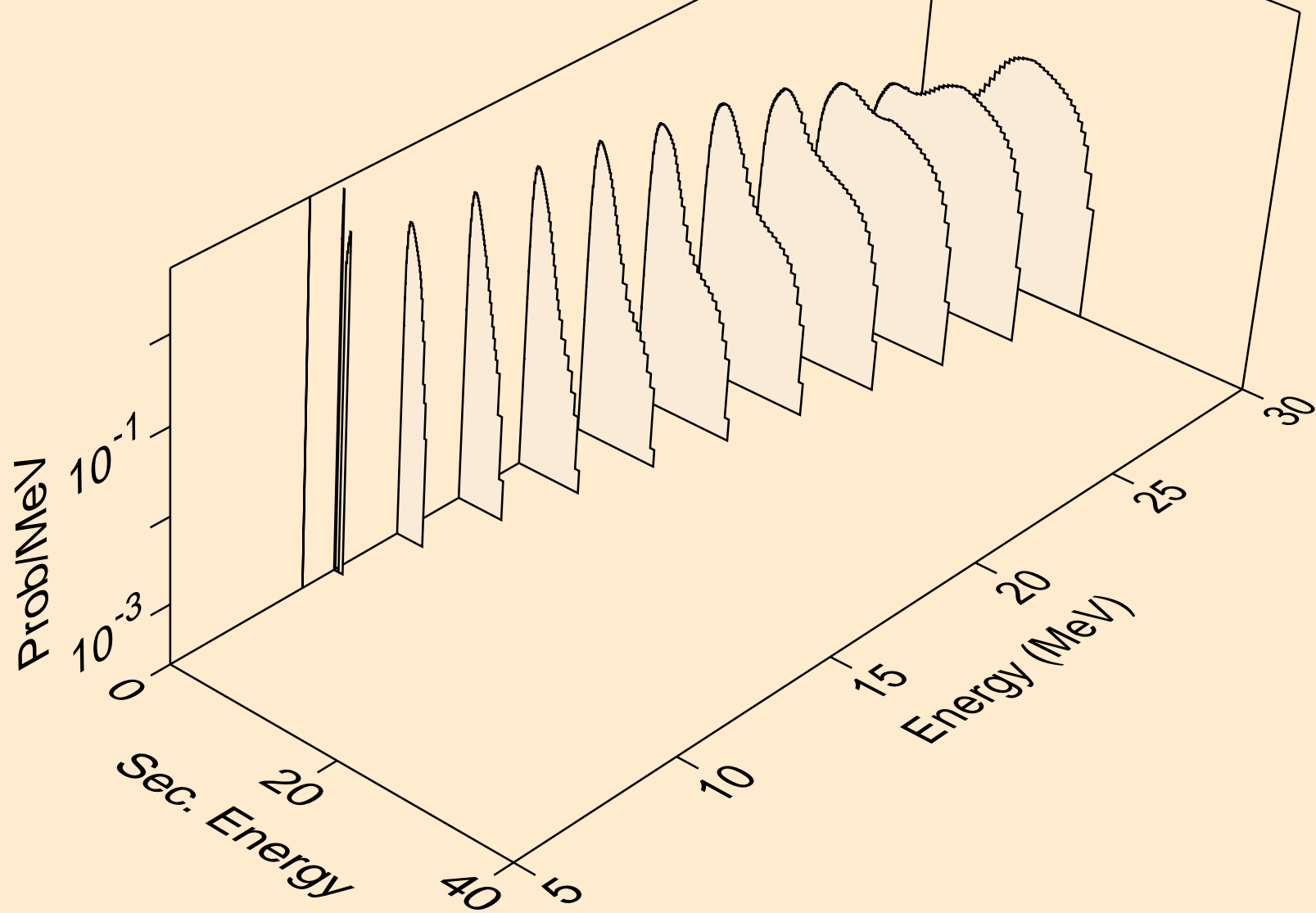

PB194 PROTON ACER TENDL-2023 LIBRARY; T=0.K  
neutrons from (p,x)

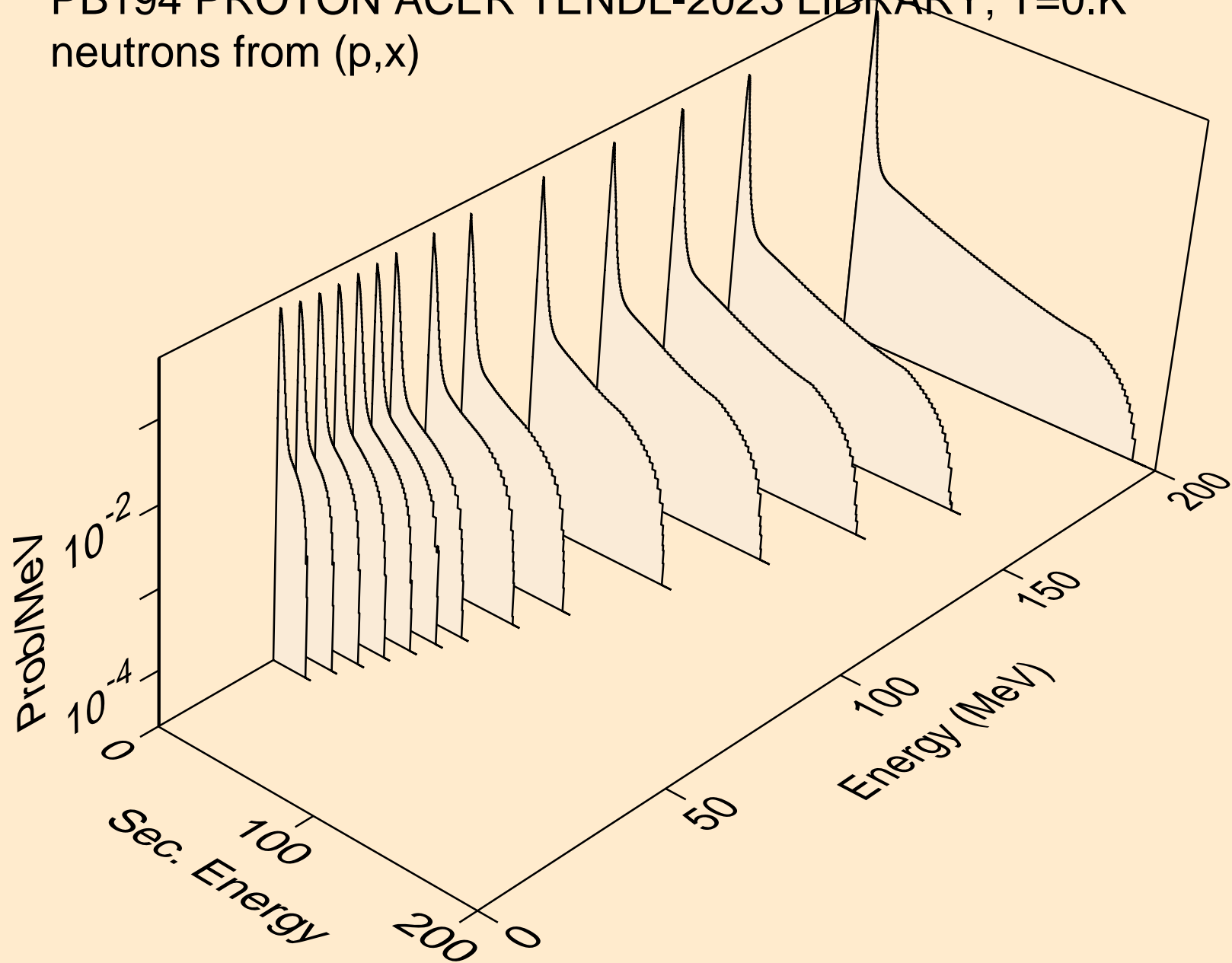

PB194 PROTON ACER TENDL-2023 LIBRARY; T=0.K  
neutrons from (p,2n)

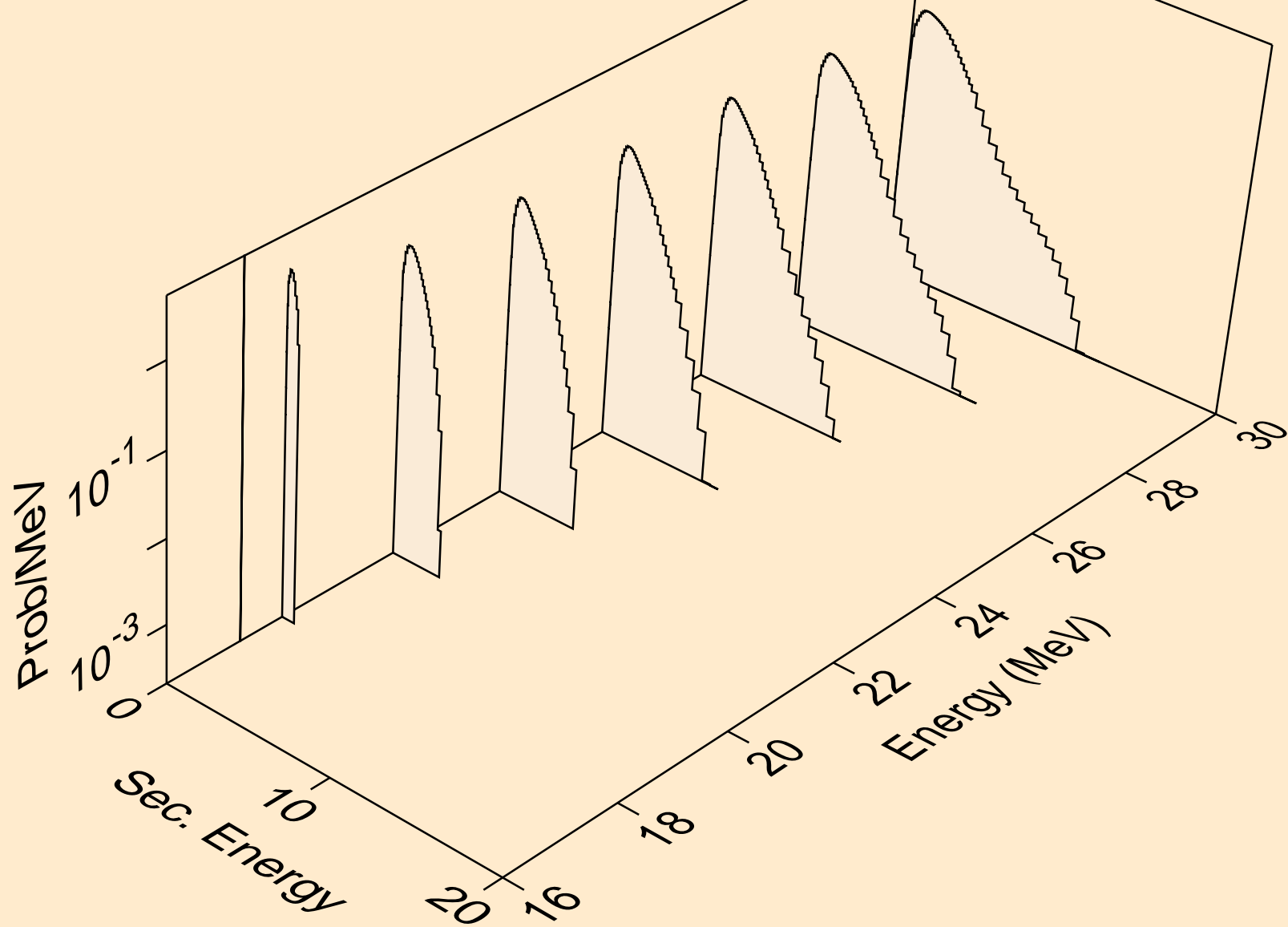

PB194 PROTON ACER TENDL-2023 LIBRARY; T=0.K  
neutrons from (p,3n)

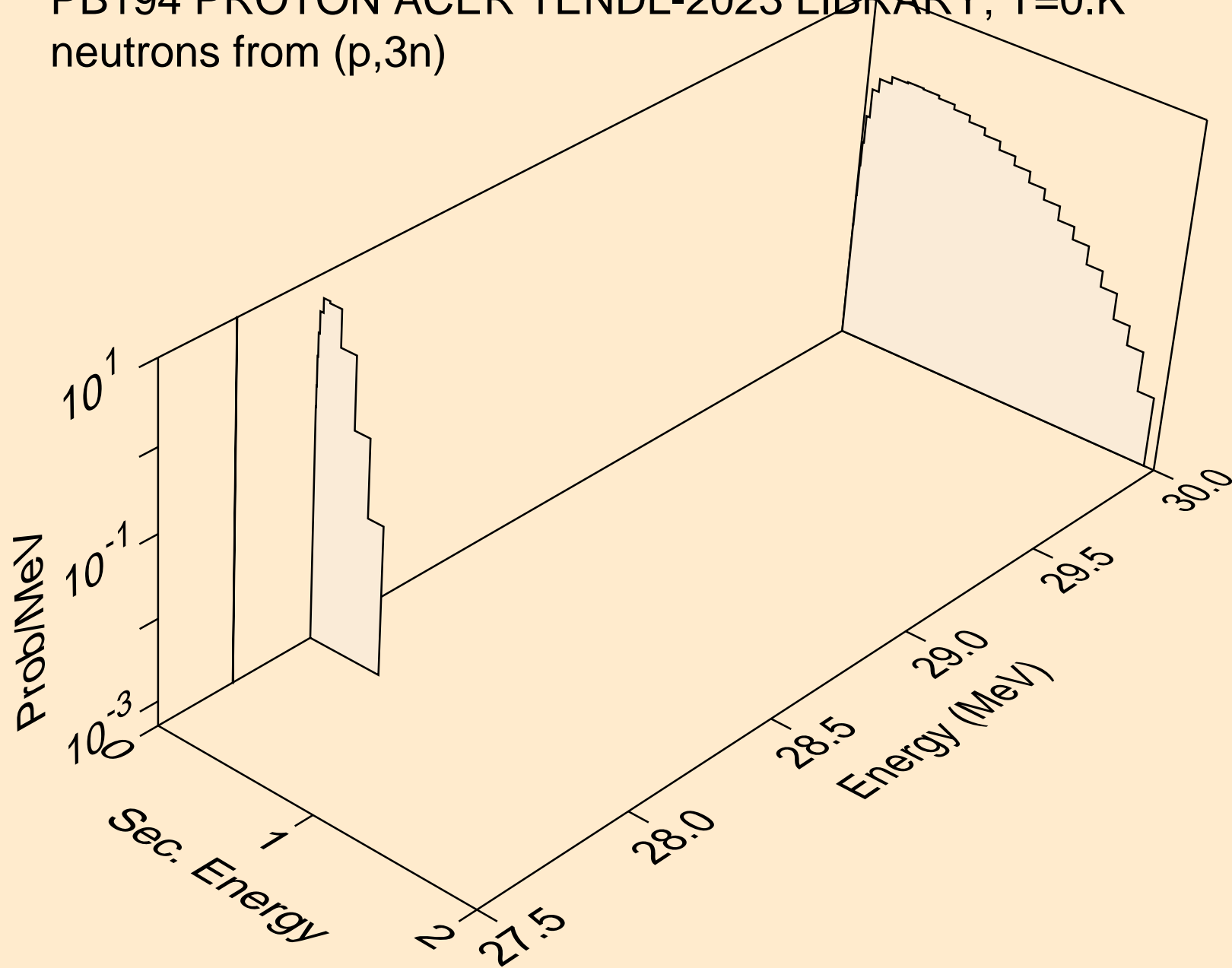

PB194 PROTON ACER TENDL-2023 LIBRARY; T=0.K  
neutrons from (p,n\*)a

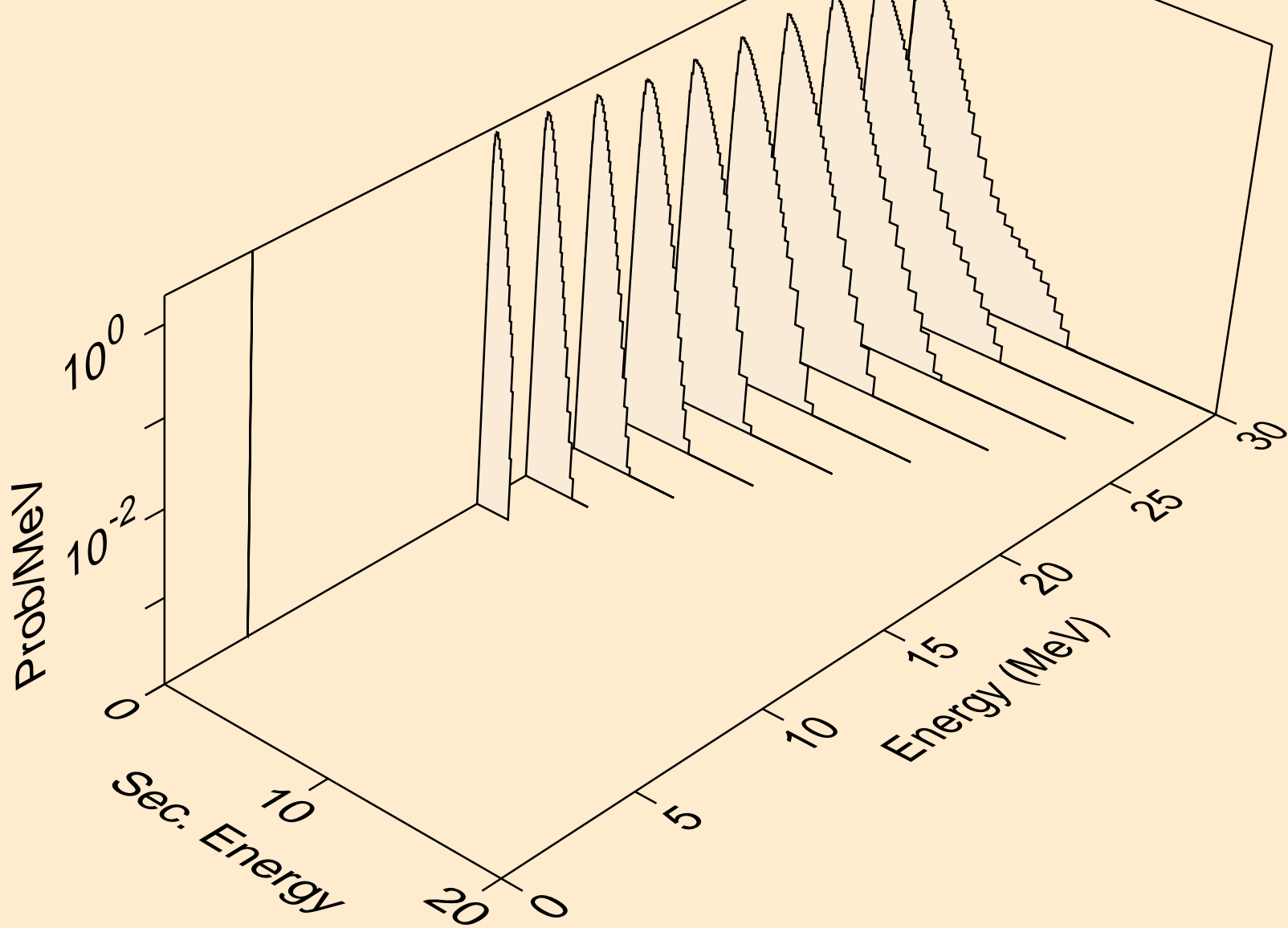

PB194 PROTON ACER TENDL-2023 LIBRARY; T=0.K  
neutrons from (p,2n)a

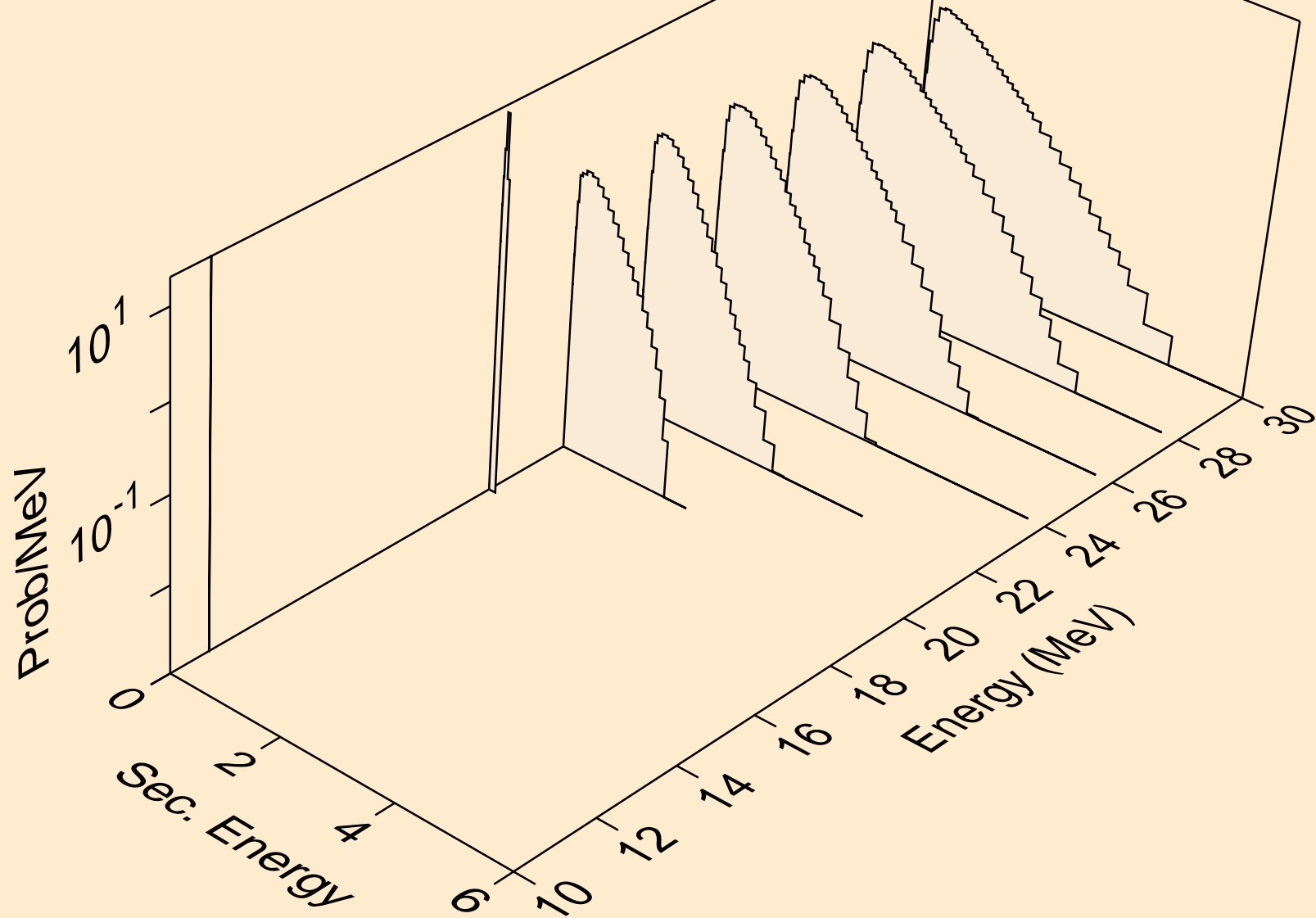

PB194 PROTON ACER TENDL-2023 LIBRARY; T=0.K  
neutrons from (p,n\*)p

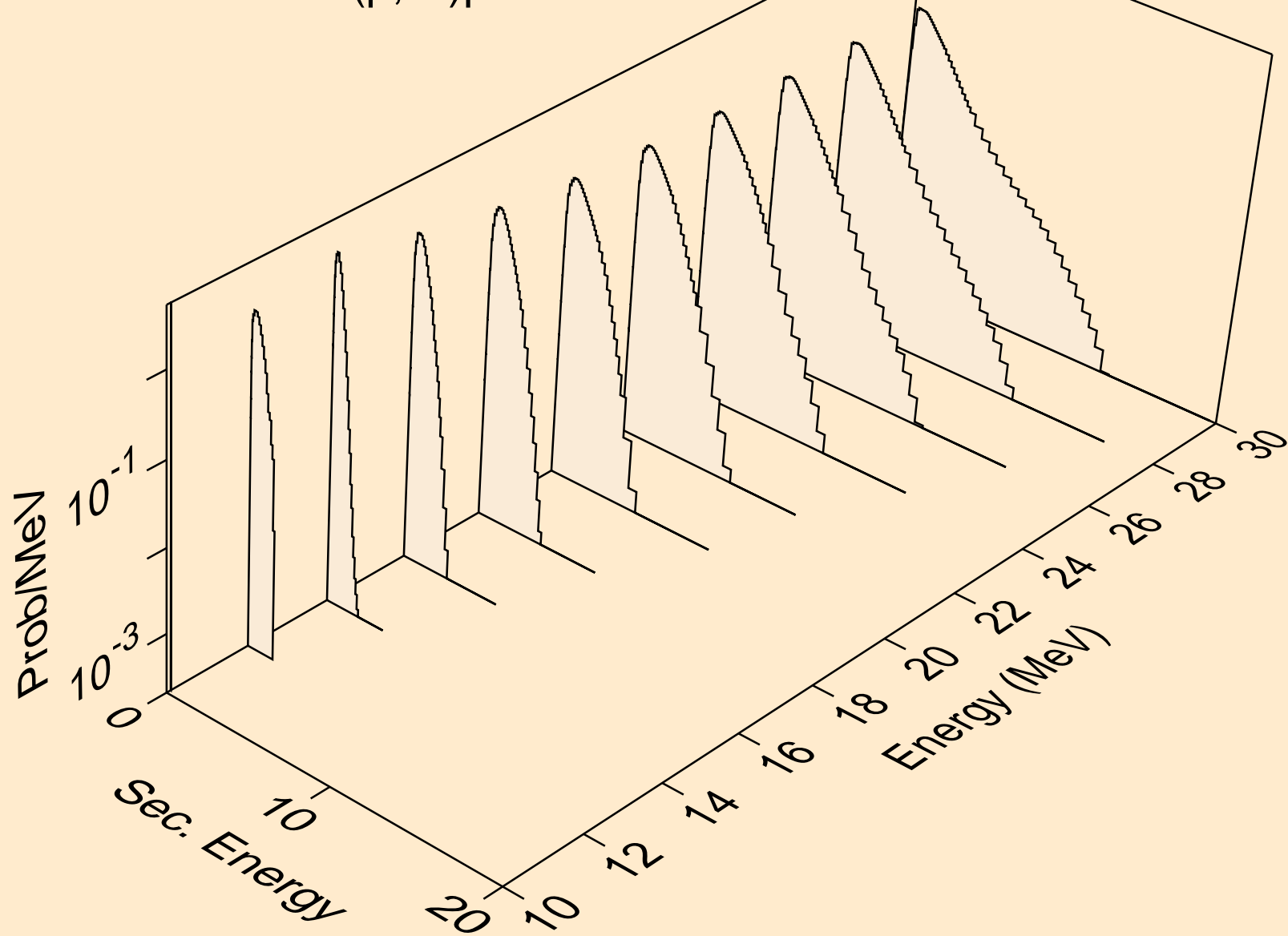

PB194 PROTON ACER TENDL-2023 LIBRARY; T=0.K  
neutrons from (p,n\*)2a

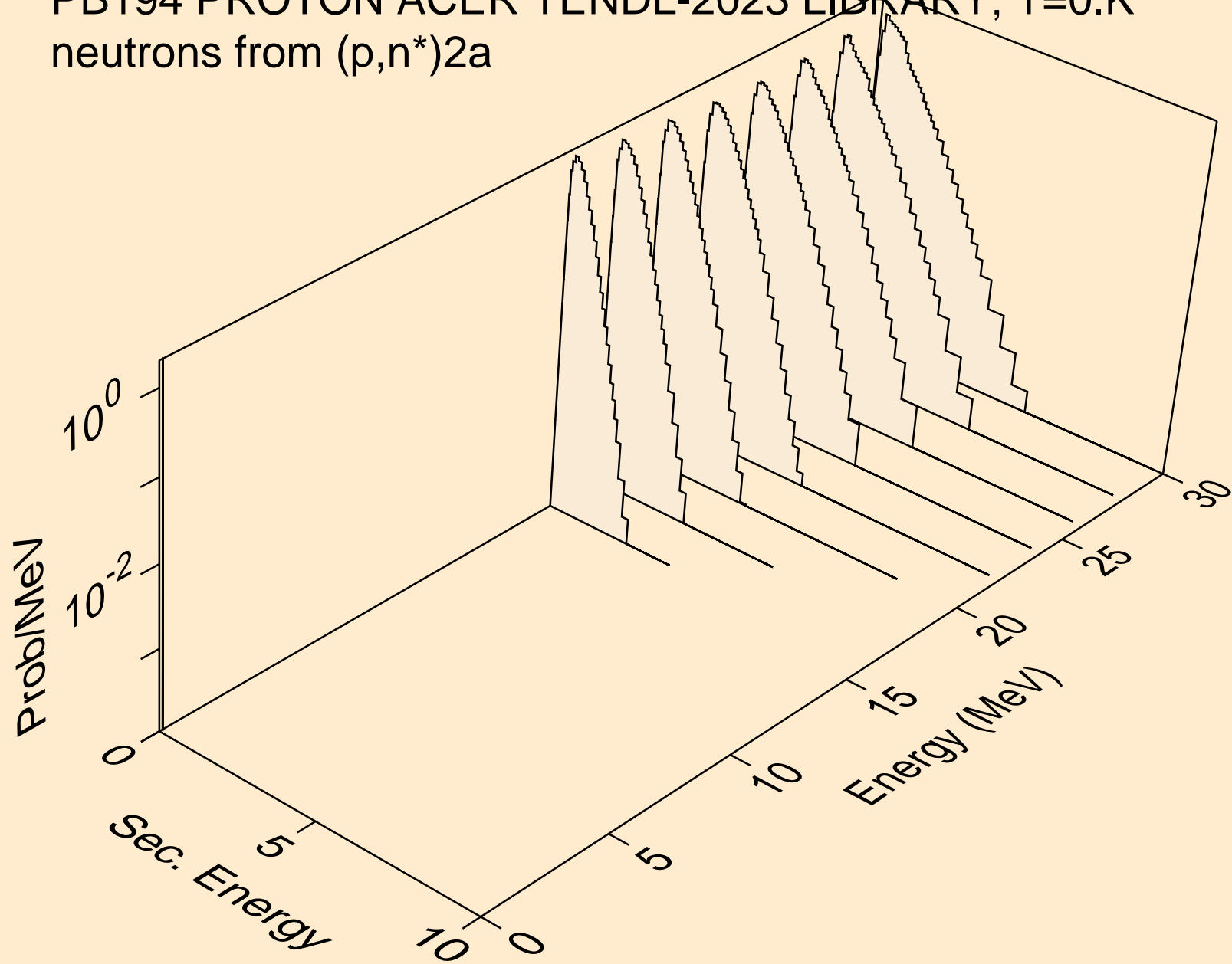



PB194 PROTON ACER TENDL-2023 LIBRARY; T=0.K  
neutrons from (p,n\*)d

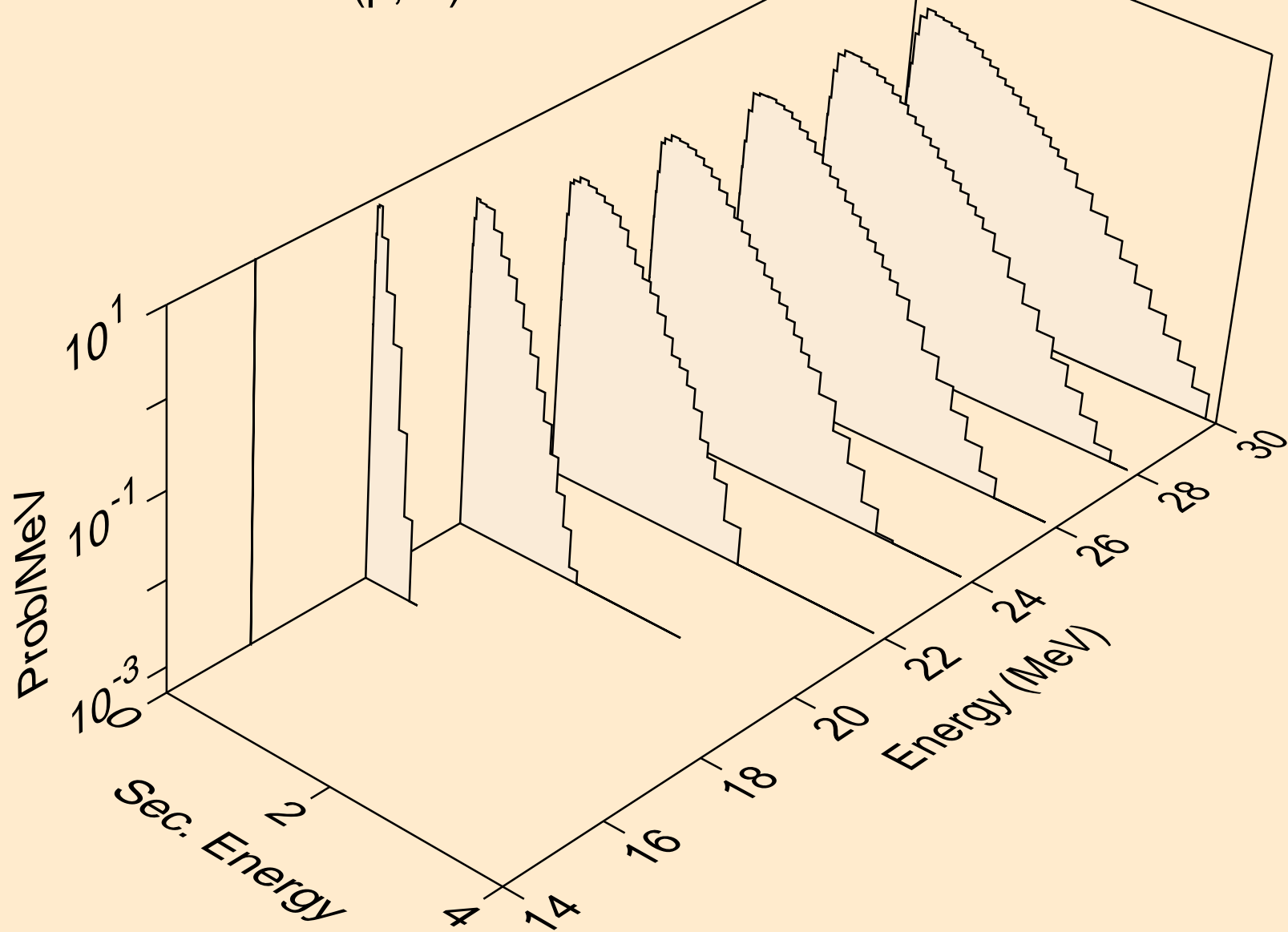

PB194 PROTON ACER TENDL-2023 LIBRARY; T=0.K  
neutrons from (p,n\*)t

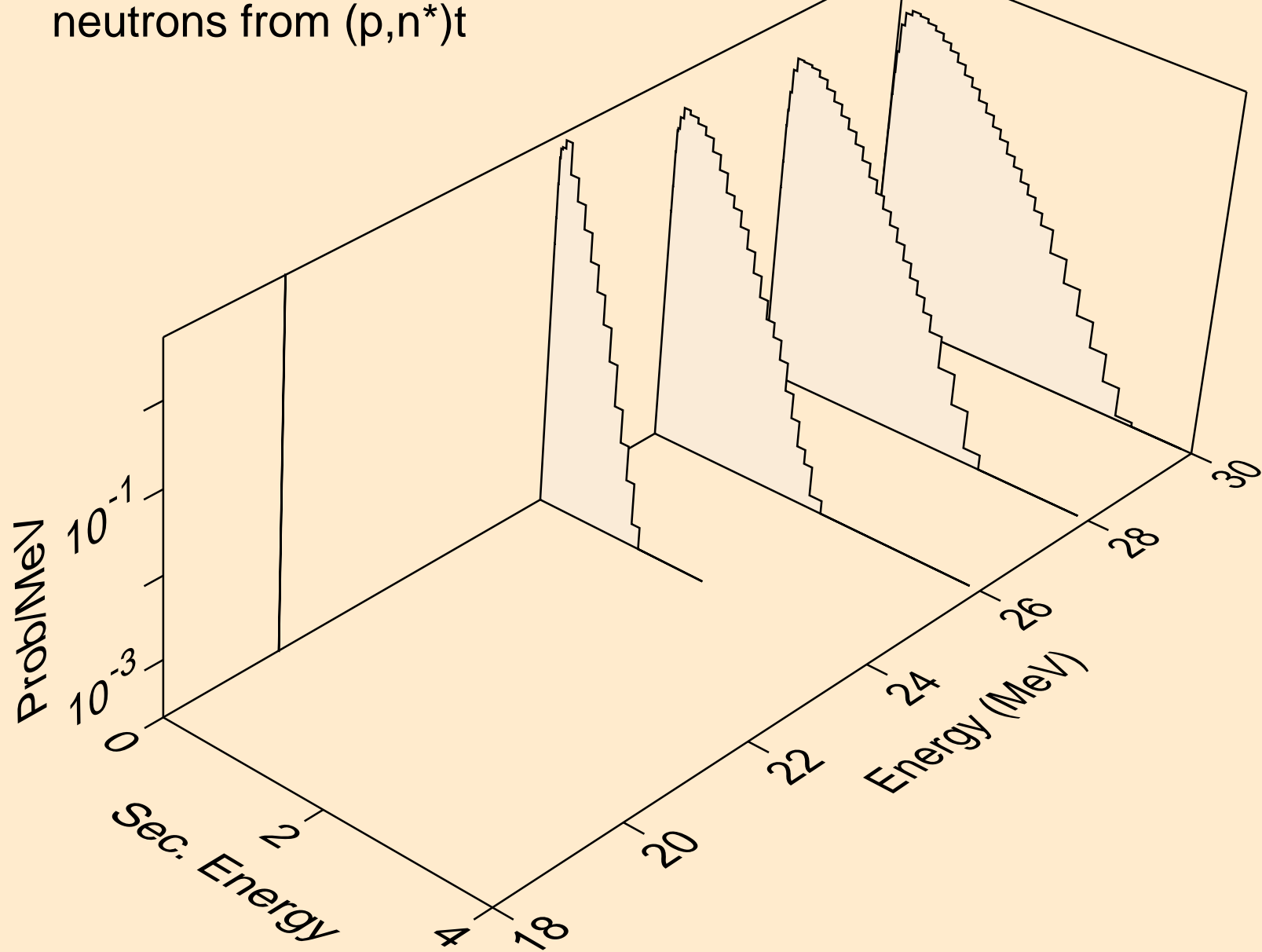

PB194 PROTON ACER TENDL-2023 LIBRARY; T=0.K  
neutrons from (p,n\*)he3

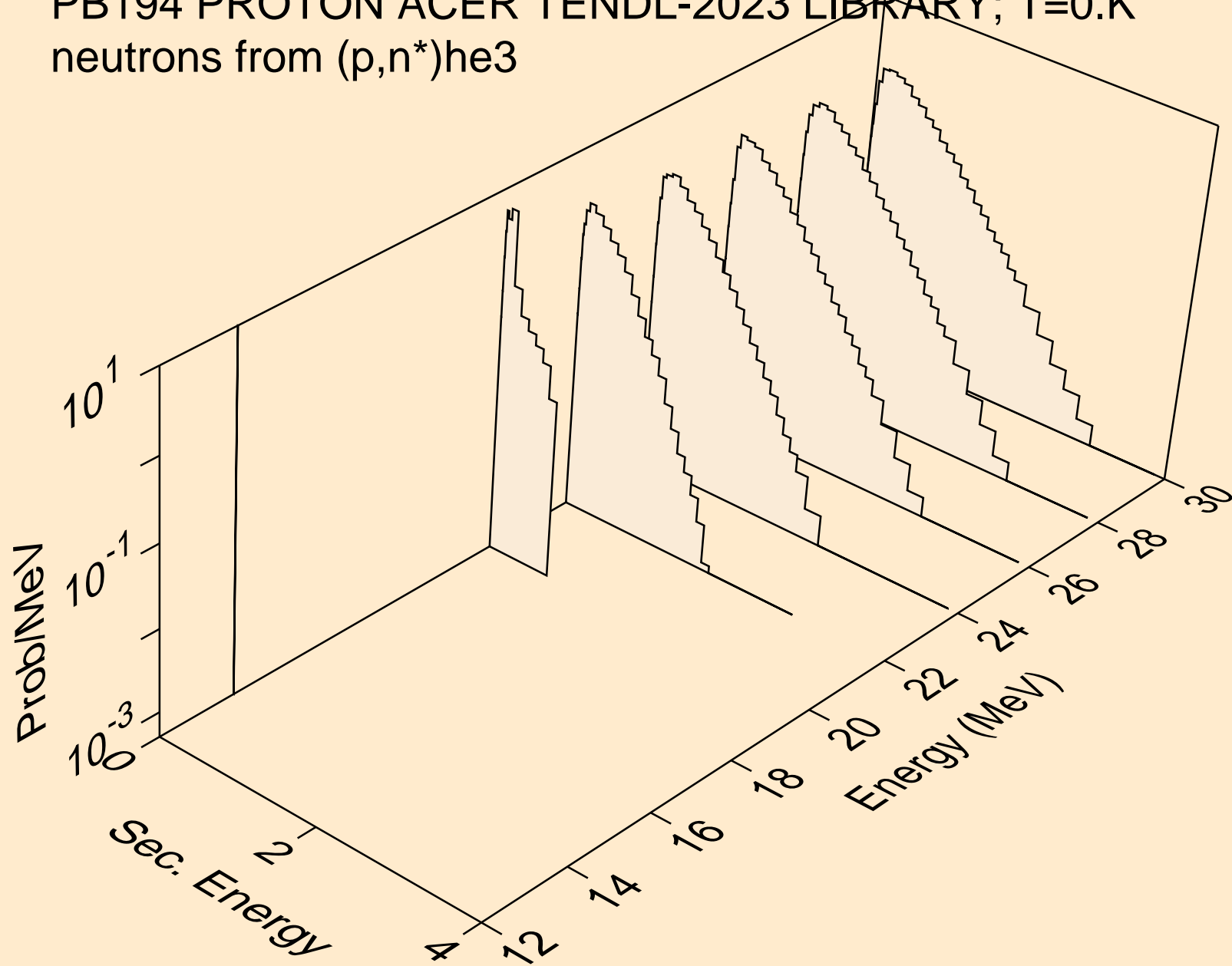

PB194 PROTON ACER TENDL-2023 LIBRARY; T=0.K  
neutrons from (p,2np)

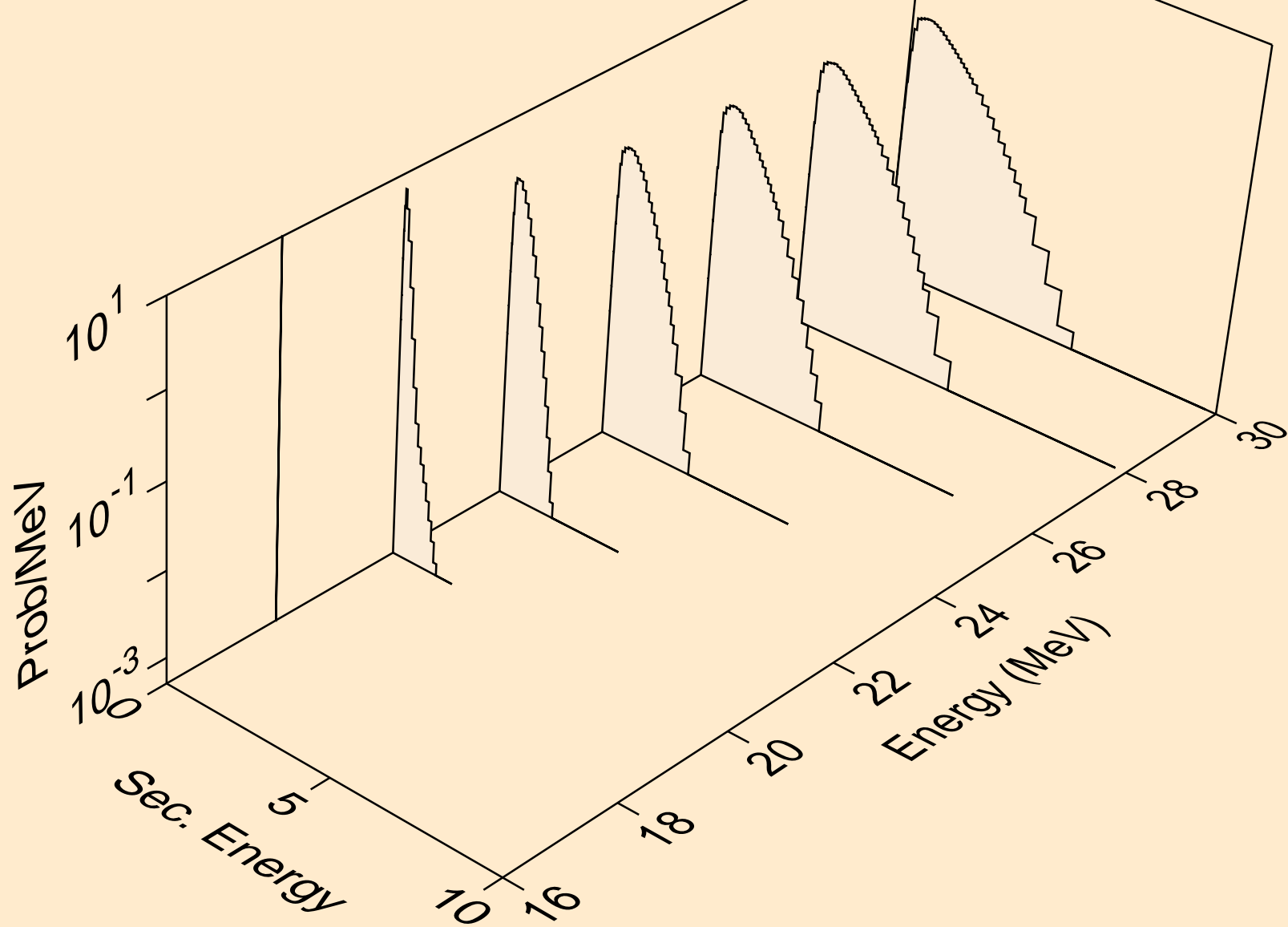

PB194 PROTON ACER TENDL-2023 LIBRARY; T=0.K  
neutrons from (p,n2p)

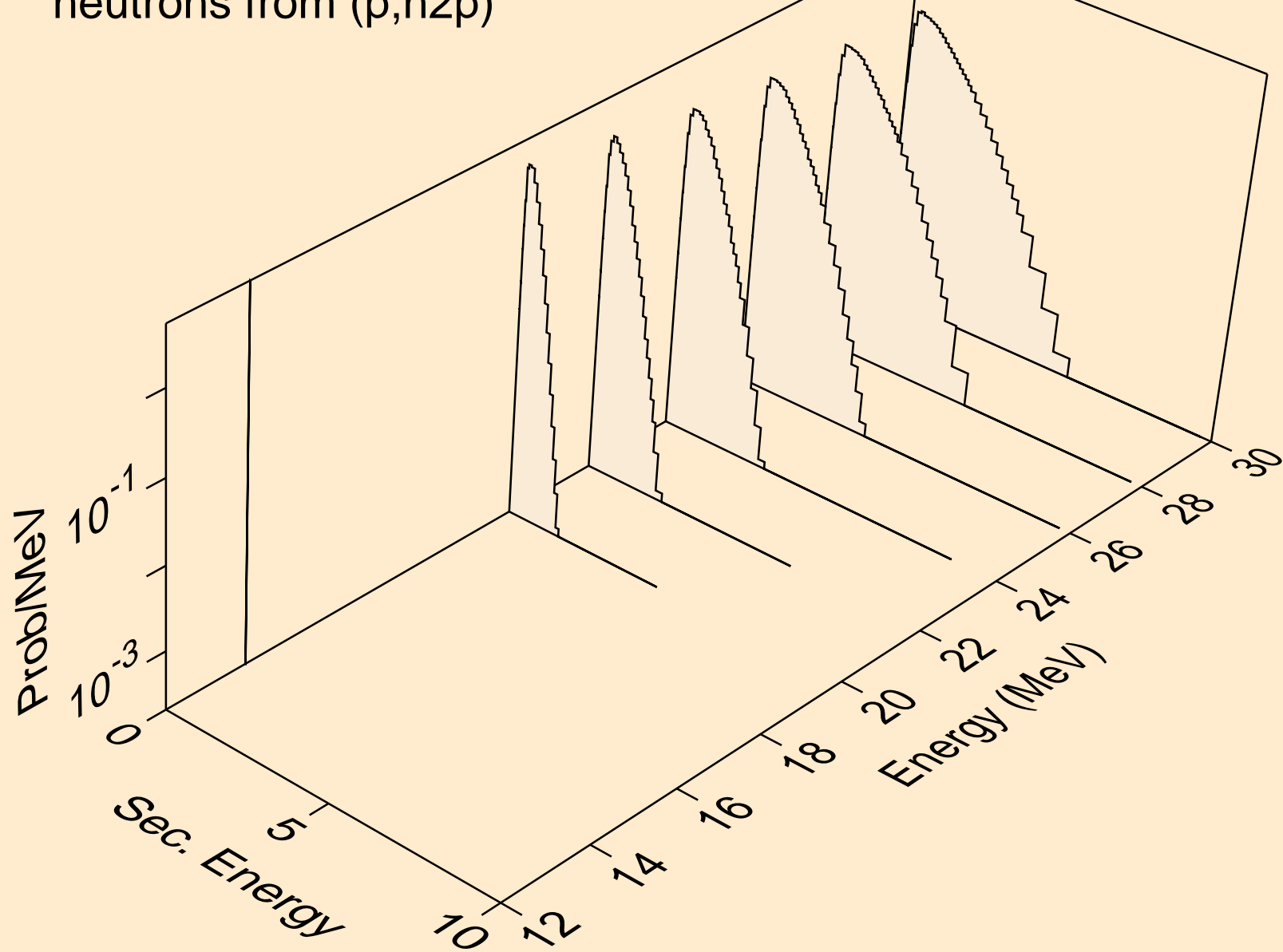

PB194 PROTON ACER TENDL-2023 LIBRARY; T=0.K  
neutrons from (p,npa)

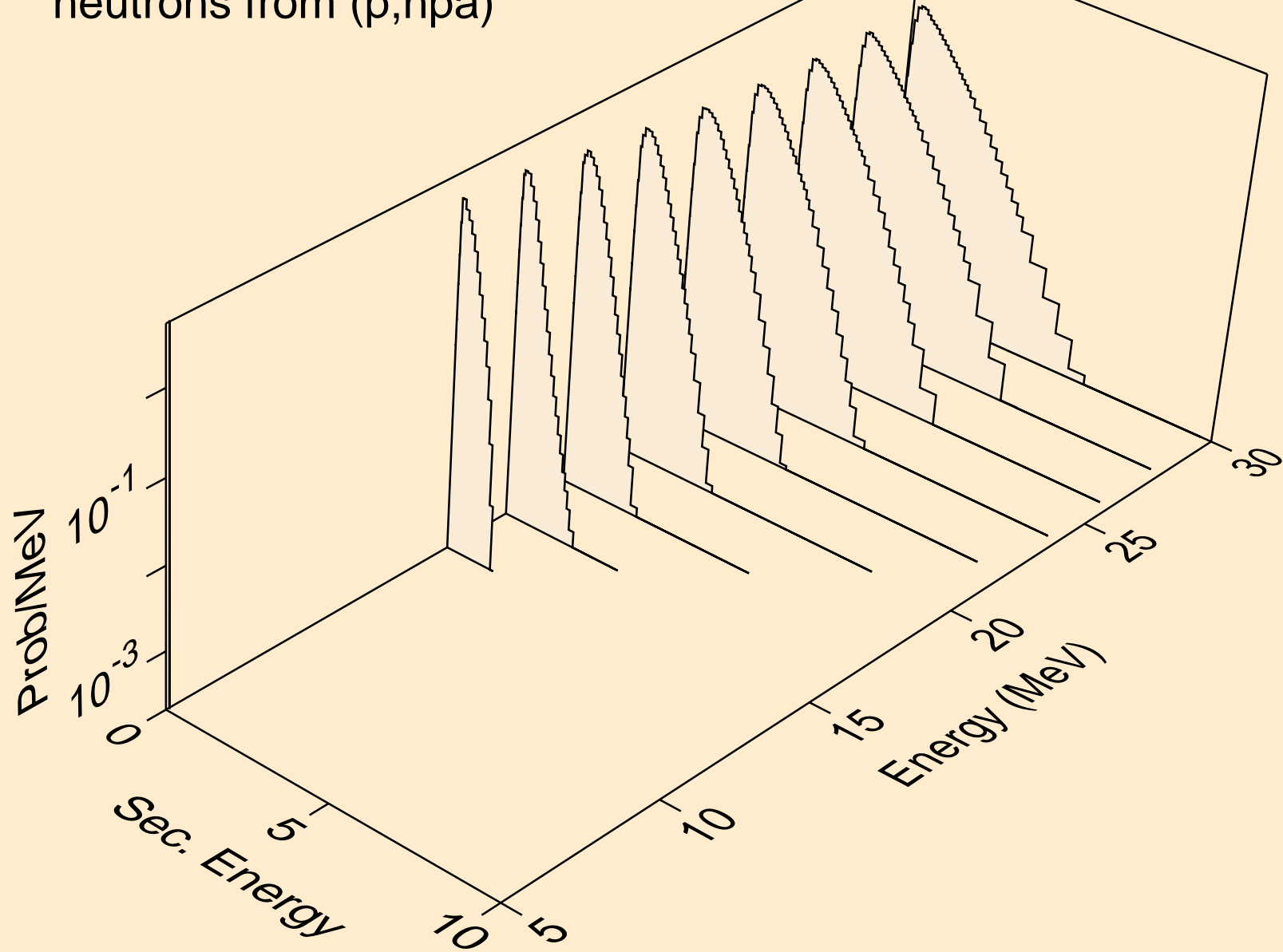

PB194 PROTON ACER TENDL-2023 LIBRARY; T=0.K  
deuterons from (p,x)

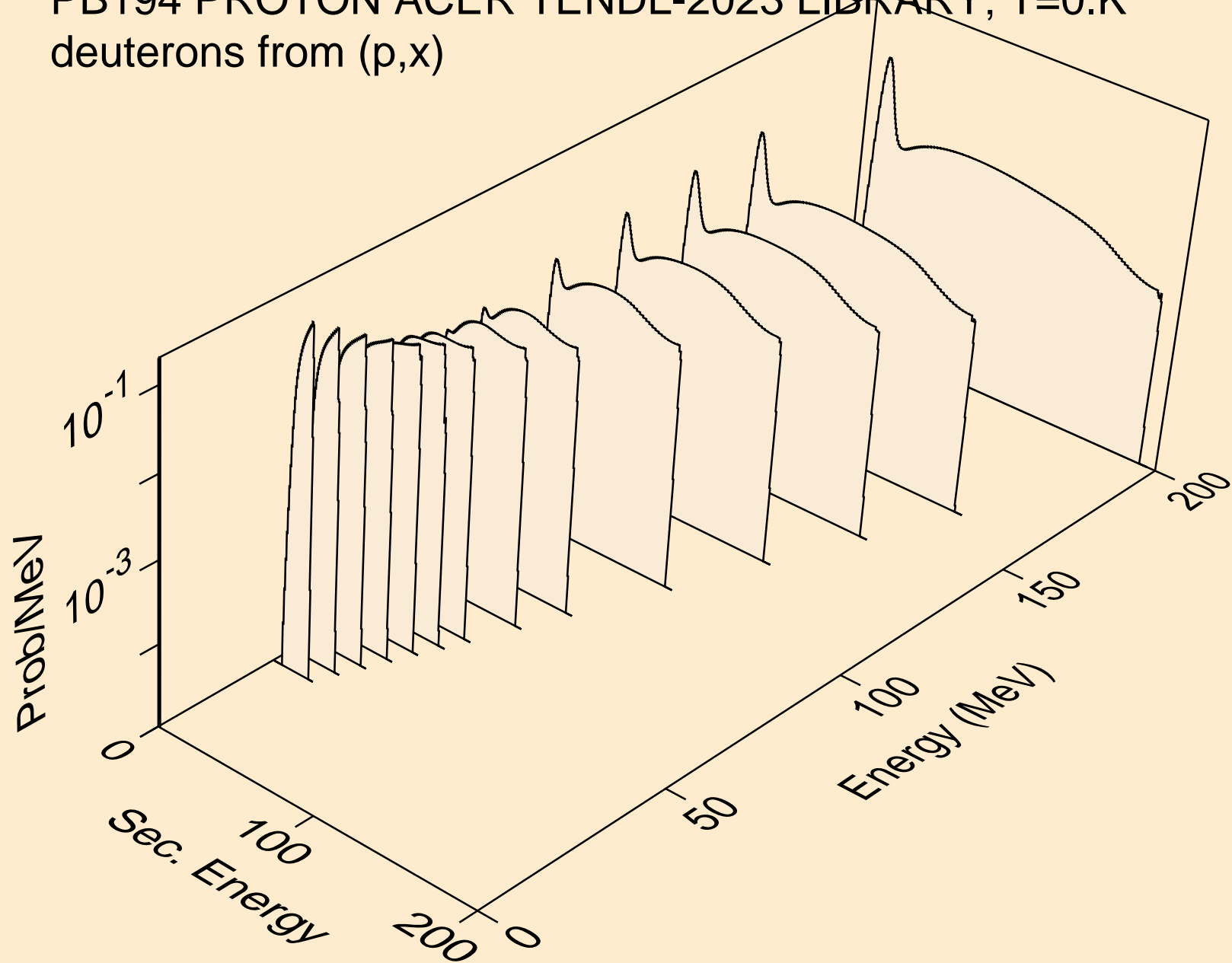

PB194 PROTON ACER TENDL-2023 LIBRARY; T=0.K  
deuterons from (p,n\*)d

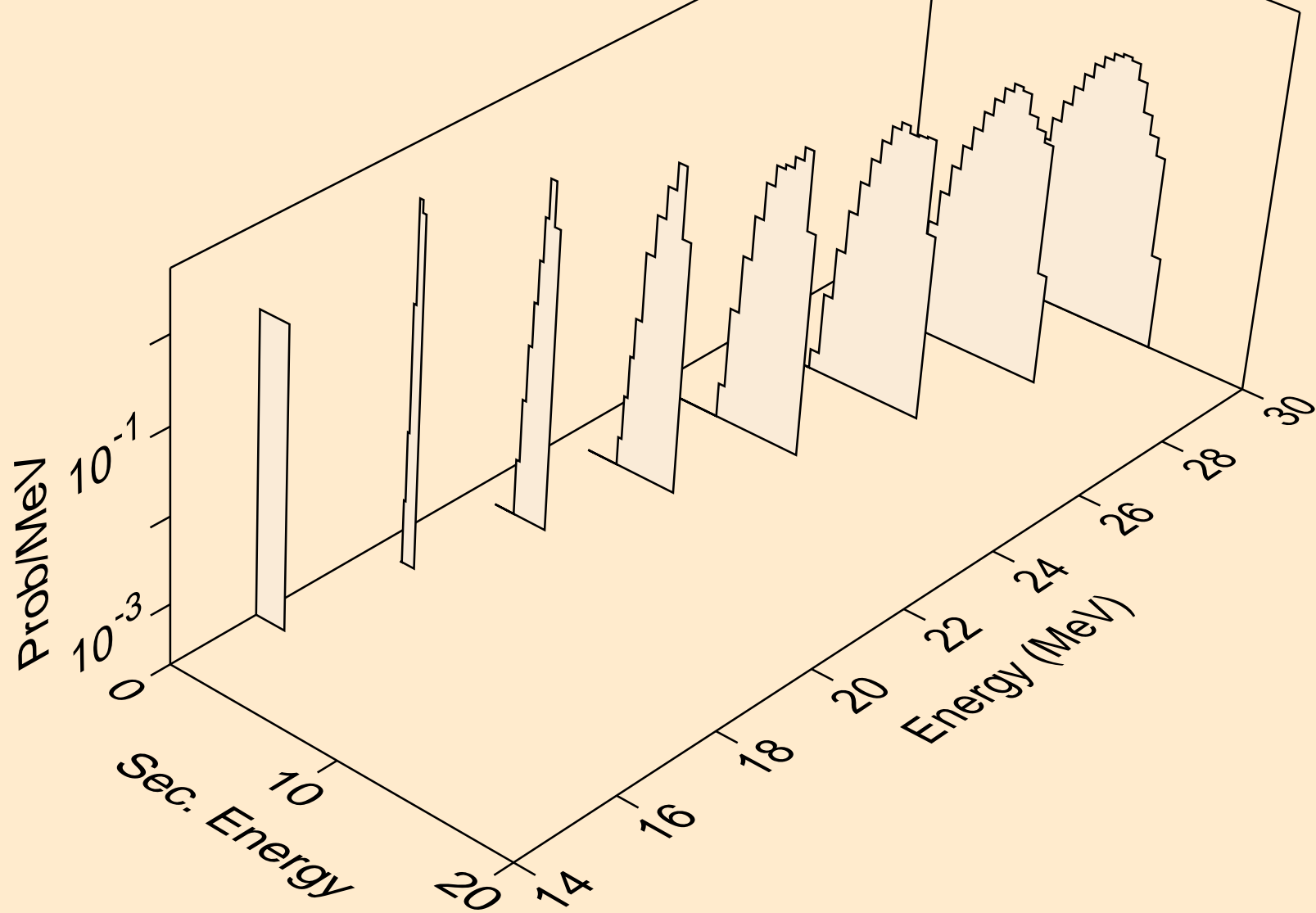



PB194 PROTON ACER TENDL-2023 LIBRARY; T=0.K  
deuterons from (p,d)

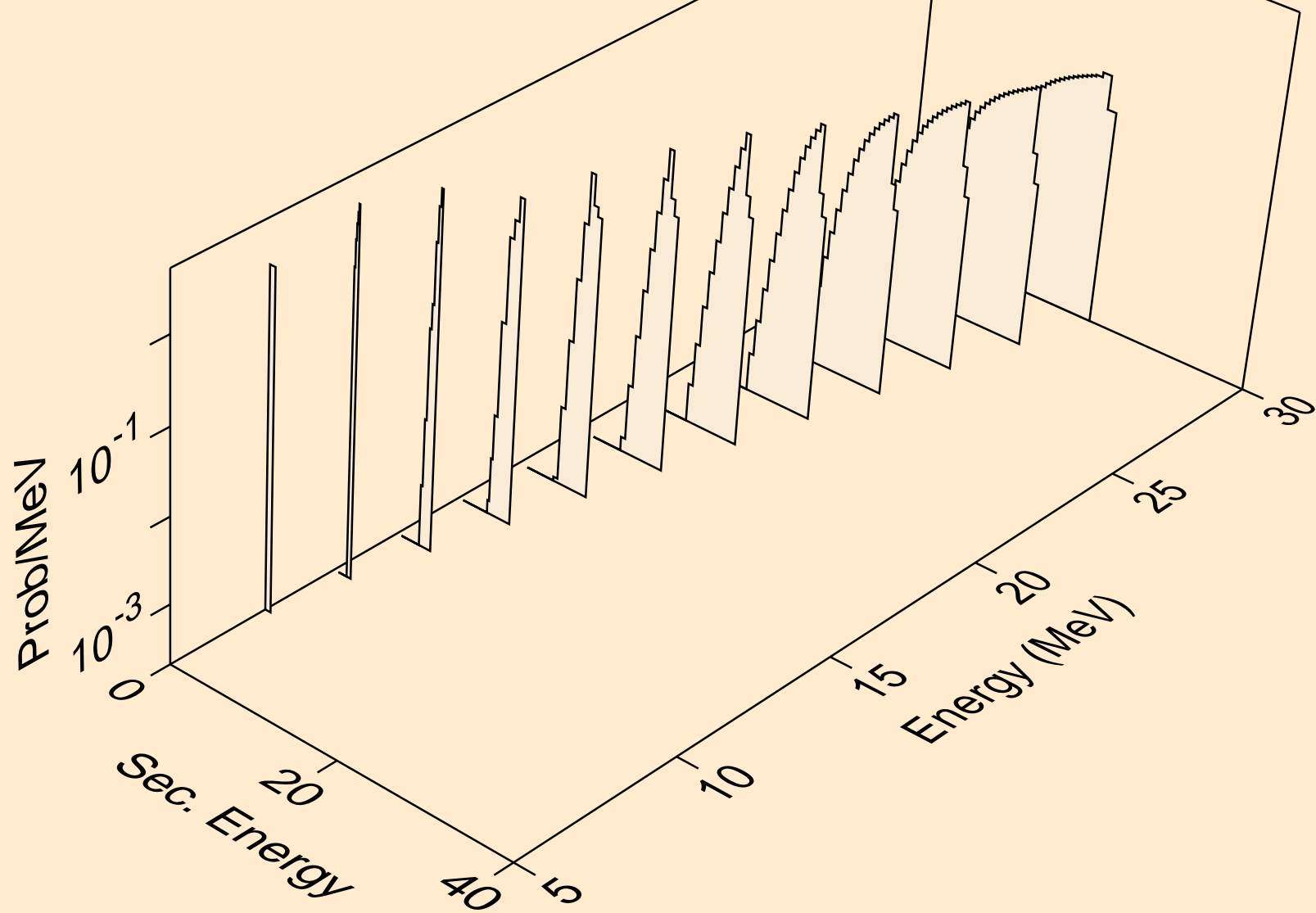

PB194 PROTON ACER TENDL-2023 LIBRARY; T=0.K  
deuterons from (p,pd)

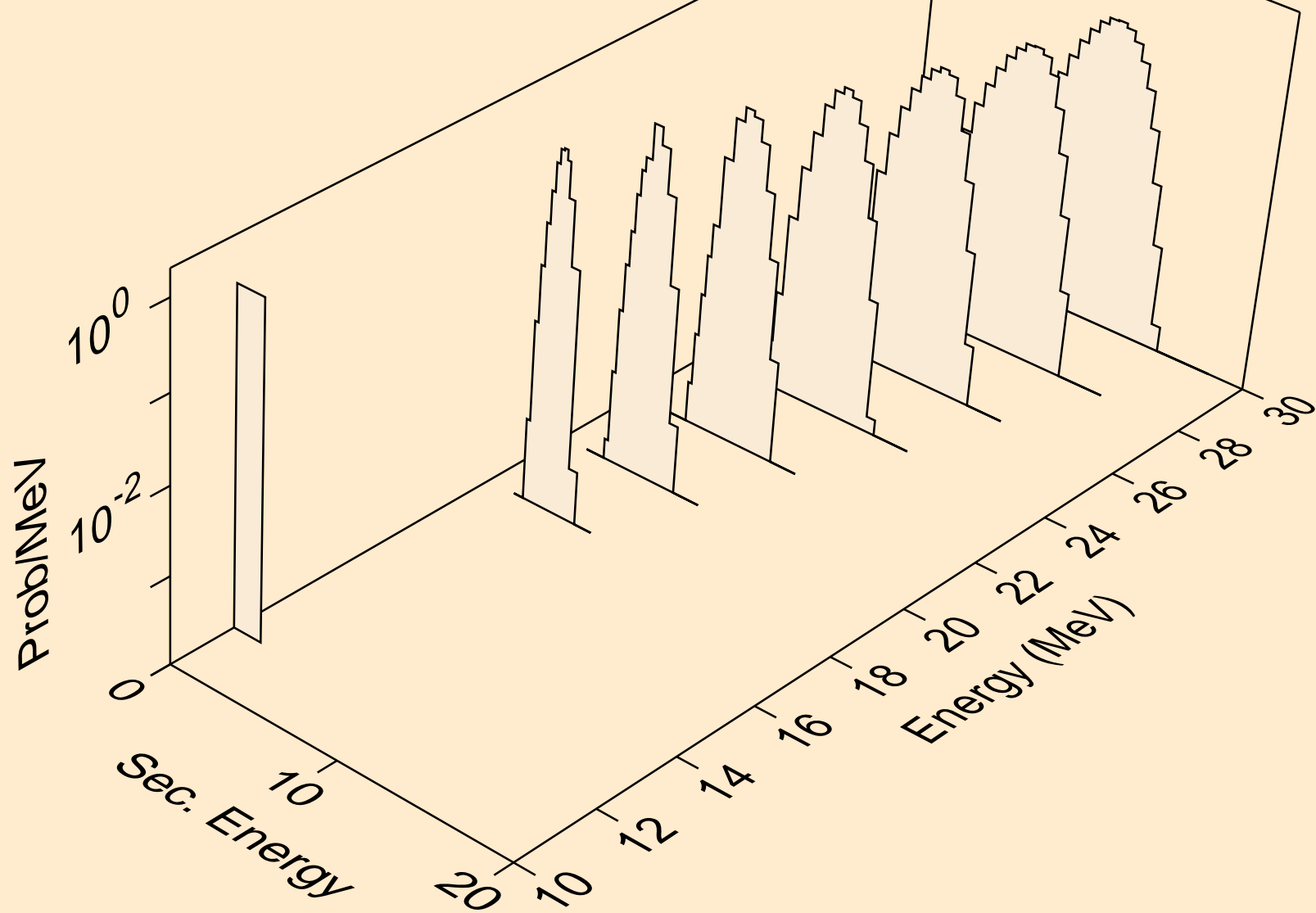

PB194 PROTON ACER TENDL-2023 LIBRARY; T=0.K  
deuterons from (p,da)

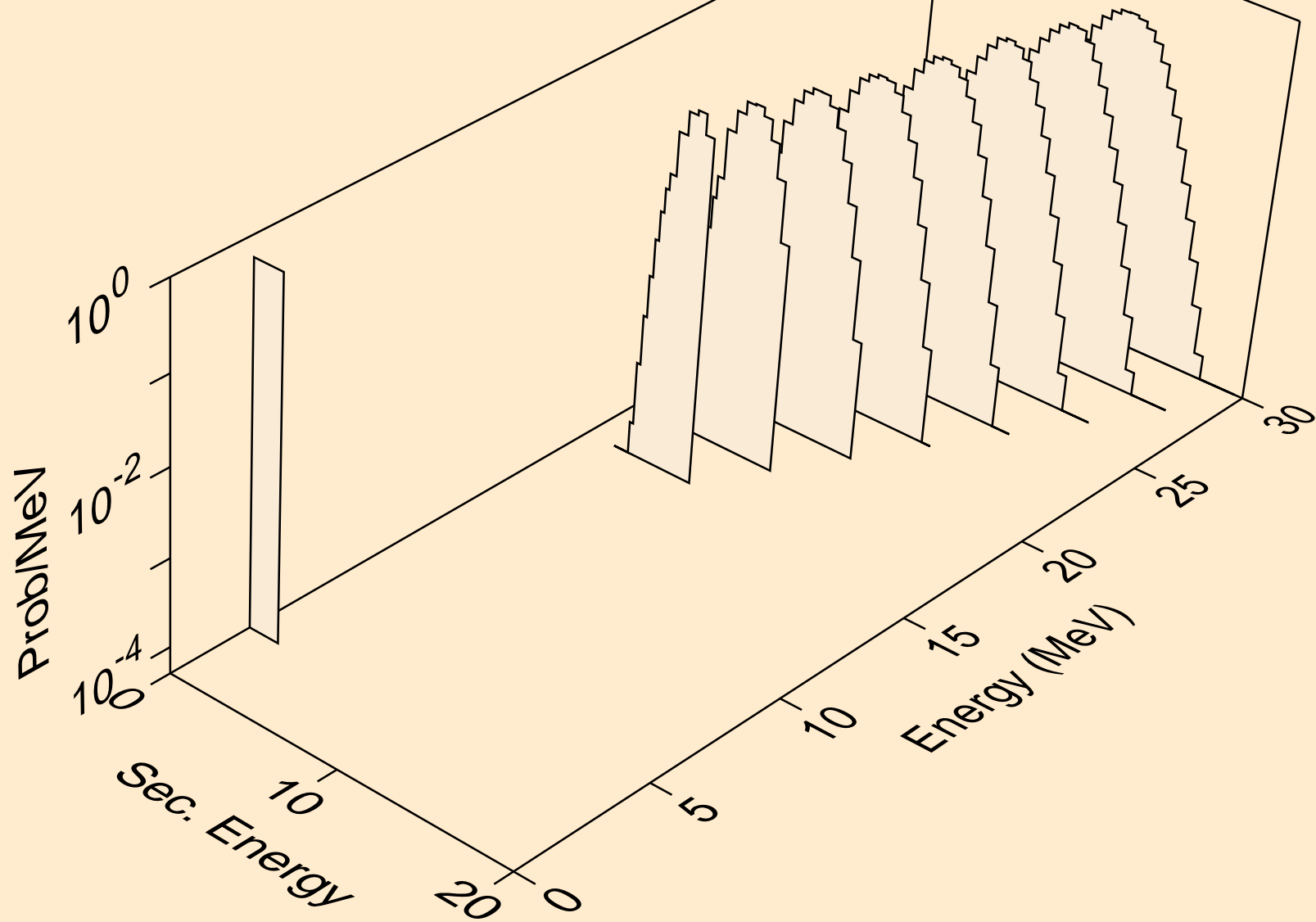

PB194 PROTON ACER TENDL-2023 LIBRARY; T=0.K  
tritons from (p,x)

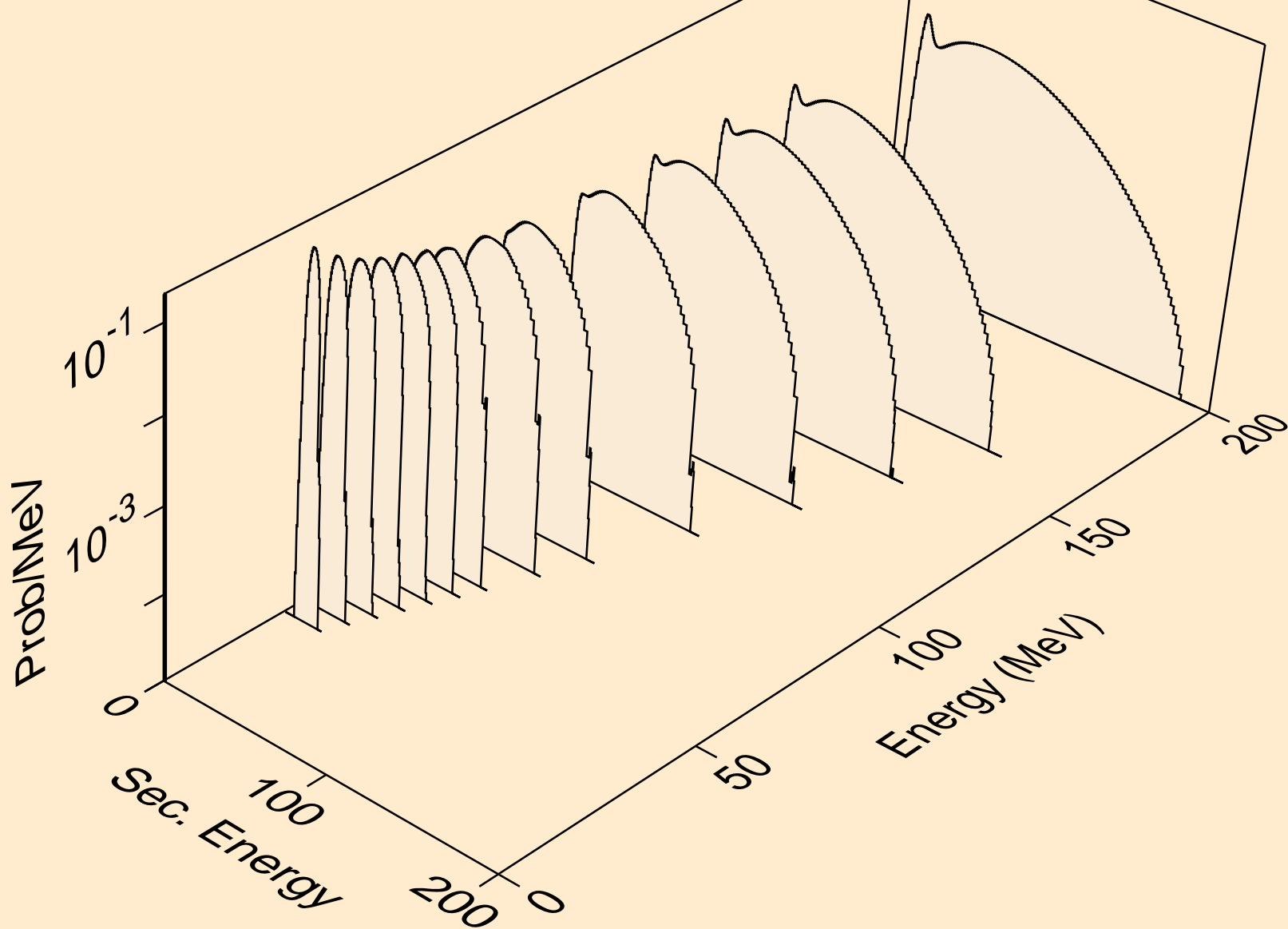

PB194 PROTON ACER TENDL-2023 LIBRARY; T=0.K  
tritons from (p,n\*)t

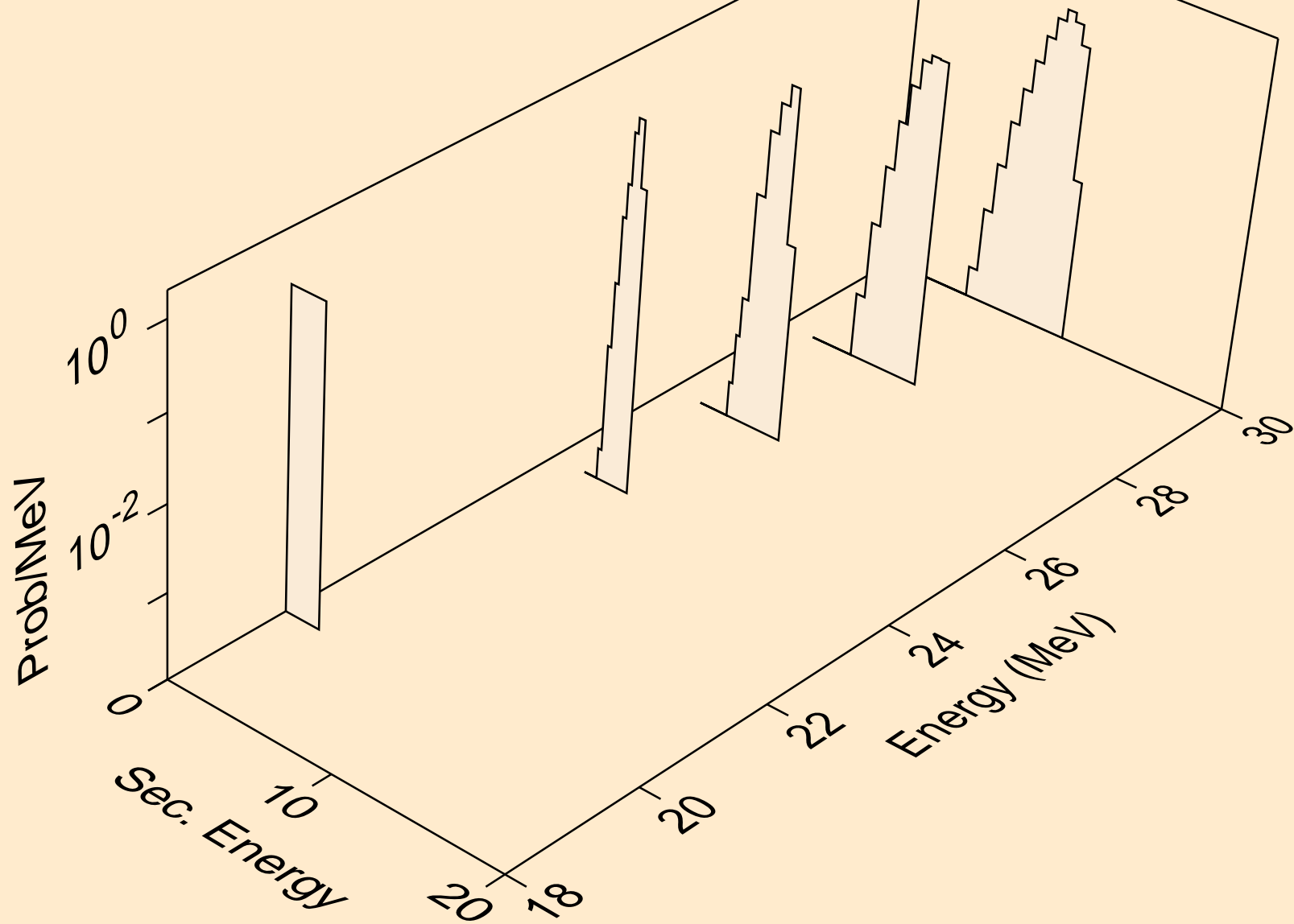

PB194 PROTON ACER TENDL-2023 LIBRARY; T=0.K  
tritons from (p,t)

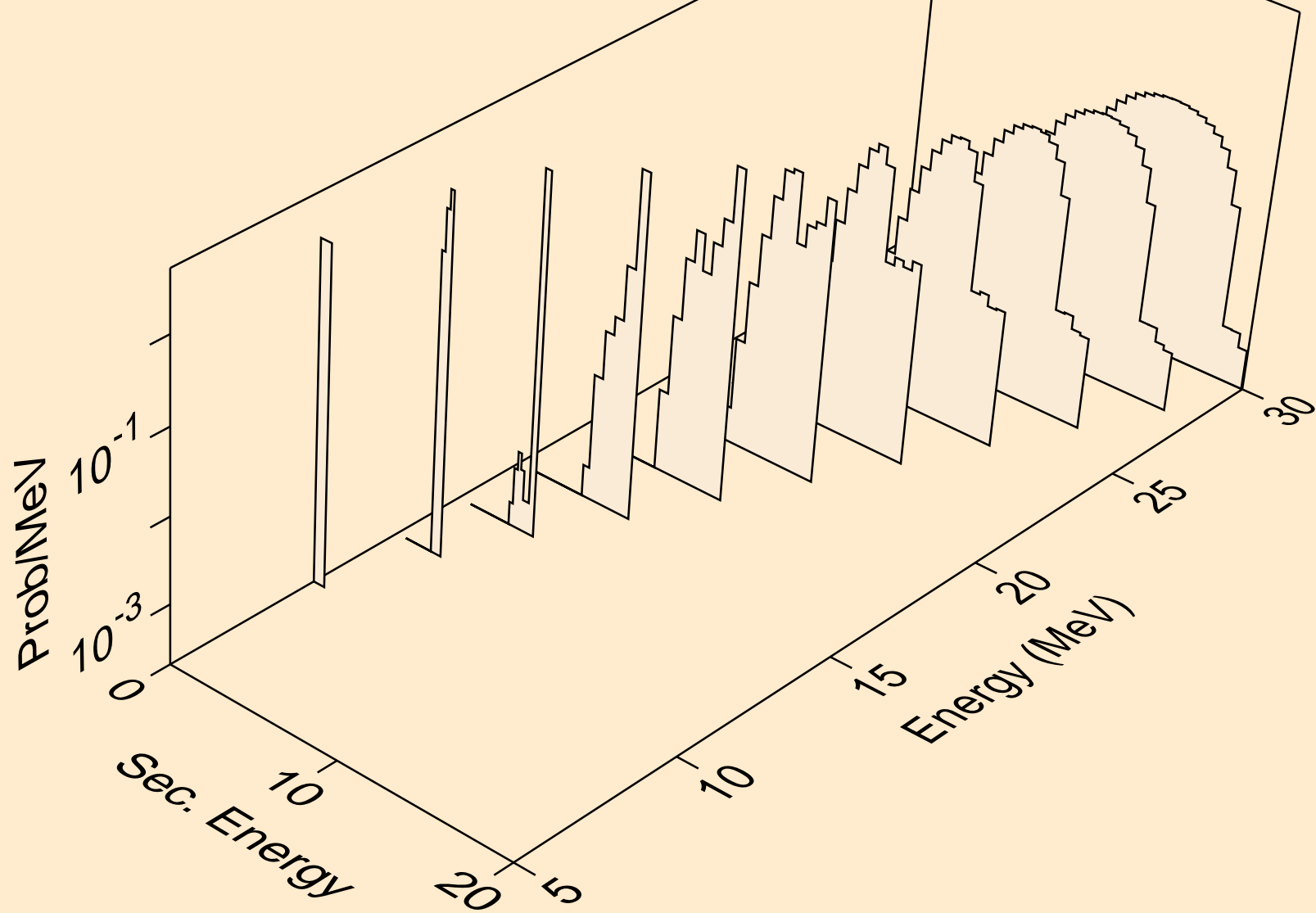

PB194 PROTON ACER TENDL-2023 LIBRARY; T=0.K  
tritons from (p,pt)

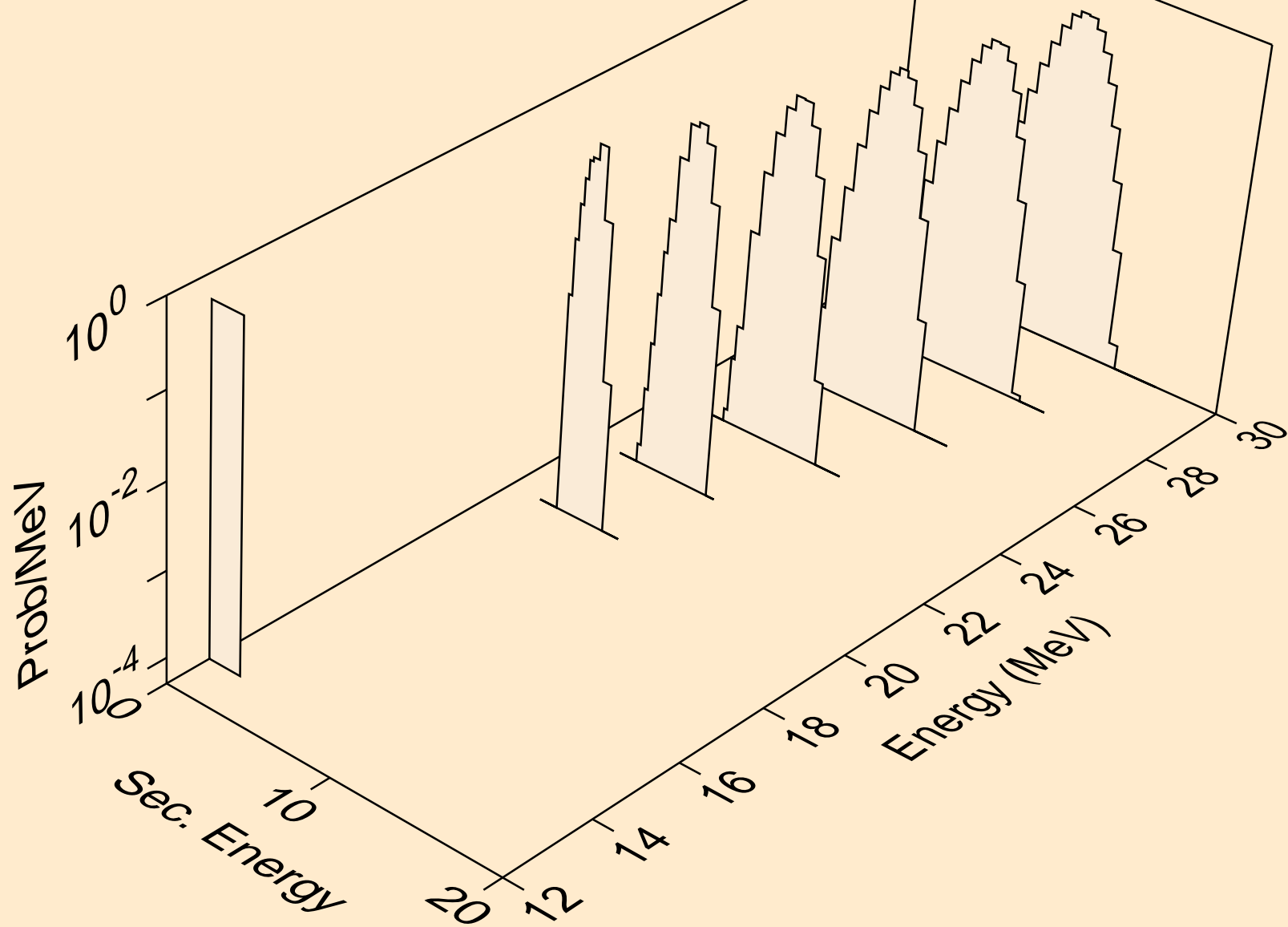

PB194 PROTON ACER TENDL-2023 LIBRARY; T=0.K  
he3s from (p,x)

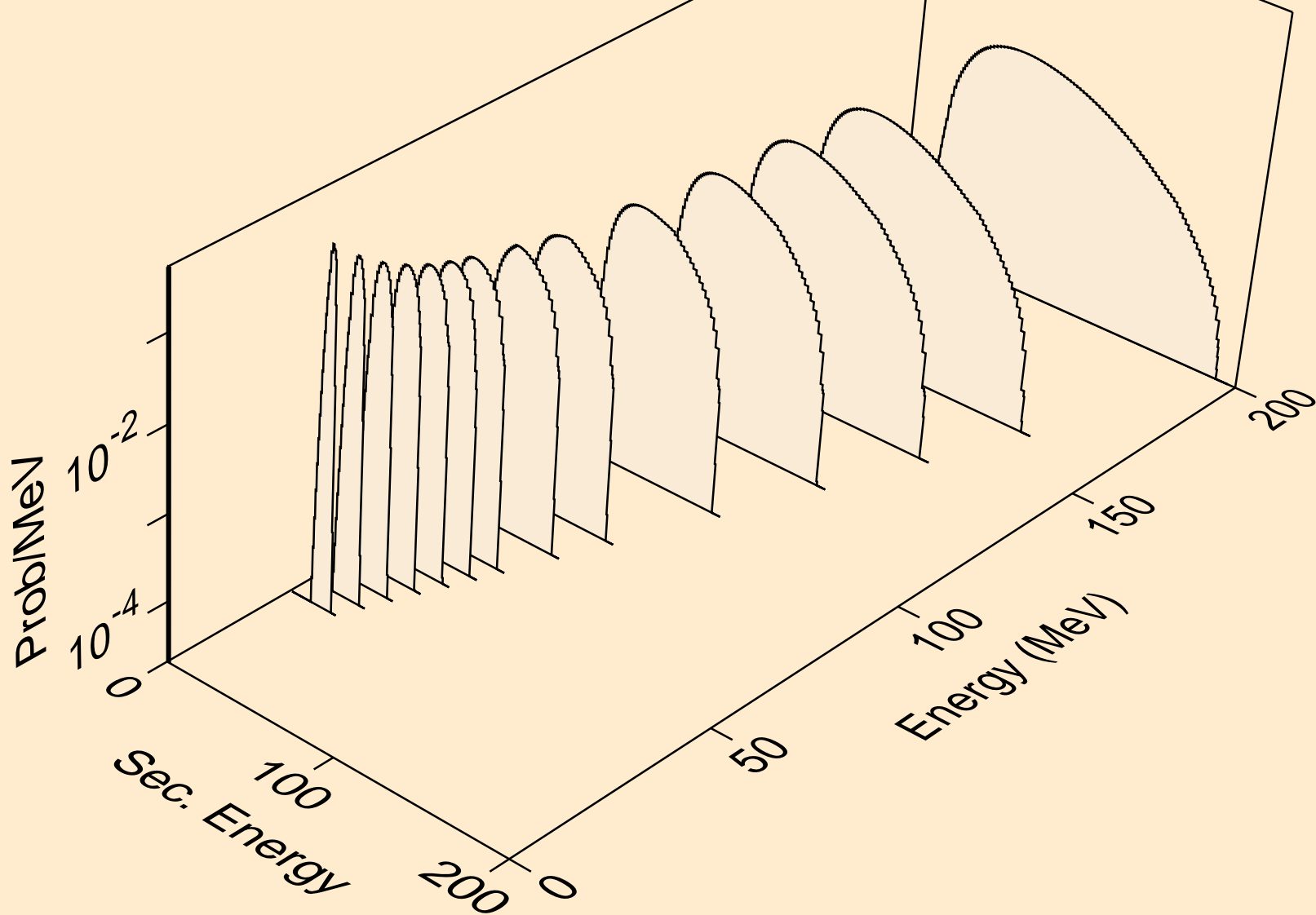



PB194 PROTON ACER TENDL-2023 LIBRARY; T=0.K  
he3s from (p,n\*)he3

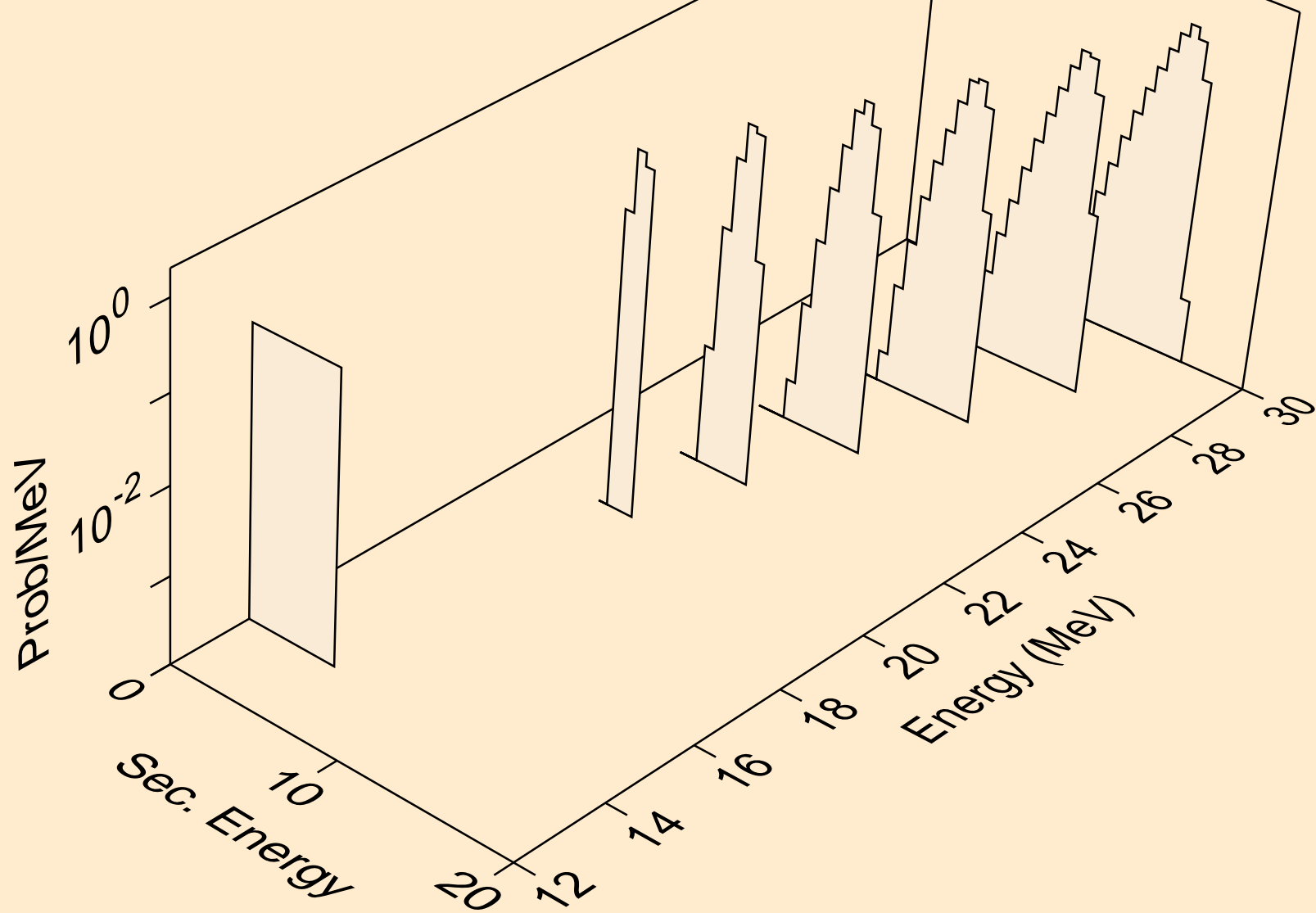

PB194 PROTON ACER TENDL-2023 LIBRARY; T=0.K  
he3s from (p,he3)

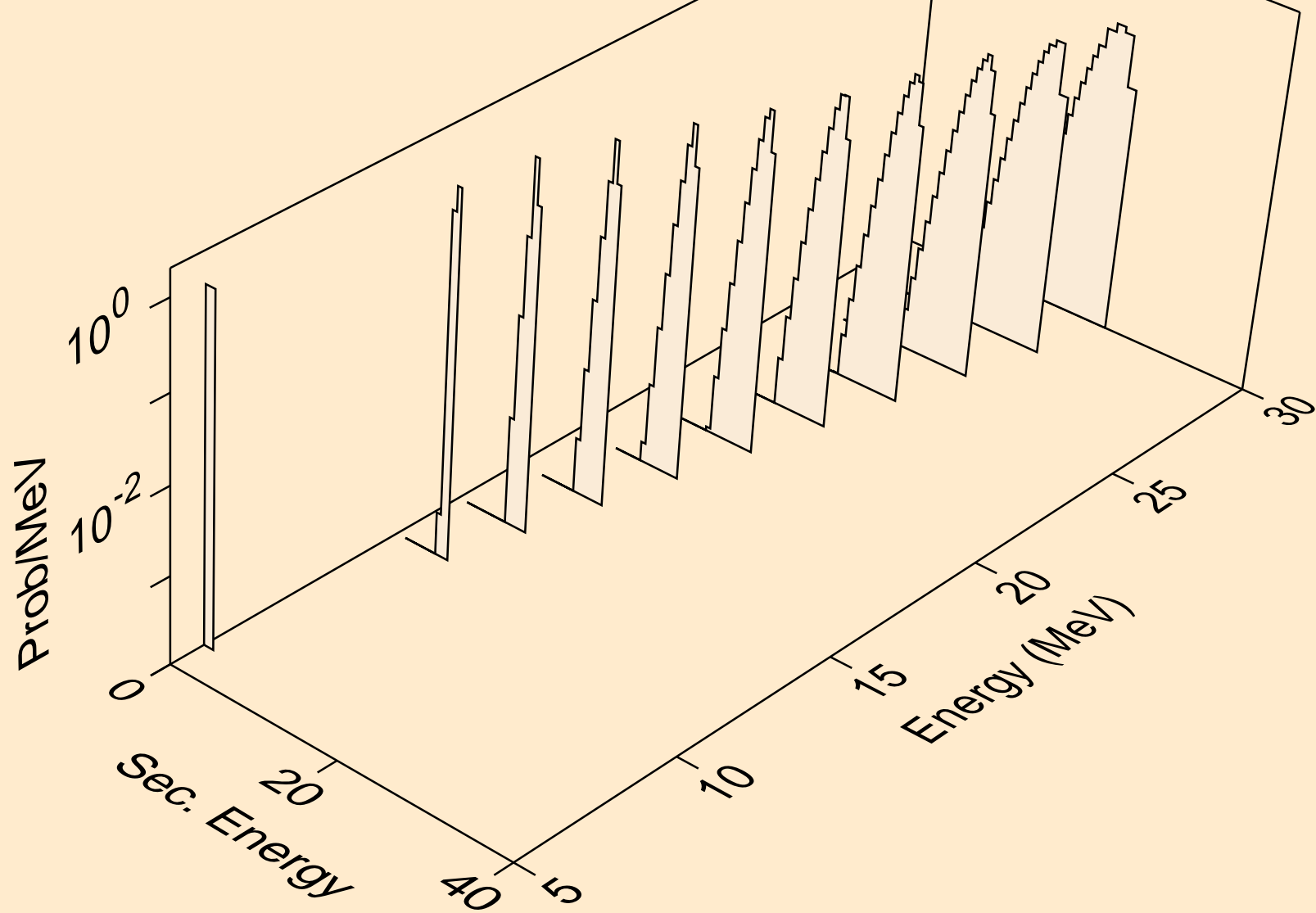

PB194 PROTON ACER TENDL-2023 LIBRARY; T=0.K  
alphas from (p,x)

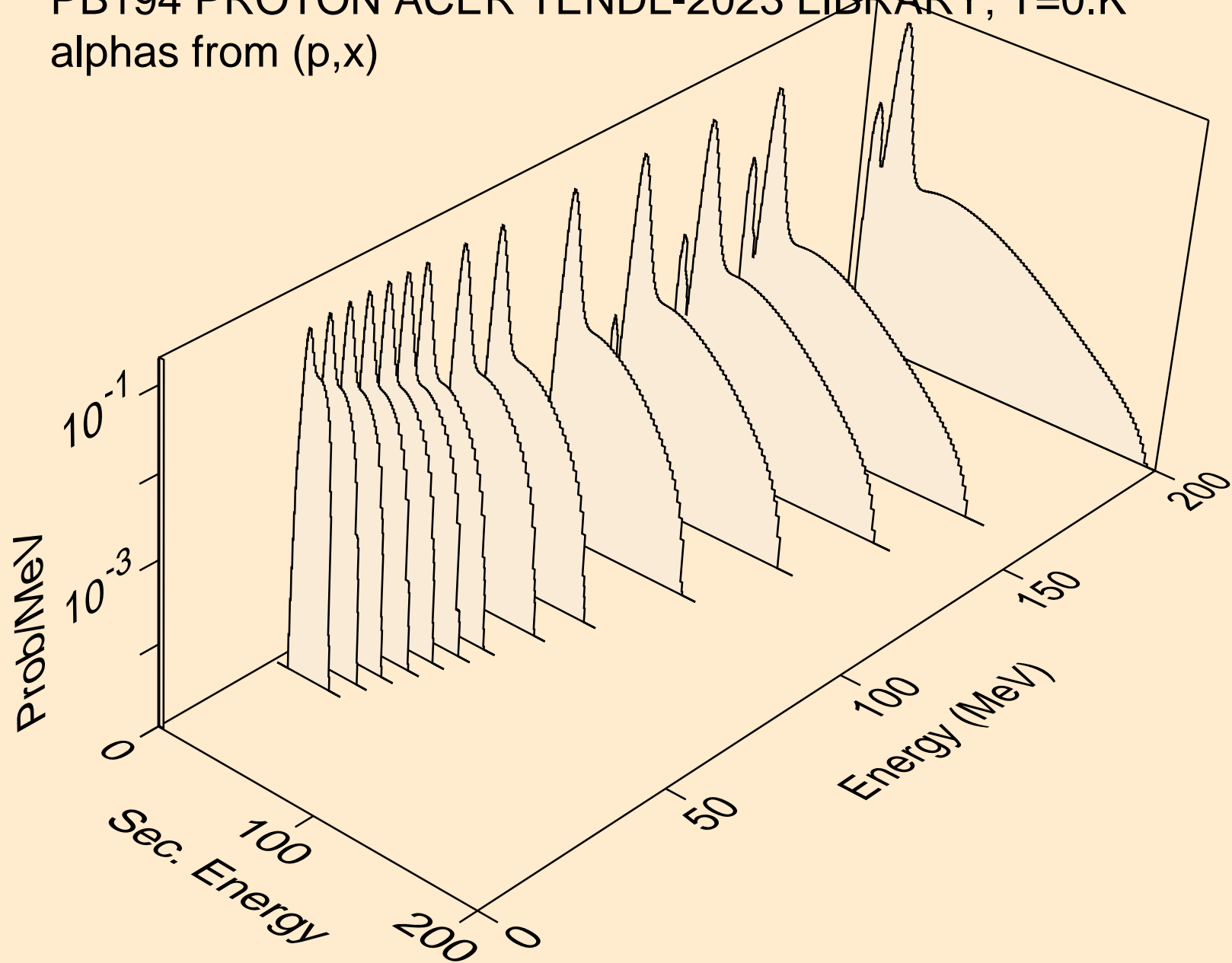

PB194 PROTON ACER TENDL-2023 LIBRARY; T=0.K  
alphas from (p,n\*)a

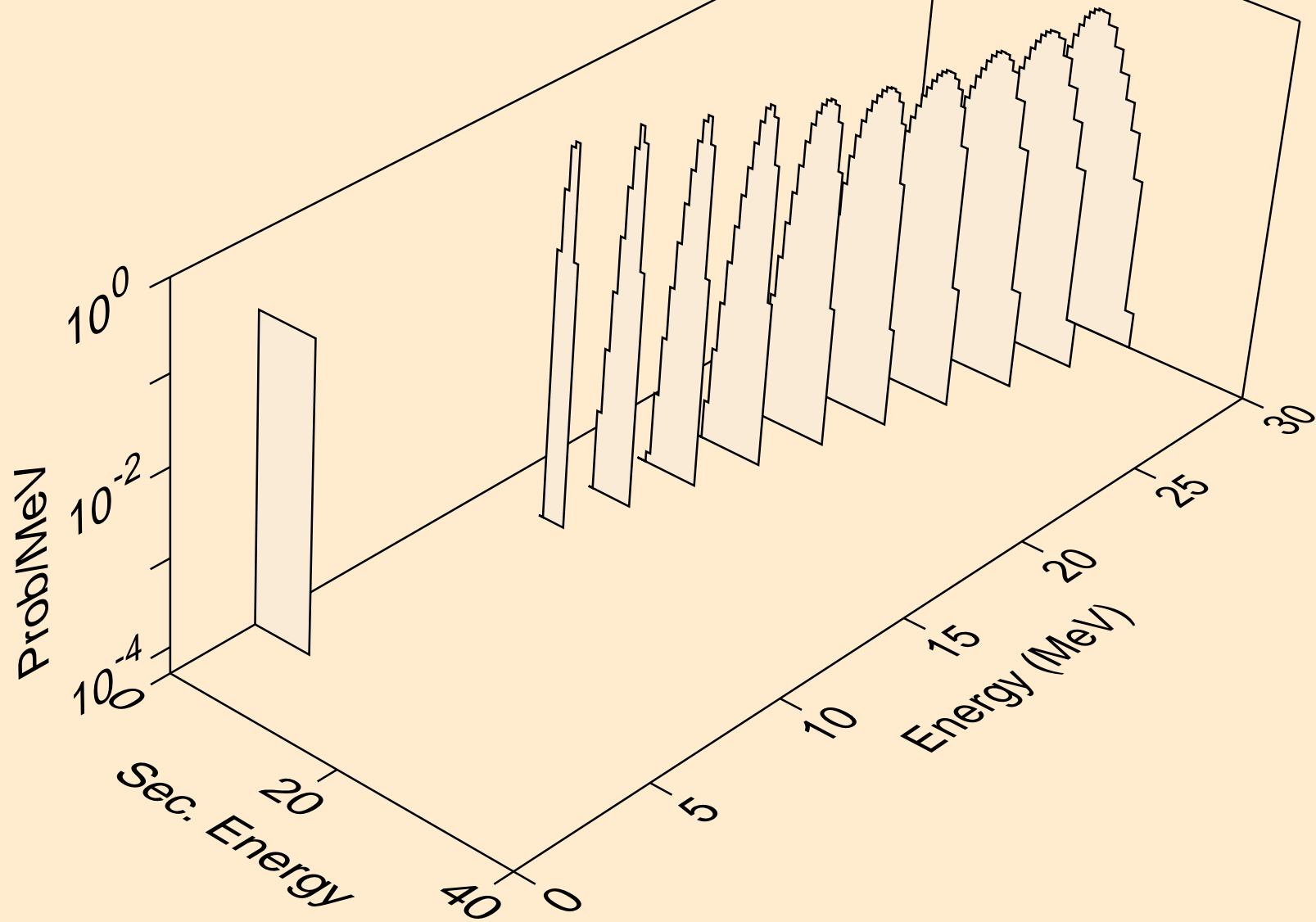

PB194 PROTON ACER TENDL-2023 LIBRARY; T=0.K  
alphas from (p,2n)a

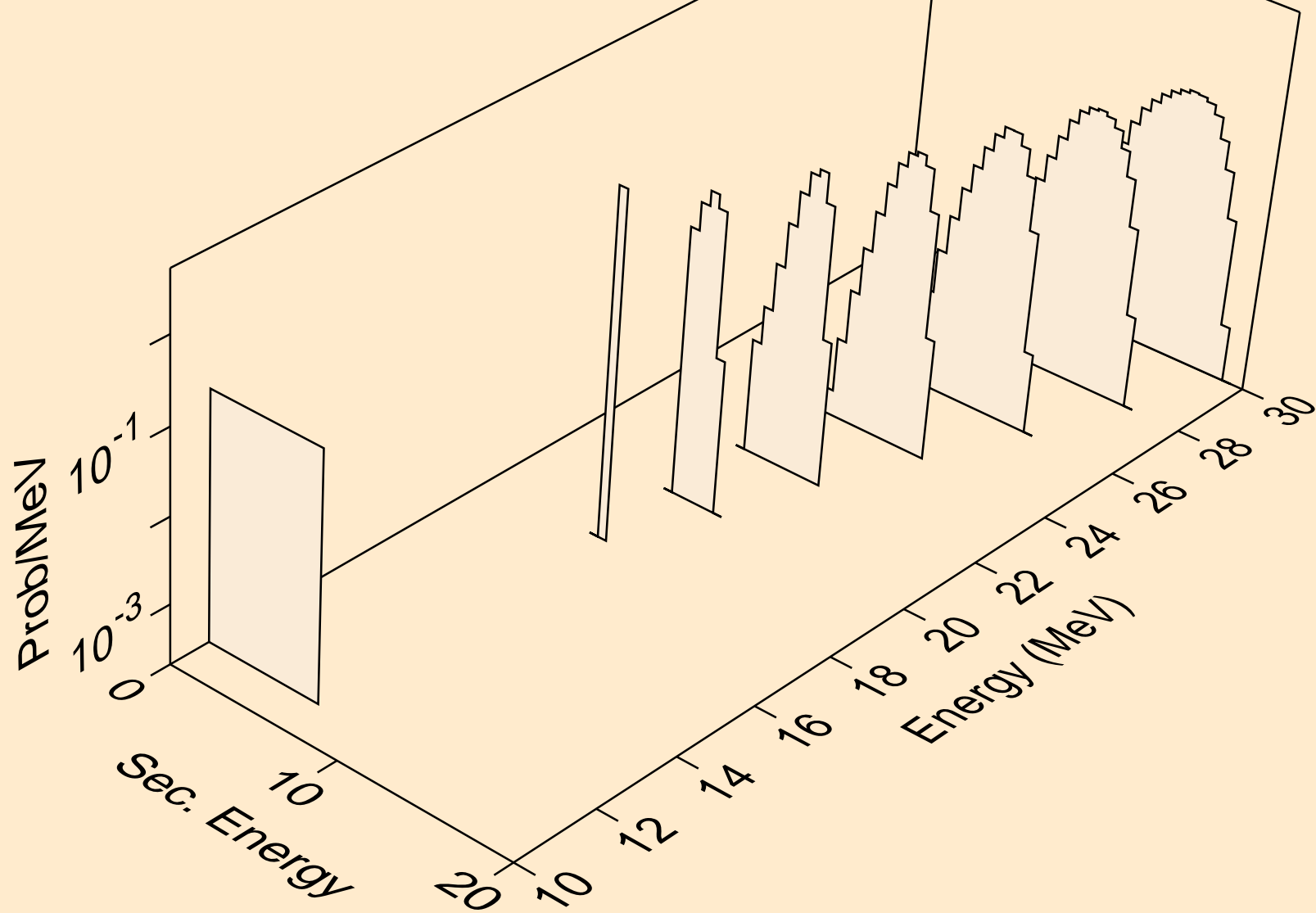

PB194 PROTON ACER TENDL-2023 LIBRARY; T=0.K  
alphas from (p,n\*)2a

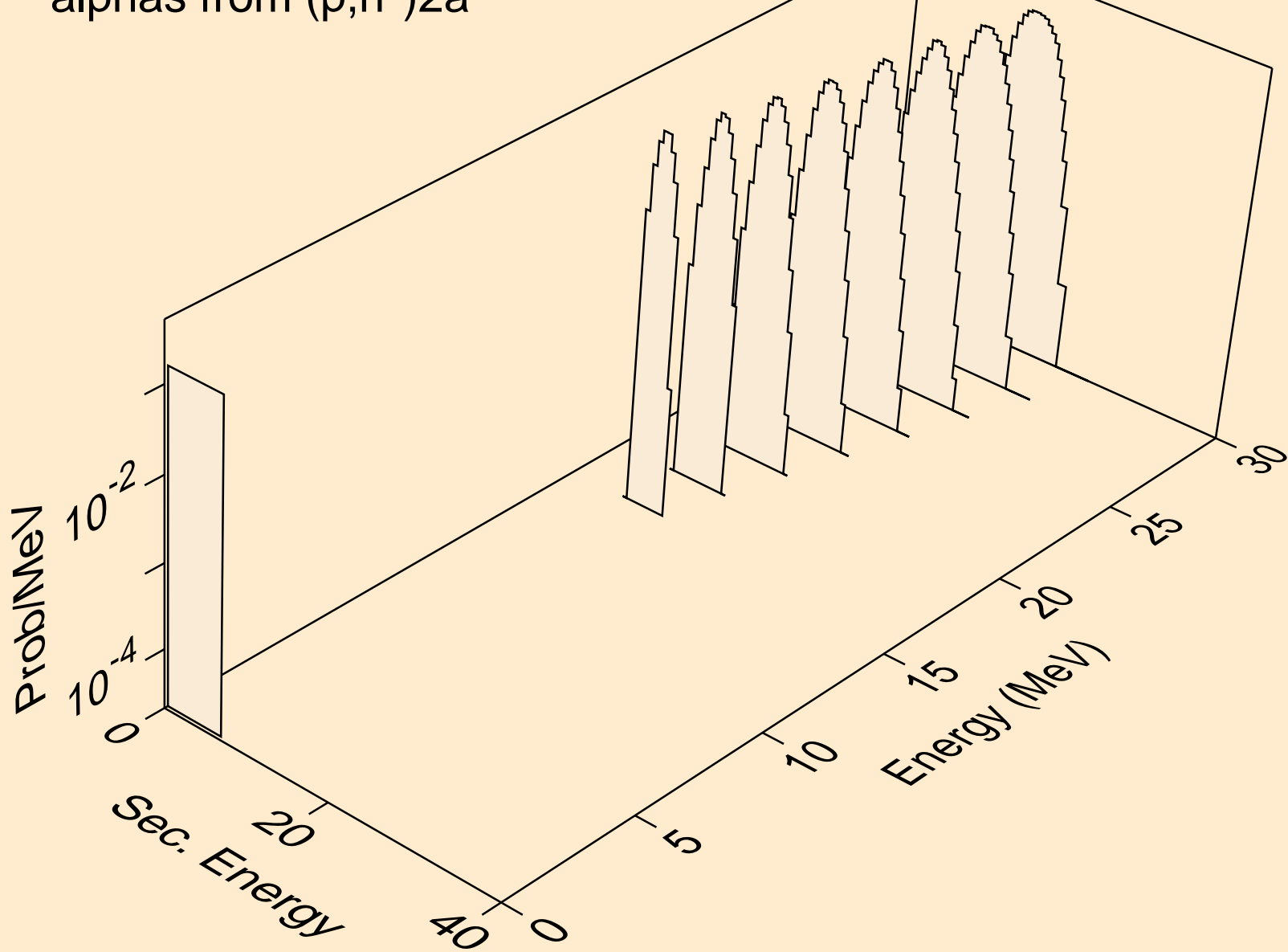

PB194 PROTON ACER TENDL-2023 LIBRARY; T=0.K  
alphas from (p,npa)

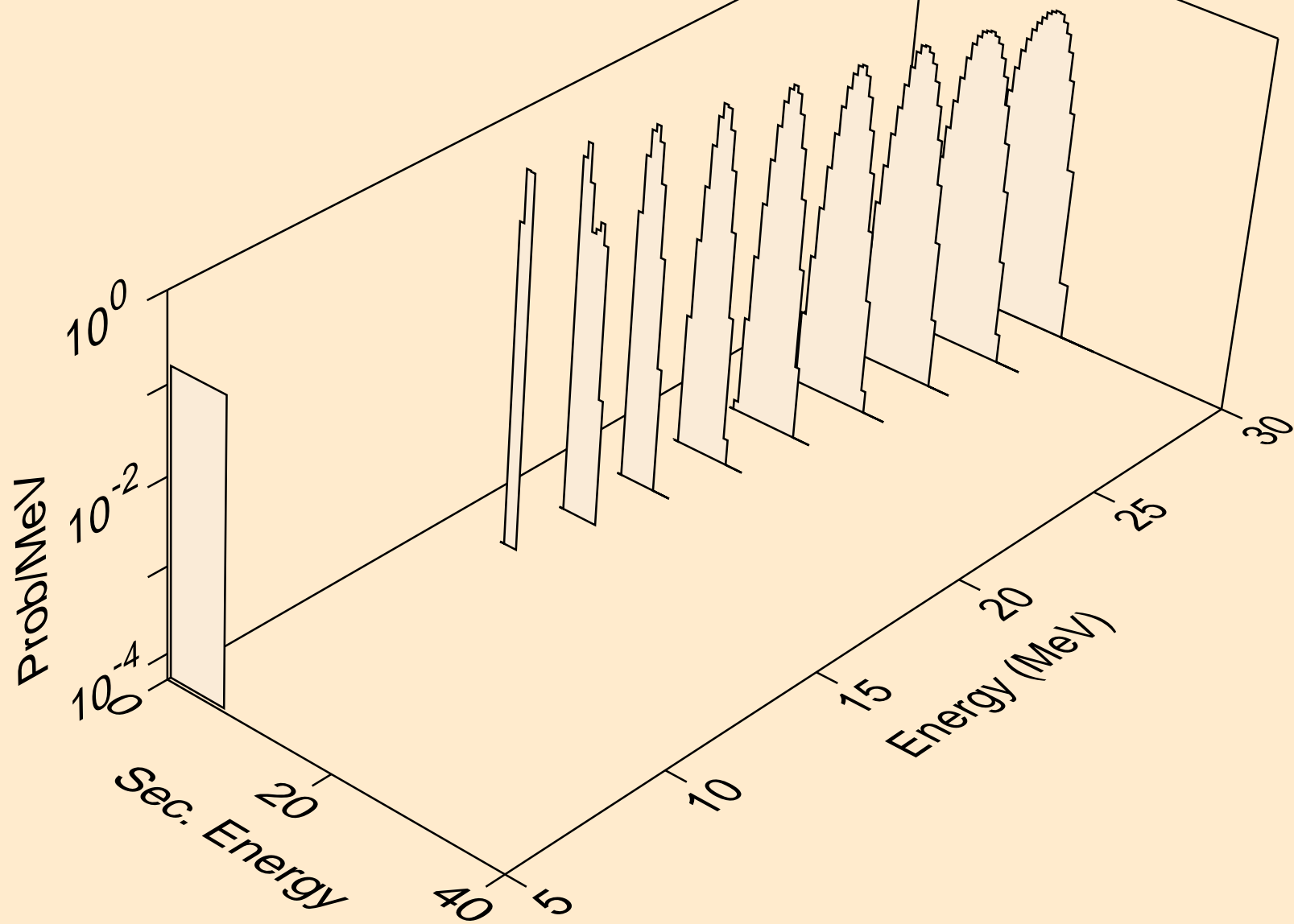

PB194 PROTON ACER TENDL-2023 LIBRARY; T=0.K  
alphas from (p,a)

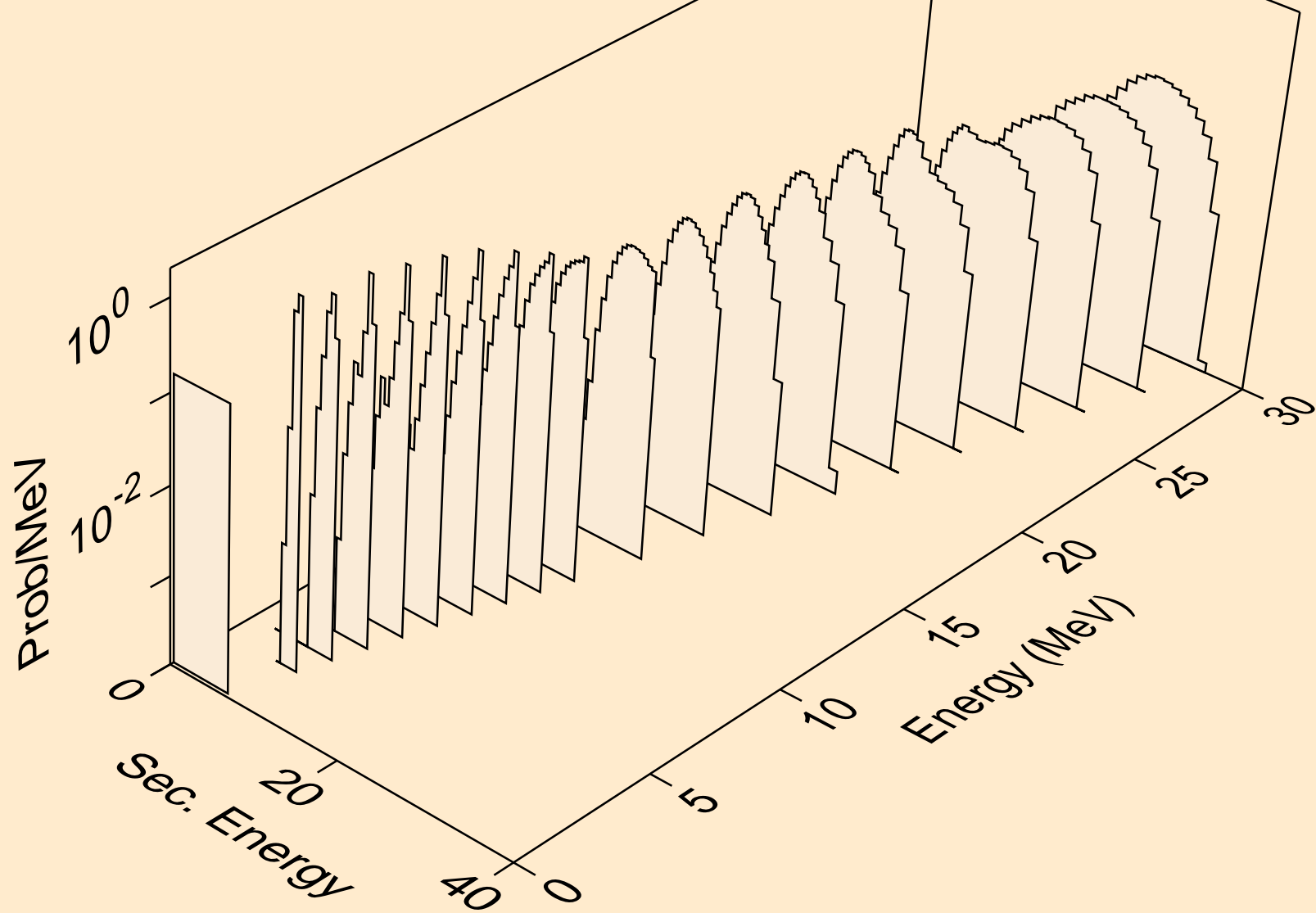



PB194 PROTON ACER TENDL-2023 LIBRARY; T=0.K  
alphas from (p,2a)

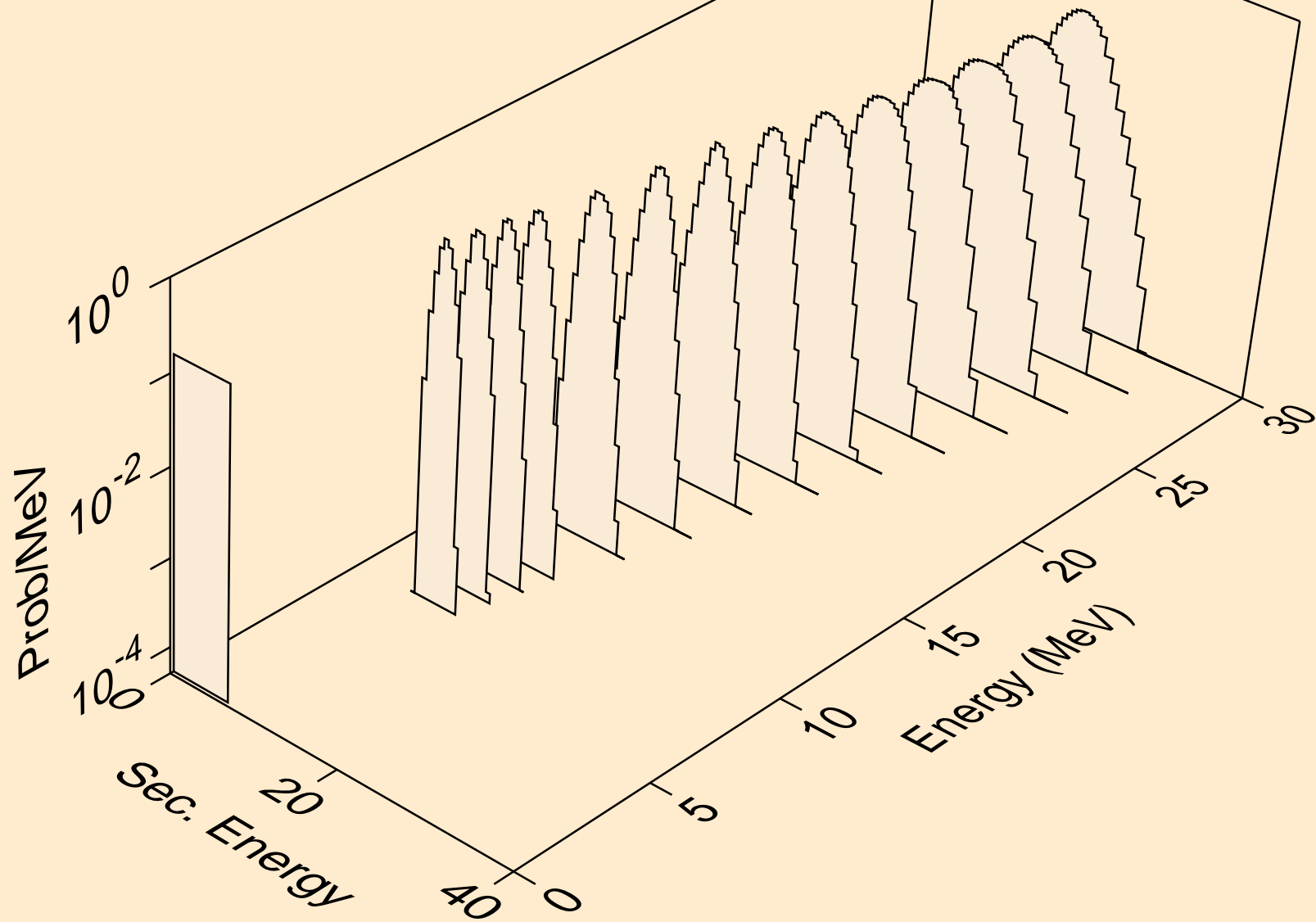

PB194 PROTON ACER TENDL-2023 LIBRARY; T=0.K  
alphas from (p,pa)

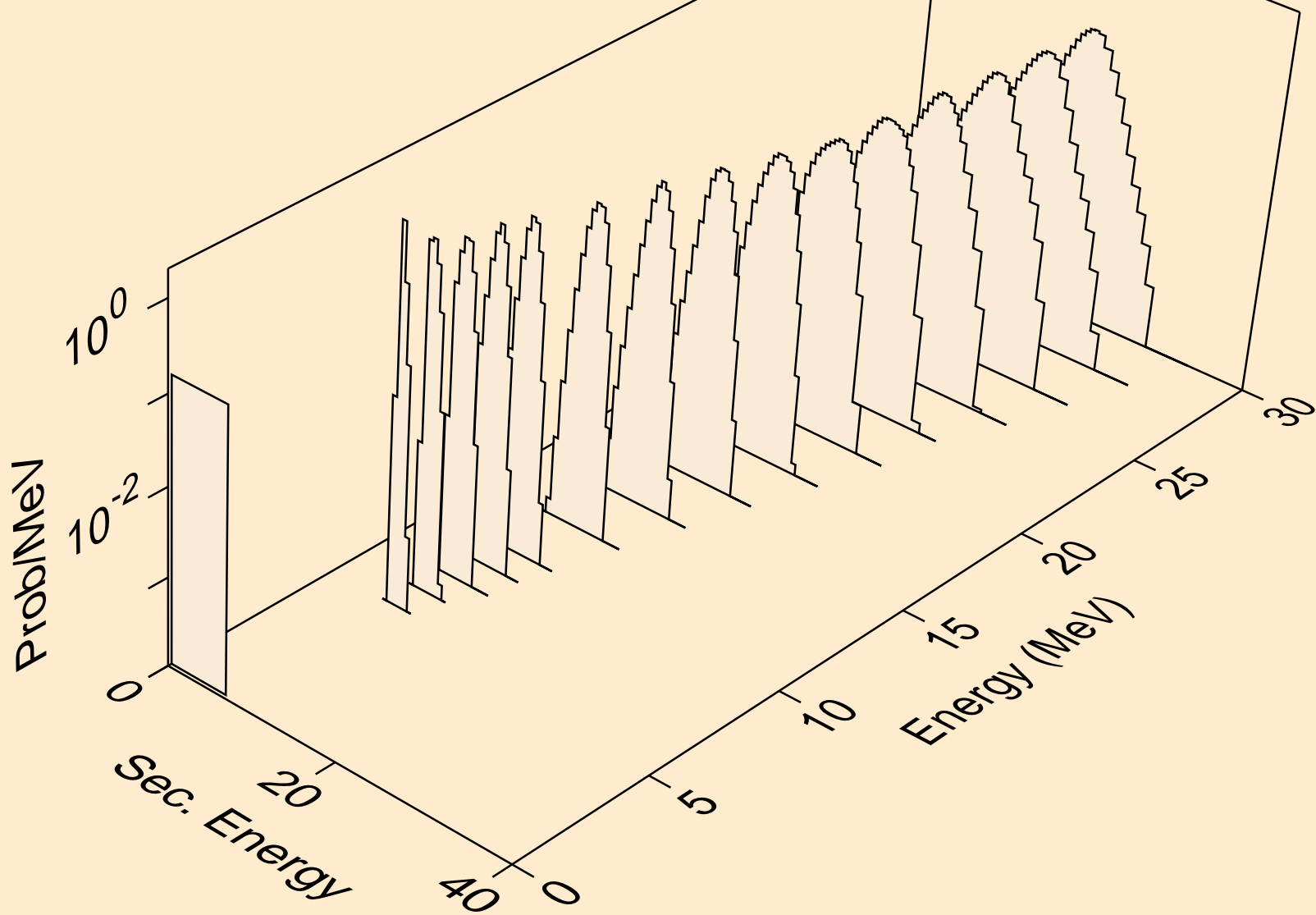

PB194 PROTON ACER TENDL-2023 LIBRARY; T=0.K  
alphas from (p,da)

