

RF257M PROTON ACER TENDL-2023 LIBRARY; T=0.K  
Principal cross sections

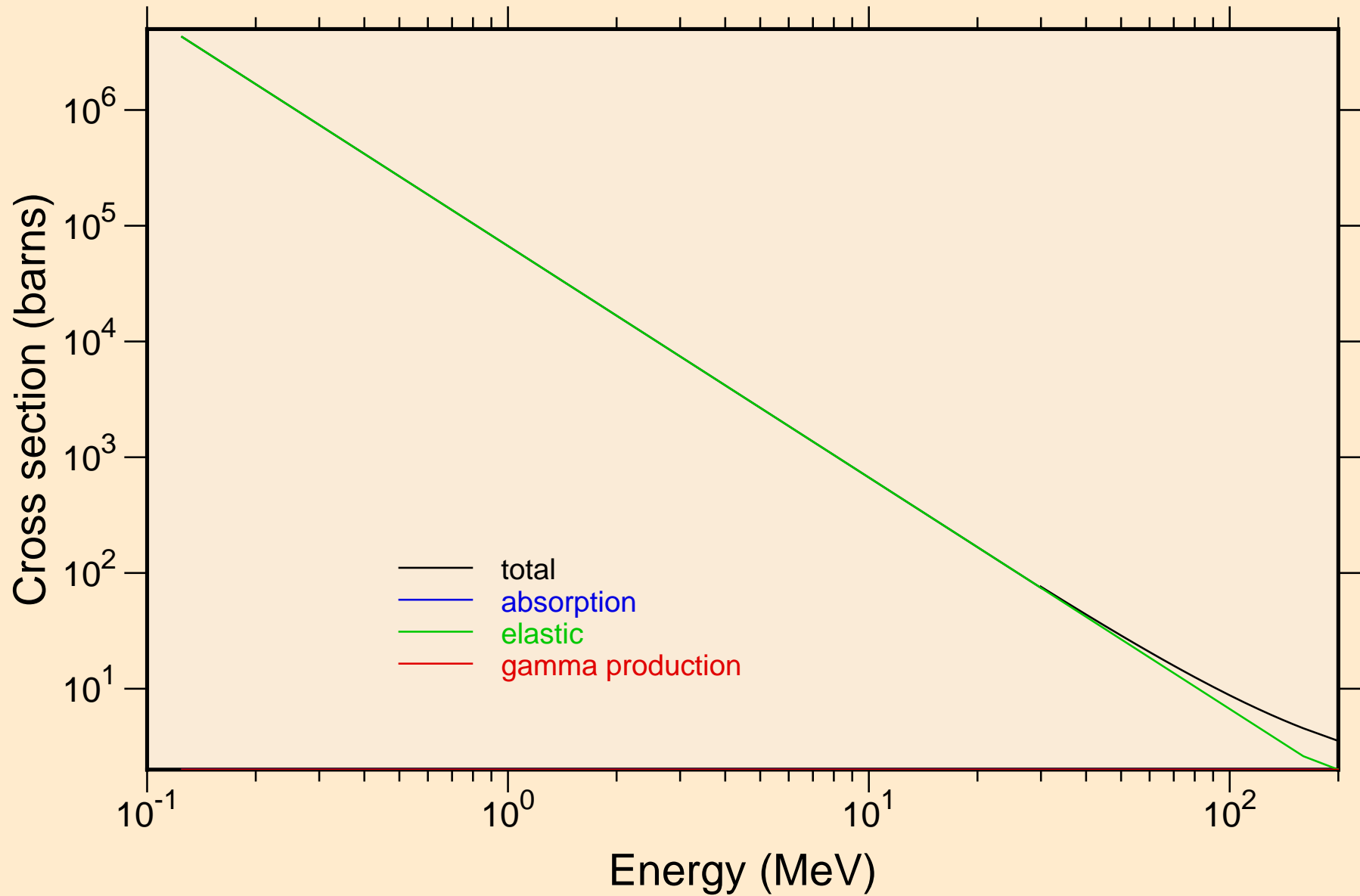

# RF257M PROTON ACER TENDL-2023 LIBRARY; T=0.K

## Heating

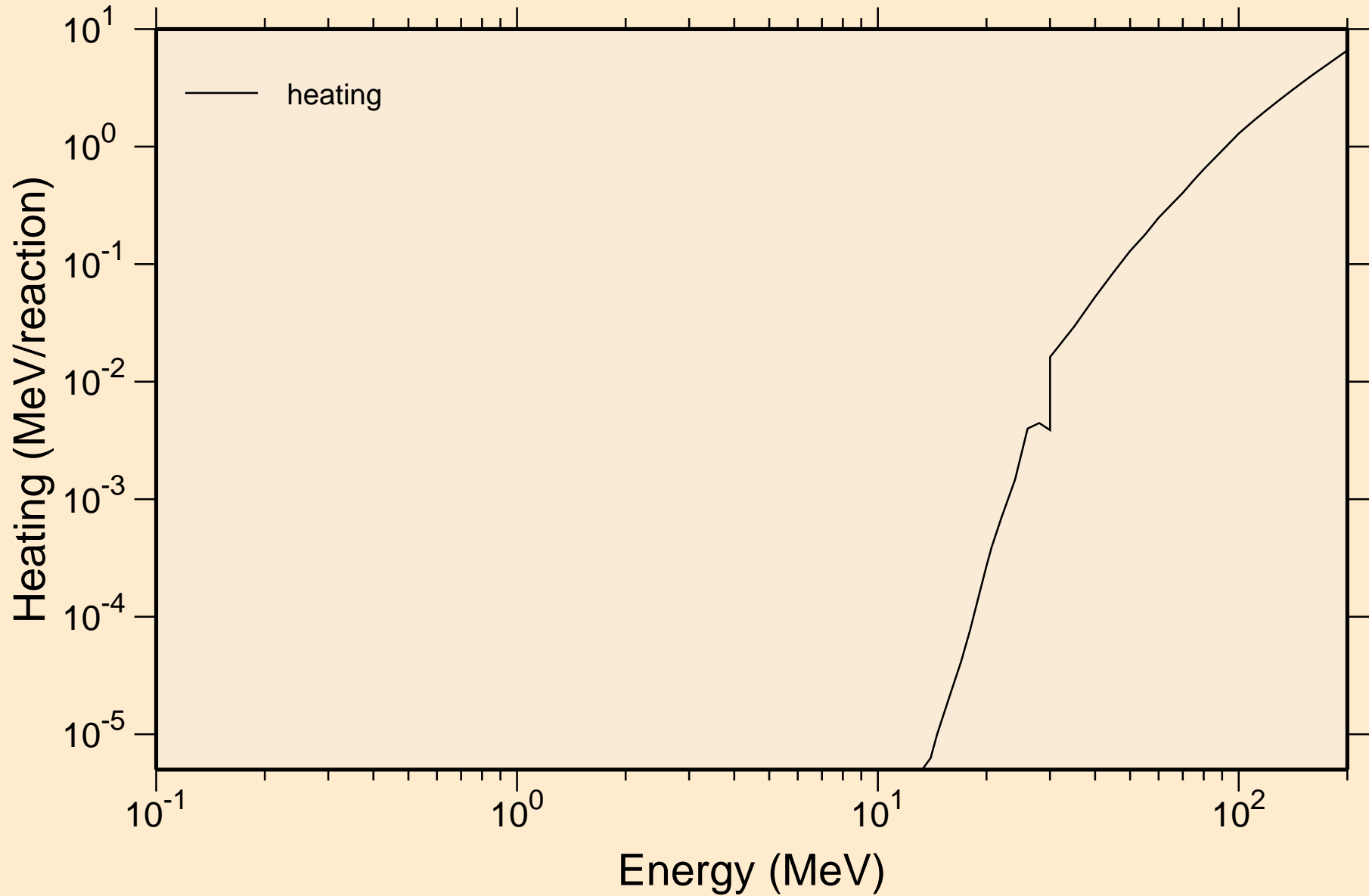

# RF257M PROTON ACER TENDL-2023 LIBRARY; T=0.K

## Principal cross sections

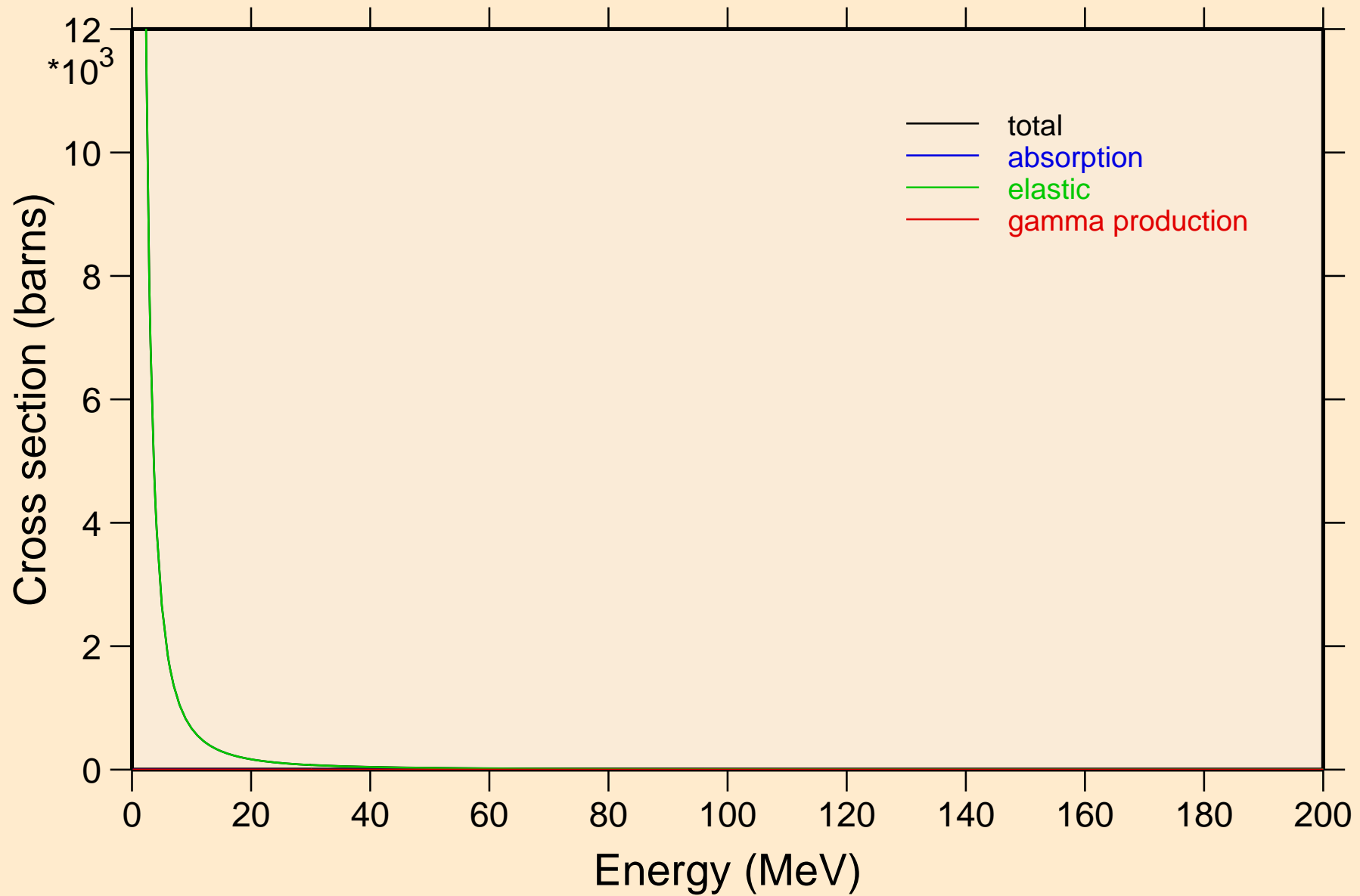

# RF257M PROTON ACER TENDL-2023 LIBRARY; T=0.K

## Heating

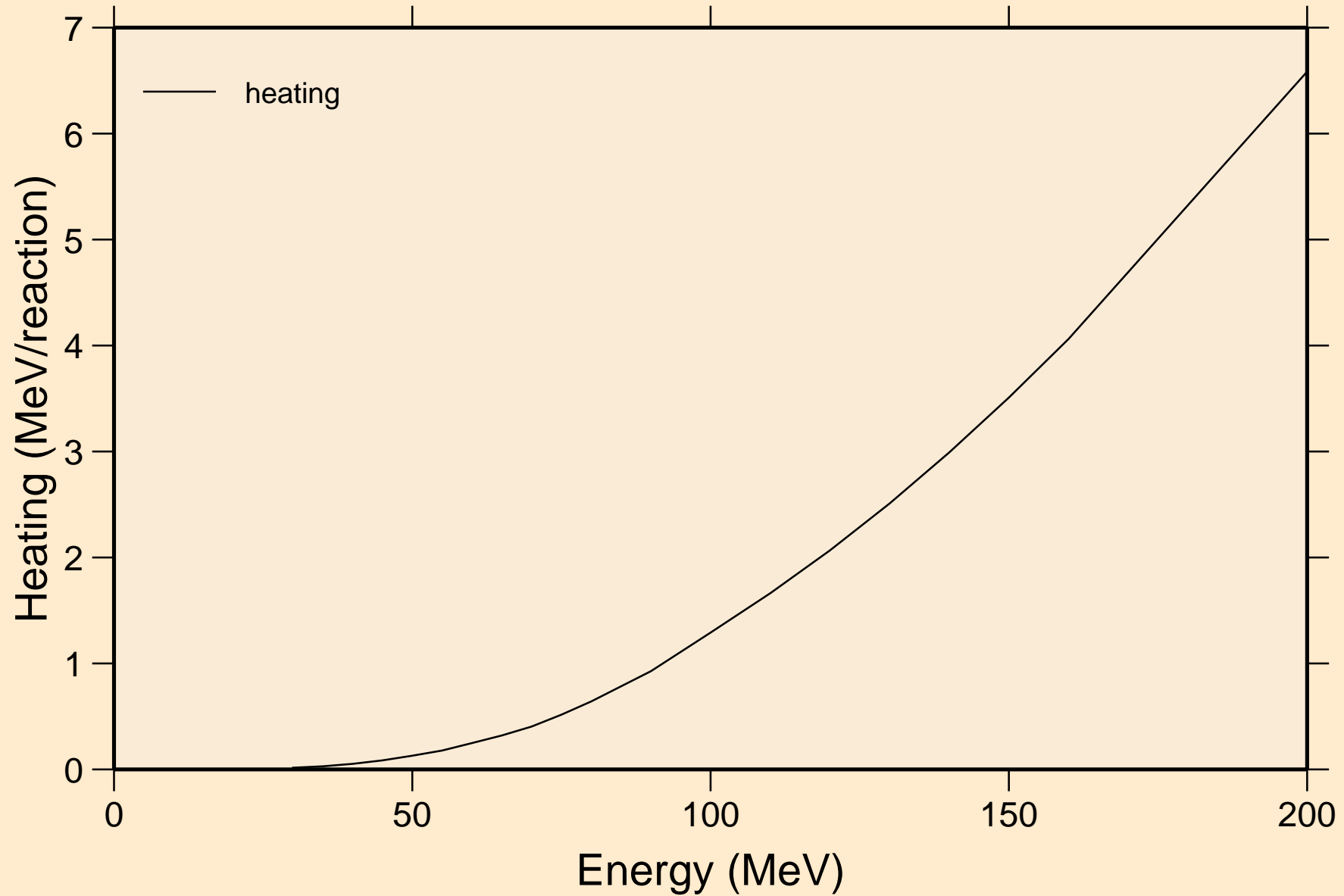

RF257M PROTON ACER TENDL-2023 LIBRARY; T=0.K  
Threshold reactions

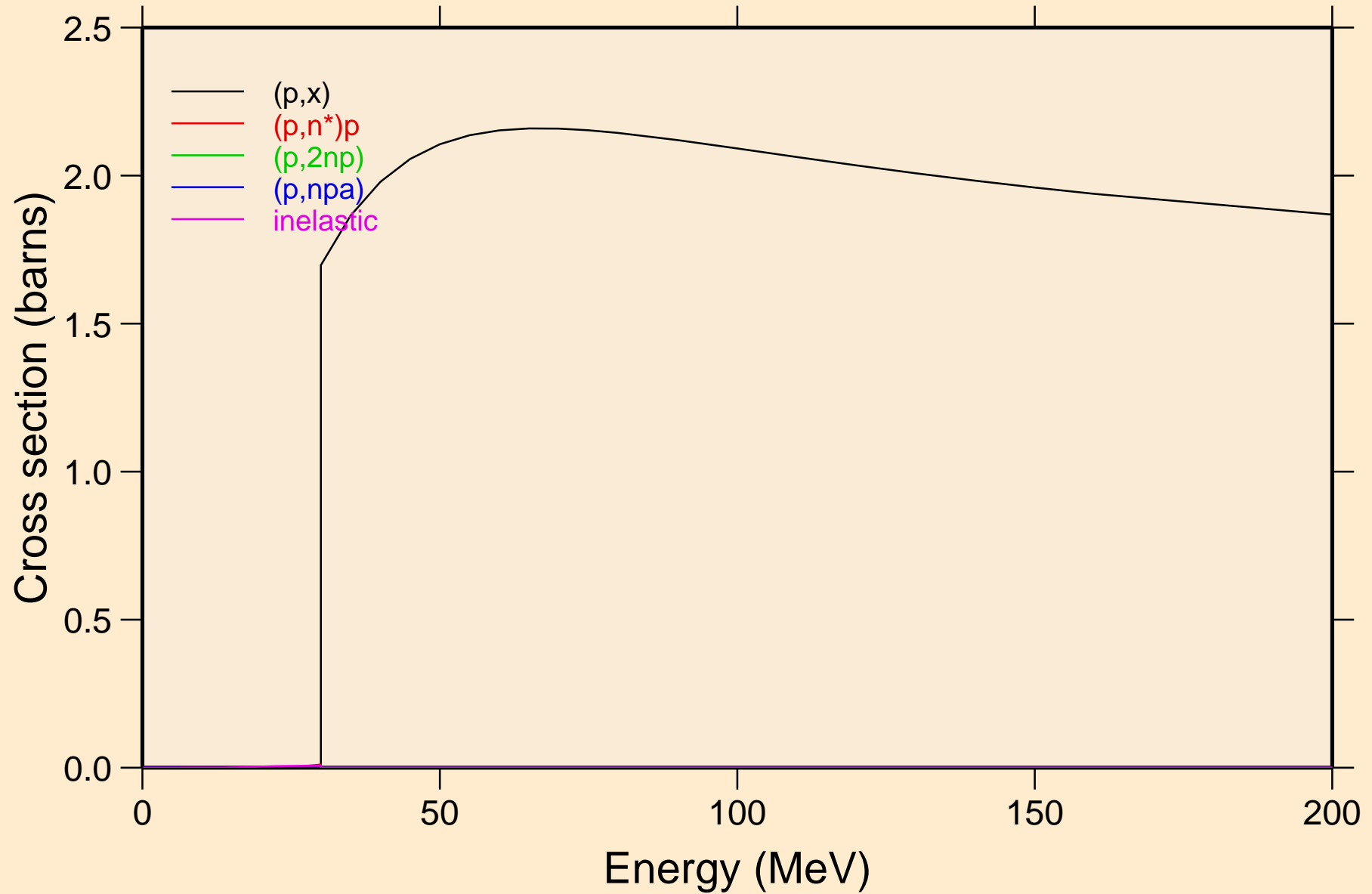

RF257M PROTON ACER TENDL-2023 LIBRARY; T=0.K  
Threshold reactions

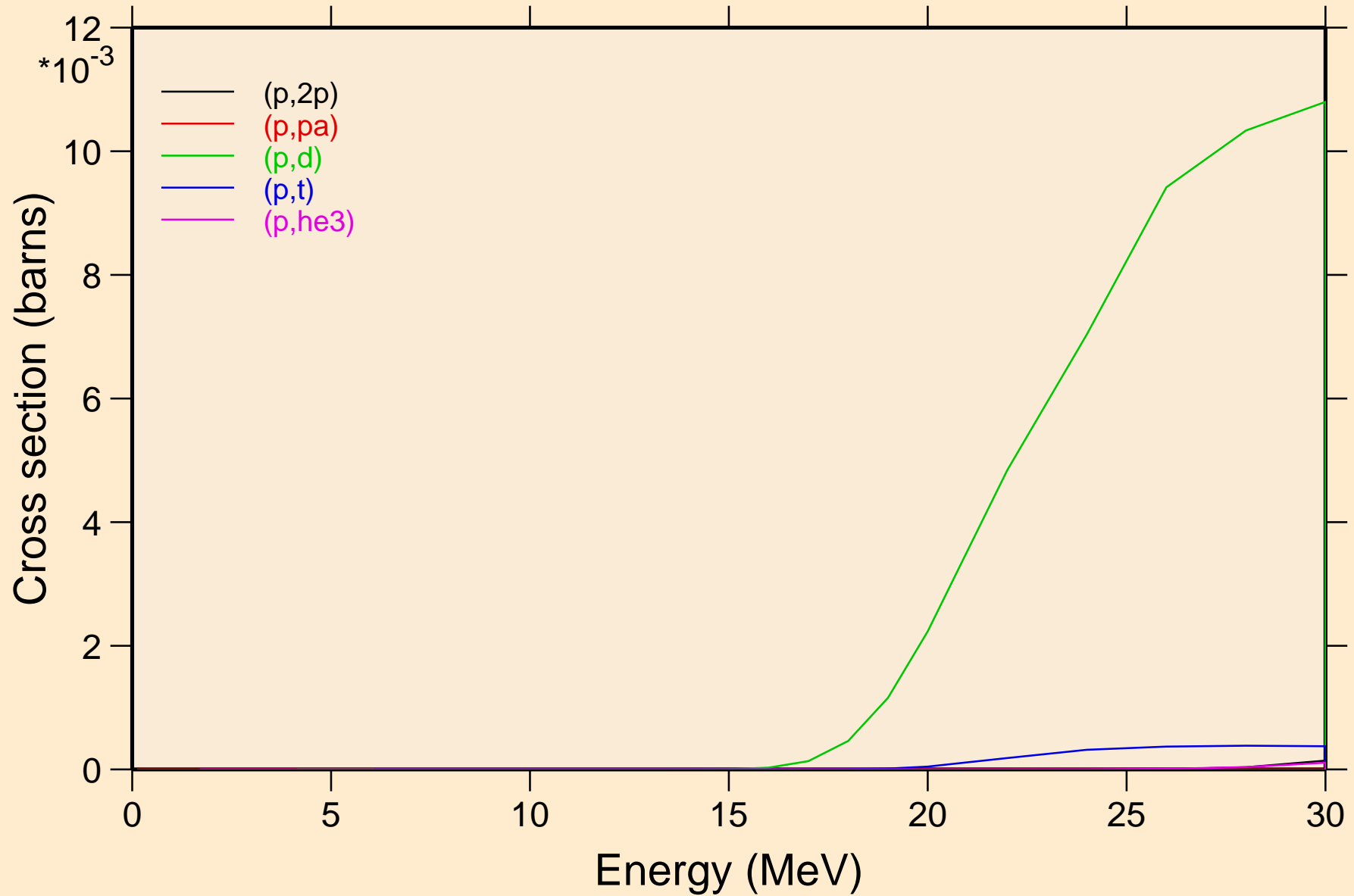

RF257M PROTON ACER TENDL-2023 LIBRARY; T=0.K  
Threshold reactions

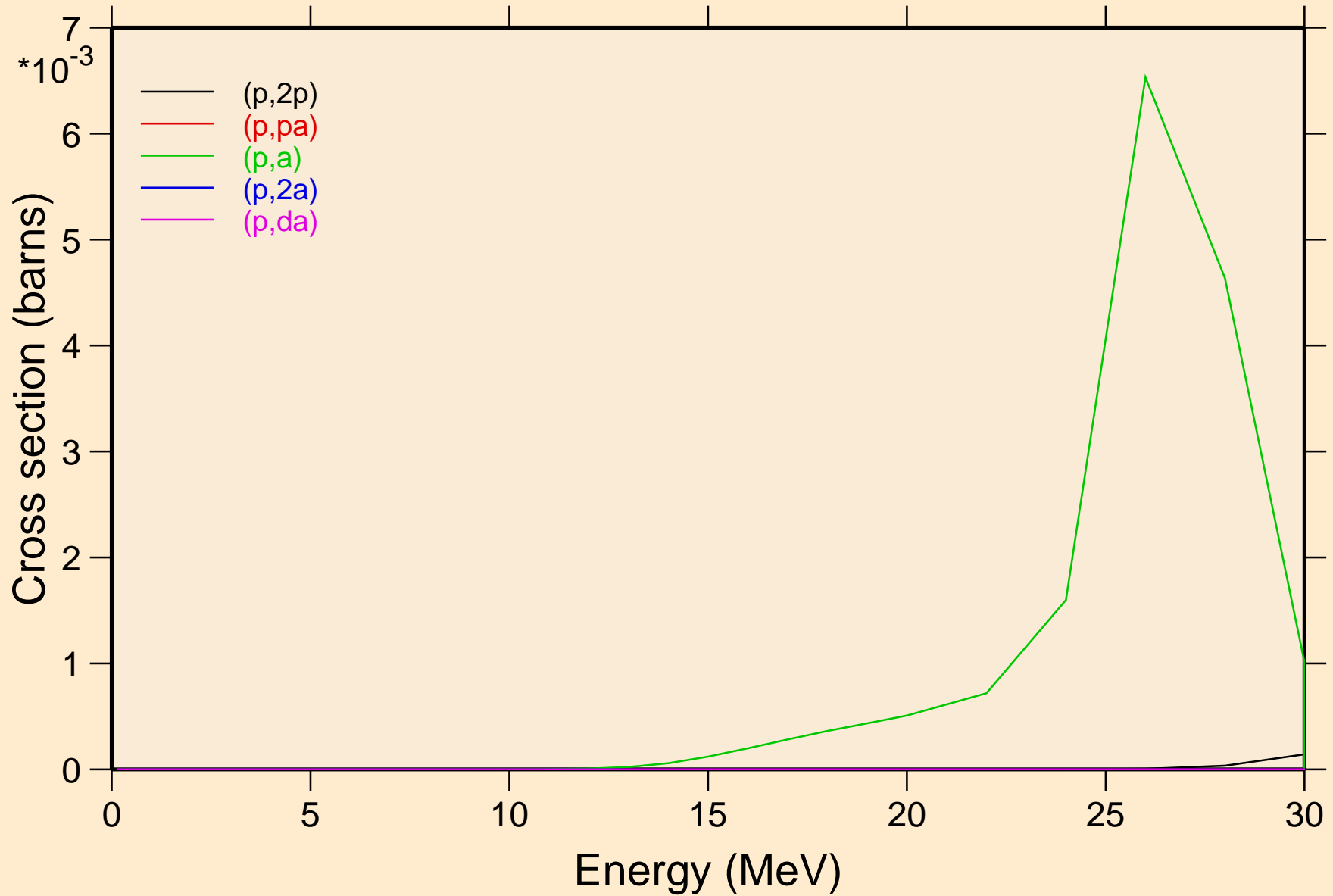

RF257M PROTON ACER TENDL-2023 LIBRARY; T=0.K  
angular distribution for elastic

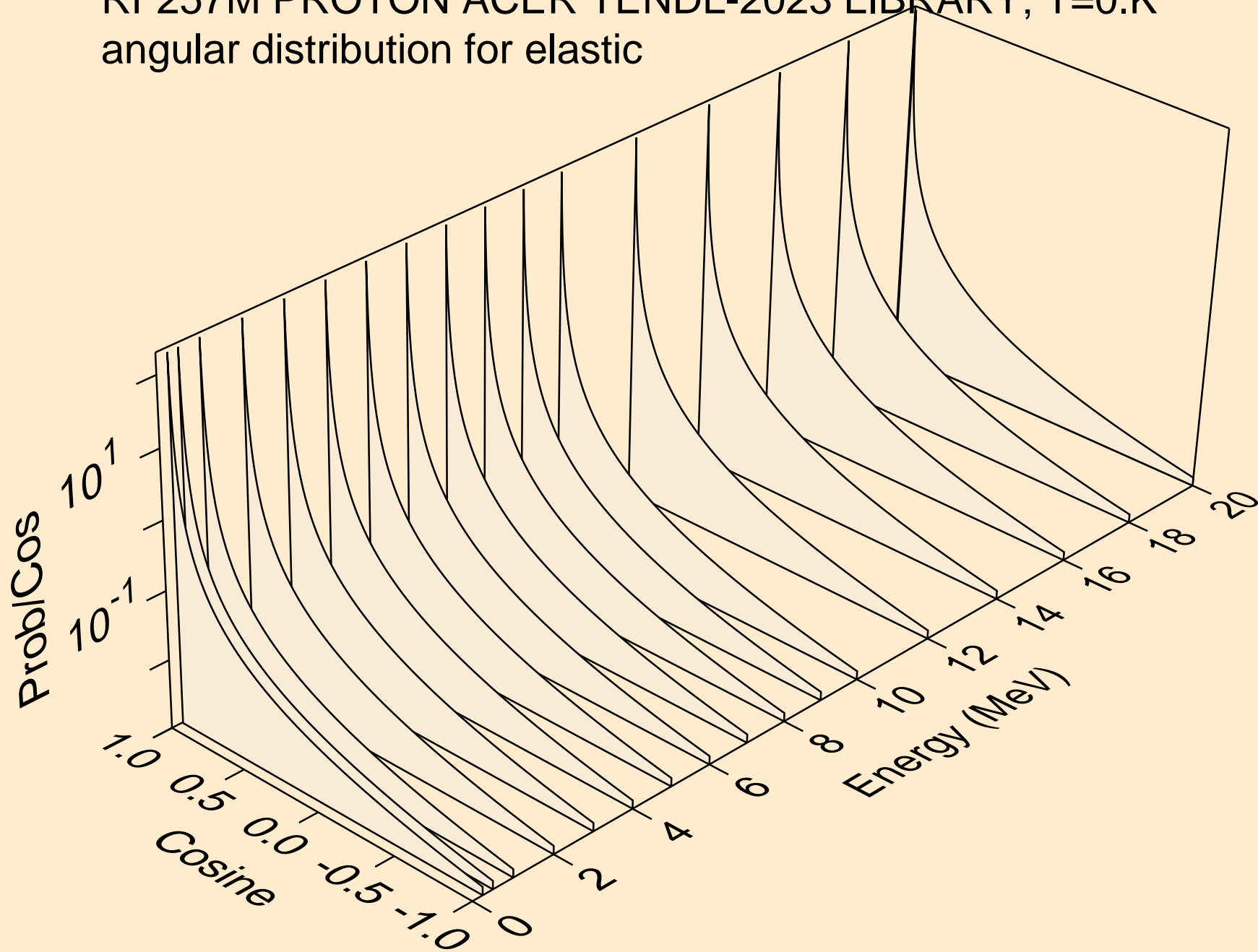



RF257M PROTON ACER TENDL-2023 LIBRARY; T=0.K  
angular distribution for elastic

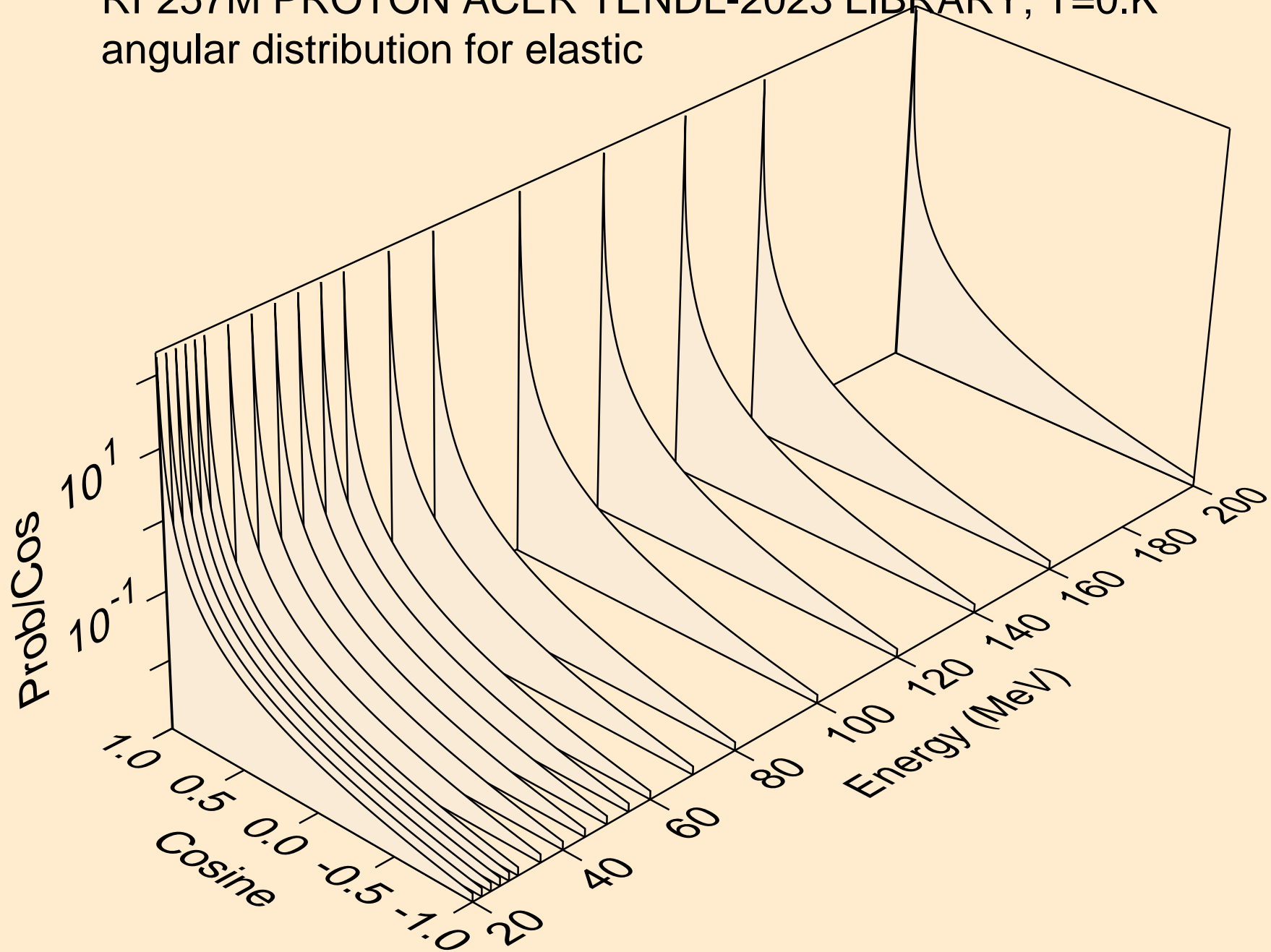

RF257M PROTON ACER TENDL-2023 LIBRARY; T=0.K  
Proton emission for (p,x)

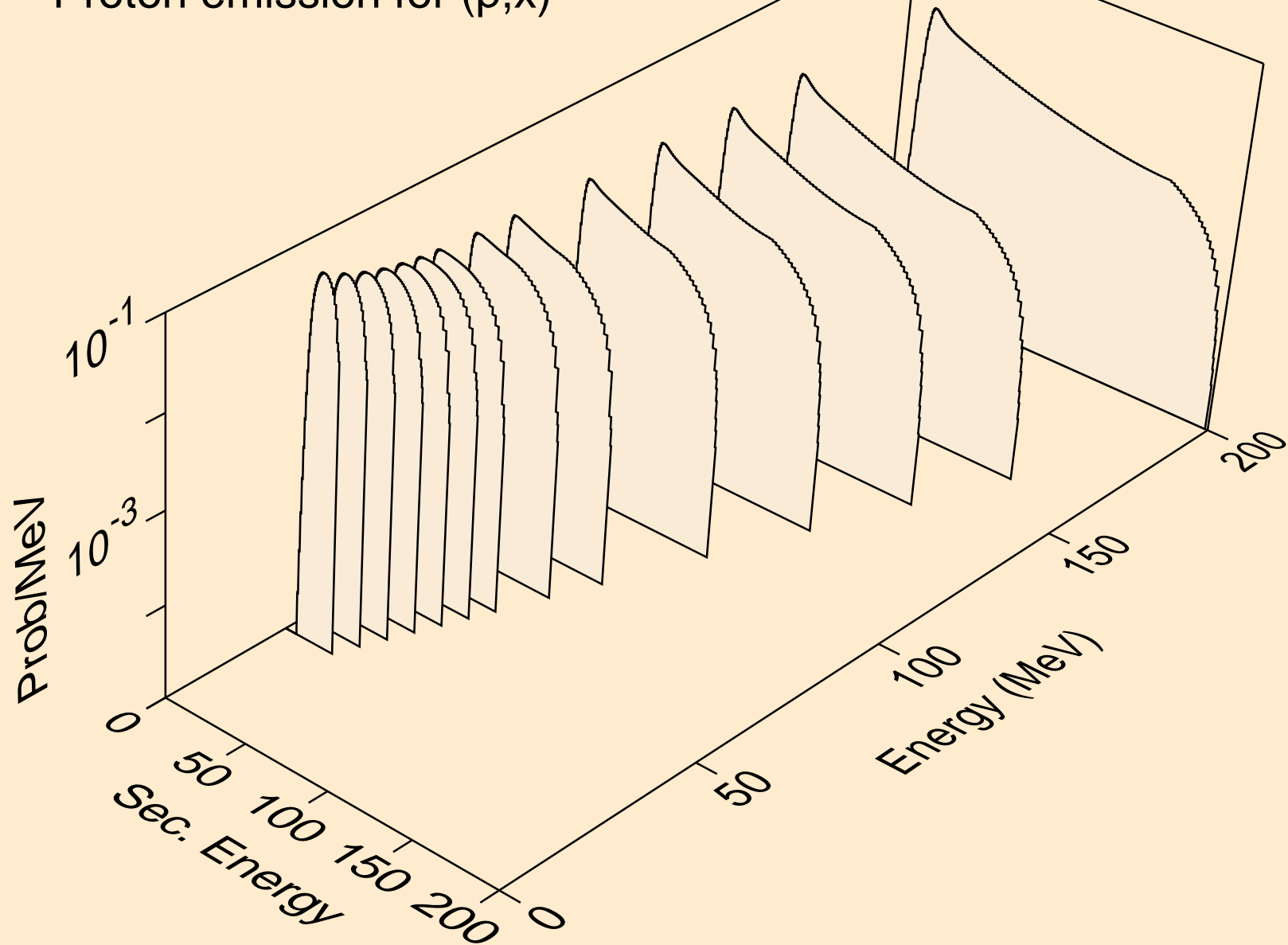

RF257M PROTON ACER TENDL-2023 LIBRARY; T=0.K  
Proton emission for (p,n\*)p

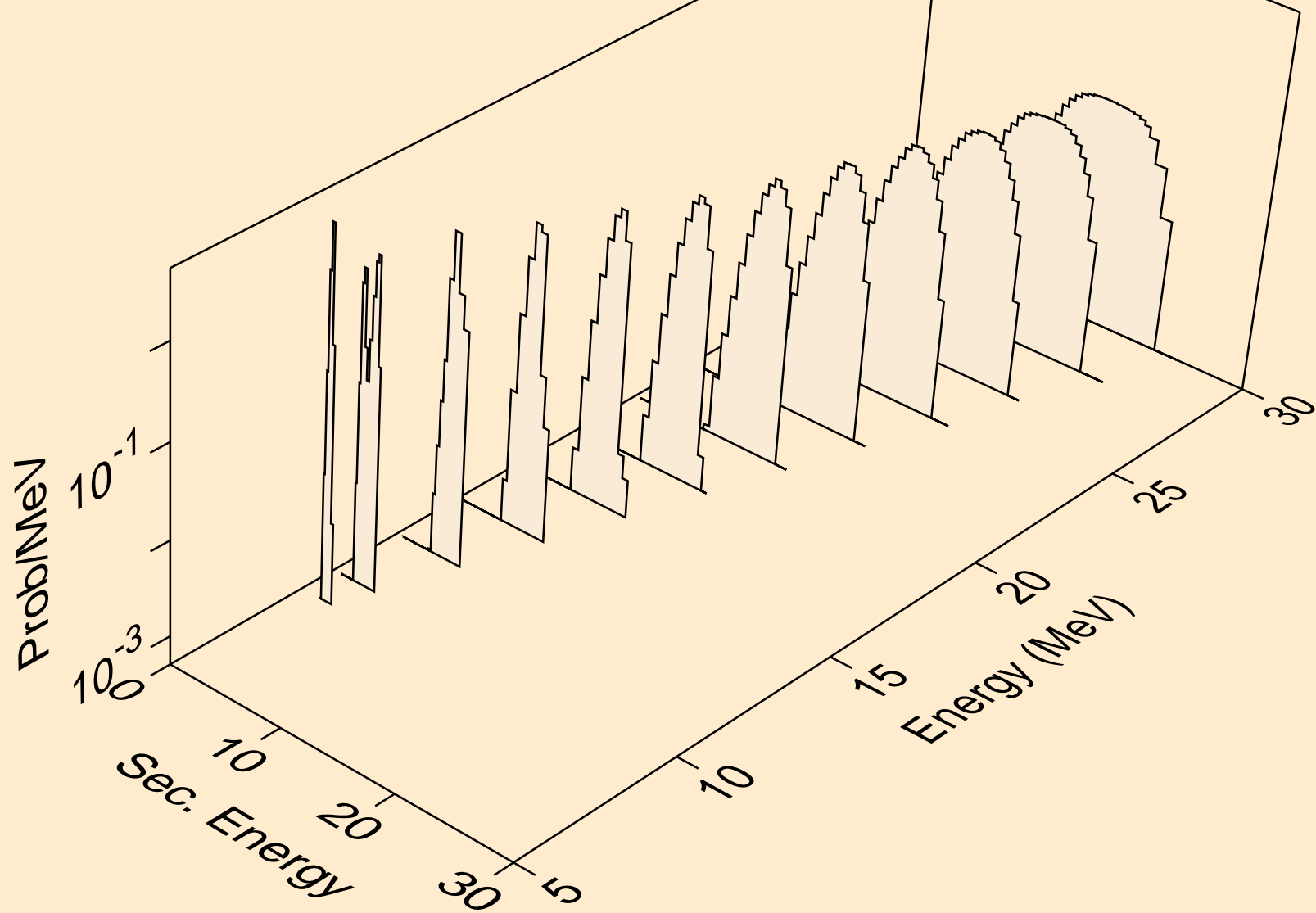

RF257M PROTON ACER TENDL-2023 LIBRARY; T=0.K  
Proton emission for (p,2np)

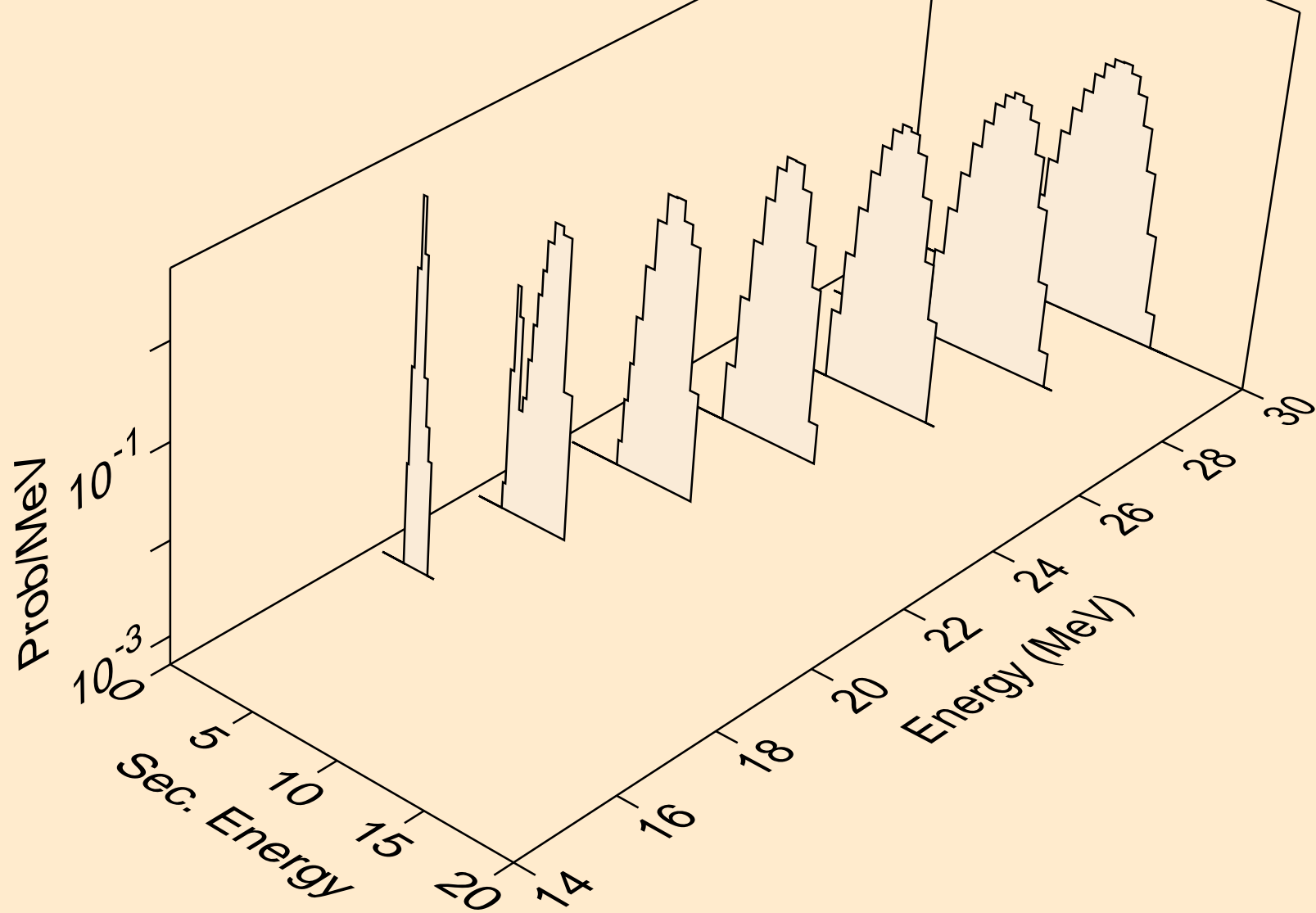

RF257M PROTON ACER TENDL-2023 LIBRARY; T=0.K  
Proton emission for (p,npa)

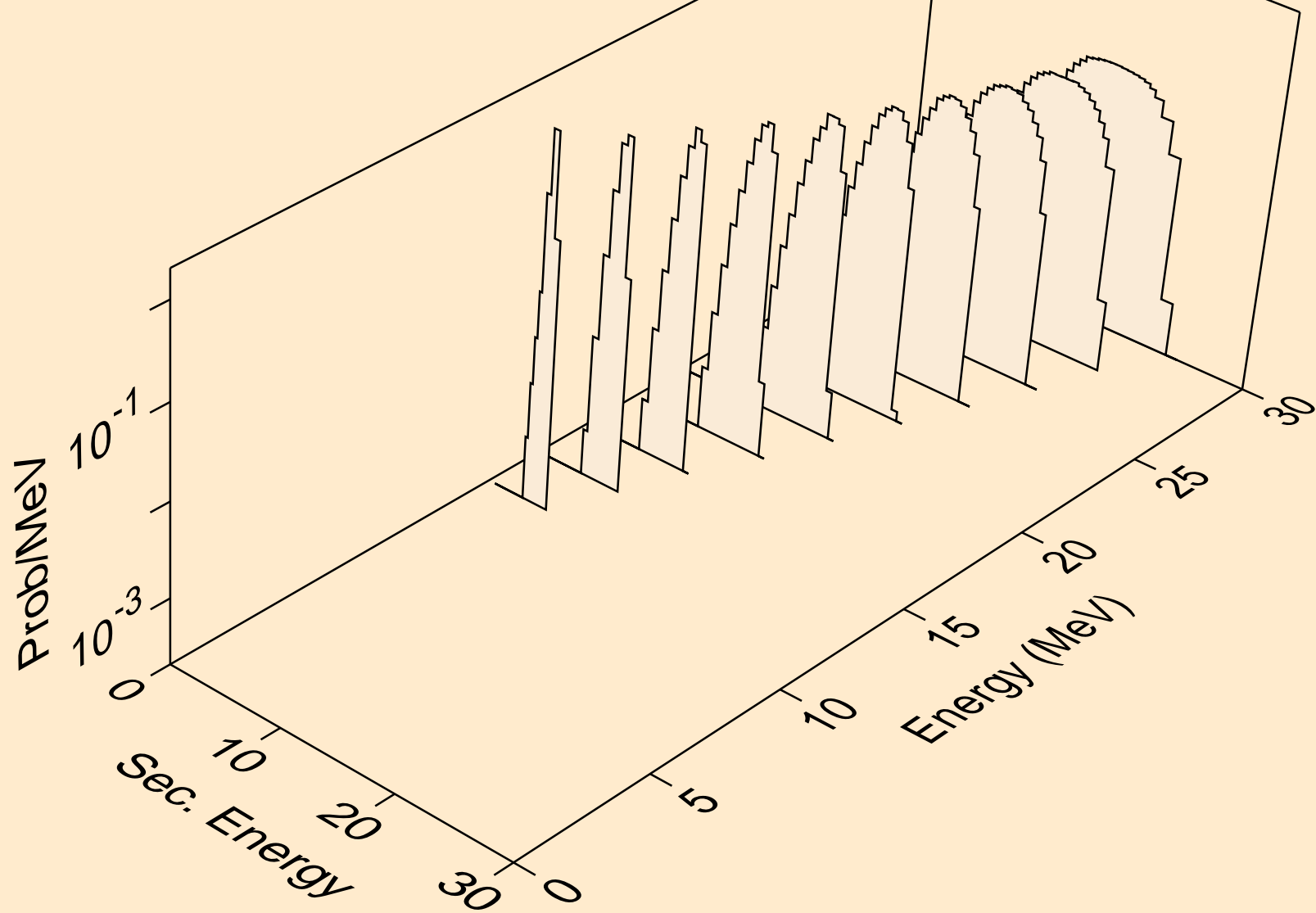

RF257M PROTON ACER TENDL-2023 LIBRARY; T=0.K  
Proton emission for inelastic

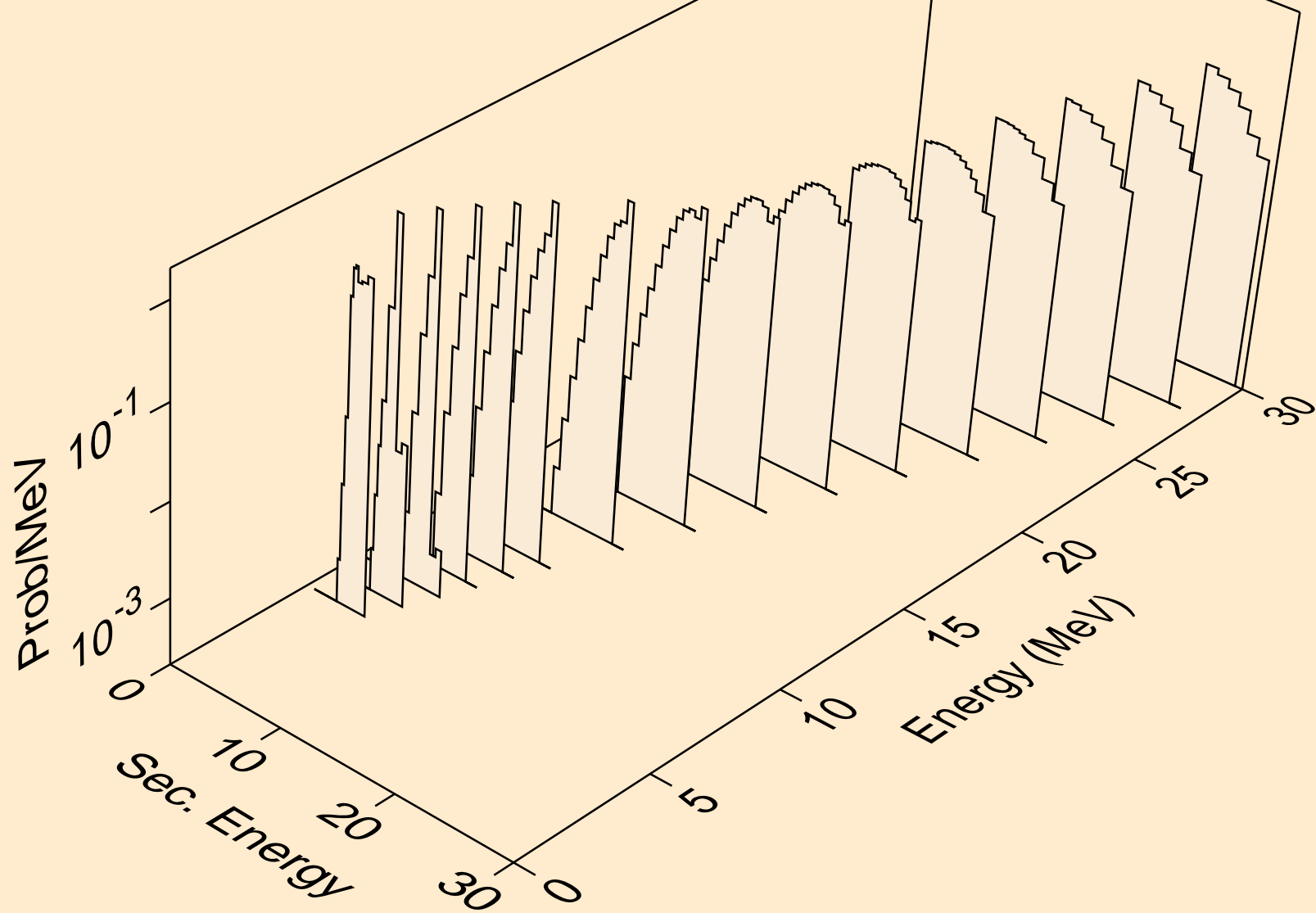

RF257M PROTON ACER TENDL-2023 LIBRARY; T=0.K  
Proton emission for (p,2p)

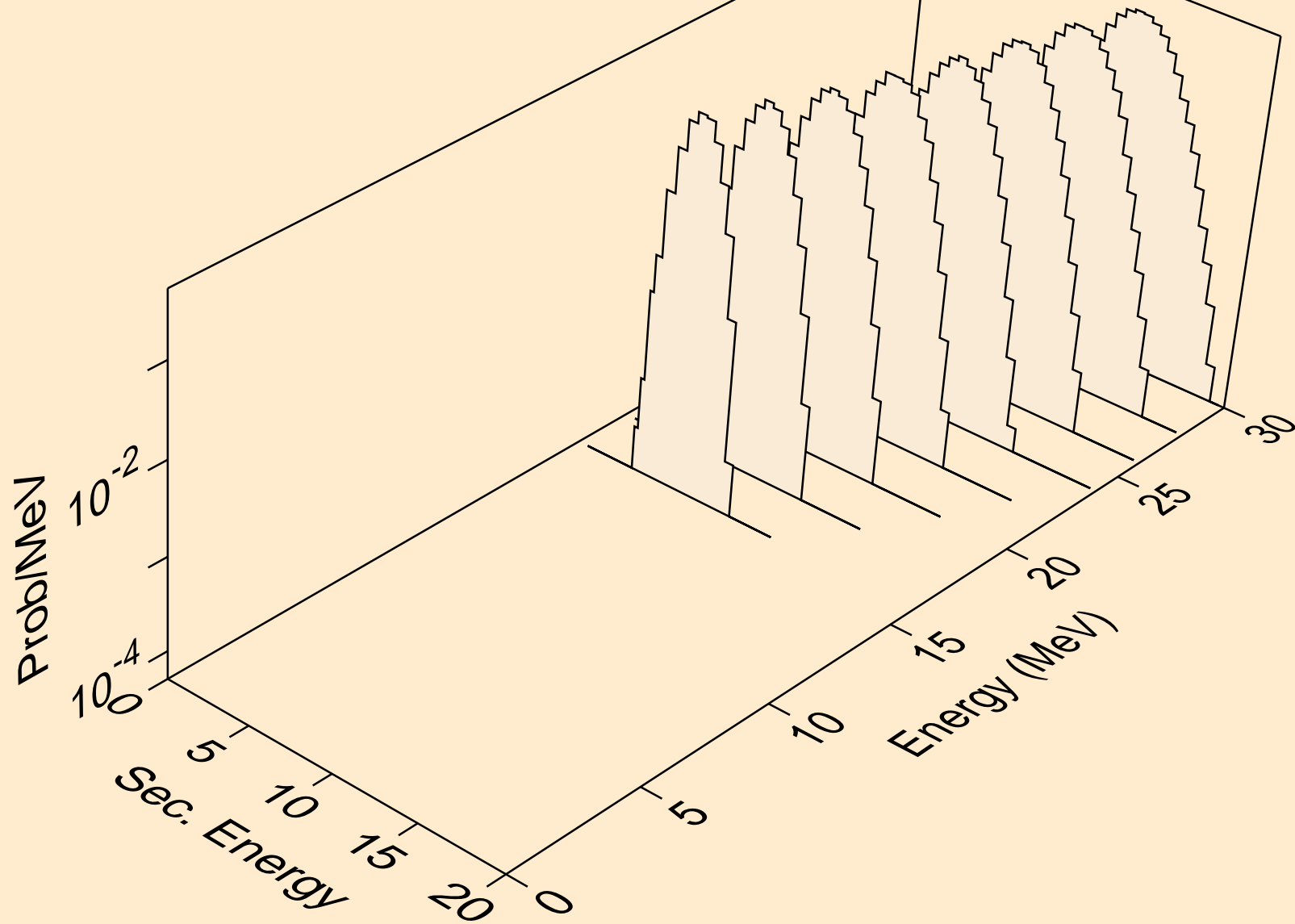

RF257M PROTON ACER TENDL-2023 LIBRARY; T=0.K  
Proton emission for (p,pa)

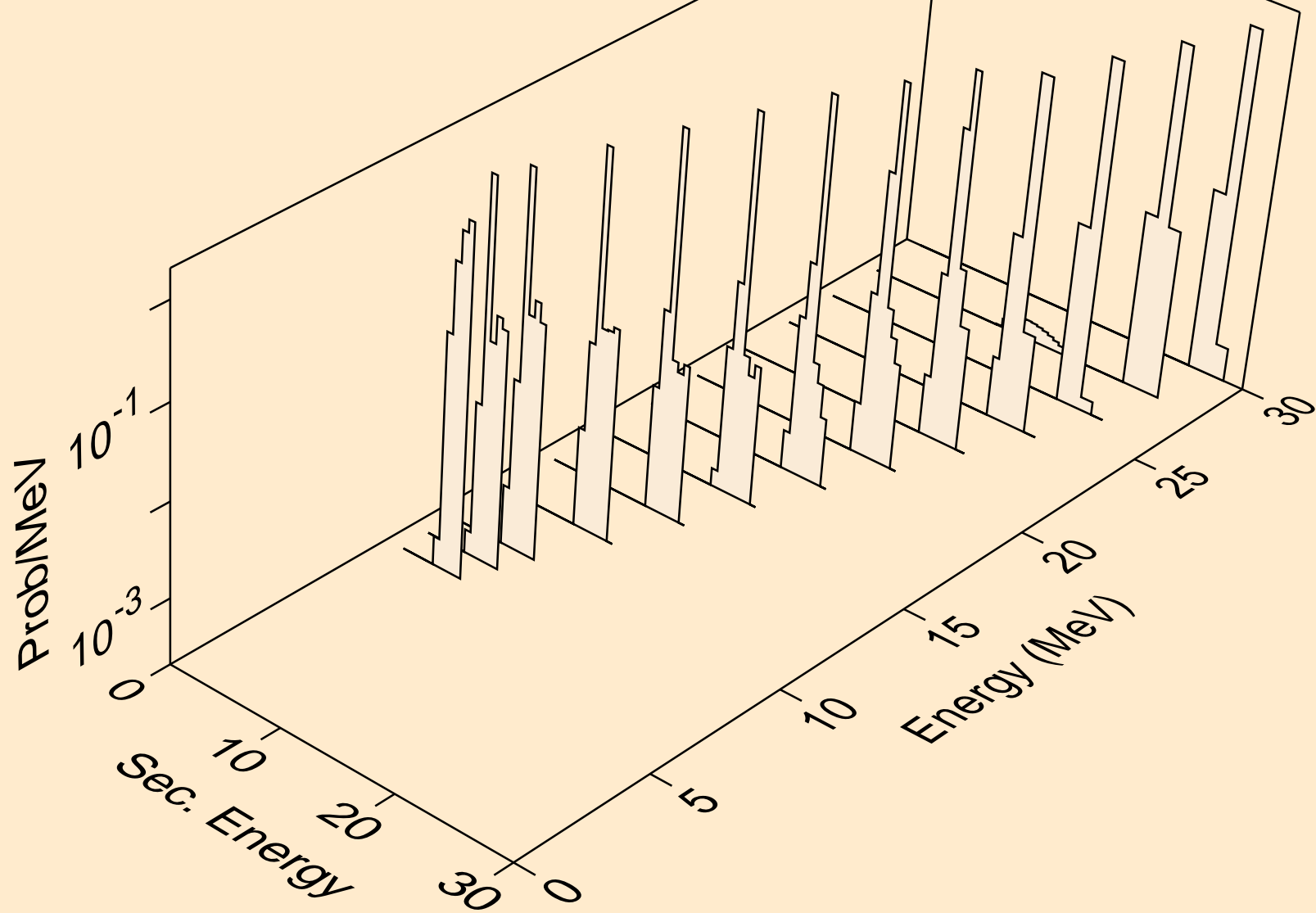



RF257M PROTON ACER TENDL-2023 LIBRARY; T=0.K  
Photon emission for (z,n)

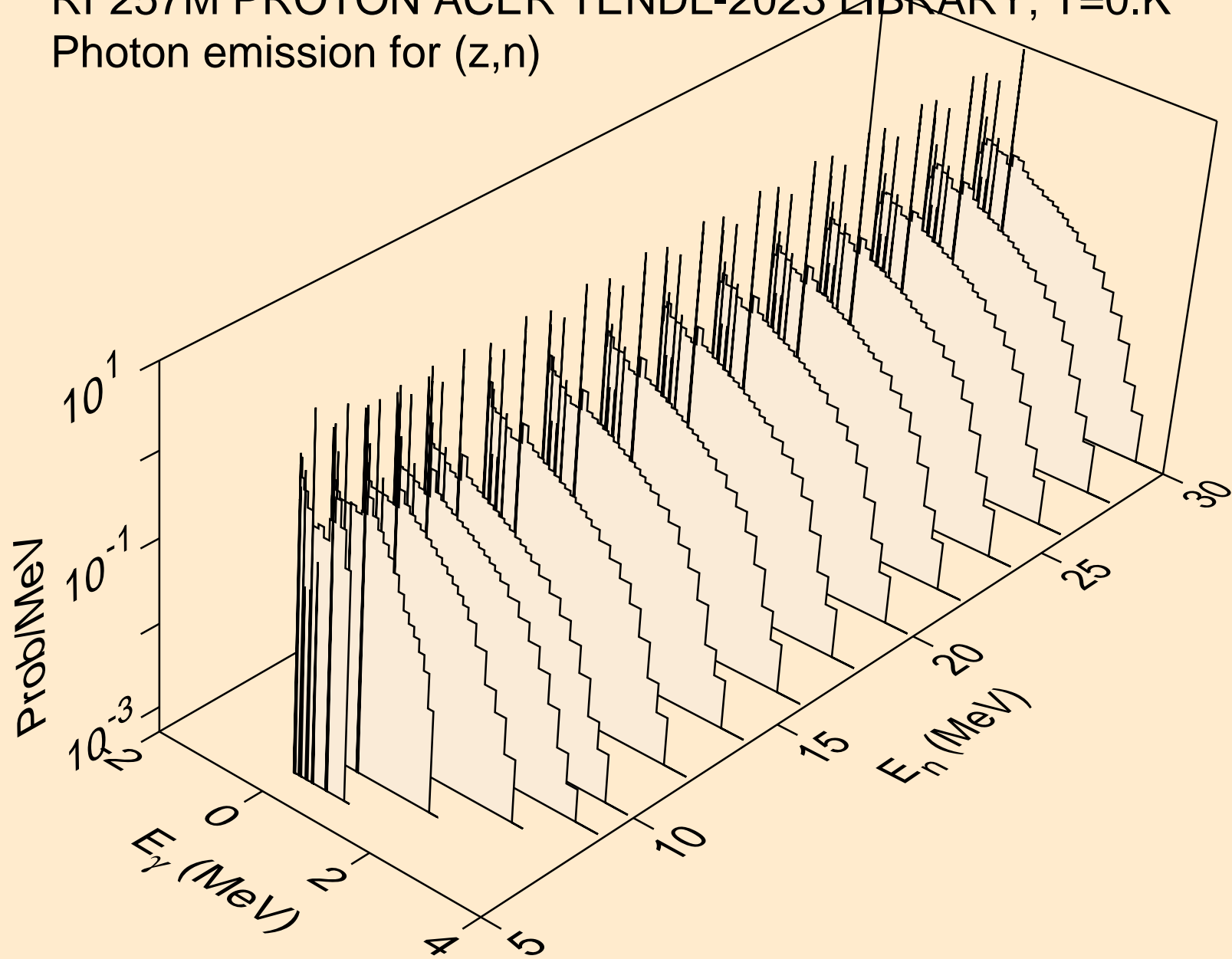

RF257M PROTON ACER TENDL-2023 LIBRARY; T=0.K  
Photon emission for (z,x)

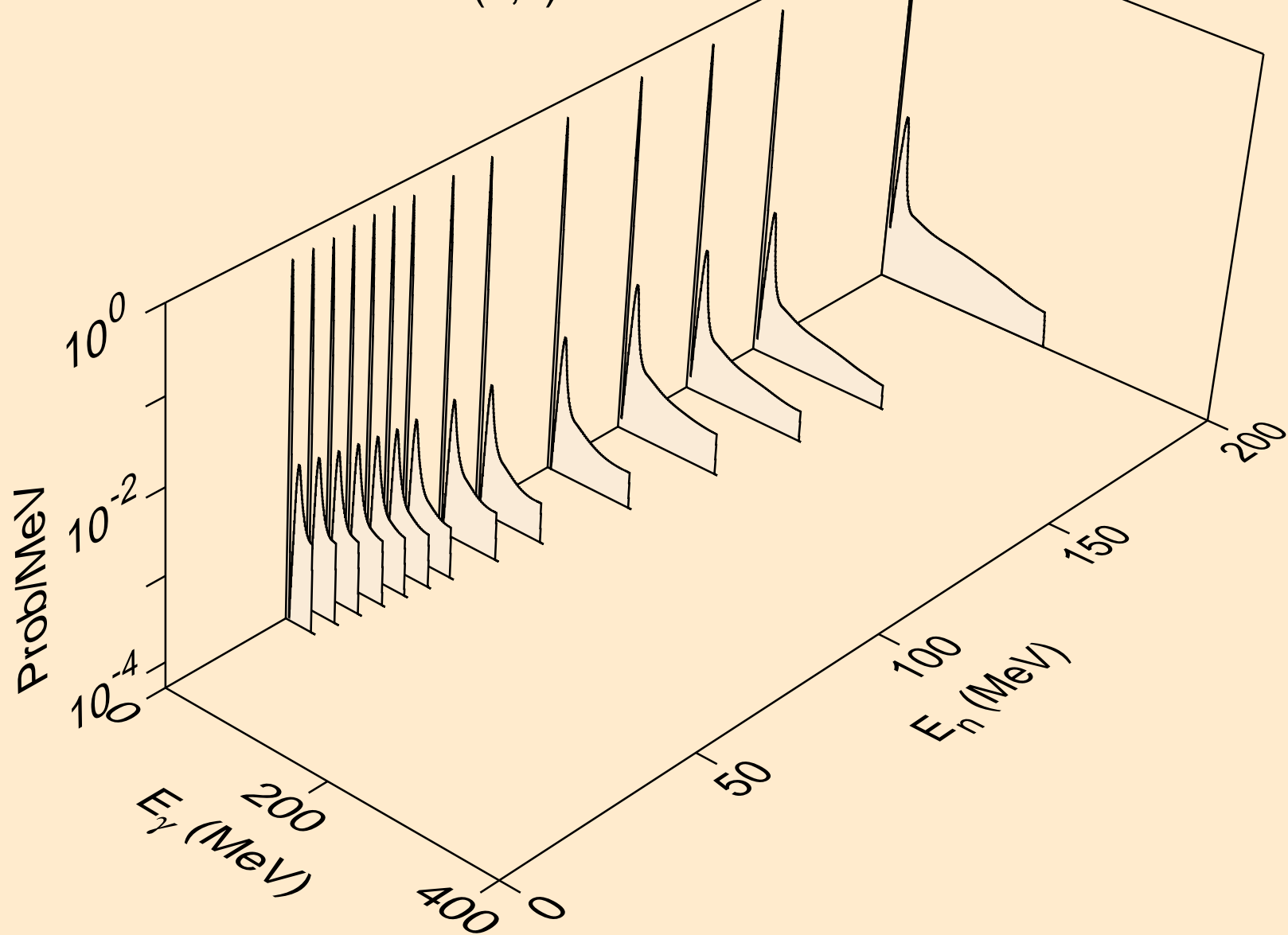

RF257M PROTON ACER TENDL-2023 LIBRARY; T=0.K  
Photon emission for (n,2n)

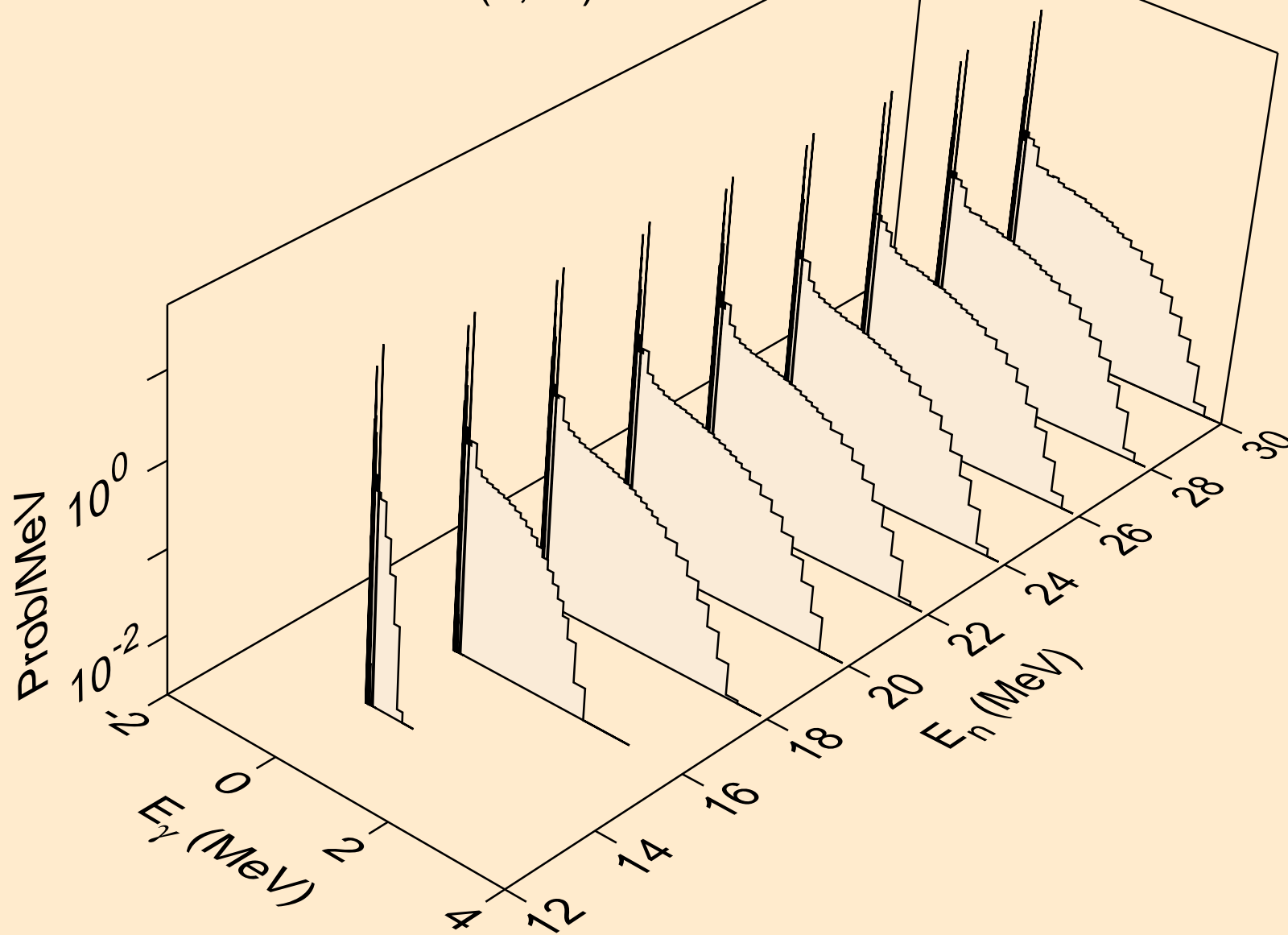

RF257M PROTON ACER TENDL-2023 LIBRARY; T=0.K  
Photon emission for (n,3n)

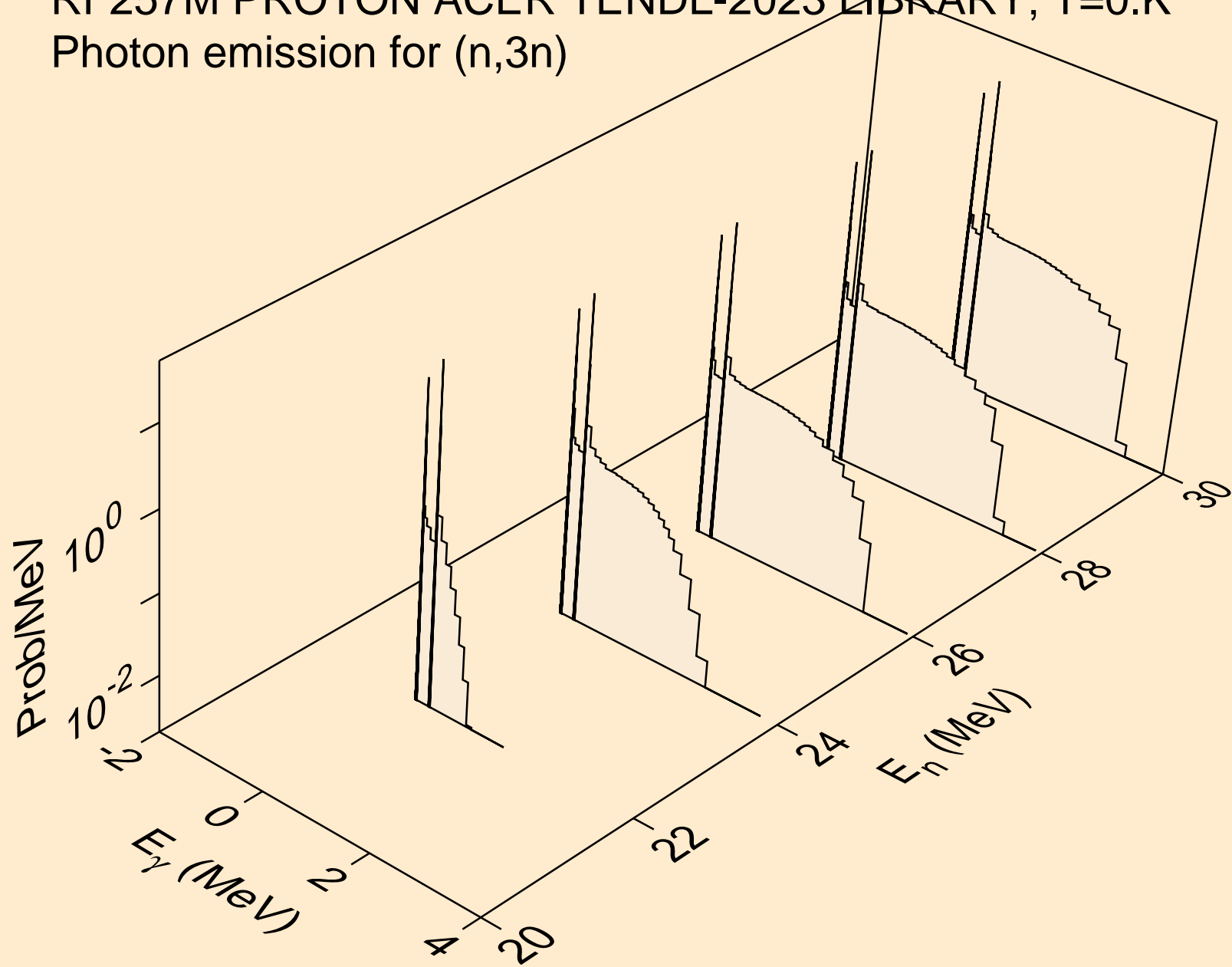

RF257M PROTON ACER TENDL-2023 LIBRARY; T=0.K  
Photon emission for (n,n\*)a

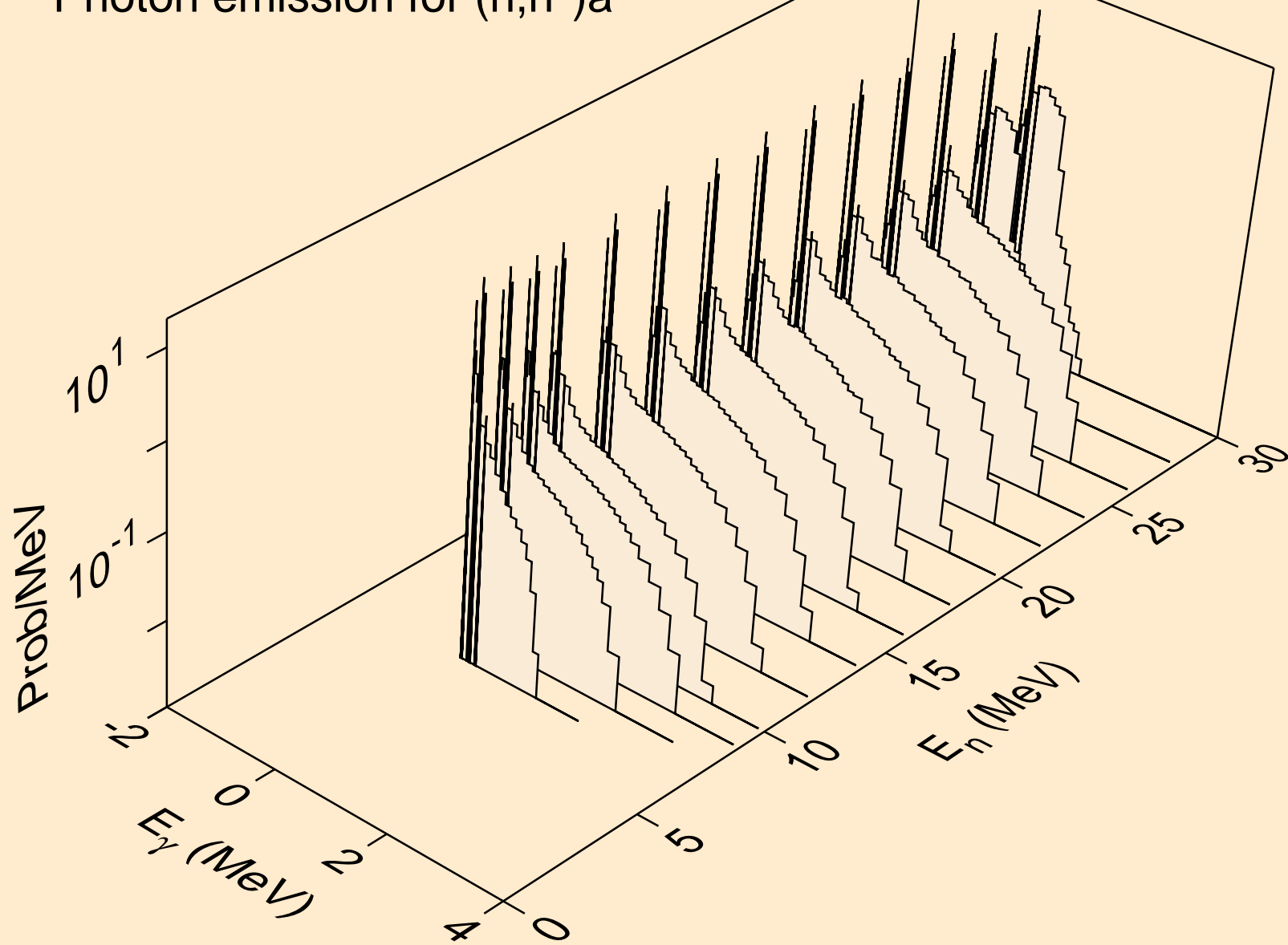

RF257M PROTON ACER TENDL-2023 LIBRARY; T=0.K  
Photon emission for (n,2n) $\alpha$

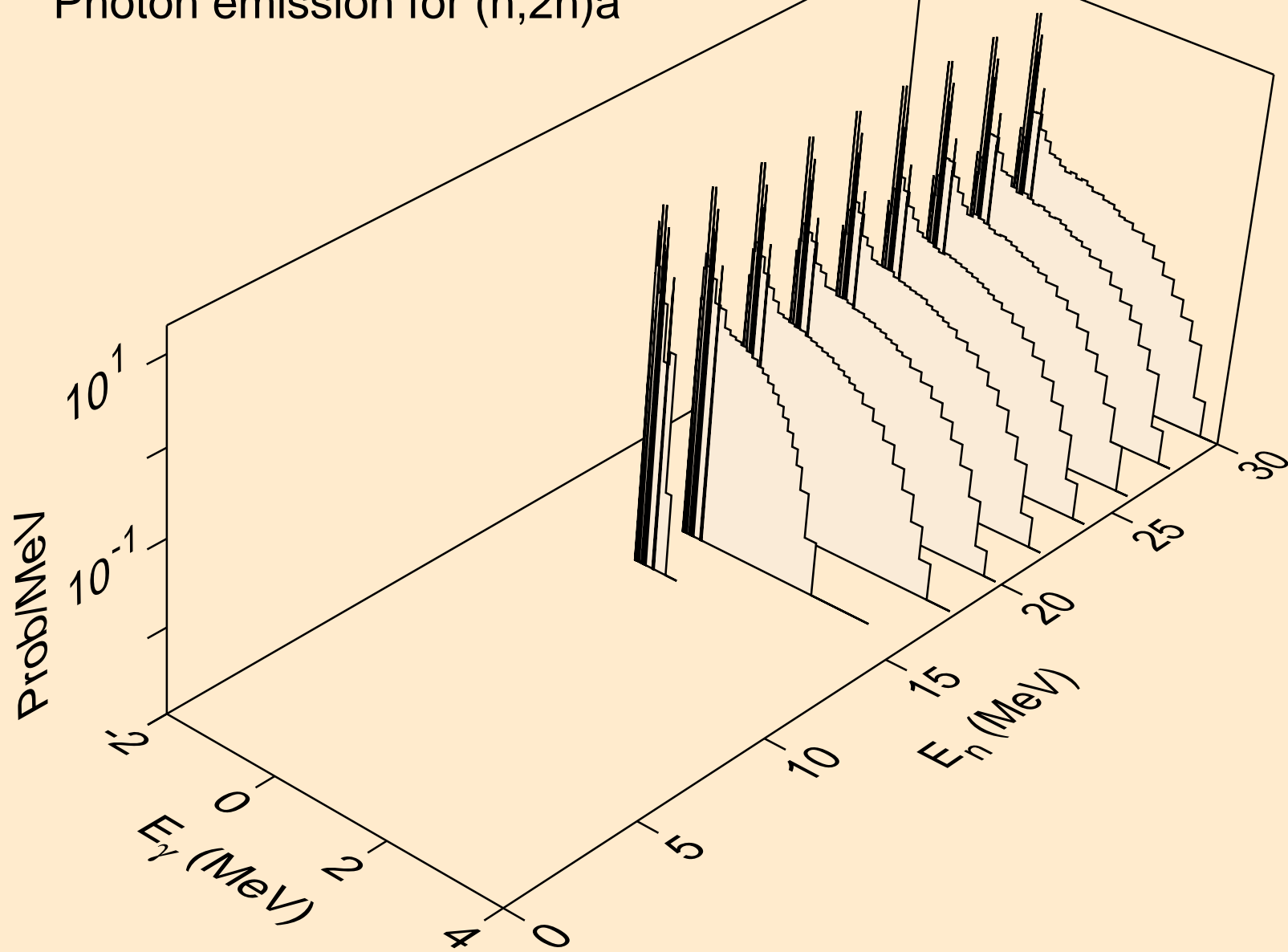

RF257M PROTON ACER TENDL-2023 LIBRARY; T=0.K  
Photon emission for (n,n\*)p

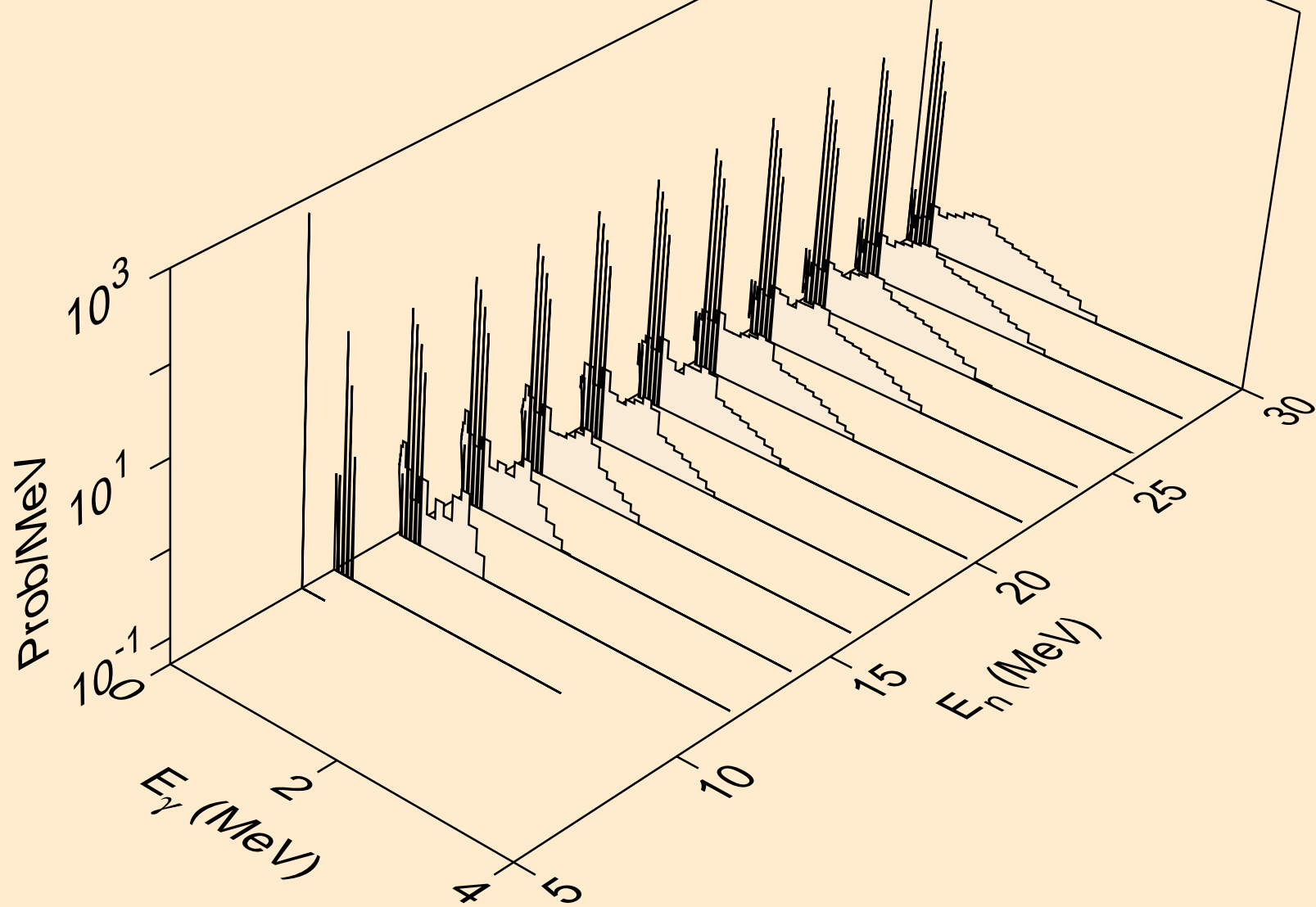

RF257M PROTON ACER TENDL-2023 LIBRARY; T=0.K  
Photon emission for (n,n\*)d

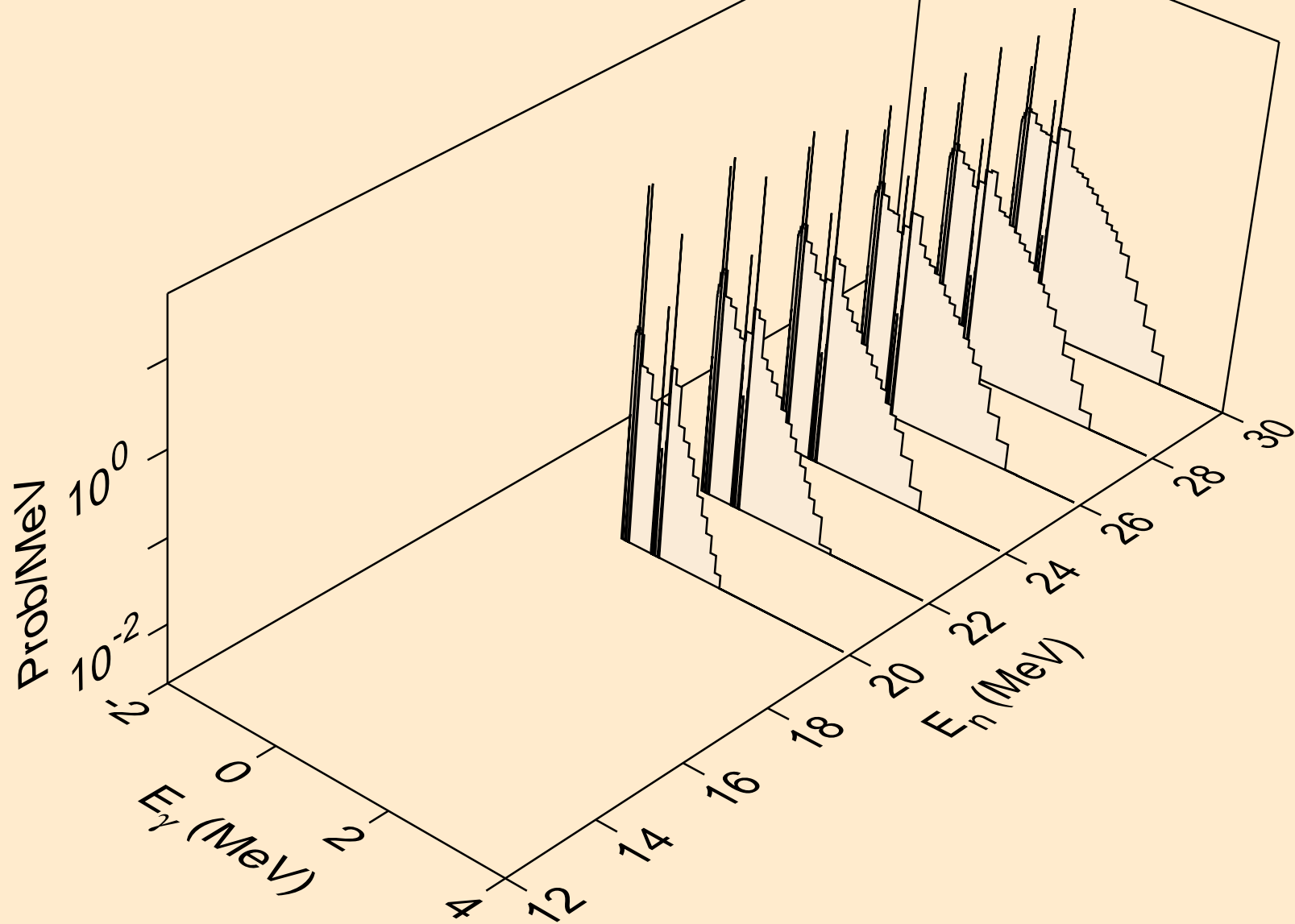



RF257M PROTON ACER TENDL-2023 LIBRARY; T=0.K  
Photon emission for (n,n\*)t

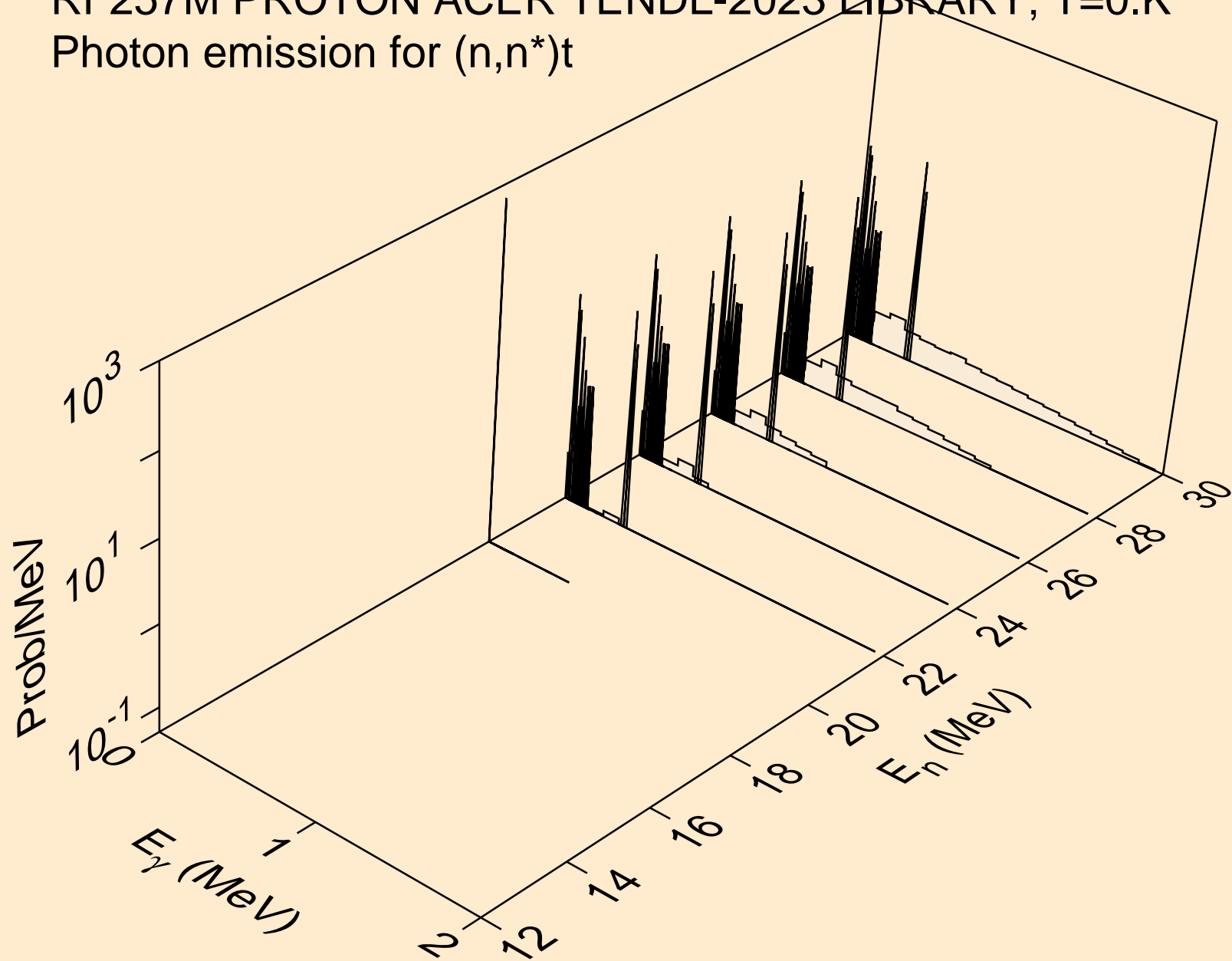

RF257M PROTON ACER TENDL-2023 LIBRARY; T=0.K  
Photon emission for (n,2np)

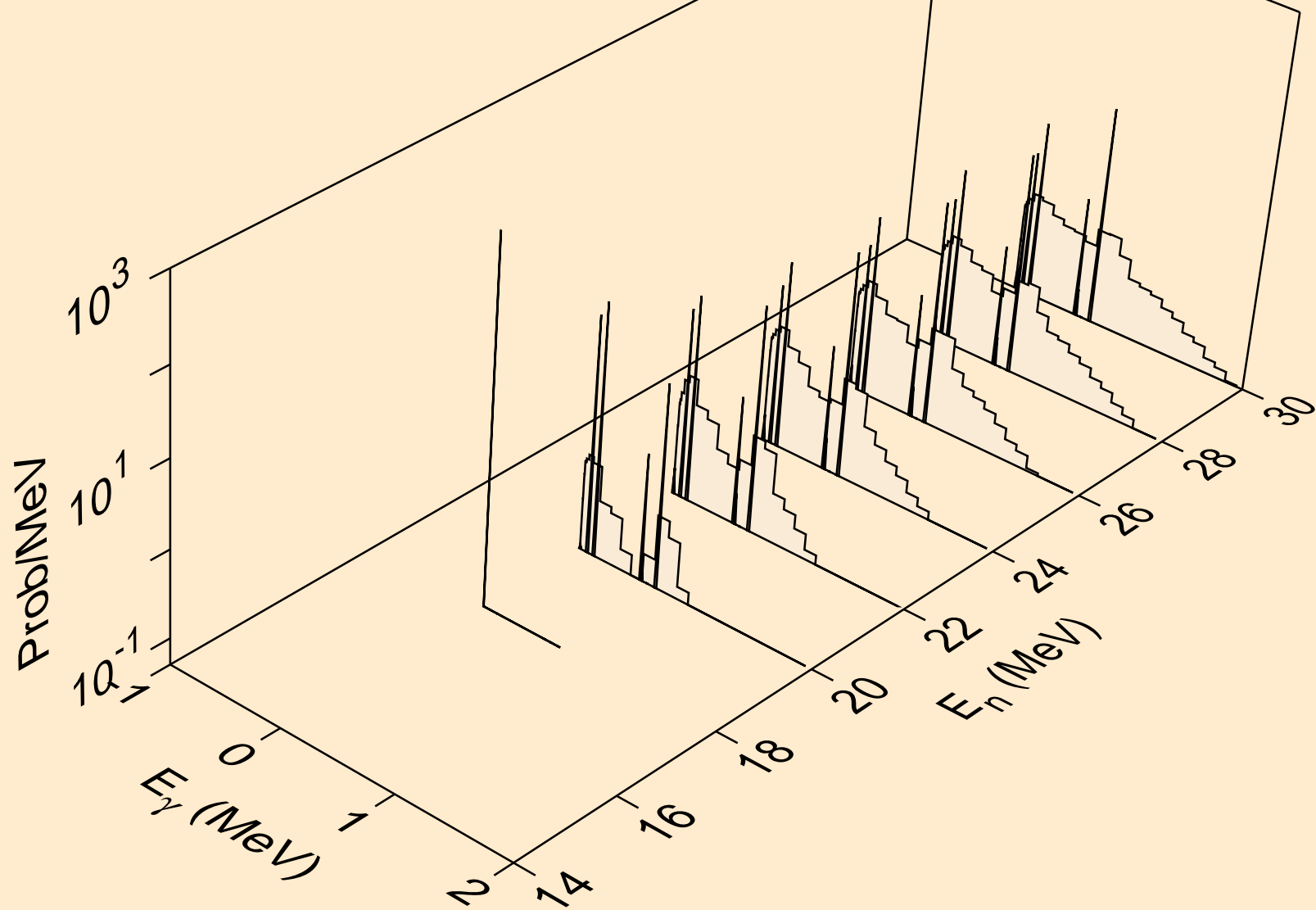

RF257M PROTON ACER TENDL-2023 LIBRARY; T=0.K  
Photon emission for (n,npa)

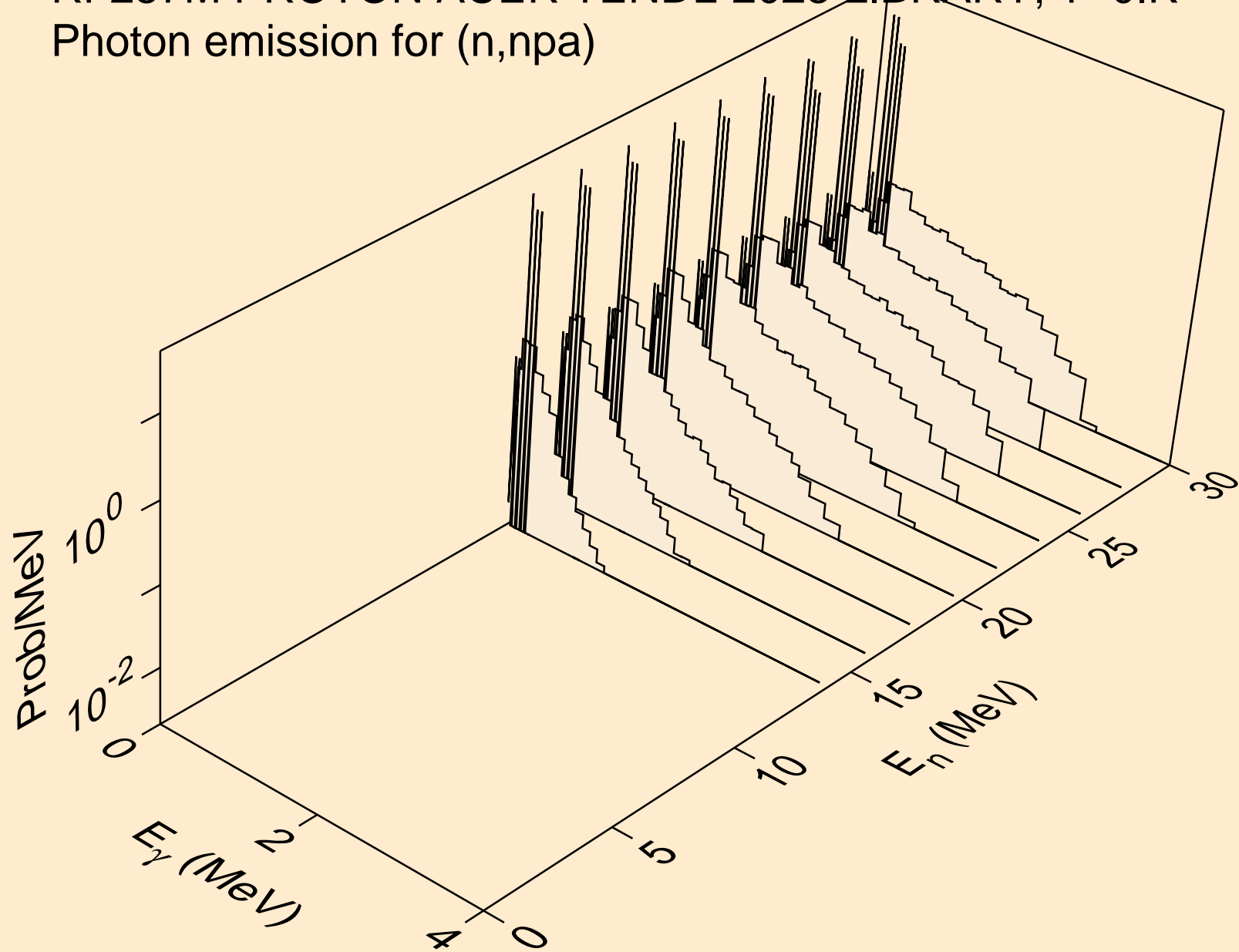

RF257M PROTON ACER TENDL-2023 LIBRARY; T=0.K  
Photon emission for (n,gma)

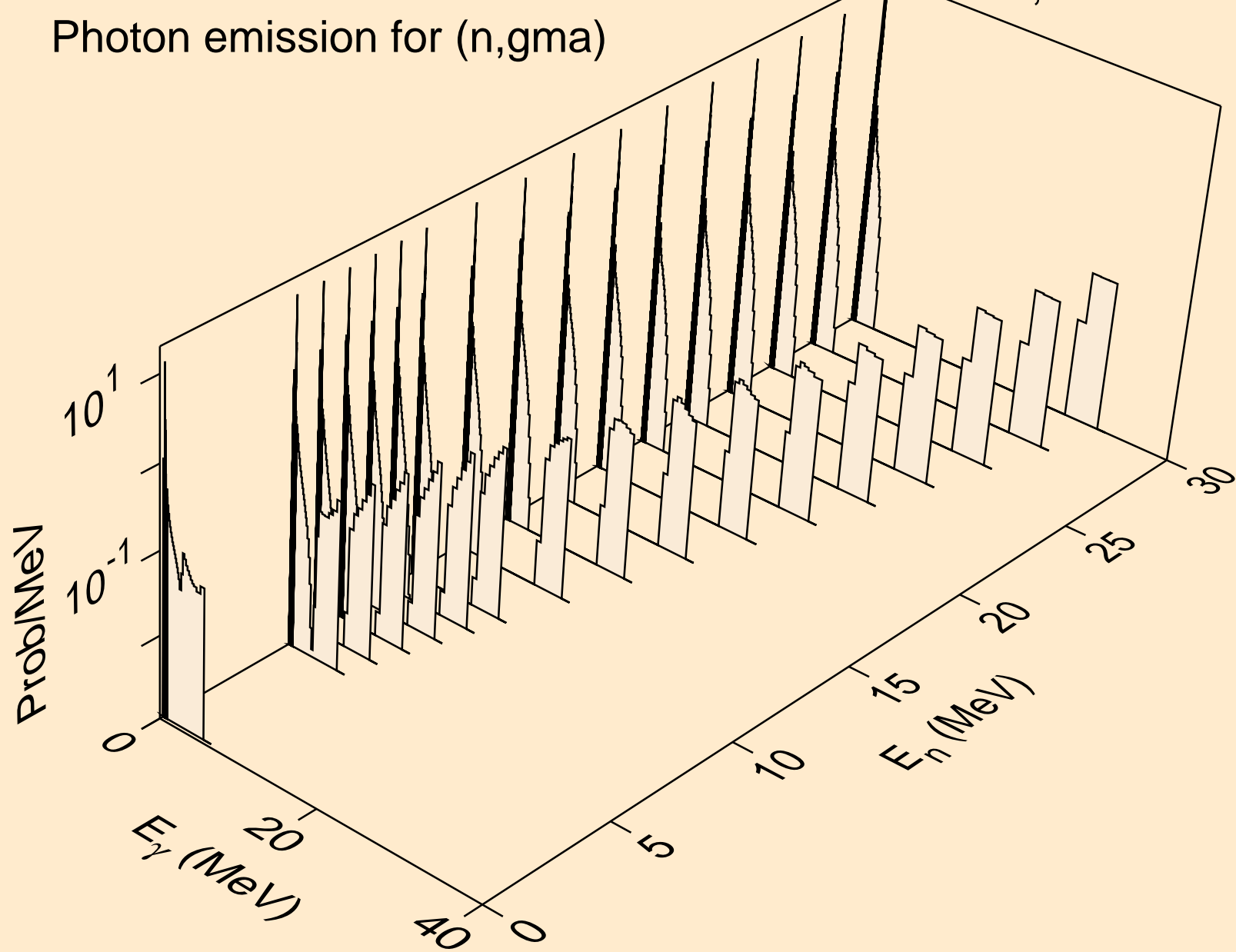

RF257M PROTON ACER TENDL-2023 LIBRARY; T=0.K  
Photon emission for inelastic

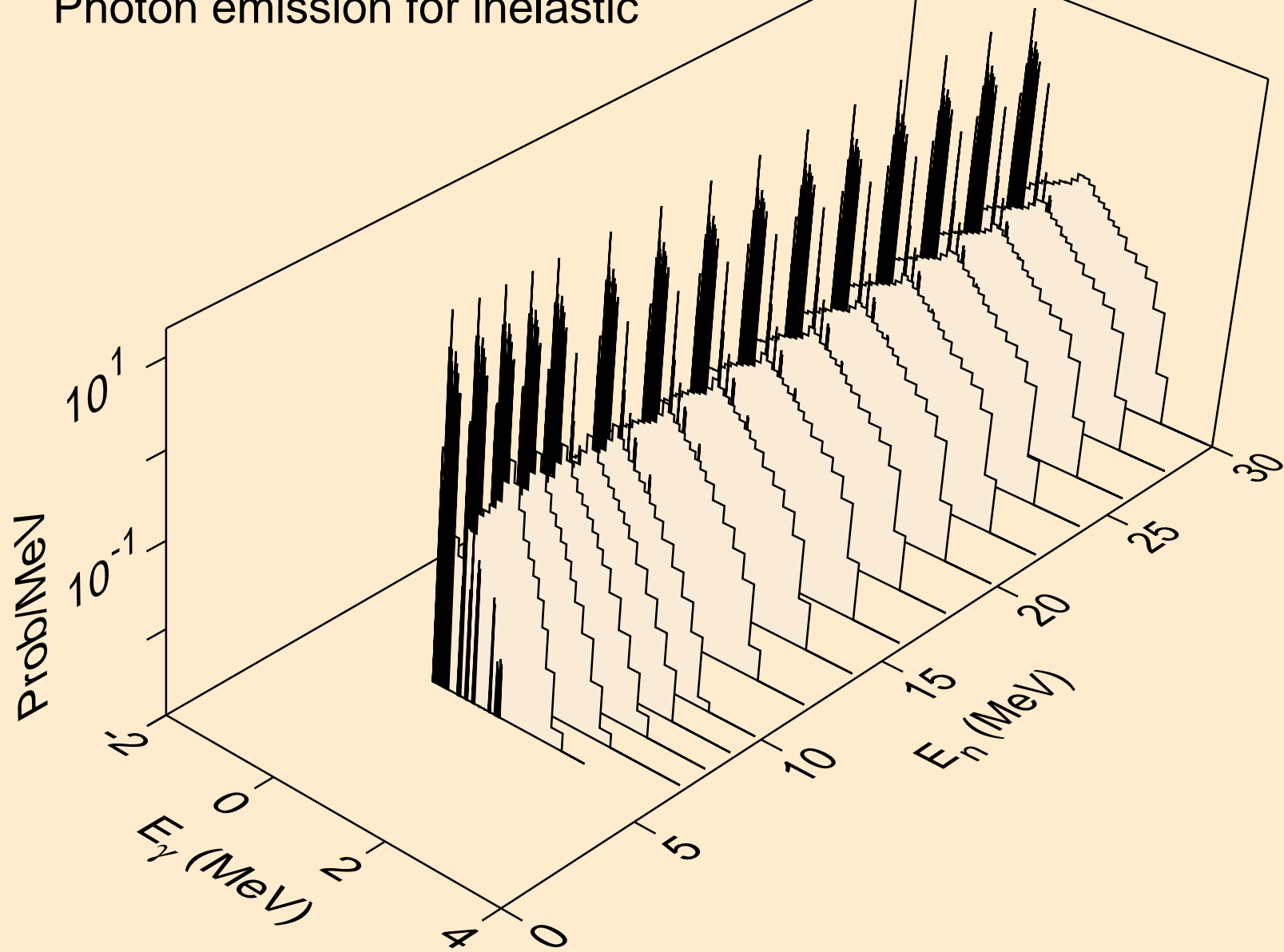

RF257M PROTON ACER TENDL-2023 LIBRARY; T=0.K  
Photon emission for (n,d)

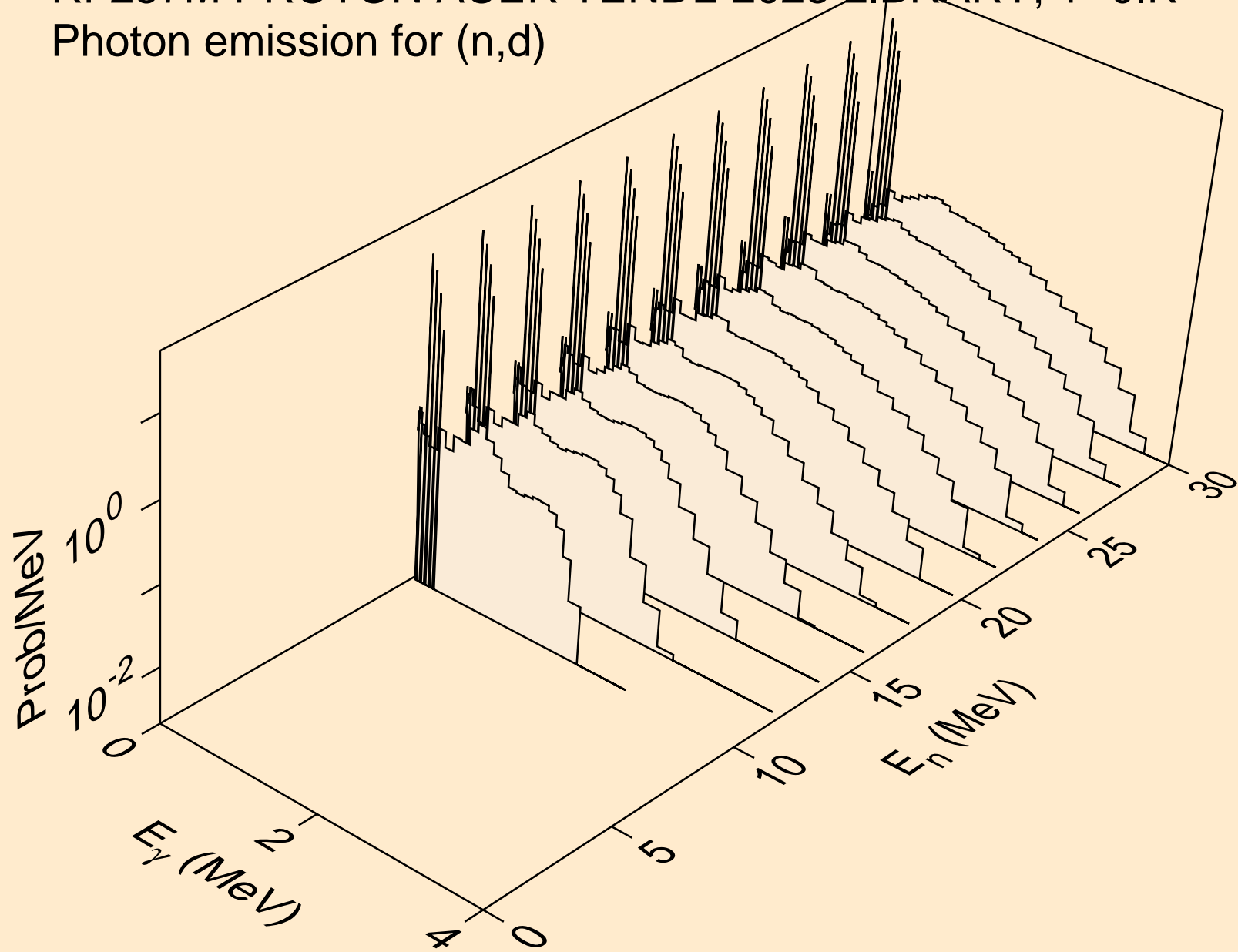

RF257M PROTON ACER TENDL-2023 LIBRARY; T=0.K  
Photon emission for (n,t)

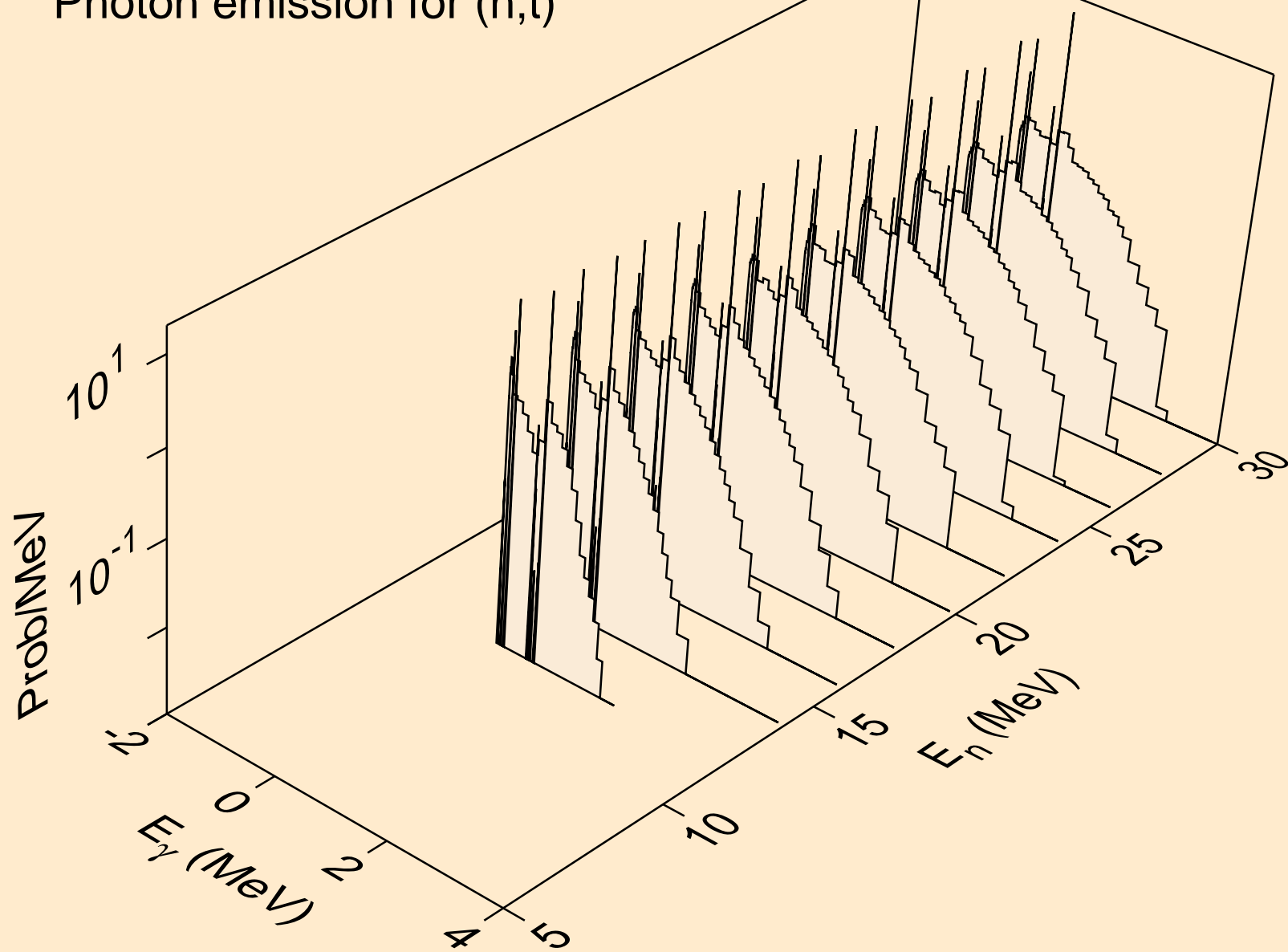

RF257M PROTON ACER TENDL-2023 LIBRARY; T=0.K  
Photon emission for (n,he3)

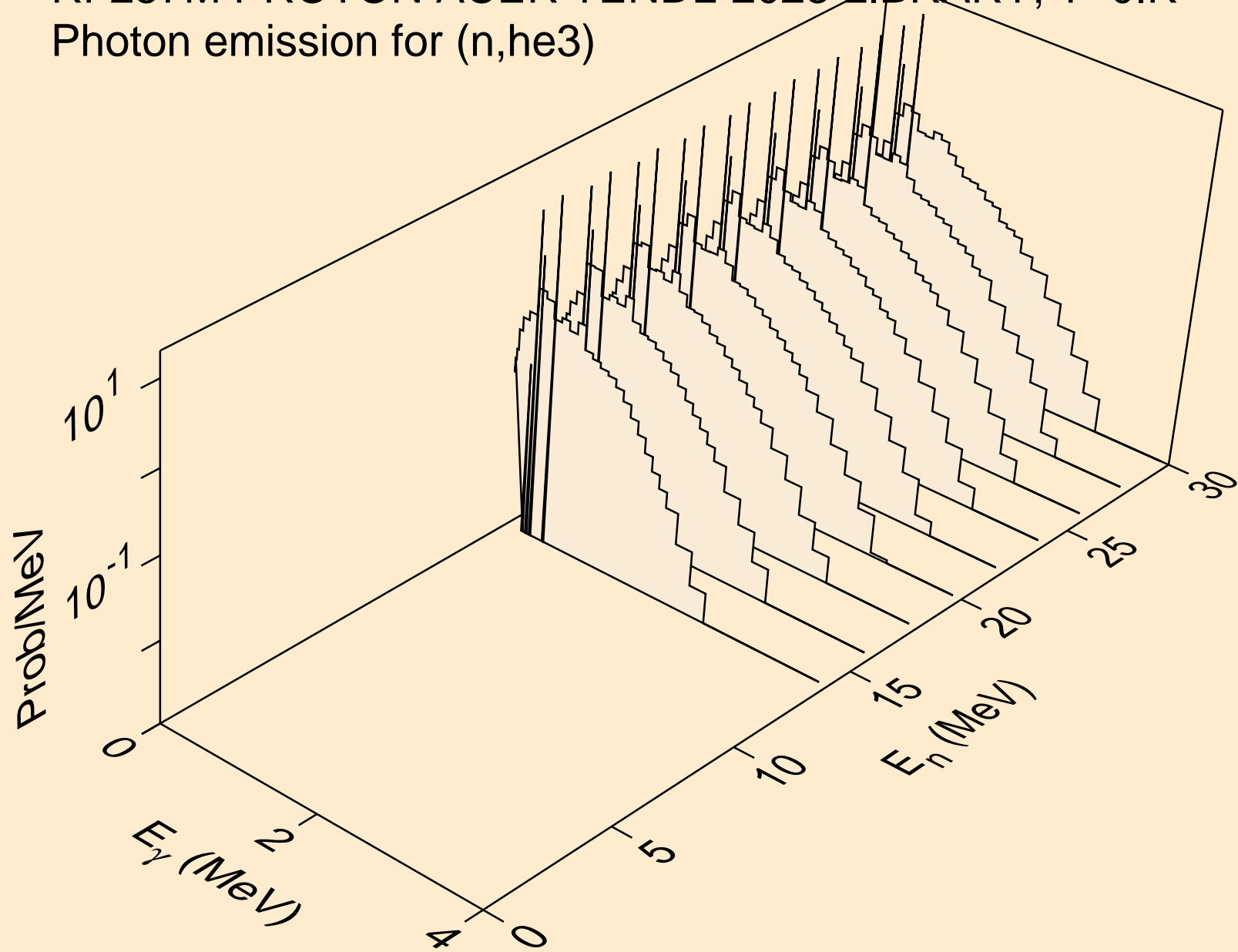



RF257M PROTON ACER TENDL-2023 LIBRARY; T=0.K  
Photon emission for (n,a)

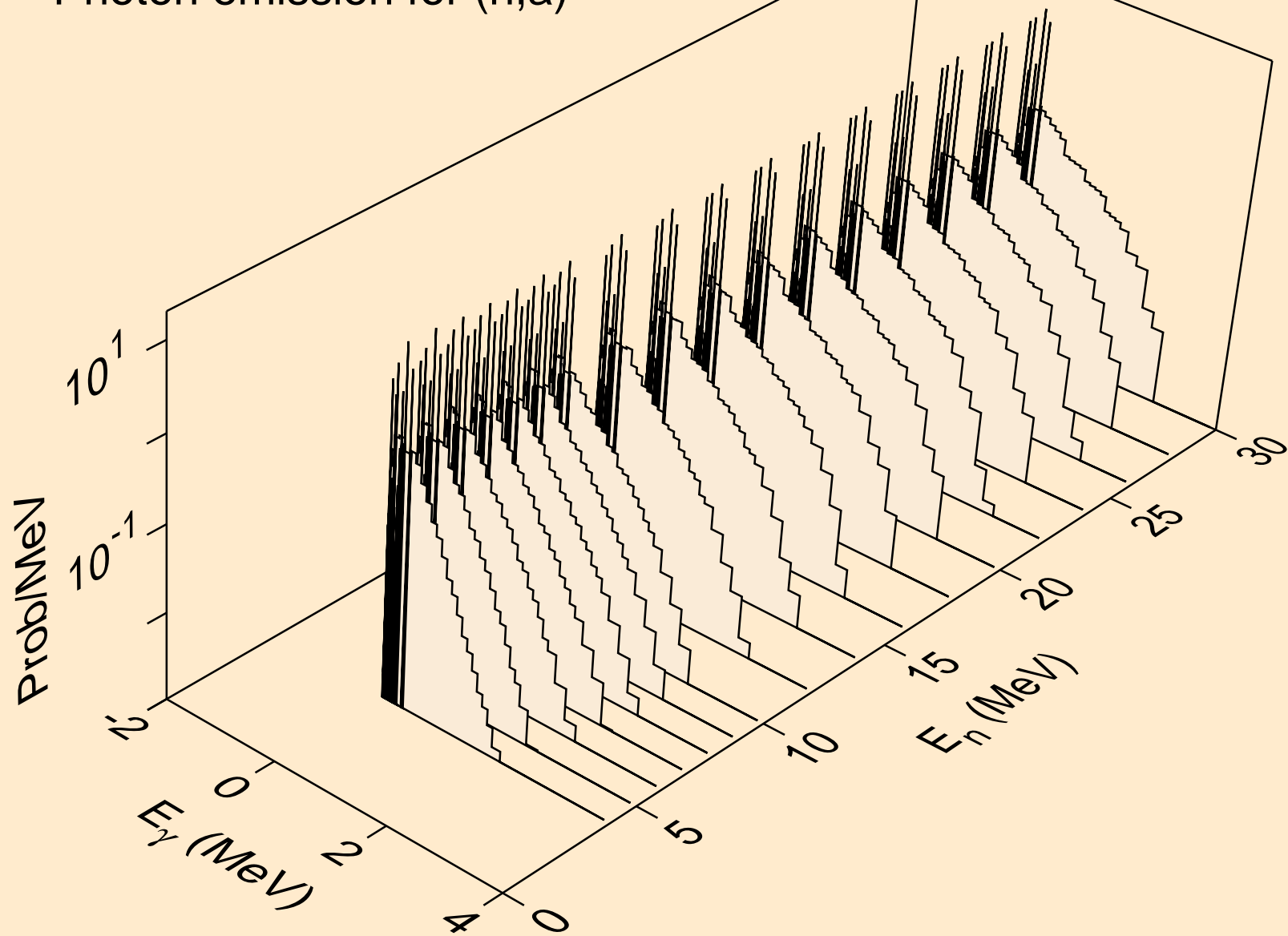

RF257M PROTON ACER TENDL-2023 LIBRARY; T=0.K  
Photon emission for (n,2a)

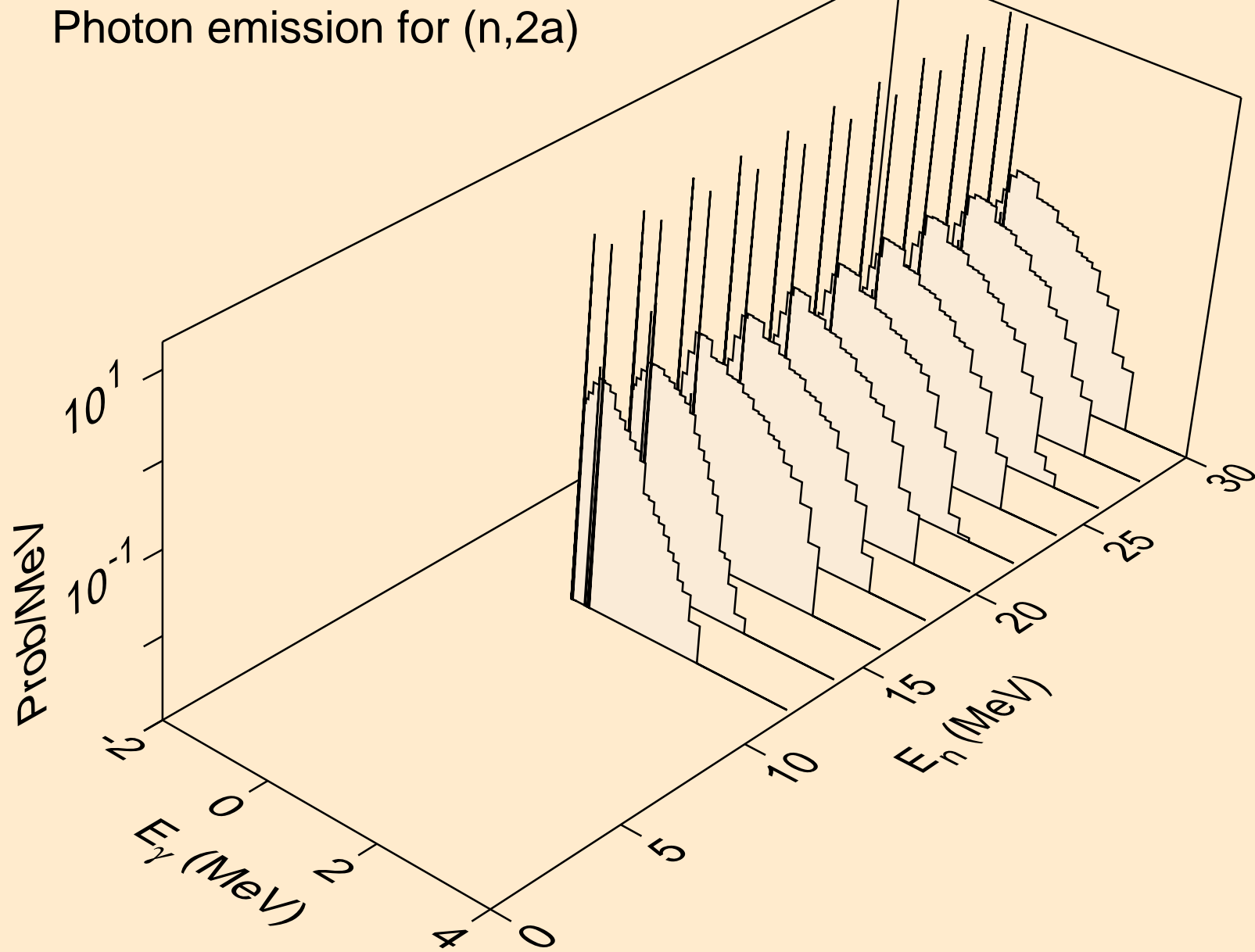

RF257M PROTON ACER TENDL-2023 LIBRARY; T=0.K  
Photon emission for (n,2p)

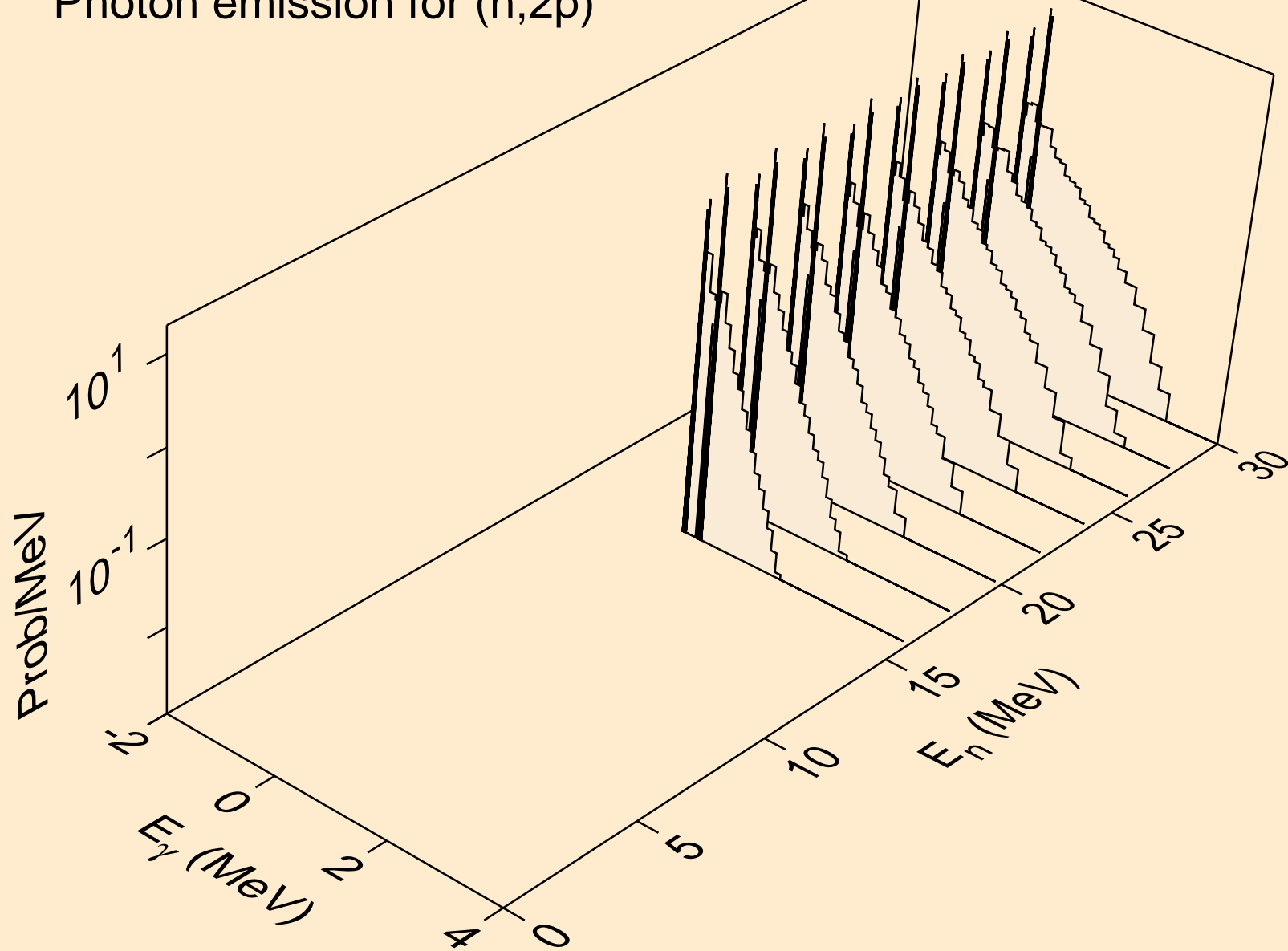

RF257M PROTON ACER TENDL-2023 LIBRARY; T=0.K  
Photon emission for (n,pa)

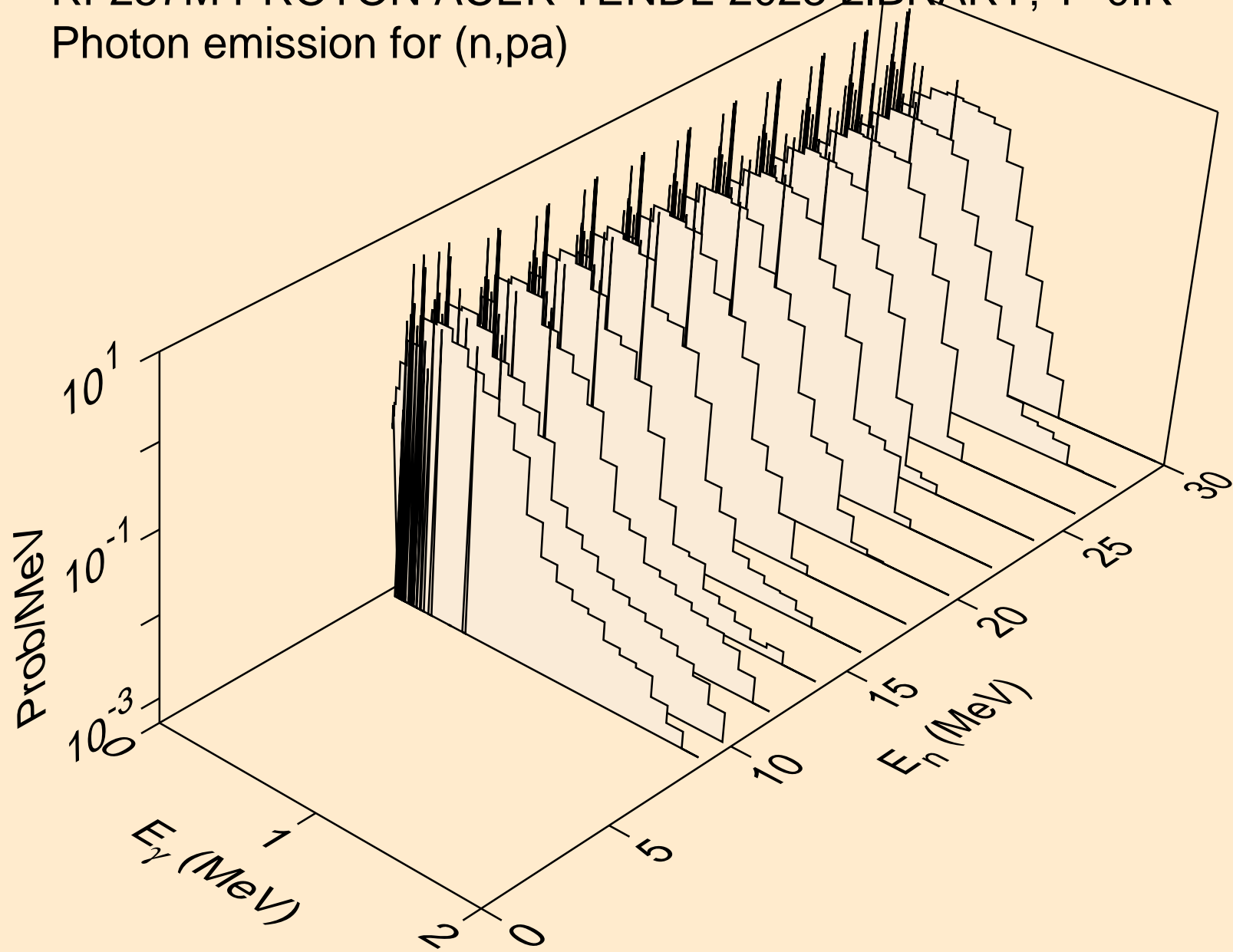

RF257M PROTON ACER TENDL-2023 LIBRARY; T=0.K  
Photon emission for (n,da)

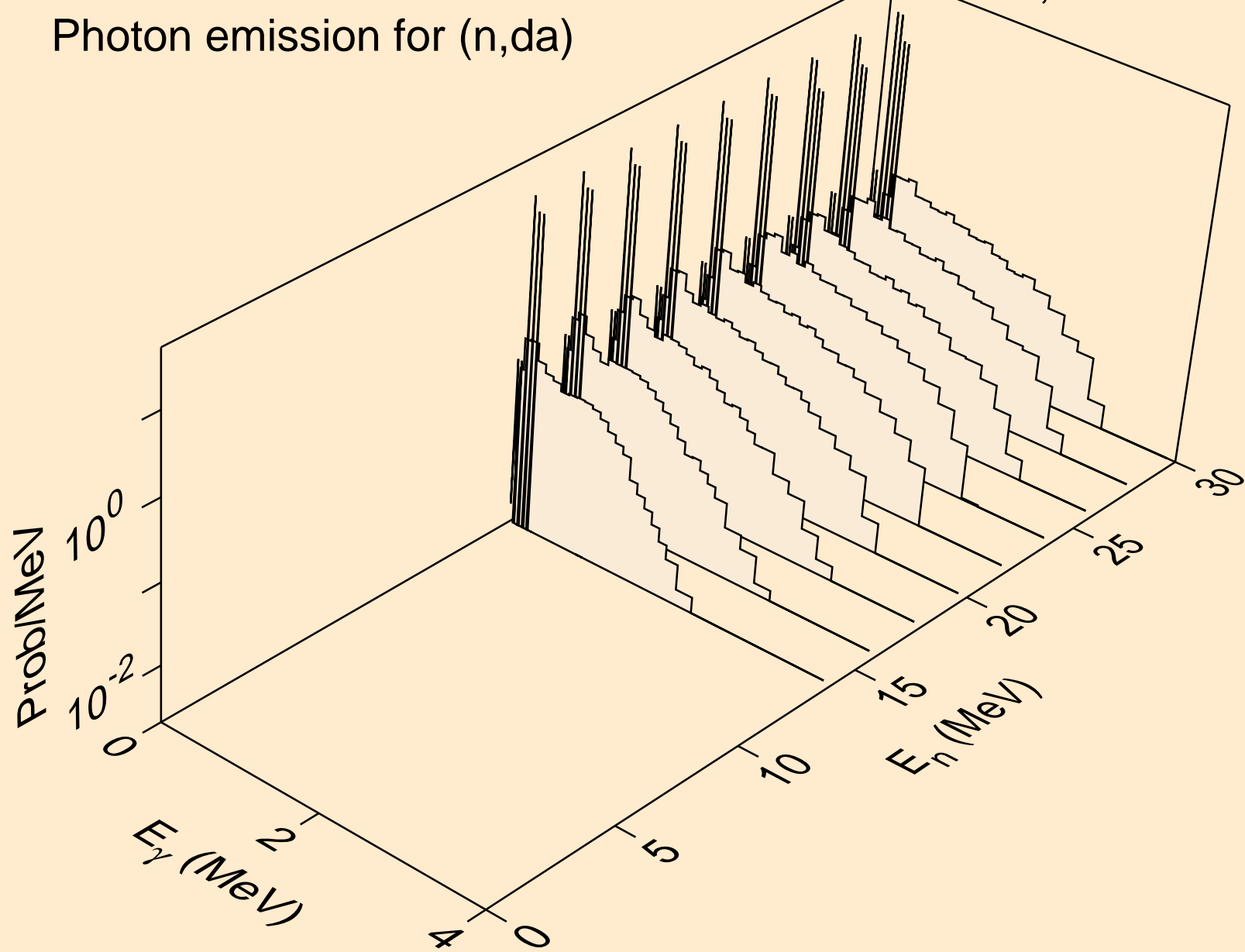

RF257M PROTON ACER TENDL-2023 LIBRARY; T=0.K  
Particle heating contributions

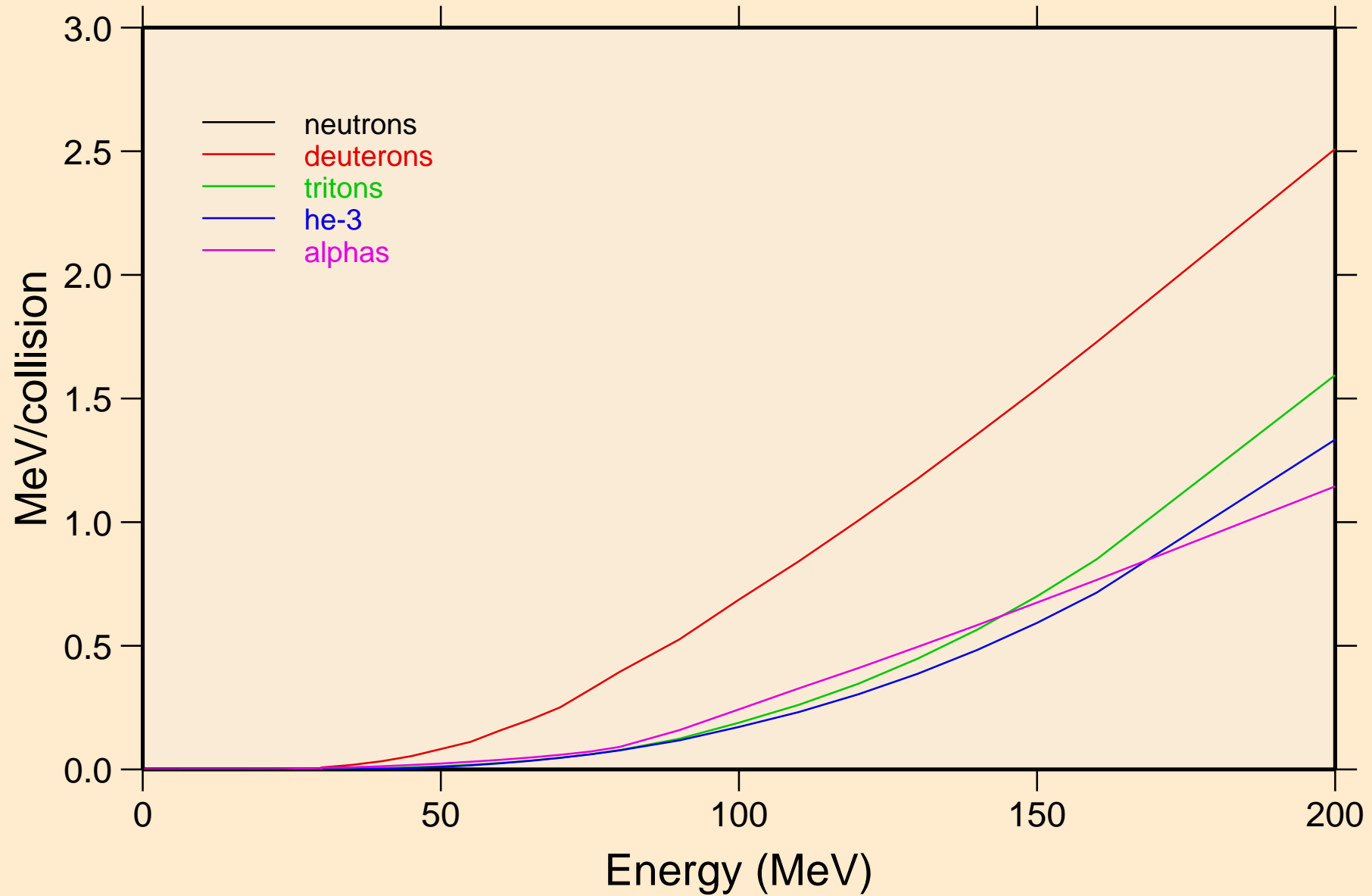

RF257M PROTON ACER TENDL-2023 LIBRARY; T=0.K  
Recoil Heating

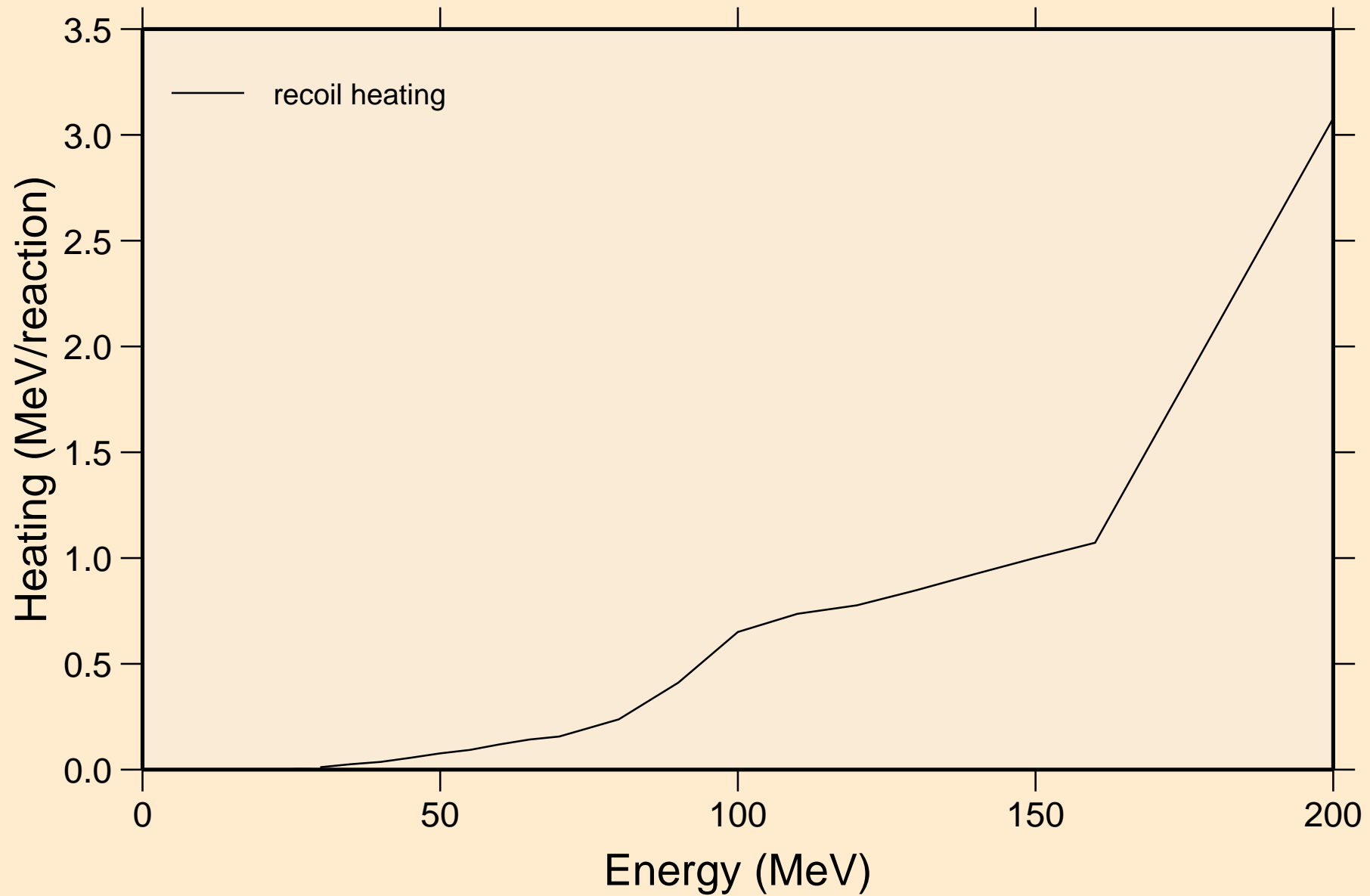

RF257M PROTON ACER TENDL-2023 LIBRARY; T=0.K  
Particle production cross sections

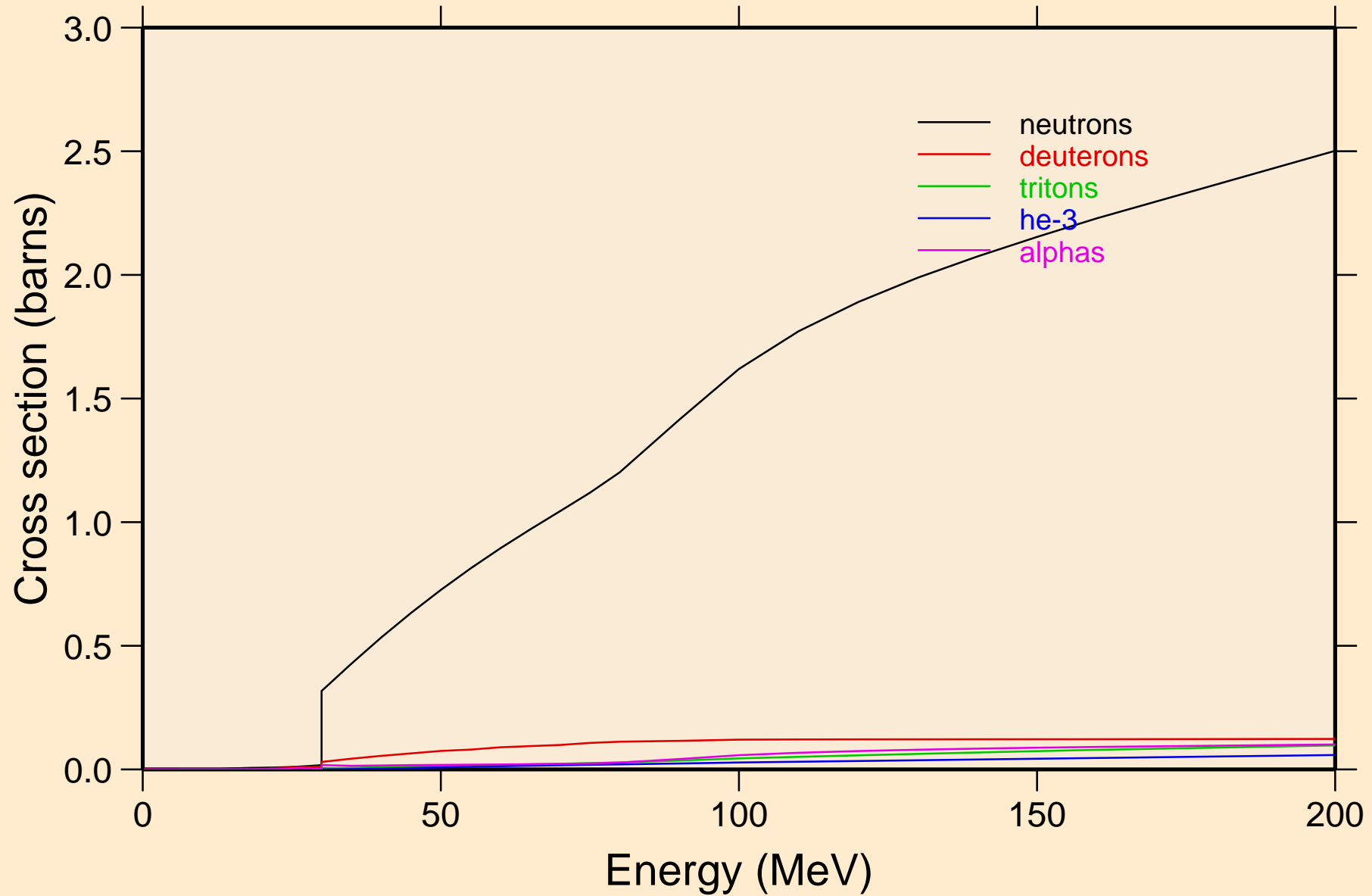



RF257M PROTON ACER TENDL-2023 LIBRARY; T=0.K  
neutrons from (p,n)

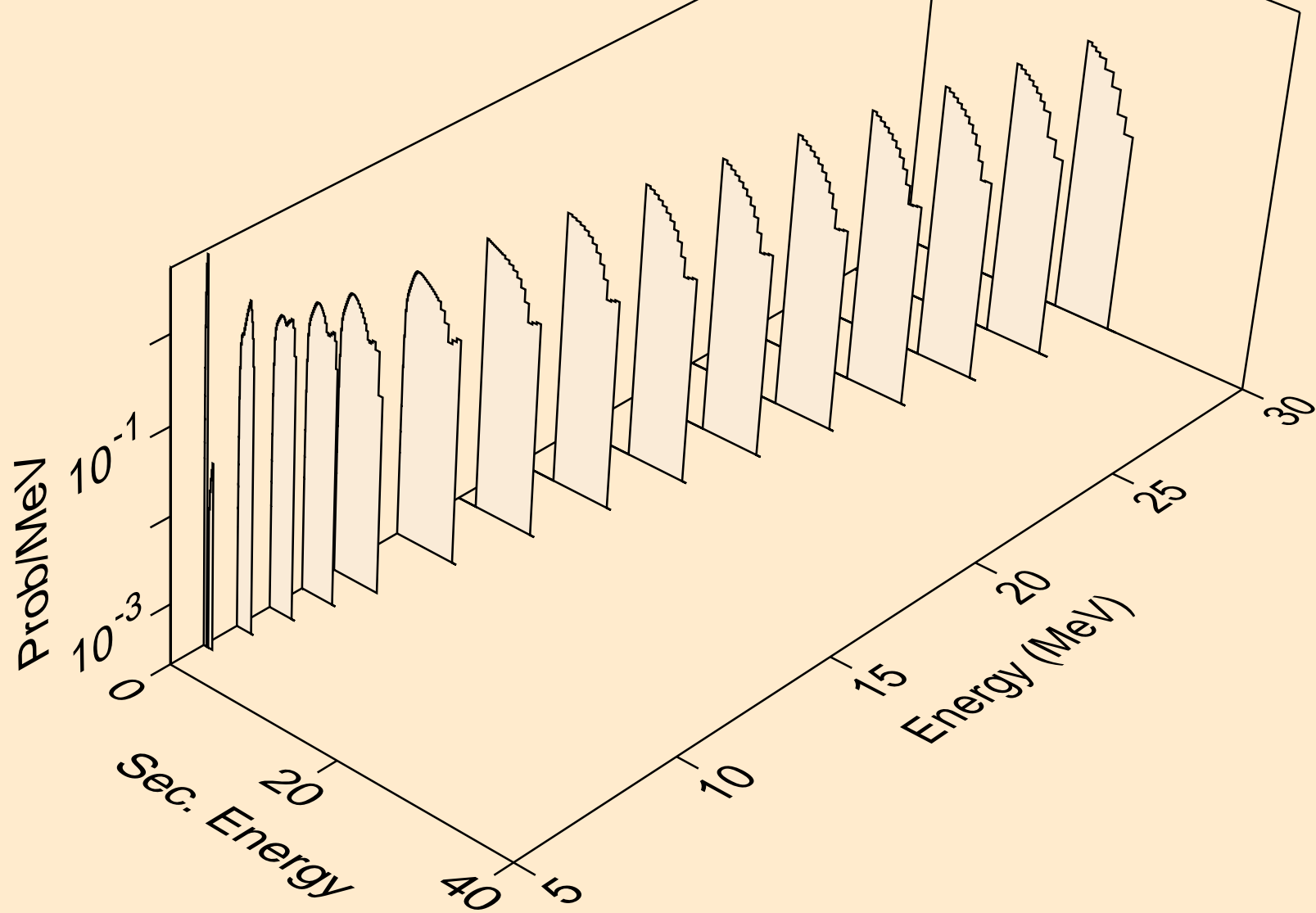

RF257M PROTON ACER TENDL-2023 LIBRARY; T=0.K  
neutrons from (p,x)

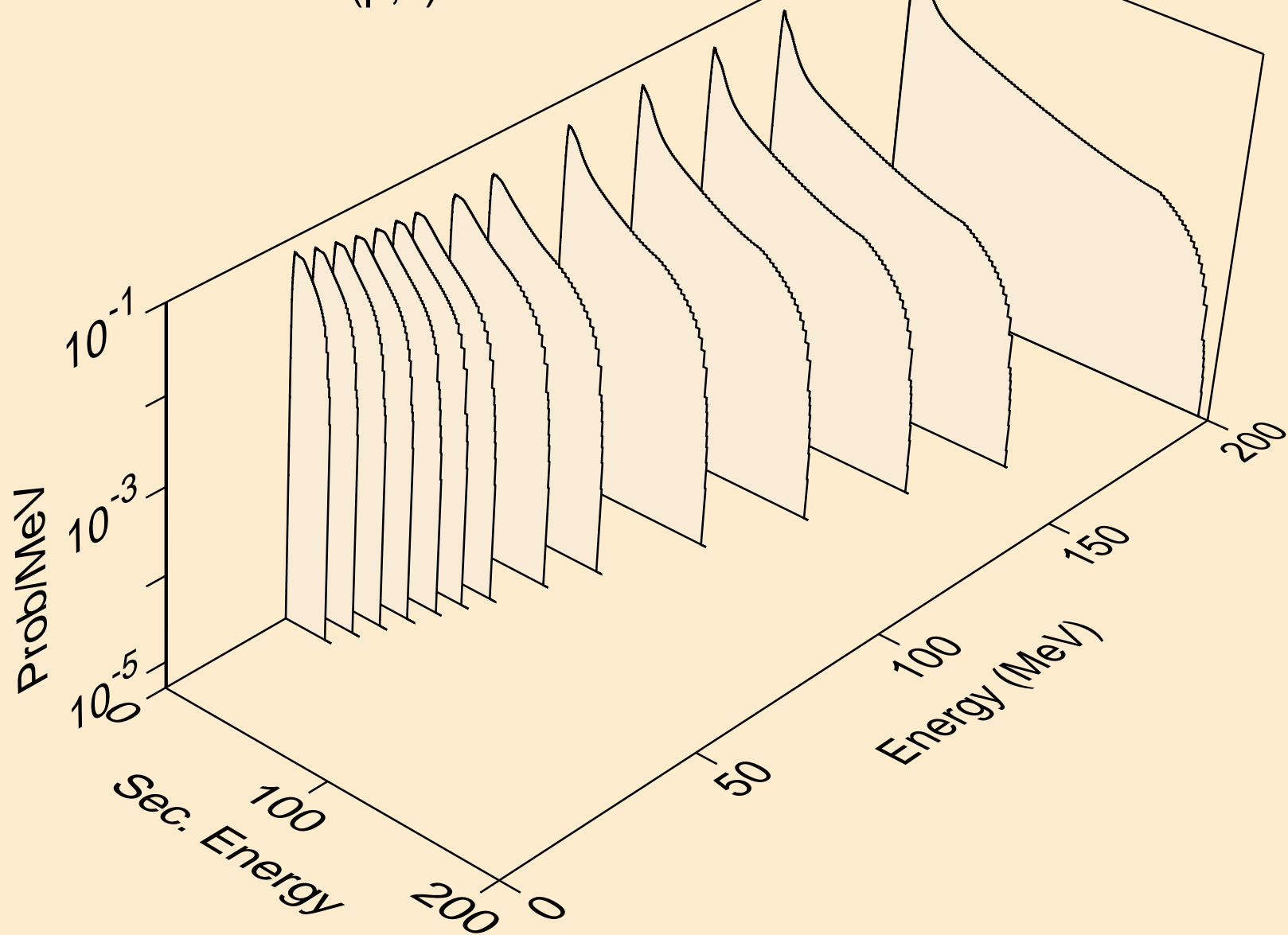

RF257M PROTON ACER TENDL-2023 LIBRARY; T=0.K  
neutrons from (p,2n)

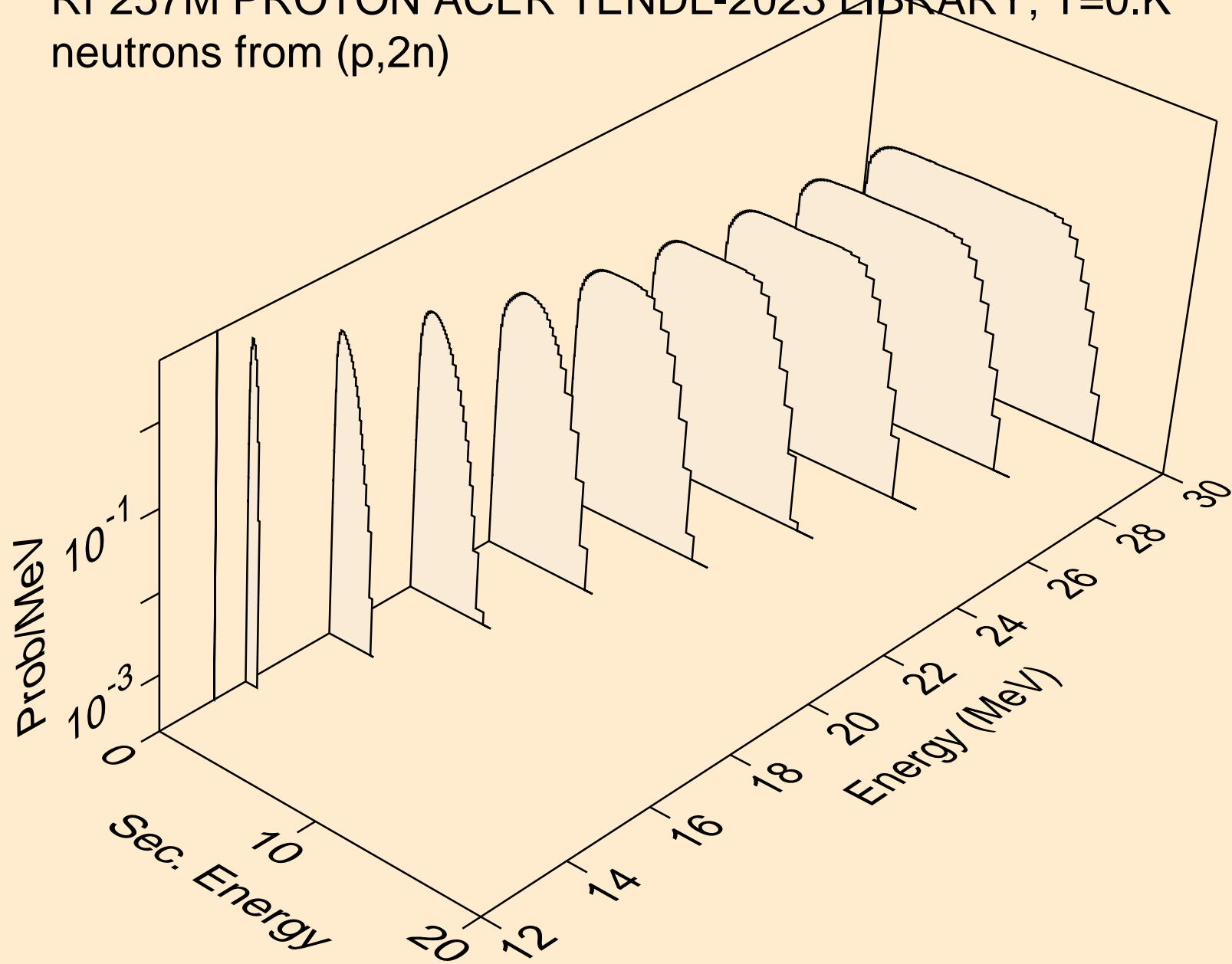

RF257M PROTON ACER TENDL-2023 LIBRARY; T=0.K  
neutrons from (p,3n)

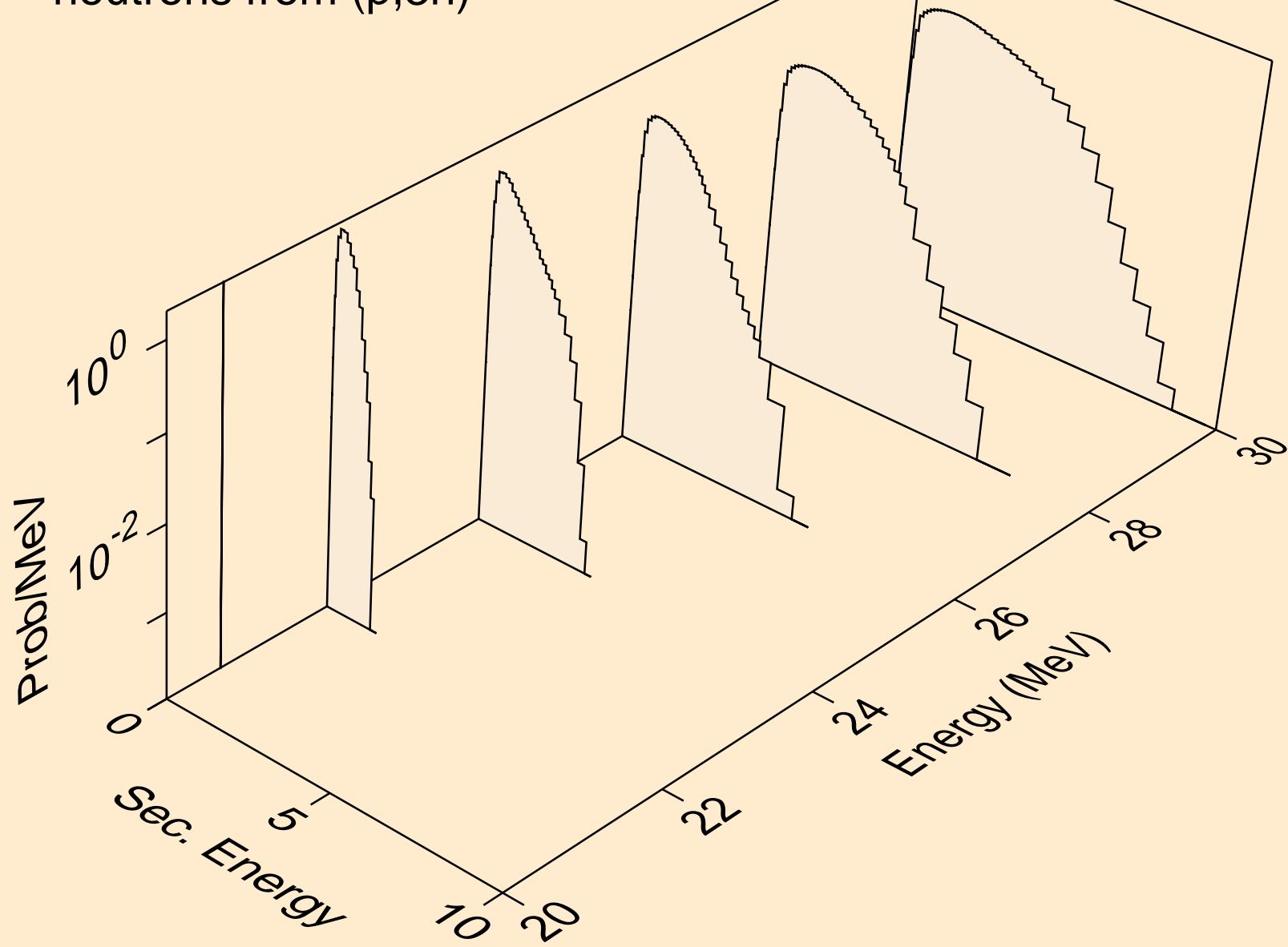

RF257M PROTON ACER TENDL-2023 LIBRARY; T=0.K  
neutrons from (p,n\*)a

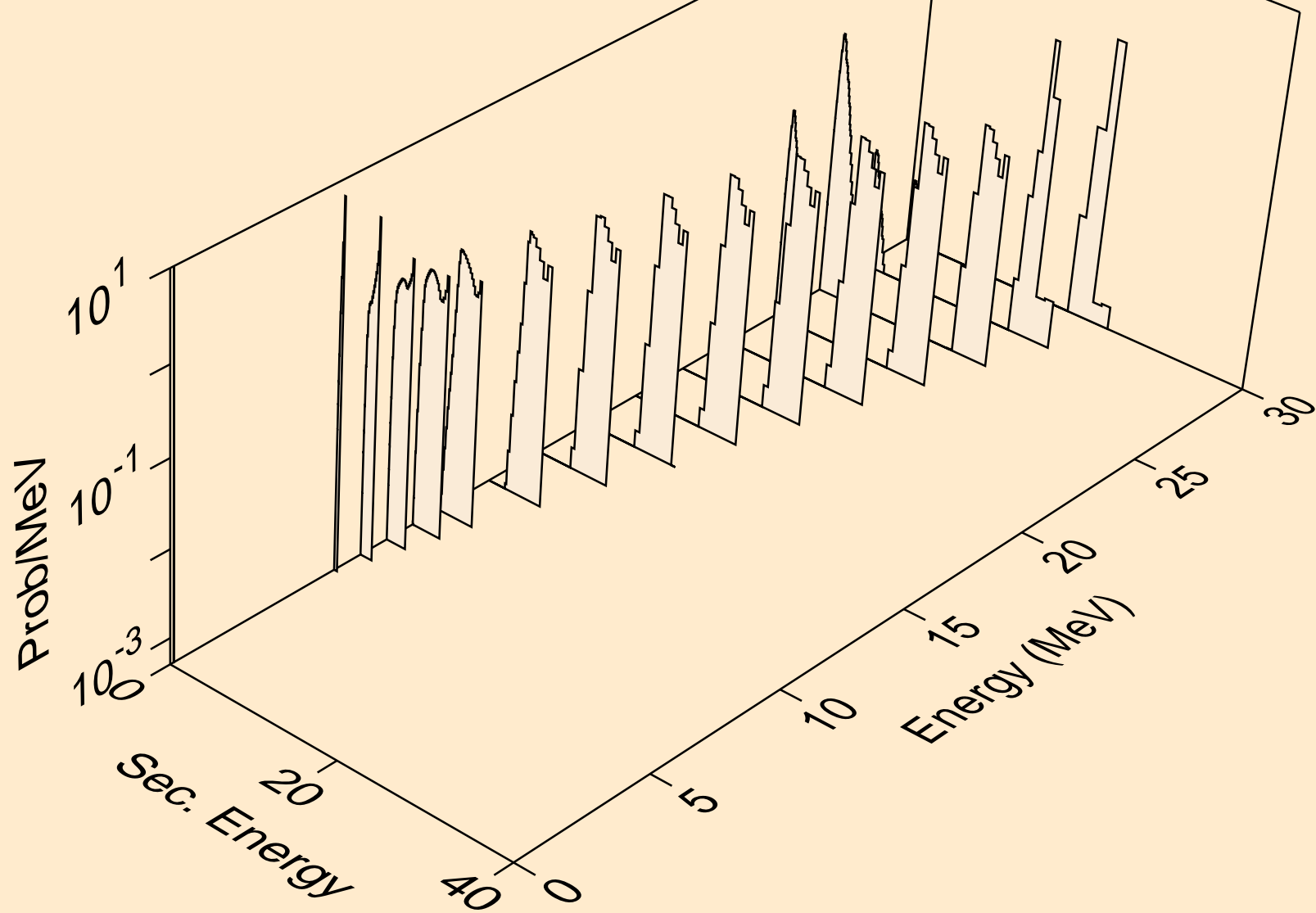

RF257M PROTON ACER TENDL-2023 LIBRARY; T=0.K  
neutrons from (p,2n)a

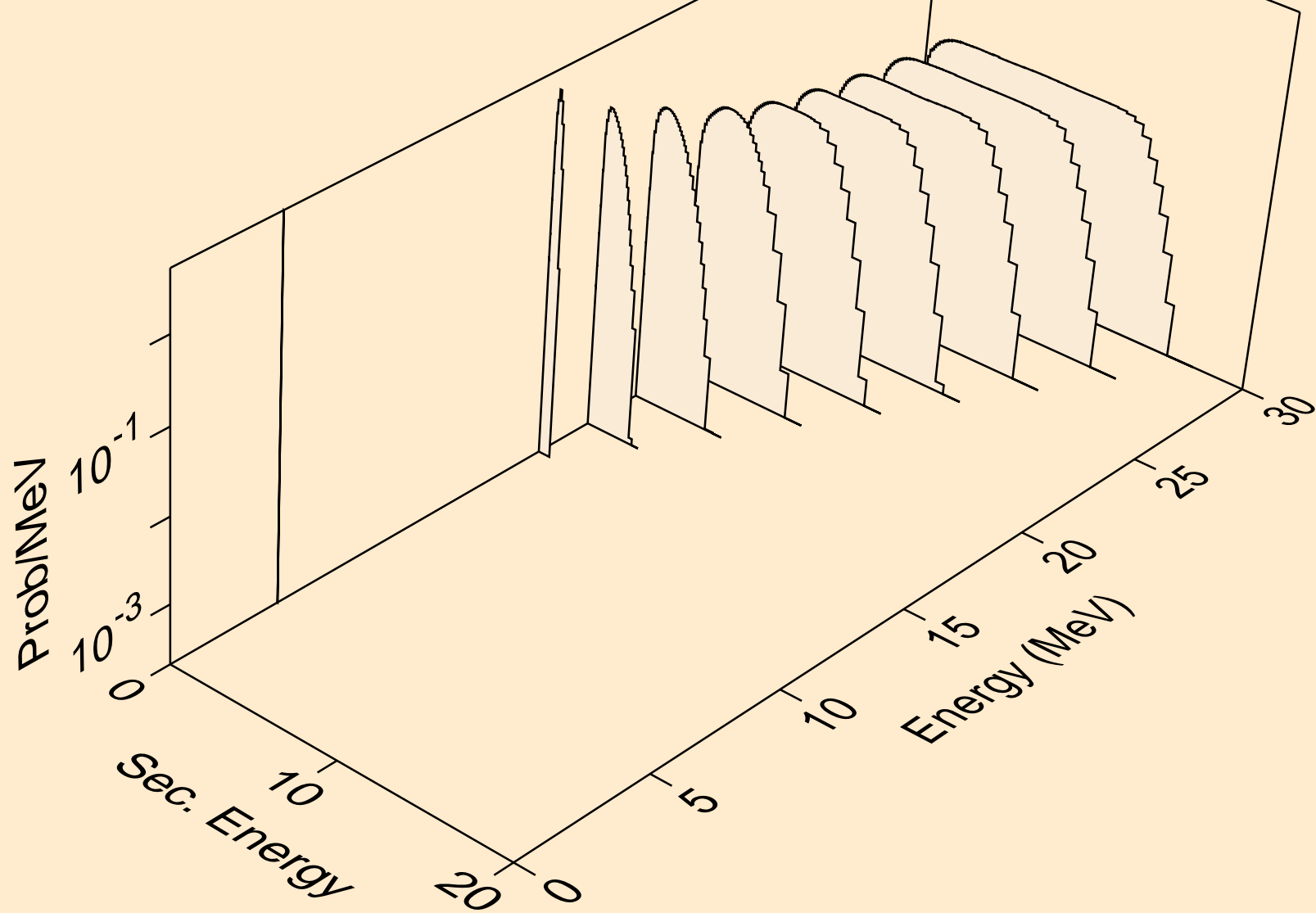

RF257M PROTON ACER TENDL-2023 LIBRARY; T=0.K  
neutrons from (p,n\*)p

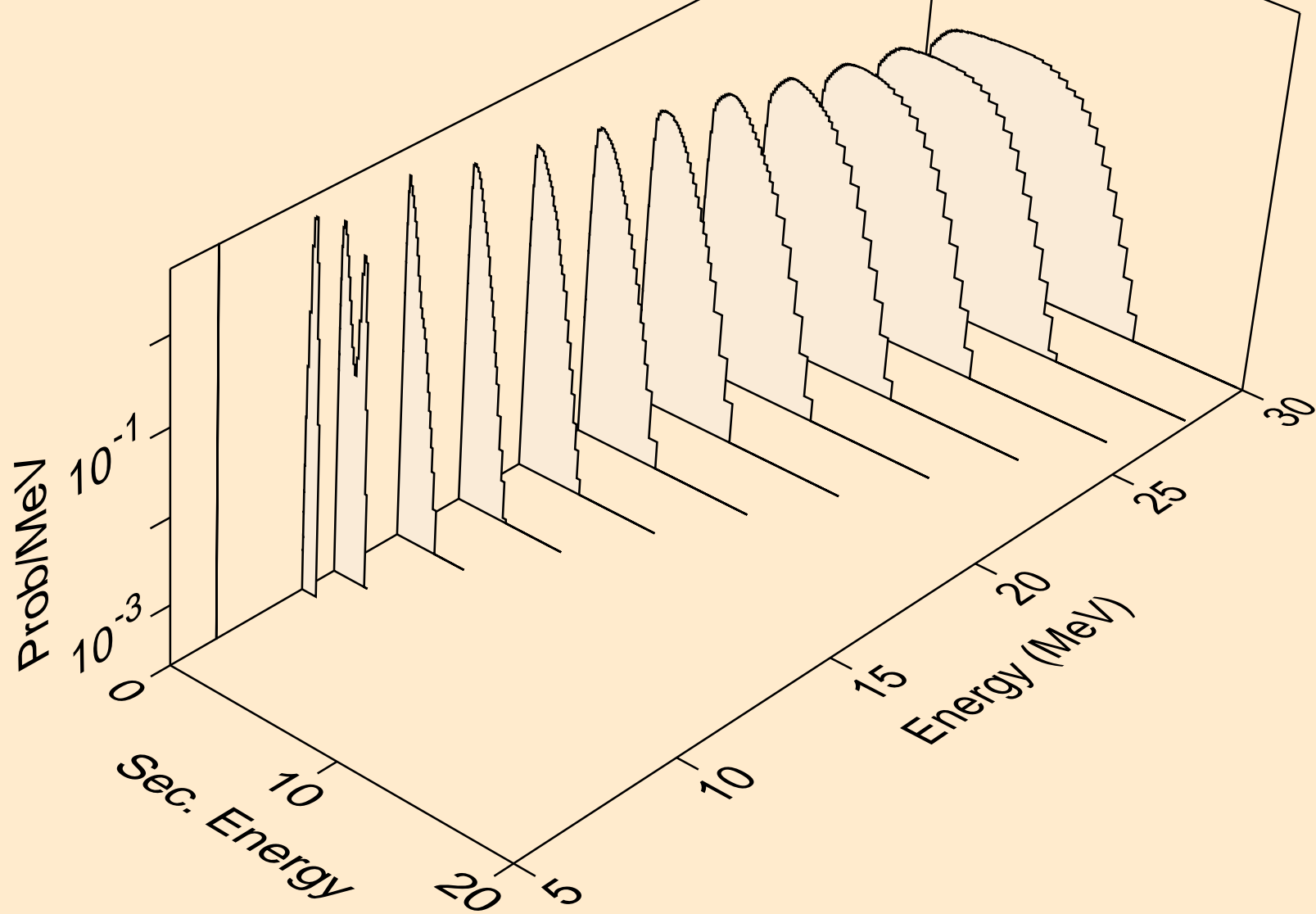

RF257M PROTON ACER TENDL-2023 LIBRARY; T=0.K  
neutrons from (p,n\*)d

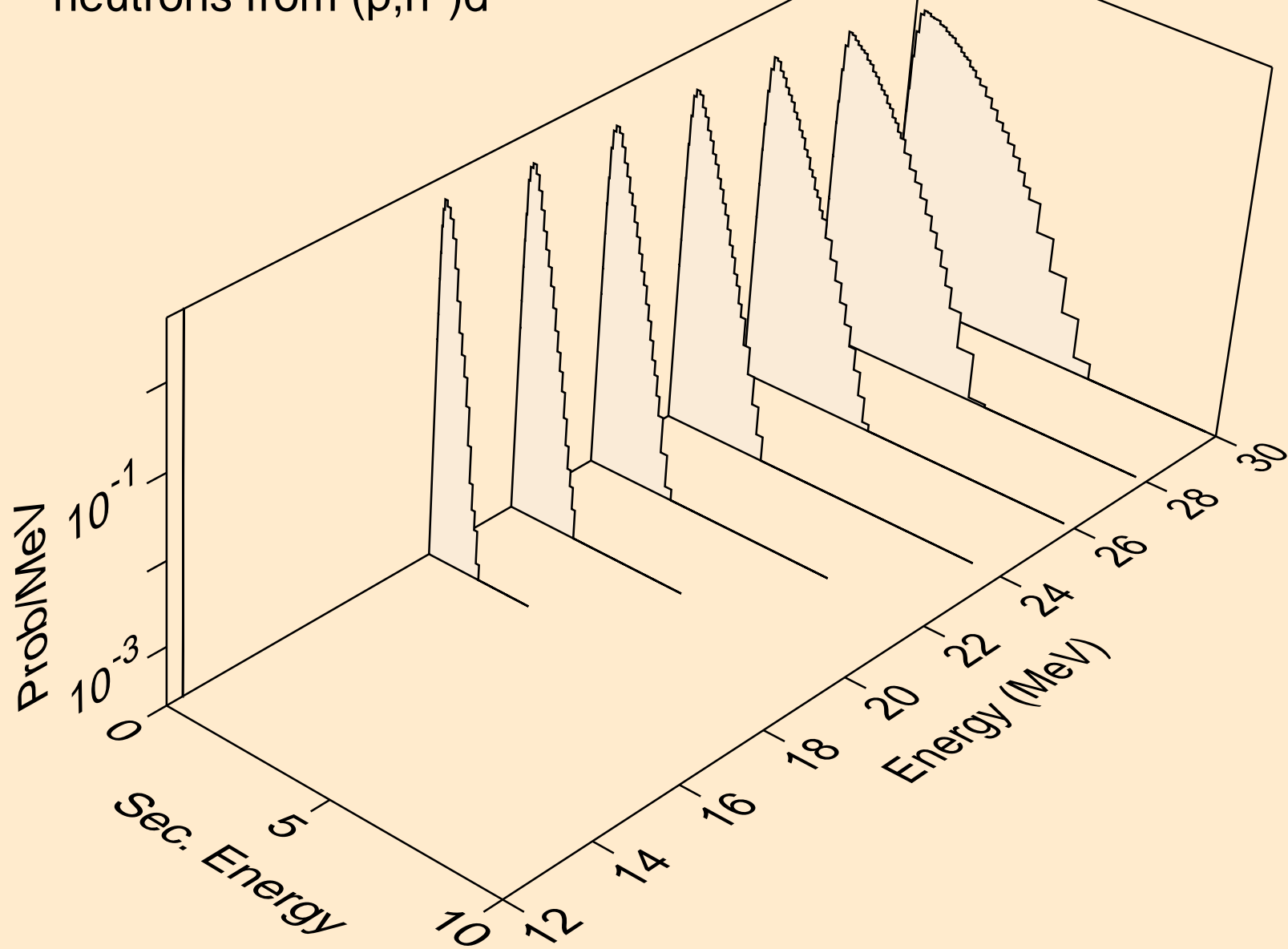



RF257M PROTON ACER TENDL-2023 LIBRARY; T=0.K  
neutrons from (p,n\*)t

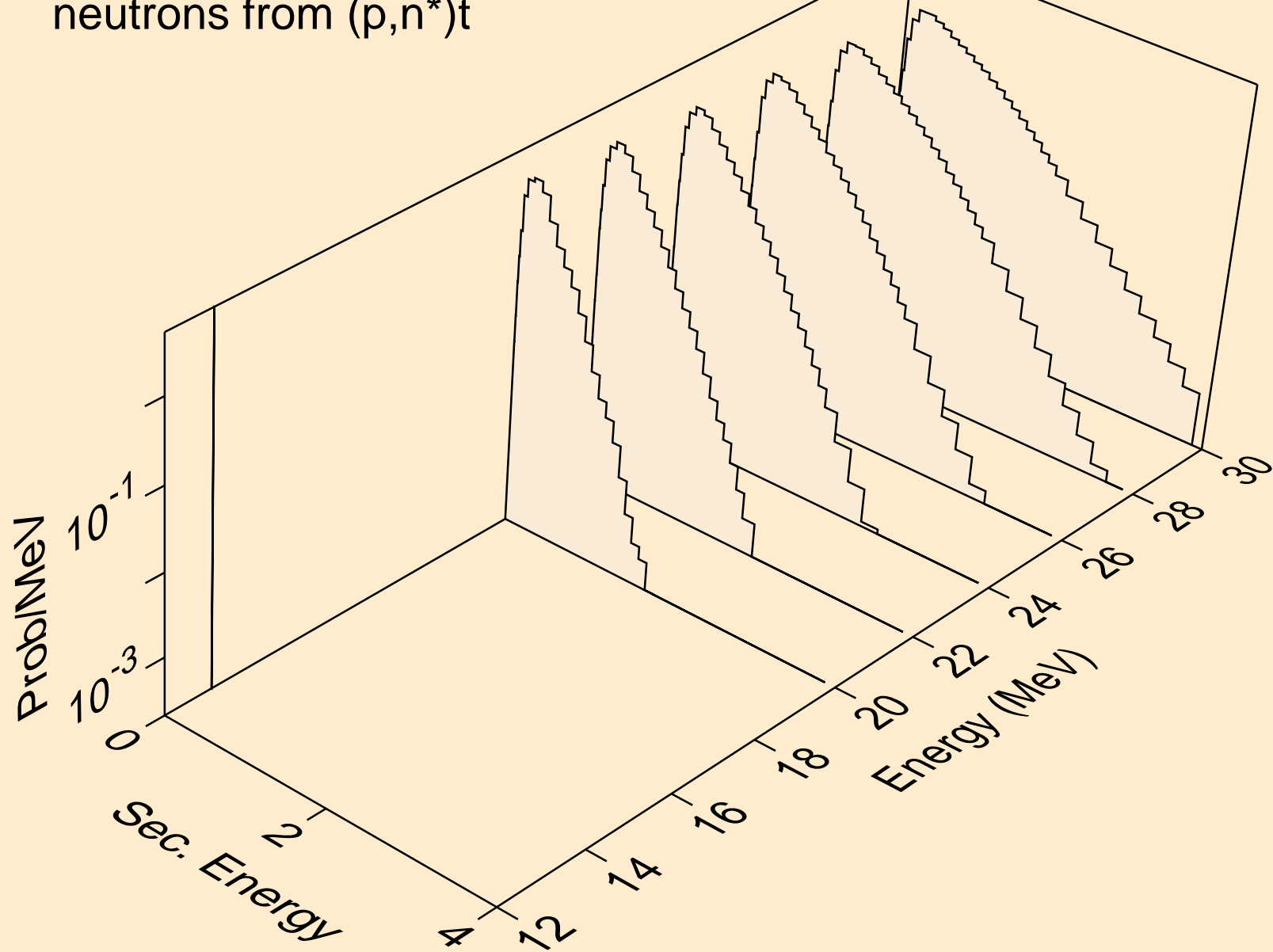

RF257M PROTON ACER TENDL-2023 LIBRARY; T=0.K  
neutrons from (p,2np)

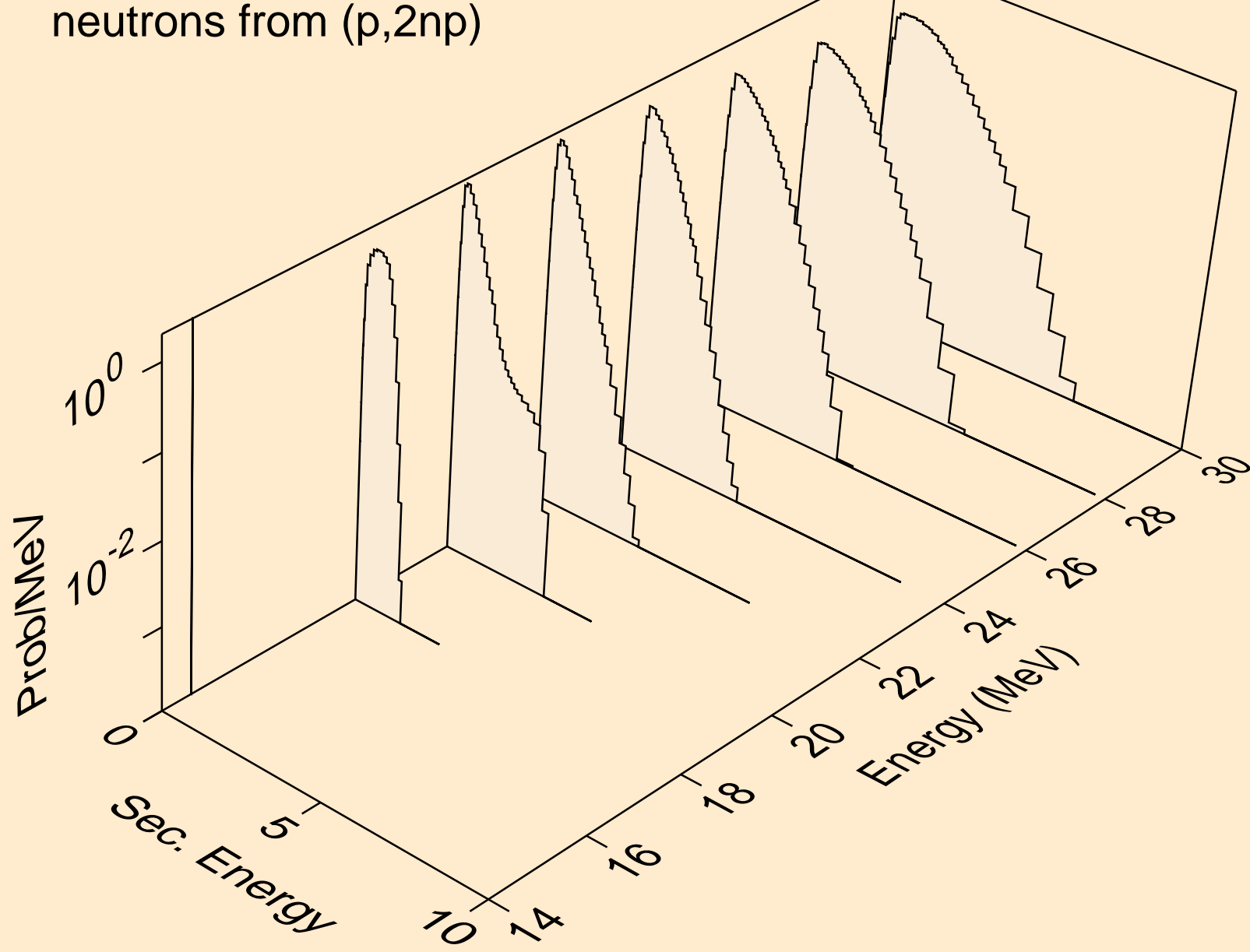

RF257M PROTON ACER TENDL-2023 LIBRARY; T=0.K  
neutrons from (p,npa)

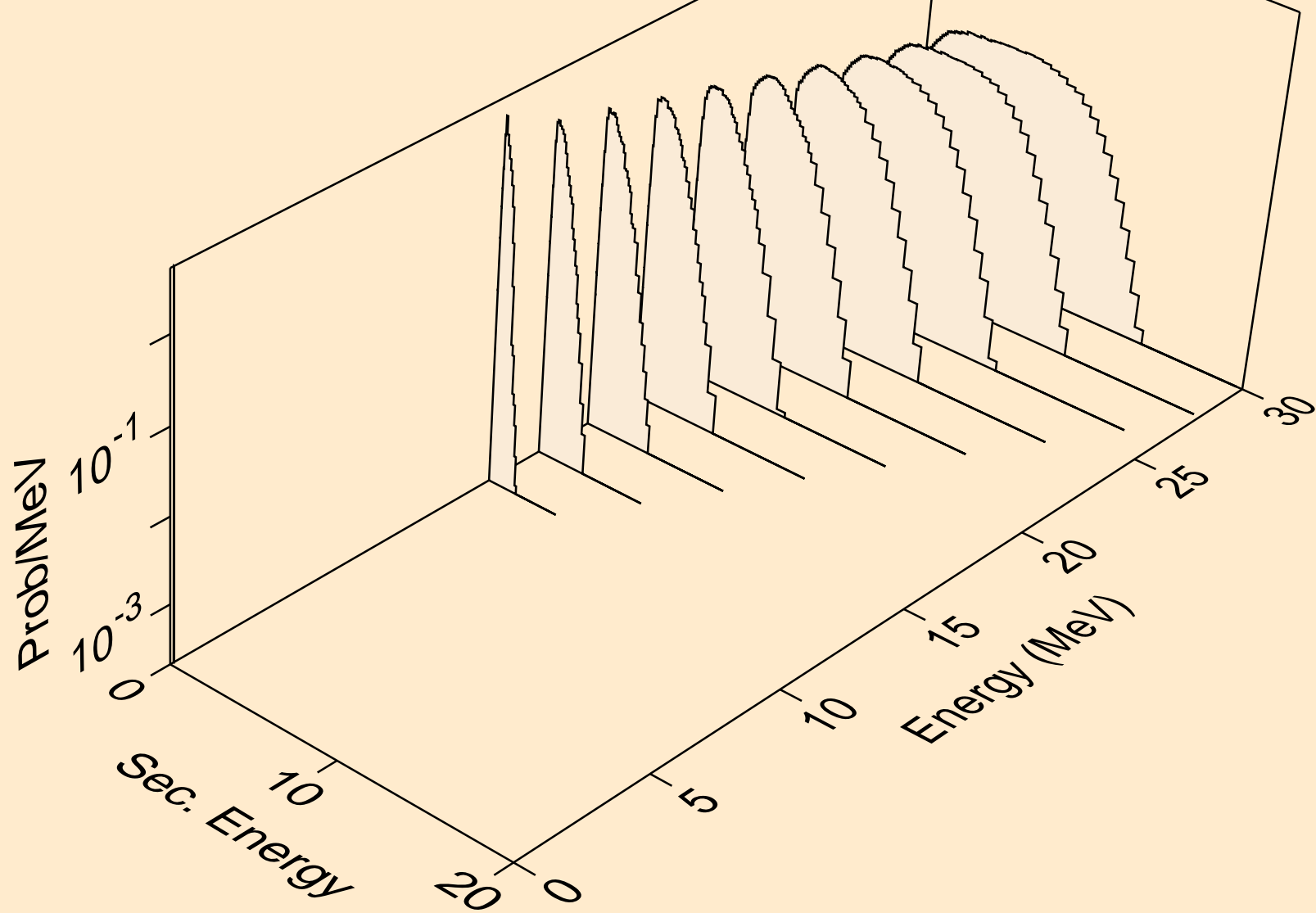

RF257M PROTON ACER TENDL-2023 LIBRARY; T=0.K  
deuterons from (p,x)

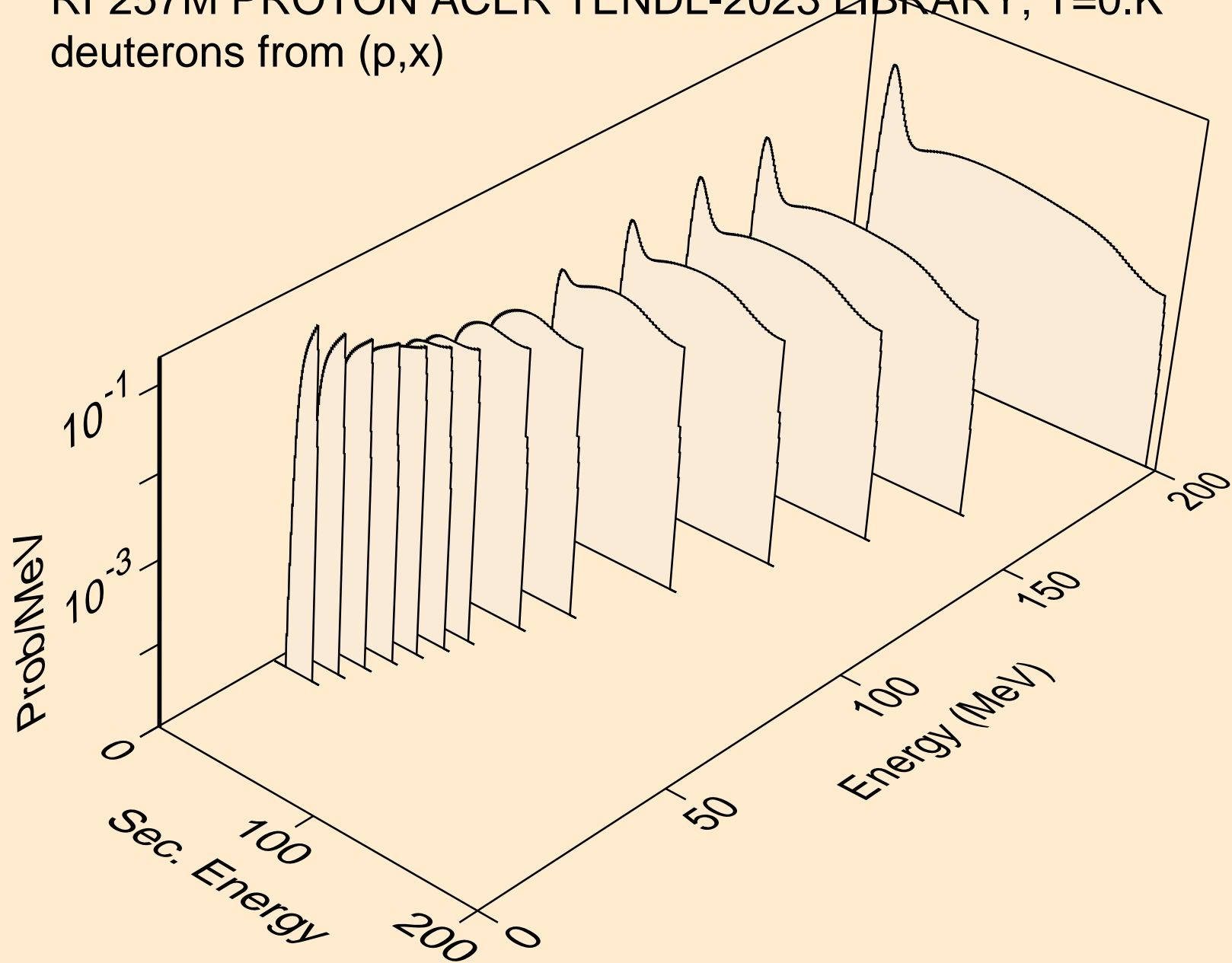

RF257M PROTON ACER TENDL-2023 LIBRARY; T=0.K  
deuterons from (p,n\*)d

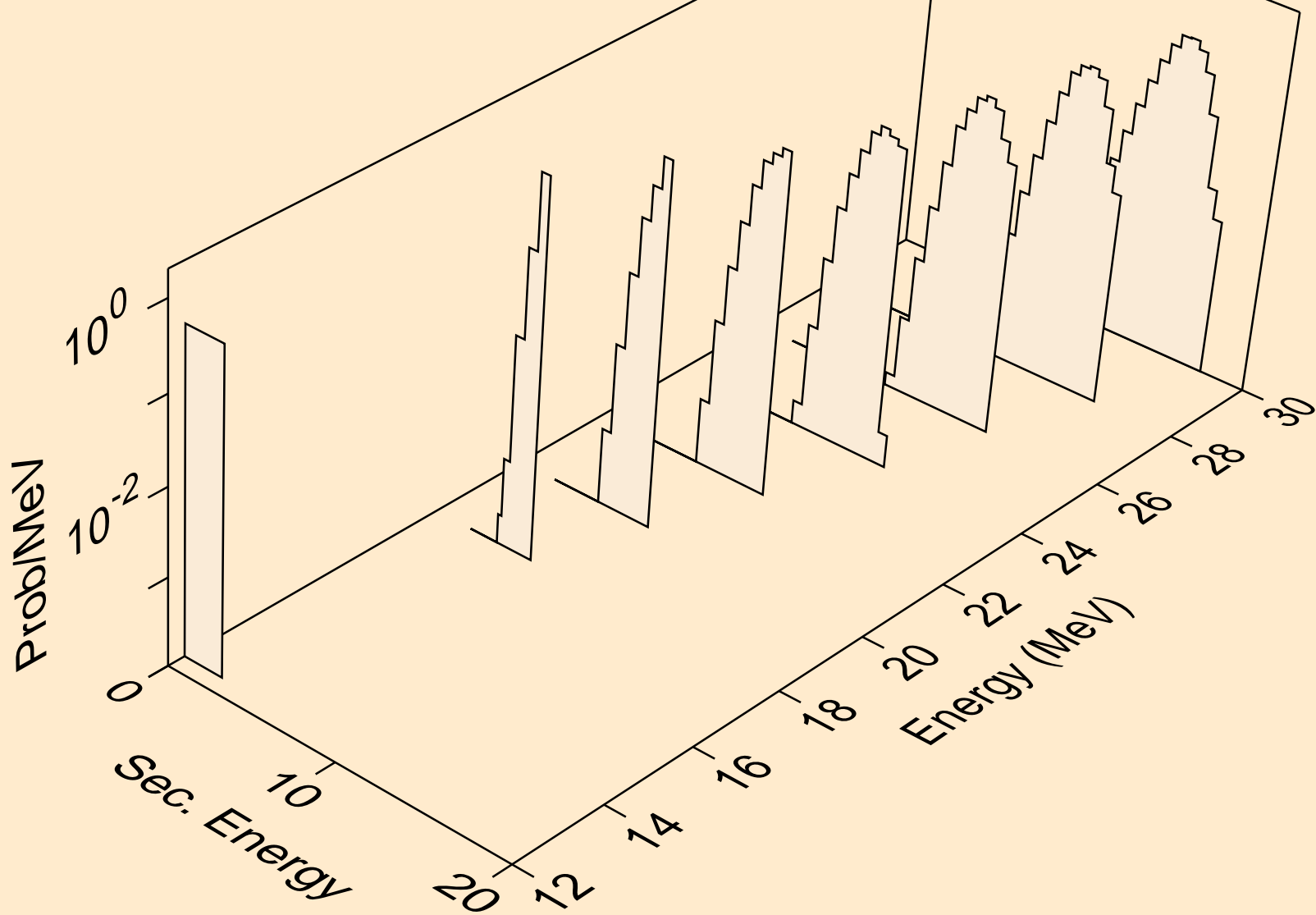

RF257M PROTON ACER TENDL-2023 LIBRARY; T=0.K  
deuterons from (p,d)

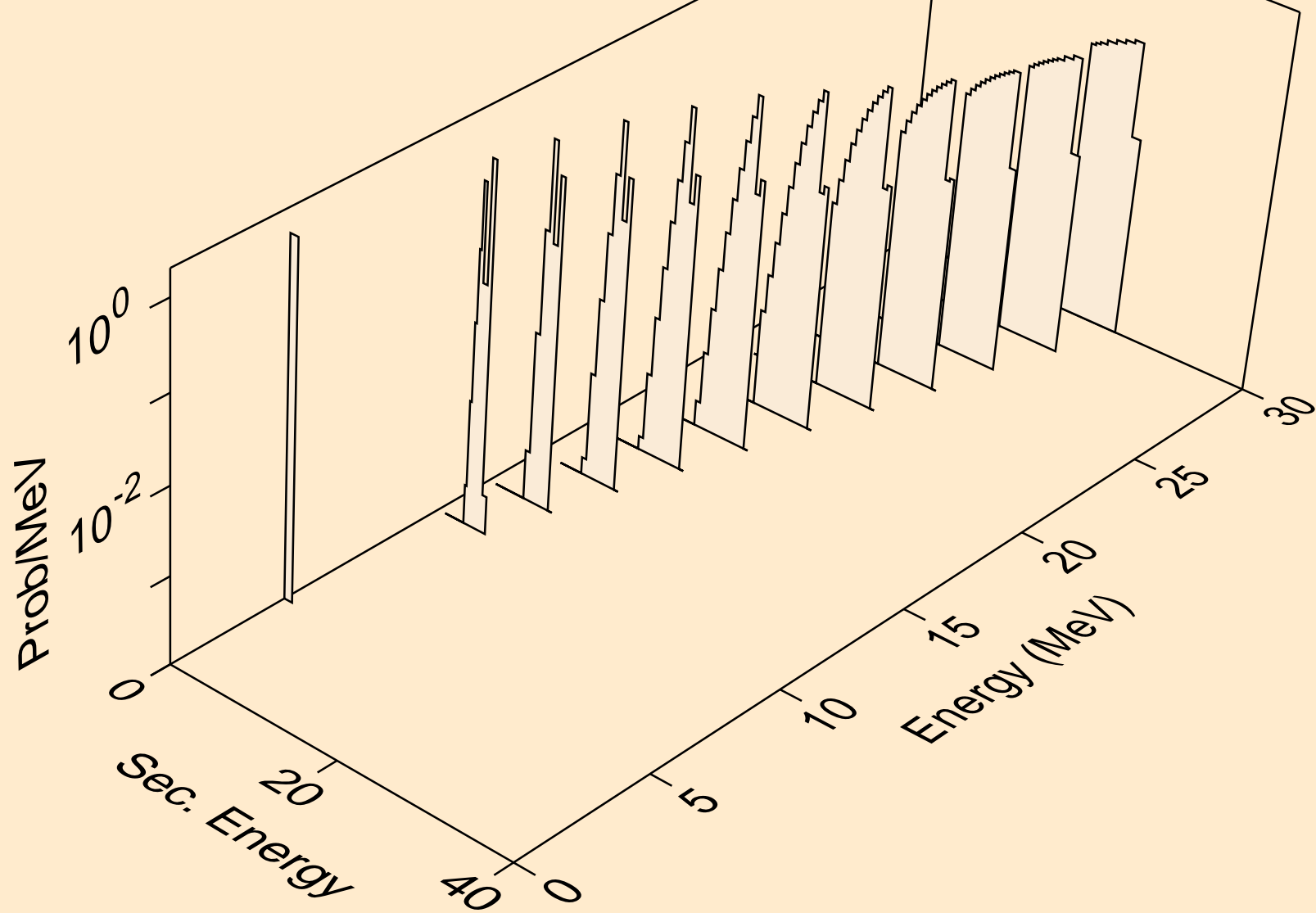

RF257M PROTON ACER TENDL-2023 LIBRARY; T=0.K  
deuterons from (p,da)

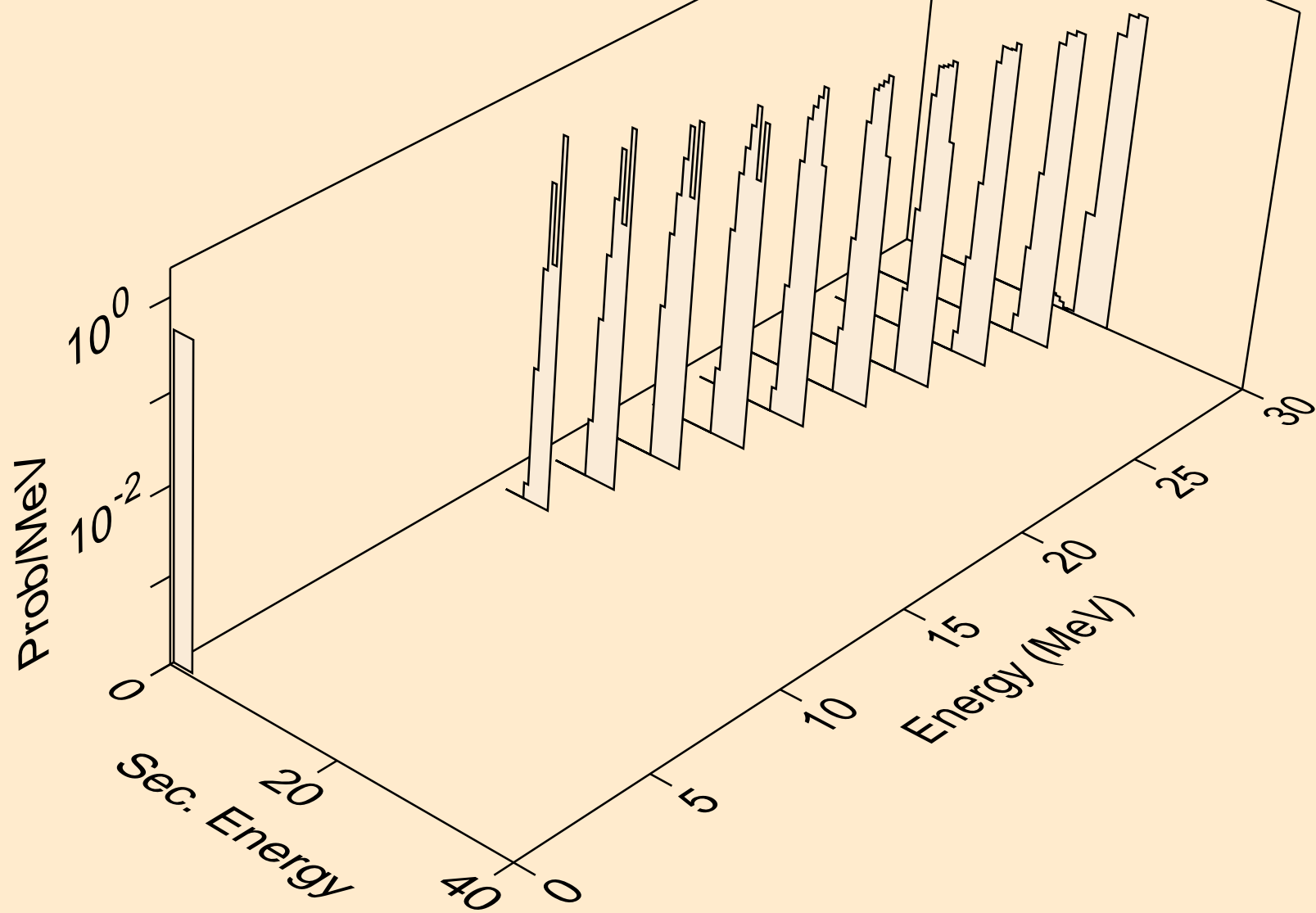

RF257M PROTON ACER TENDL-2023 LIBRARY; T=0.K  
tritons from (p,x)

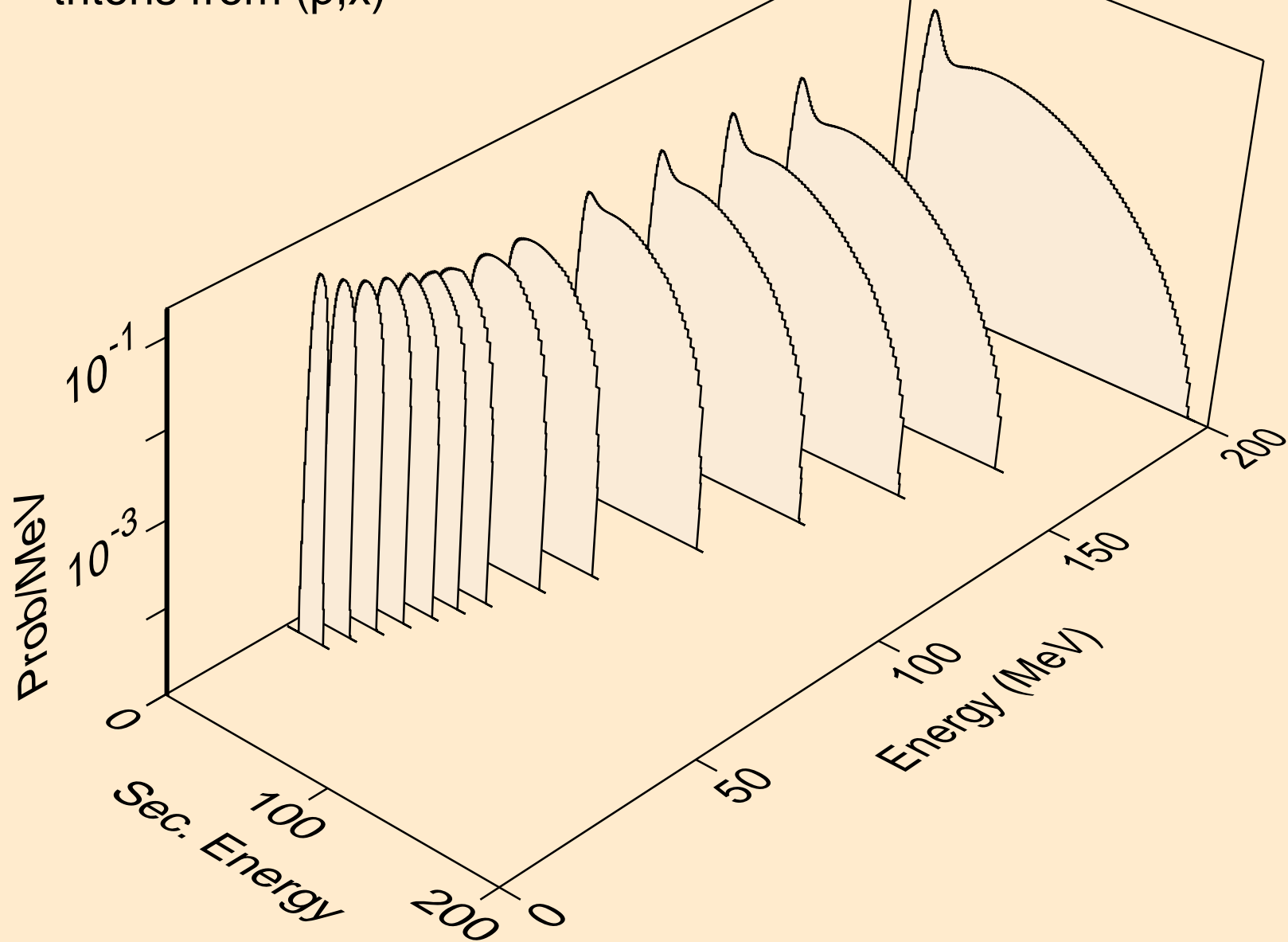



RF257M PROTON ACER TENDL-2023 LIBRARY; T=0.K  
tritons from (p,n\*)t

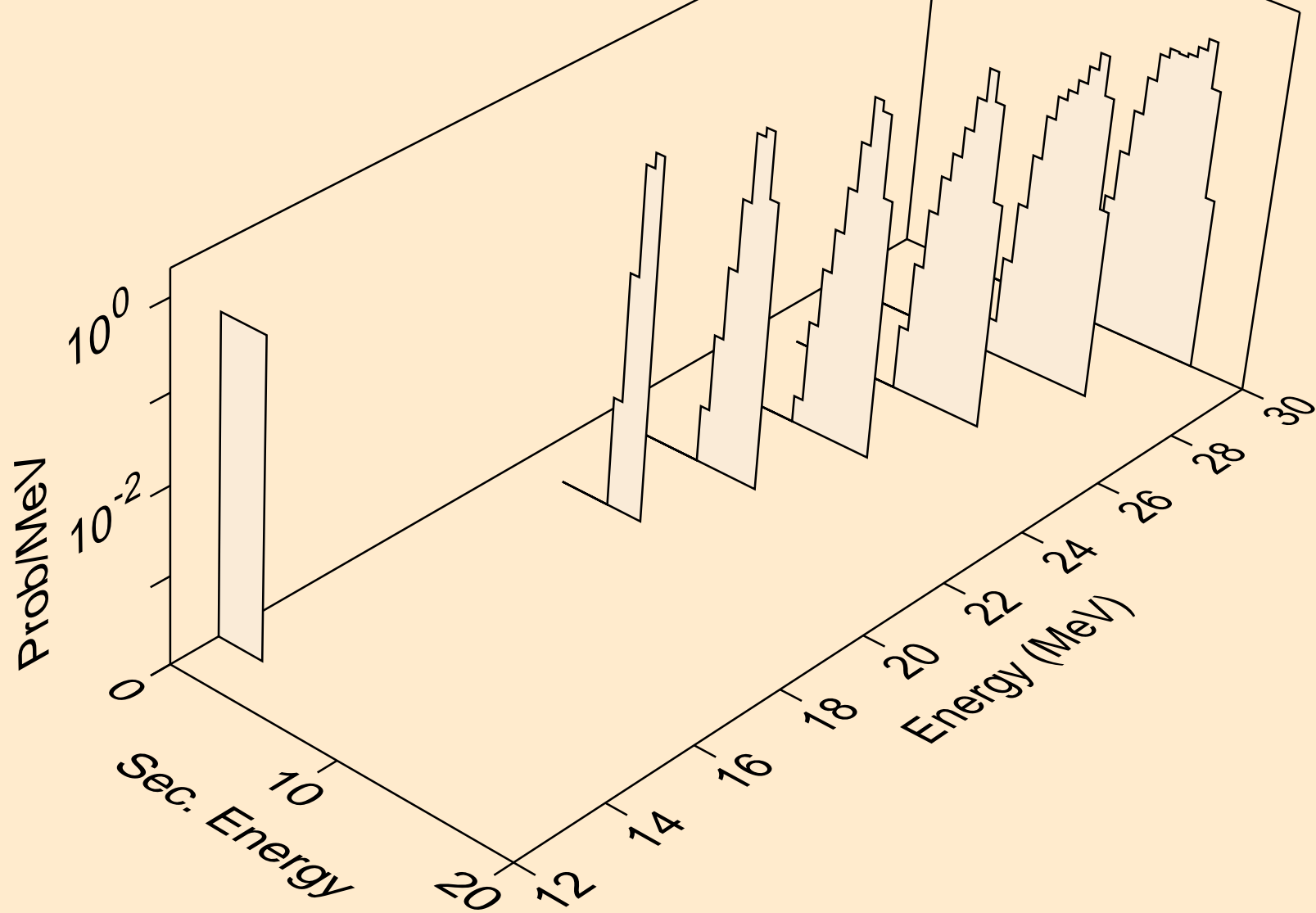

RF257M PROTON ACER TENDL-2023 LIBRARY; T=0.K  
tritons from (p,t)

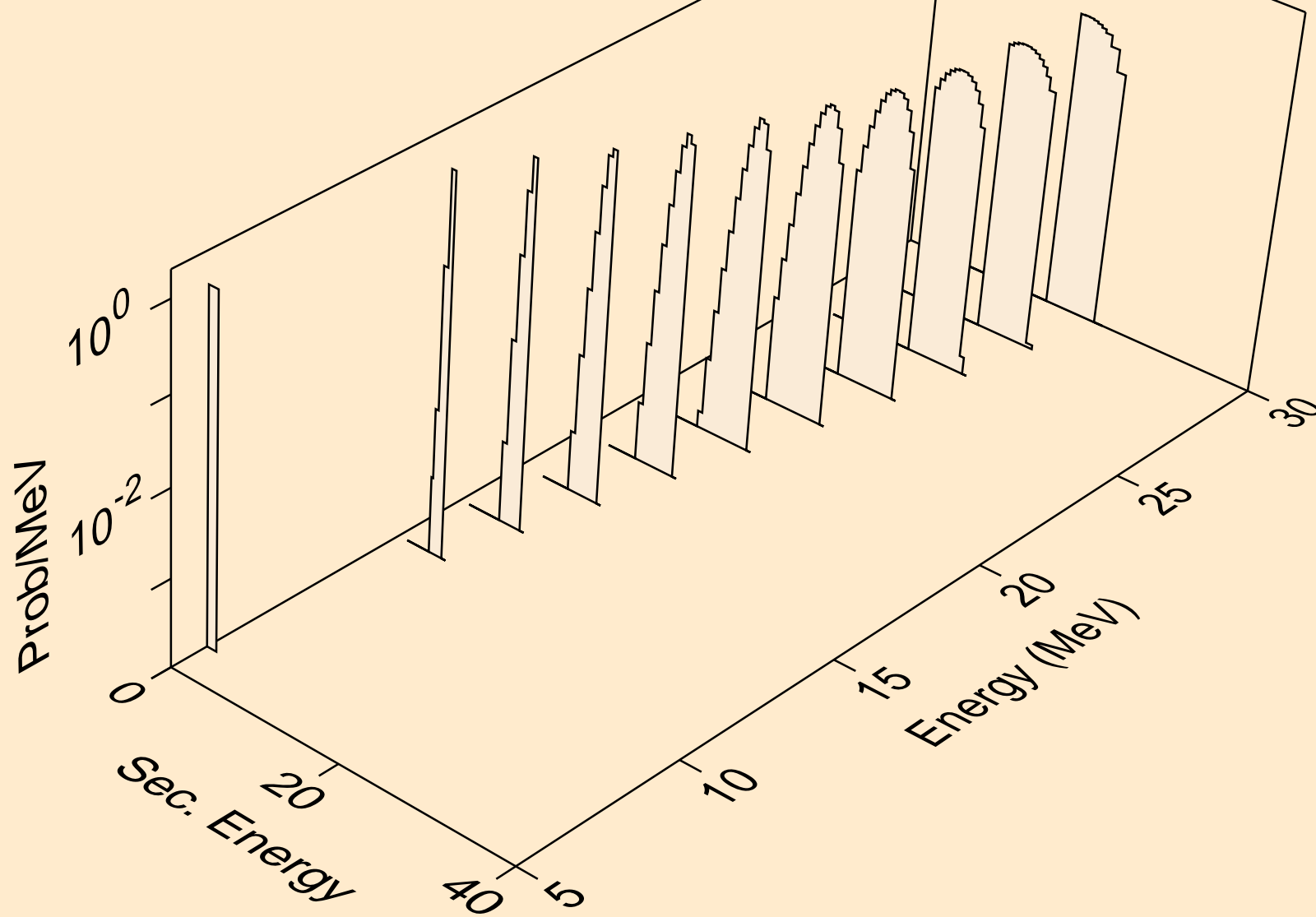

RF257M PROTON ACER TENDL-2023 LIBRARY; T=0.K  
he3s from (p,x)

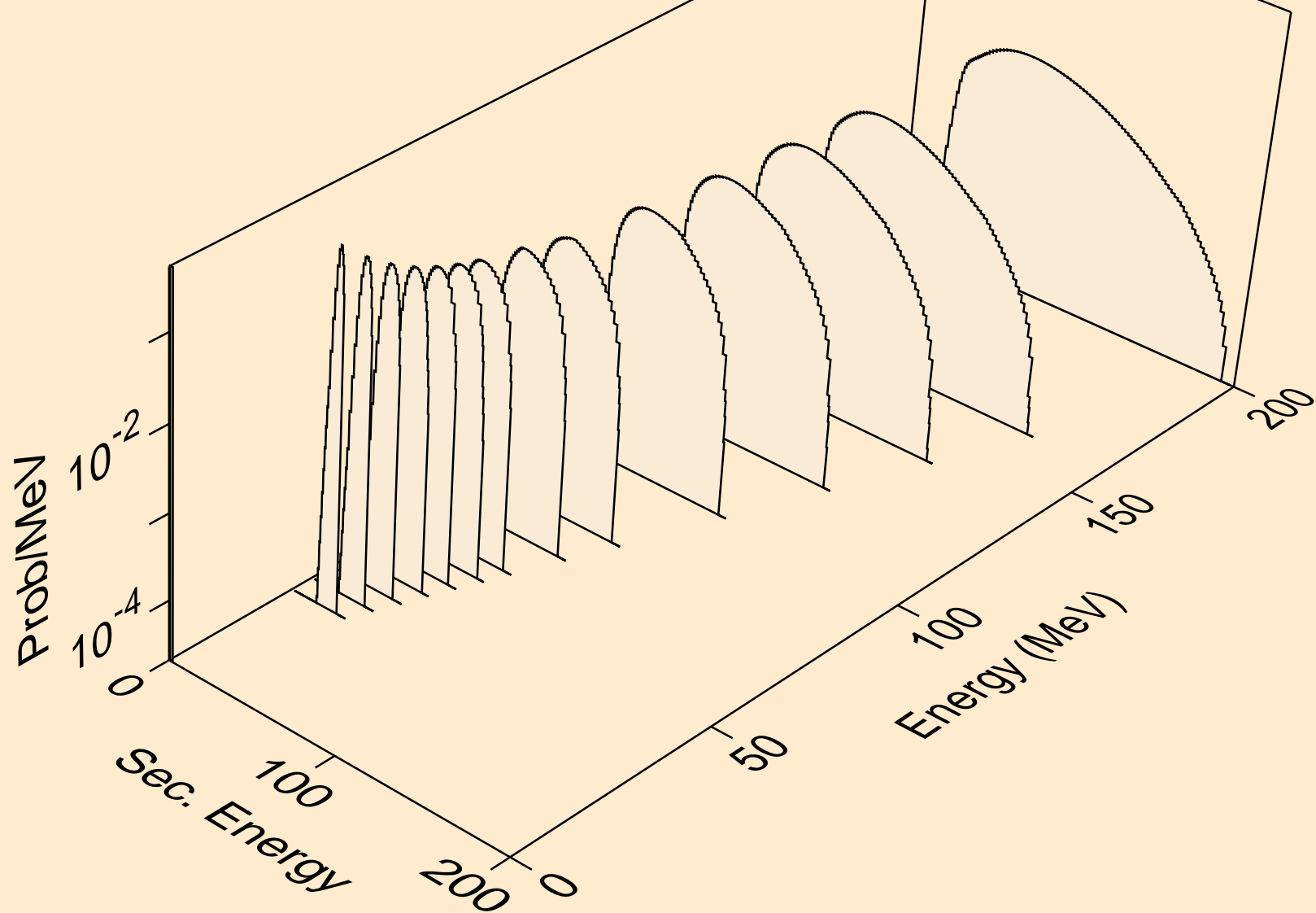

RF257M PROTON ACER TENDL-2023 LIBRARY; T=0.K  
he3s from (p,he3)

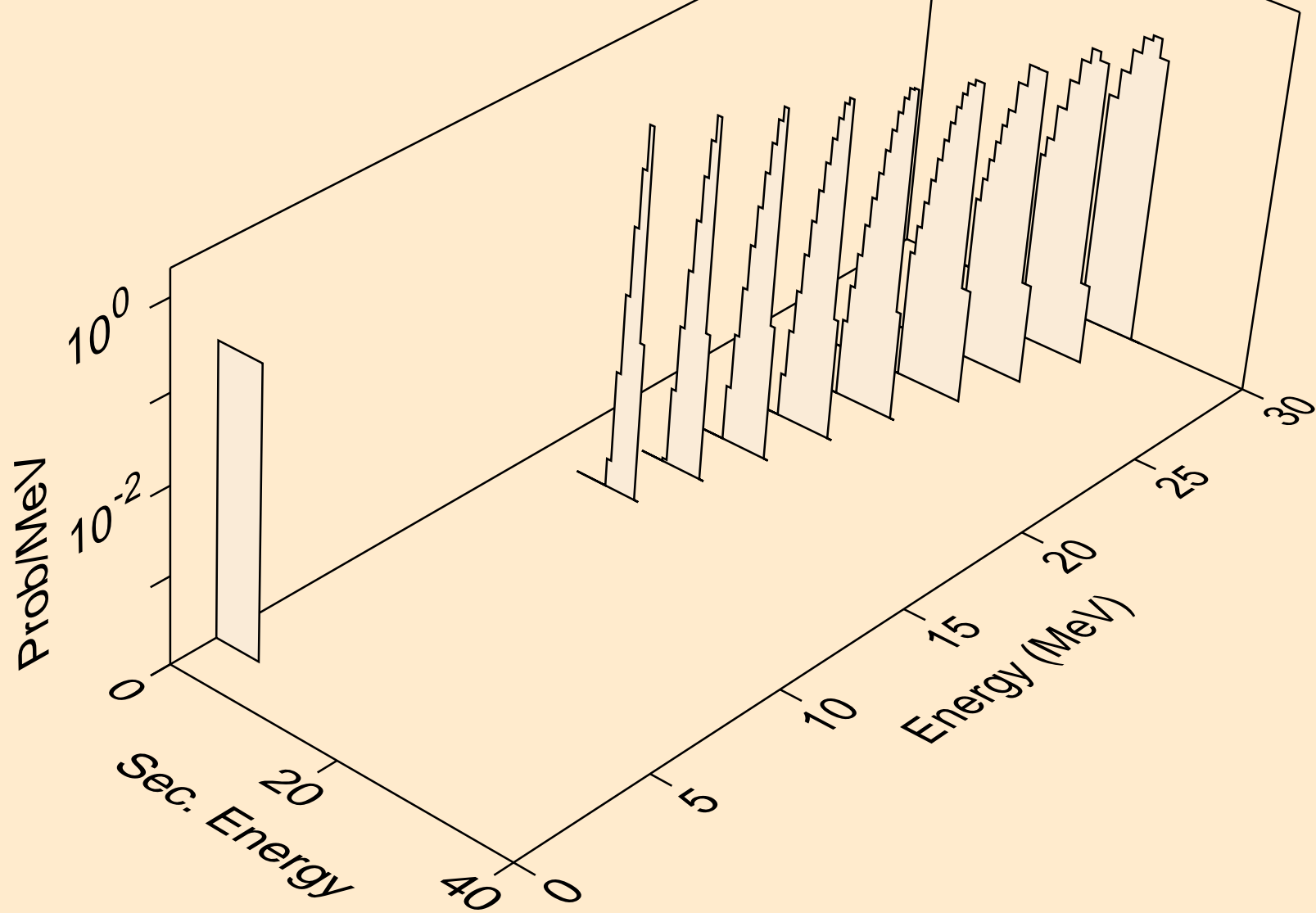

RF257M PROTON ACER TENDL-2023 LIBRARY; T=0.K  
alphas from (p,x)

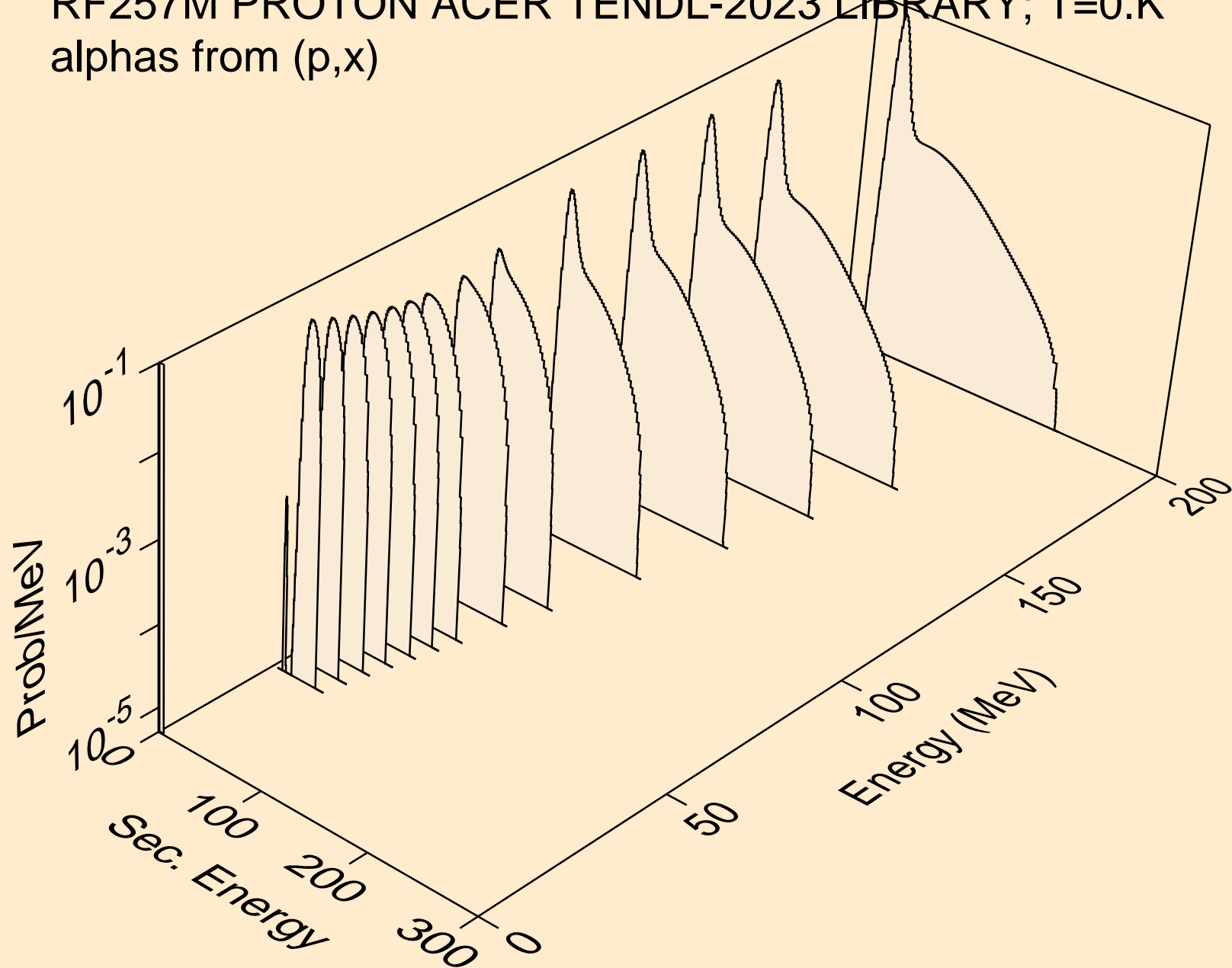

RF257M PROTON ACER TENDL-2023 LIBRARY; T=0.K  
alphas from (p,n\*)a

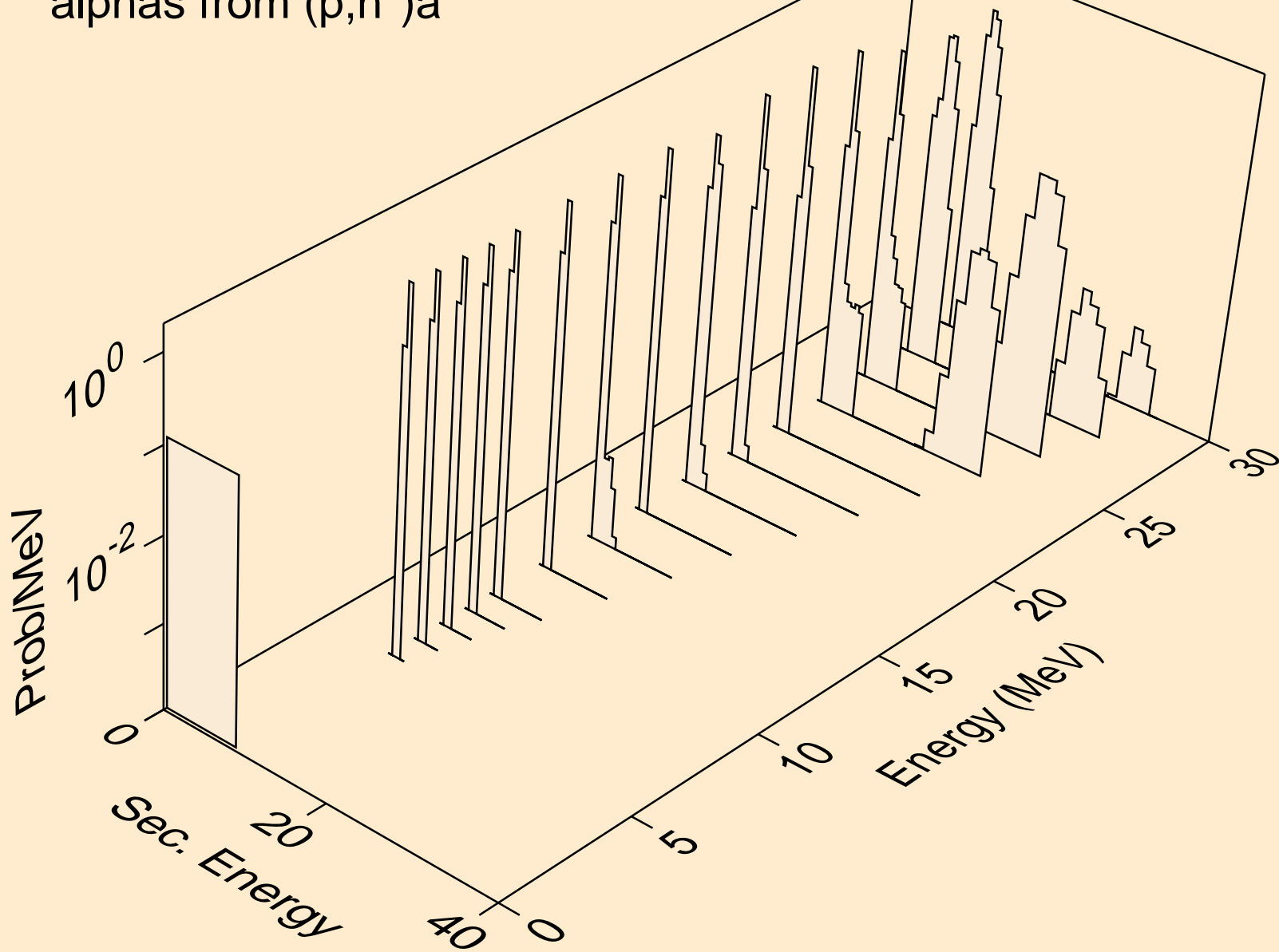

RF257M PROTON ACER TENDL-2023 LIBRARY; T=0.K  
alphas from (p,2n)a

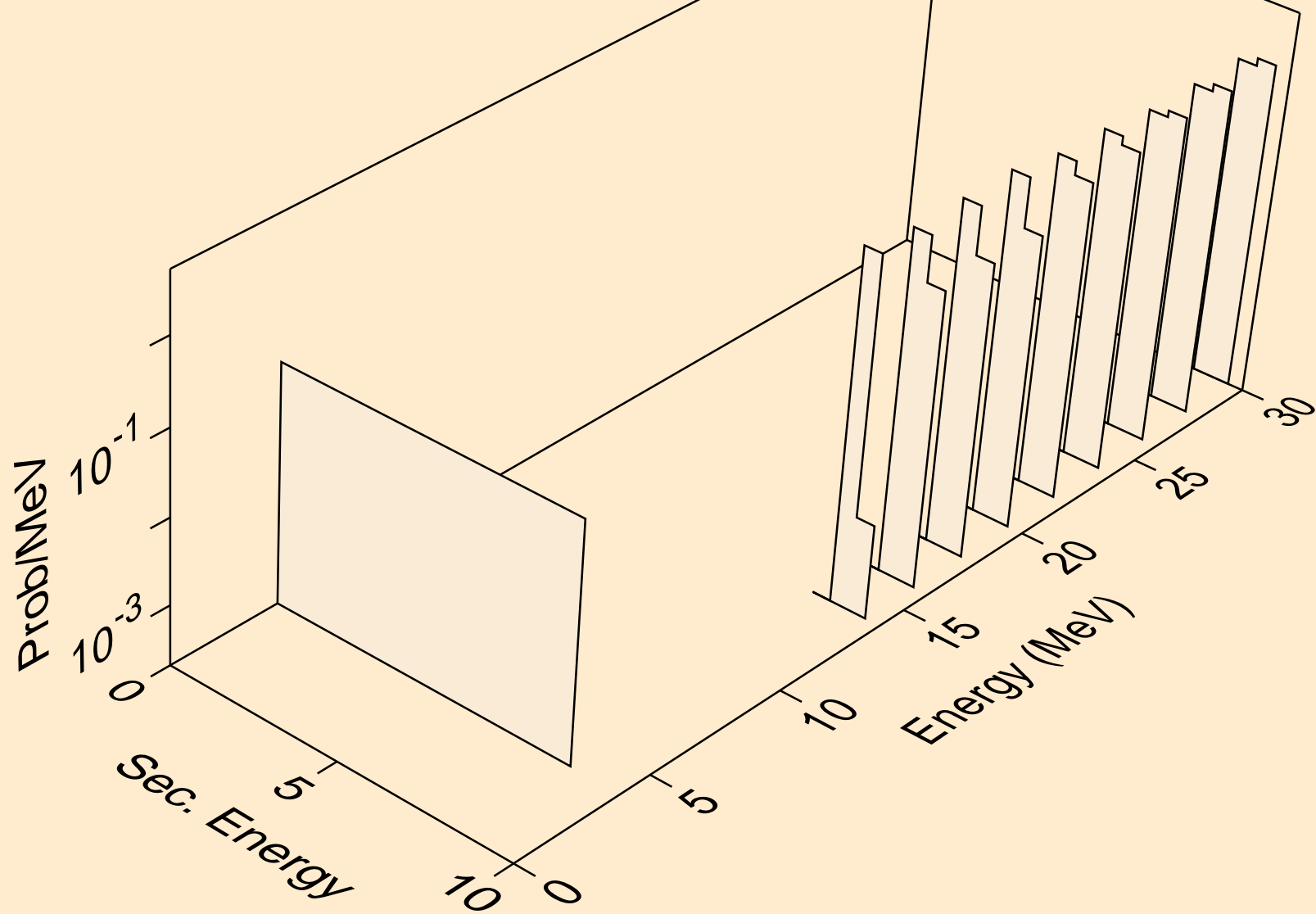

RF257M PROTON ACER TENDL-2023 LIBRARY; T=0.K  
alphas from (p,npa)

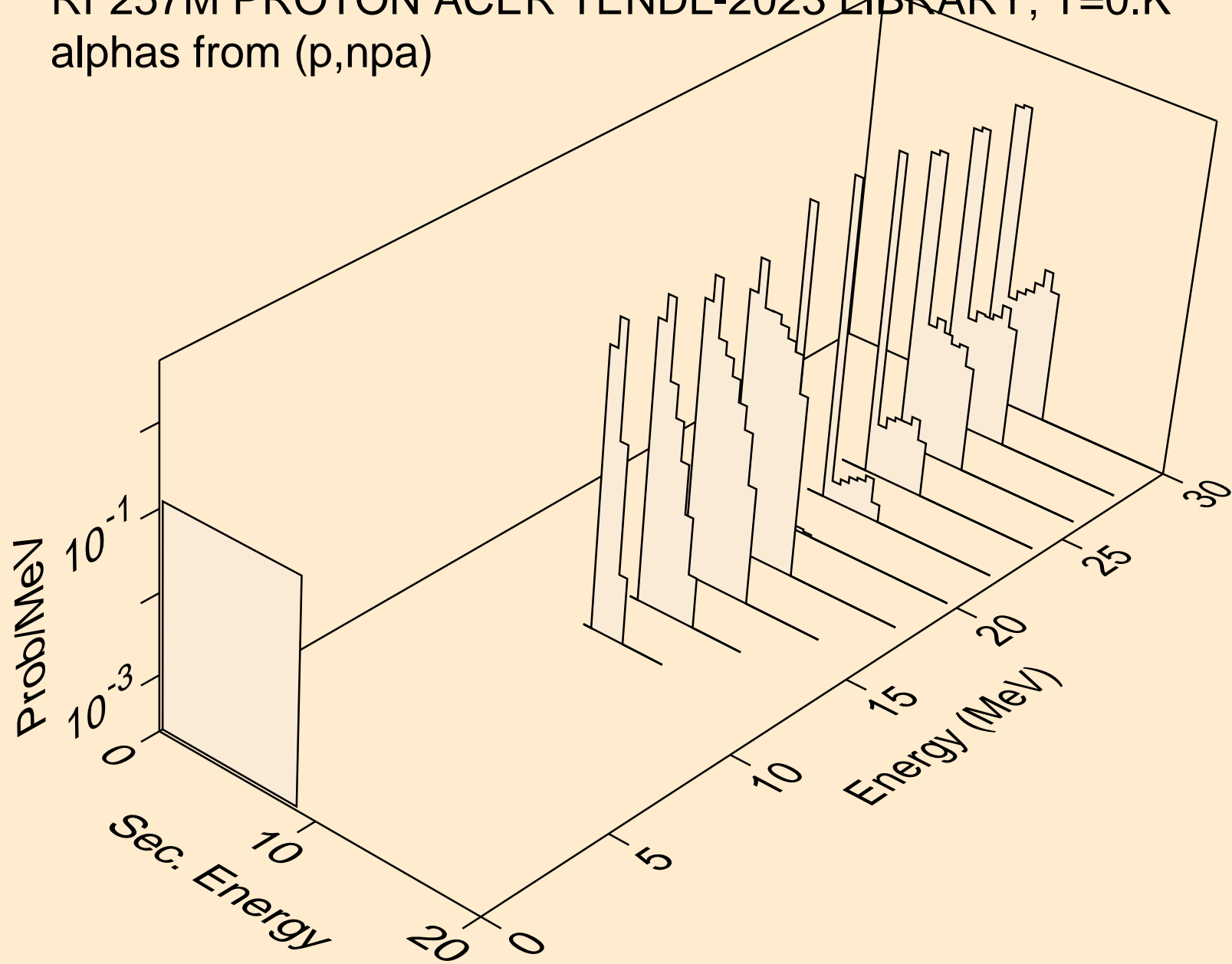



RF257M PROTON ACER TENDL-2023 LIBRARY; T=0.K  
alphas from (p,a)

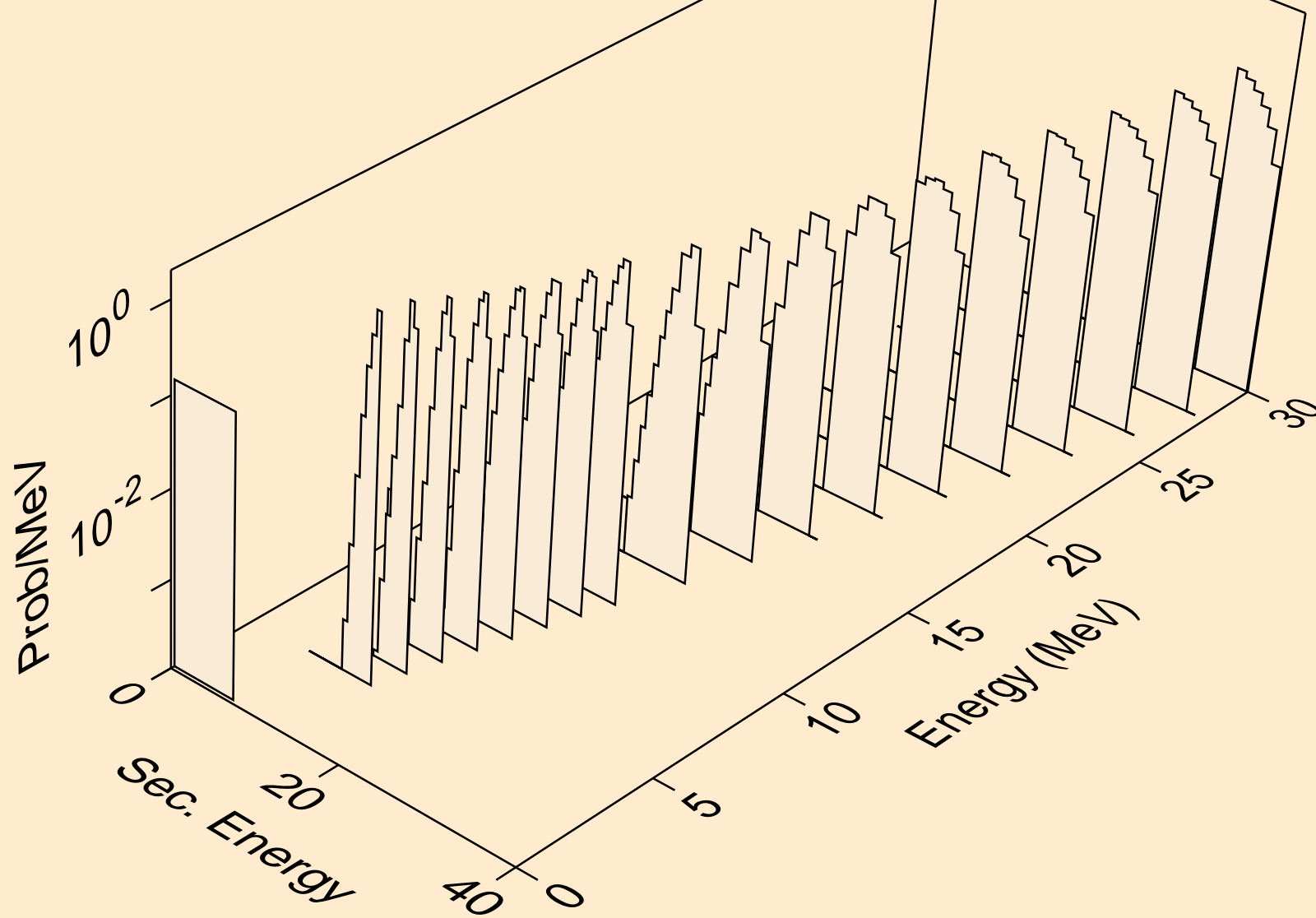

RF257M PROTON ACER TENDL-2023 LIBRARY; T=0.K  
alphas from (p,2a)

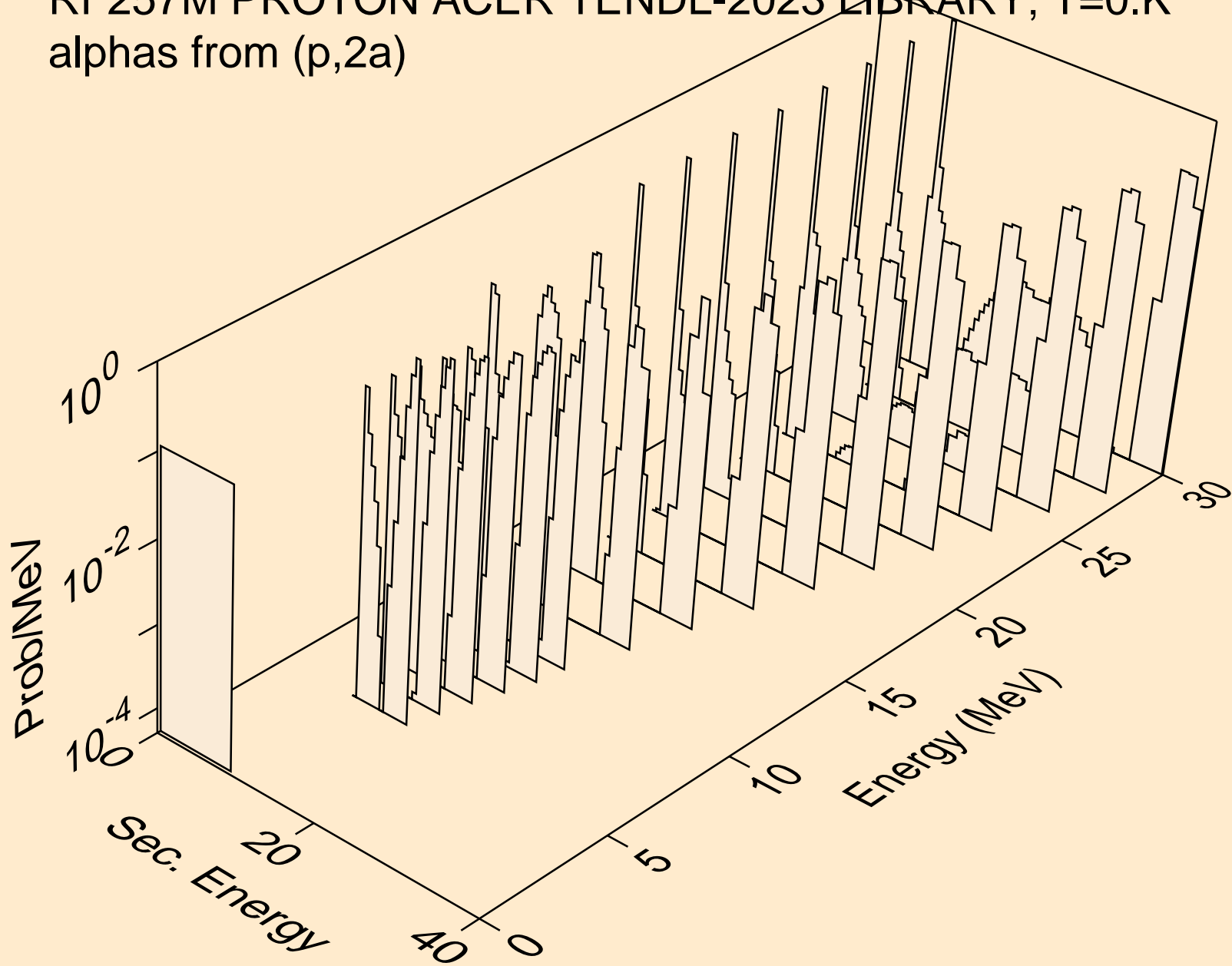

RF257M PROTON ACER TENDL-2023 LIBRARY; T=0.K  
alphas from (p,pa)

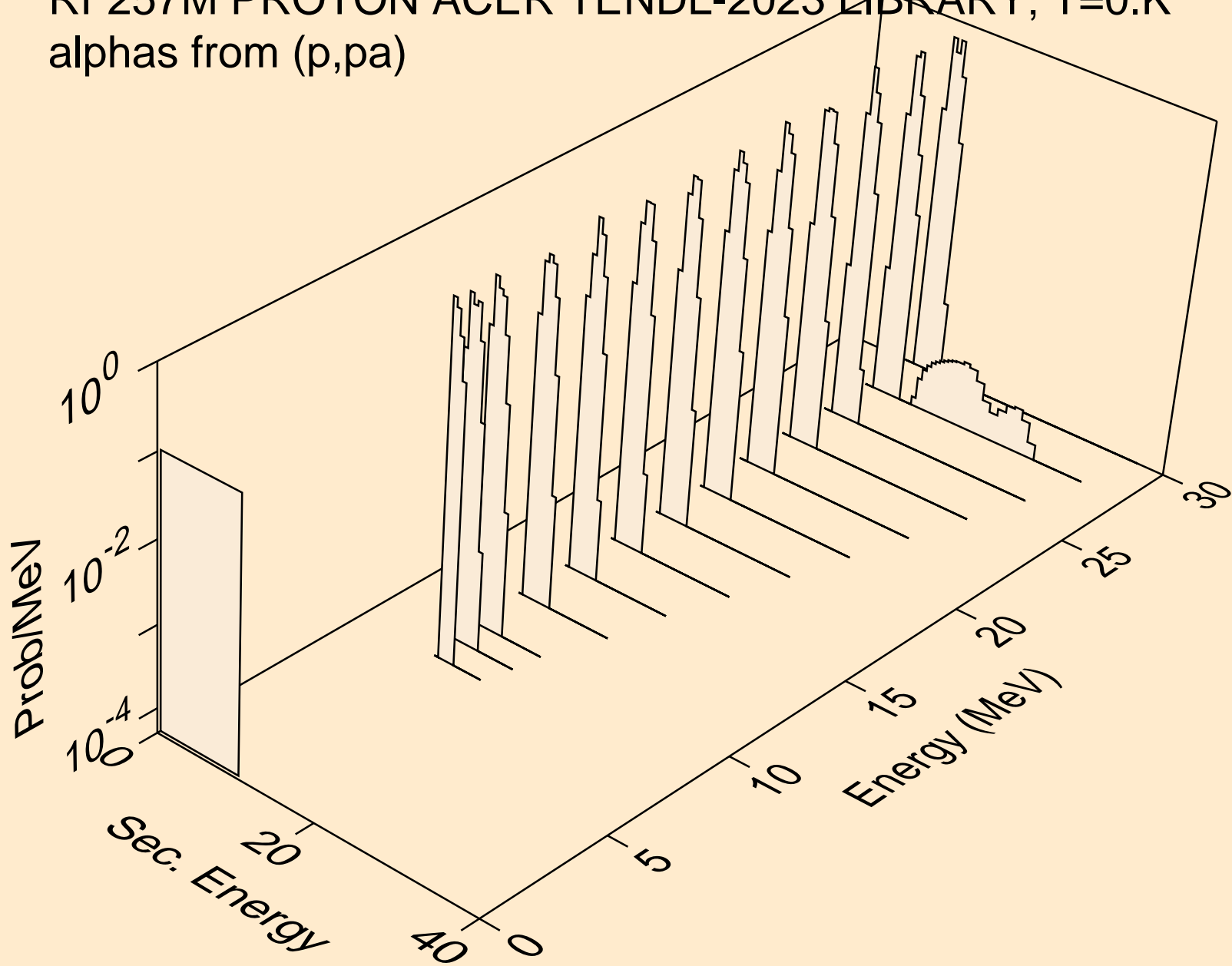

RF257M PROTON ACER TENDL-2023 LIBRARY; T=0.K  
alphas from (p,da)

