

RN201M PROTON ACER TENDL-2023 LIBRARY; T=0.K  
Principal cross sections

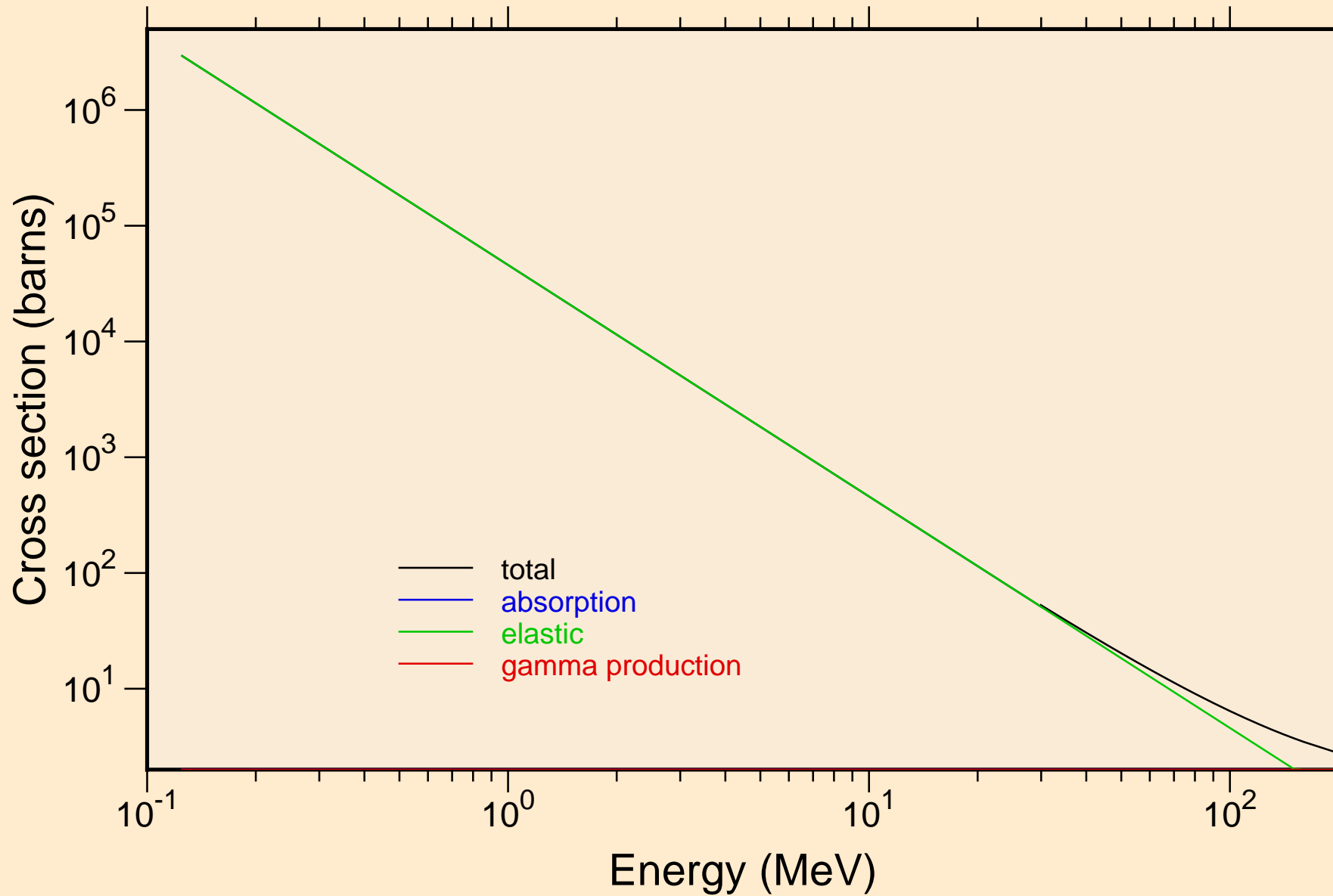

# RN201M PROTON ACER TENDL-2023 LIBRARY; T=0.K

## Heating

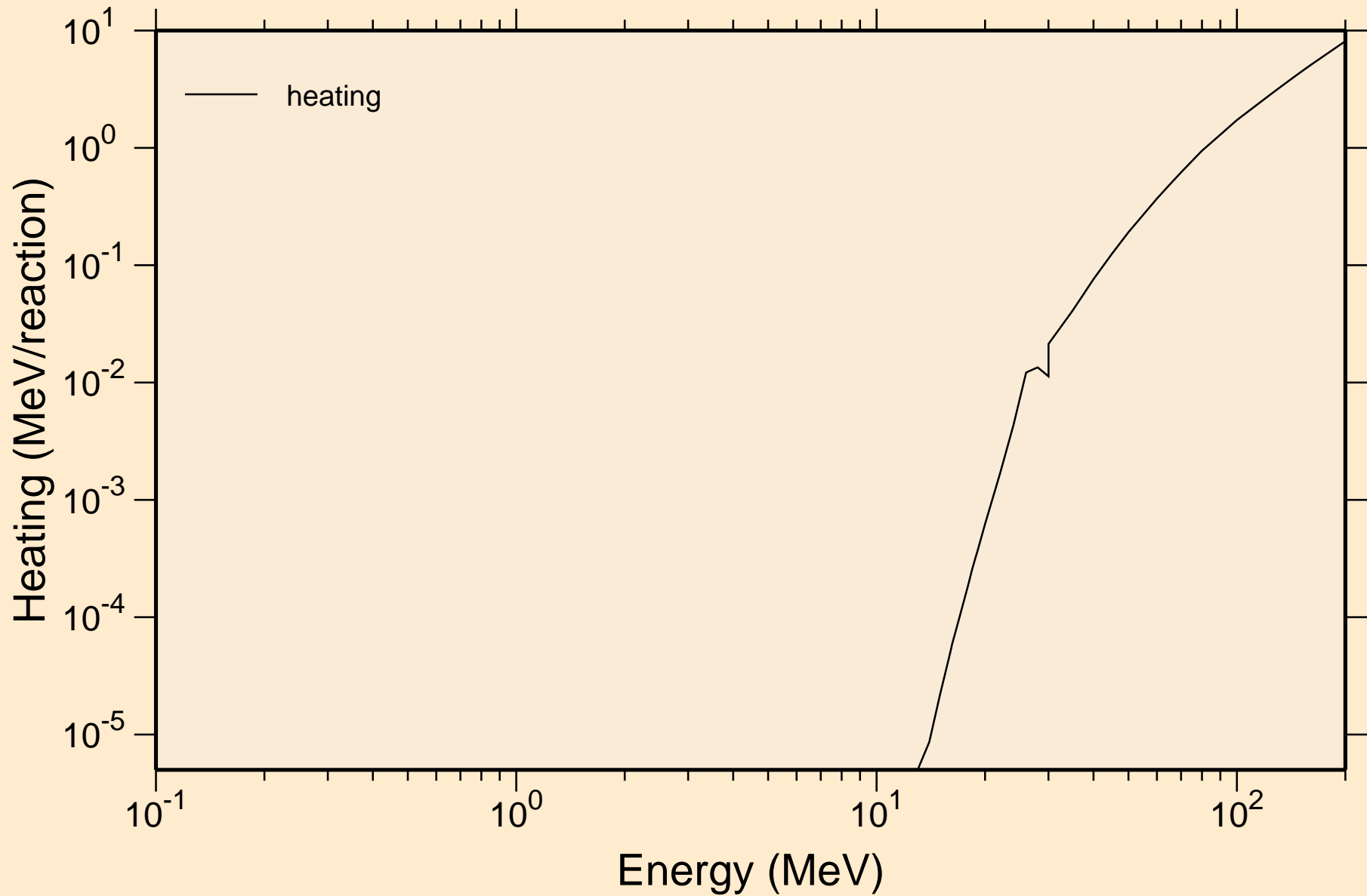

RN201M PROTON ACER TENDL-2023 LIBRARY; T=0.K  
Principal cross sections

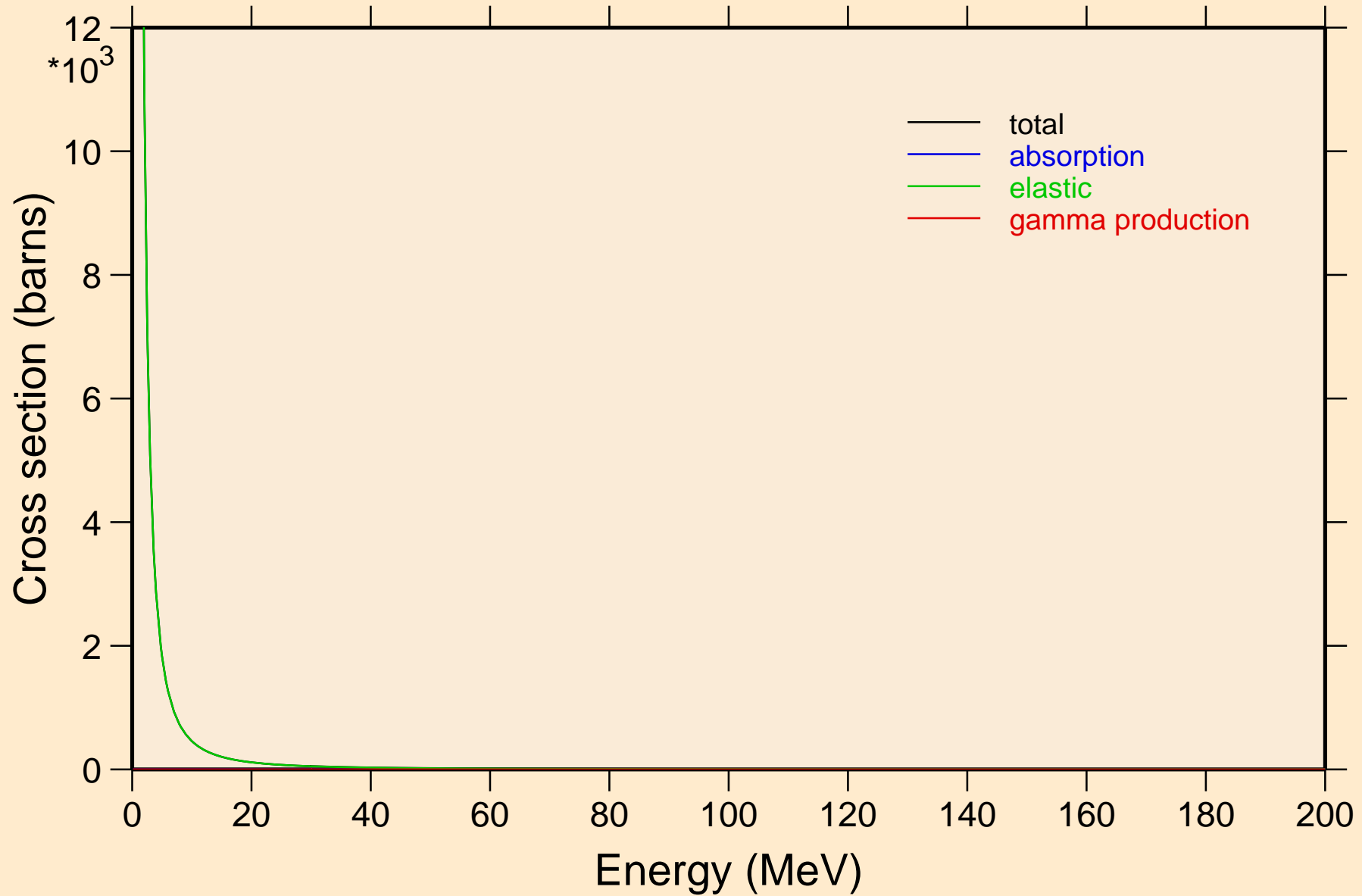

# RN201M PROTON ACER TENDL-2023 LIBRARY; T=0.K

## Heating

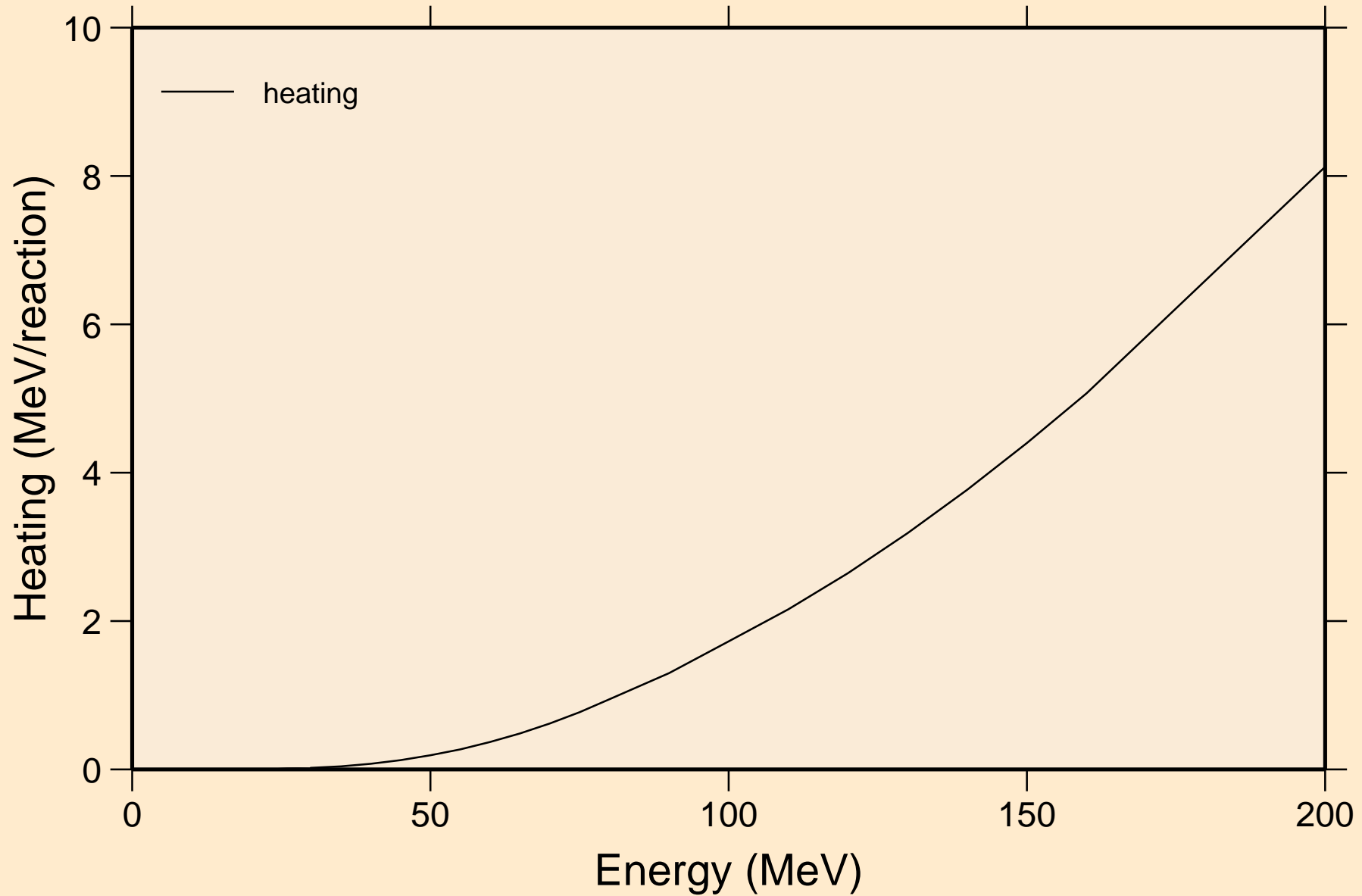

RN201M PROTON ACER TENDL-2023 LIBRARY; T=0.K  
Threshold reactions

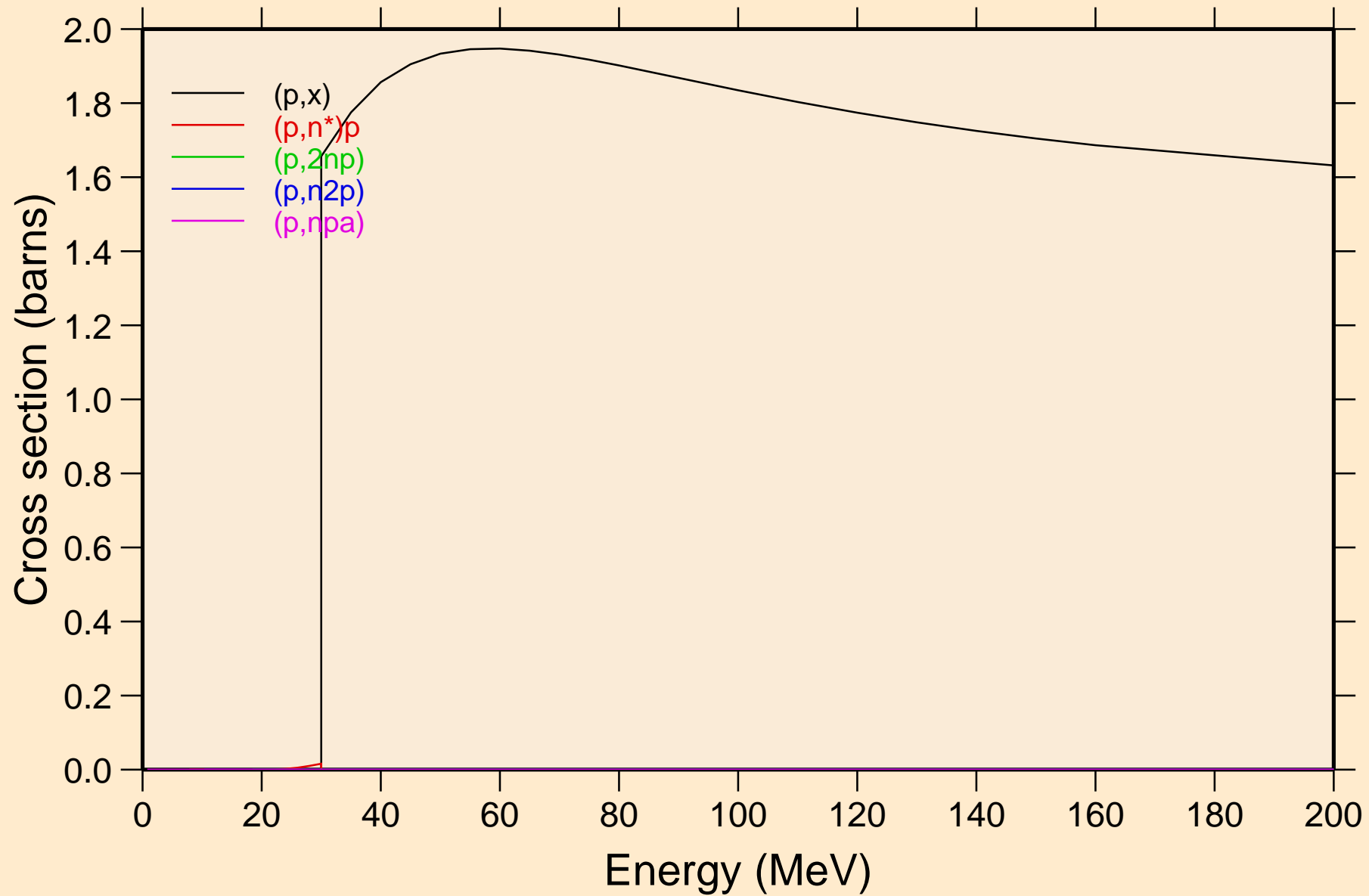

RN201M PROTON ACER TENDL-2023 LIBRARY; T=0.K  
Threshold reactions

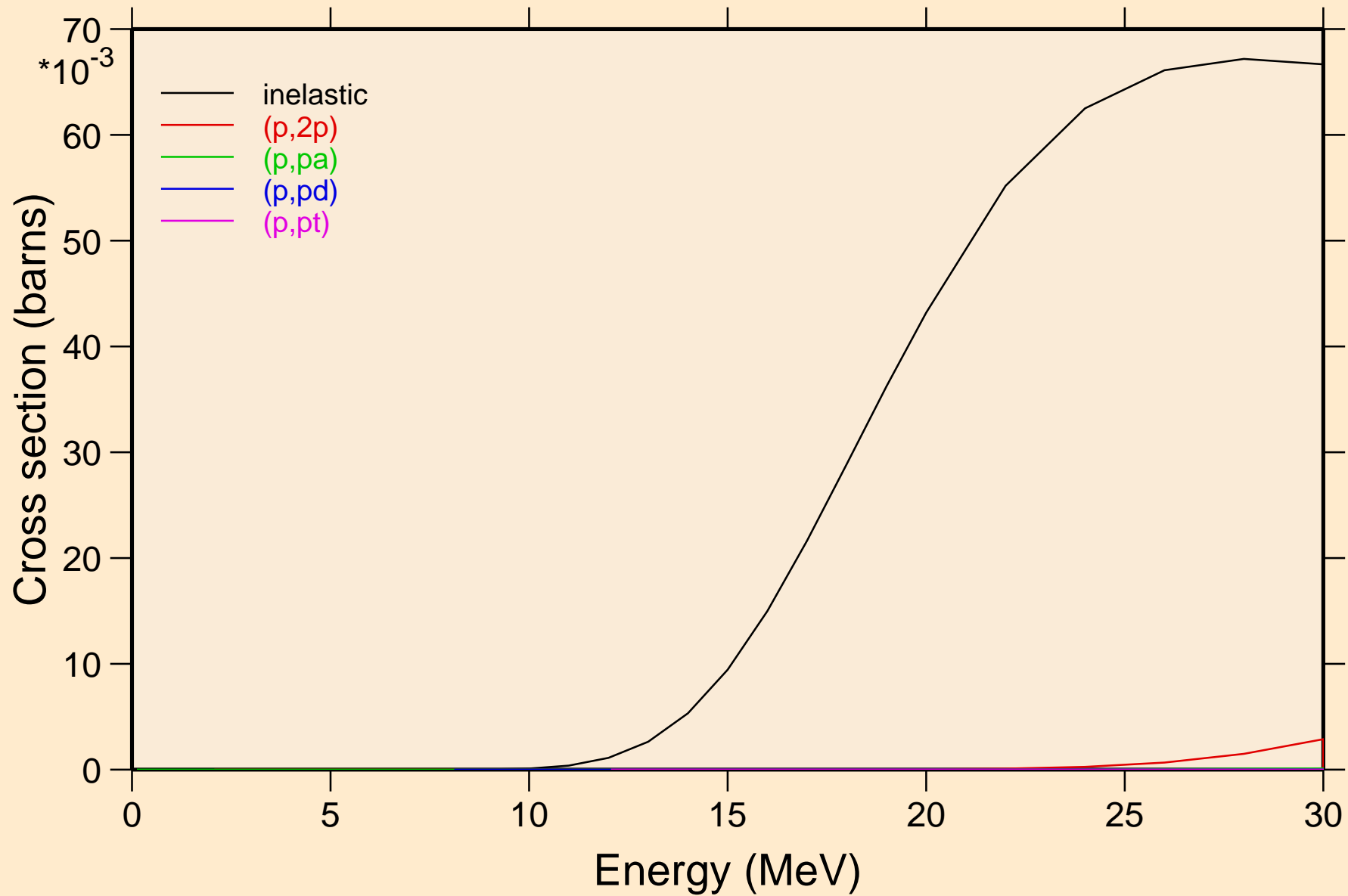

RN201M PROTON ACER TENDL-2023 LIBRARY; T=0.K  
Threshold reactions

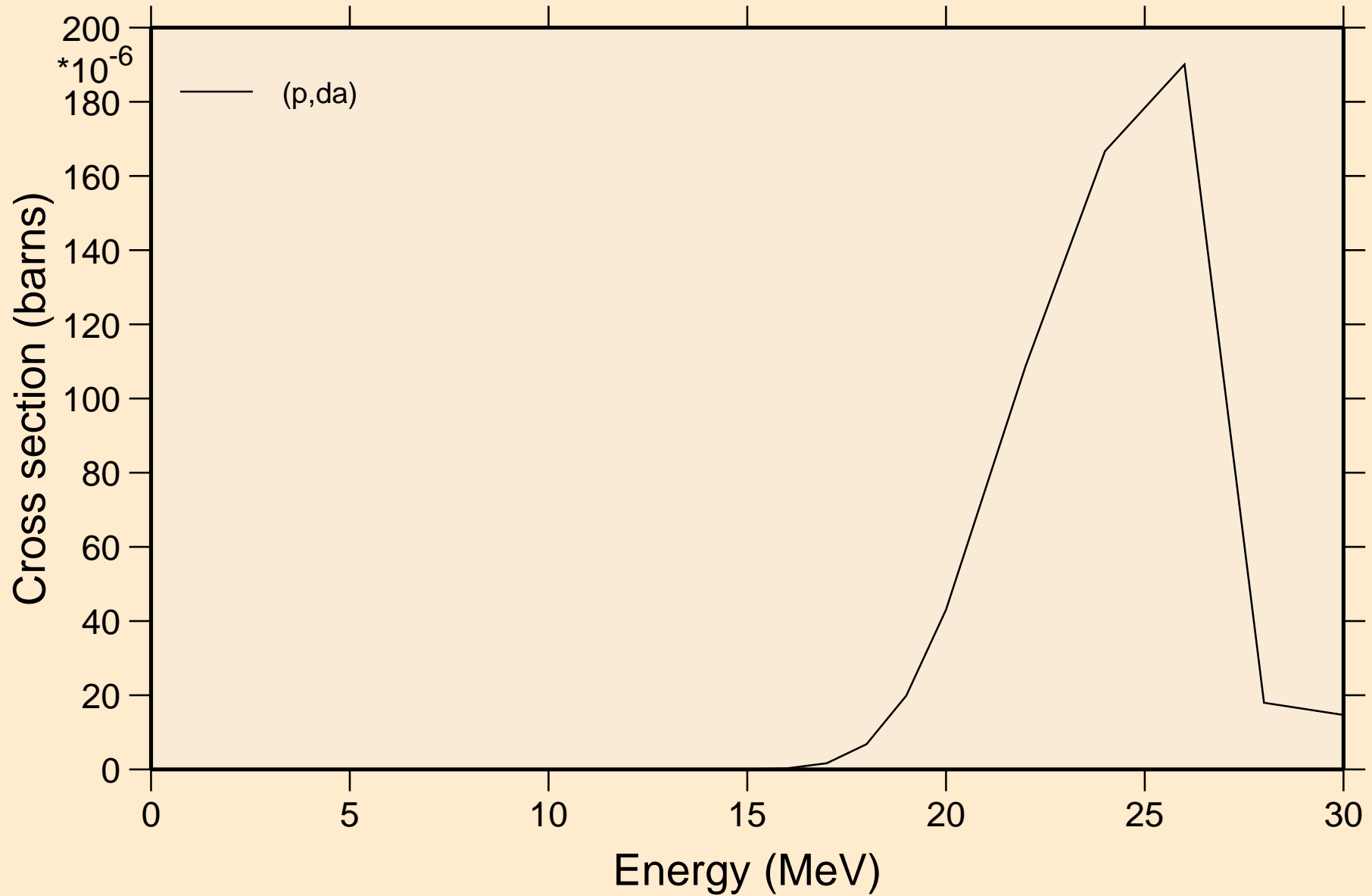

RN201M PROTON ACER TENDL-2023 LIBRARY; T=0.K  
angular distribution for elastic

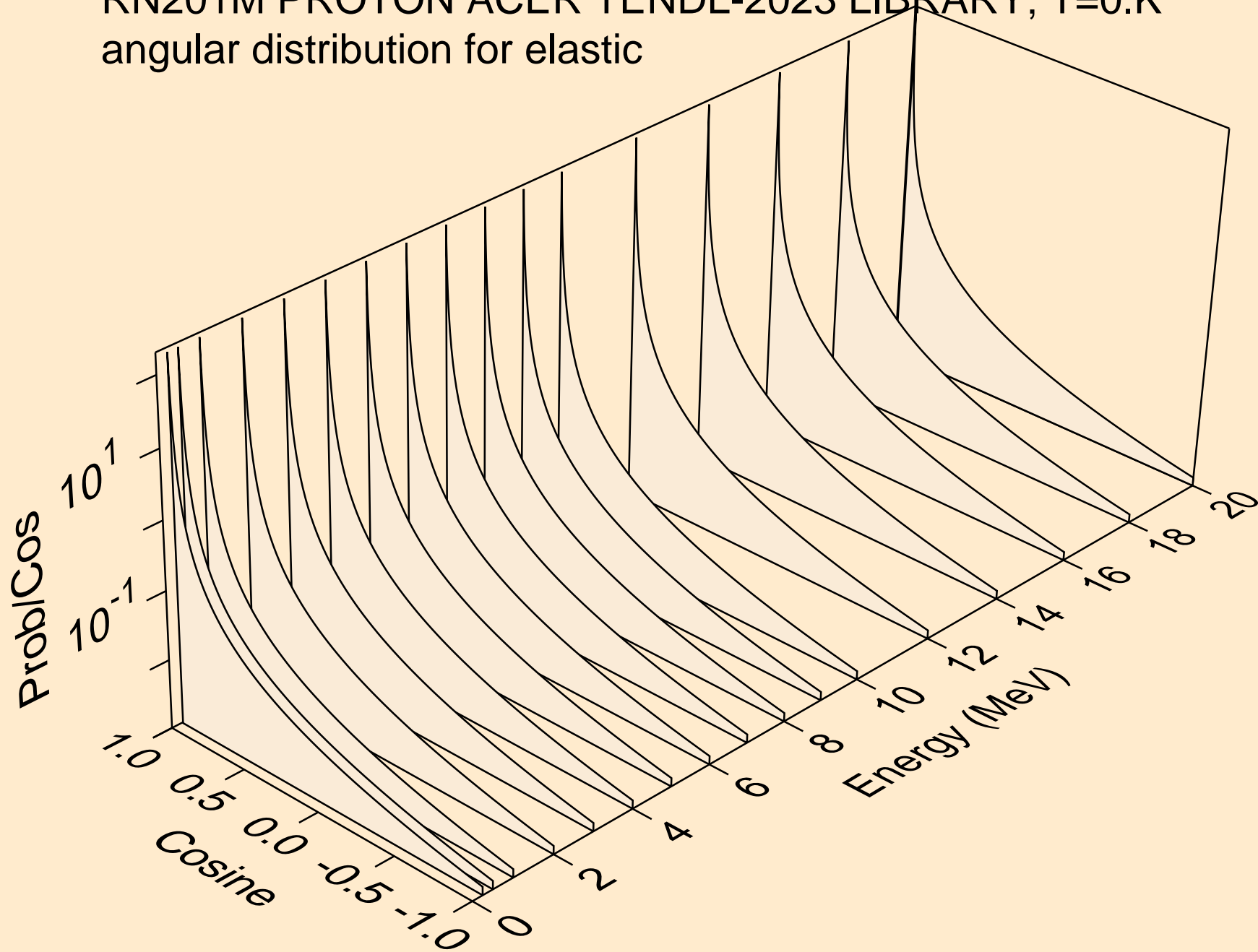



RN201M PROTON ACER TENDL-2023 LIBRARY; T=0.K  
angular distribution for elastic

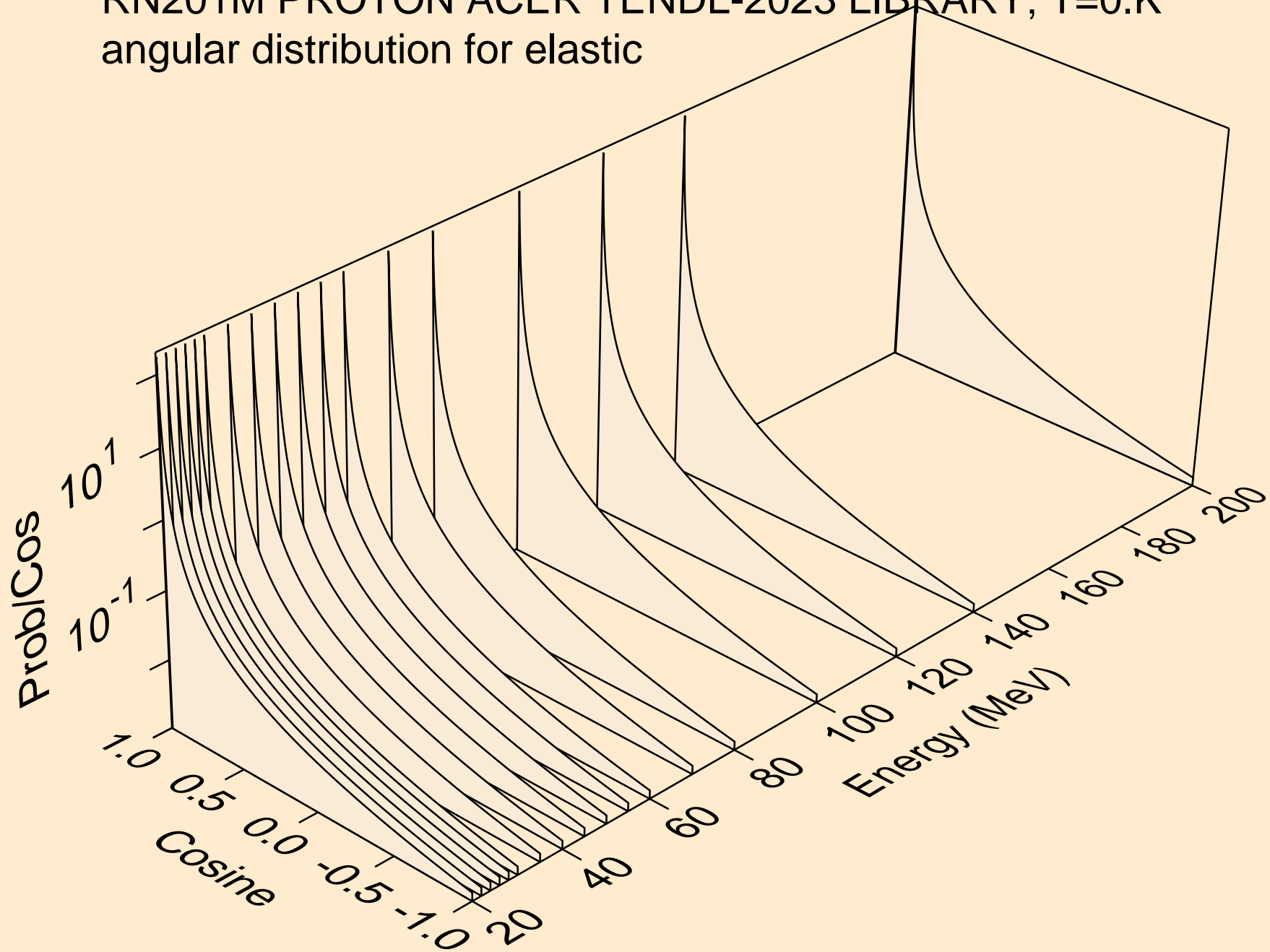

RN201M PROTON ACER TENDL-2023 LIBRARY; T=0.K  
Proton emission for (p,x)

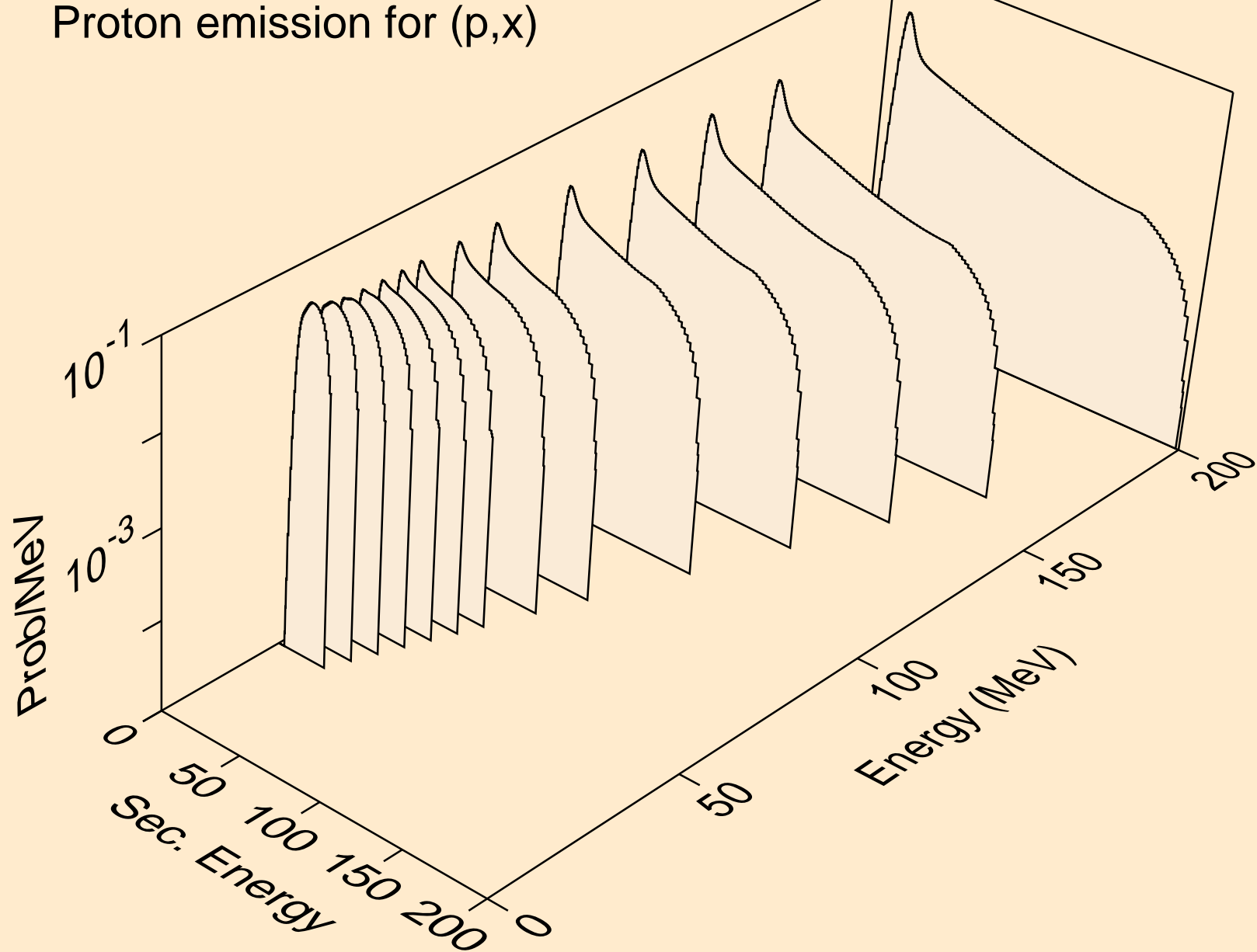

RN201M PROTON ACER TENDL-2023 LIBRARY; T=0.K  
Proton emission for (p,n\*)p

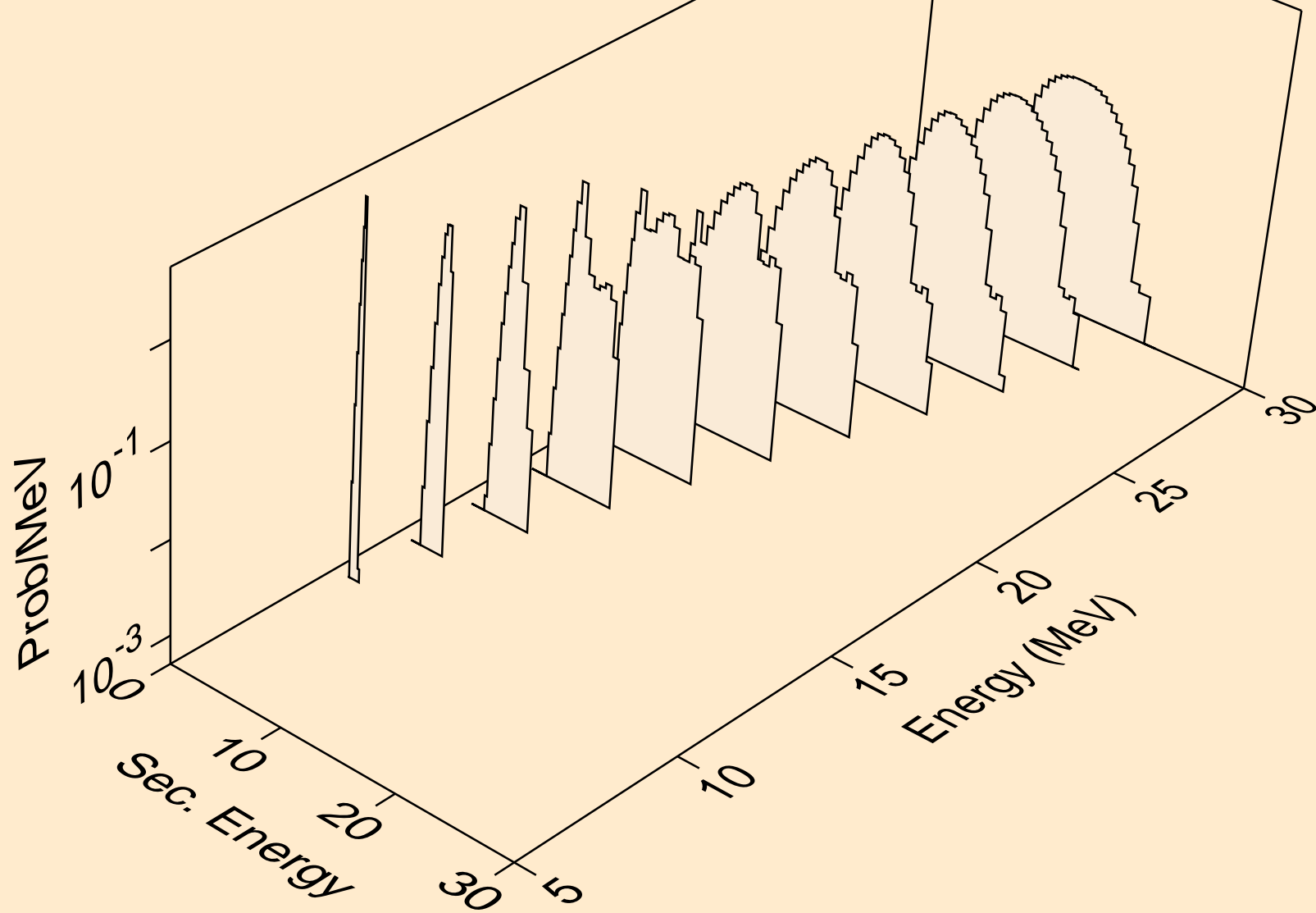

RN201M PROTON ACER TENDL-2023 LIBRARY; T=0.K  
Proton emission for (p,2np)

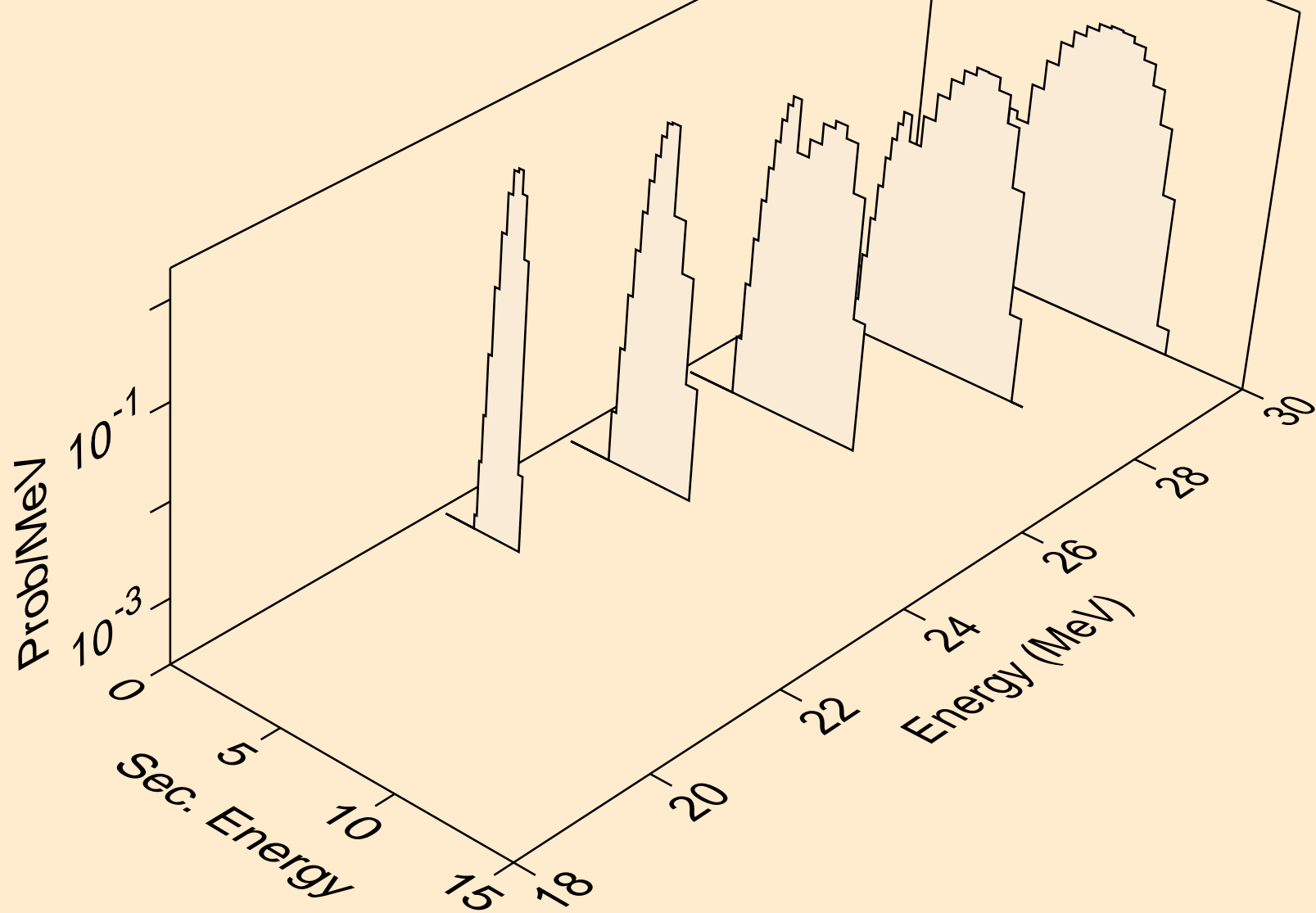

RN201M PROTON ACER TENDL-2023 LIBRARY; T=0.K  
Proton emission for (p,n2p)

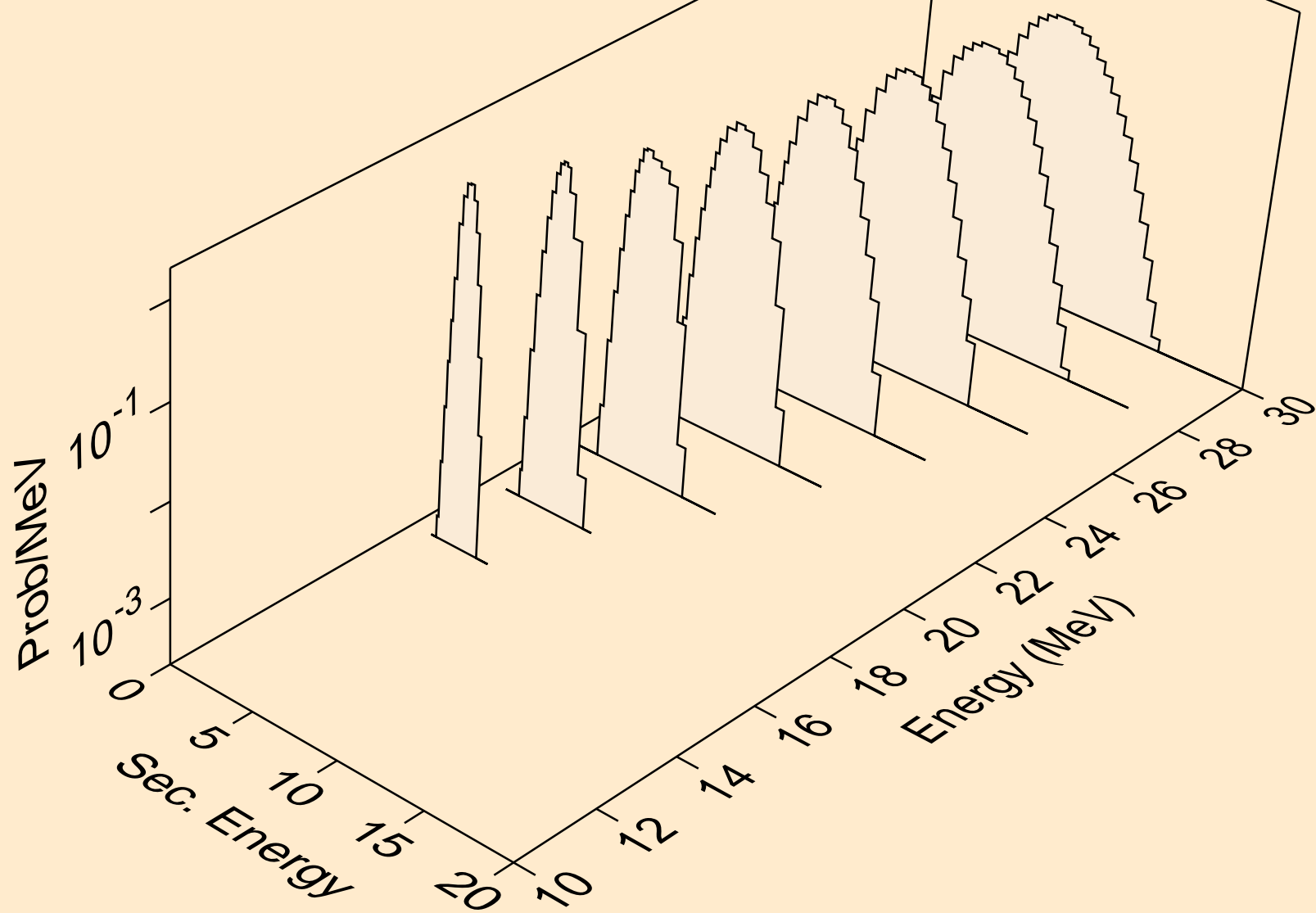

RN201M PROTON ACER TENDL-2023 LIBRARY; T=0.K  
Proton emission for (p,npa)

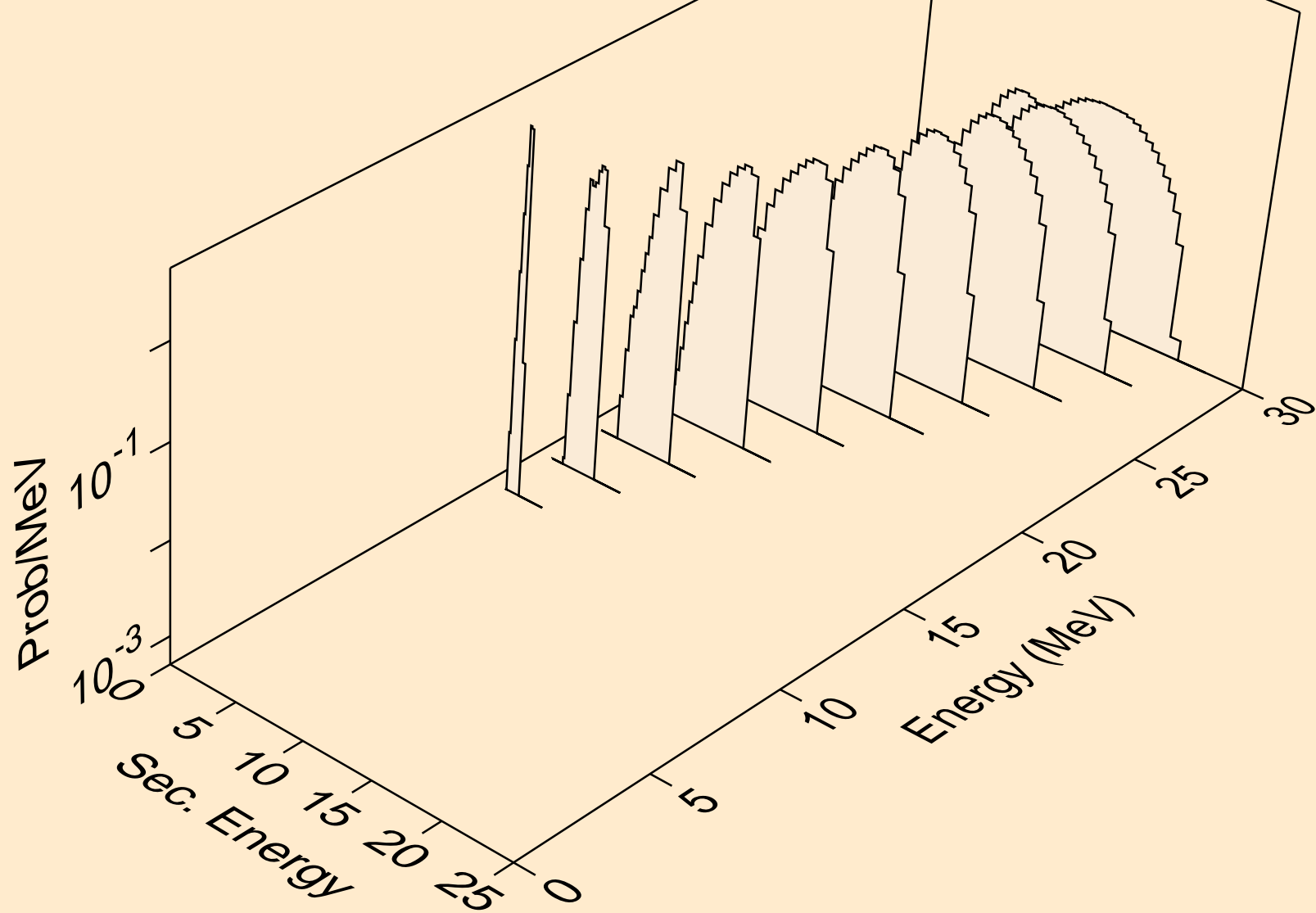

RN201M PROTON ACER TENDL-2023 LIBRARY; T=0.K  
Proton emission for inelastic

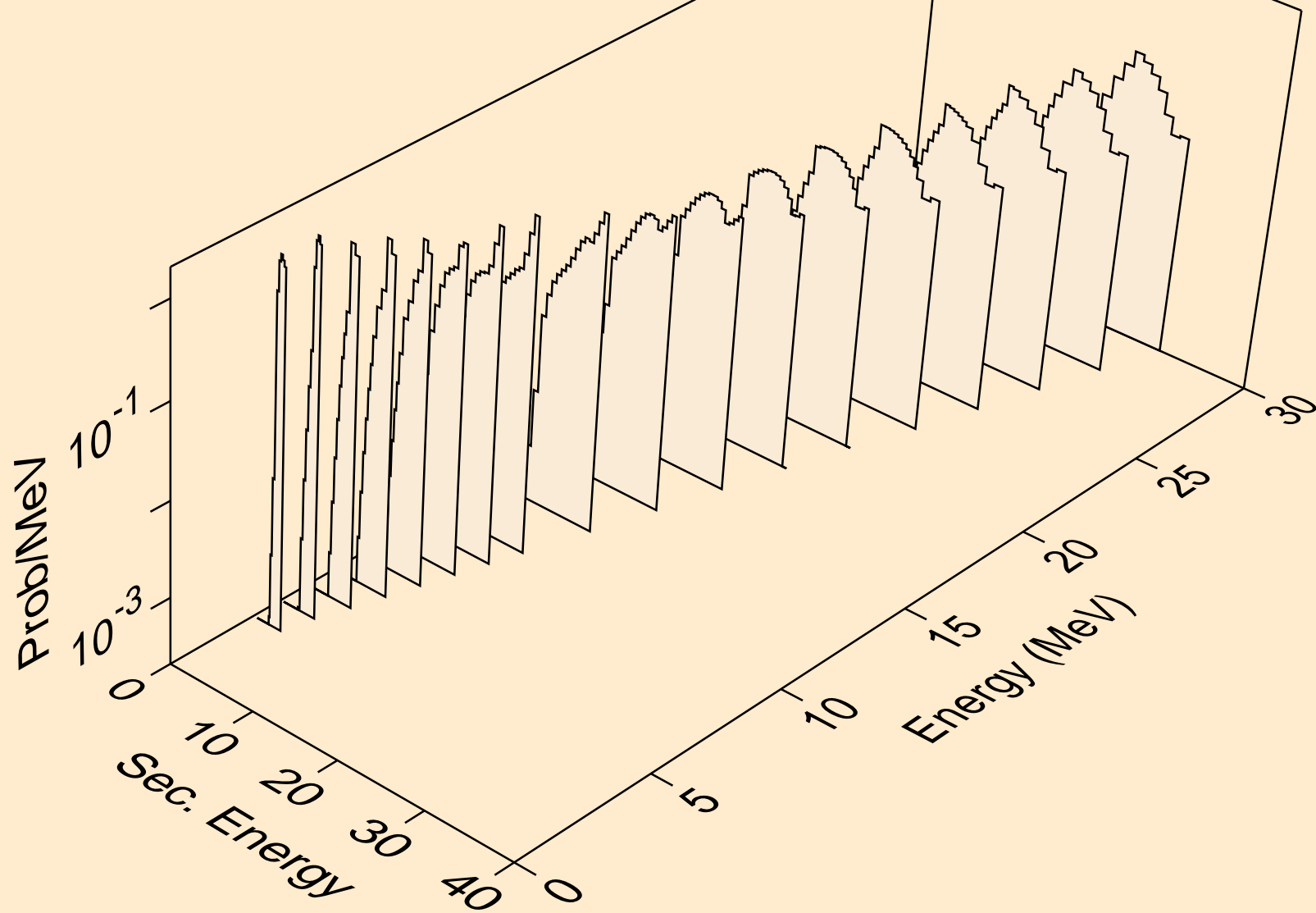

RN201M PROTON ACER TENDL-2023 LIBRARY; T=0.K  
Proton emission for (p,2p)

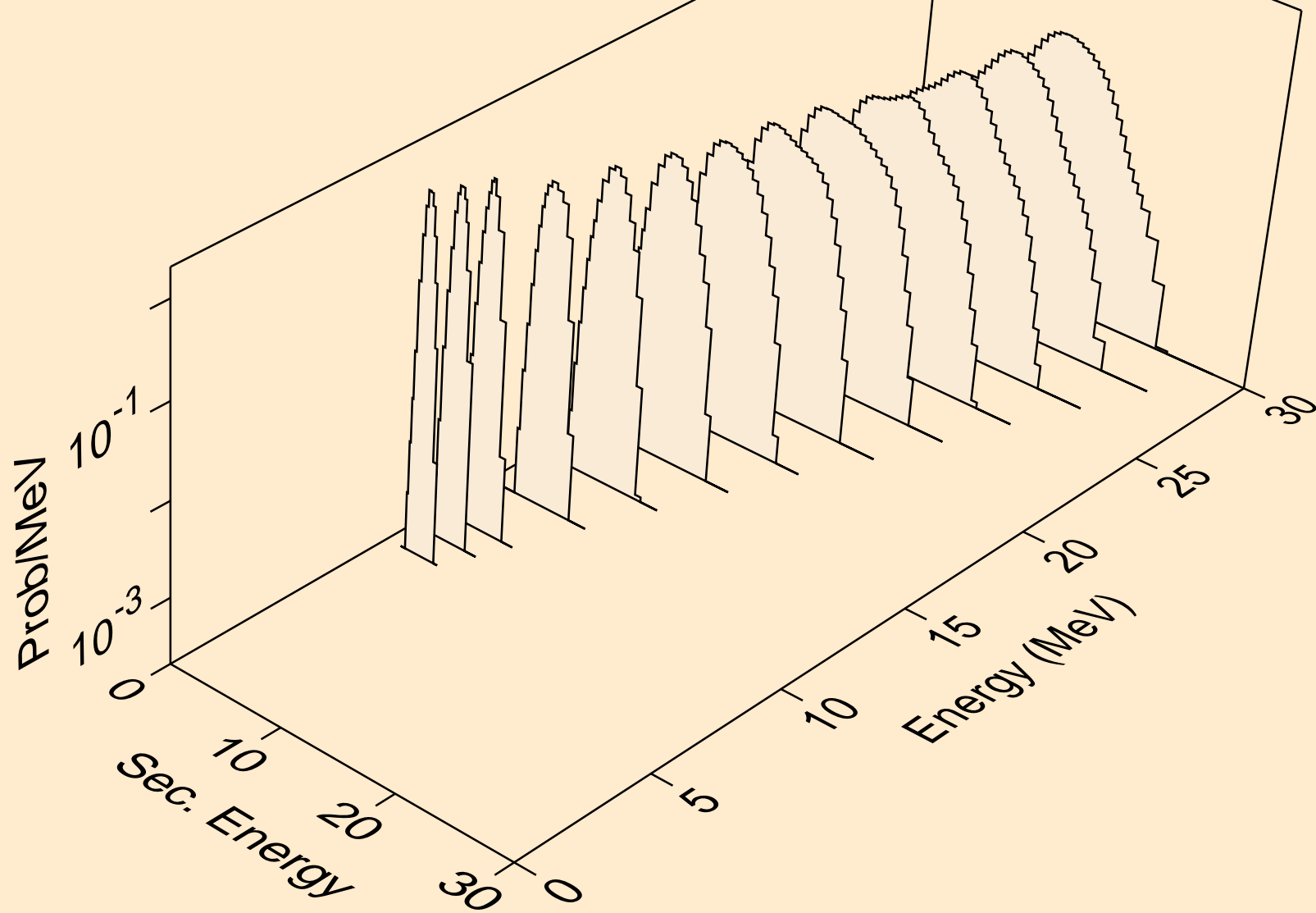



RN201M PROTON ACER TENDL-2023 LIBRARY; T=0.K  
Proton emission for (p,pa)

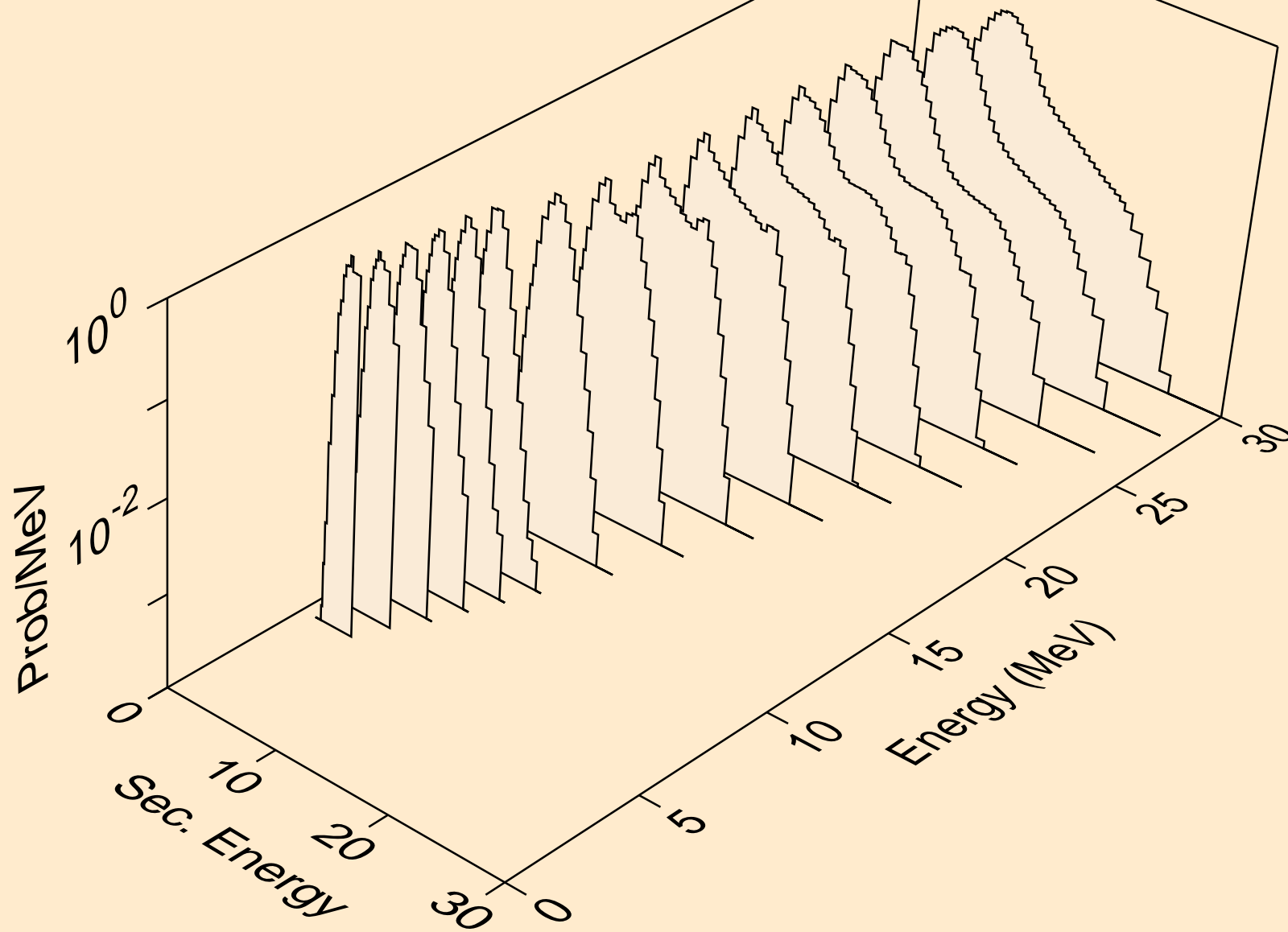

RN201M PROTON ACER TENDL-2023 LIBRARY; T=0.K  
Proton emission for (p,pd)

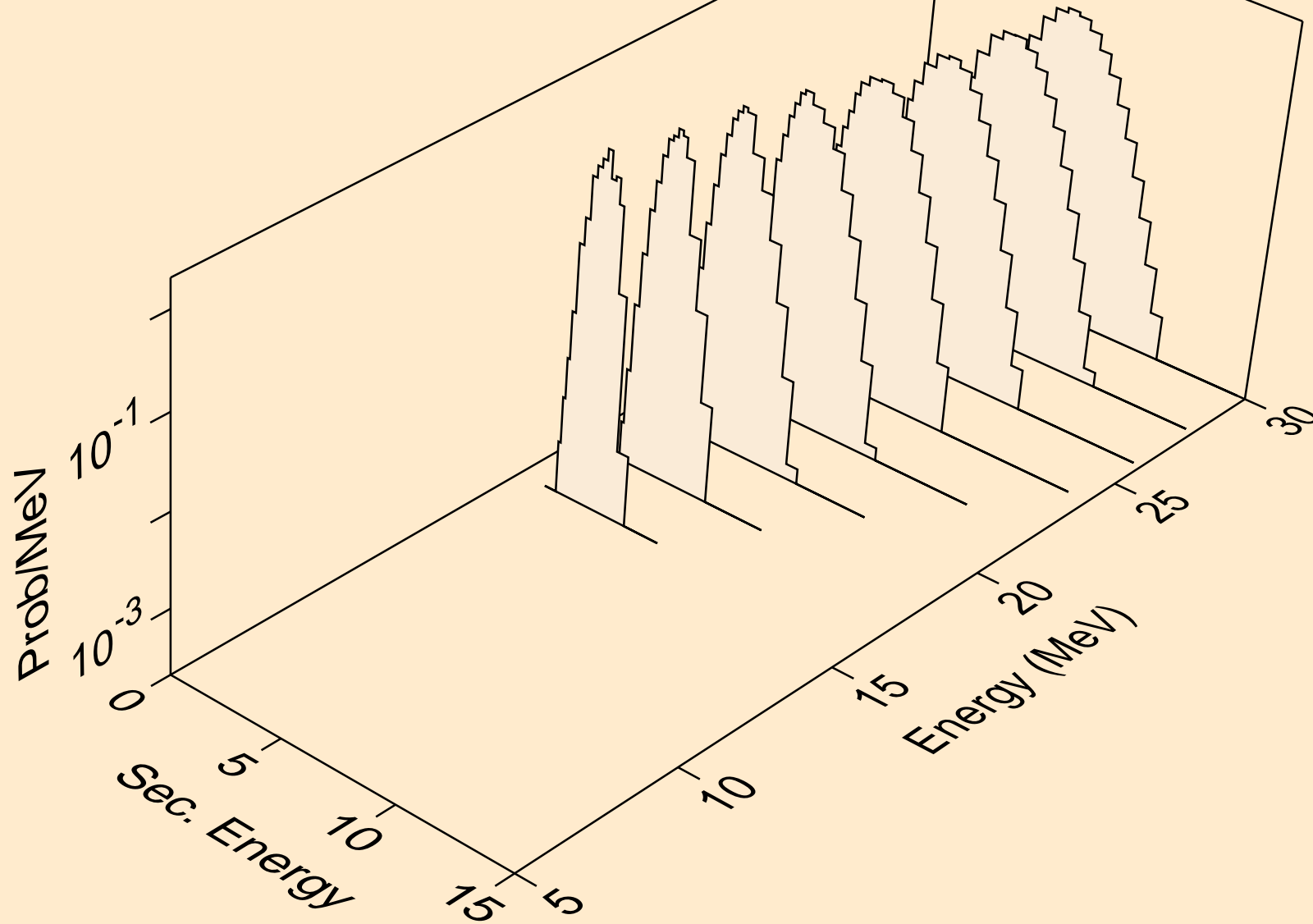

RN201M PROTON ACER TENDL-2023 LIBRARY; T=0.K  
Proton emission for (p,pt)

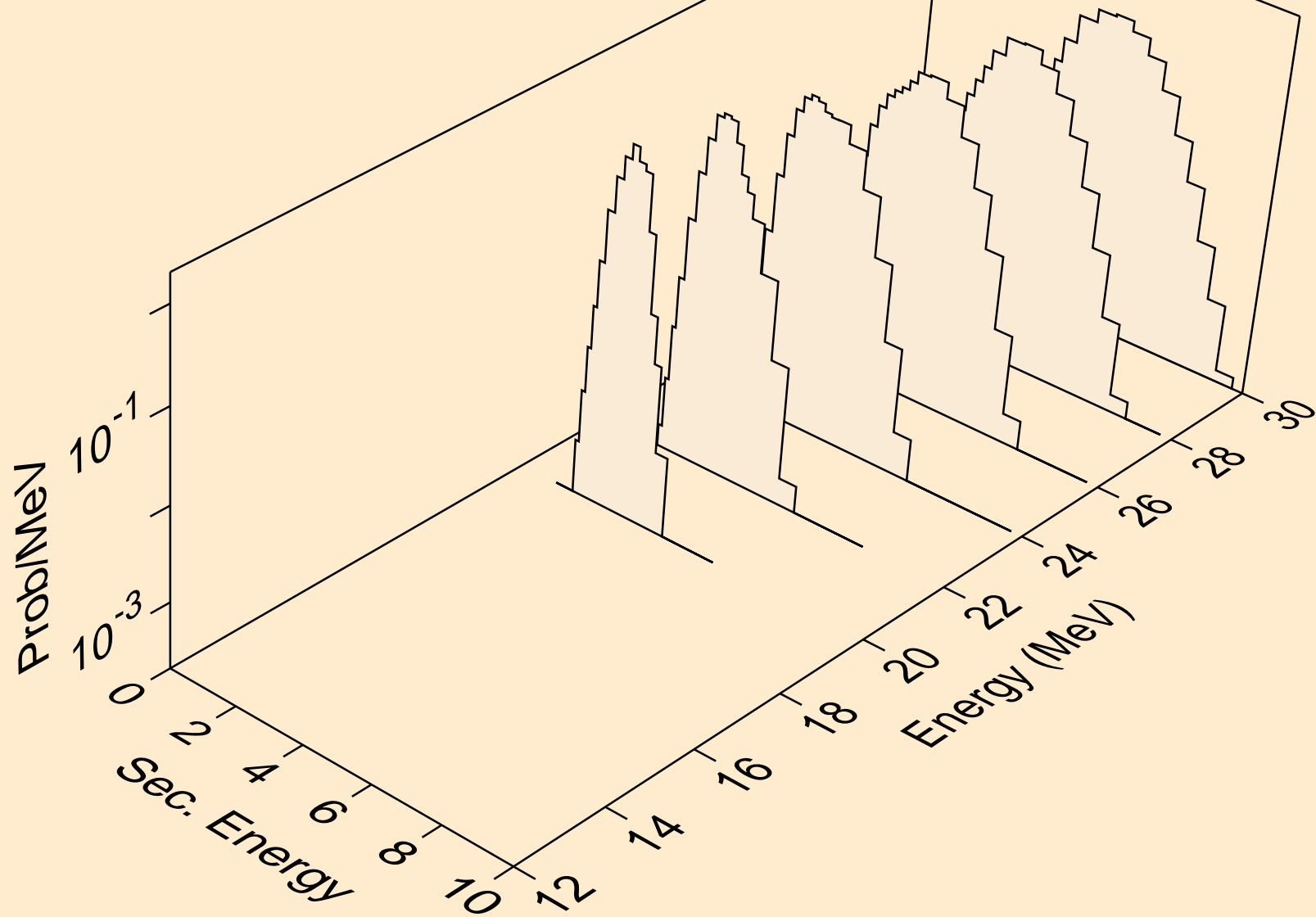

RN201M PROTON ACER TENDL-2023 LIBRARY; T=0.K  
Photon emission for (z,n)

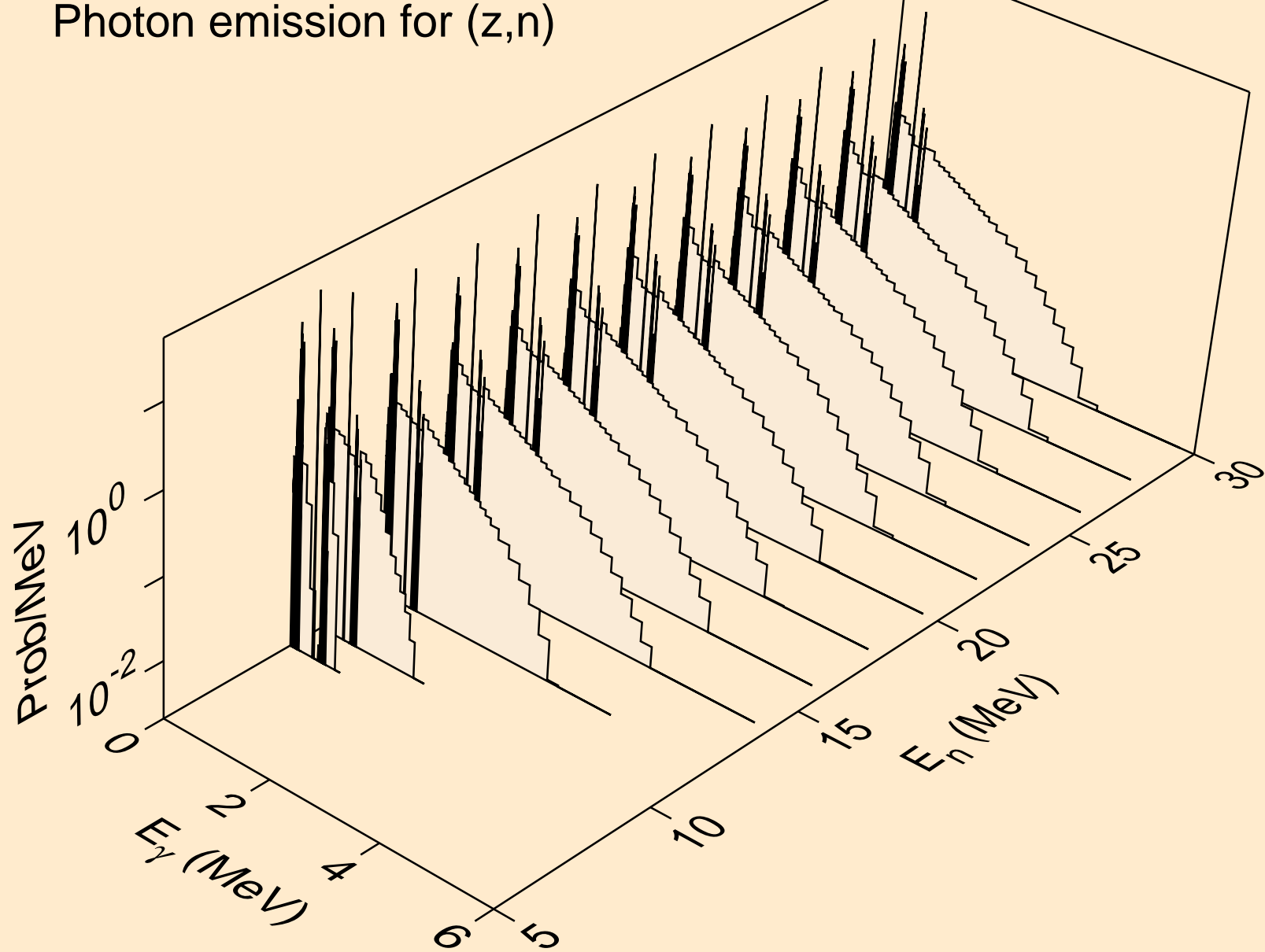

RN201M PROTON ACER TENDL-2023 LIBRARY; T=0.K  
Photon emission for (z,x)

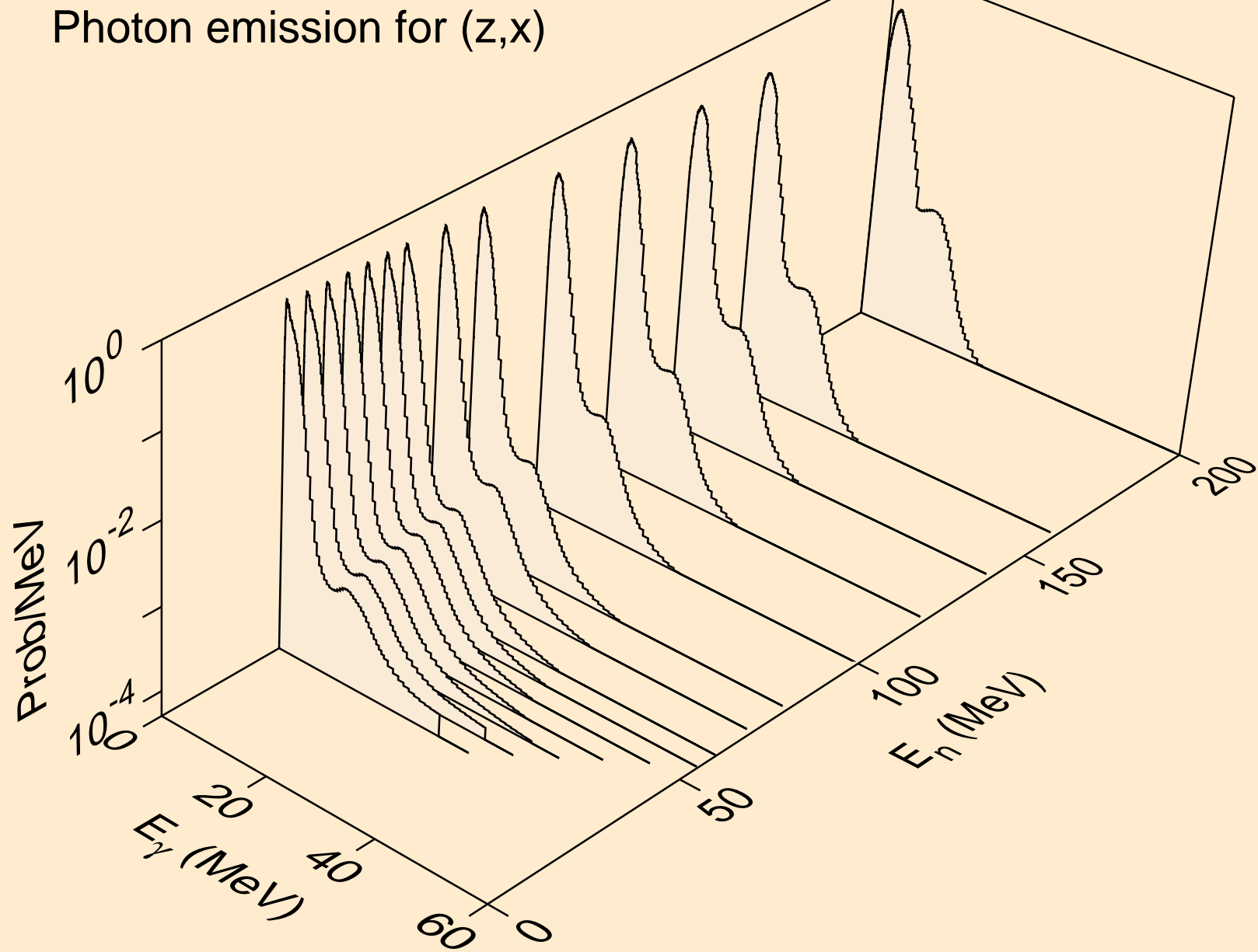

RN201M PROTON ACER TENDL-2023 LIBRARY; T=0.K  
Photon emission for (n,2n)

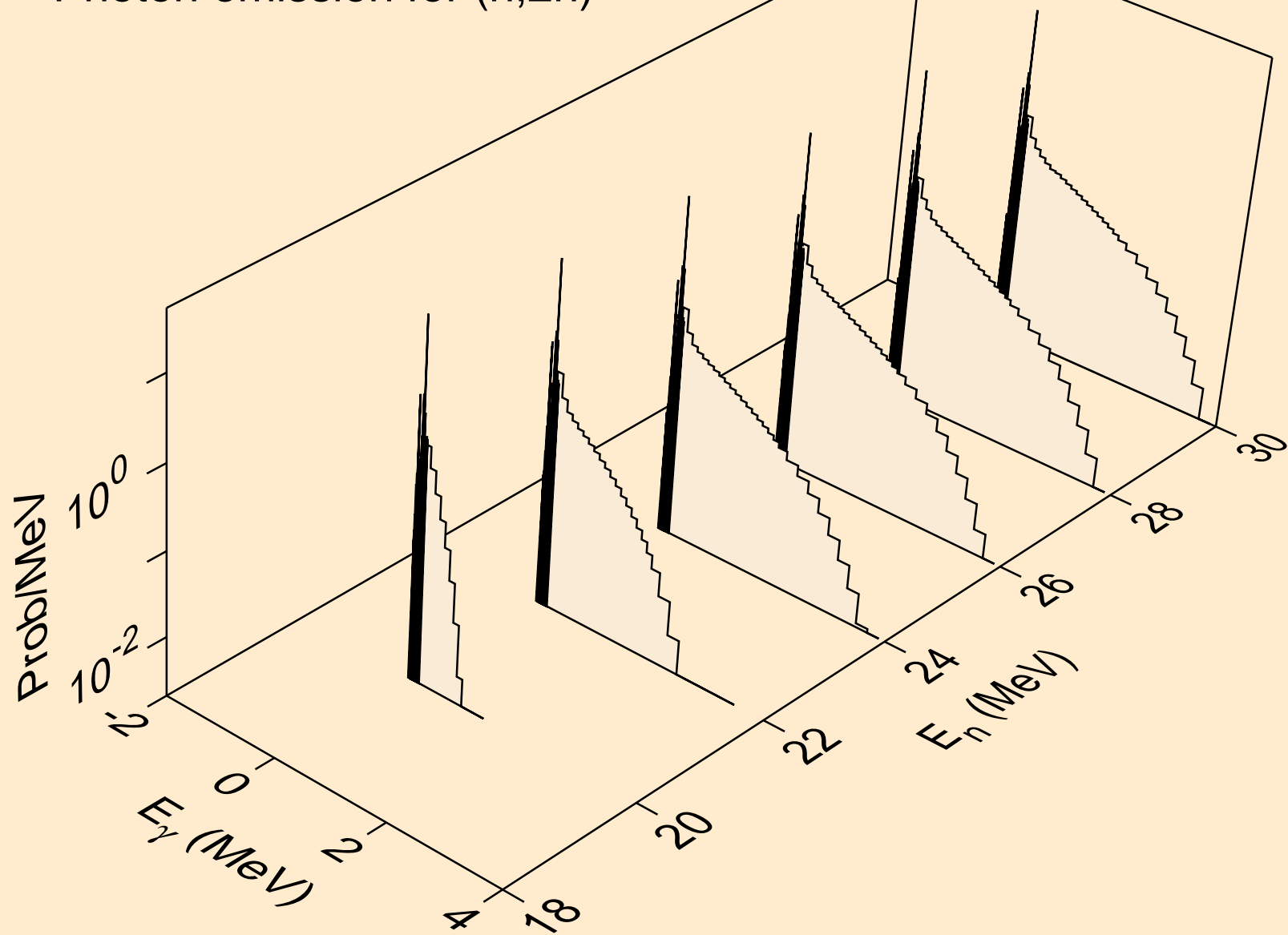

RN201M PROTON ACER TENDL-2023 LIBRARY; T=0.K  
Photon emission for (n,3n)

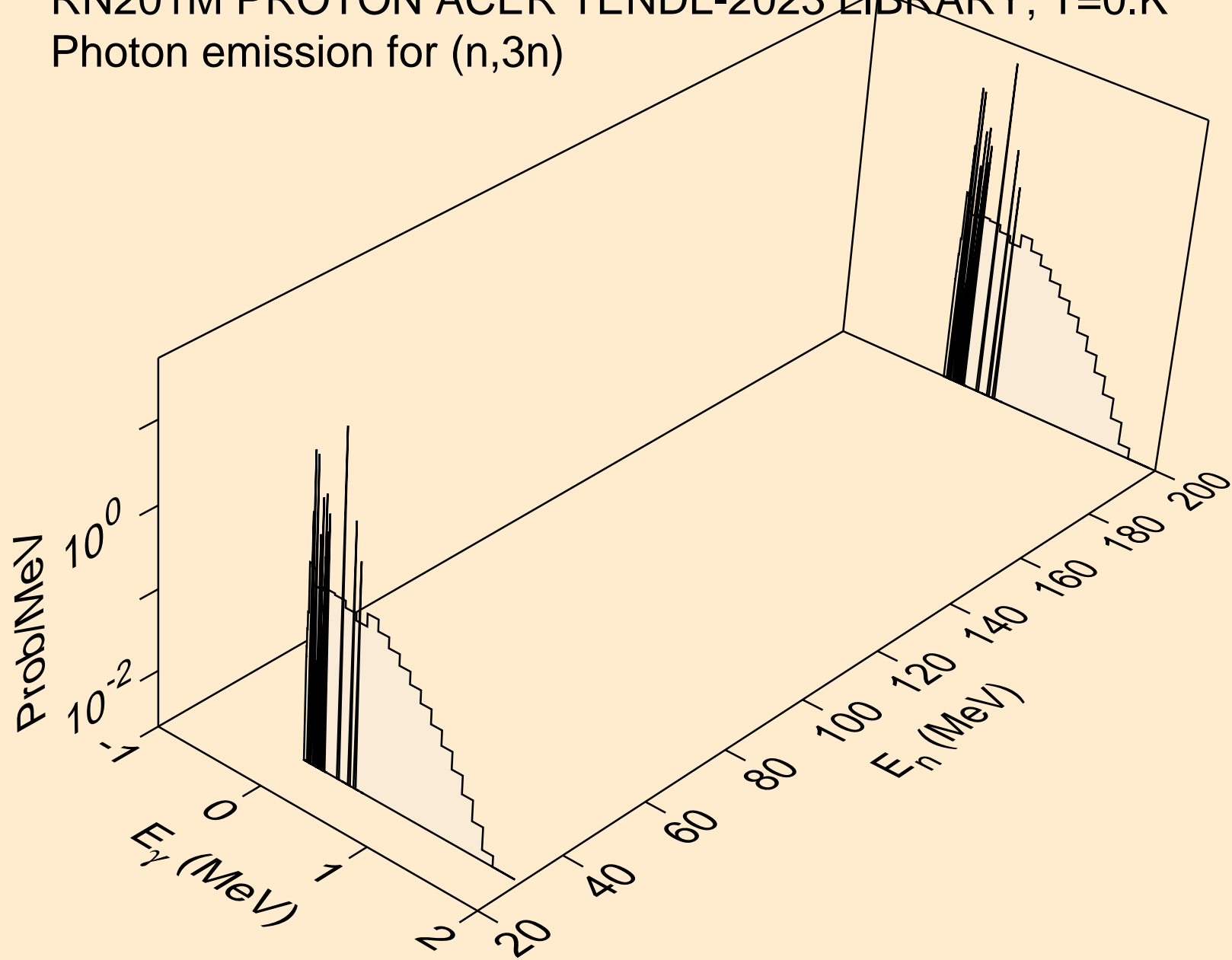

RN201M PROTON ACER TENDL-2023 LIBRARY; T=0.K  
Photon emission for (n,n\*)a

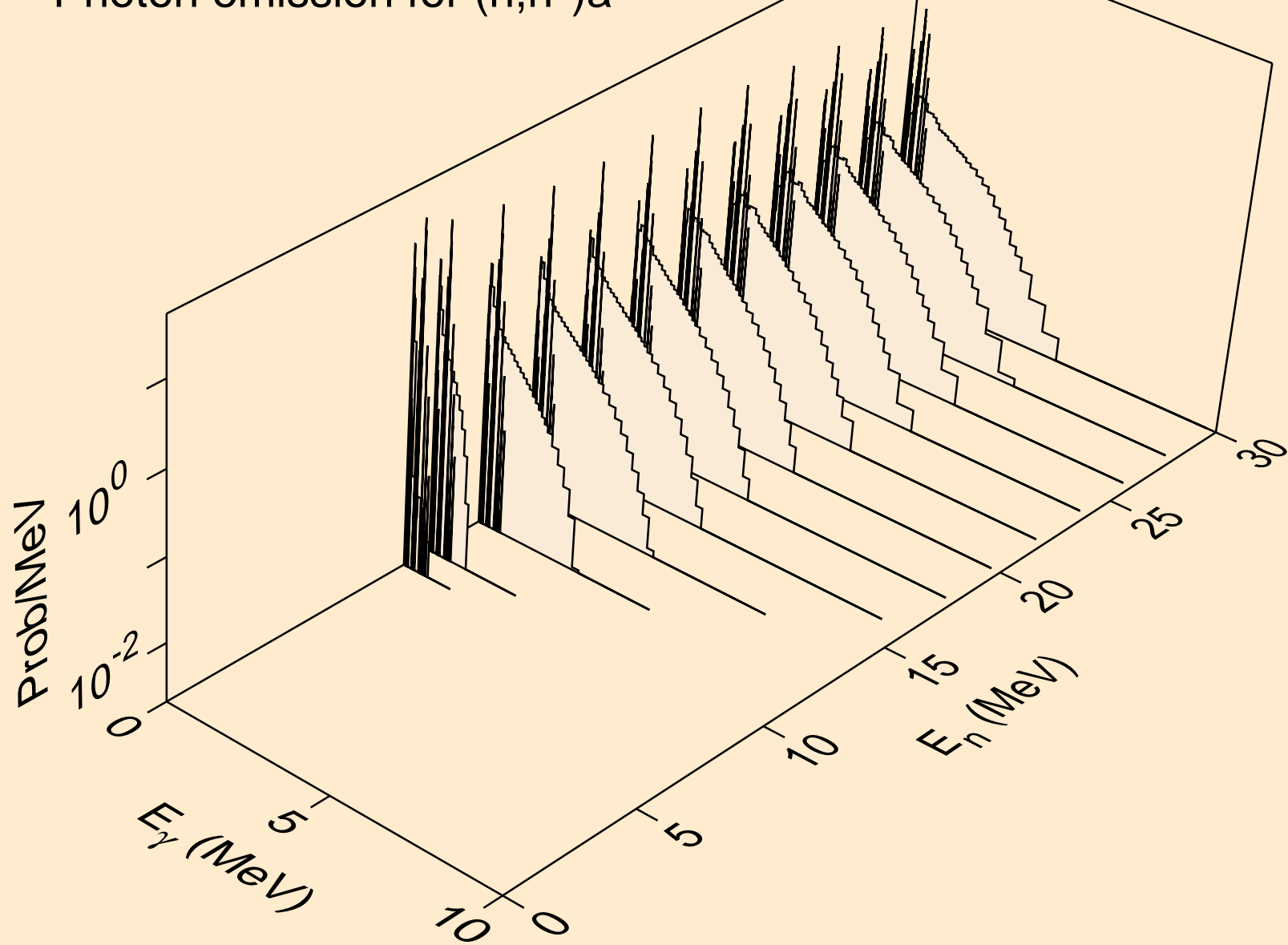



RN201M PROTON ACER TENDL-2023 LIBRARY; T=0.K  
Photon emission for (n,2n)a

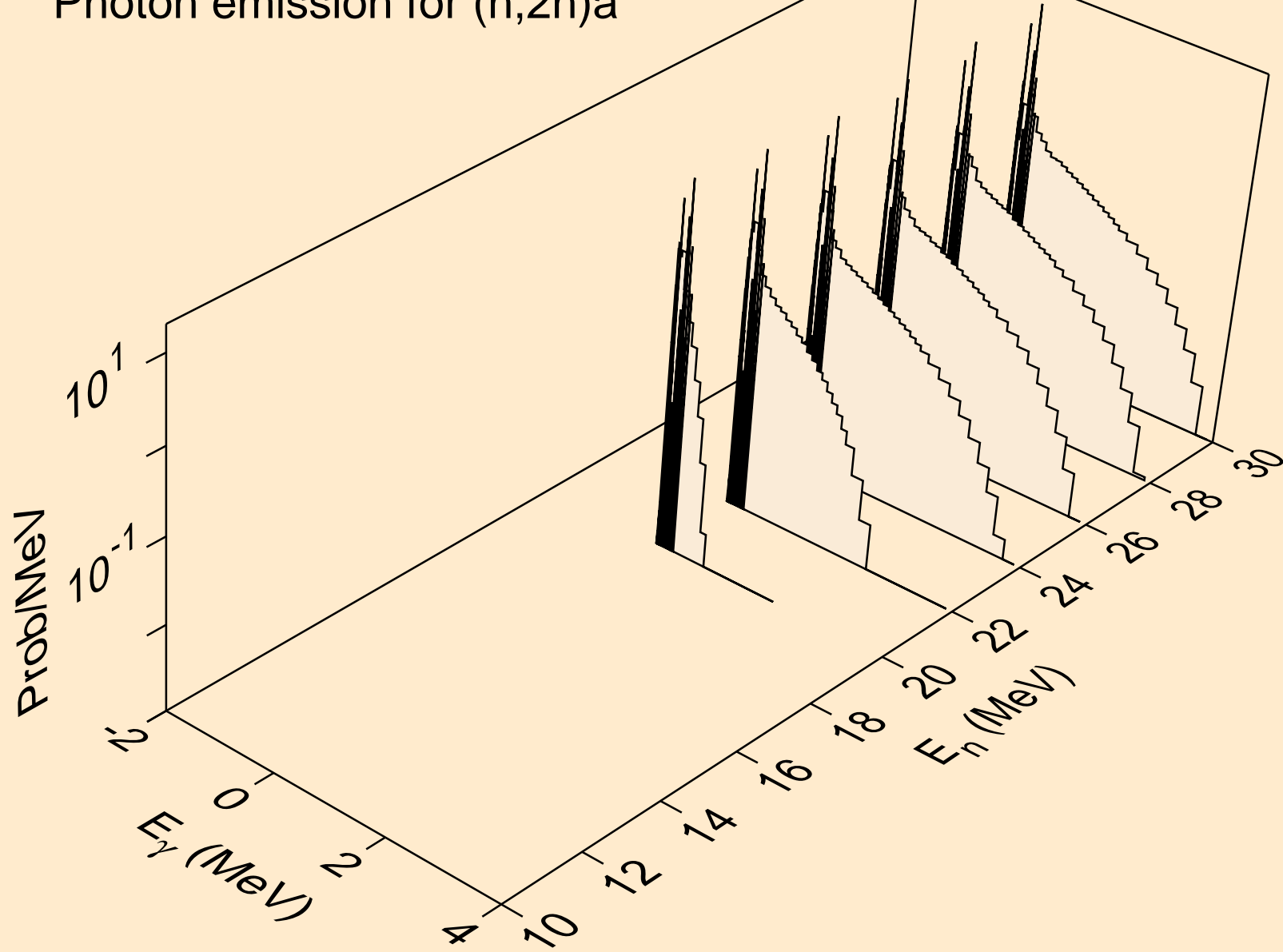

RN201M PROTON ACER TENDL-2023 LIBRARY; T=0.K  
Photon emission for (n,n\*)p

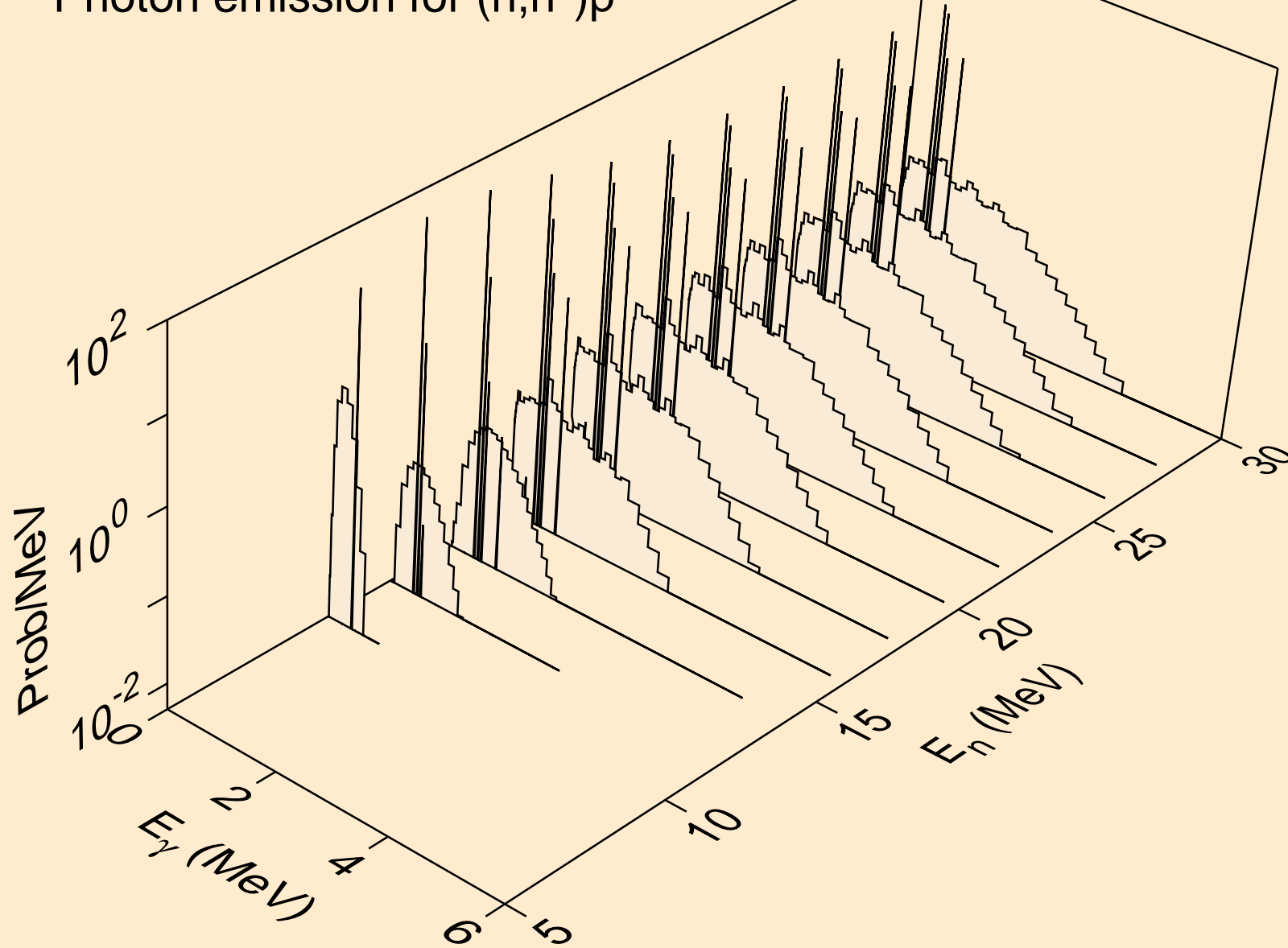

RN201M PROTON ACER TENDL-2023 LIBRARY; T=0.K  
Photon emission for (n,n\*)2a

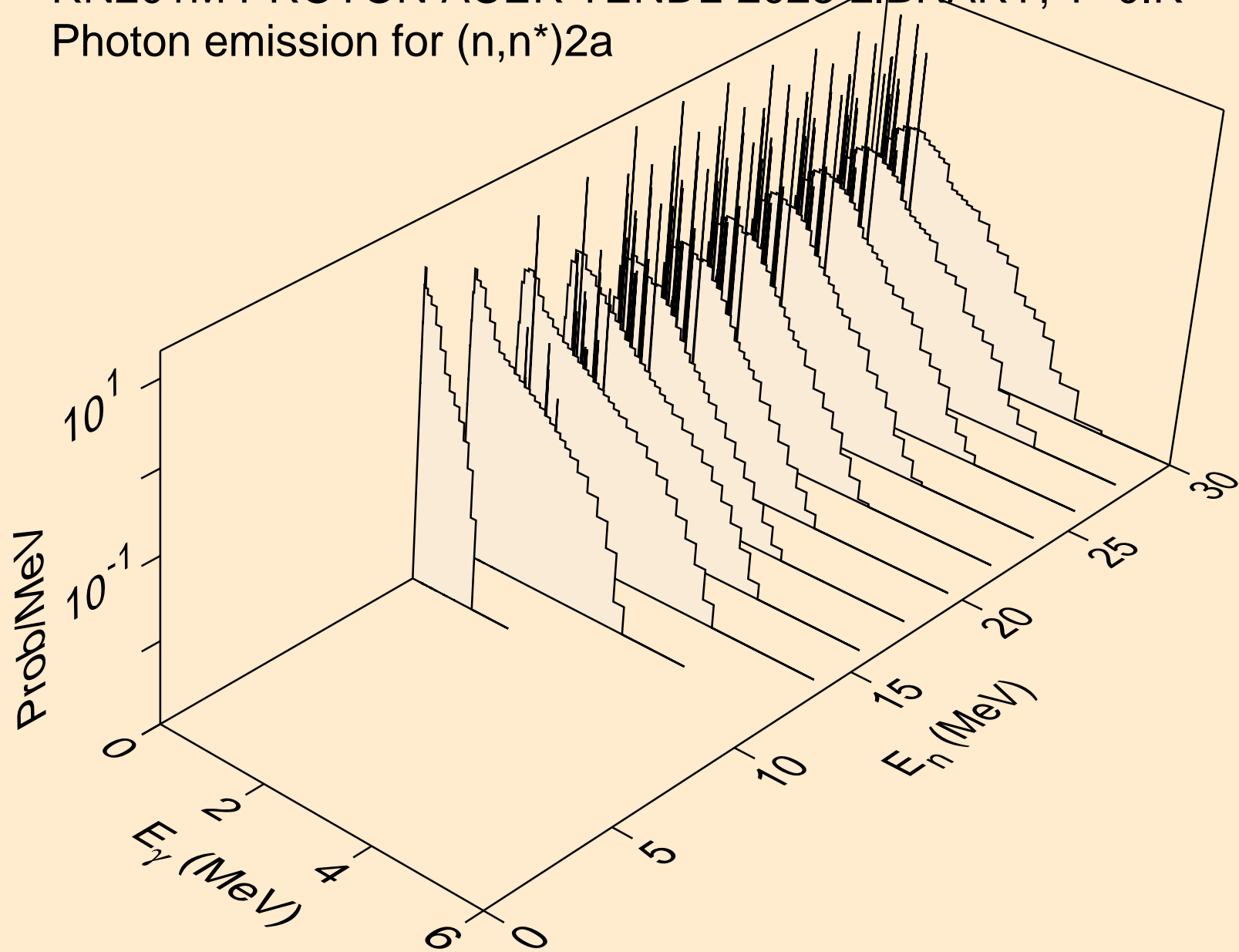

RN201M PROTON ACER TENDL-2023 LIBRARY; T=0.K  
Photon emission for (n,n\*)d

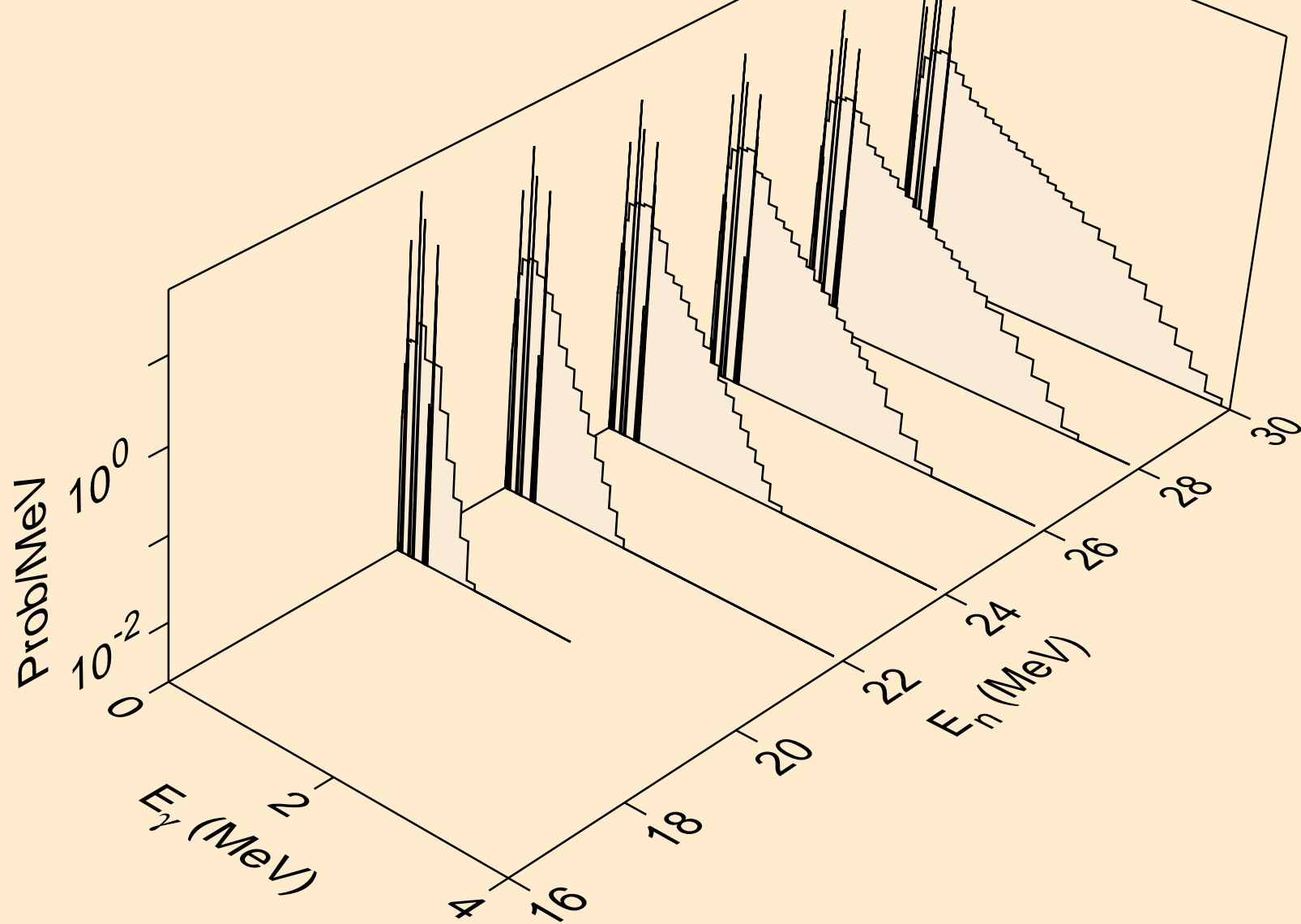

RN201M PROTON ACER TENDL-2023 LIBRARY; T=0.K  
Photon emission for (n,n\*)t

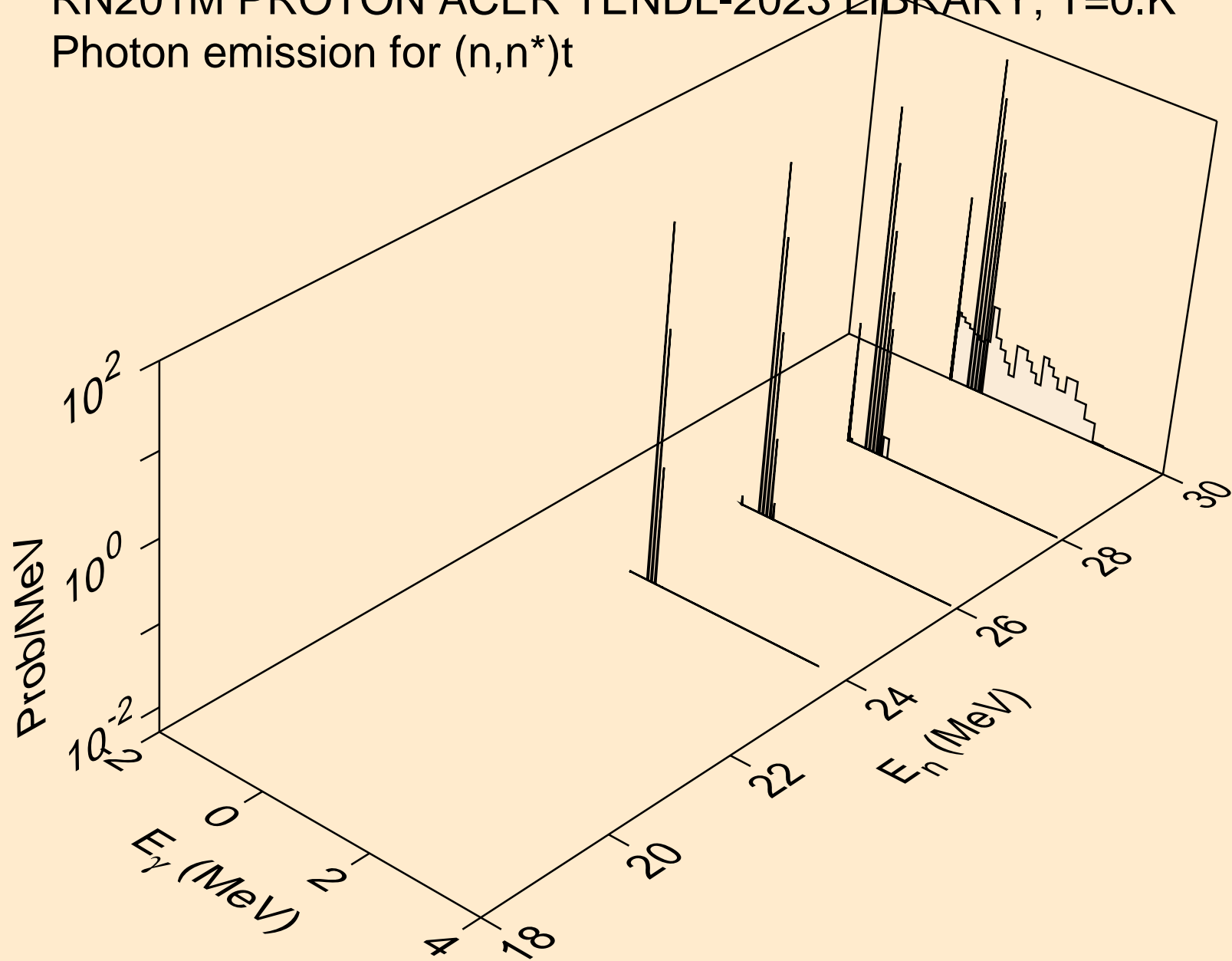

RN201M PROTON ACER TENDL-2023 LIBRARY; T=0.K  
Photon emission for (n,n\*)he3

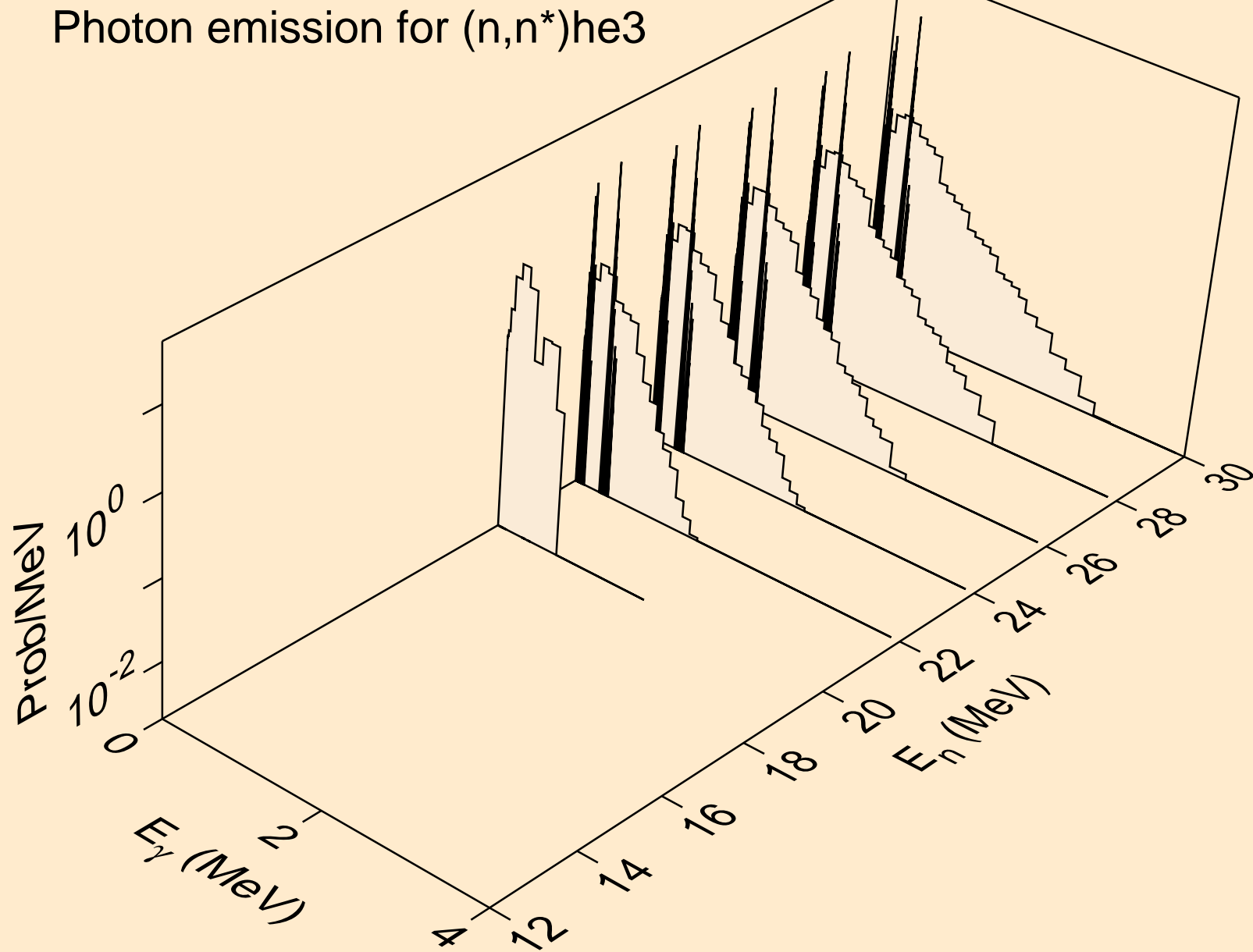

RN201M PROTON ACER TENDL-2023 LIBRARY; T=0.K  
Photon emission for (n,2np)

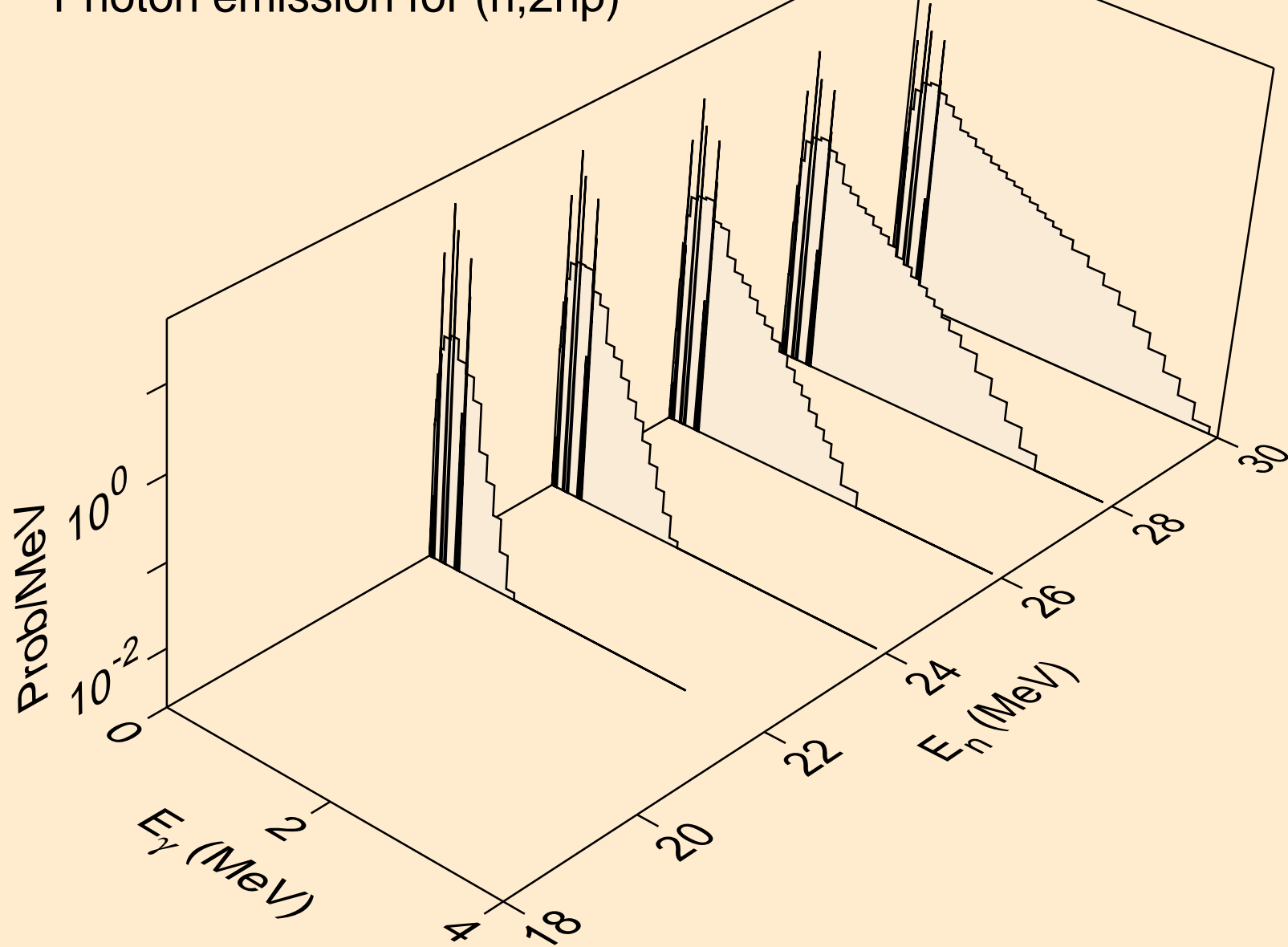

RN201M PROTON ACER TENDL-2023 LIBRARY; T=0.K  
Photon emission for (n,n2p)

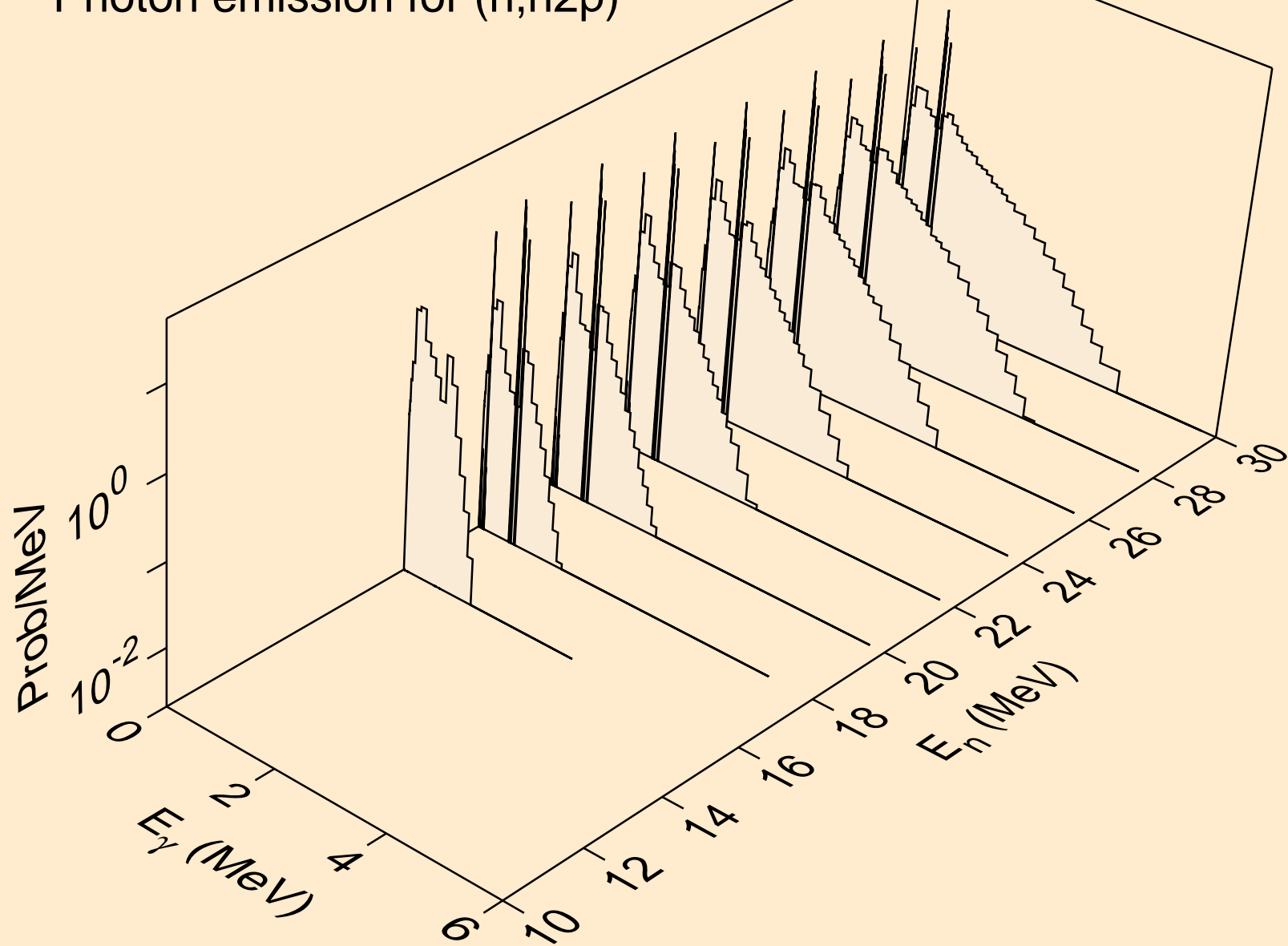



RN201M PROTON ACER TENDL-2023 LIBRARY; T=0.K  
Photon emission for (n,npa)

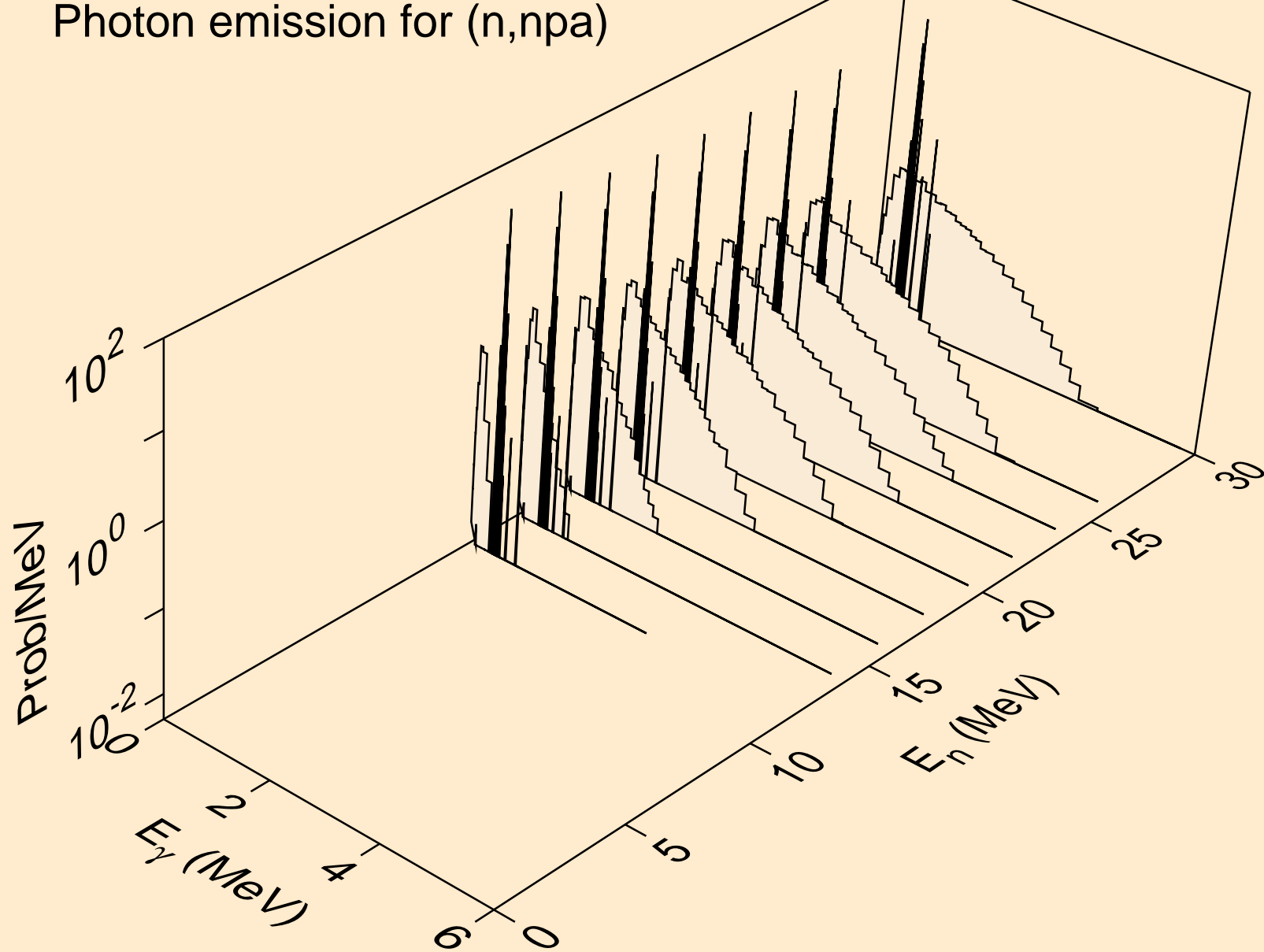

RN201M PROTON ACER TENDL-2023 LIBRARY; T=0.K  
Photon emission for (n,gma)

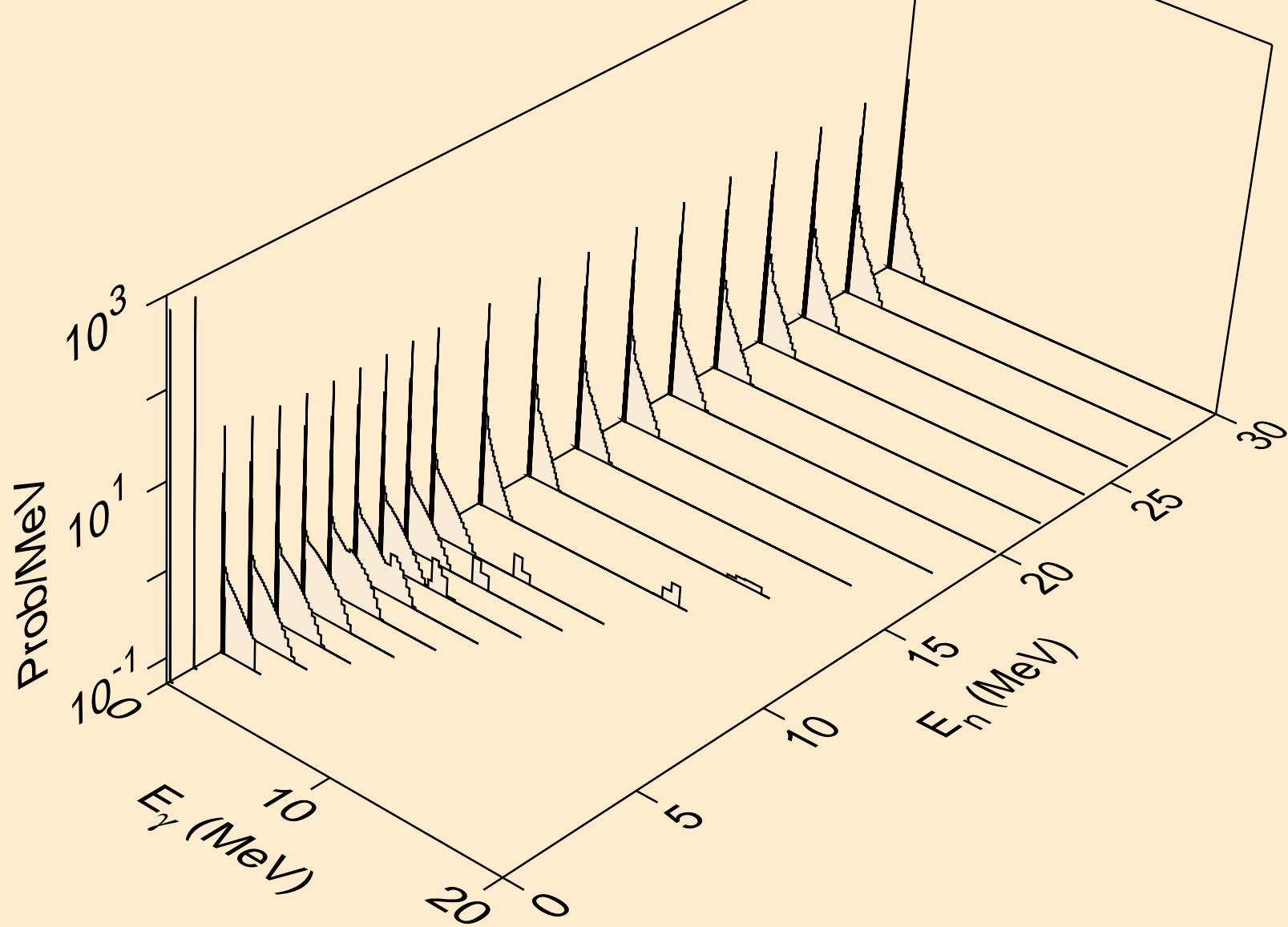

RN201M PROTON ACER TENDL-2023 LIBRARY; T=0.K  
Photon emission for inelastic

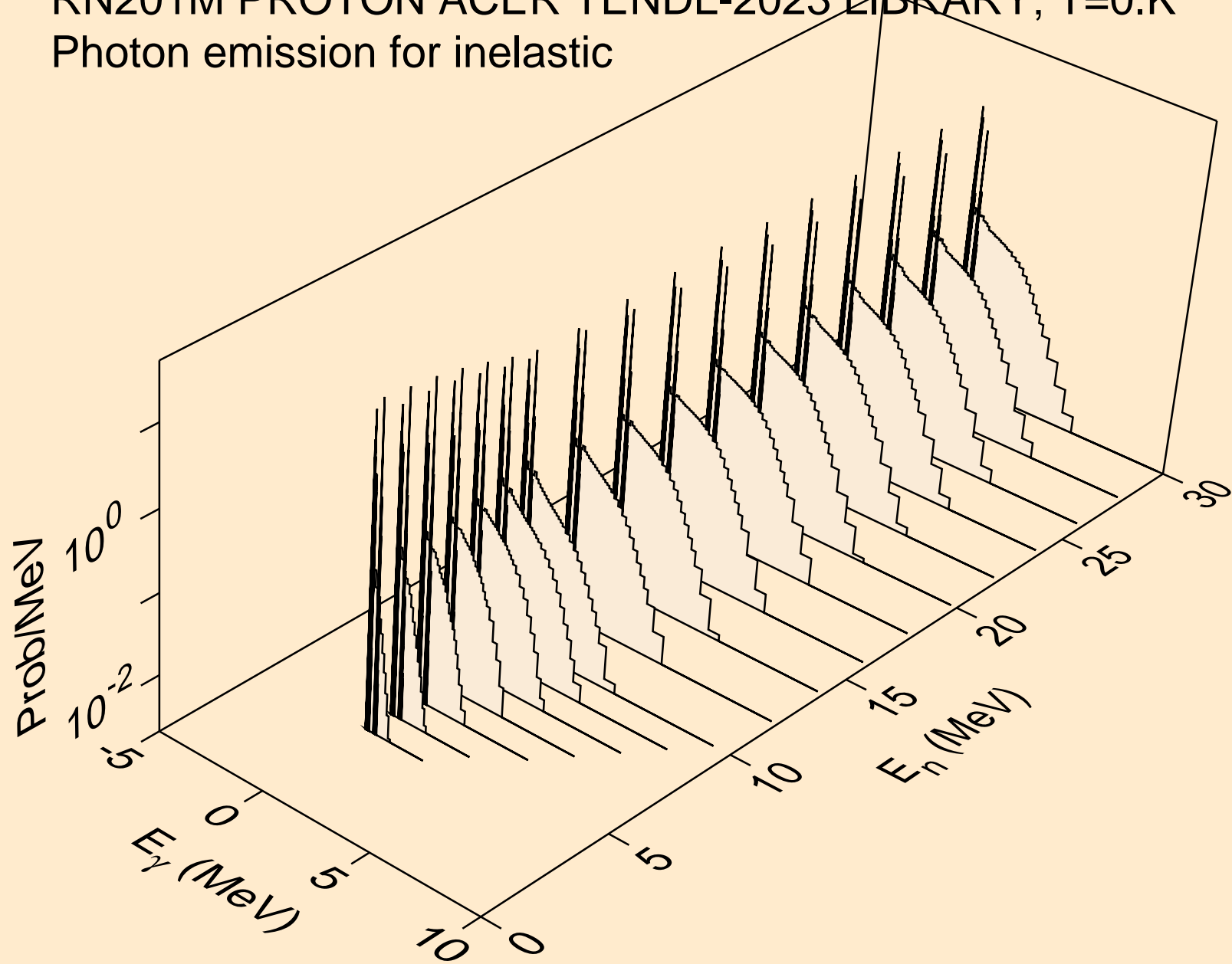

RN201M PROTON ACER TENDL-2023 LIBRARY; T=0.K  
Photon emission for (n,d)

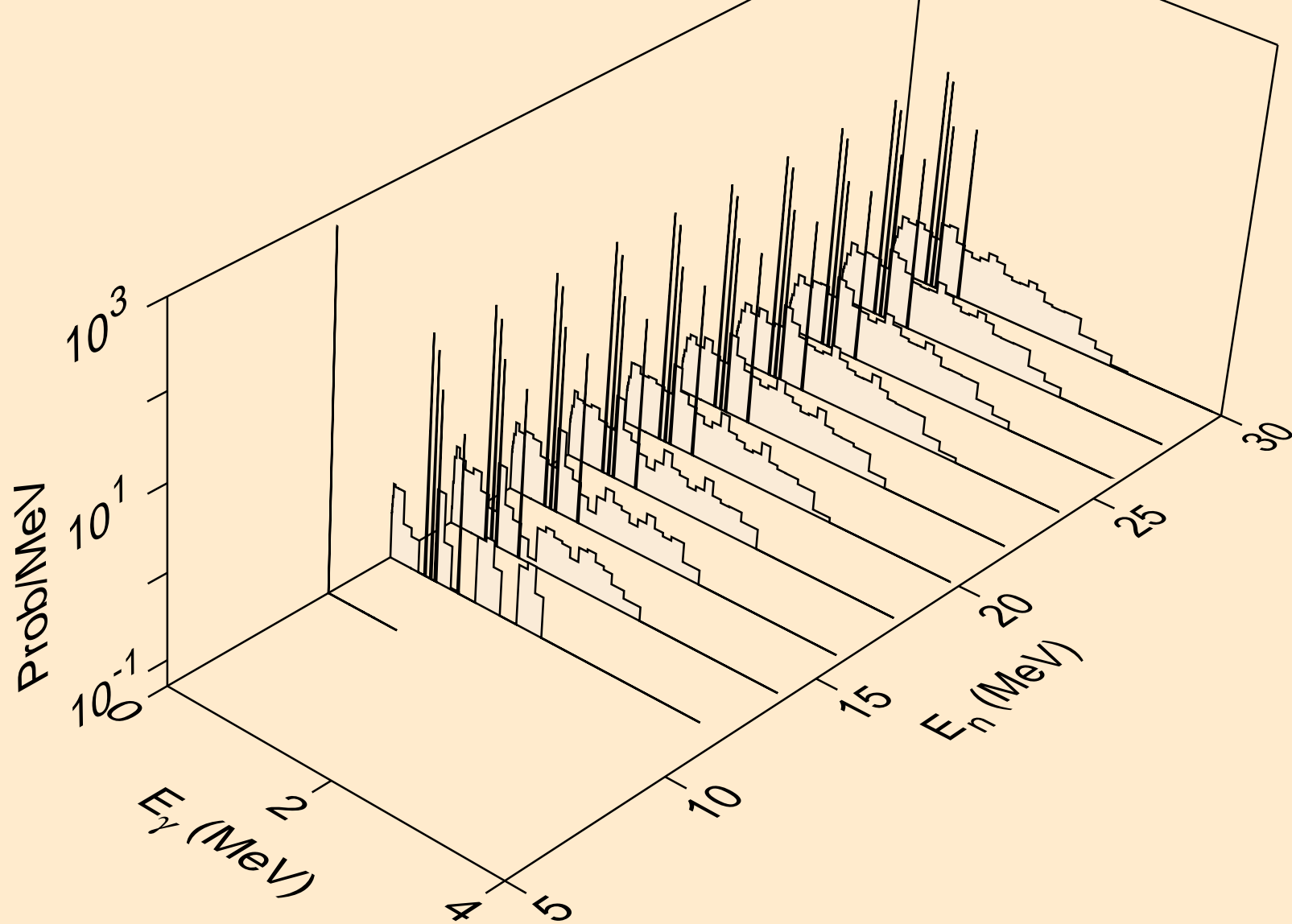

RN201M PROTON ACER TENDL-2023 LIBRARY; T=0.K  
Photon emission for (n,t)

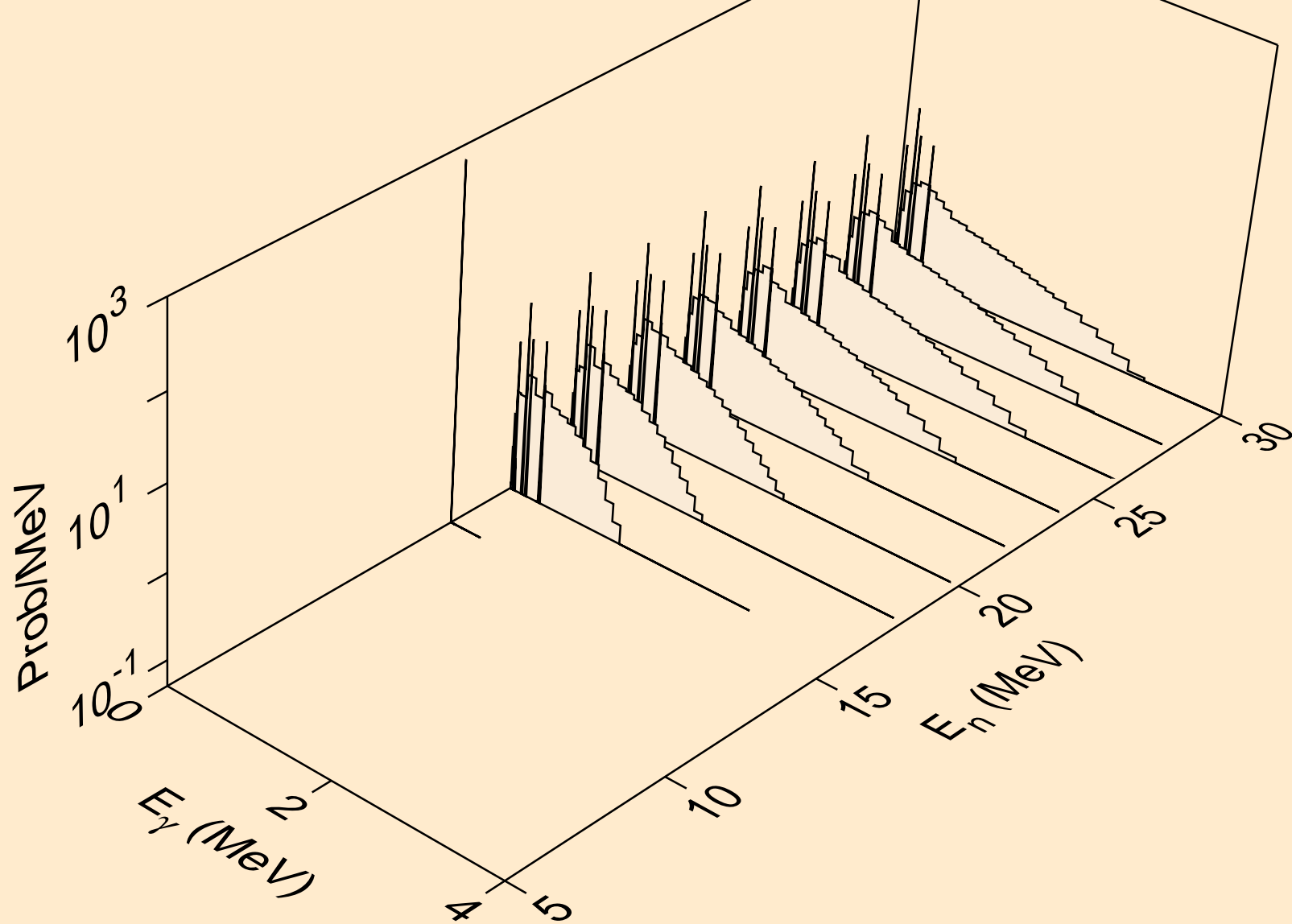

RN201M PROTON ACER TENDL-2023 LIBRARY; T=0.K  
Photon emission for (n,he3)

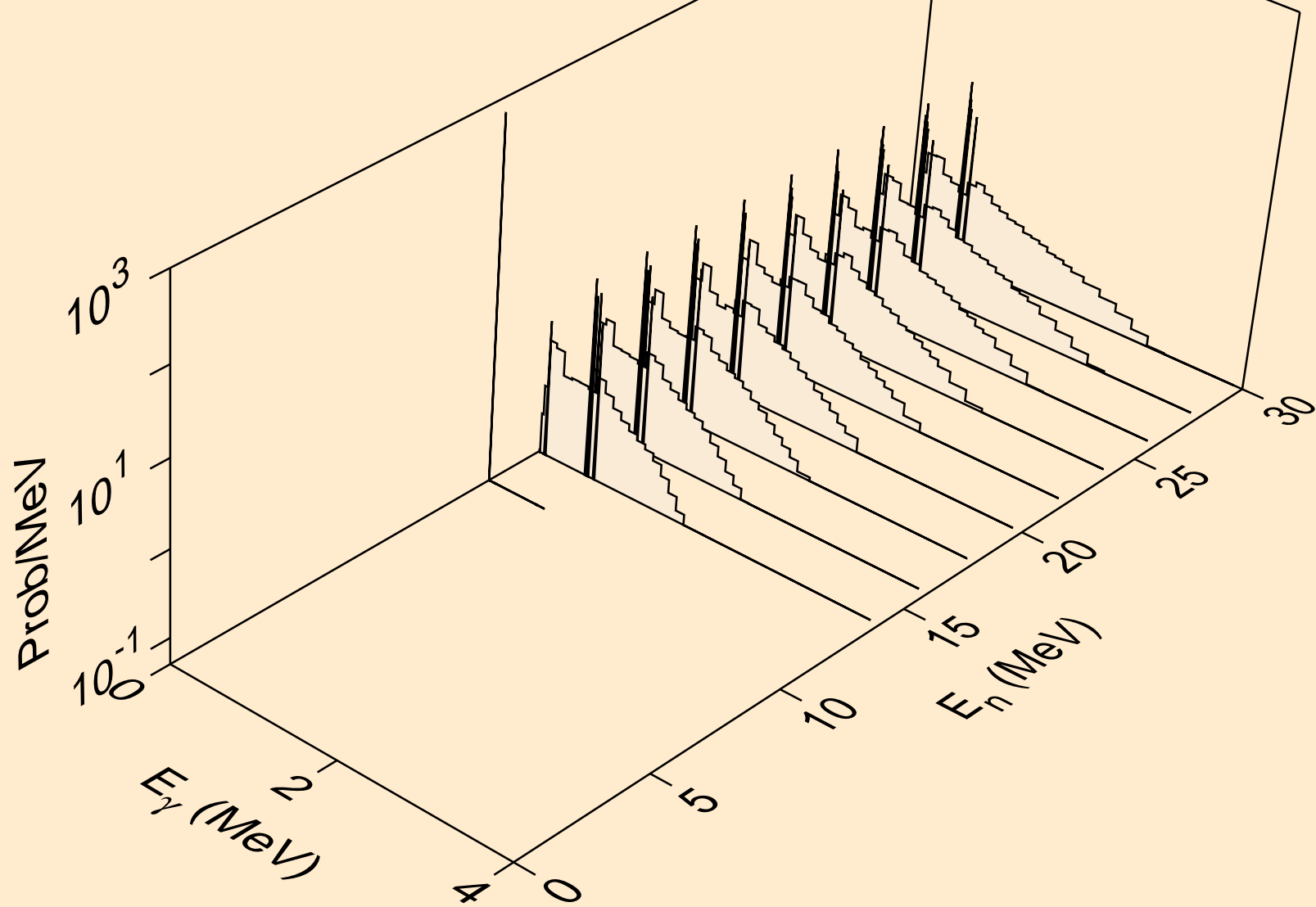

RN201M PROTON ACER TENDL-2023 LIBRARY; T=0.K  
Photon emission for (n,a)

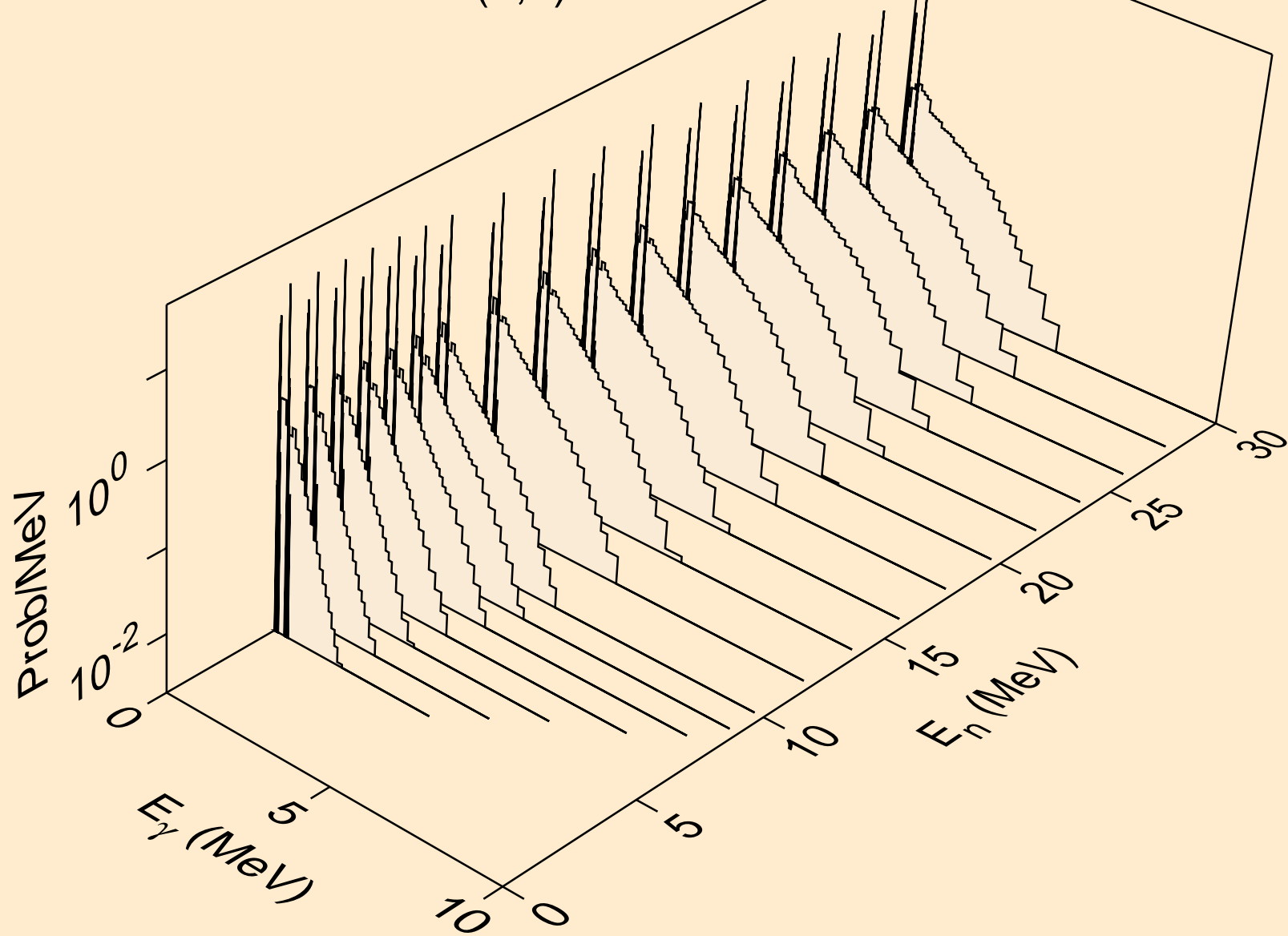

RN201M PROTON ACER TENDL-2023 LIBRARY; T=0.K  
Photon emission for (n,2a)

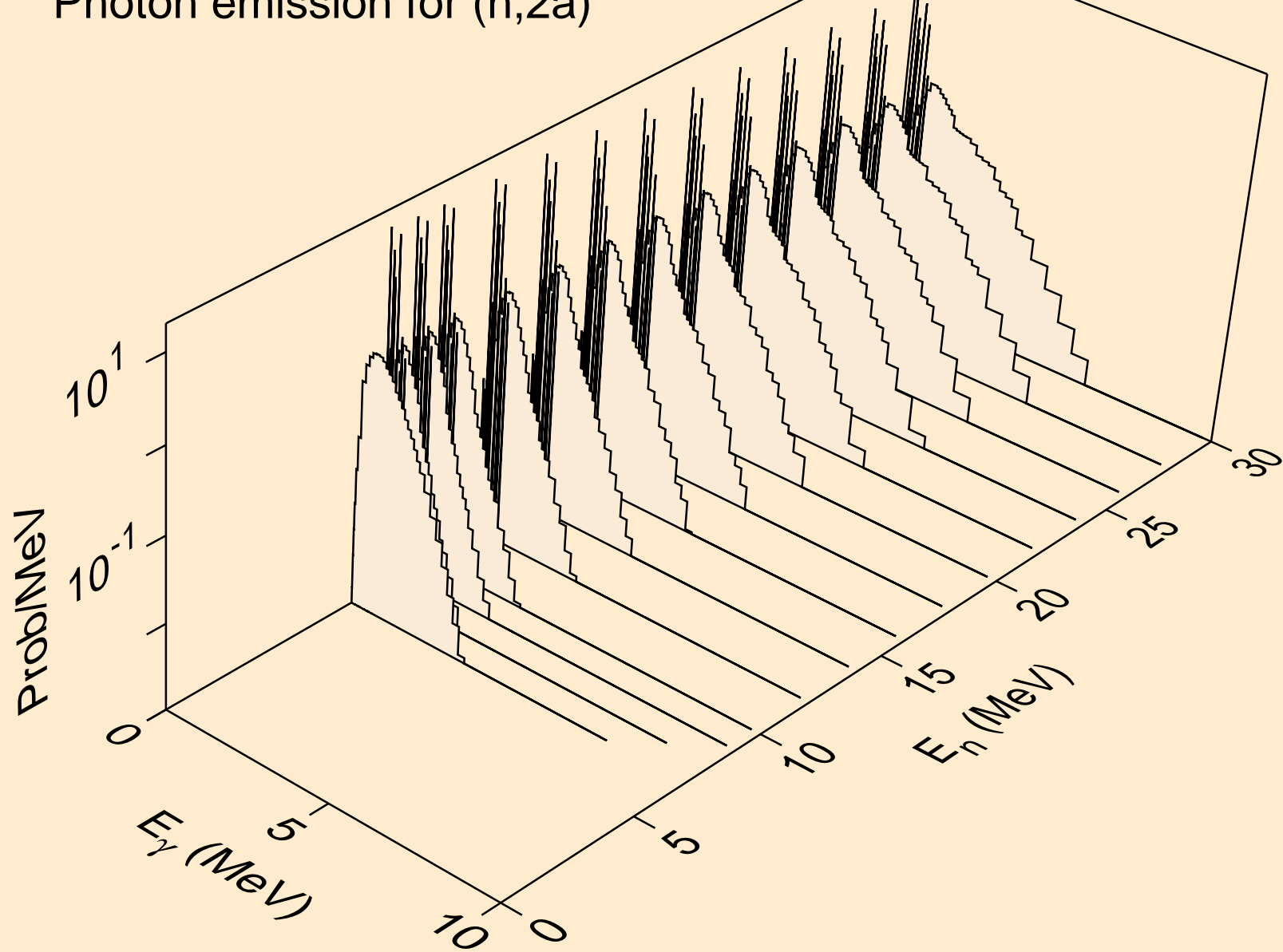



RN201M PROTON ACER TENDL-2023 LIBRARY; T=0.K  
Photon emission for (n,2p)

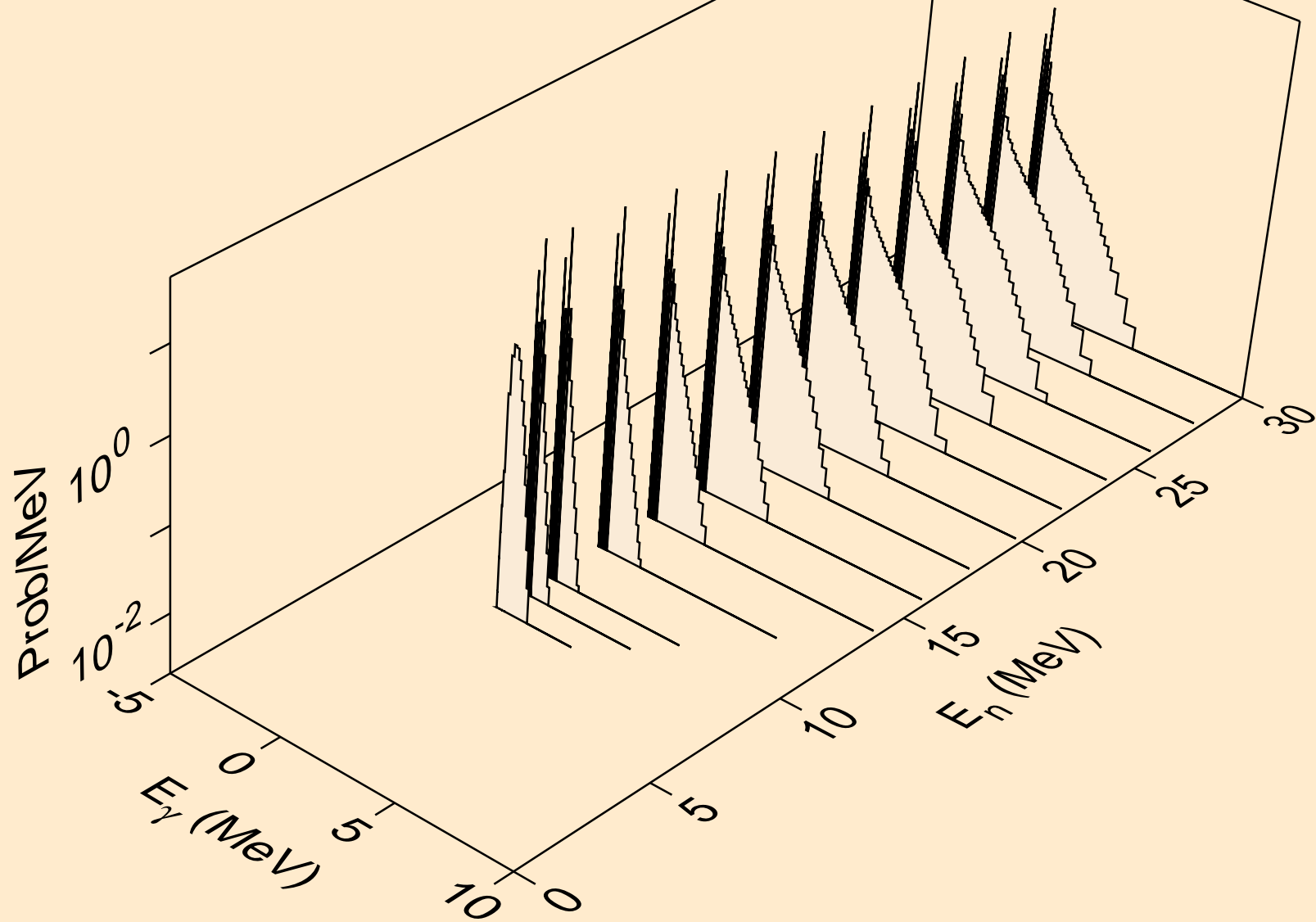

RN201M PROTON ACER TENDL-2023 LIBRARY; T=0.K  
Photon emission for (n,pa)

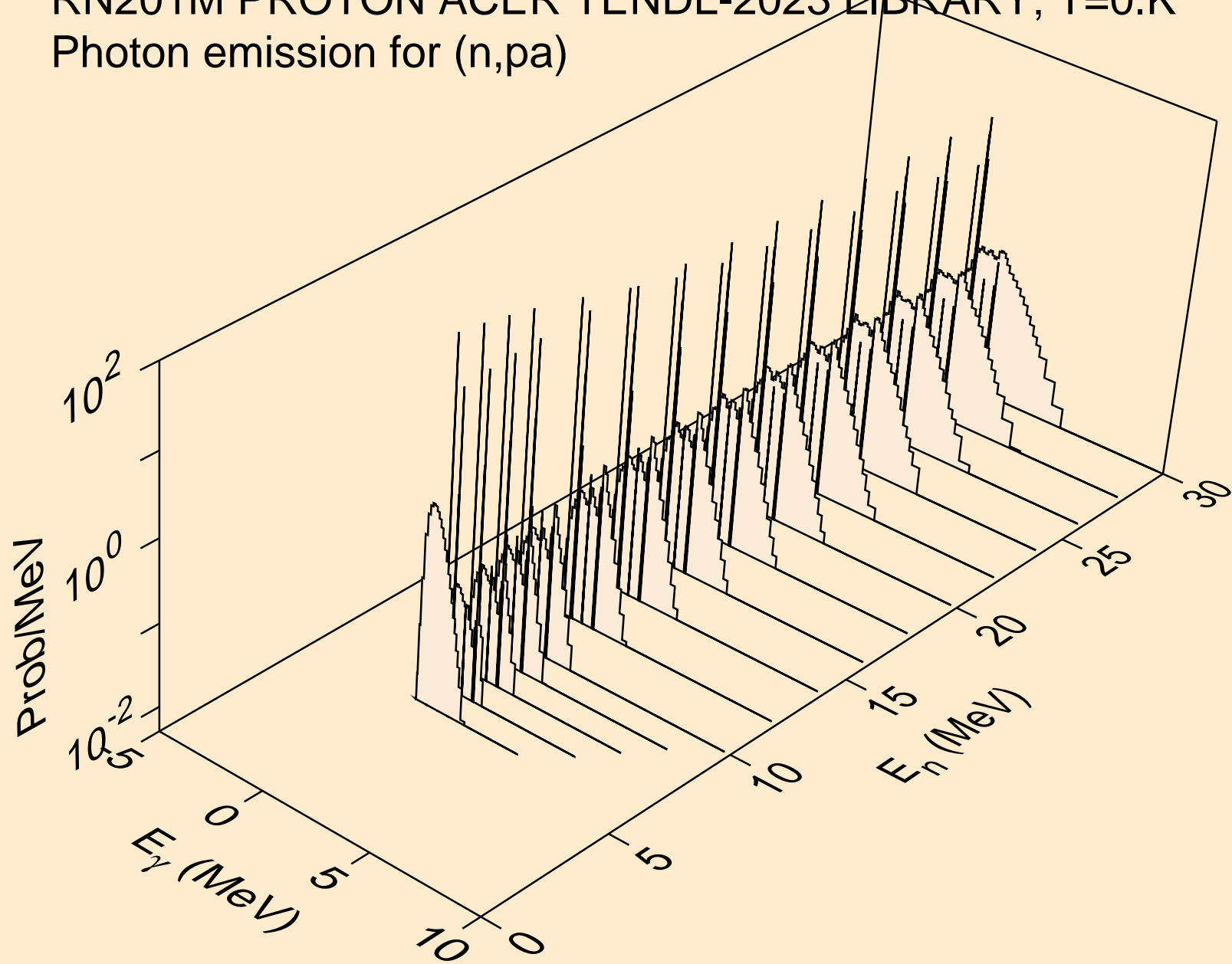

RN201M PROTON ACER TENDL-2023 LIBRARY; T=0.K  
Photon emission for (n,pd)

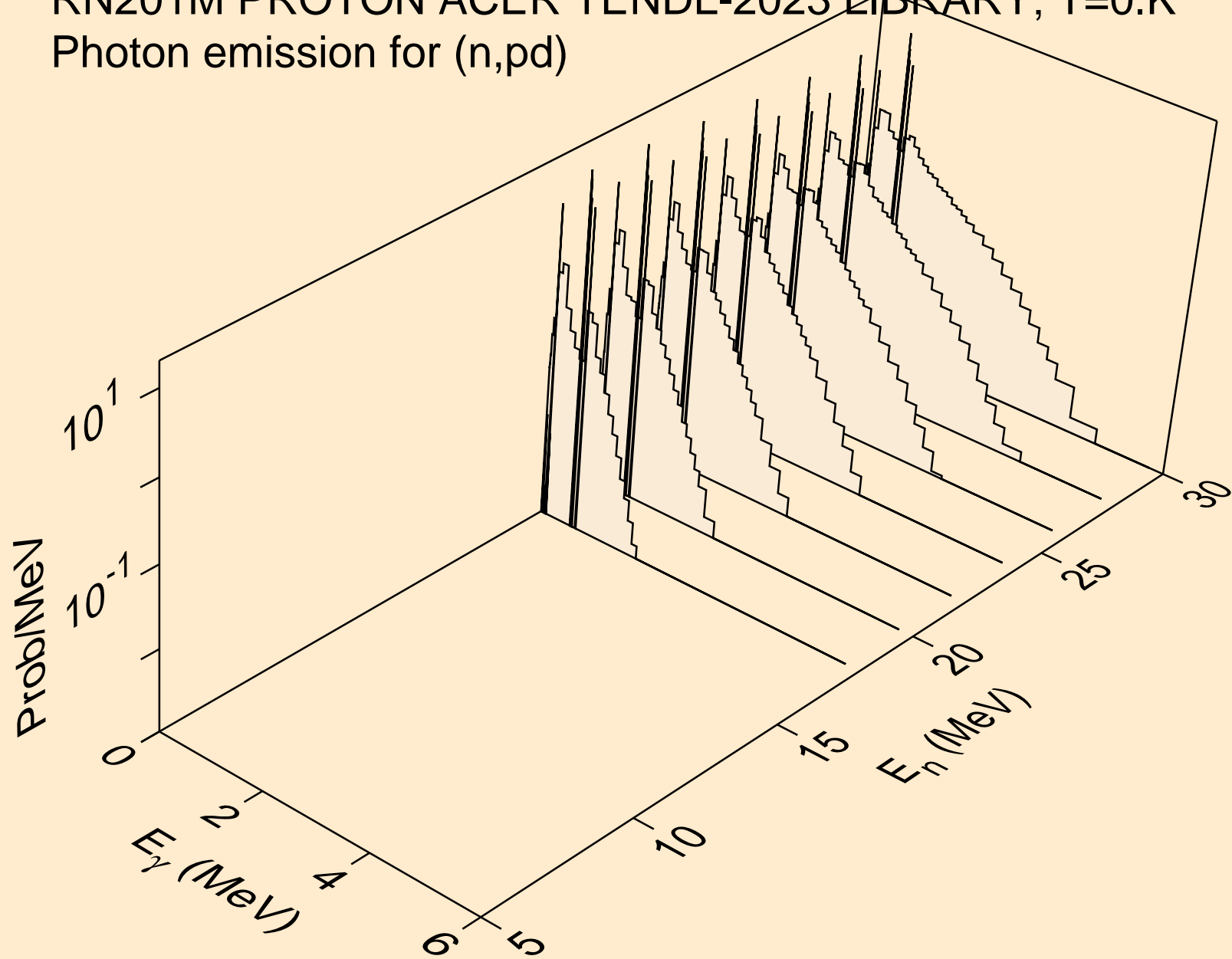

RN201M PROTON ACER TENDL-2023 LIBRARY; T=0.K  
Photon emission for (n,pt)

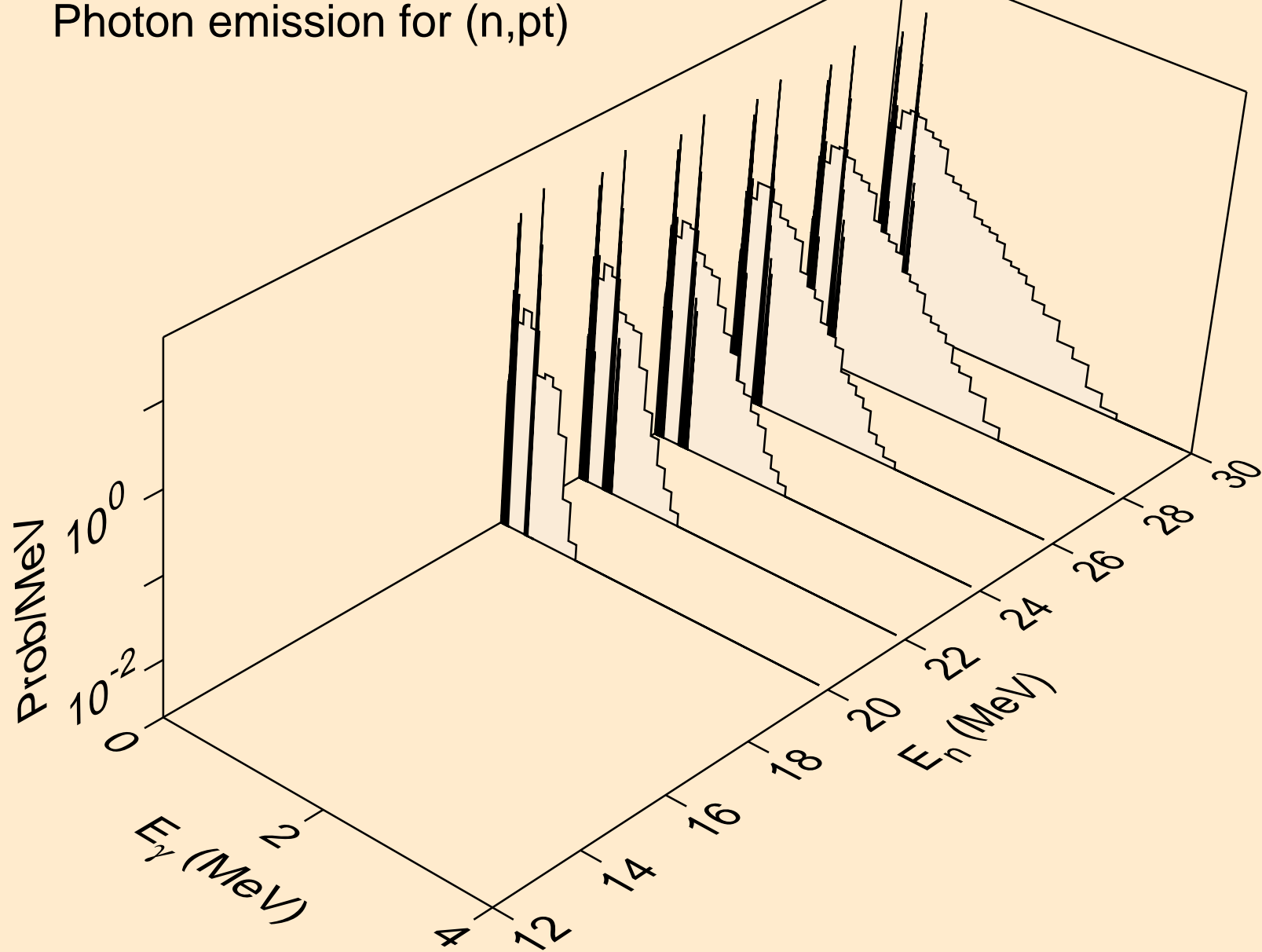

RN201M PROTON ACER TENDL-2023 LIBRARY; T=0.K  
Photon emission for (n,da)

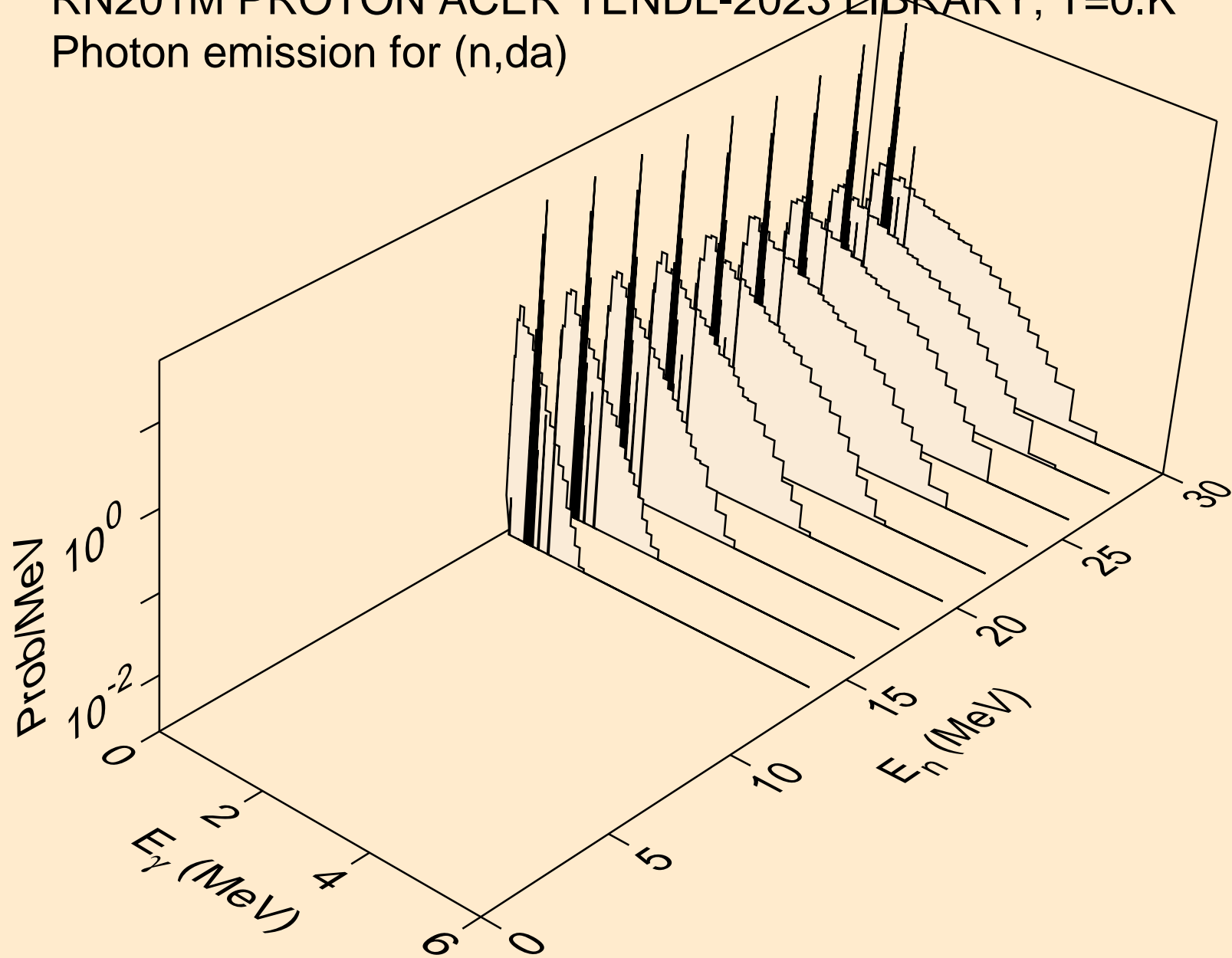

RN201M PROTON ACER TENDL-2023 LIBRARY; T=0.K  
Particle heating contributions

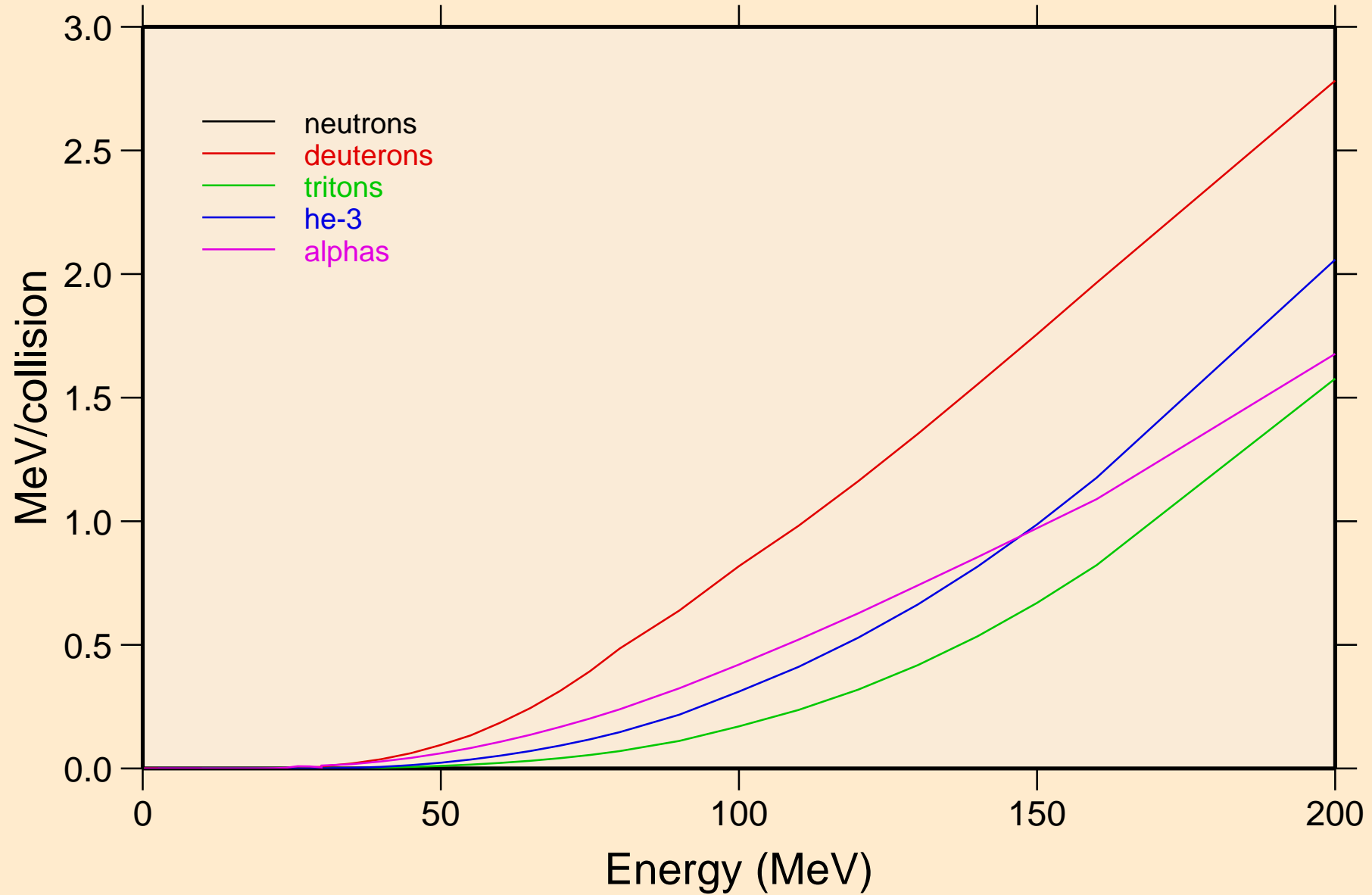

RN201M PROTON ACER TENDL-2023 LIBRARY; T=0.K  
Recoil Heating

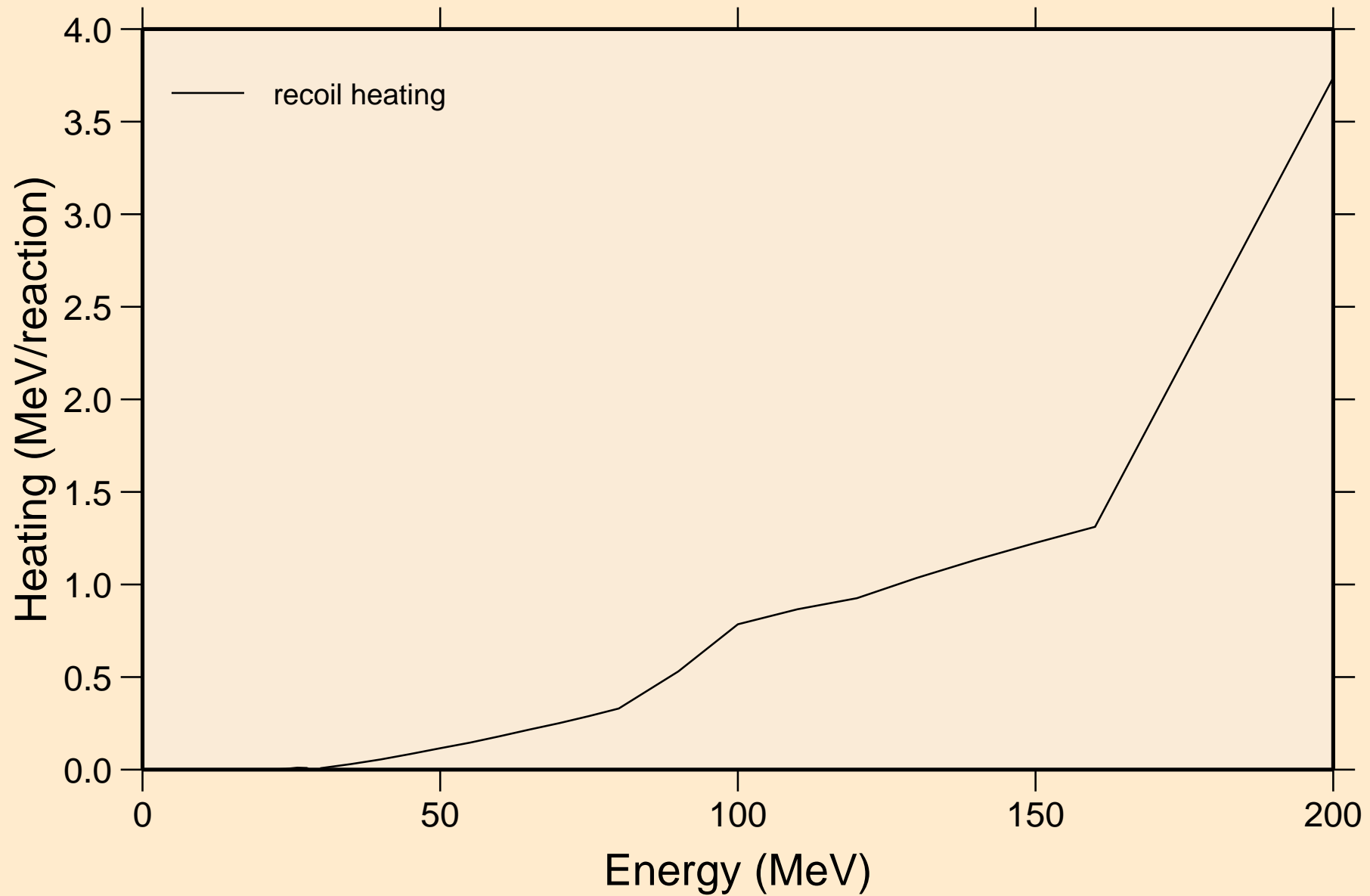

RN201M PROTON ACER TENDL-2023 LIBRARY; T=0.K  
Particle production cross sections

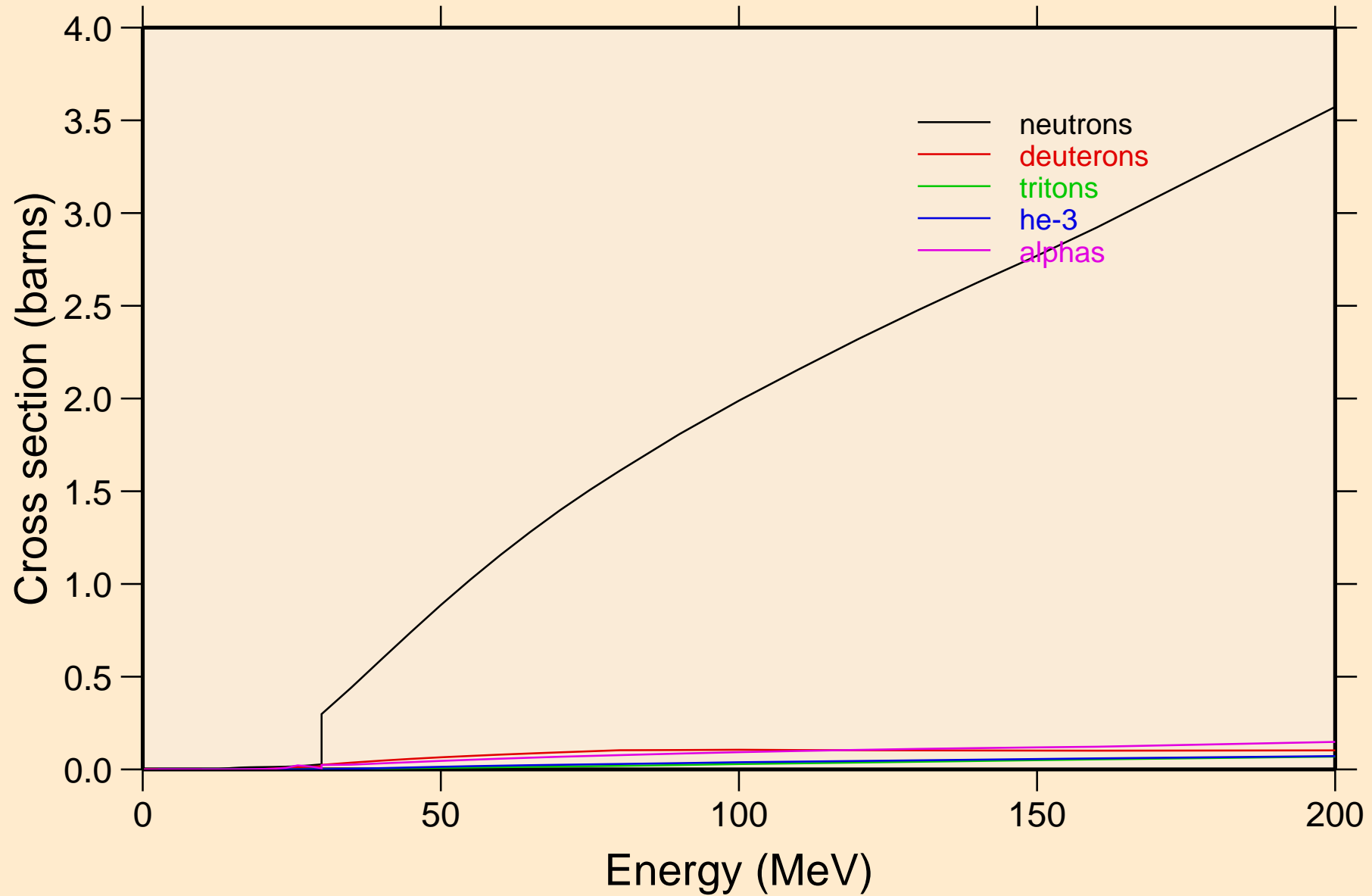



RN201M PROTON ACER TENDL-2023 LIBRARY; T=0.K  
neutrons from (p,n)

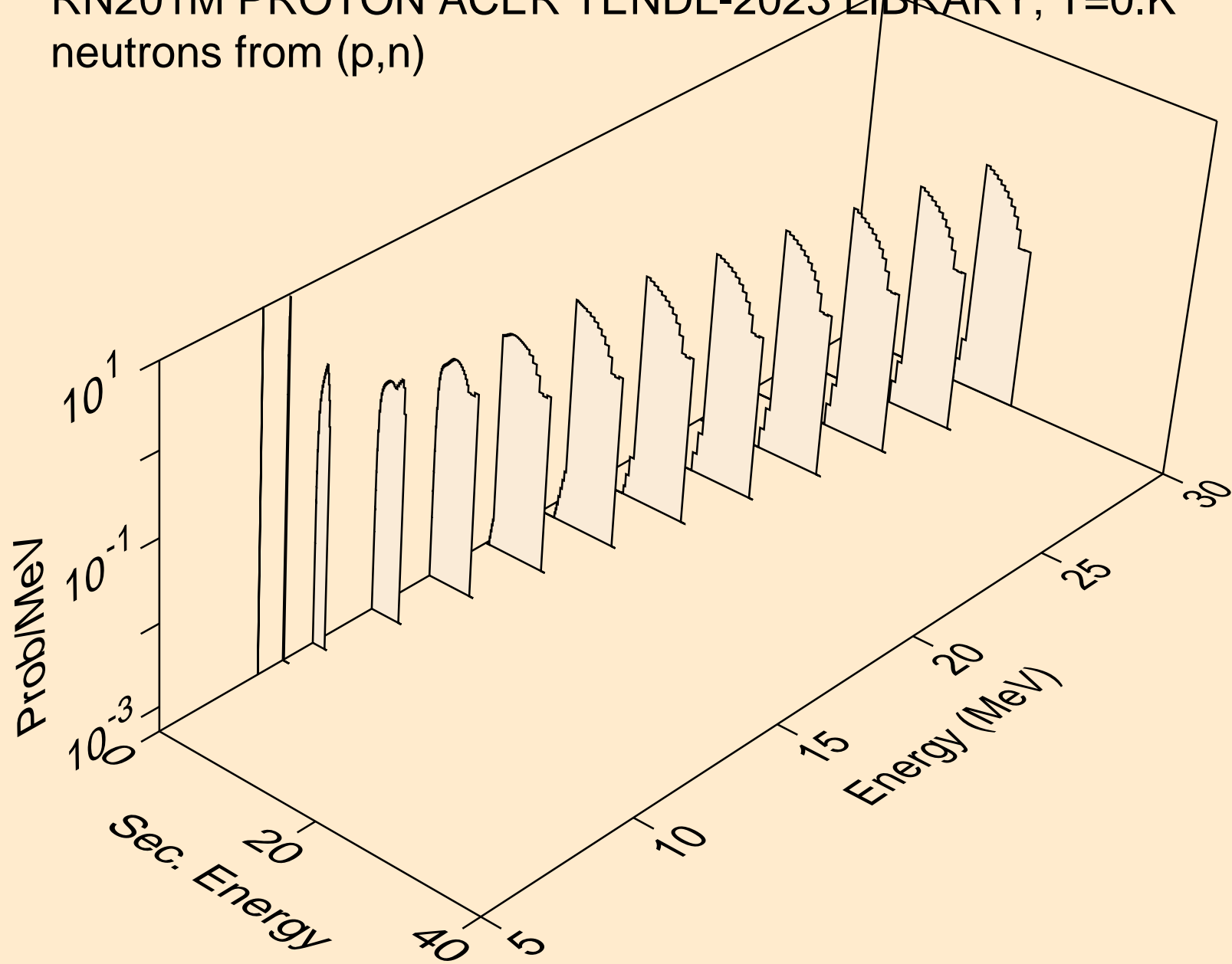

RN201M PROTON ACER TENDL-2023 LIBRARY; T=0.K  
neutrons from (p,x)

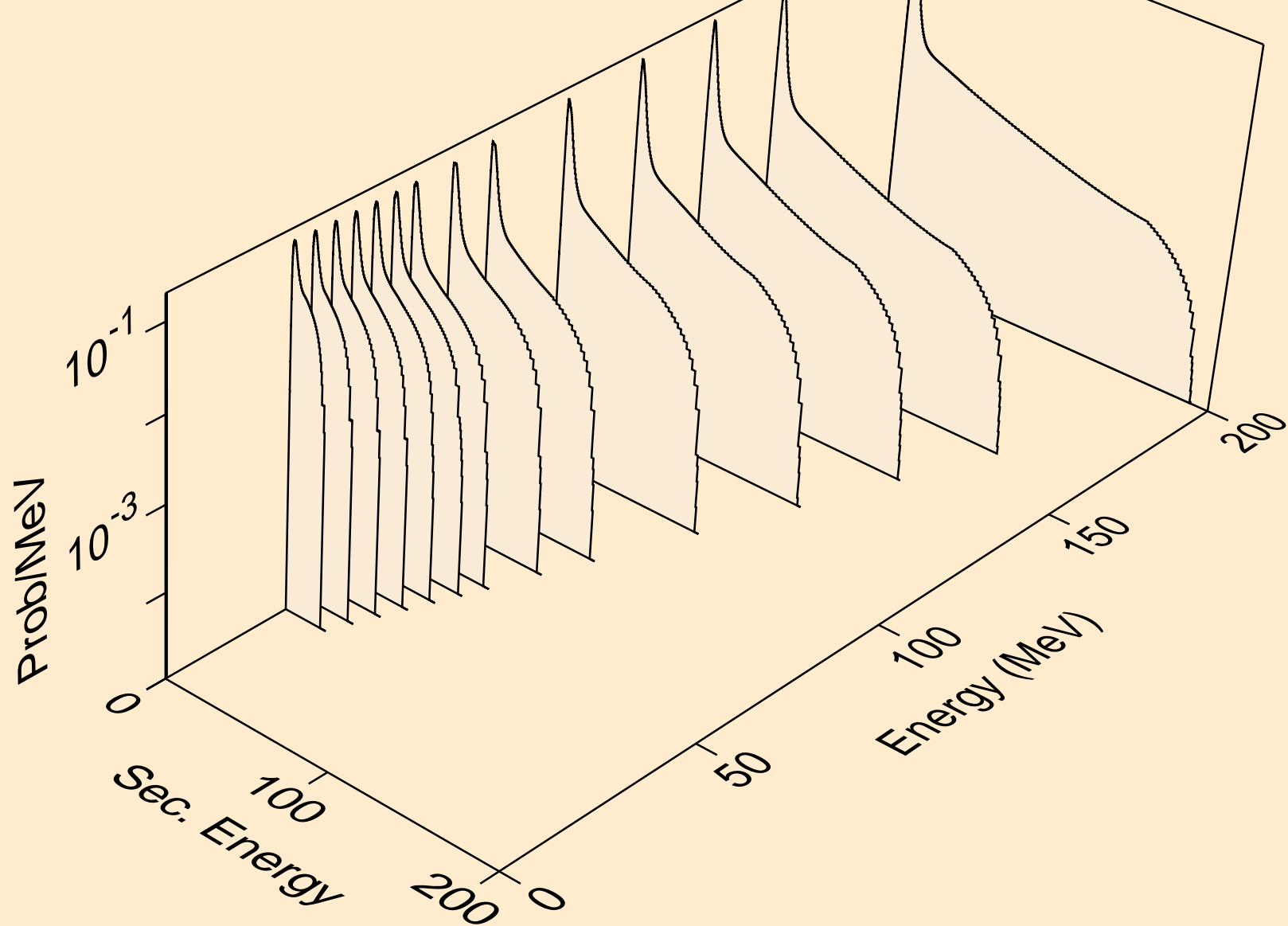

RN201M PROTON ACER TENDL-2023 LIBRARY; T=0.K  
neutrons from (p,2n)

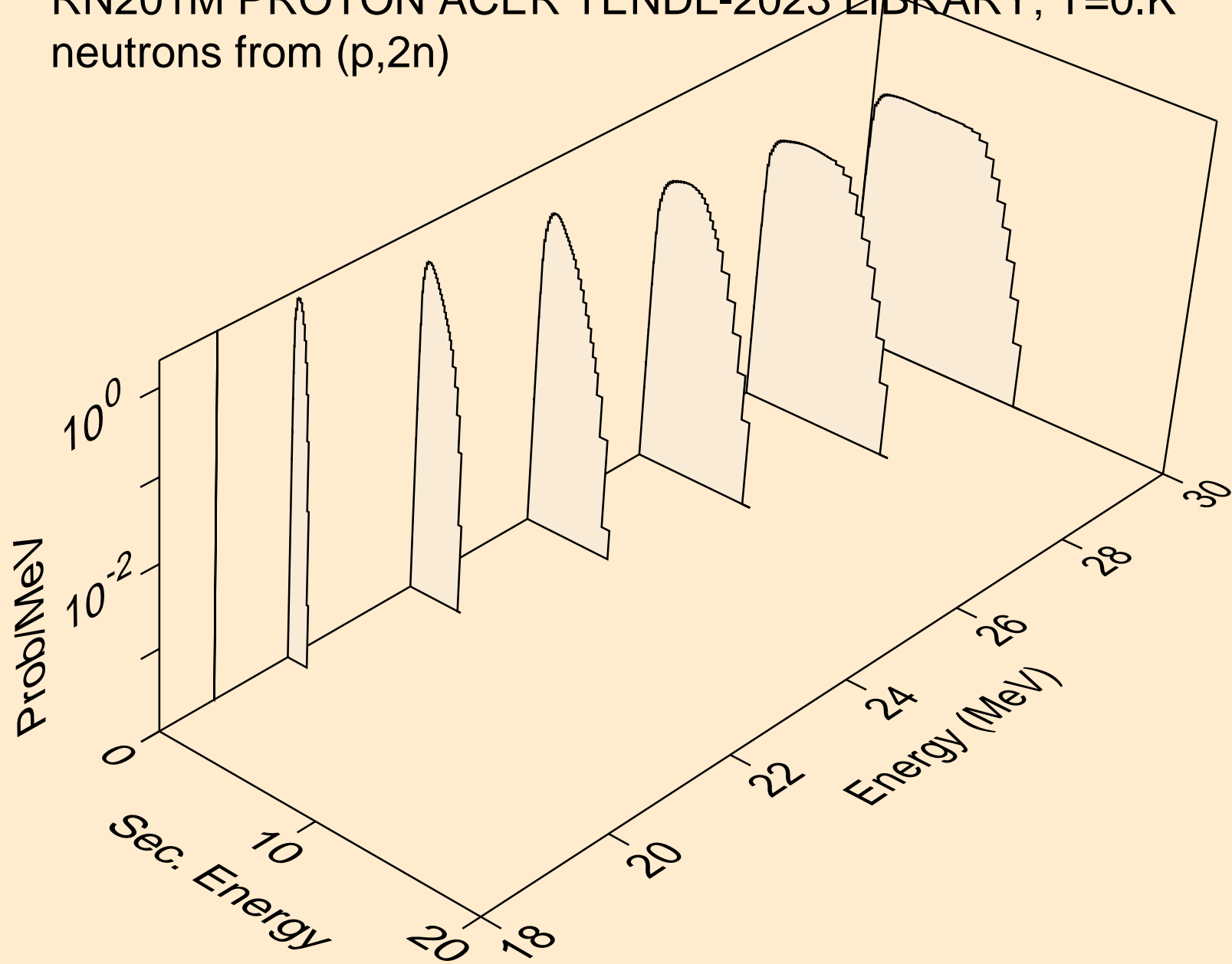

RN201M PROTON ACER TENDL-2023 LIBRARY; T=0.K  
neutrons from (p,3n)

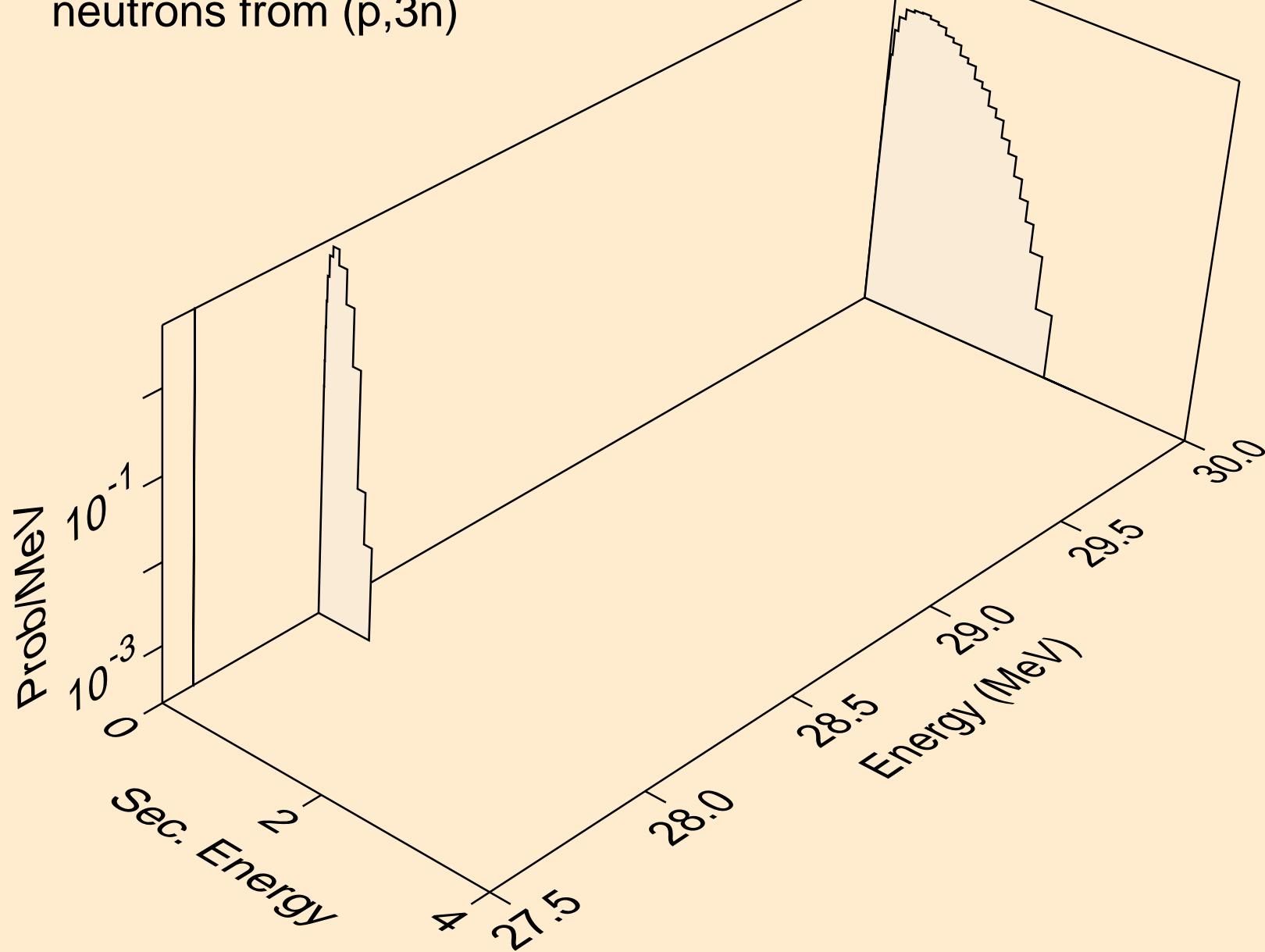

RN201M PROTON ACER TENDL-2023 LIBRARY; T=0.K  
neutrons from (p,n\*)a

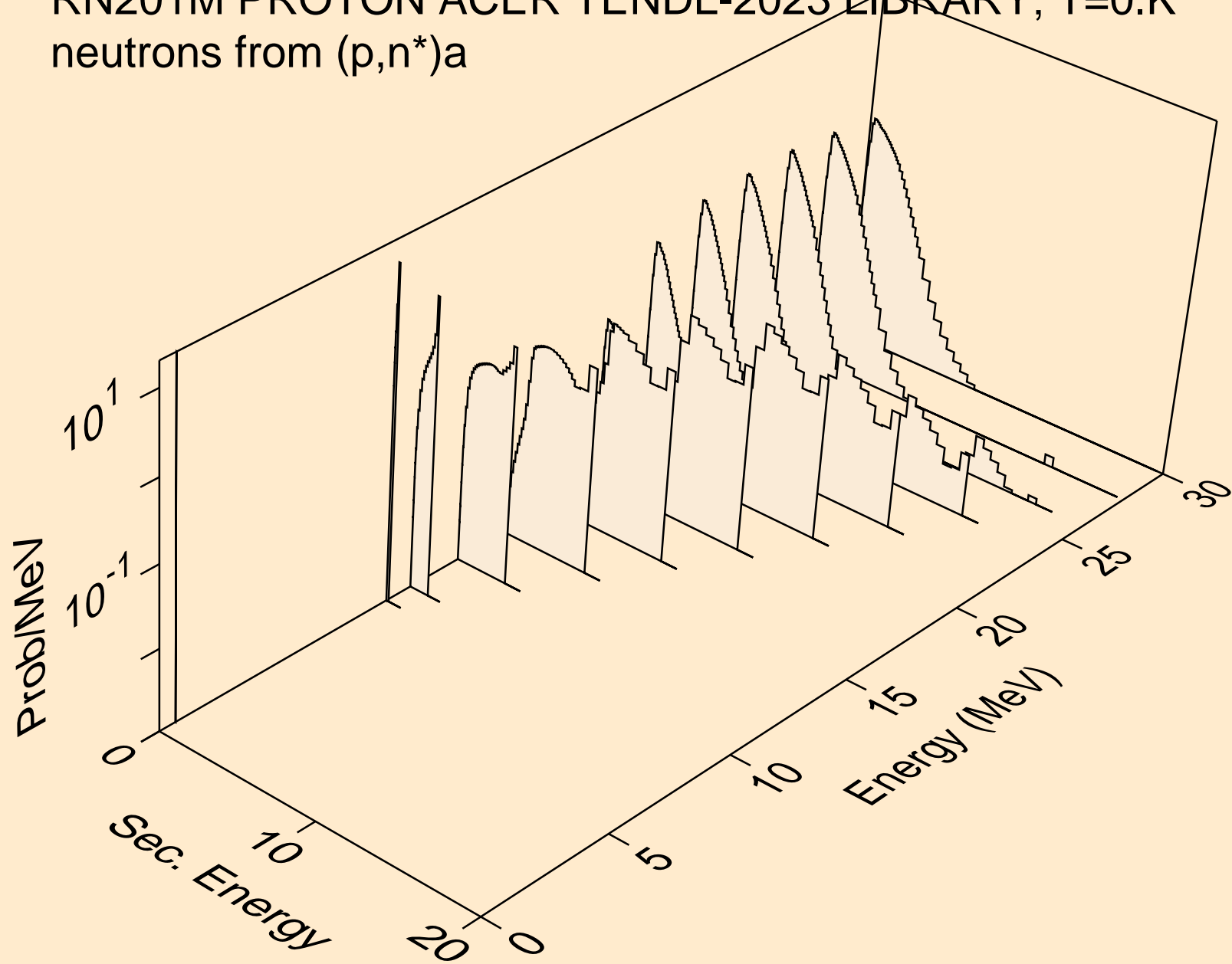

RN201M PROTON ACER TENDL-2023 LIBRARY; T=0.K  
neutrons from (p,2n)a

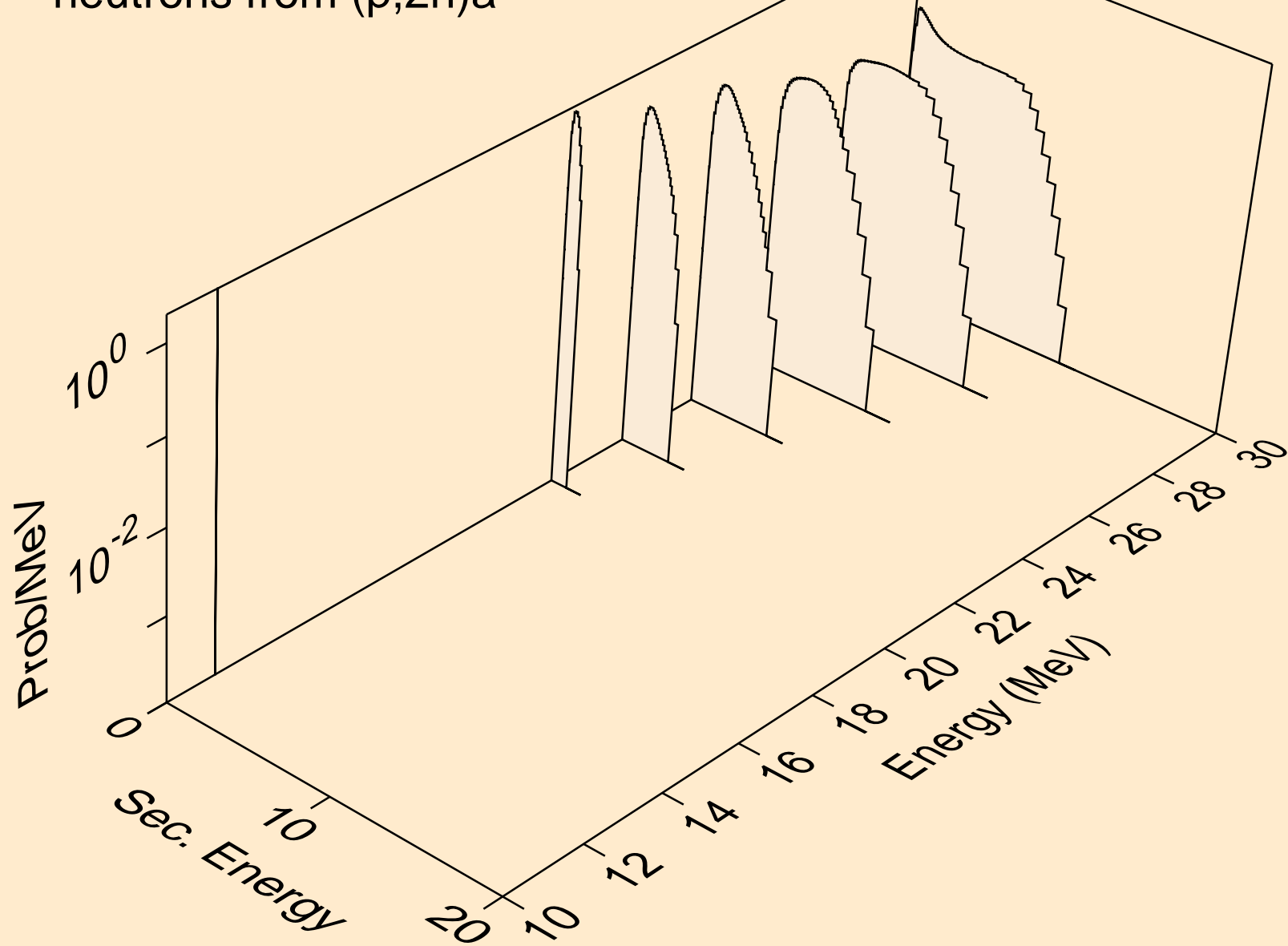

RN201M PROTON ACER TENDL-2023 LIBRARY; T=0.K  
neutrons from (p,n\*)p

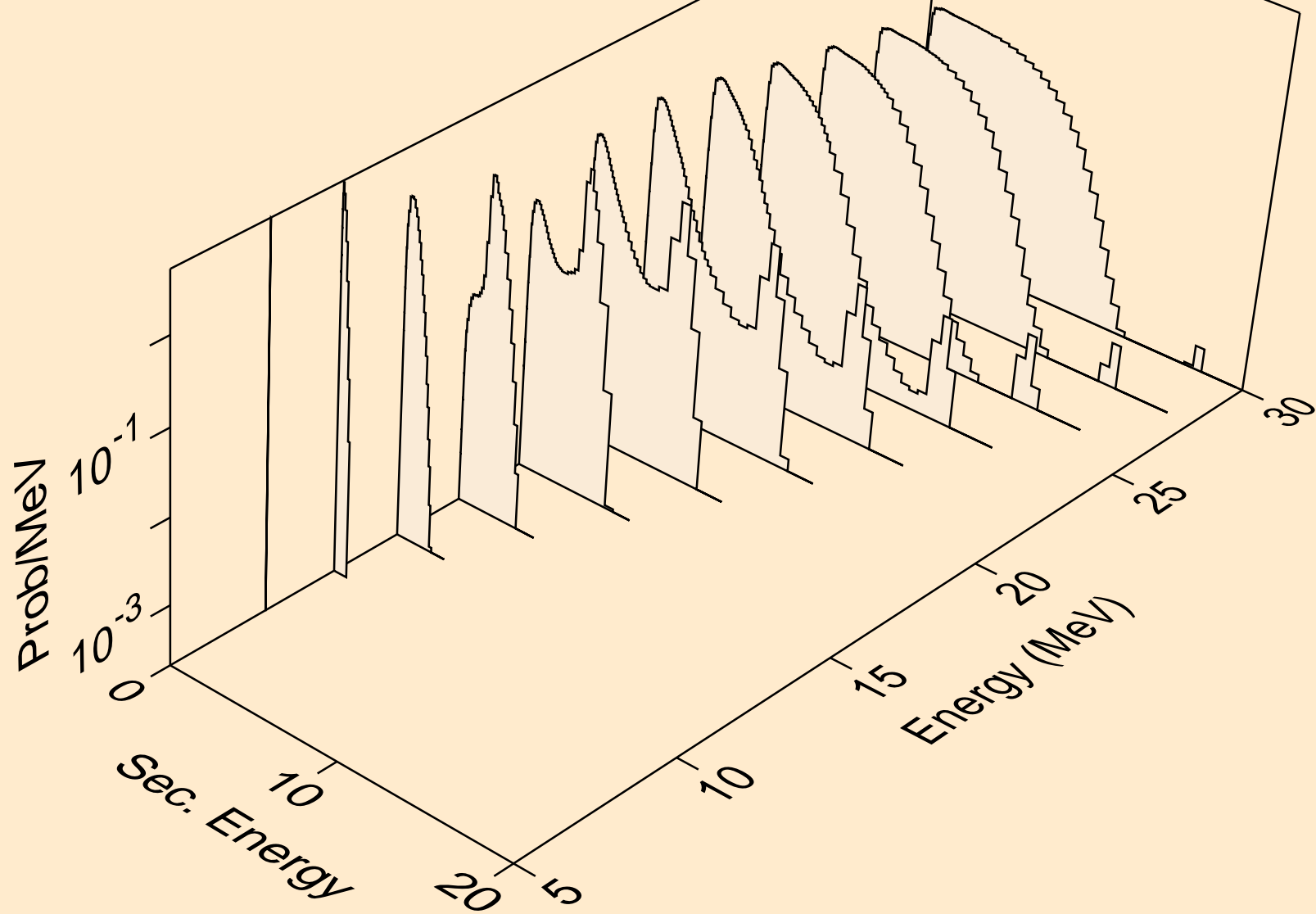

RN201M PROTON ACER TENDL-2023 LIBRARY; T=0.K  
neutrons from (p,n\*)2a

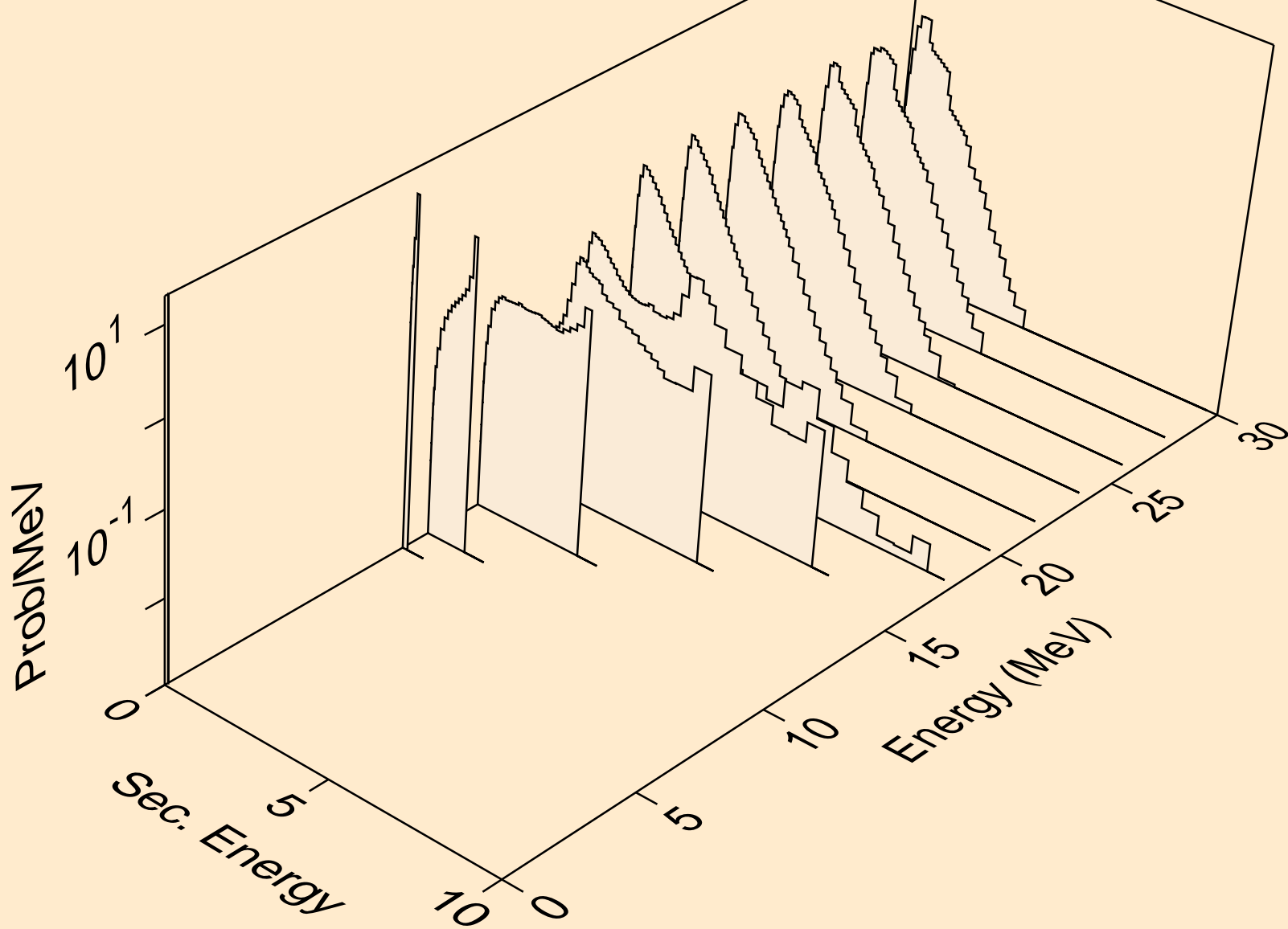



RN201M PROTON ACER TENDL-2023 LIBRARY; T=0.K  
neutrons from (p,n\*)d

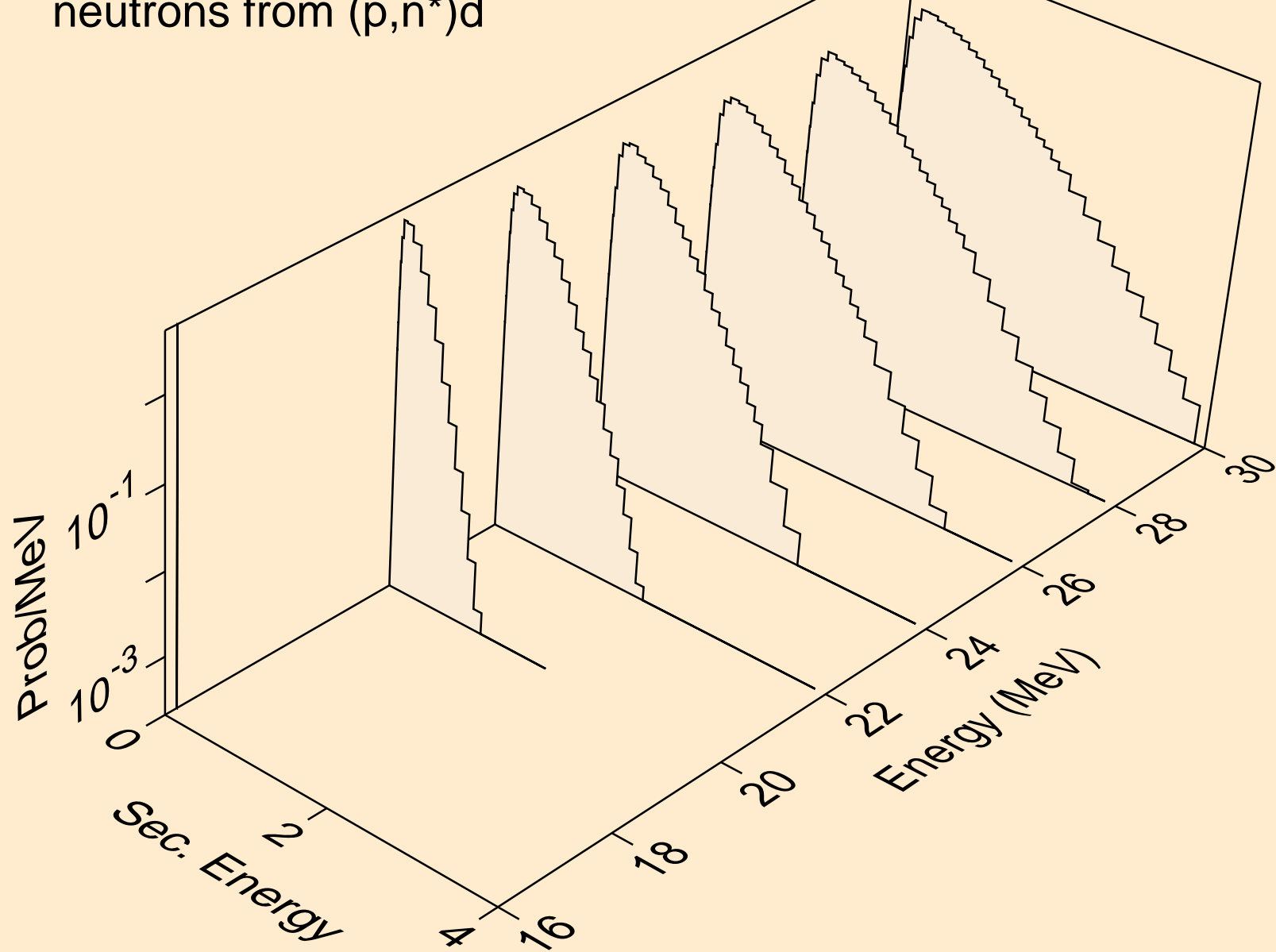

RN201M PROTON ACER TENDL-2023 LIBRARY; T=0.K  
neutrons from (p,n\*)t

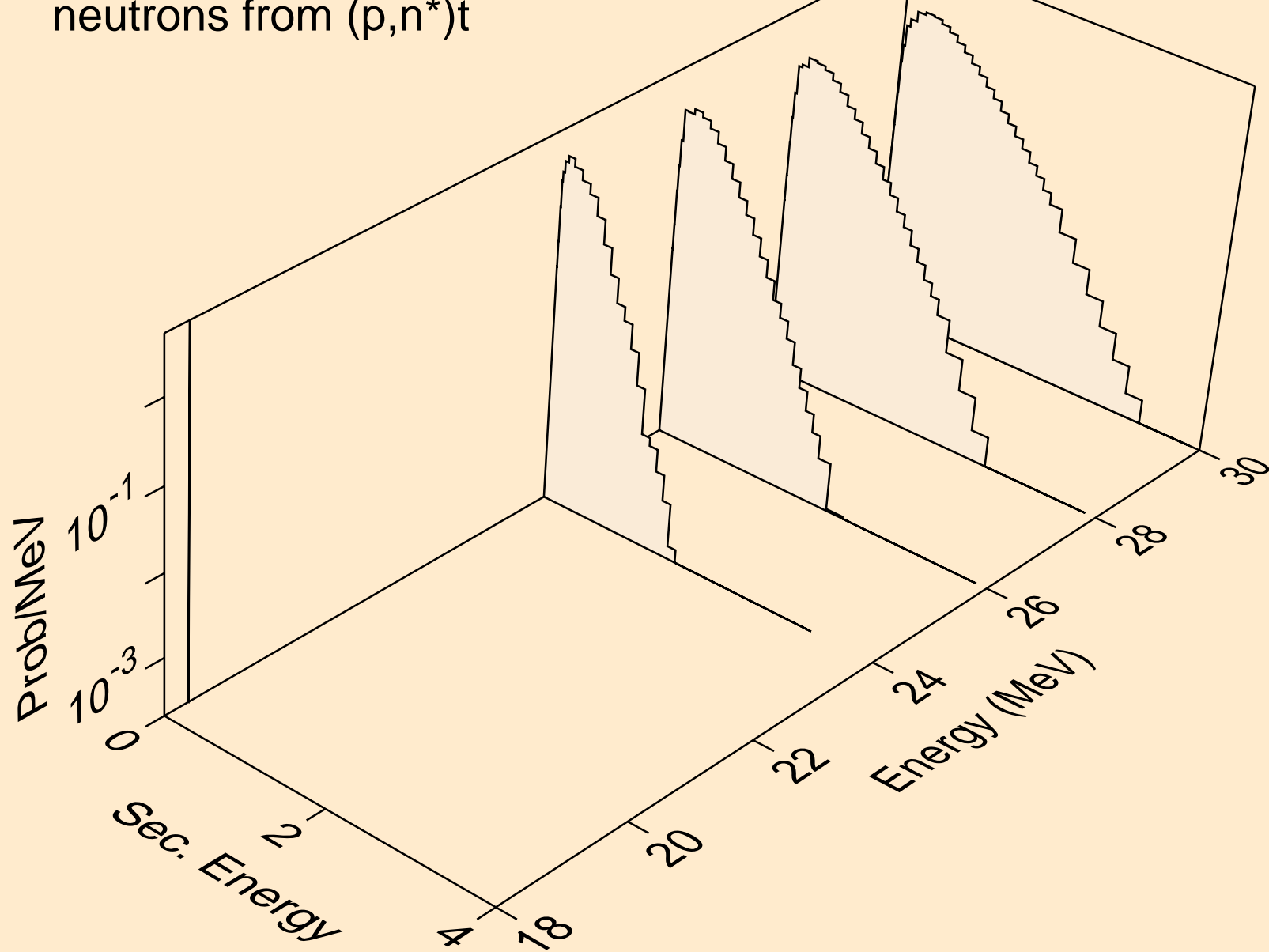

RN201M PROTON ACER TENDL-2023 LIBRARY; T=0.K  
neutrons from (p,n\*)he3

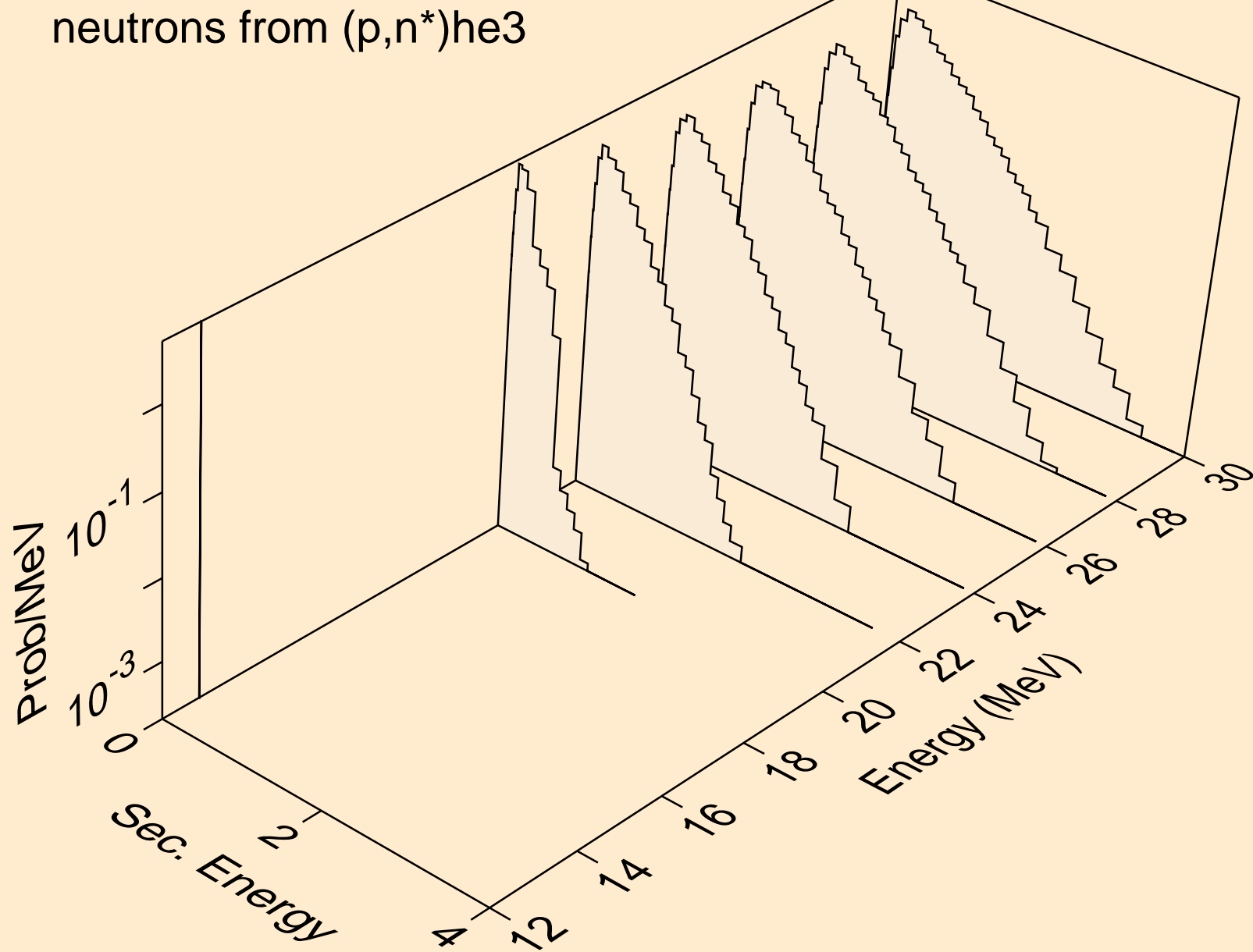

RN201M PROTON ACER TENDL-2023 LIBRARY; T=0.K  
neutrons from (p,2np)

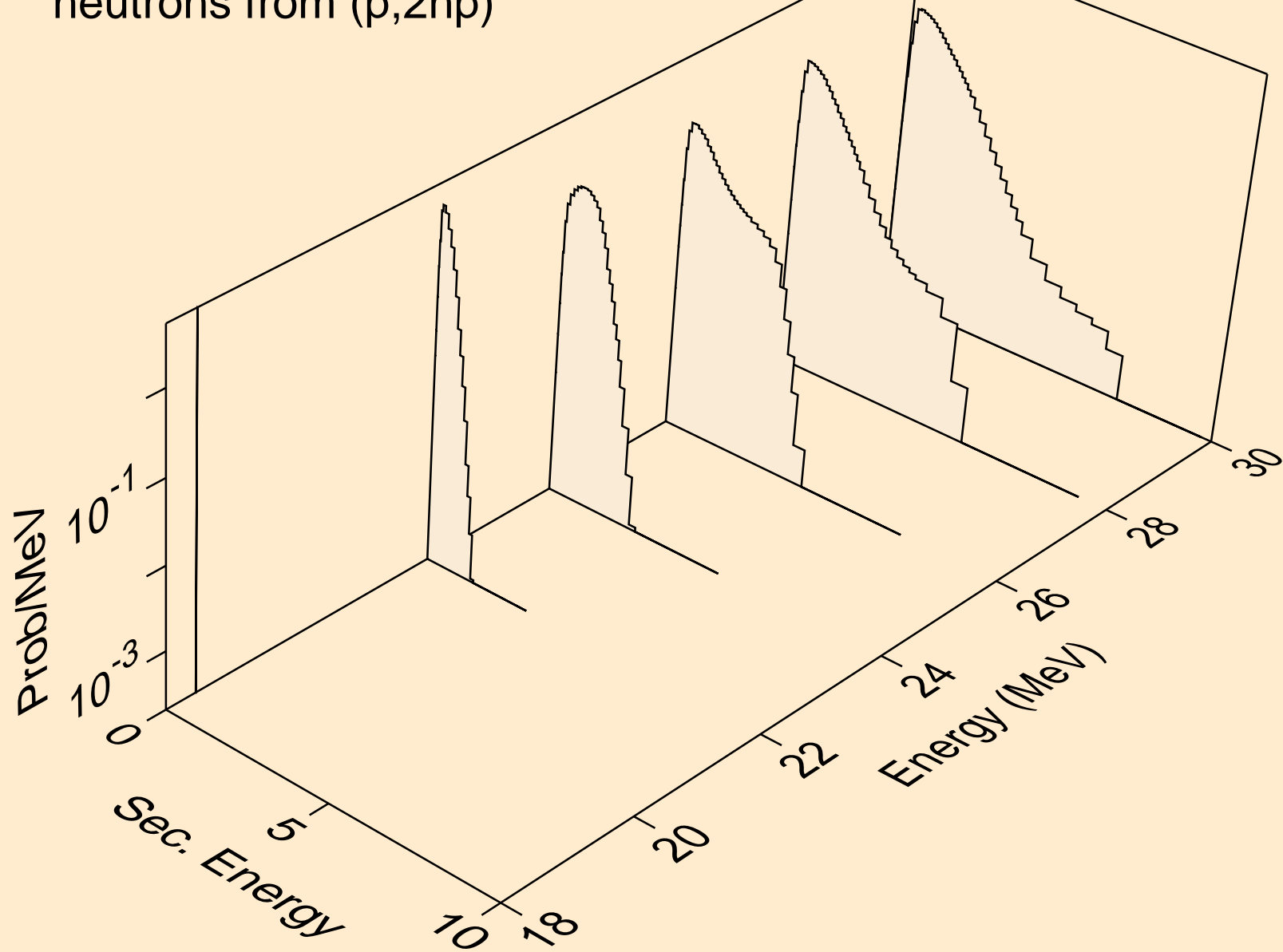

RN201M PROTON ACER TENDL-2023 LIBRARY; T=0.K  
neutrons from (p,n2p)

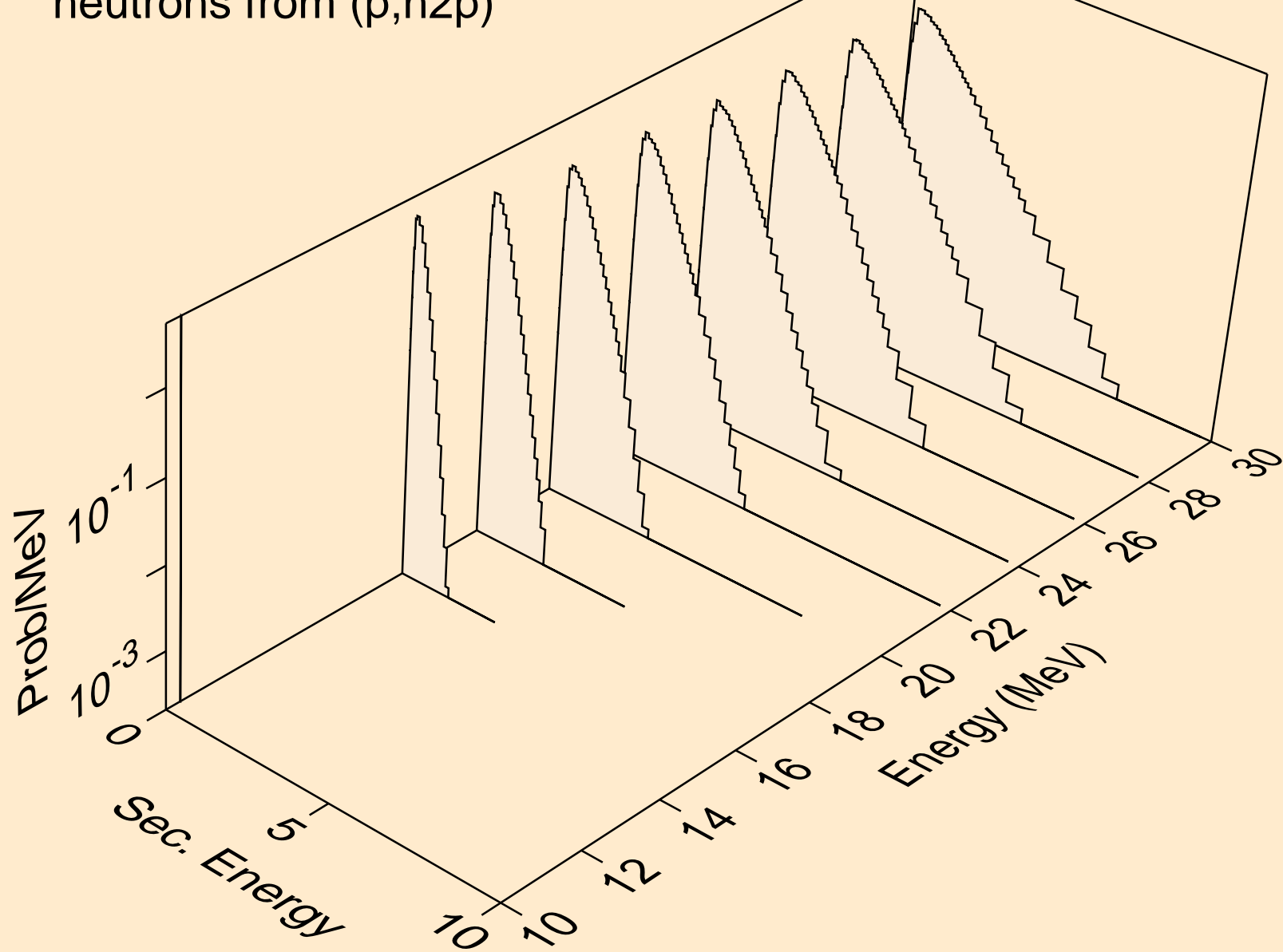

RN201M PROTON ACER TENDL-2023 LIBRARY; T=0.K  
neutrons from (p,npa)

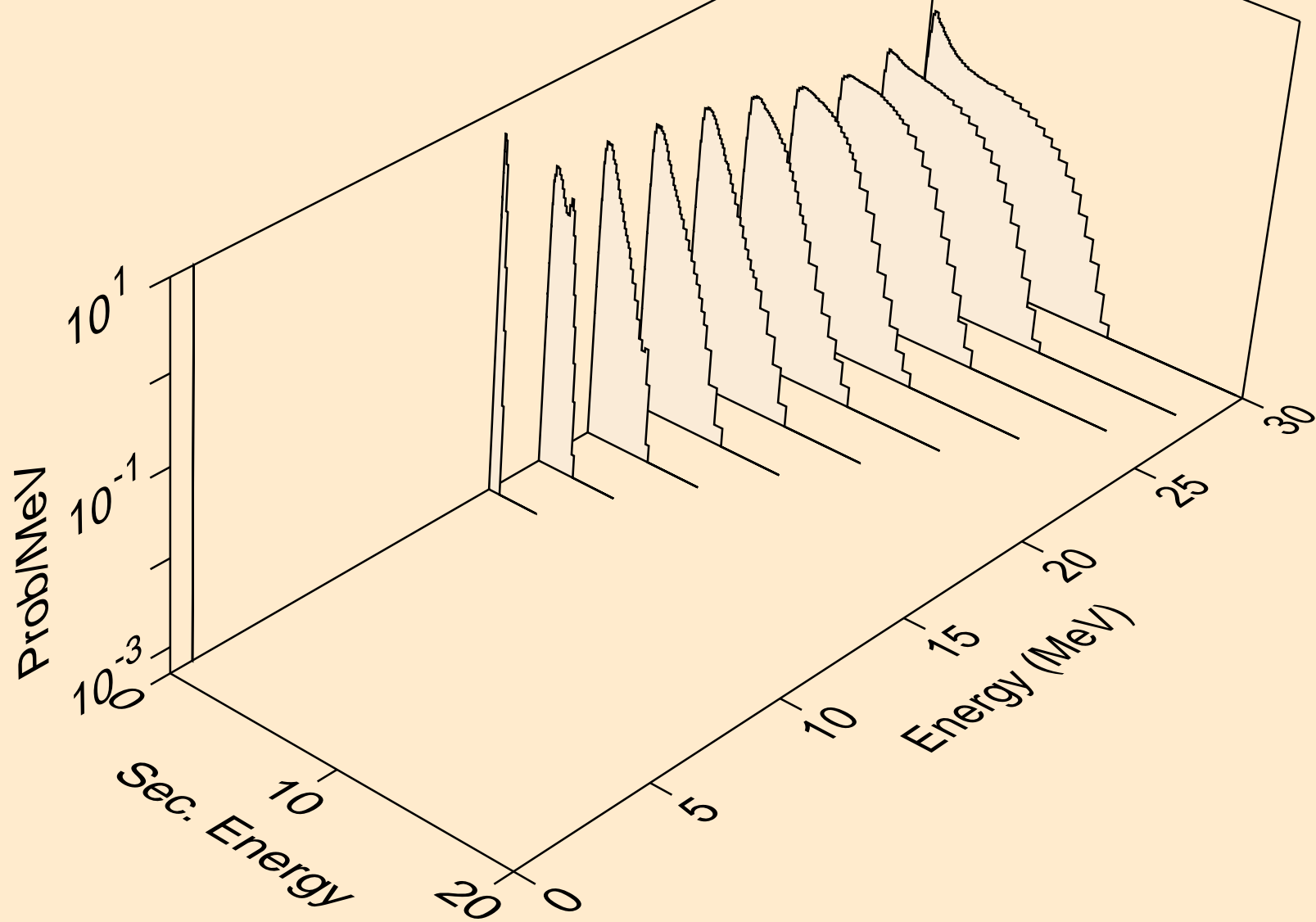

RN201M PROTON ACER TENDL-2023 LIBRARY; T=0.K  
deuterons from (p,x)

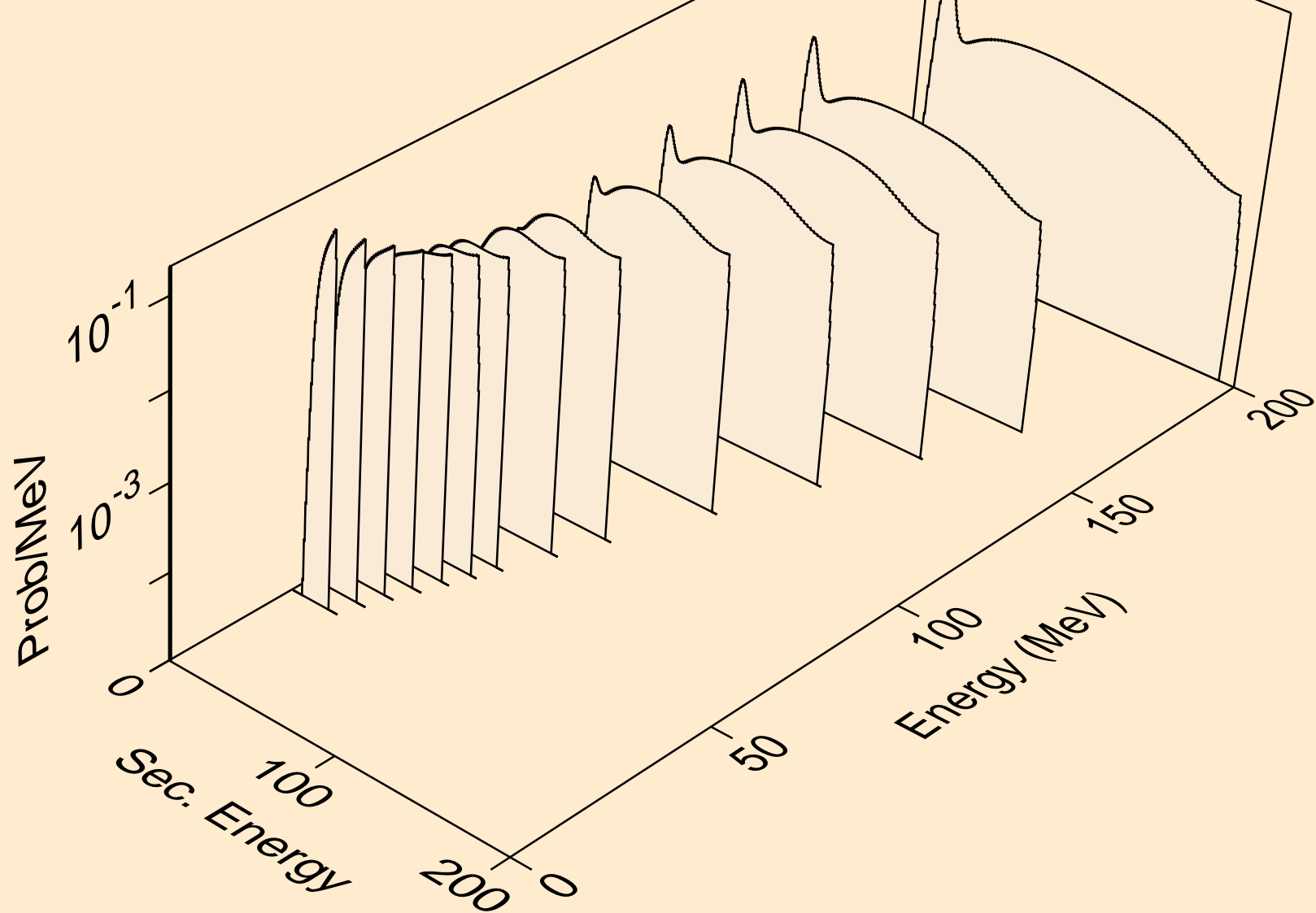

RN201M PROTON ACER TENDL-2023 LIBRARY; T=0.K  
deuterons from (p,n\*)d

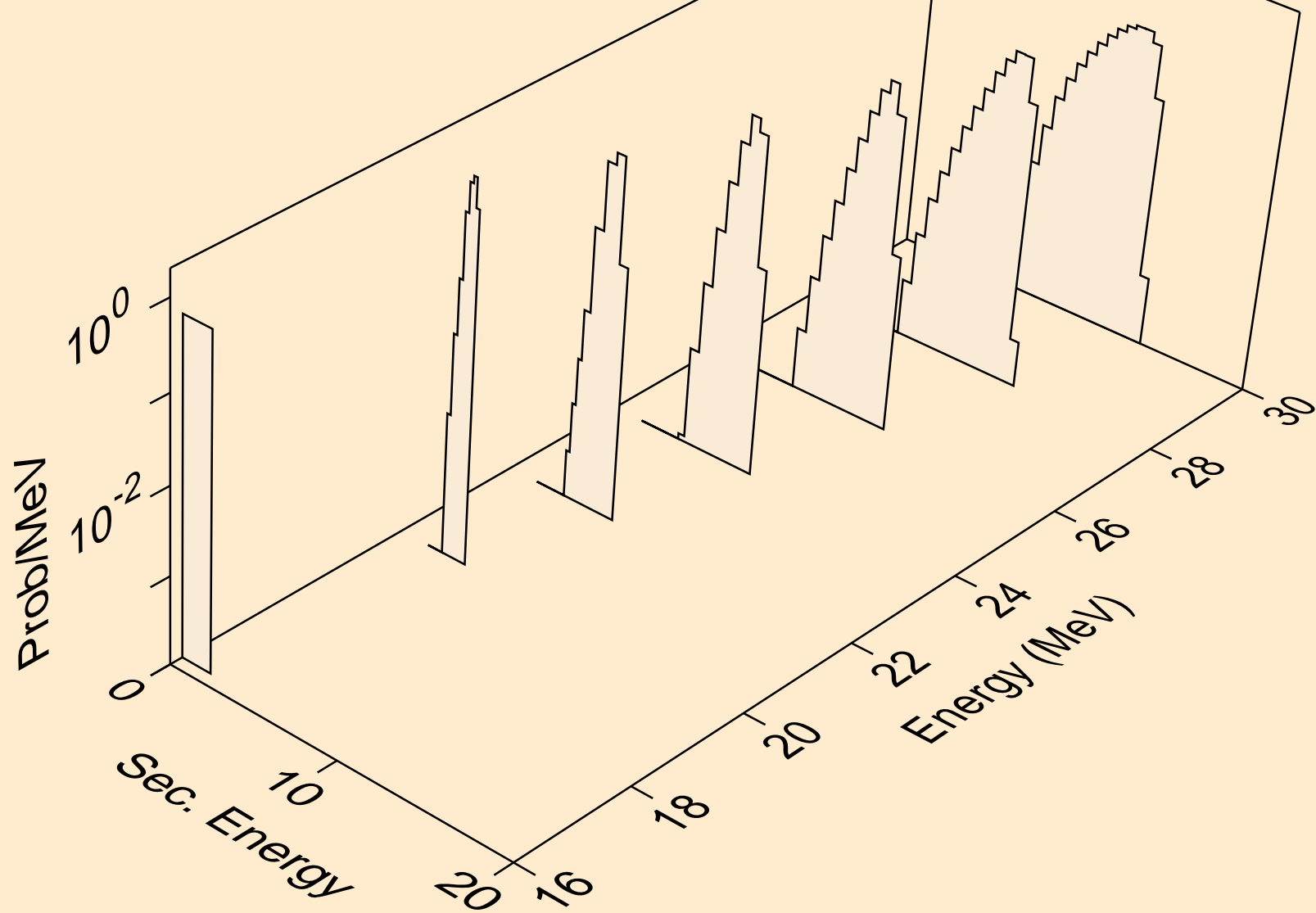



RN201M PROTON ACER TENDL-2023 LIBRARY; T=0.K  
deuterons from (p,d)

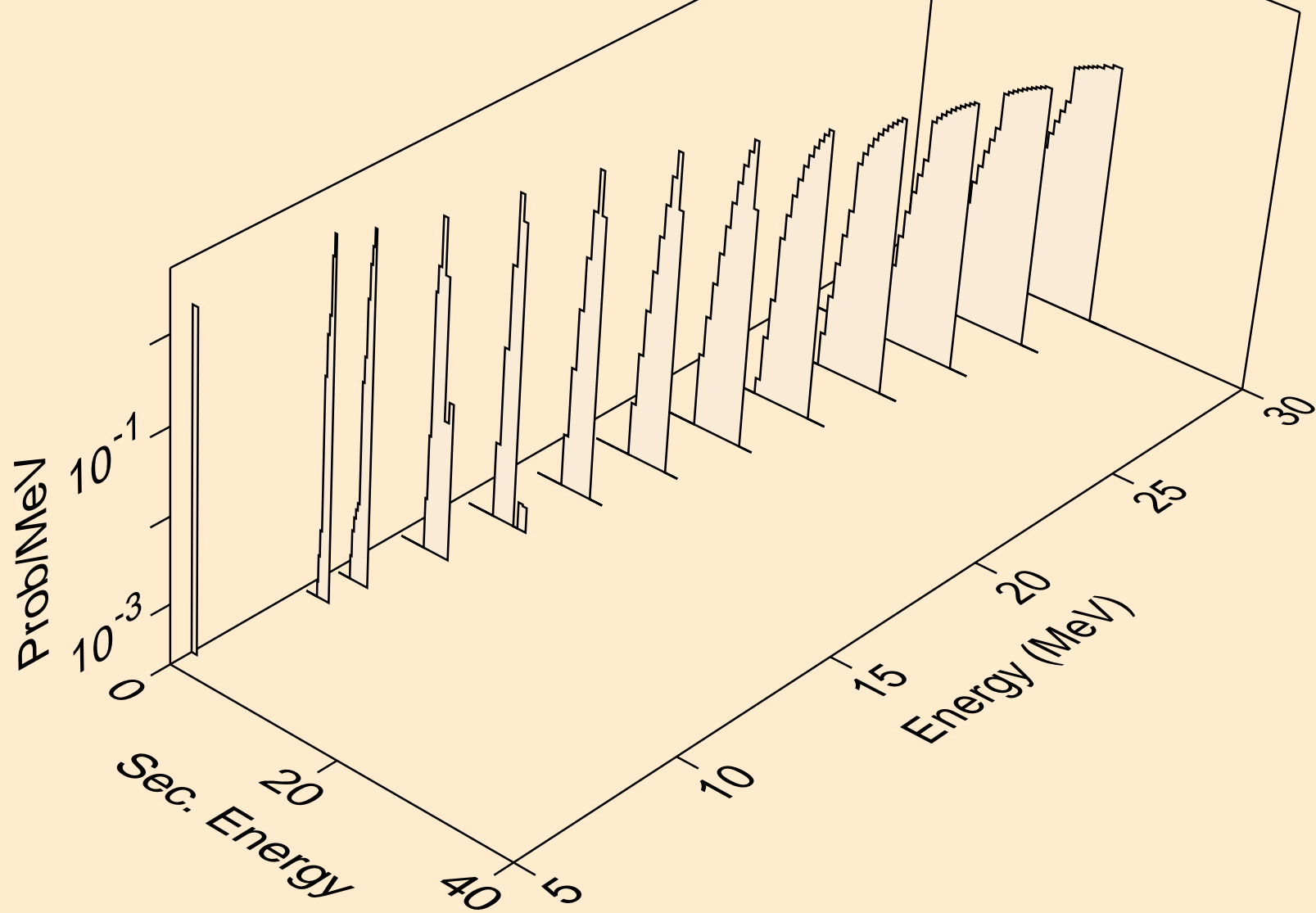

RN201M PROTON ACER TENDL-2023 LIBRARY; T=0.K  
deuterons from (p,pd)

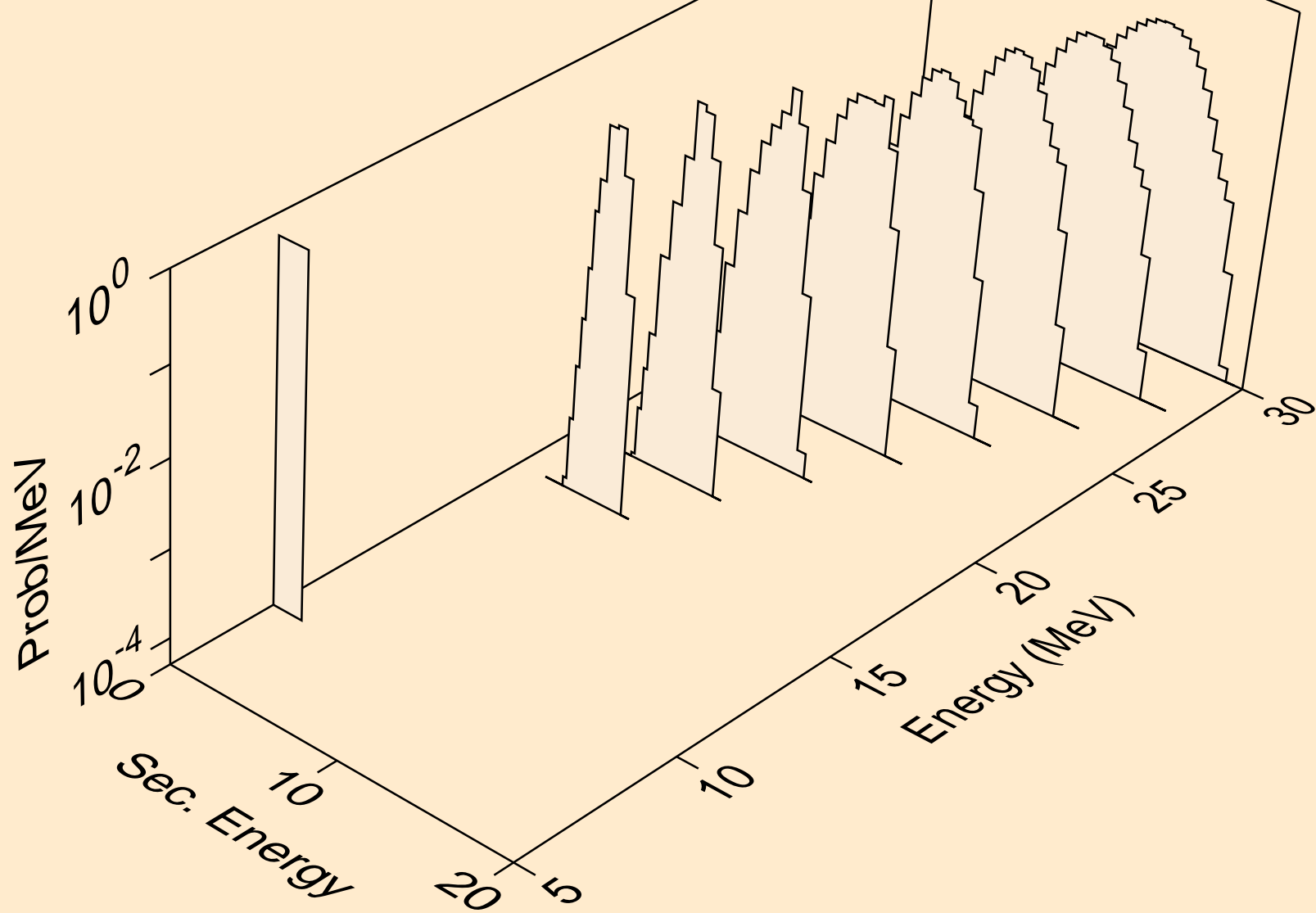

RN201M PROTON ACER TENDL-2023 LIBRARY; T=0.K  
deuterons from (p,da)

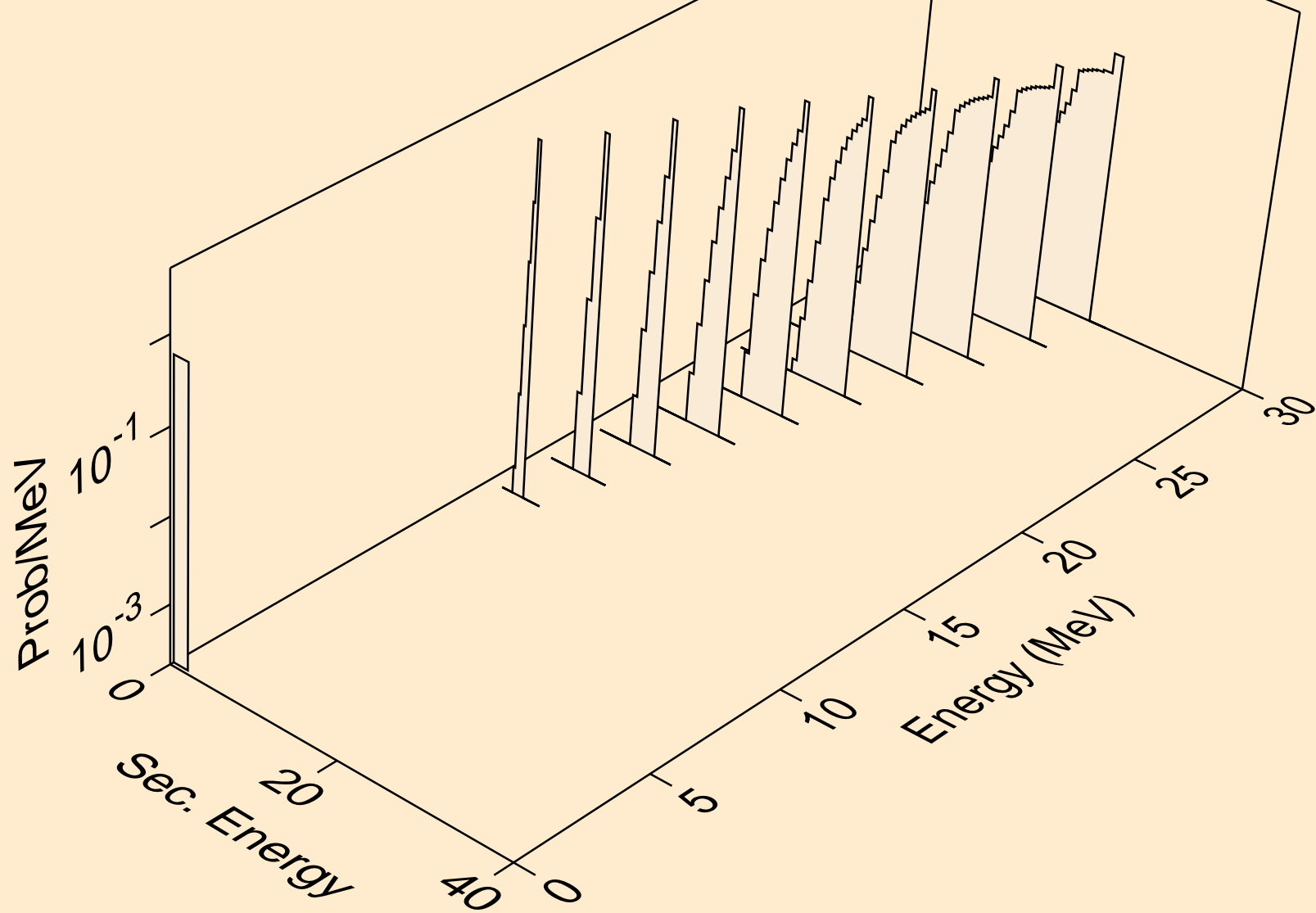

RN201M PROTON ACER TENDL-2023 LIBRARY; T=0.K  
tritons from (p,x)

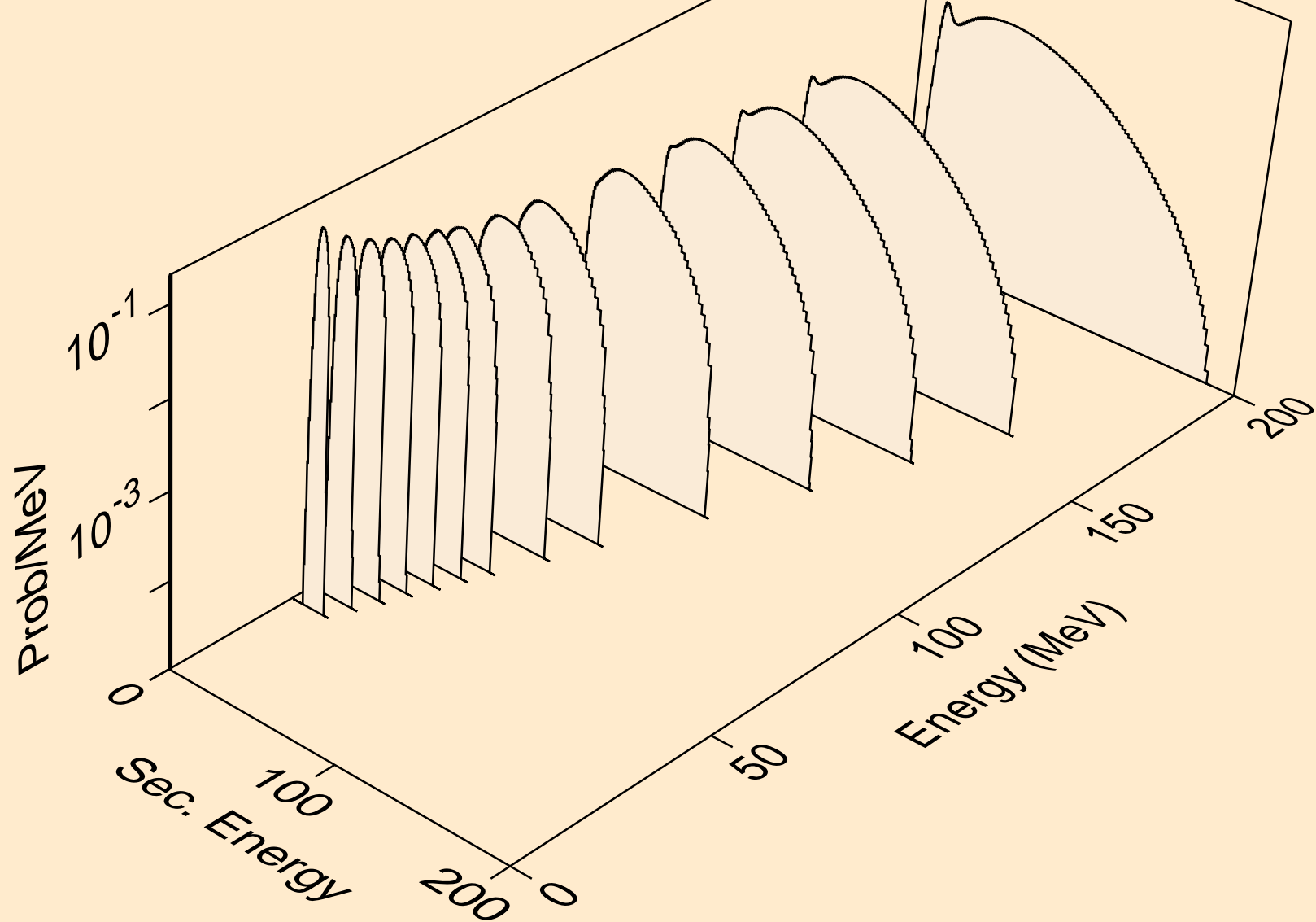

RN201M PROTON ACER TENDL-2023 LIBRARY; T=0.K  
tritons from (p,n\*)t

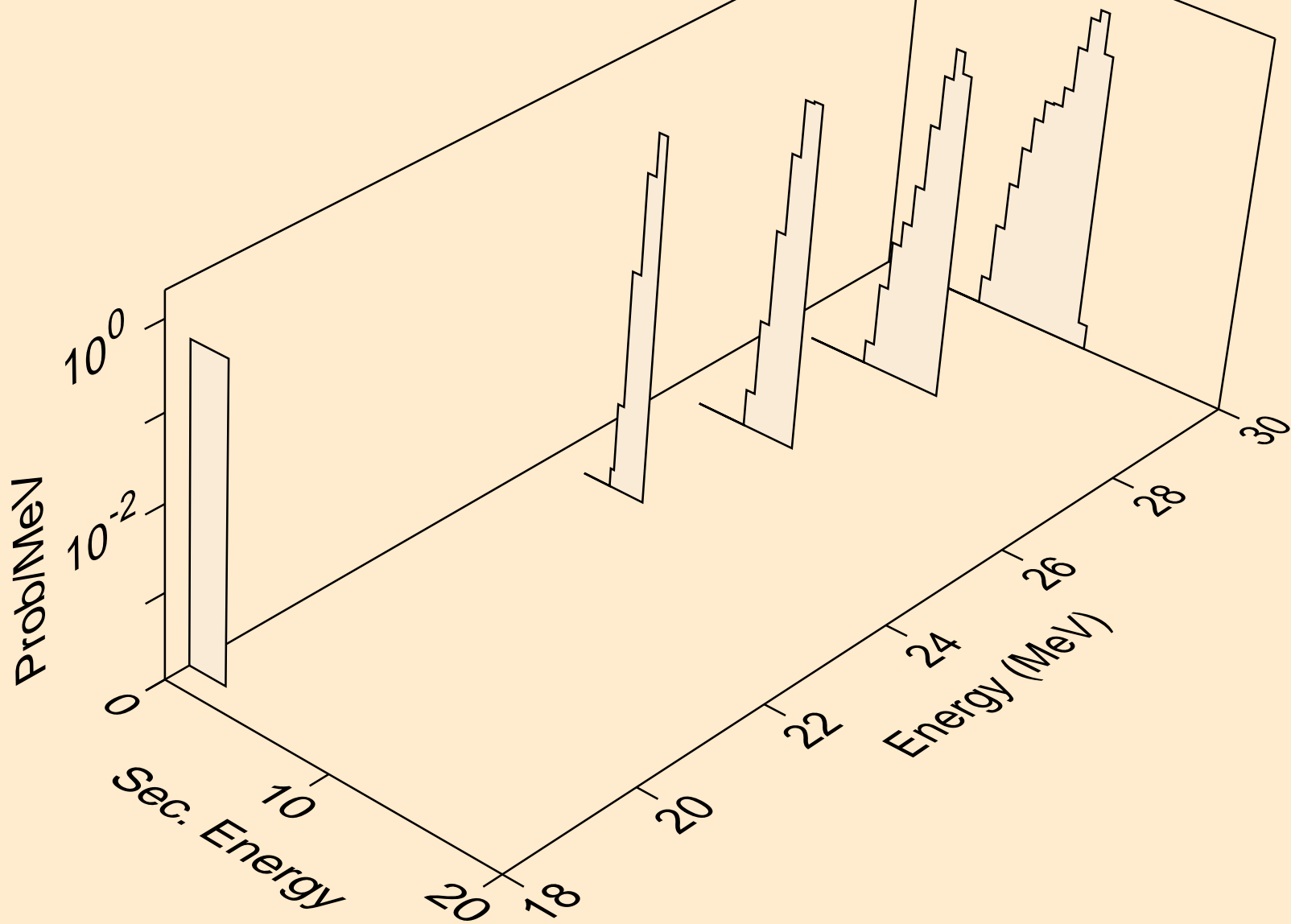

RN201M PROTON ACER TENDL-2023 LIBRARY; T=0.K  
tritons from (p,t)

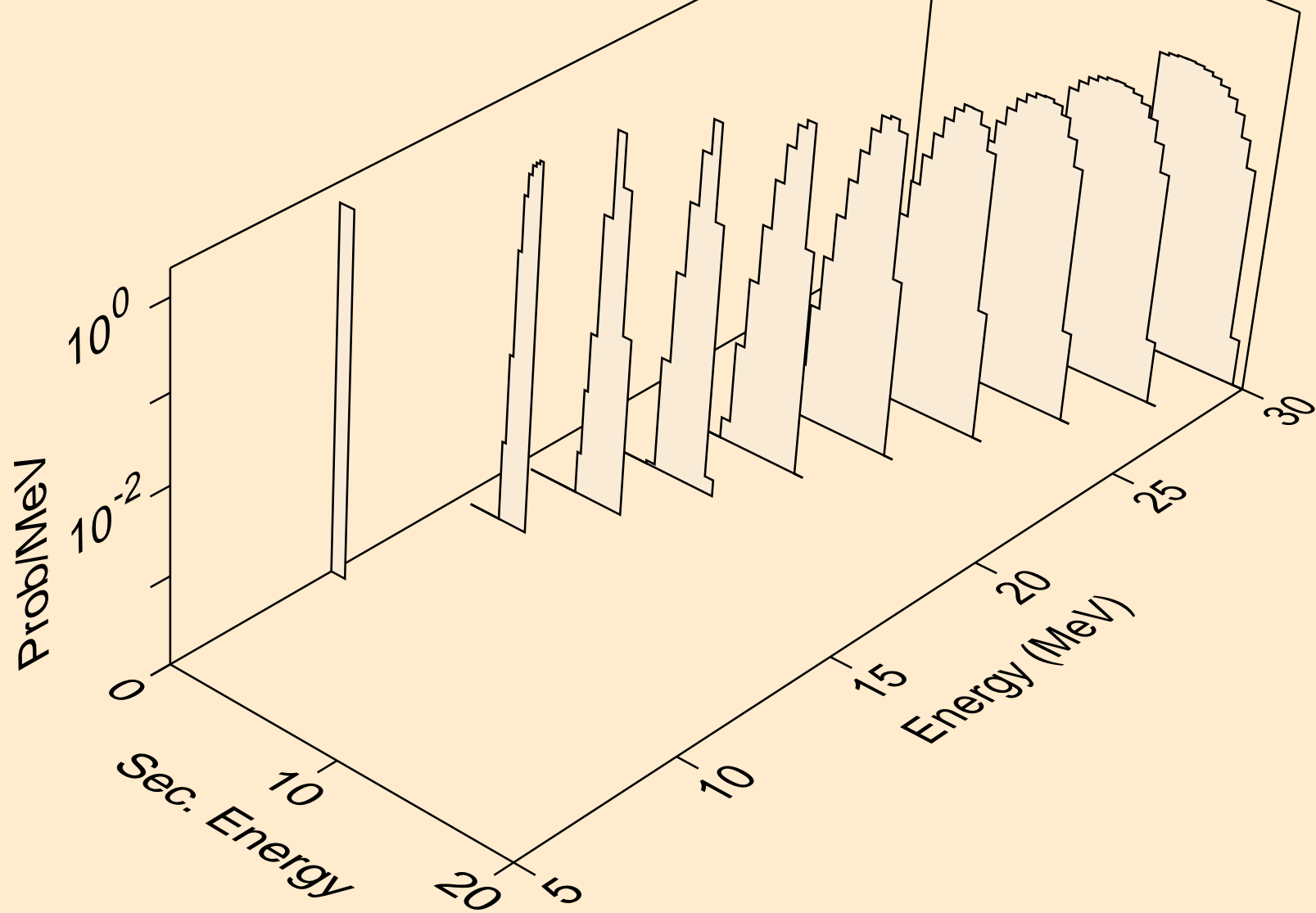

RN201M PROTON ACER TENDL-2023 LIBRARY; T=0.K  
tritons from (p,pt)

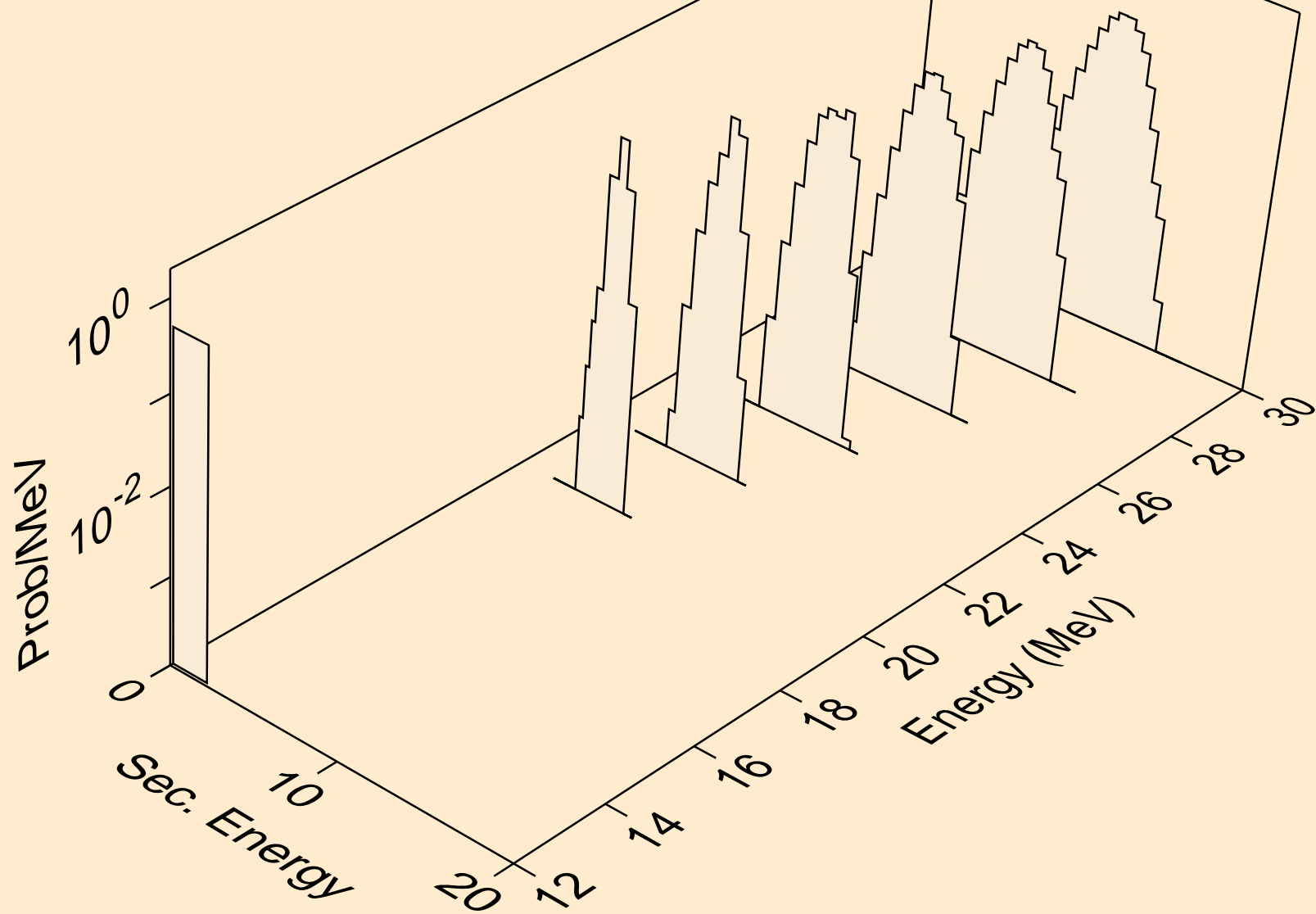

RN201M PROTON ACER TENDL-2023 LIBRARY; T=0.K  
he3s from (p,x)

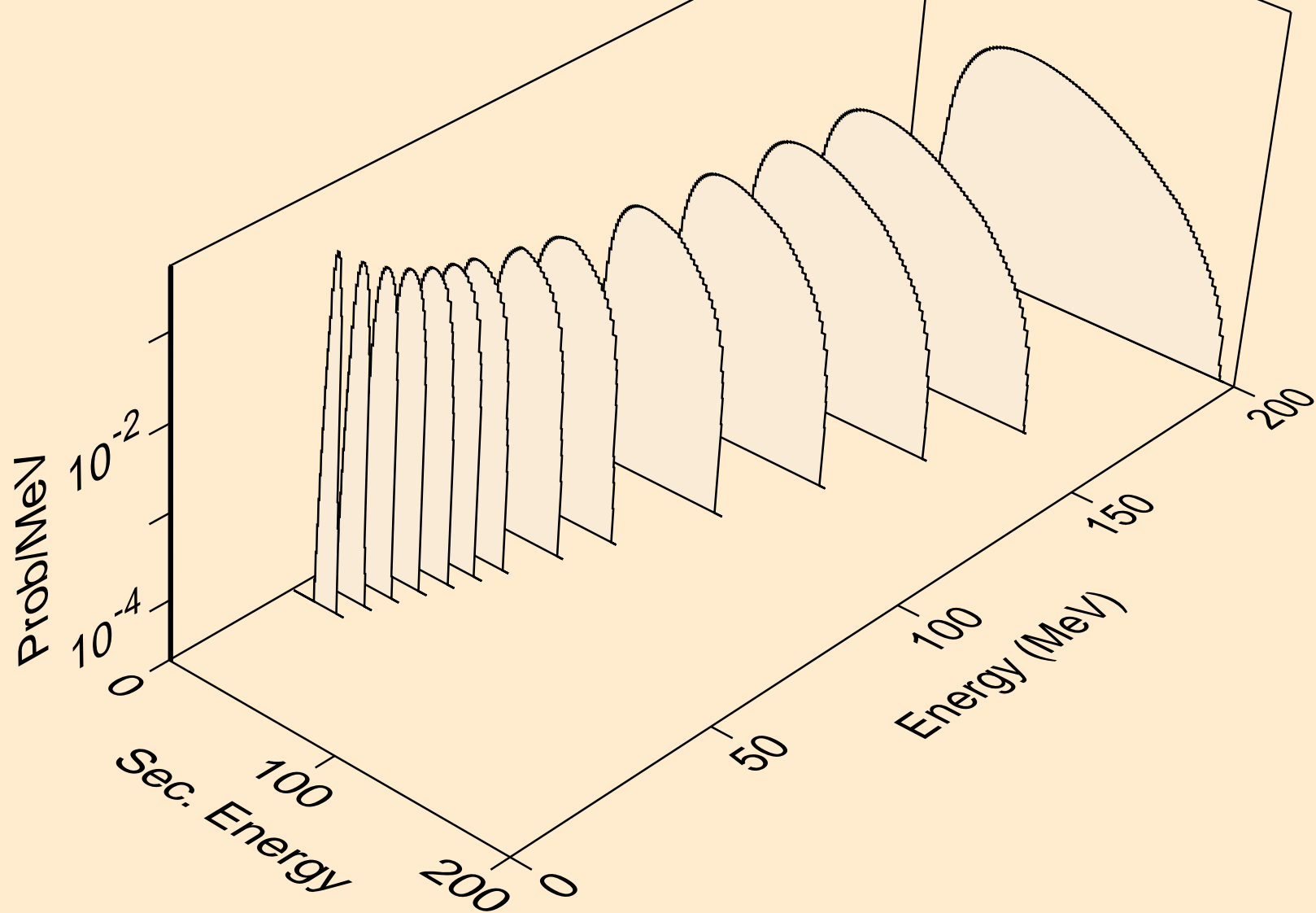



RN201M PROTON ACER TENDL-2023 LIBRARY; T=0.K  
he3s from (p,n\*)he3

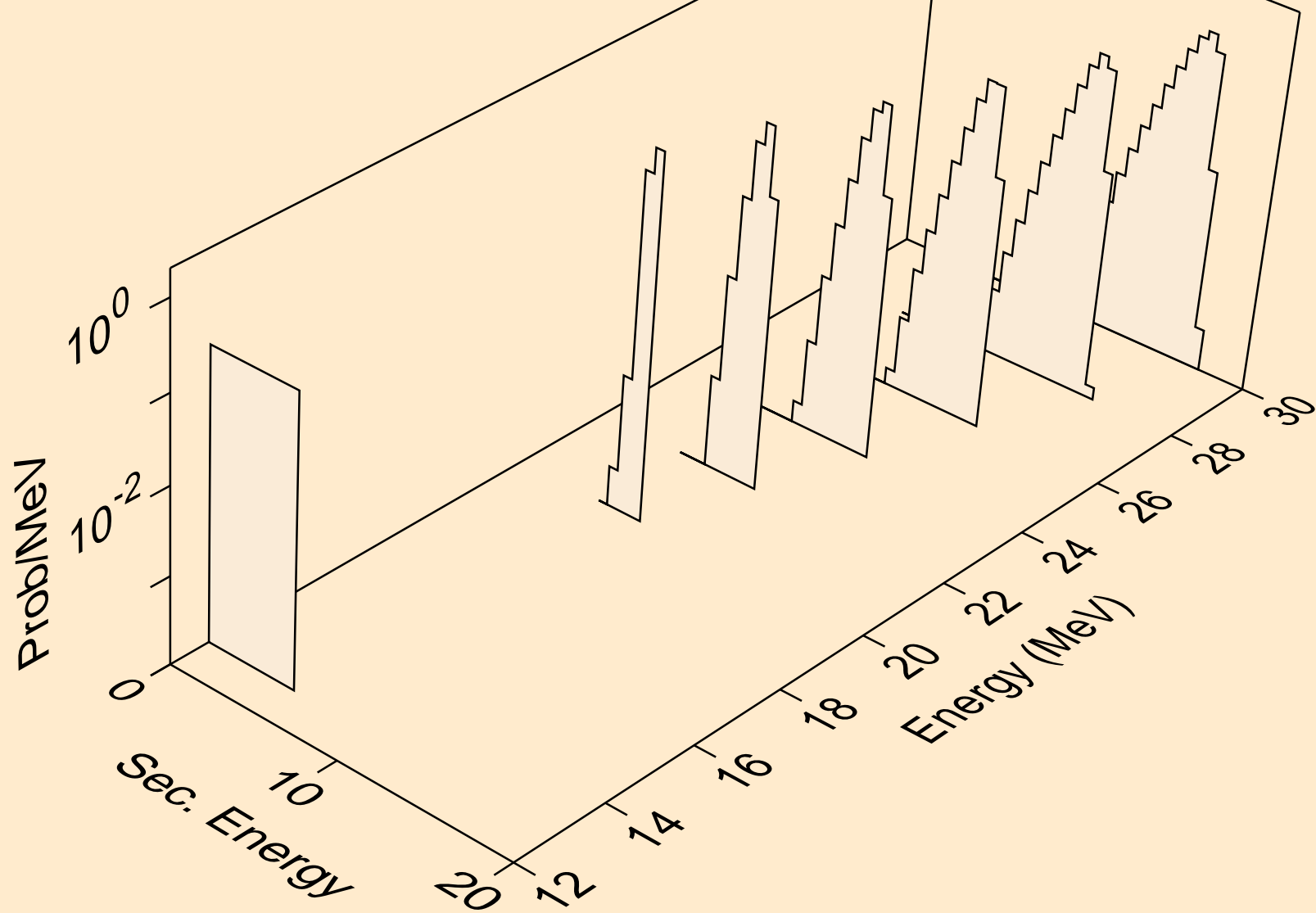

RN201M PROTON ACER TENDL-2023 LIBRARY; T=0.K  
he3s from (p,he3)

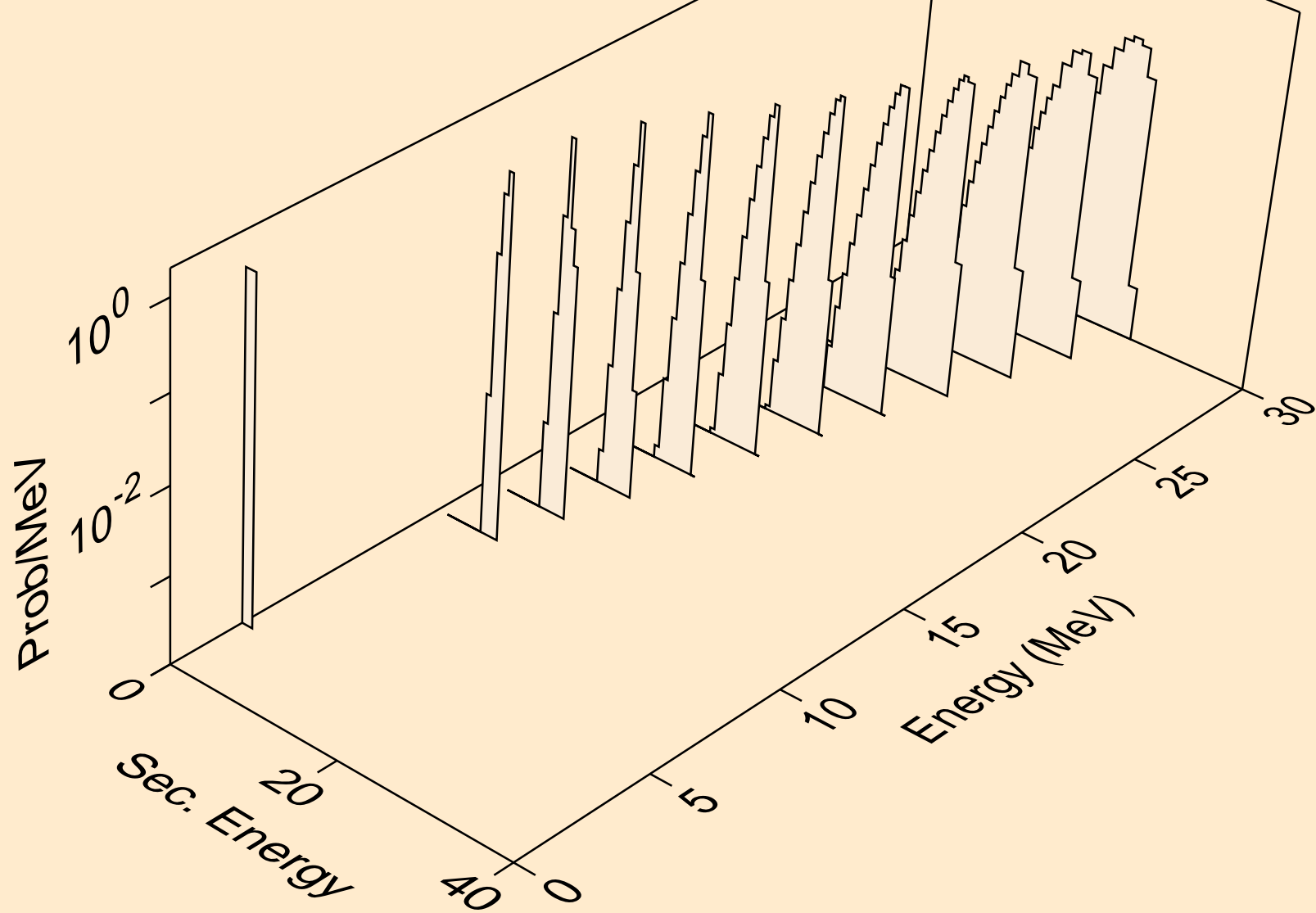

RN201M PROTON ACER TENDL-2023 LIBRARY; T=0.K  
alphas from (p,x)

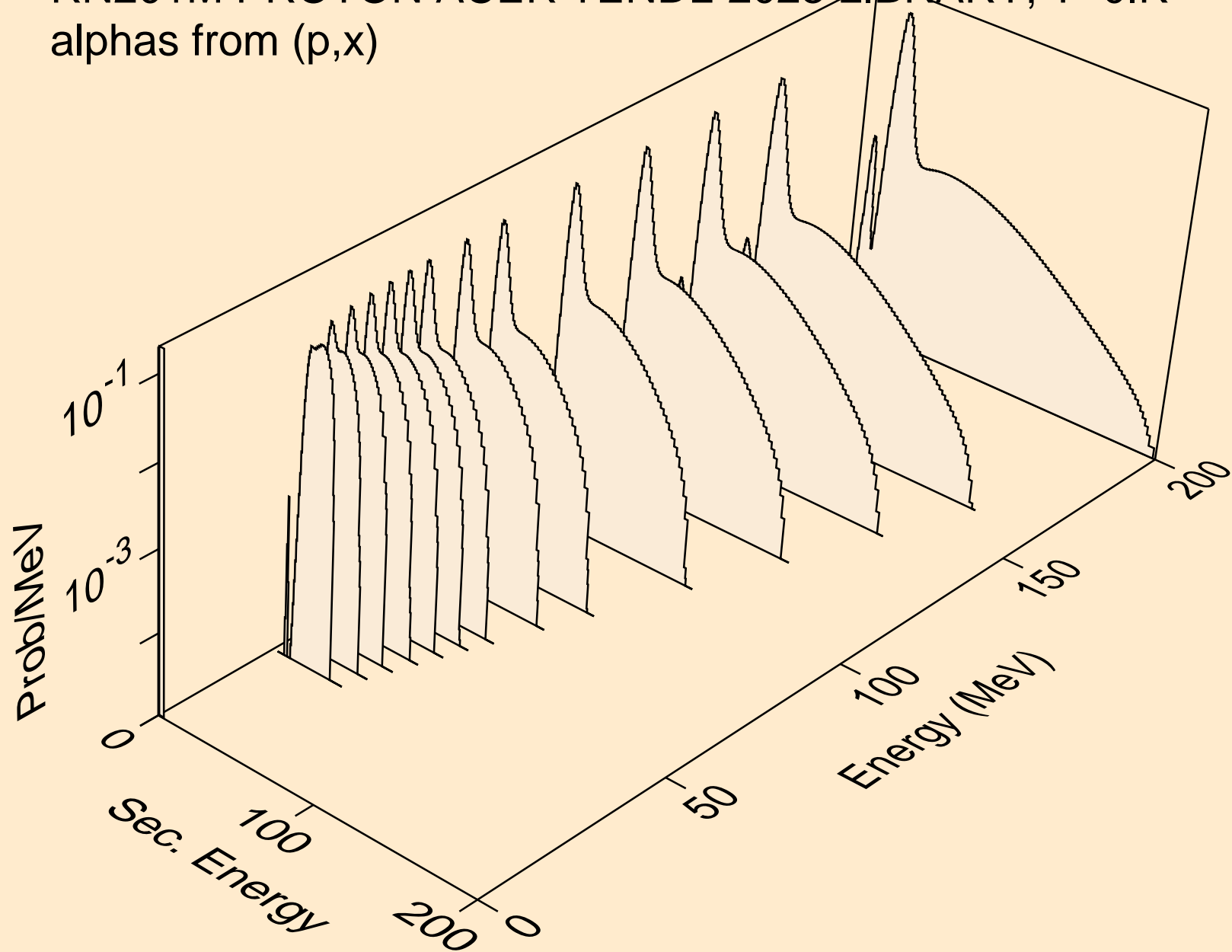

RN201M PROTON ACER TENDL-2023 LIBRARY; T=0.K  
alphas from (p,n\*)a

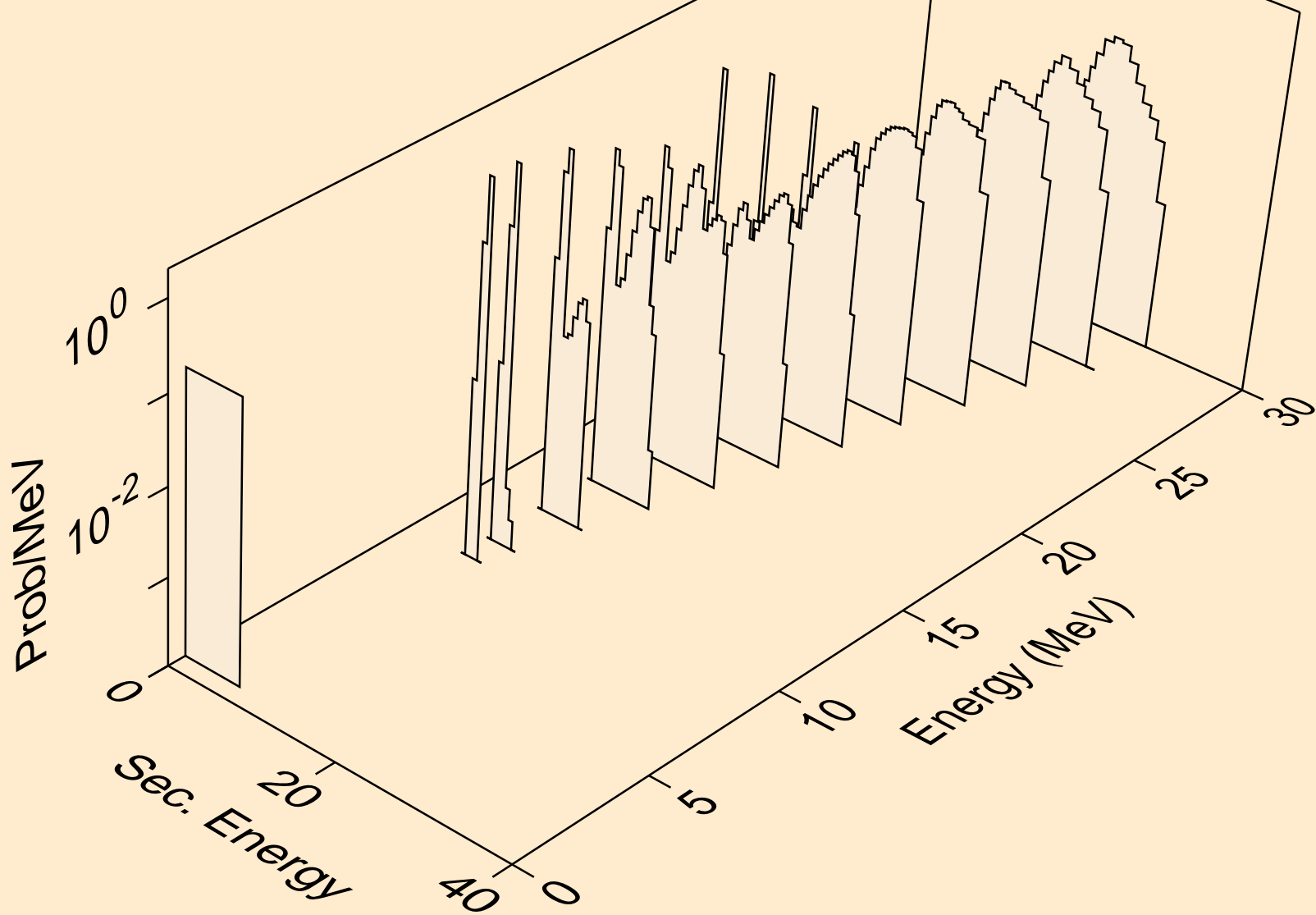

RN201M PROTON ACER TENDL-2023 LIBRARY; T=0.K  
alphas from (p,2n)a

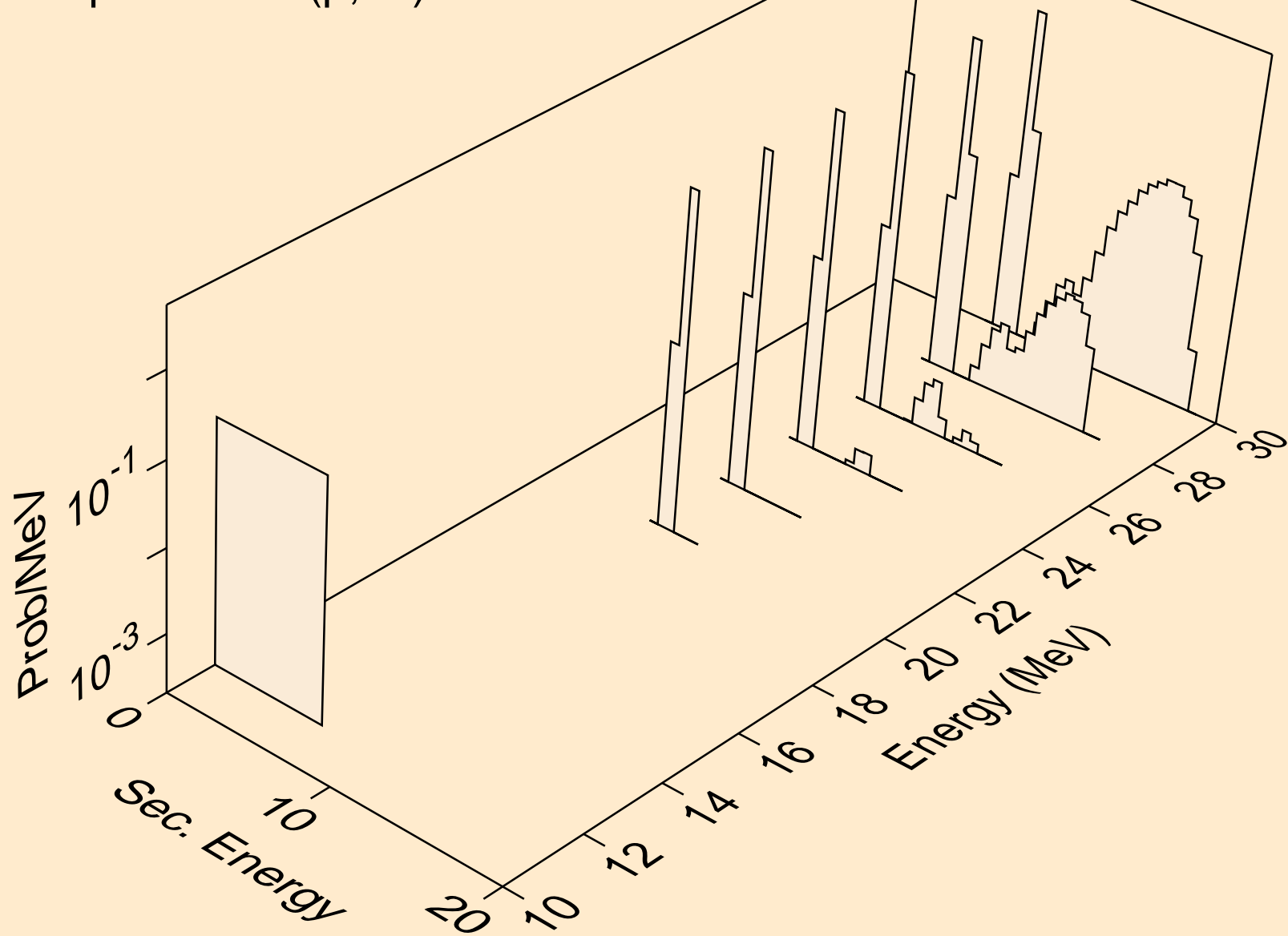

RN201M PROTON ACER TENDL-2023 LIBRARY; T=0.K  
alphas from (p,n\*)2a

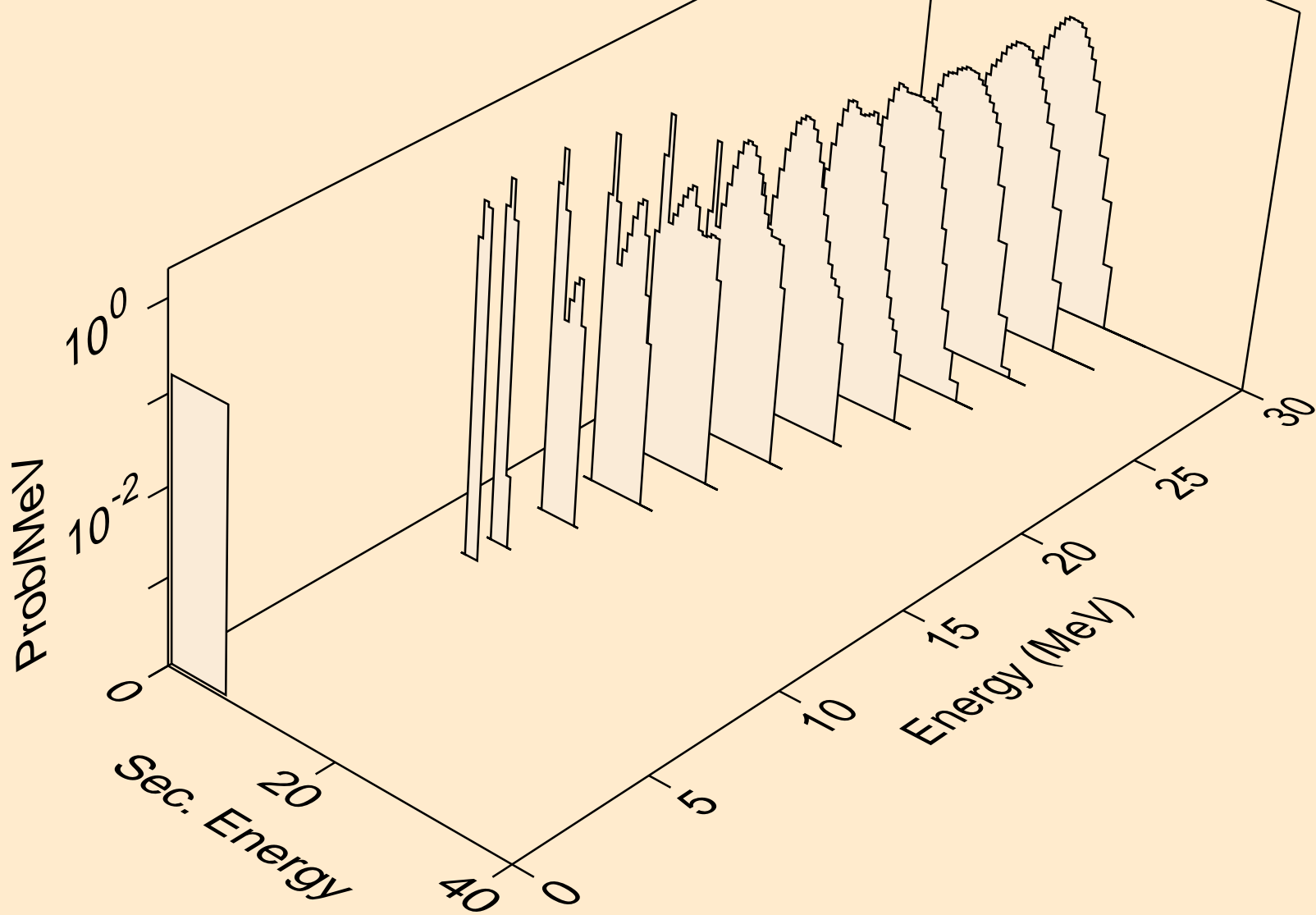

RN201M PROTON ACER TENDL-2023 LIBRARY; T=0.K  
alphas from (p,npa)

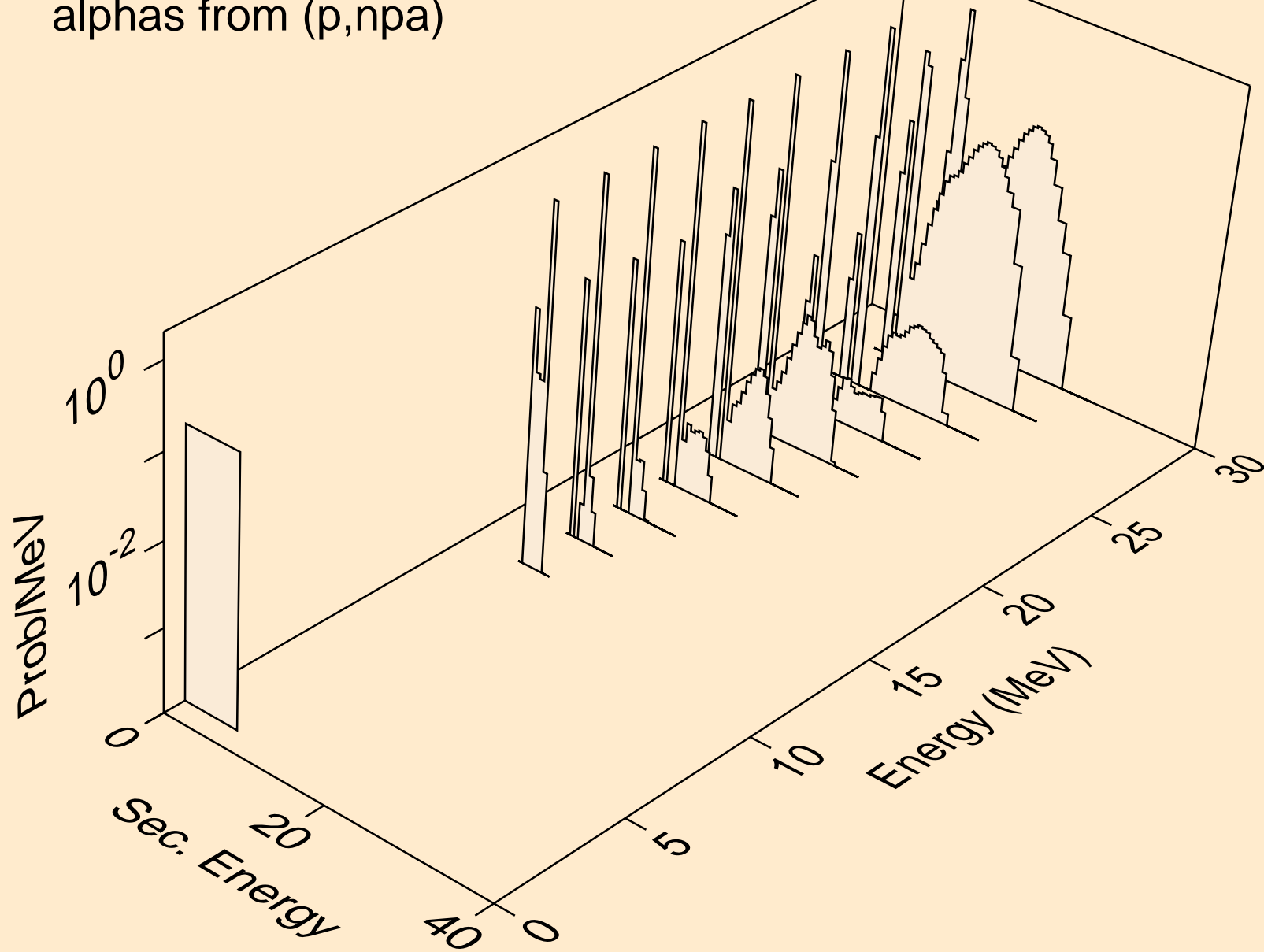

RN201M PROTON ACER TENDL-2023 LIBRARY; T=0.K  
alphas from (p,a)

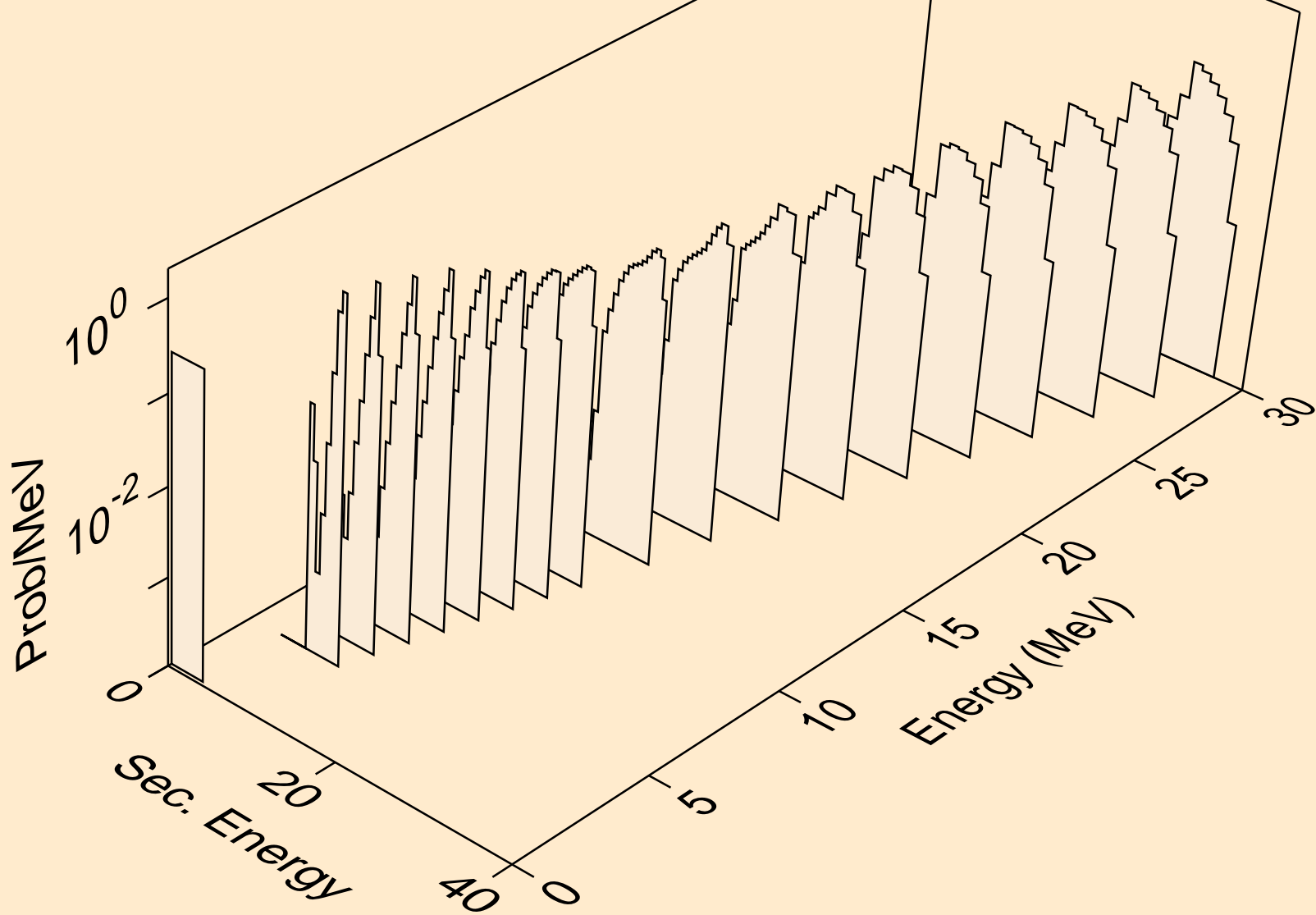



RN201M PROTON ACER TENDL-2023 LIBRARY; T=0.K  
alphas from (p,2a)

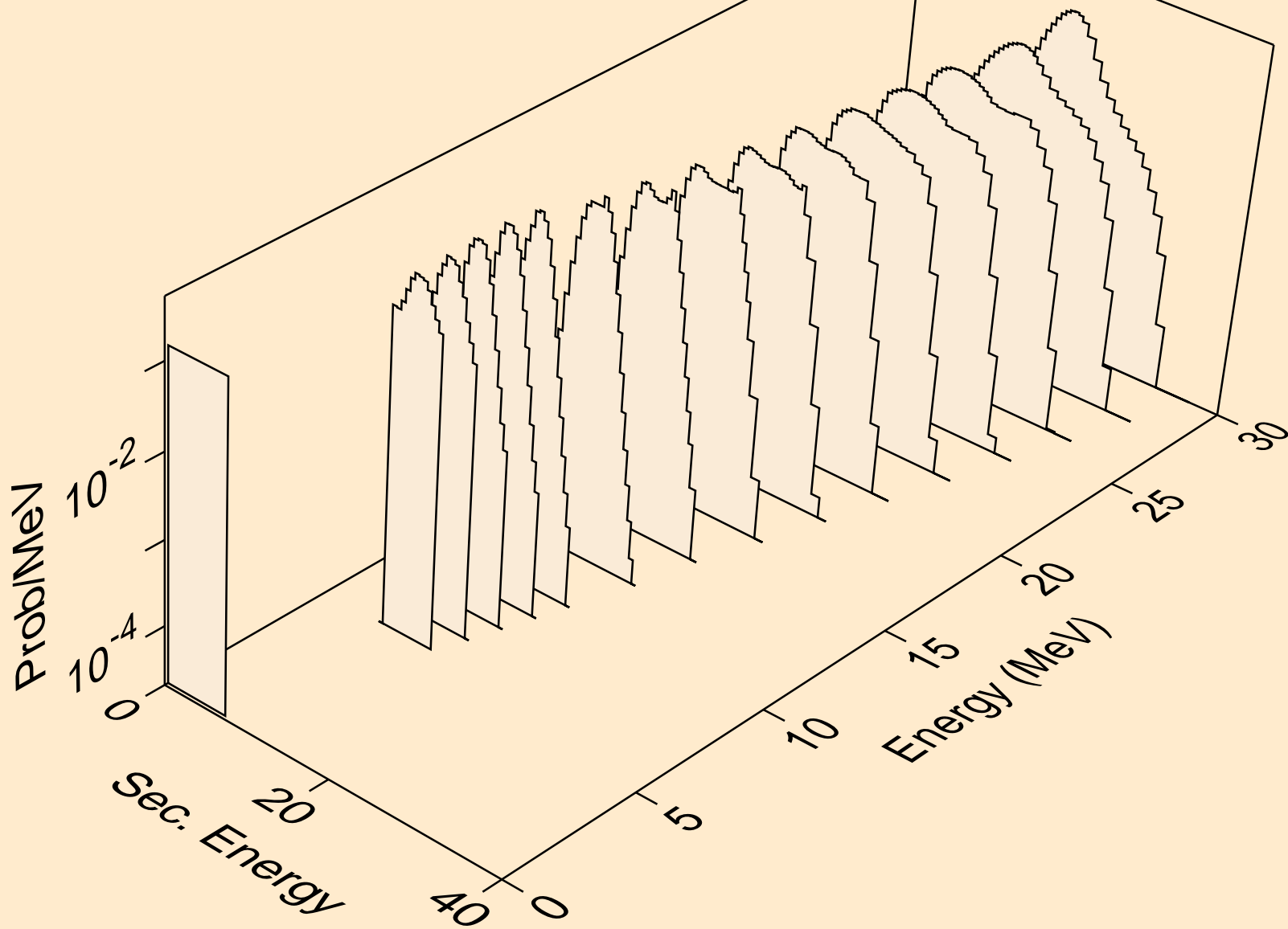

RN201M PROTON ACER TENDL-2023 LIBRARY; T=0.K  
alphas from (p,pa)

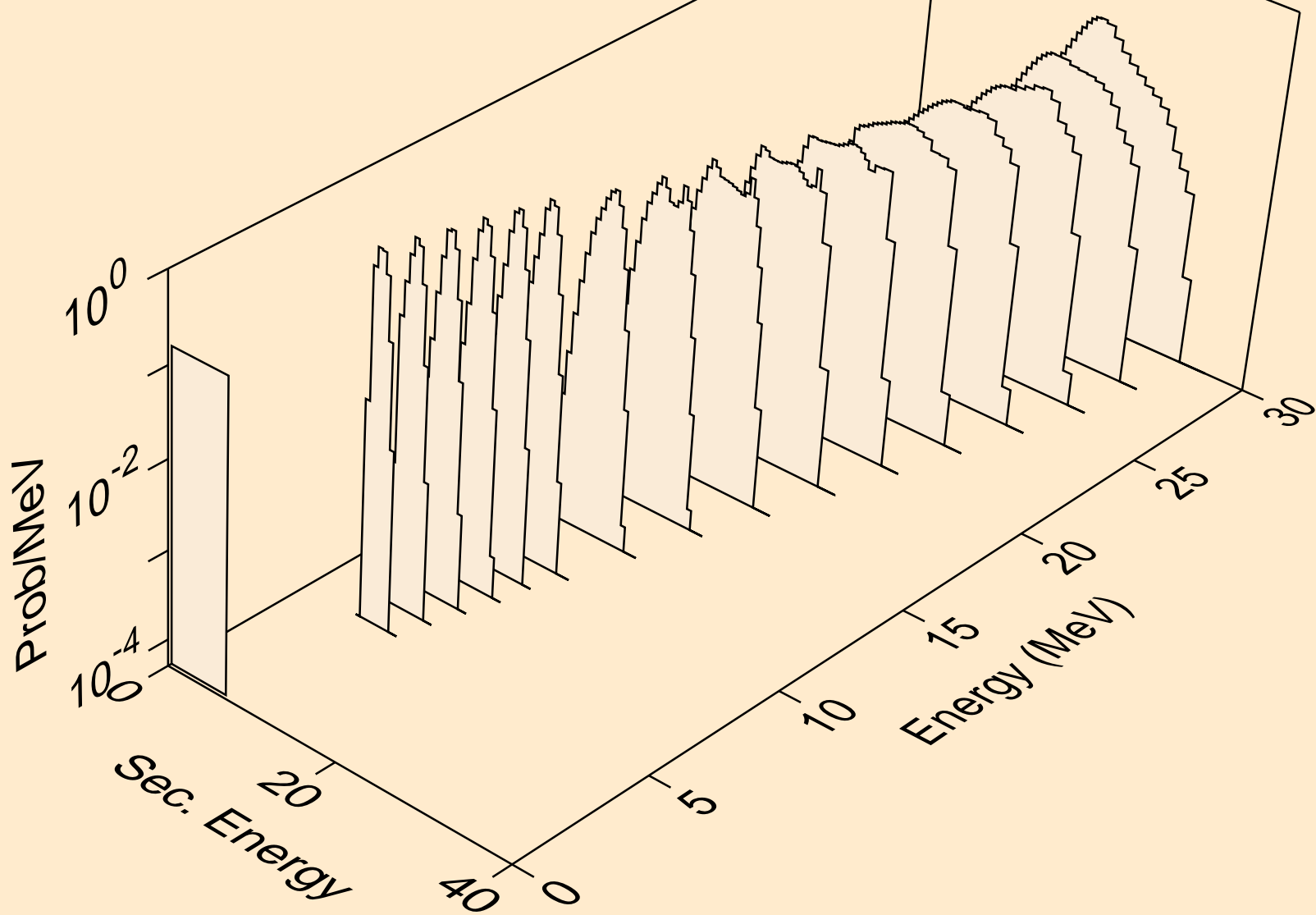

RN201M PROTON ACER TENDL-2023 LIBRARY; T=0.K  
alphas from (p,da)

