

# SM131 PROTON ACER TENDL-2023 LIBRARY; T=0.K

## Principal cross sections

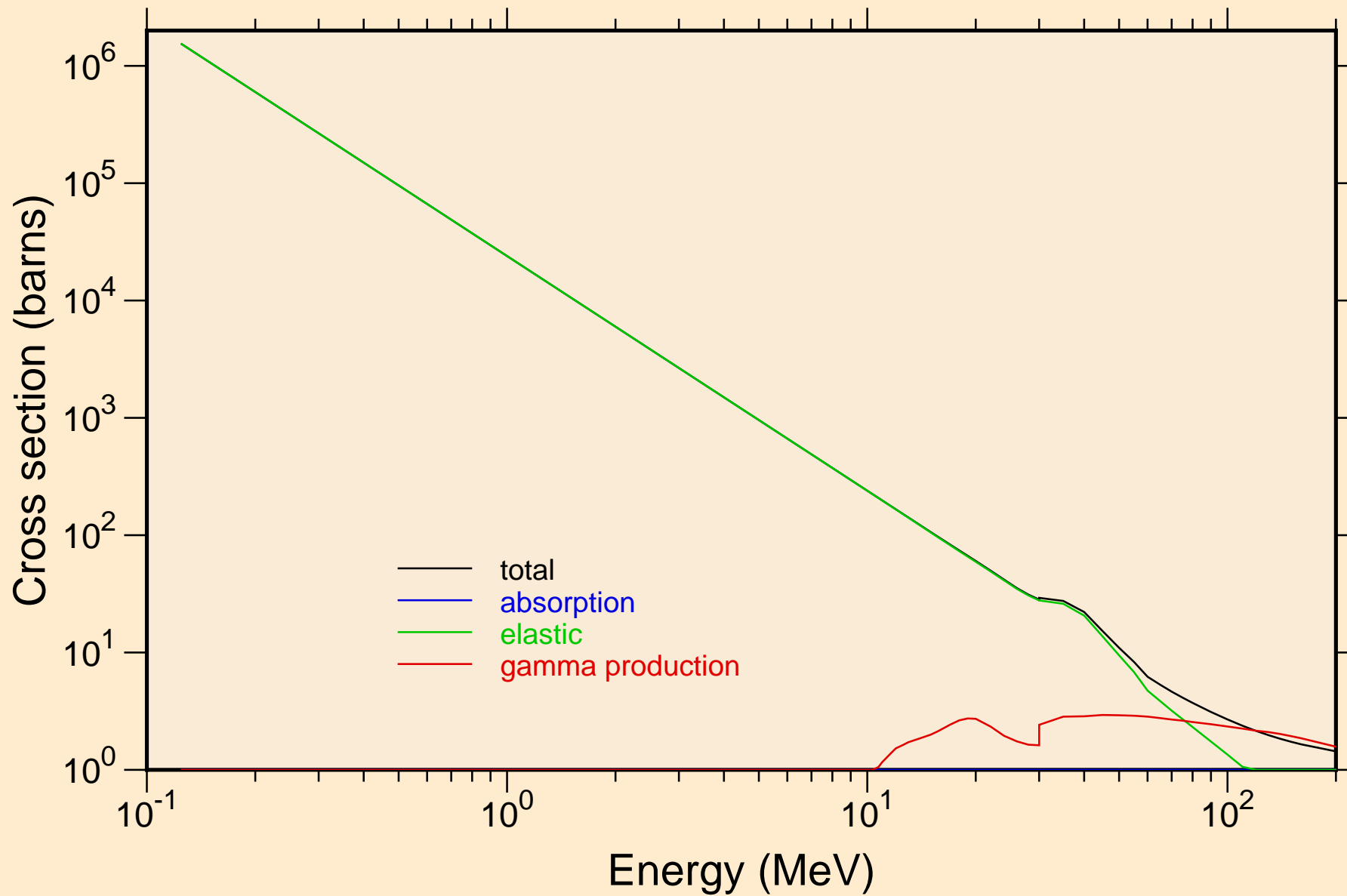

SM131 PROTON ACER TENDL-2023 LIBRARY; T=0.K  
Heating

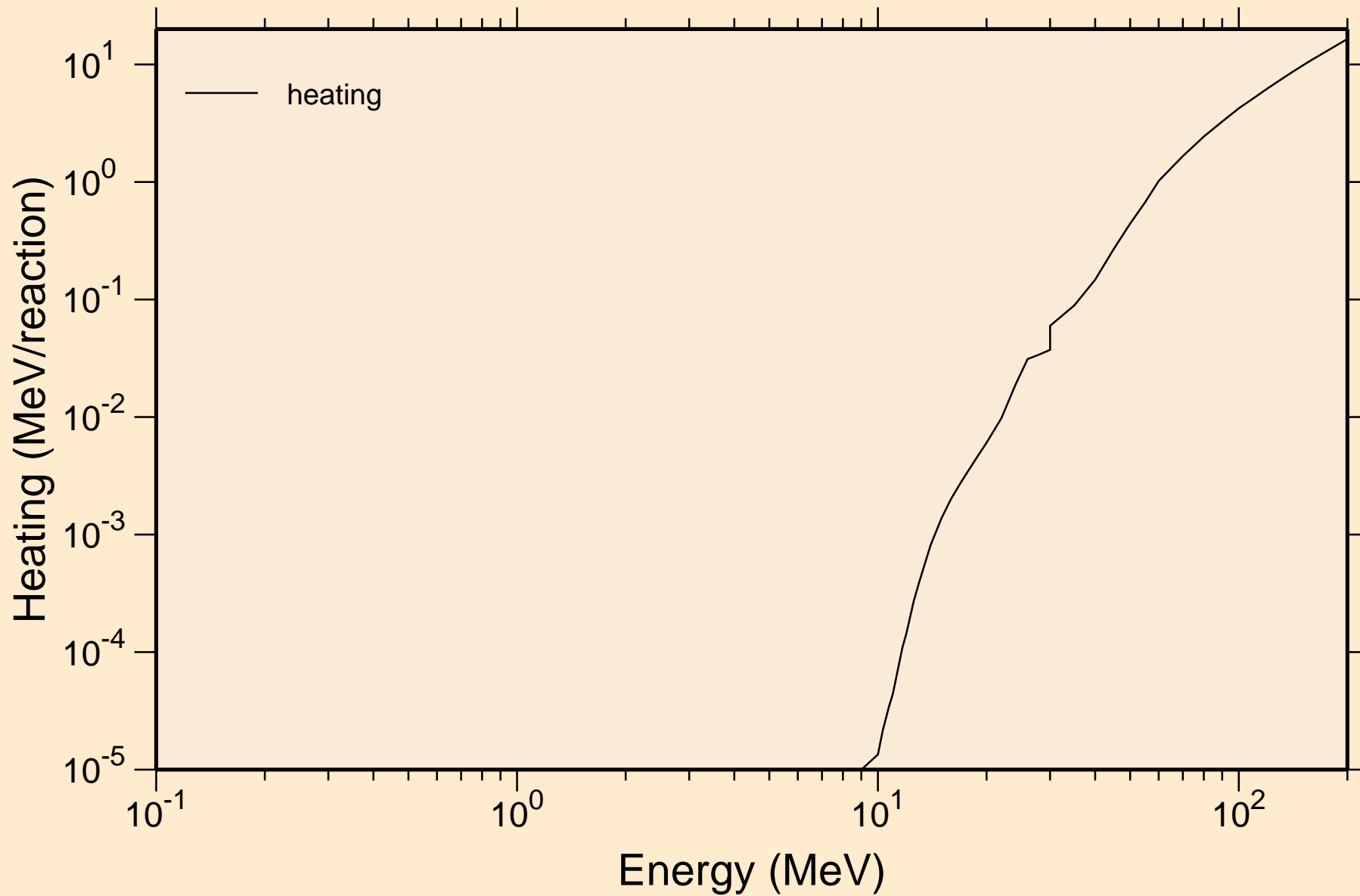

# SM131 PROTON ACER TENDL-2023 LIBRARY; T=0.K

## Principal cross sections

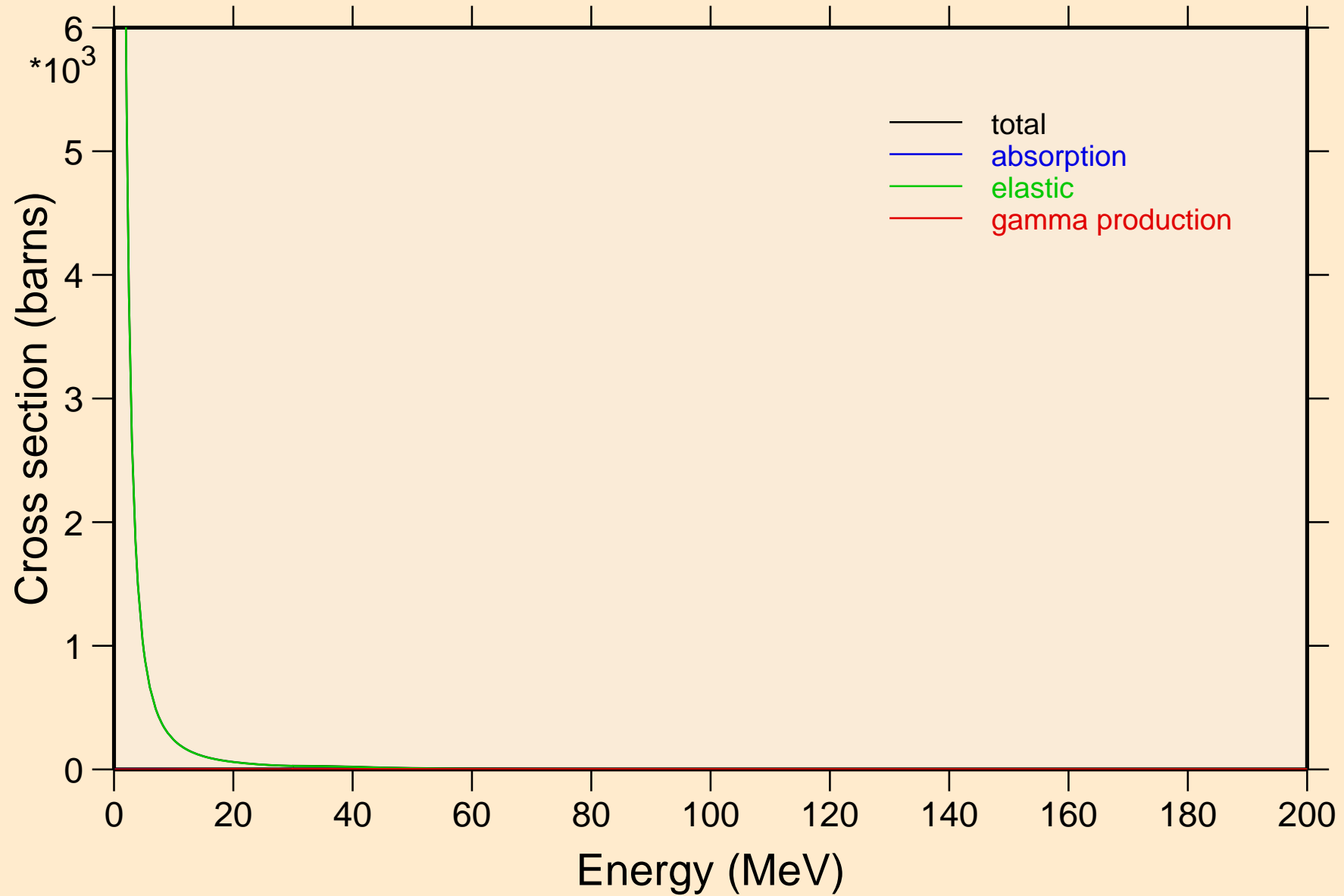

# SM131 PROTON ACER TENDL-2023 LIBRARY; T=0.K

## Heating

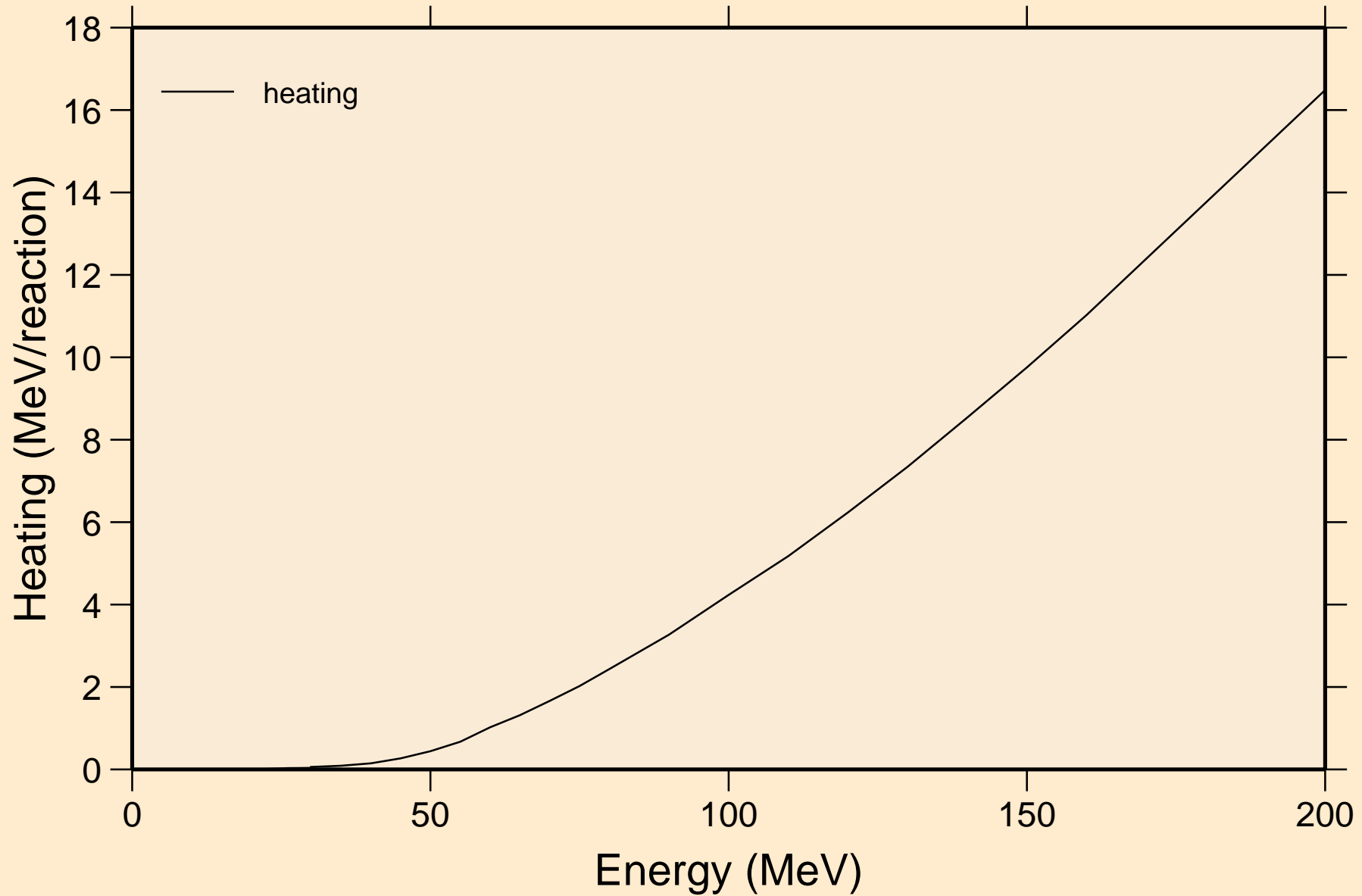

SM131 PROTON ACER TENDL-2023 LIBRARY; T=0.K  
Threshold reactions

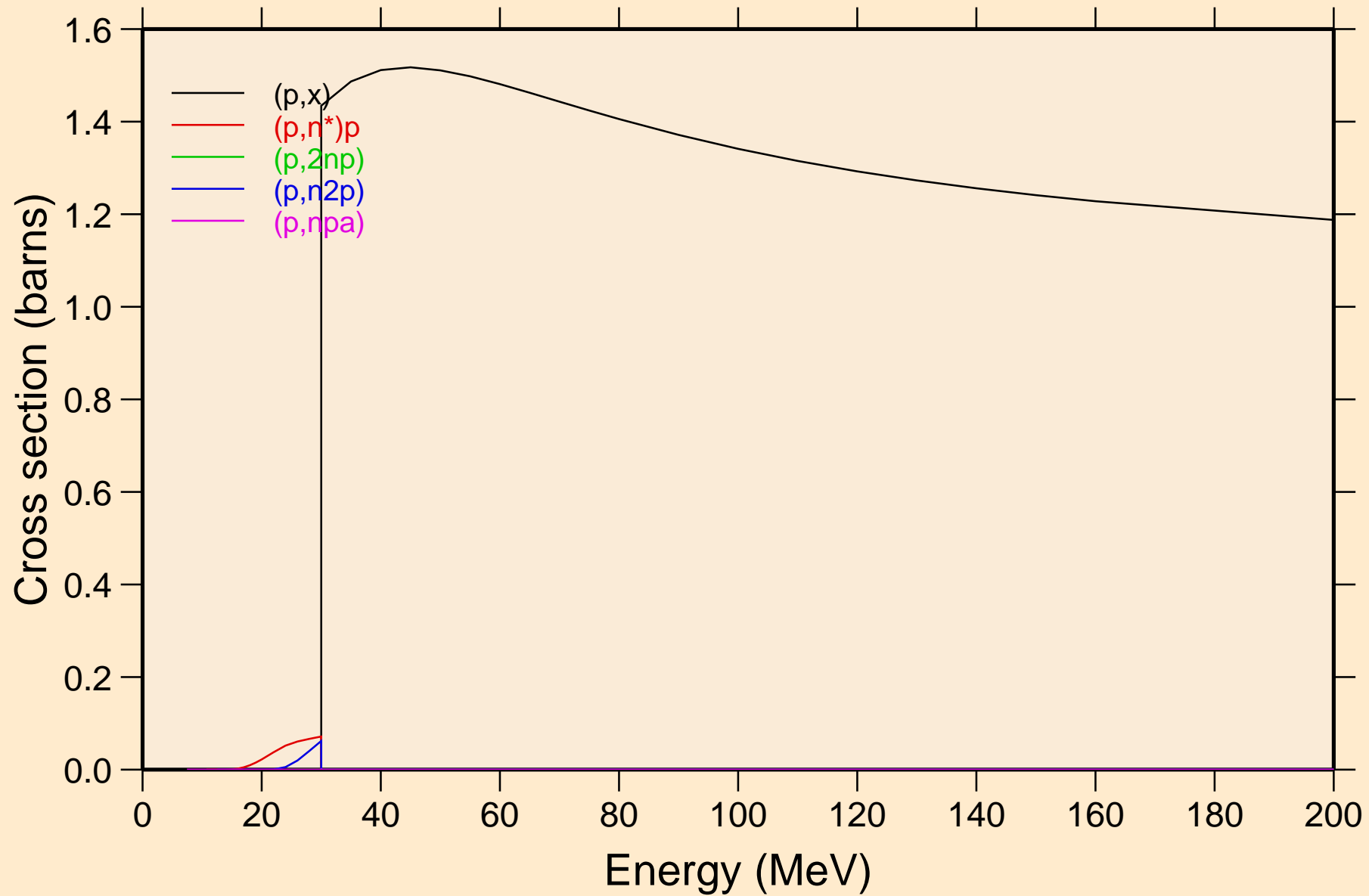

# SM131 PROTON ACER TENDL-2023 LIBRARY; T=0.K

## Threshold reactions

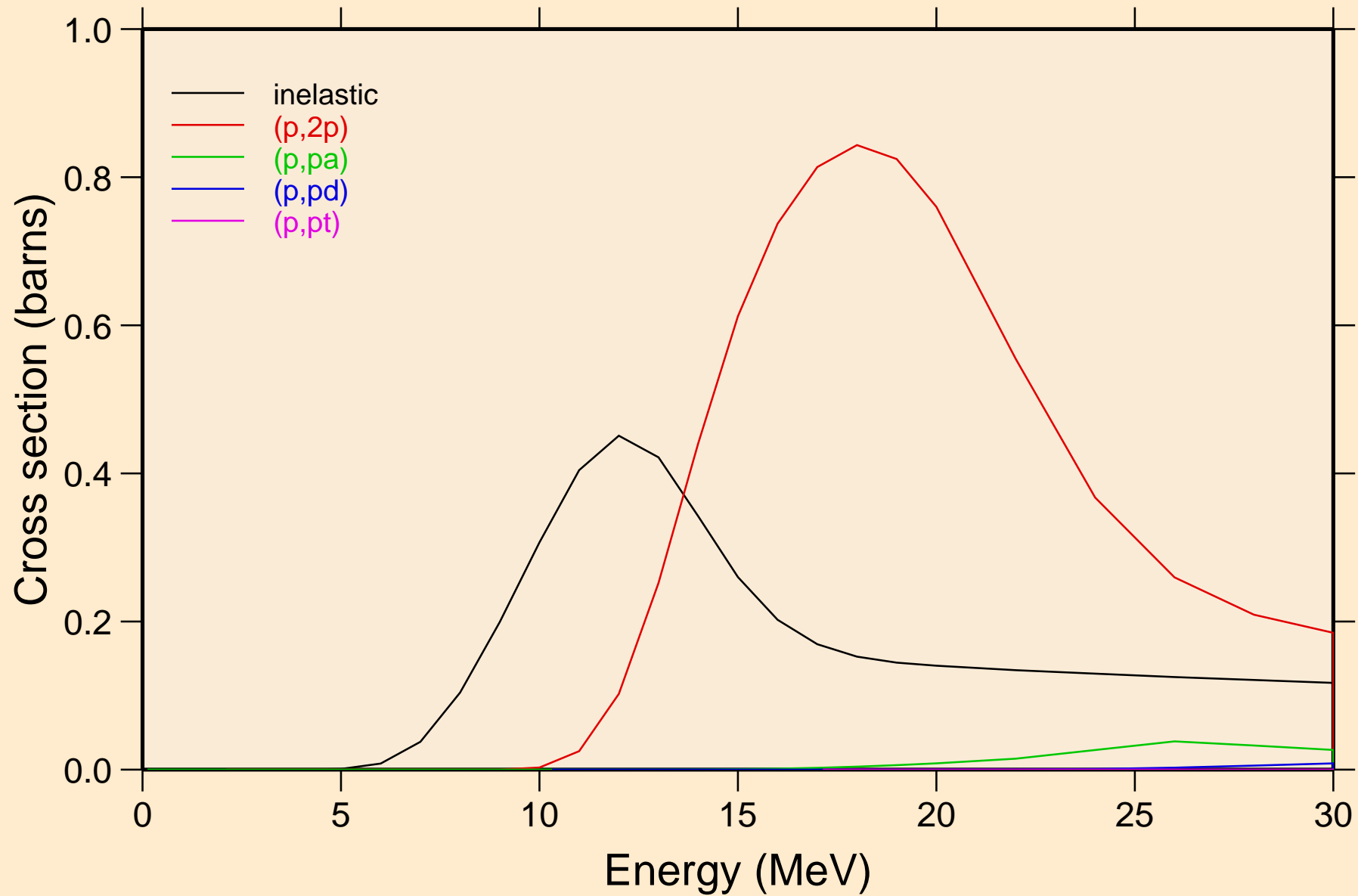

SM131 PROTON ACER TENDL-2023 LIBRARY; T=0.K  
Threshold reactions

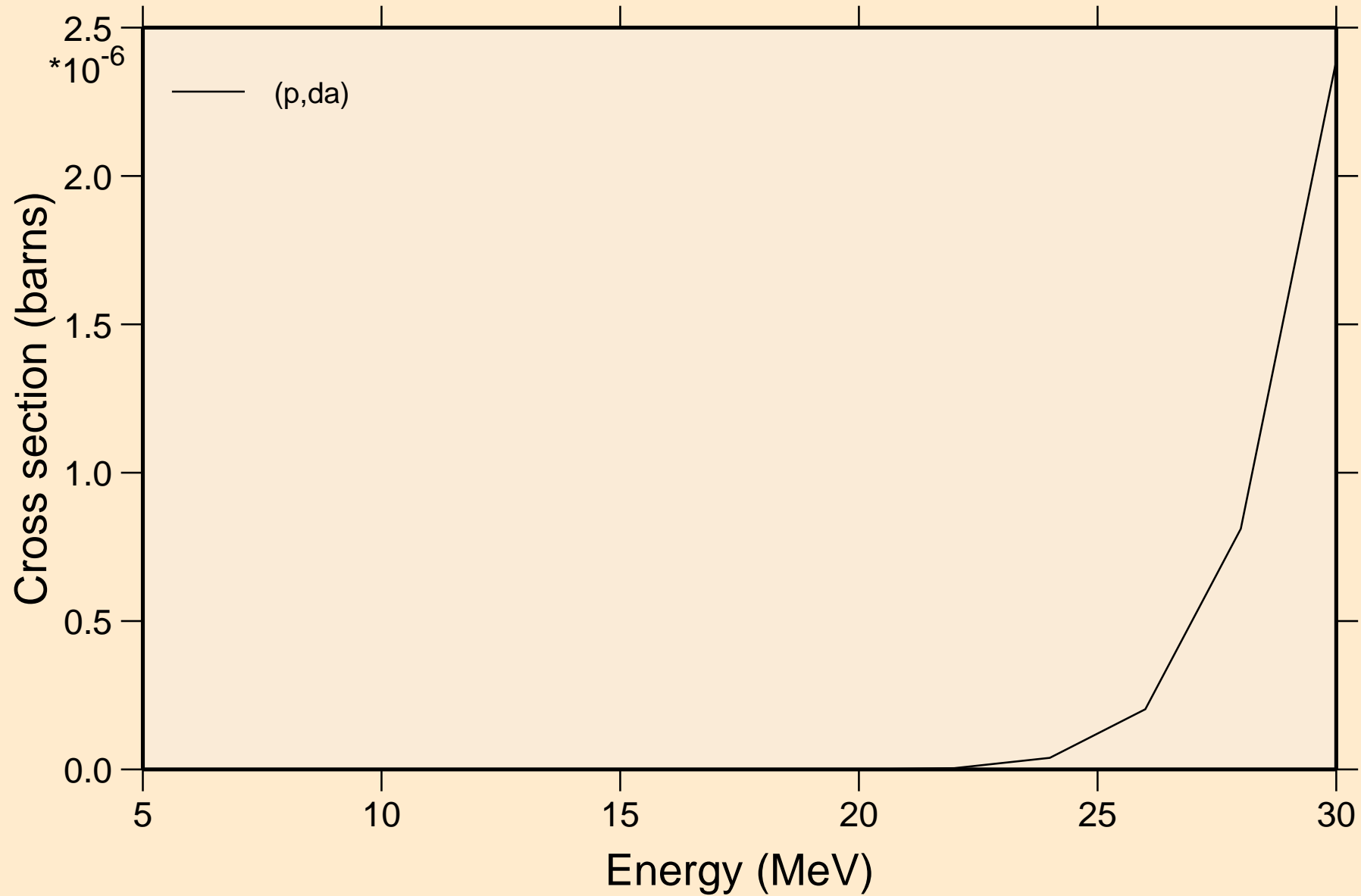

SM131 PROTON ACER TENDL-2023 LIBRARY; T=0.K  
angular distribution for elastic

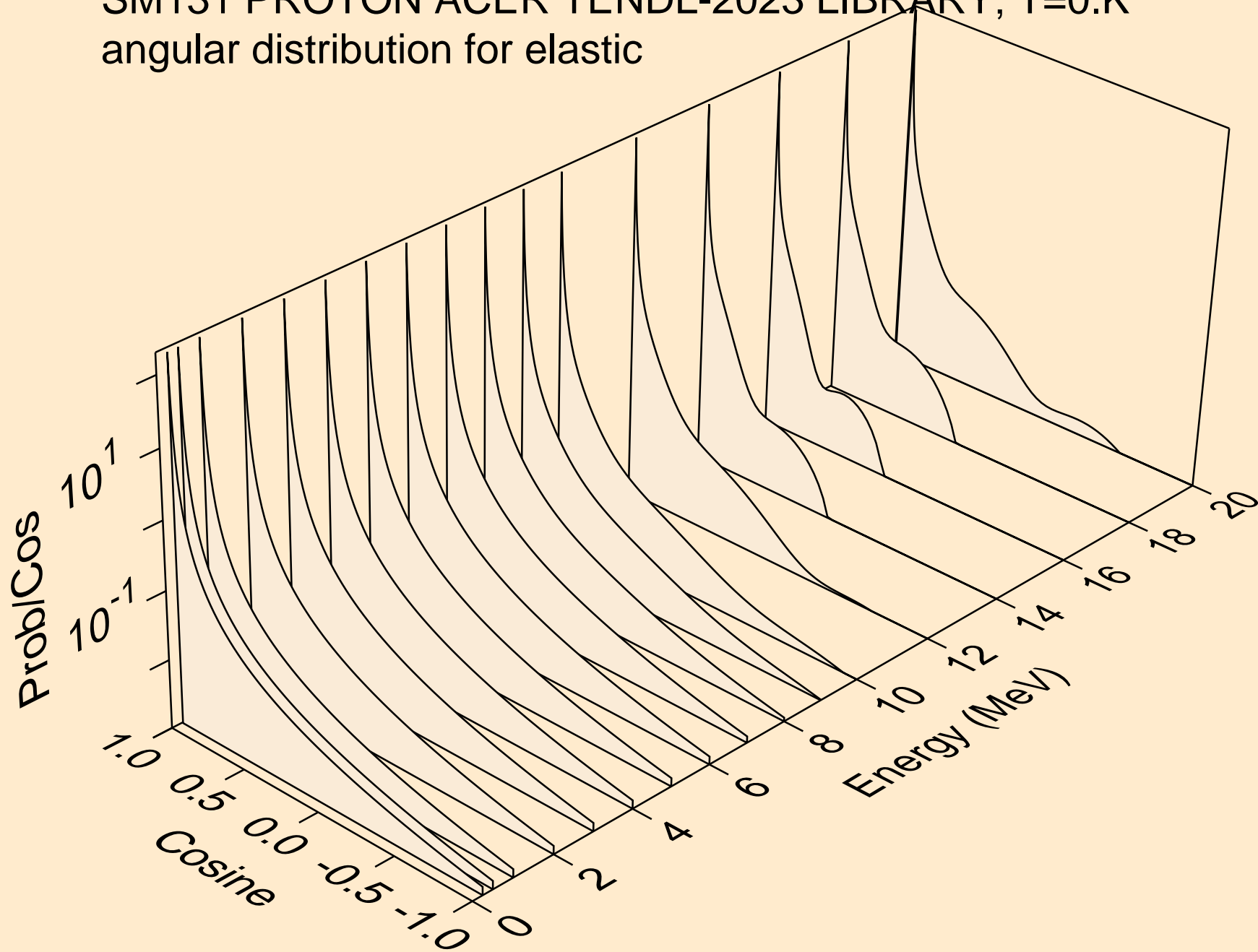



SM131 PROTON ACER TENDL-2023 LIBRARY; T=0.K  
angular distribution for elastic

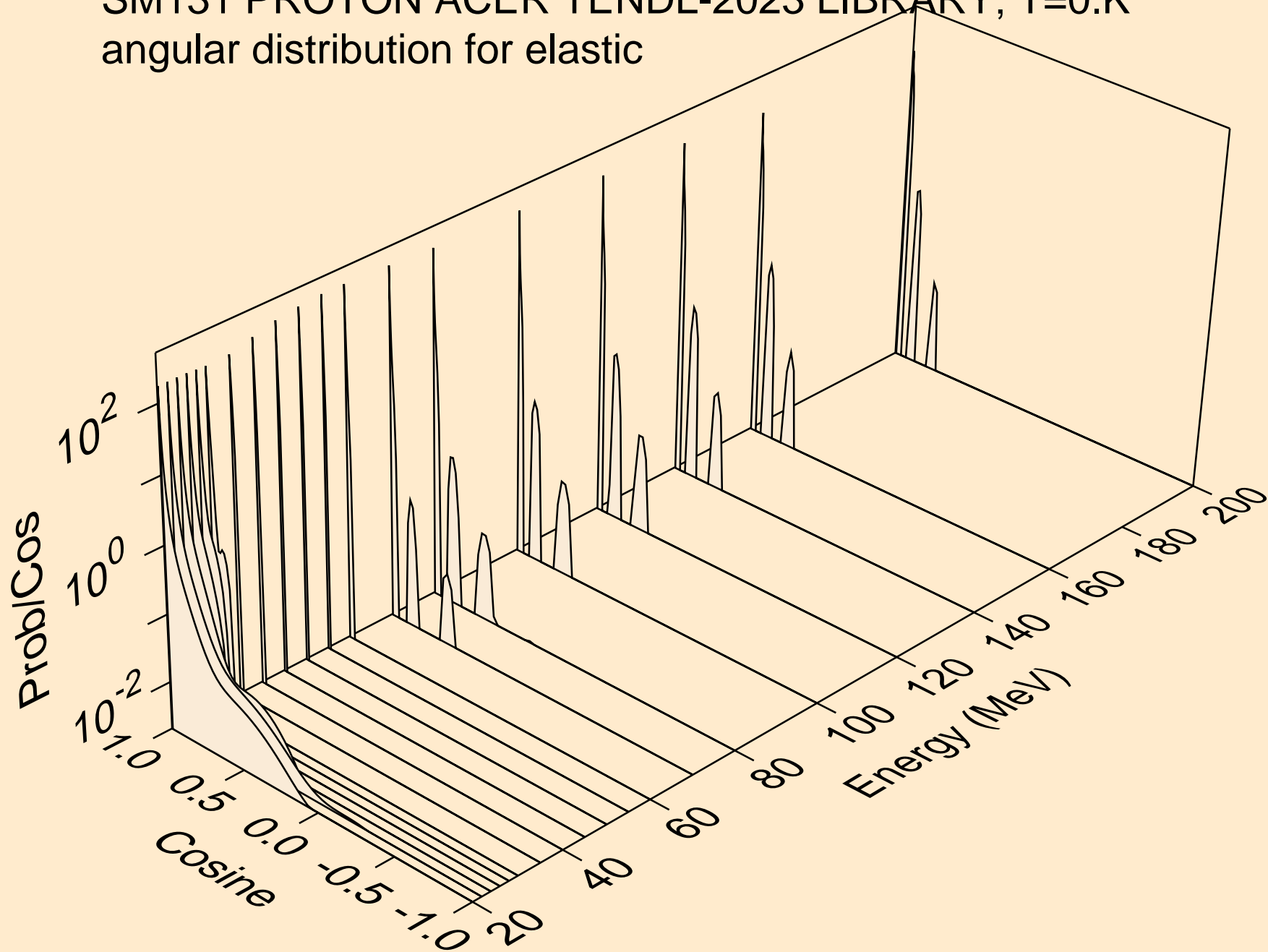

SM131 PROTON ACER TENDL-2023 LIBRARY; T=0.K  
Proton emission for (p,x)

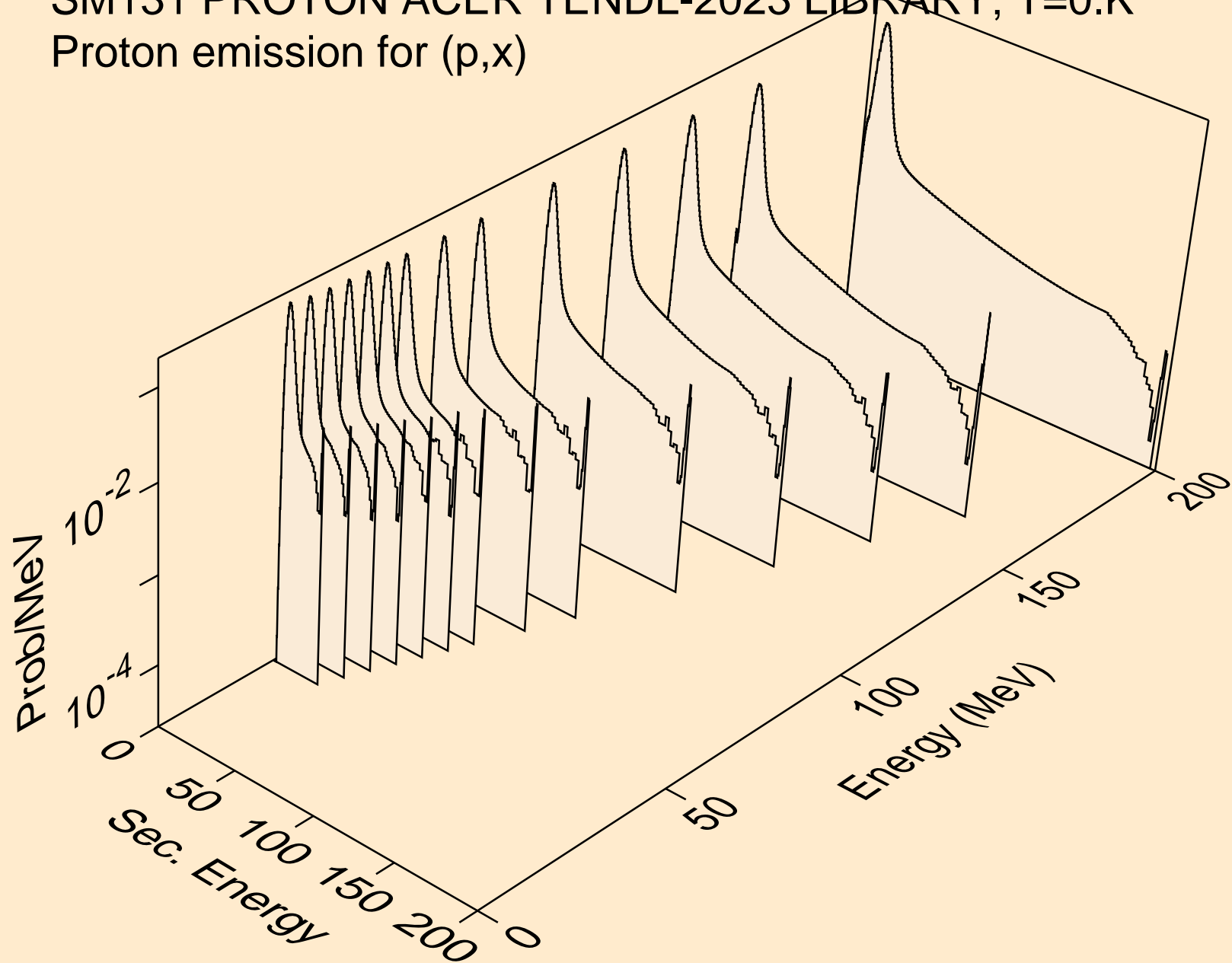

SM131 PROTON ACER TENDL-2023 LIBRARY; T=0.K  
Proton emission for (p,n\*)p

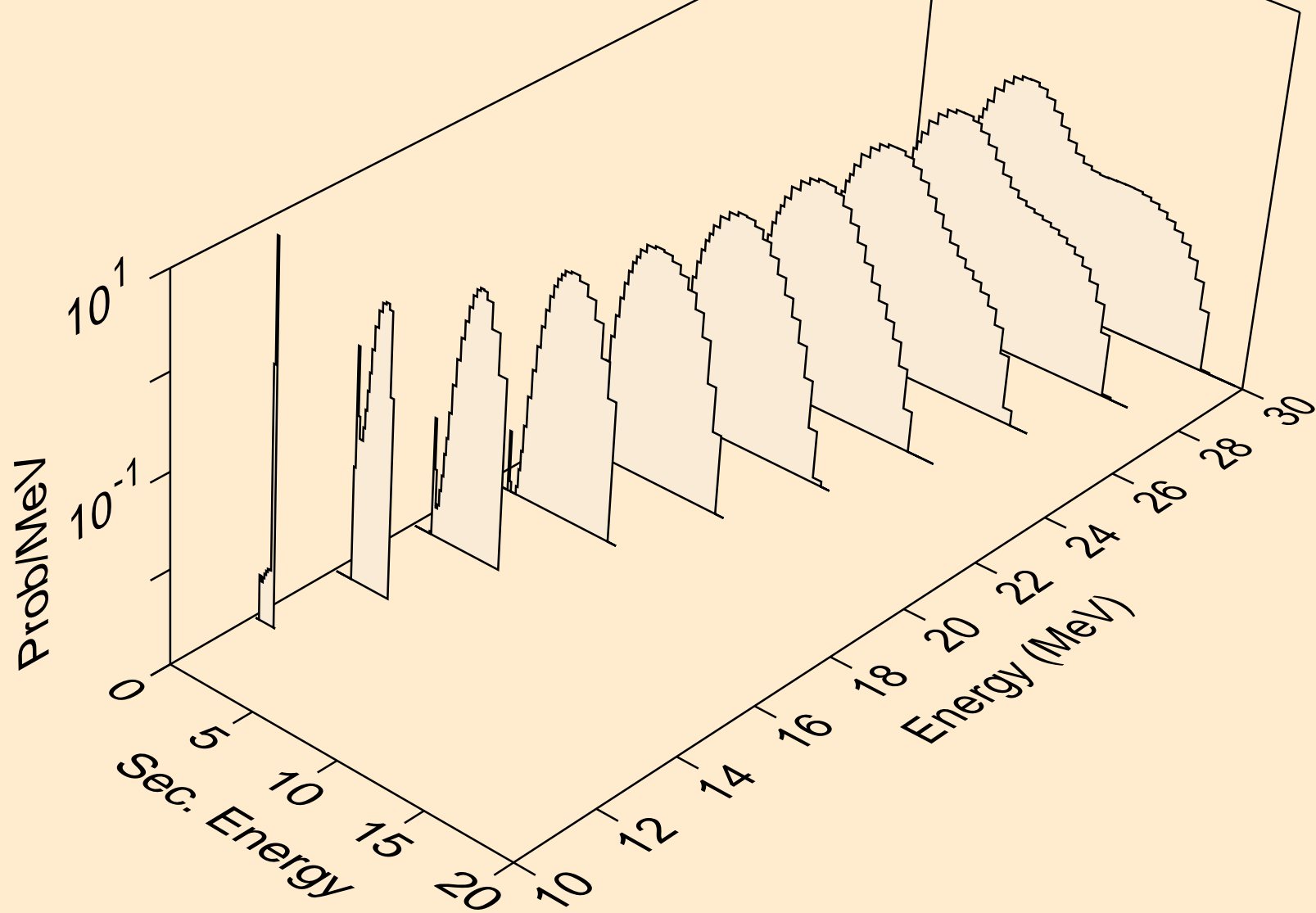

SM131 PROTON ACER TENDL-2023 LIBRARY; T=0.K  
Proton emission for (p,2np)

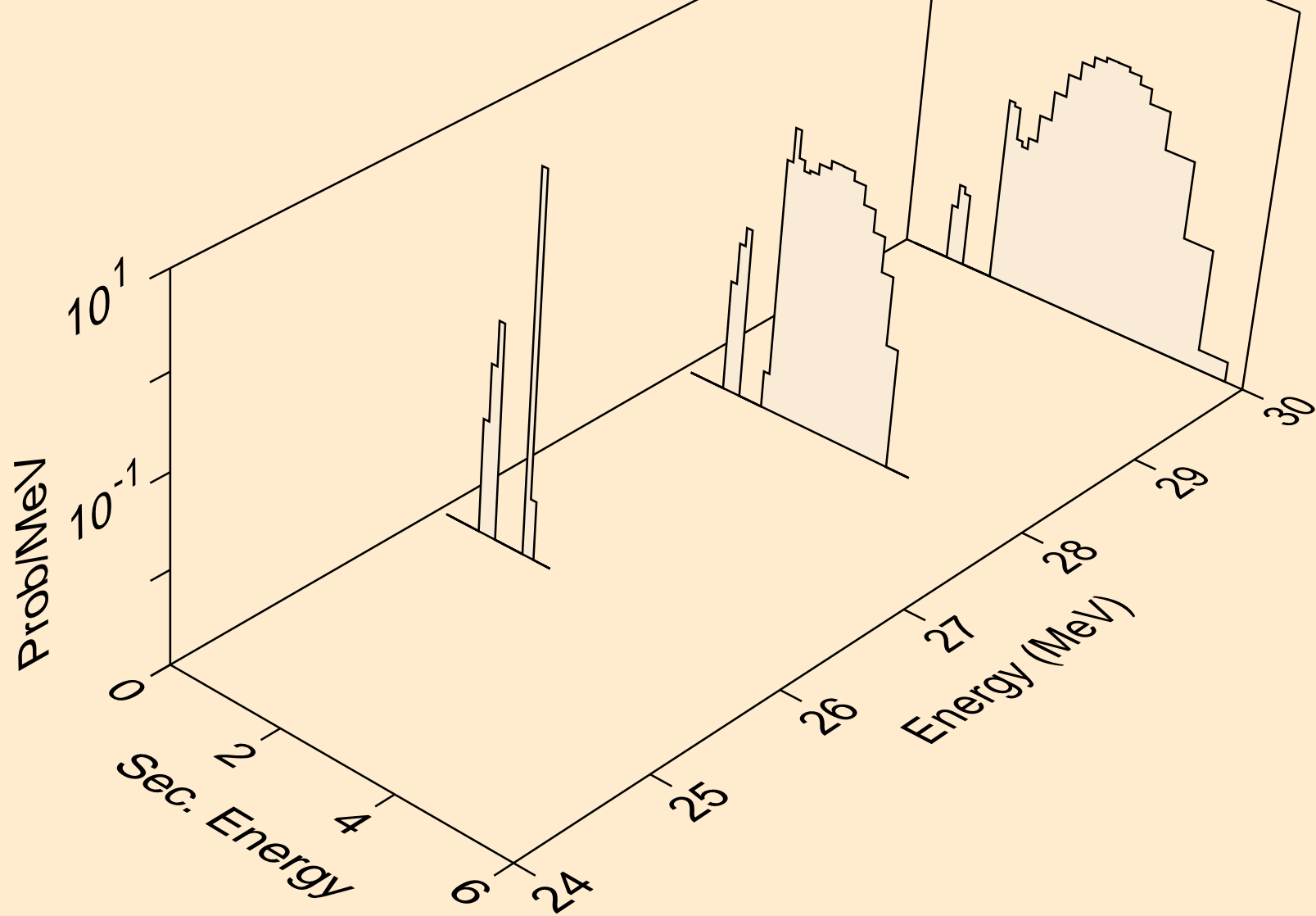

SM131 PROTON ACER TENDL-2023 LIBRARY; T=0.K  
Proton emission for (p,n2p)

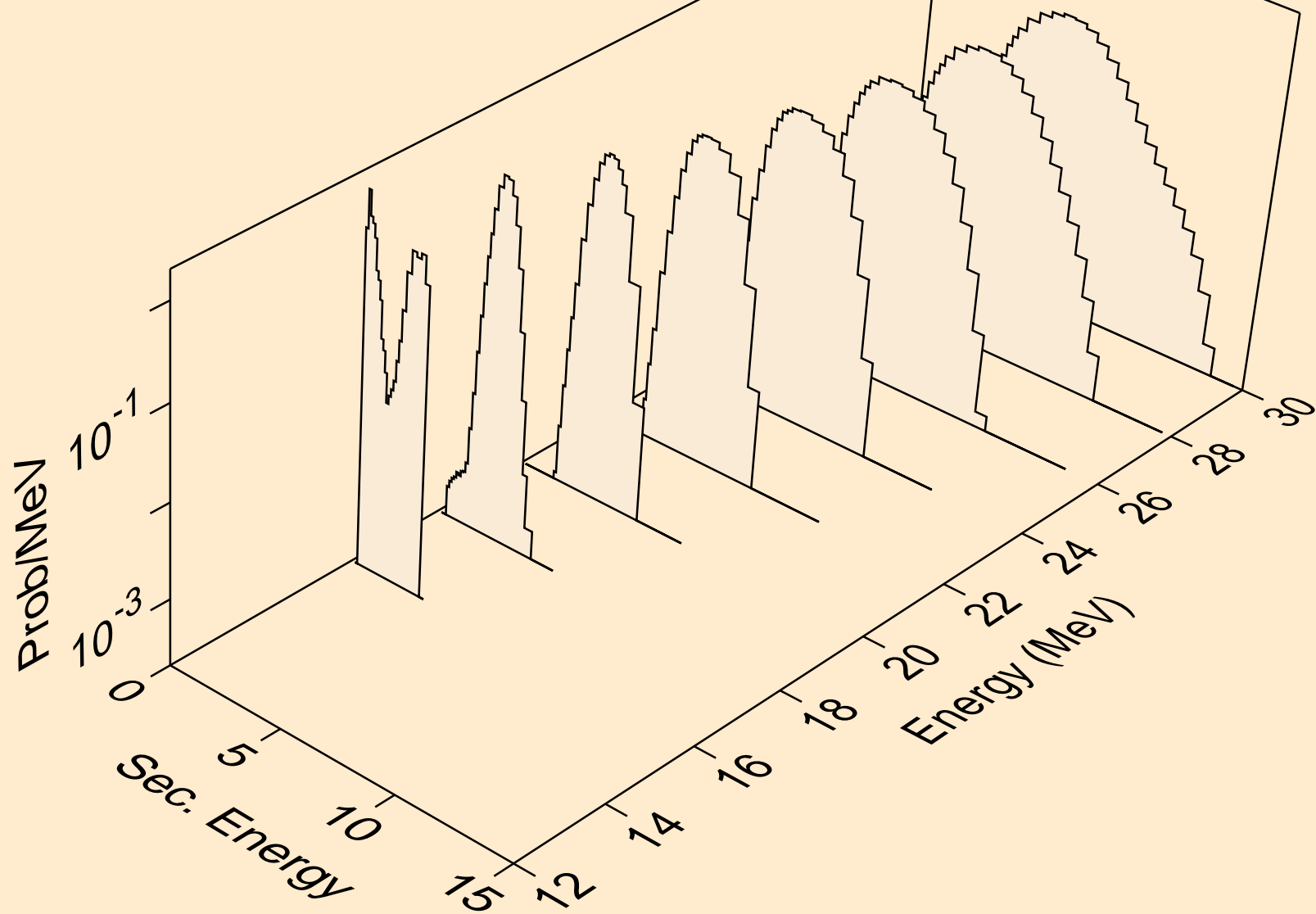

SM131 PROTON ACER TENDL-2023 LIBRARY; T=0.K  
Proton emission for (p,npa)

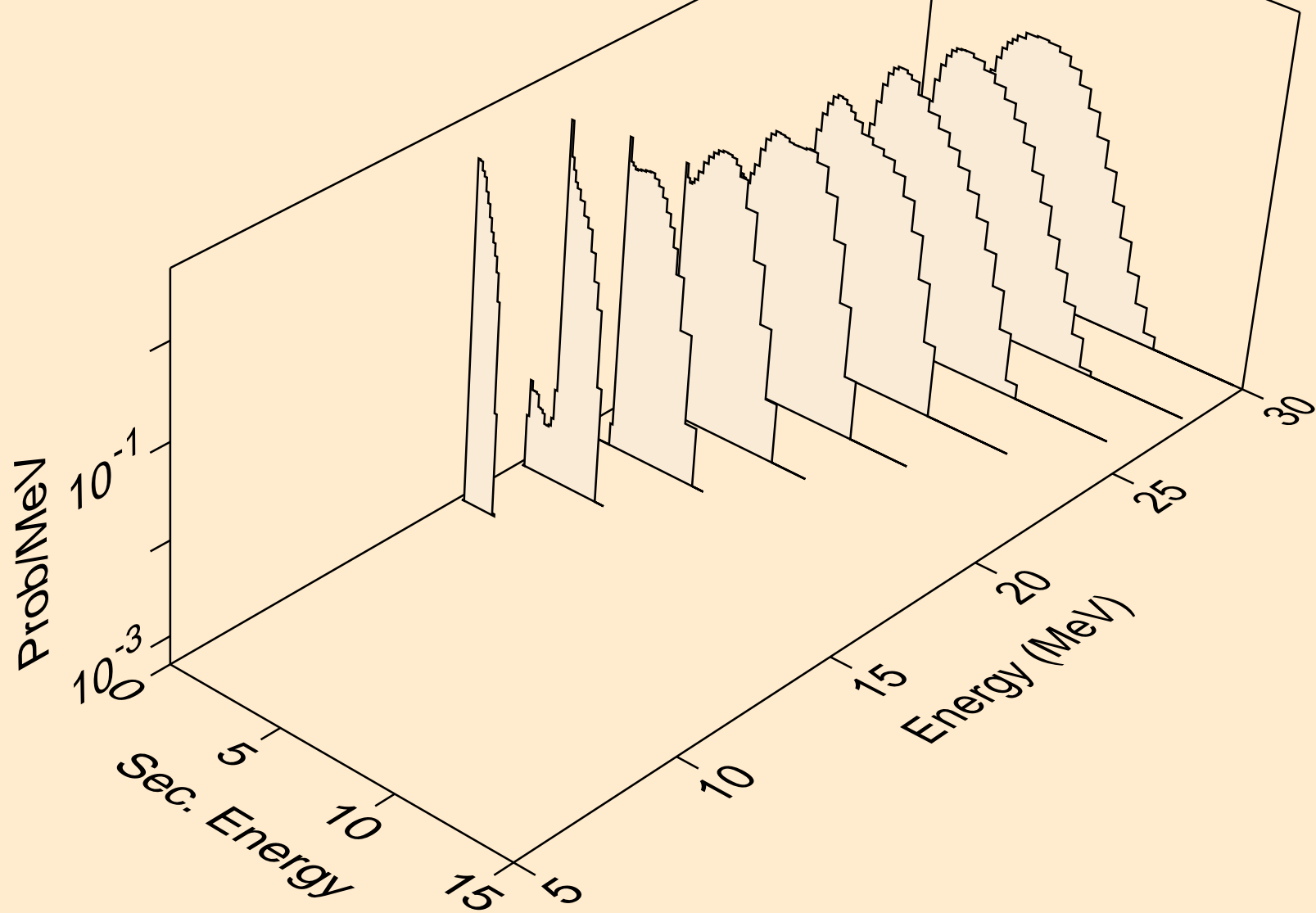

SM131 PROTON ACER TENDL-2023 LIBRARY; T=0.K  
Proton emission for inelastic

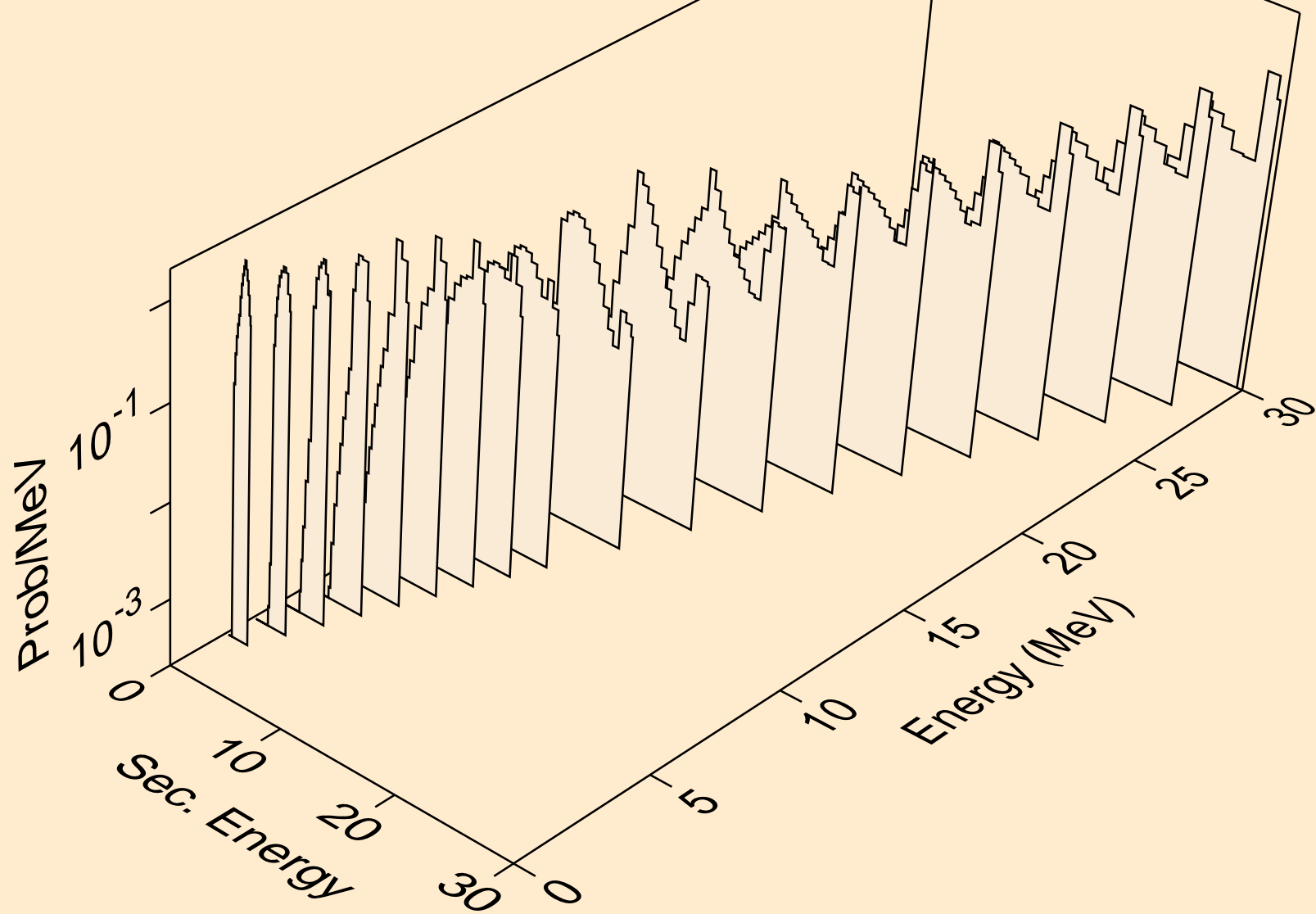

SM131 PROTON ACER TENDL-2023 LIBRARY; T=0.K  
Proton emission for (p,2p)

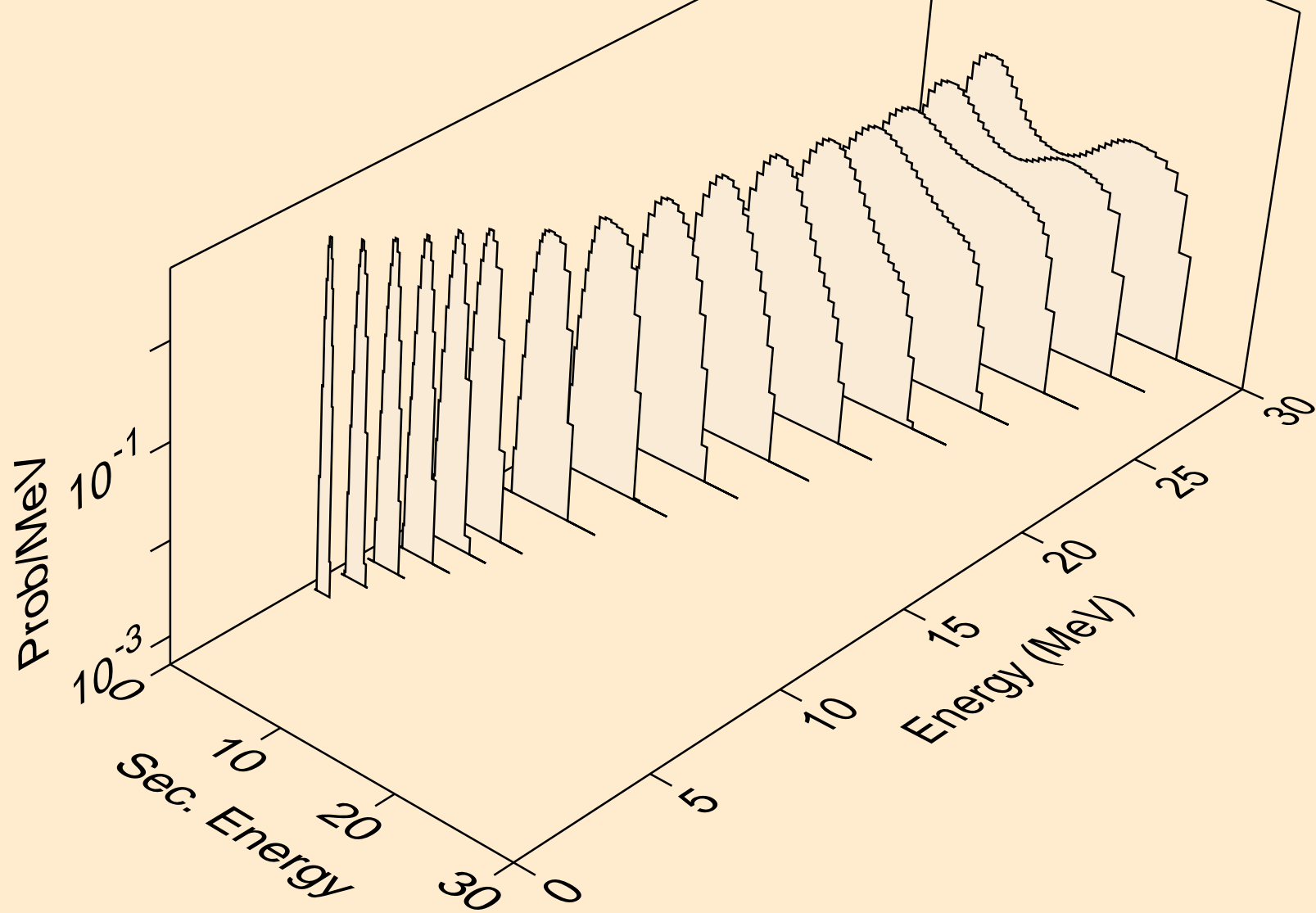



SM131 PROTON ACER TENDL-2023 LIBRARY; T=0.K  
Proton emission for (p,pa)

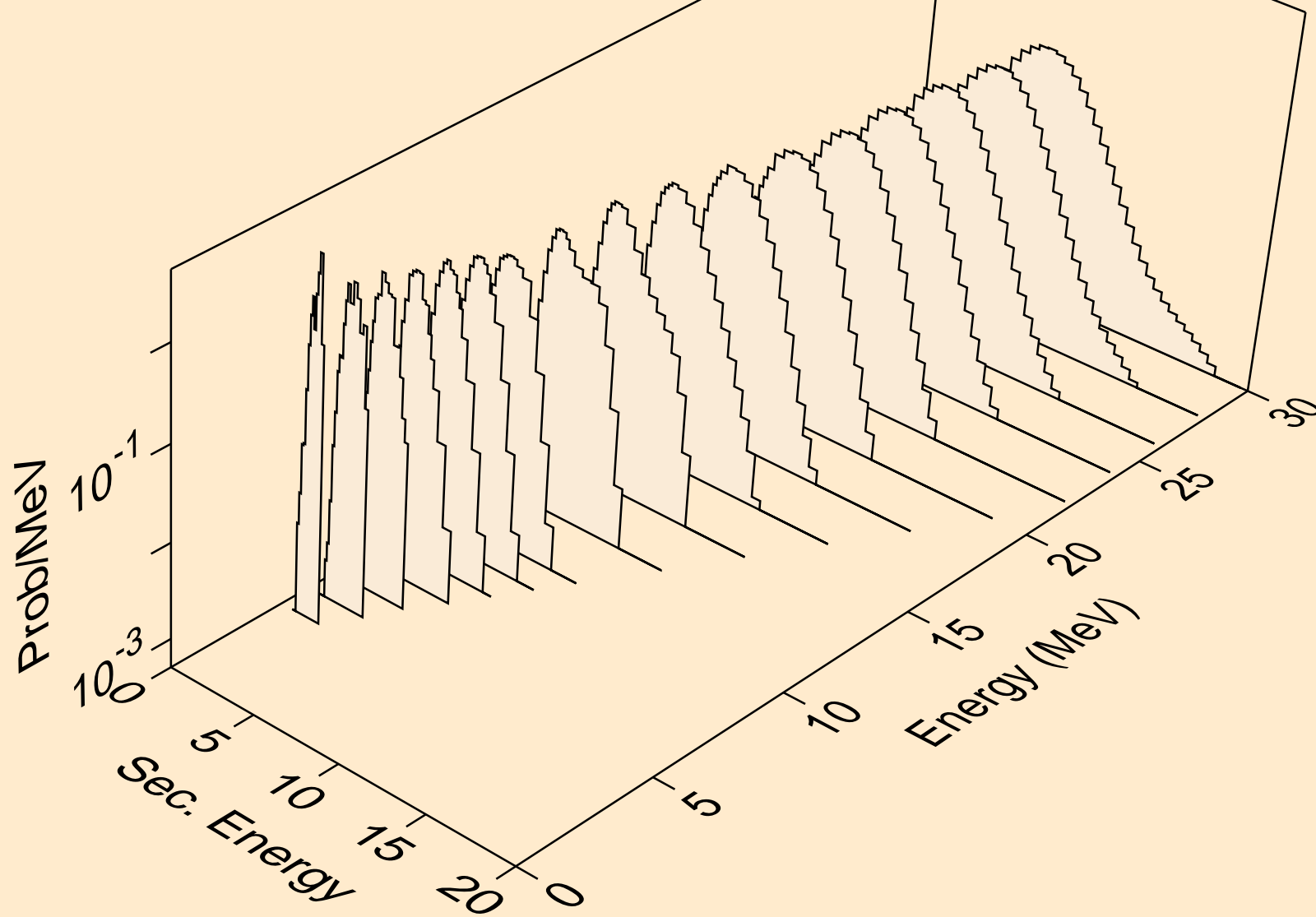

SM131 PROTON ACER TENDL-2023 LIBRARY; T=0.K  
Proton emission for (p,pd)

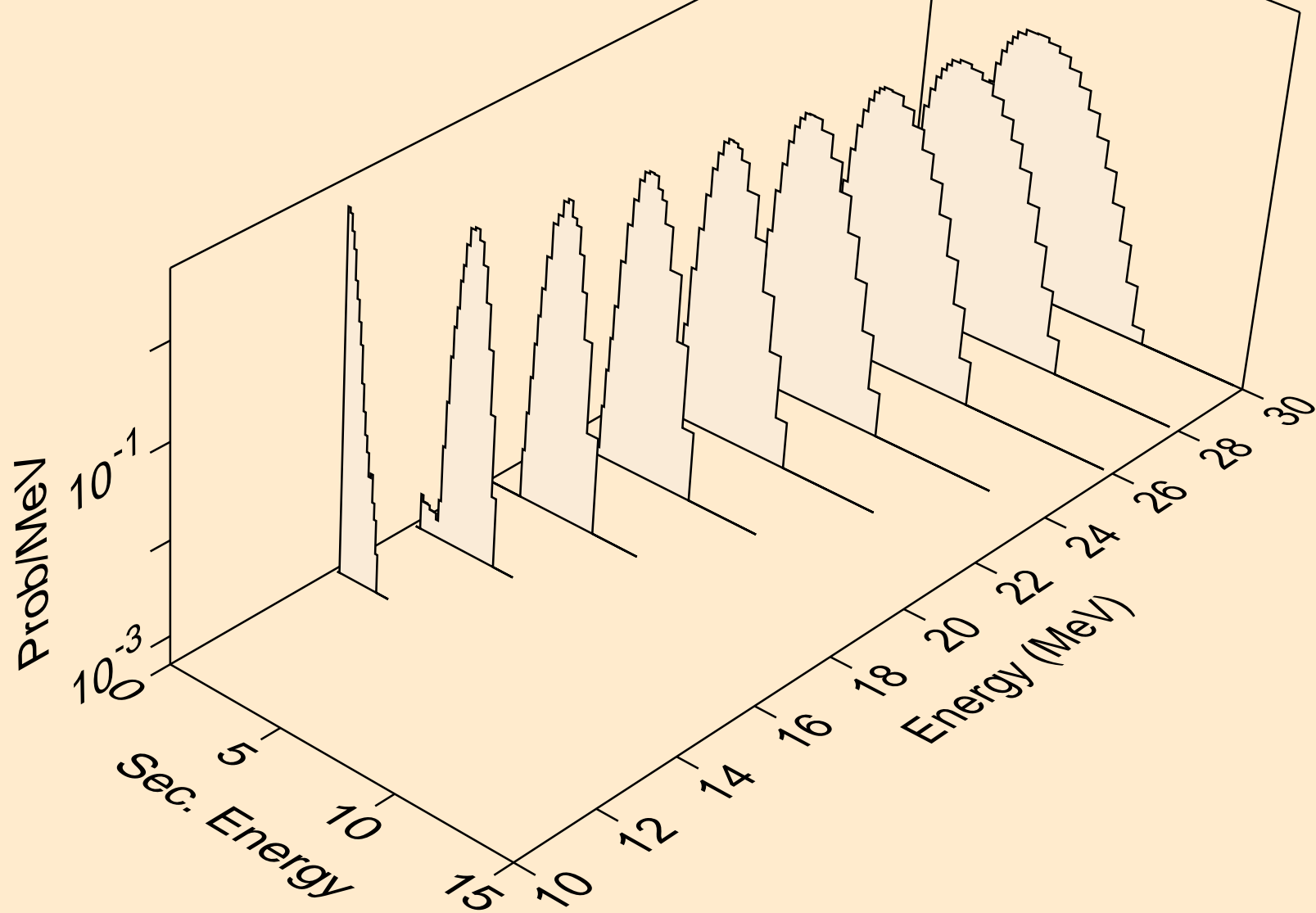

SM131 PROTON ACER TENDL-2023 LIBRARY; T=0.K  
Proton emission for (p,pt)

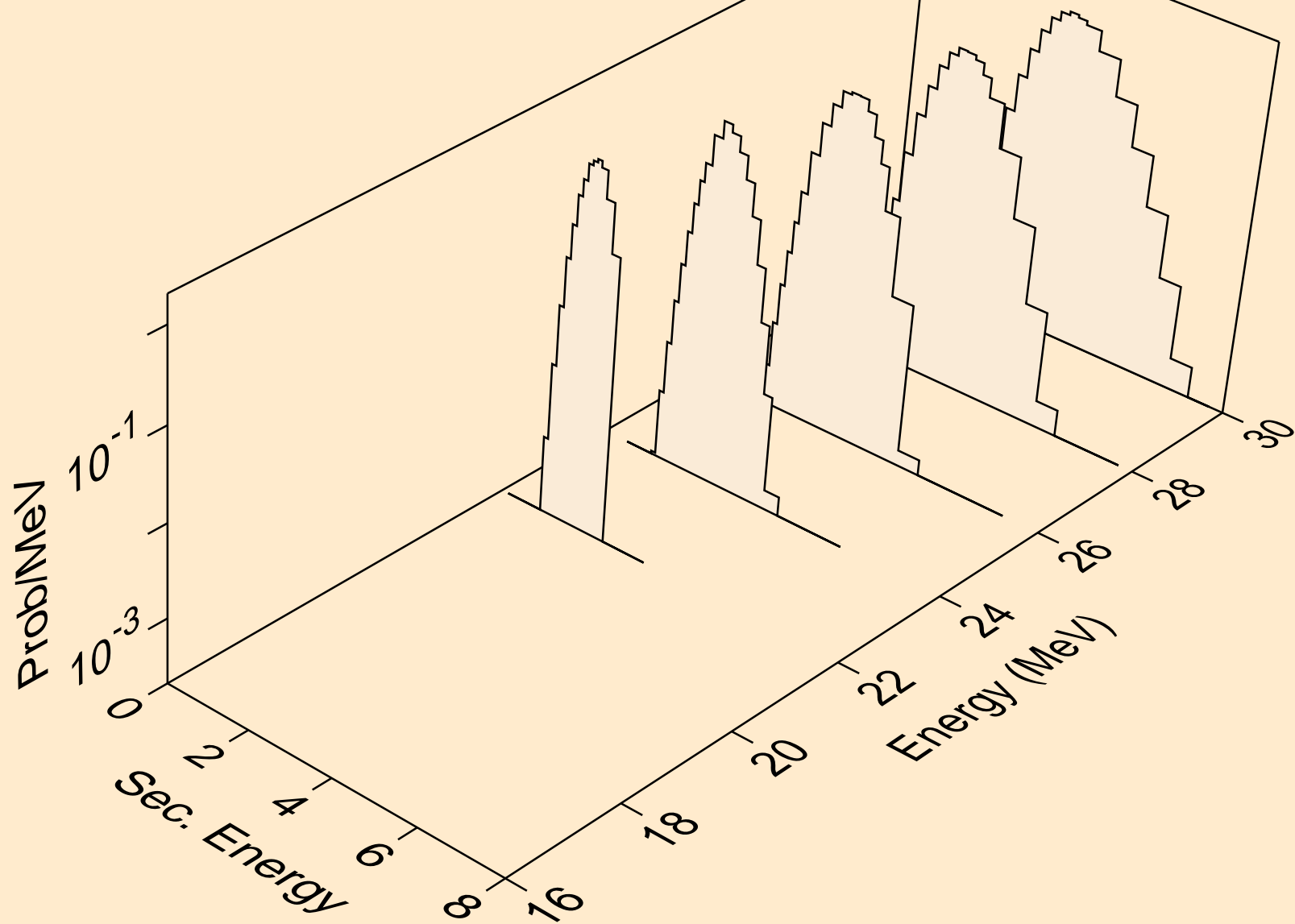

SM131 PROTON ACER TENDL-2023 LIBRARY; T=0.K  
Photon emission for (z,n)

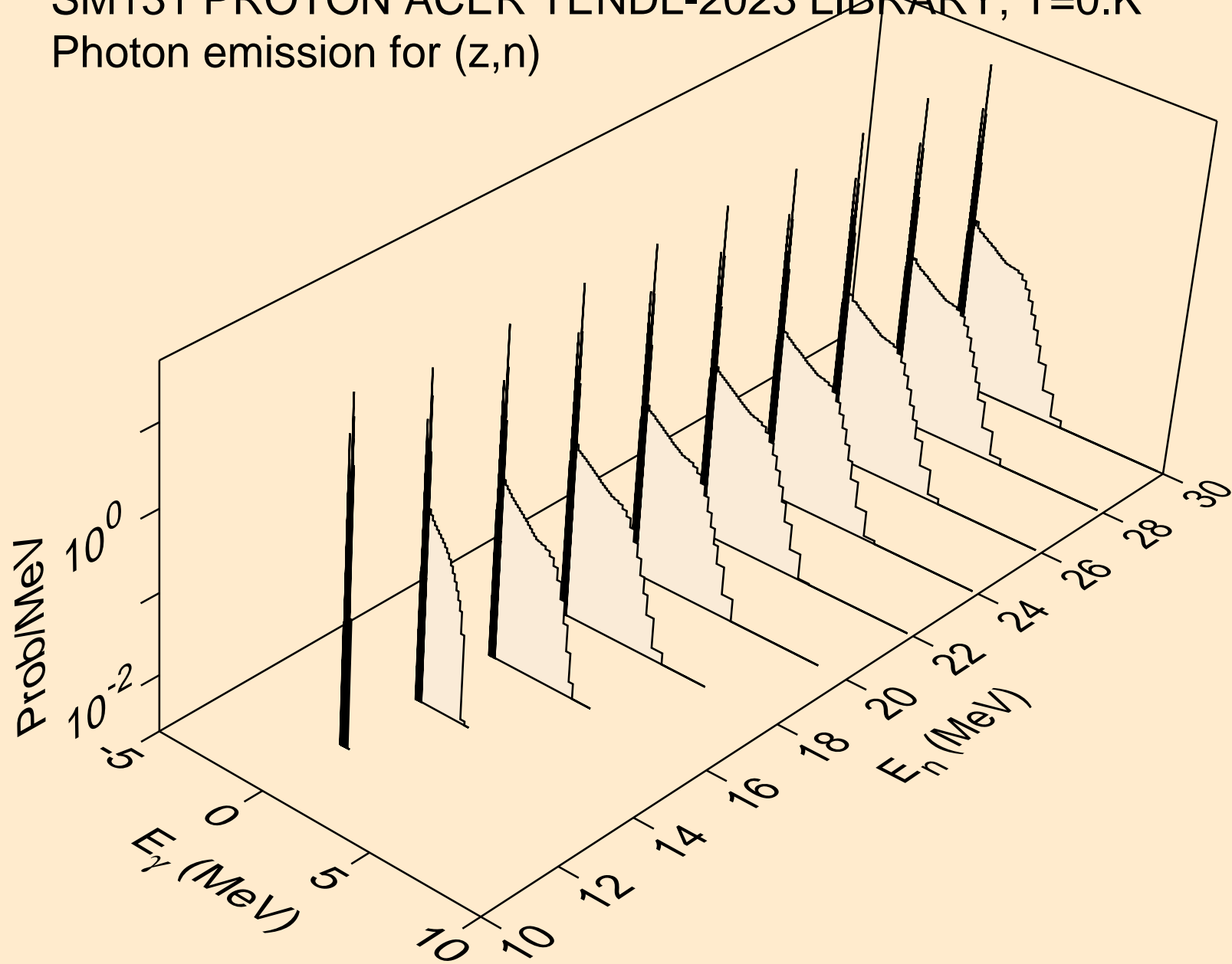

SM131 PROTON ACER TENDL-2023 LIBRARY; T=0.K  
Photon emission for (z,x)

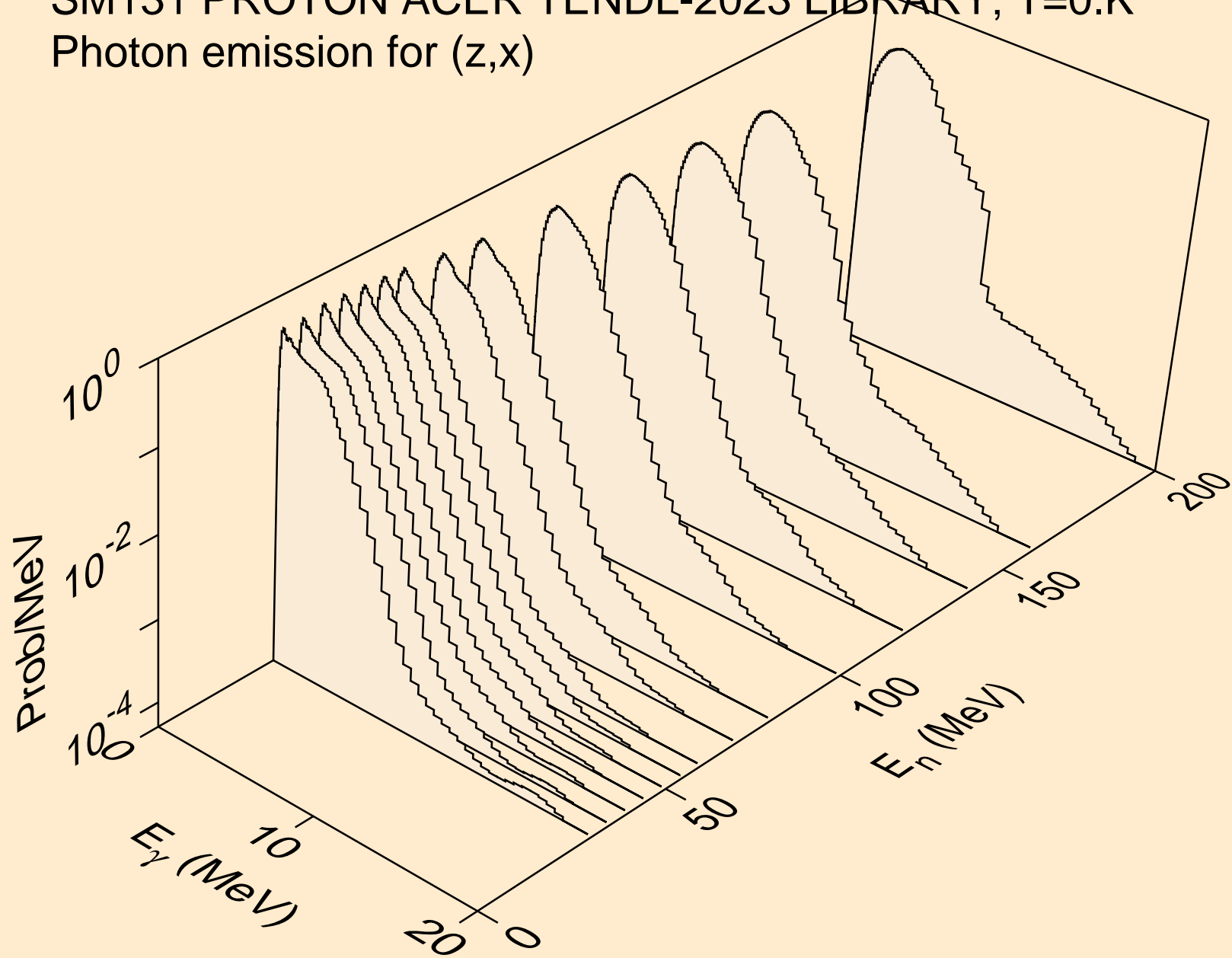

SM131 PROTON ACER TENDL-2023 LIBRARY; T=0.K  
Photon emission for (n,2n)

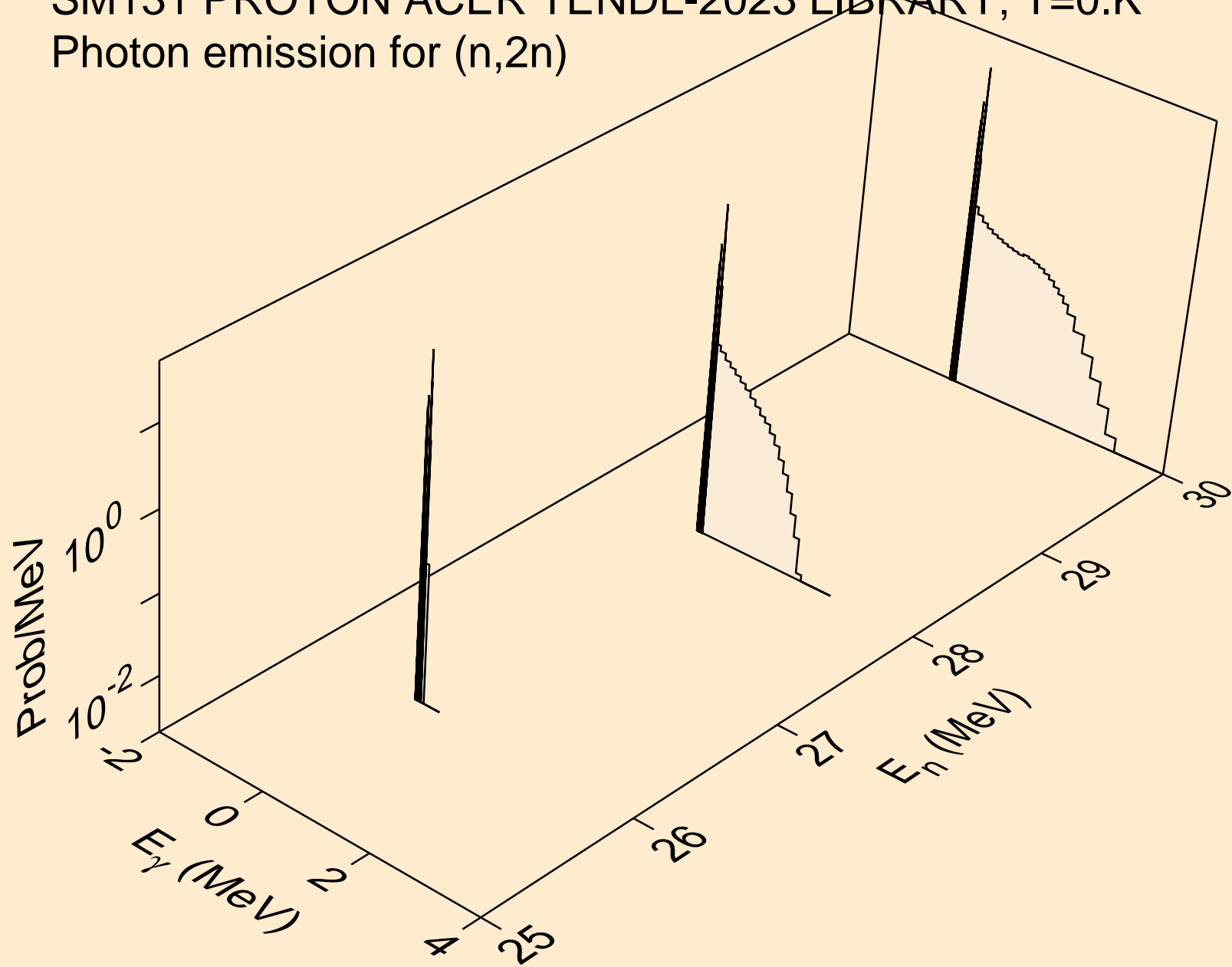

SM131 PROTON ACER TENDL-2023 LIBRARY; T=0.K  
Photon emission for (n,n\*)a

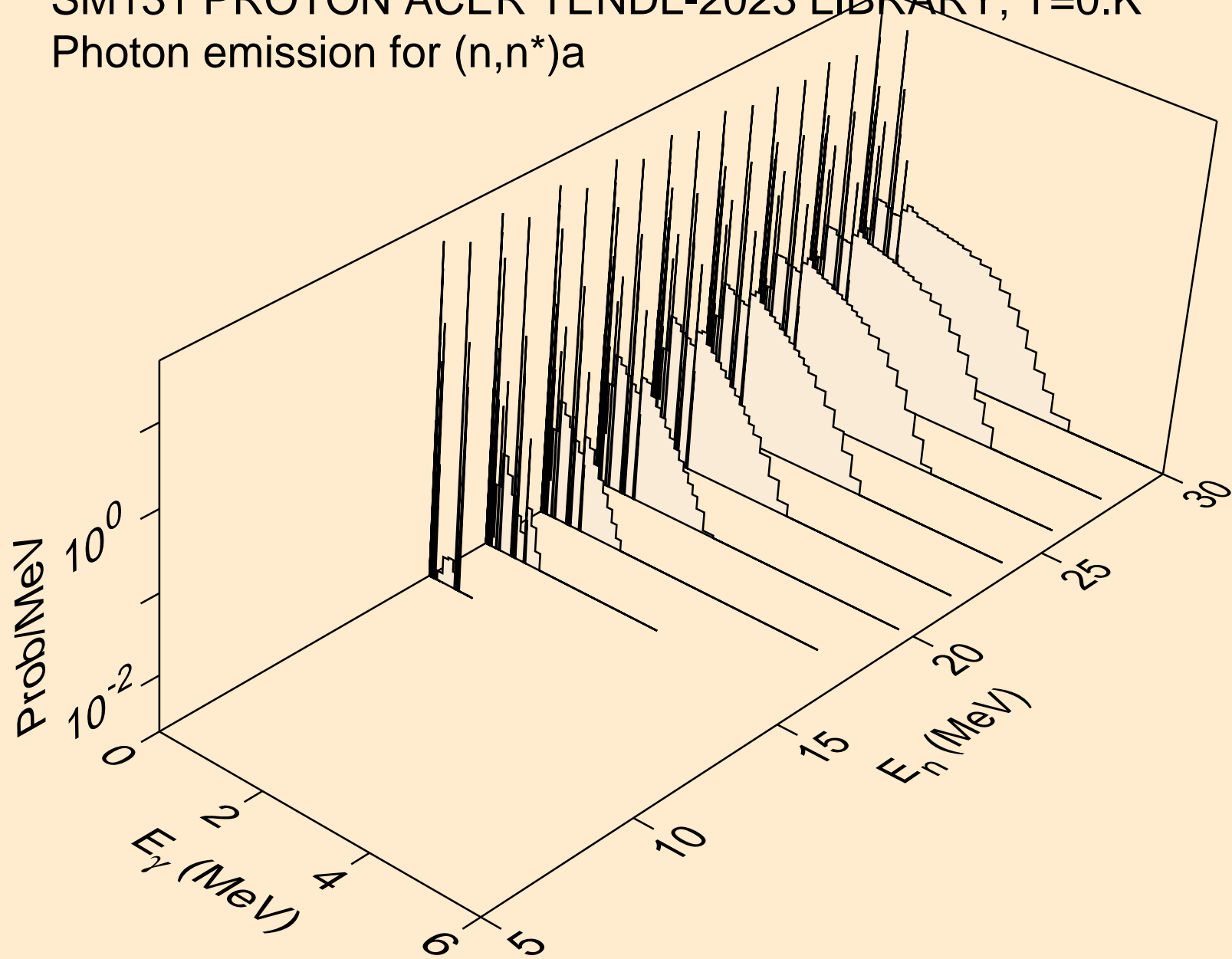

SM131 PROTON ACER TENDL-2023 LIBRARY; T=0.K  
Photon emission for (n,n\*)p

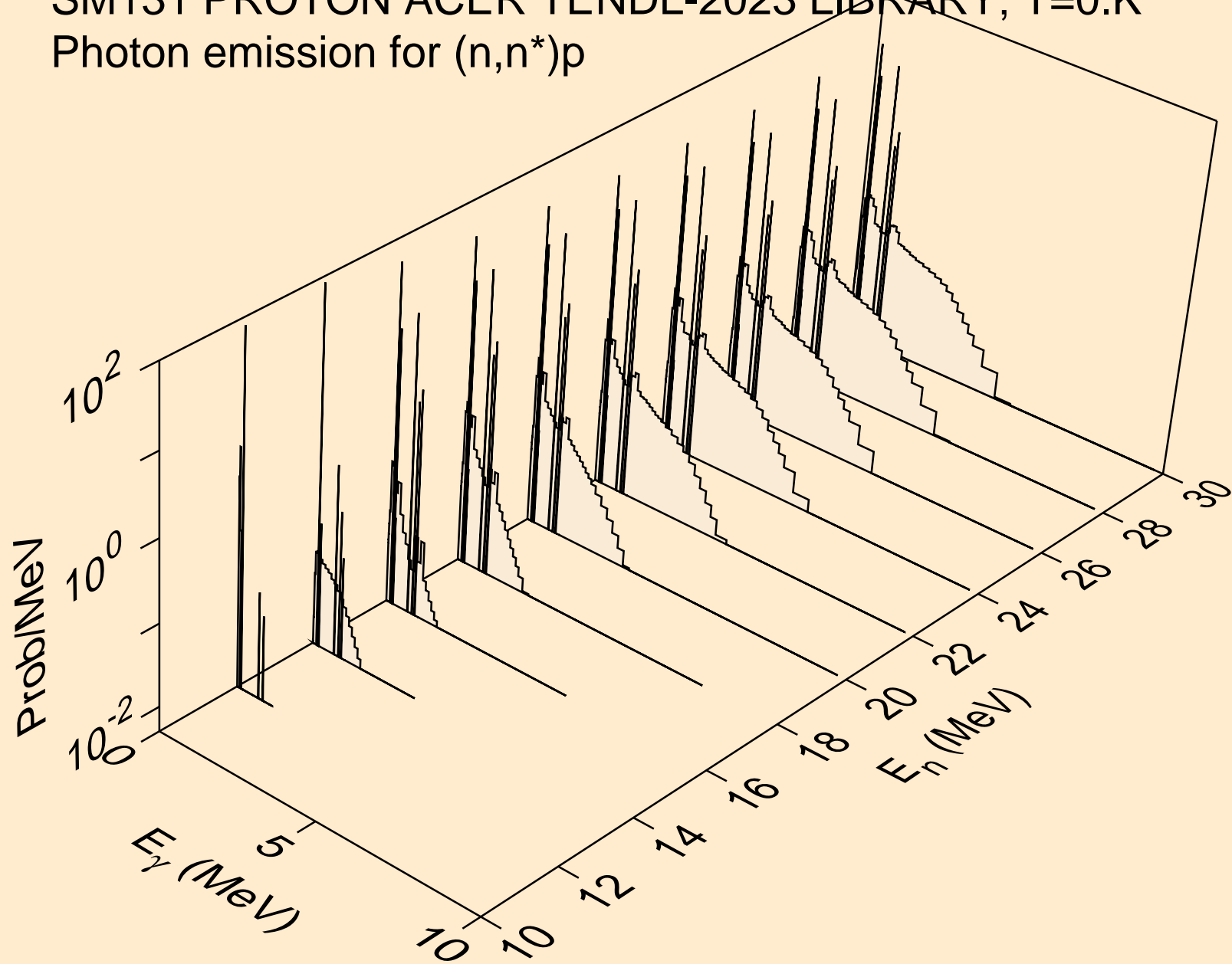



SM131 PROTON ACER TENDL-2023 LIBRARY; T=0.K  
Photon emission for (n,n\*)d

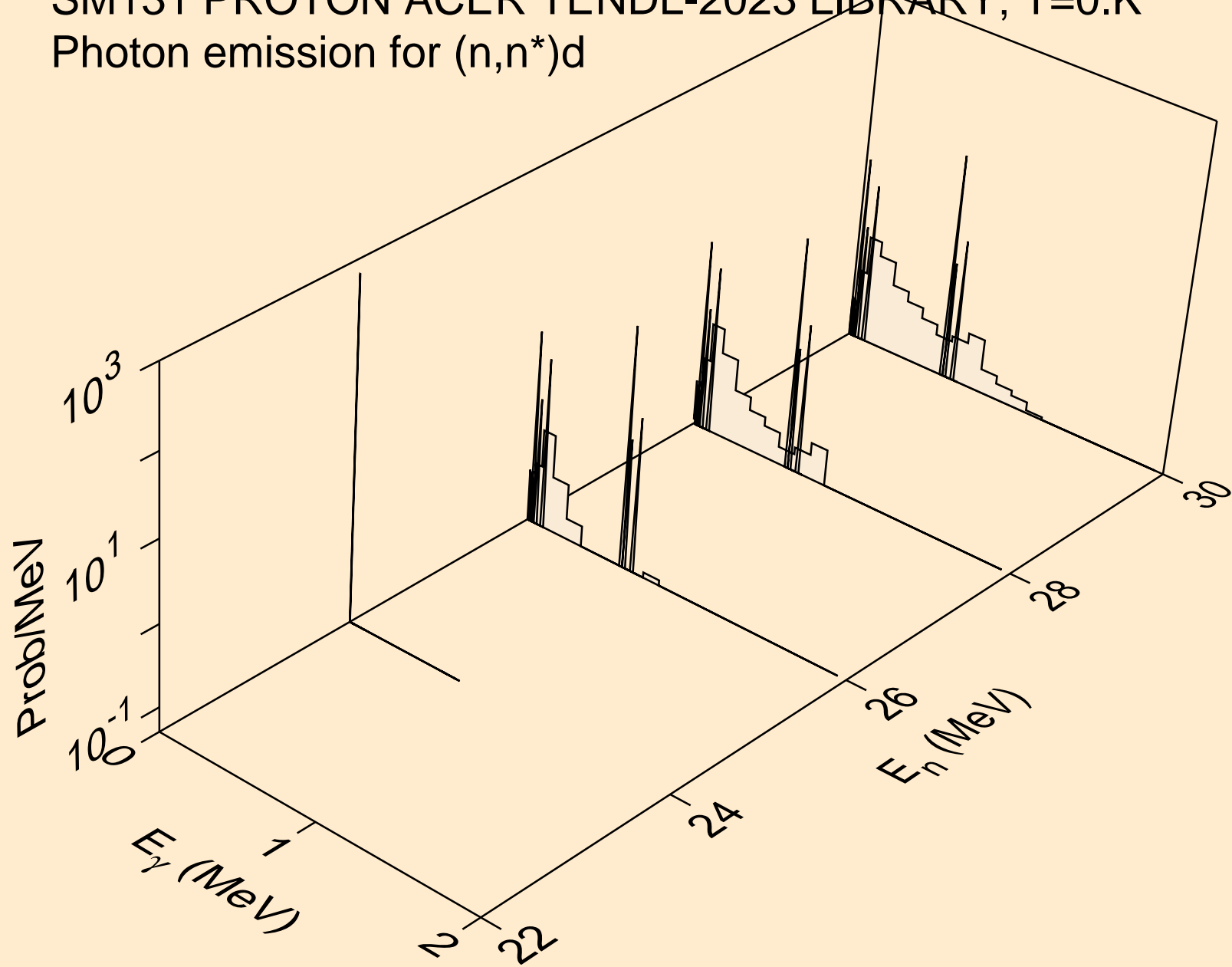

SM131 PROTON ACER TENDL-2023 LIBRARY; T=0.K  
Photon emission for (n,2np)

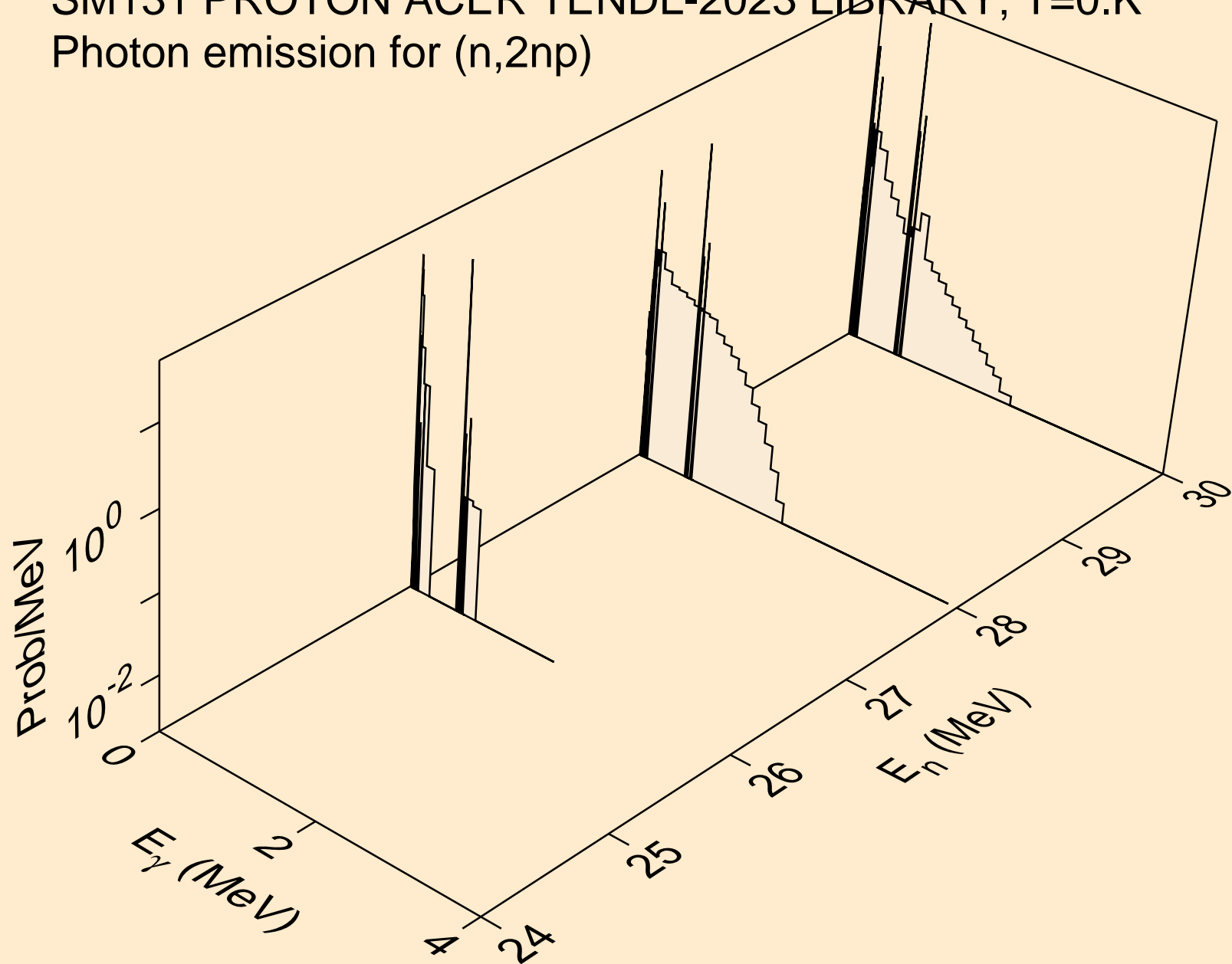

SM131 PROTON ACER TENDL-2023 LIBRARY; T=0.K  
Photon emission for (n,n2p)

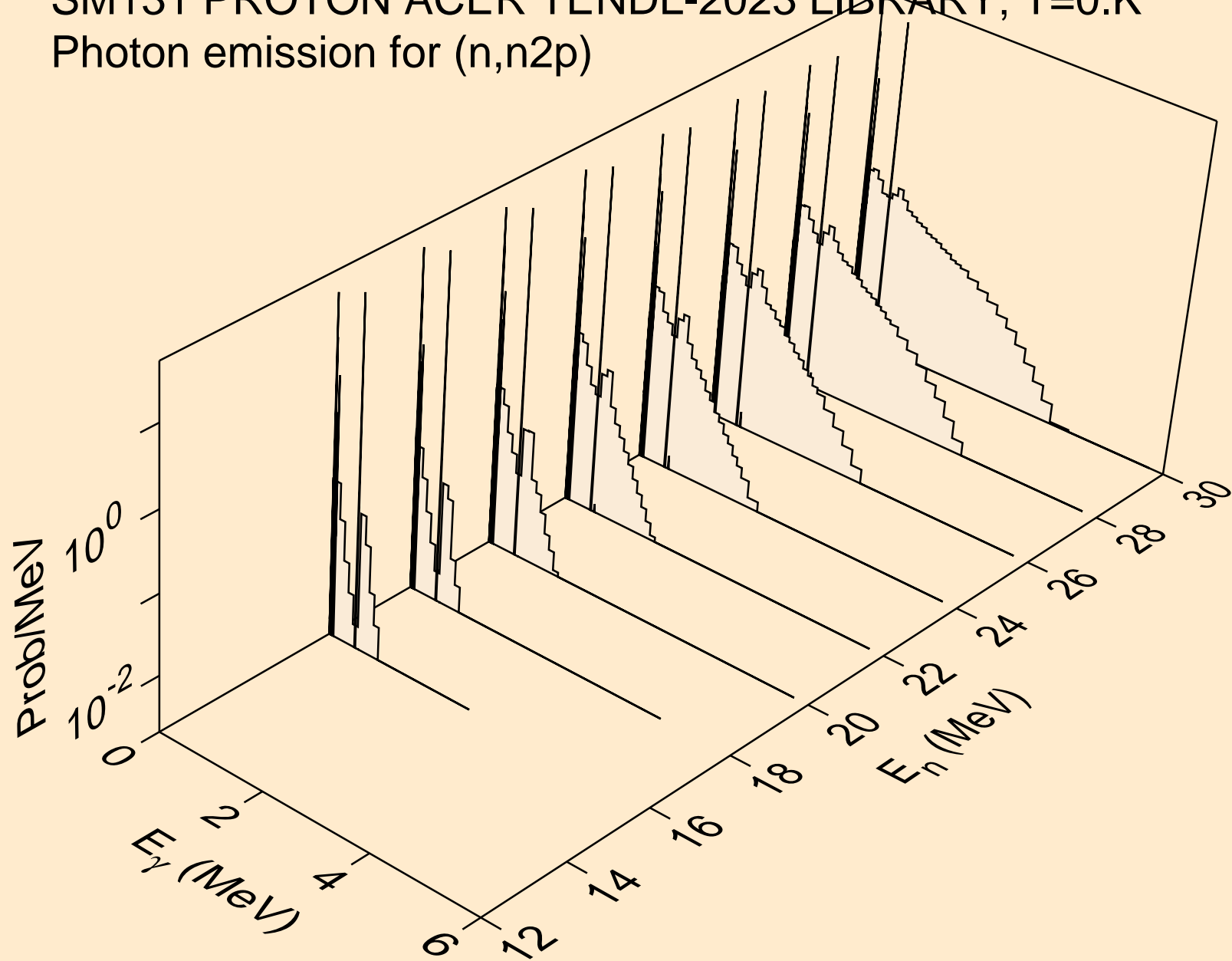

SM131 PROTON ACER TENDL-2023 LIBRARY; T=0.K  
Photon emission for (n,npa)

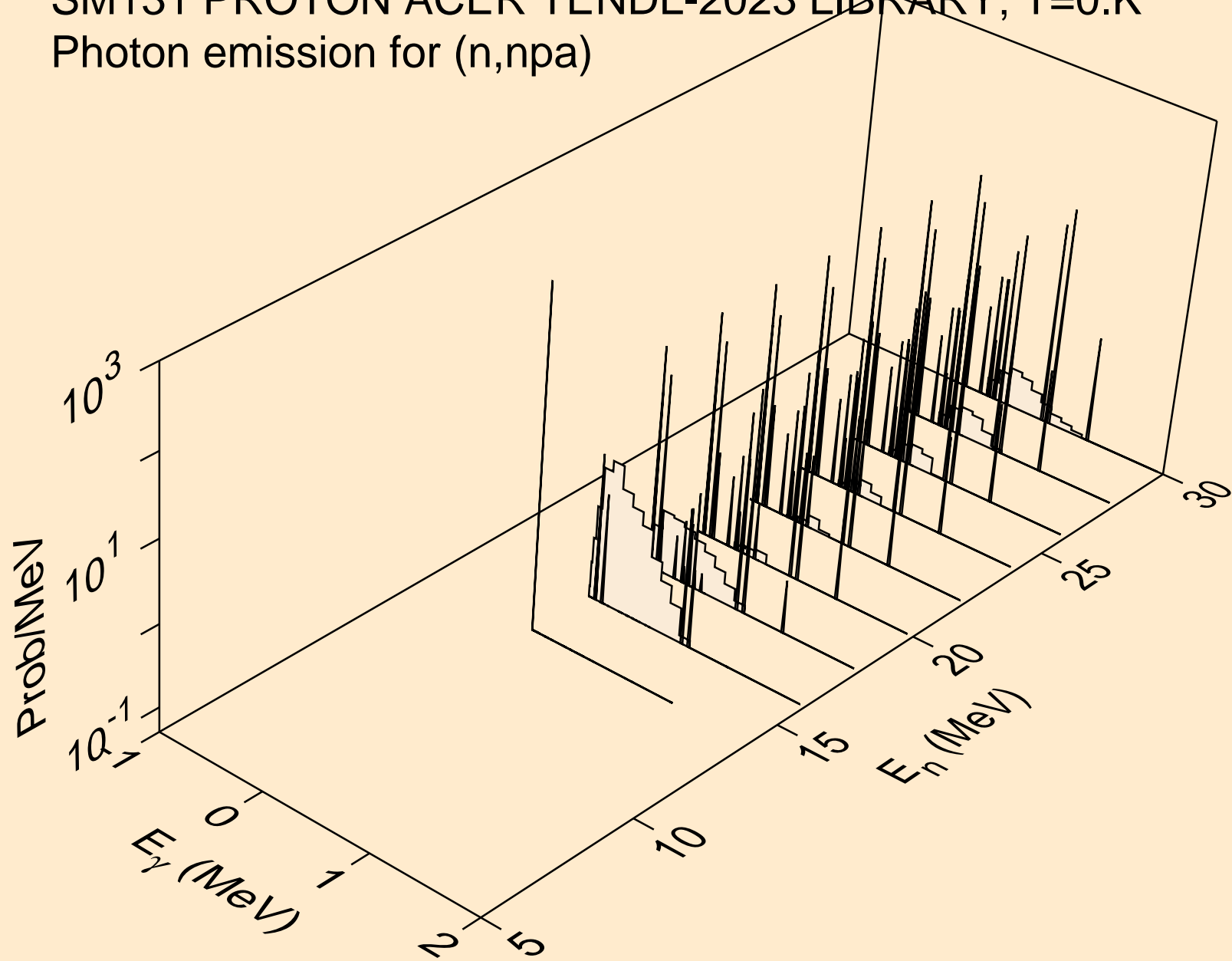

SM131 PROTON ACER TENDL-2023 LIBRARY; T=0.K  
Photon emission for (n,gma)

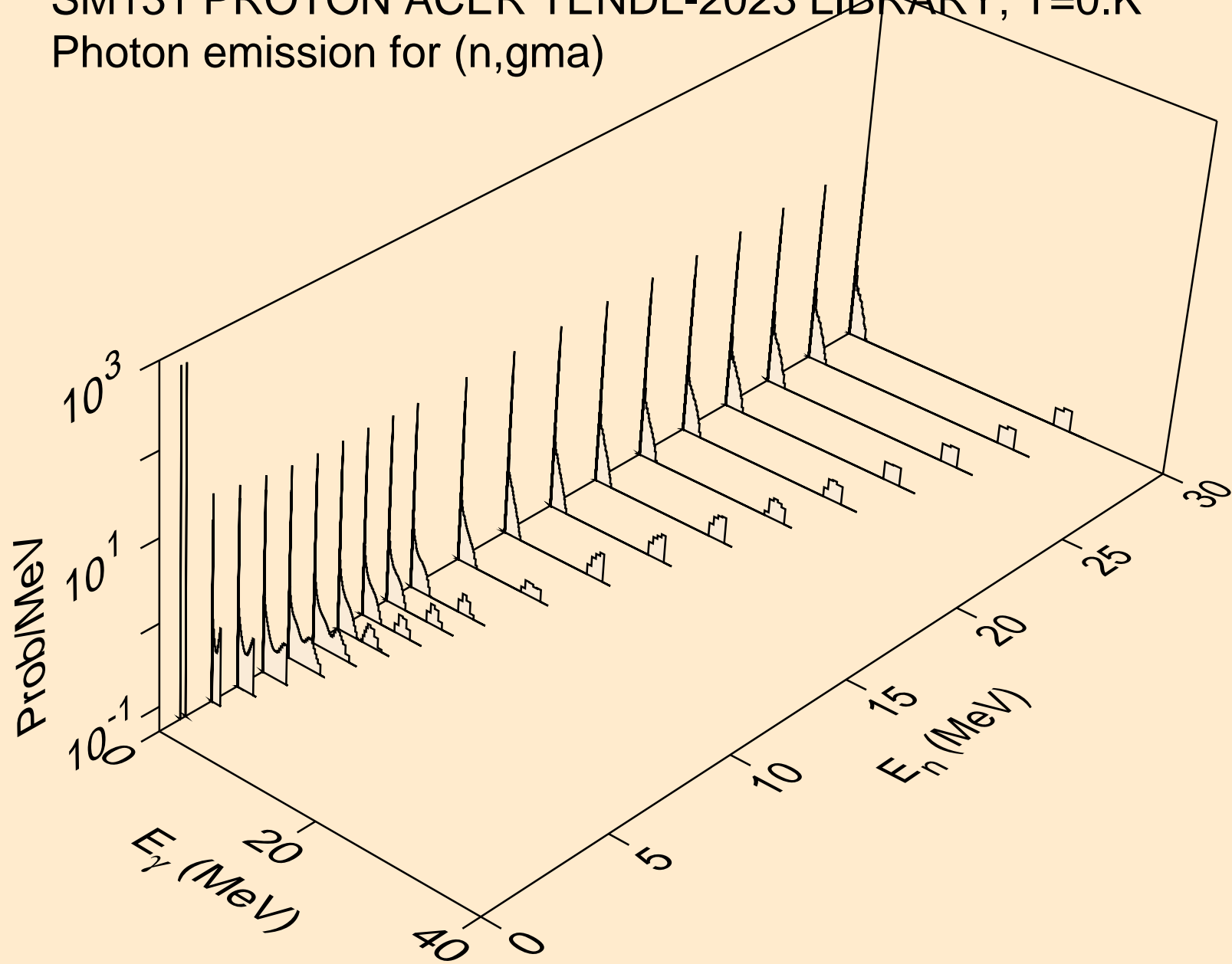

SM131 PROTON ACER TENDL-2023 LIBRARY; T=0.K  
Photon emission for inelastic

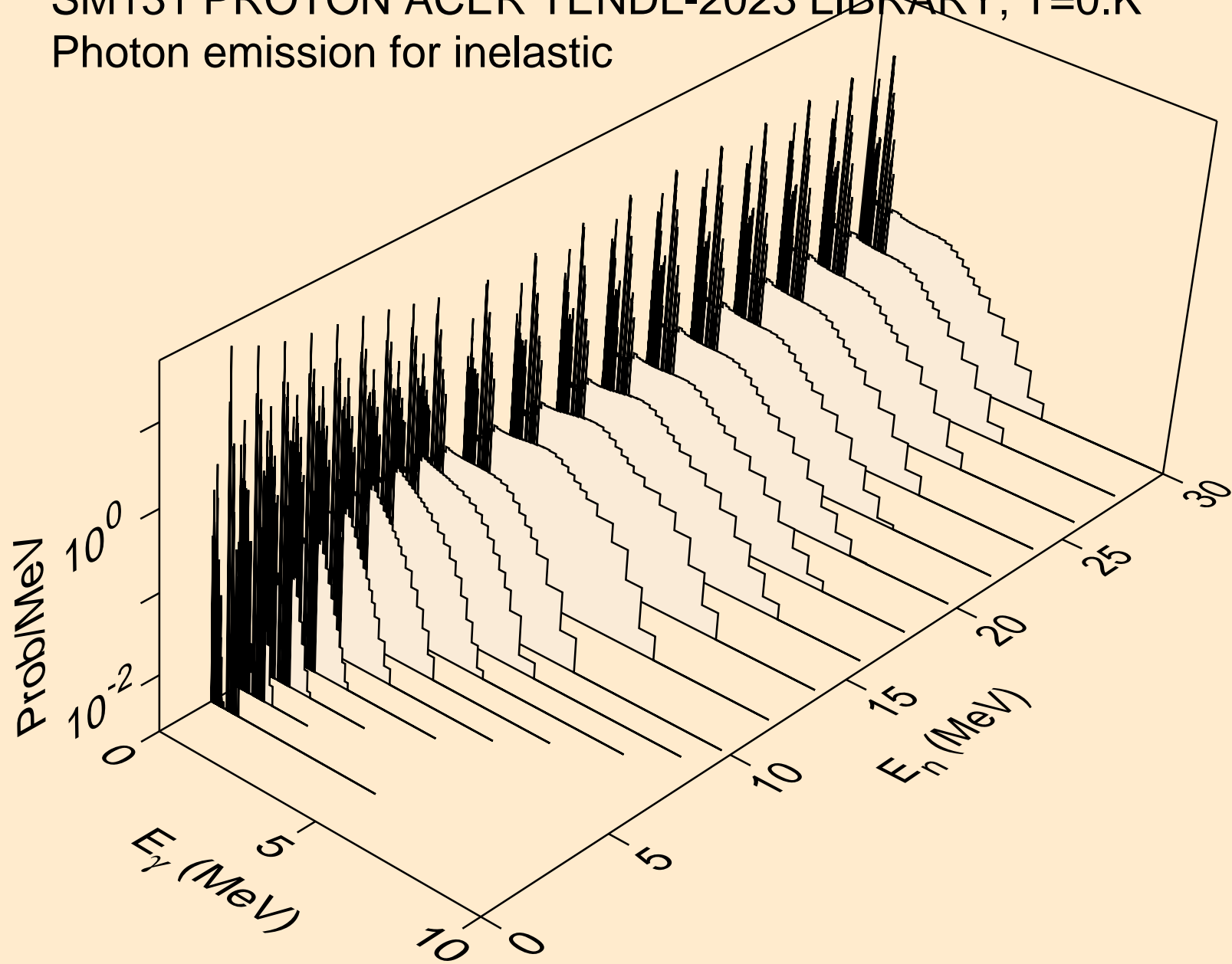

SM131 PROTON ACER TENDL-2023 LIBRARY; T=0.K  
Photon emission for (n,d)

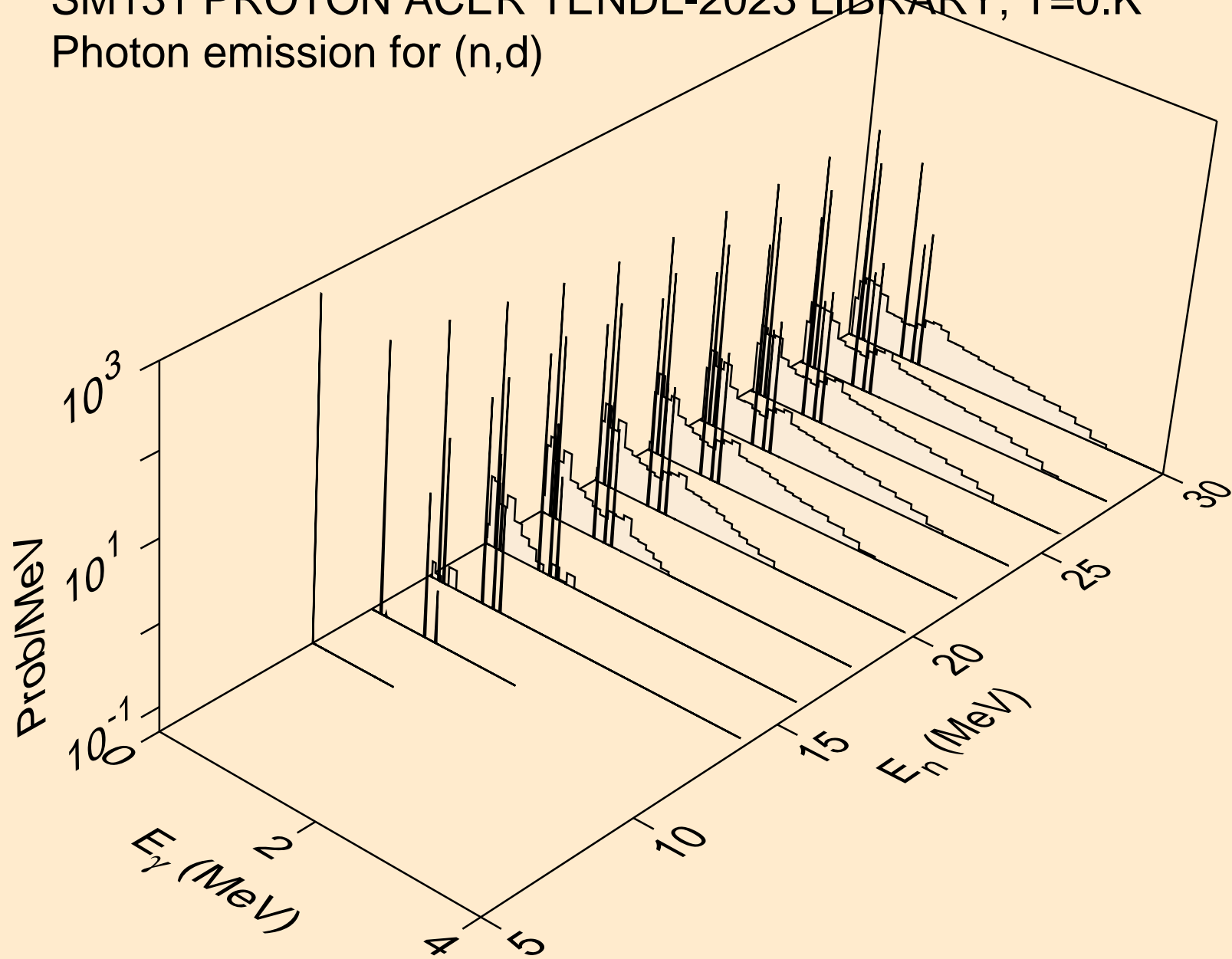

SM131 PROTON ACER TENDL-2023 LIBRARY; T=0.K  
Photon emission for (n,t)

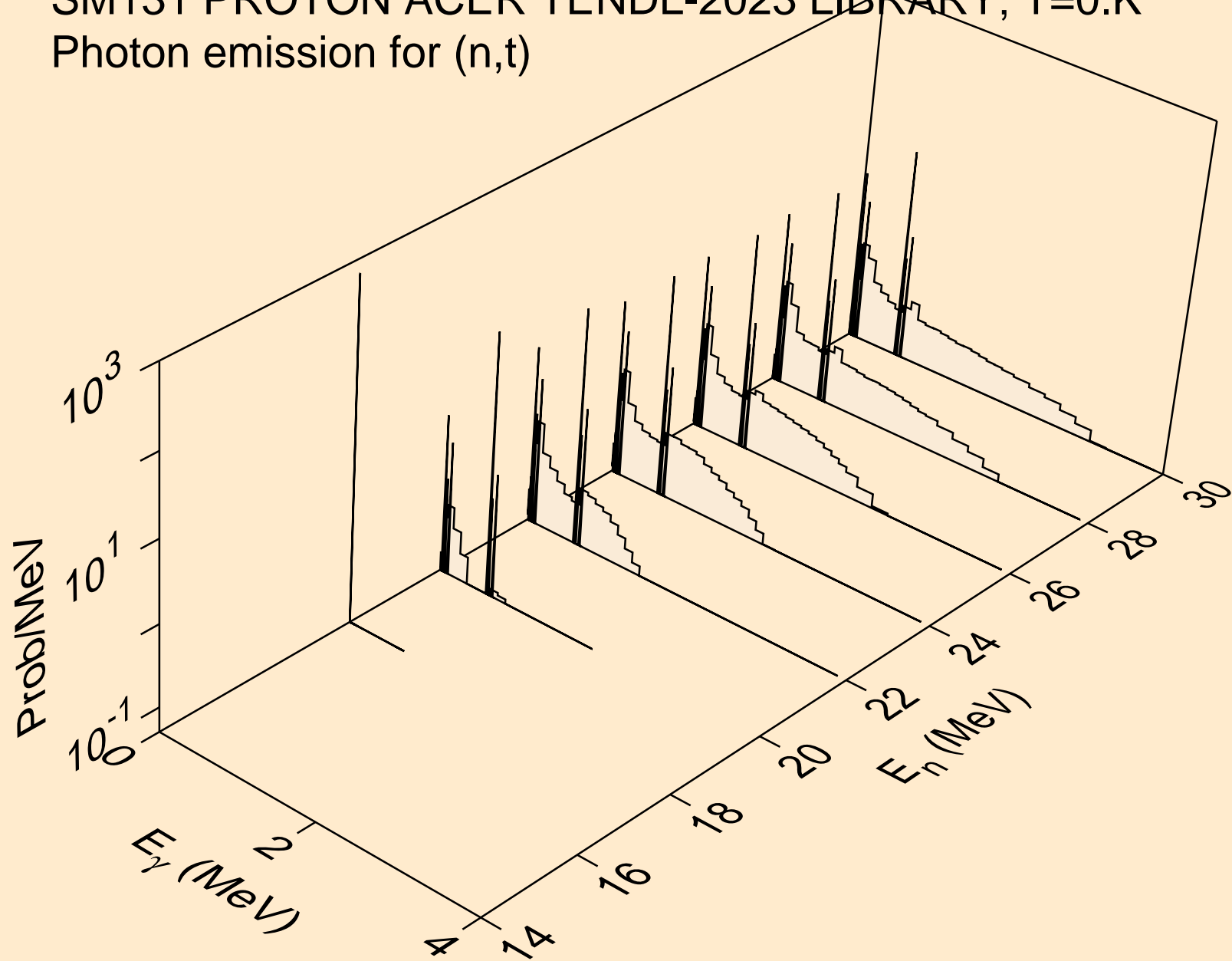



SM131 PROTON ACER TENDL-2023 LIBRARY; T=0.K  
Photon emission for (n,he3)

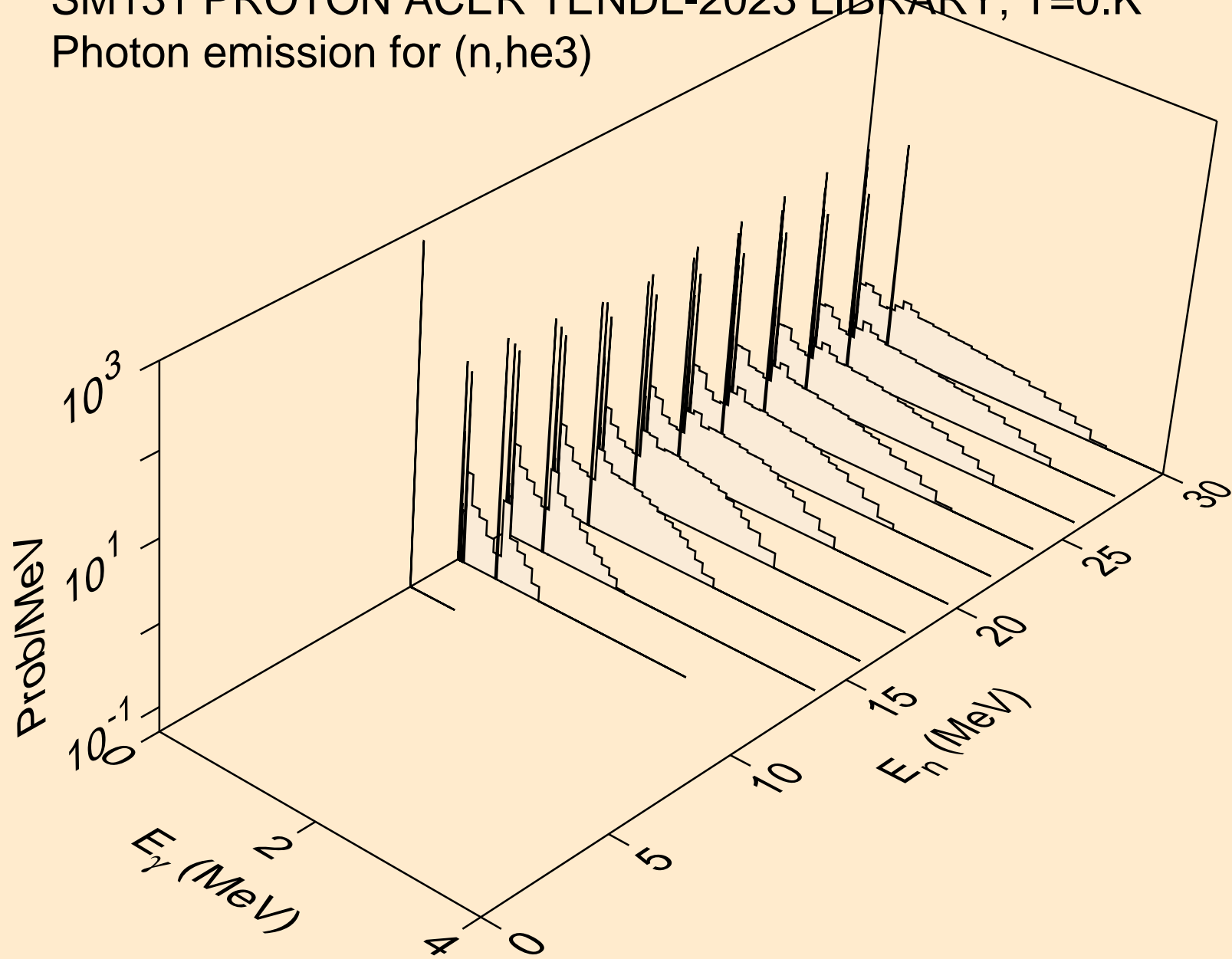

SM131 PROTON ACER TENDL-2023 LIBRARY; T=0.K  
Photon emission for (n,a)

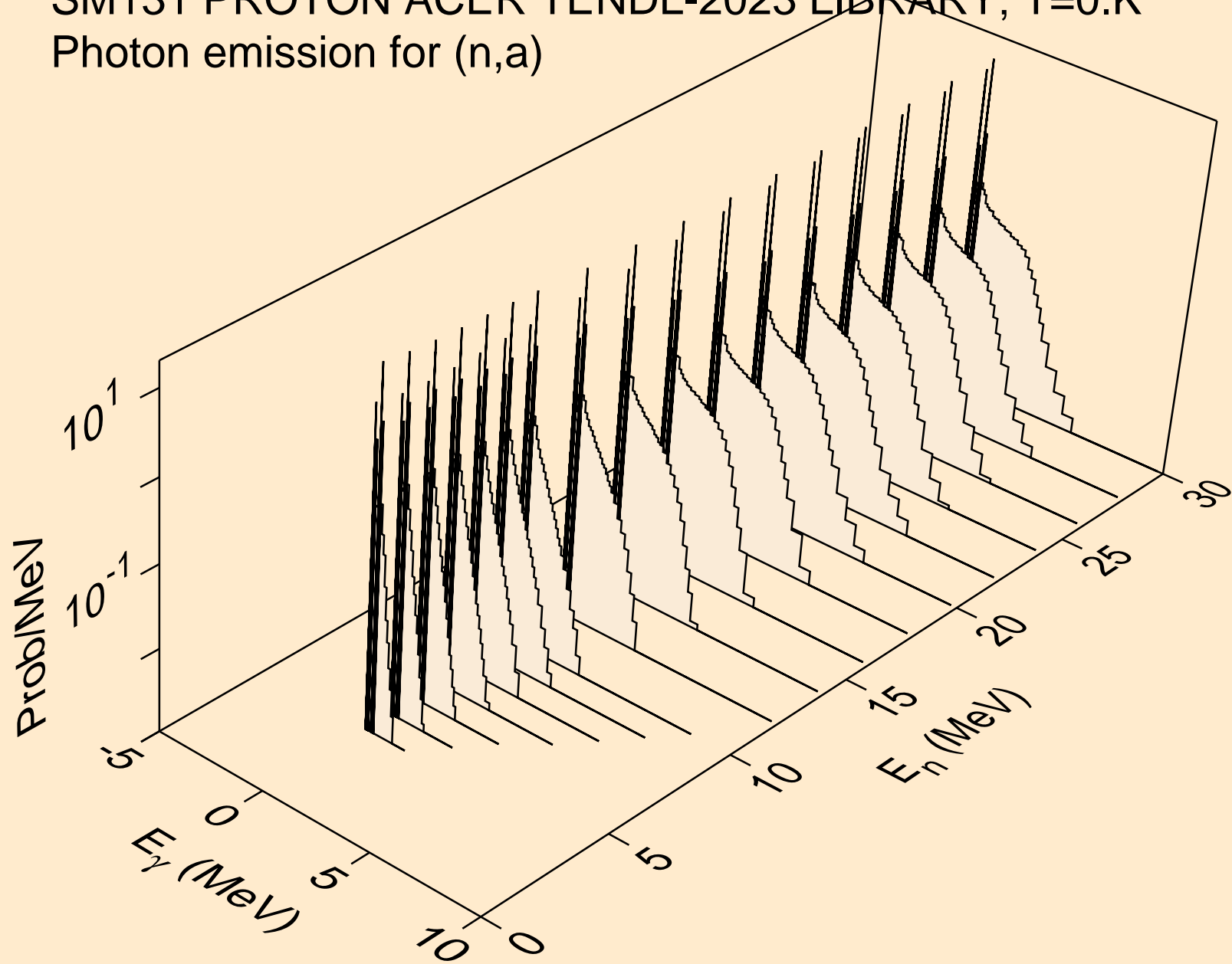

SM131 PROTON ACER TENDL-2023 LIBRARY; T=0.K  
Photon emission for (n,2a)

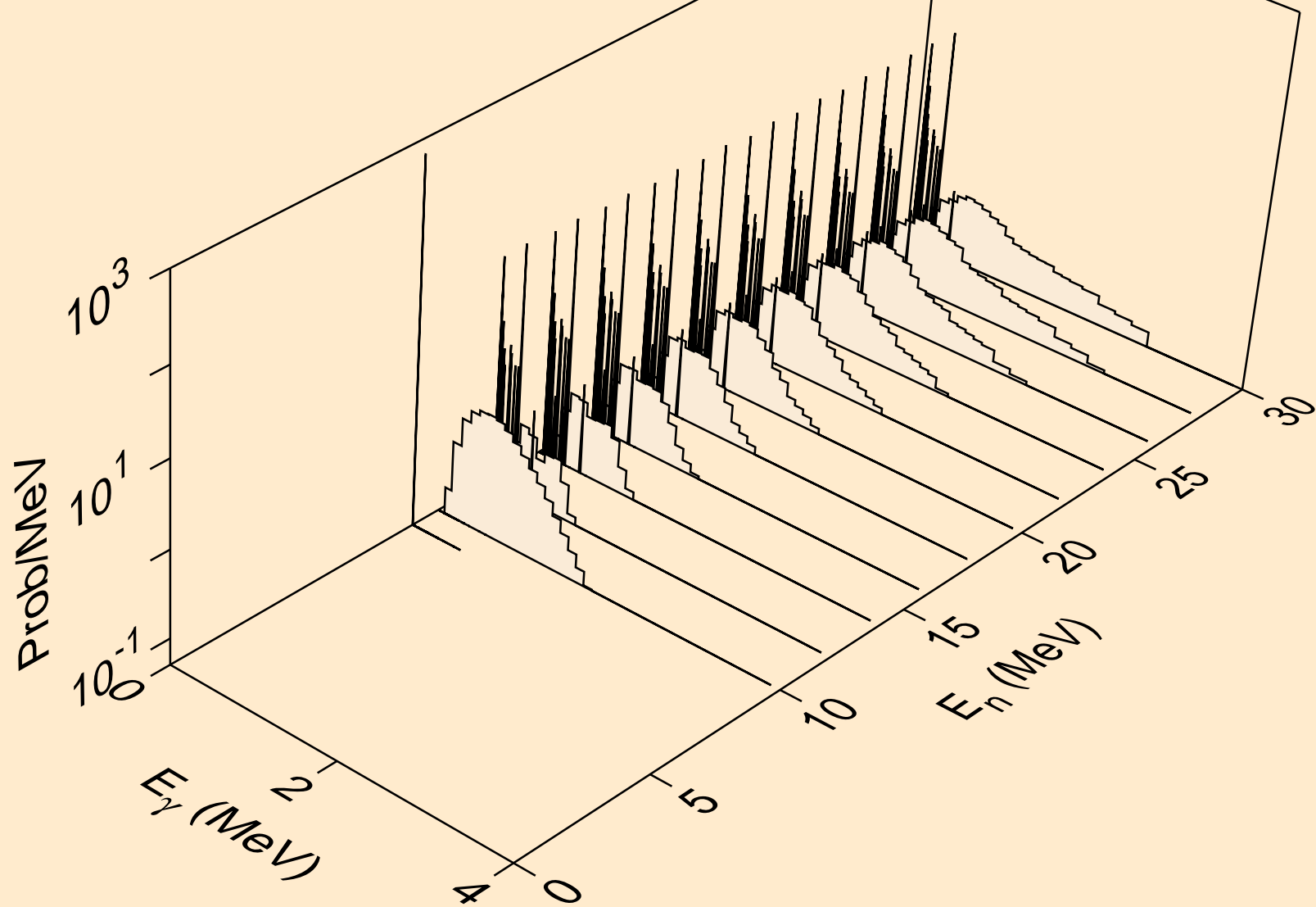

SM131 PROTON ACER TENDL-2023 LIBRARY; T=0.K  
Photon emission for (n,2p)

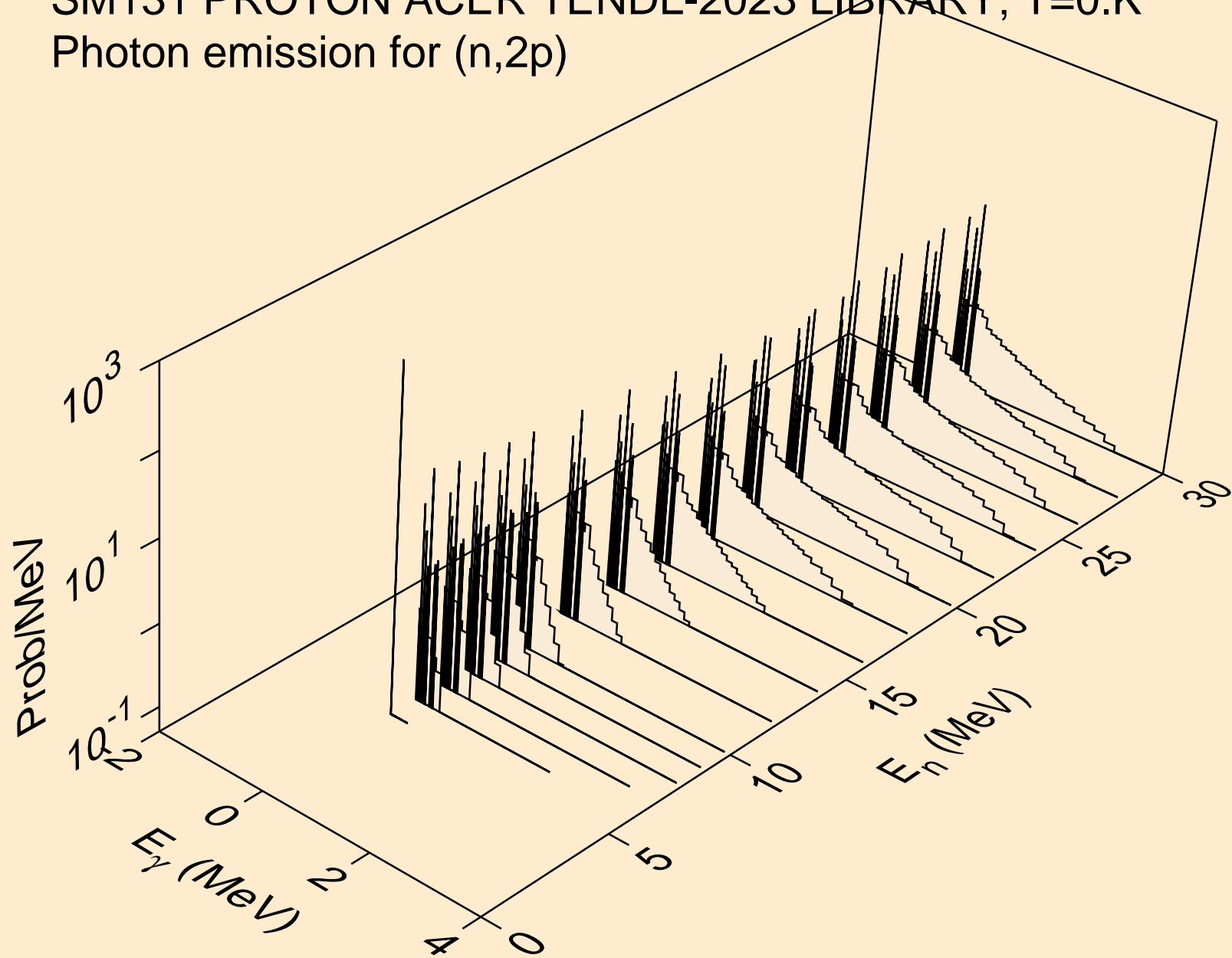

SM131 PROTON ACER TENDL-2023 LIBRARY; T=0.K  
Photon emission for (n,pa)

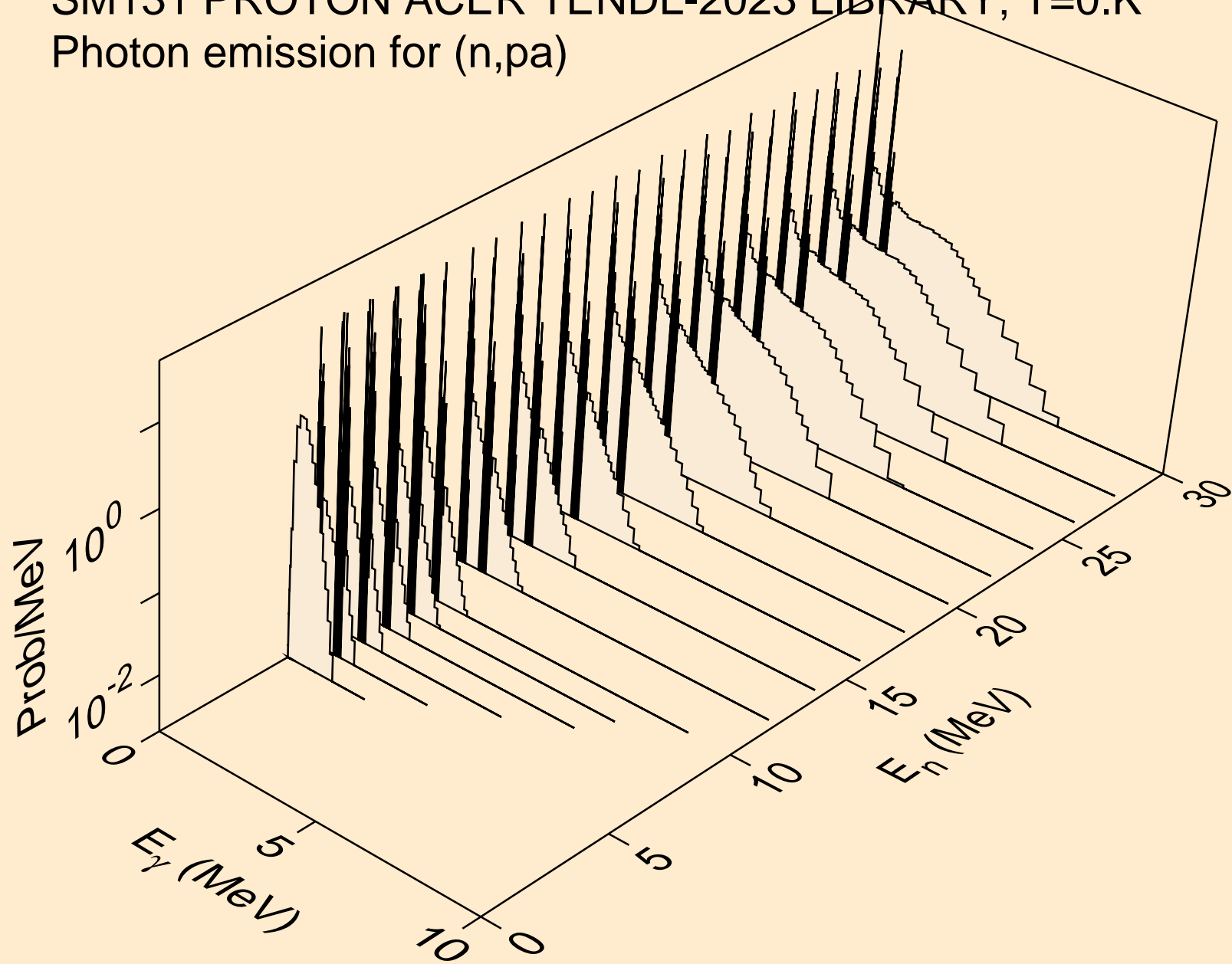

SM131 PROTON ACER TENDL-2023 LIBRARY; T=0.K  
Photon emission for (n,pd)

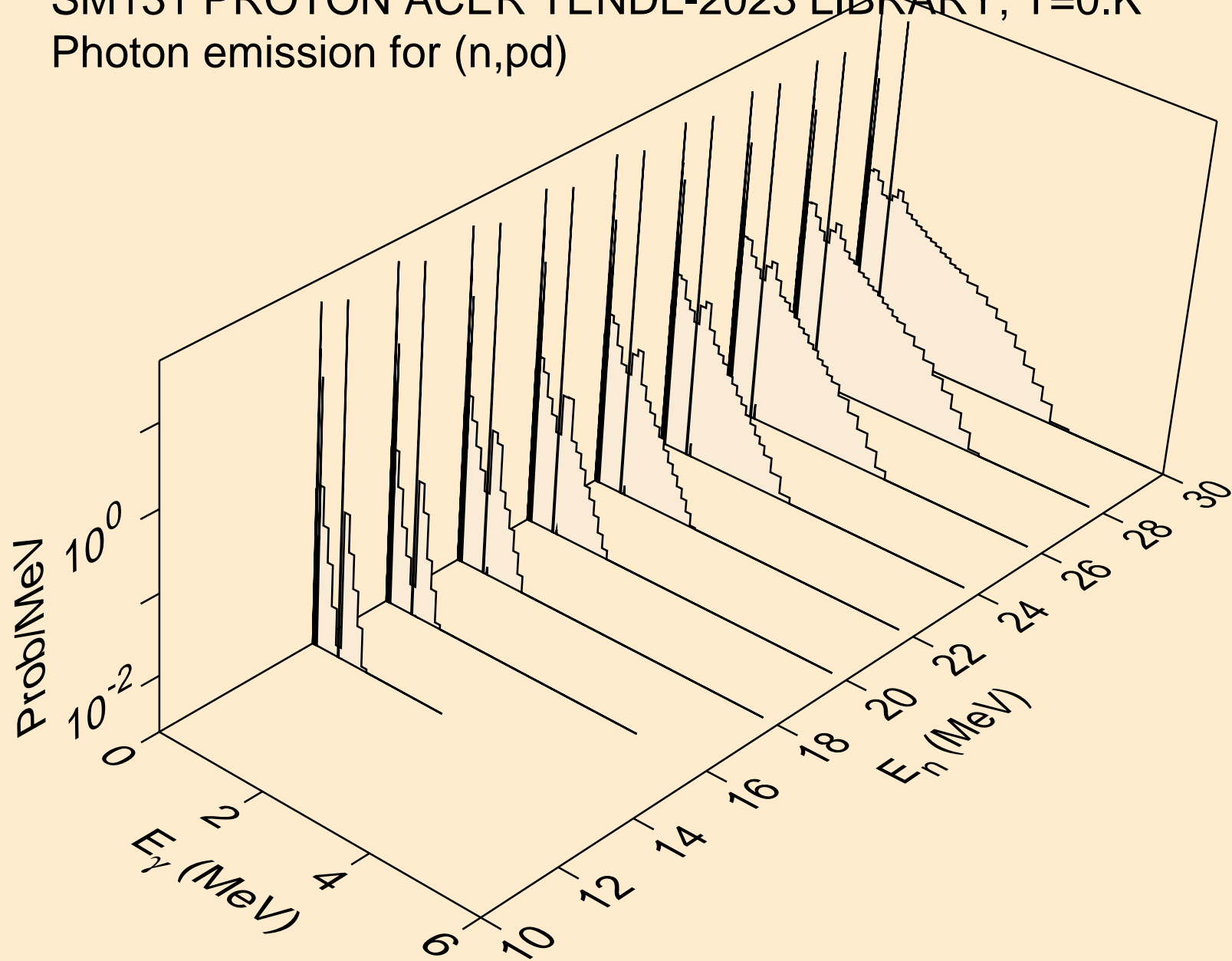

SM131 PROTON ACER TENDL-2023 LIBRARY; T=0.K  
Photon emission for (n,pt)

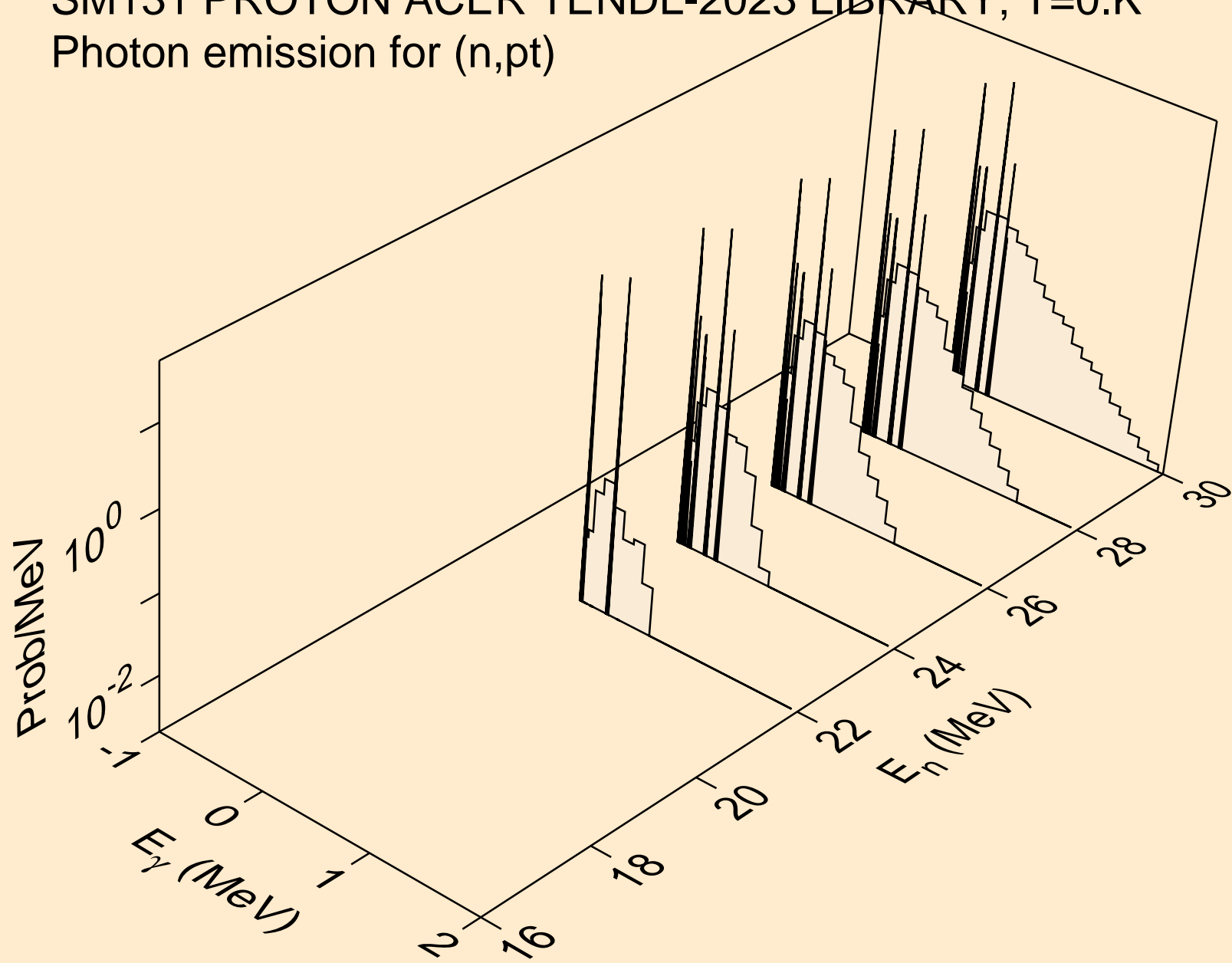

SM131 PROTON ACER TENDL-2023 LIBRARY; T=0.K  
Photon emission for (n,da)

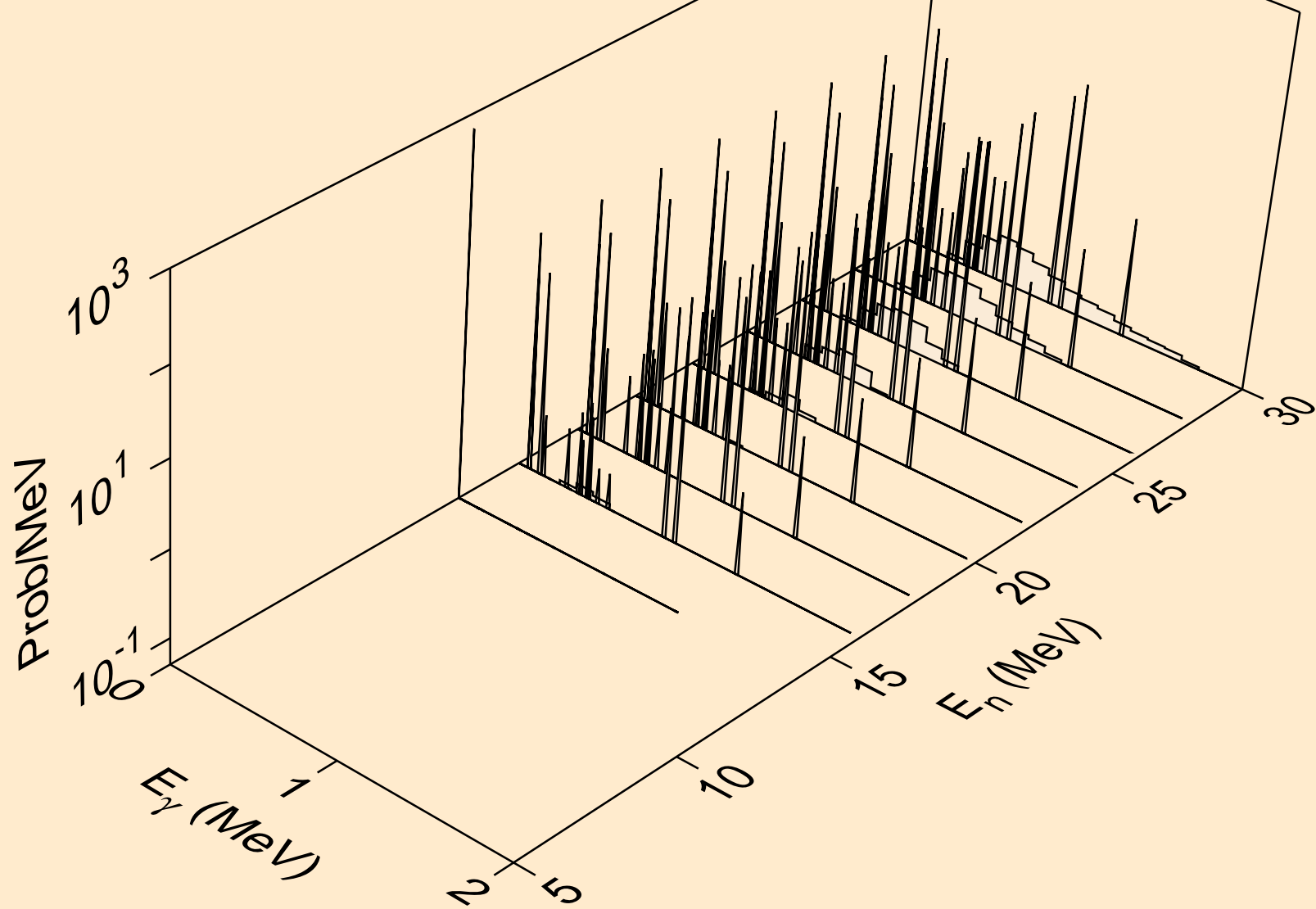



SM131 PROTON ACER TENDL-2023 LIBRARY; T=0.K  
Particle heating contributions

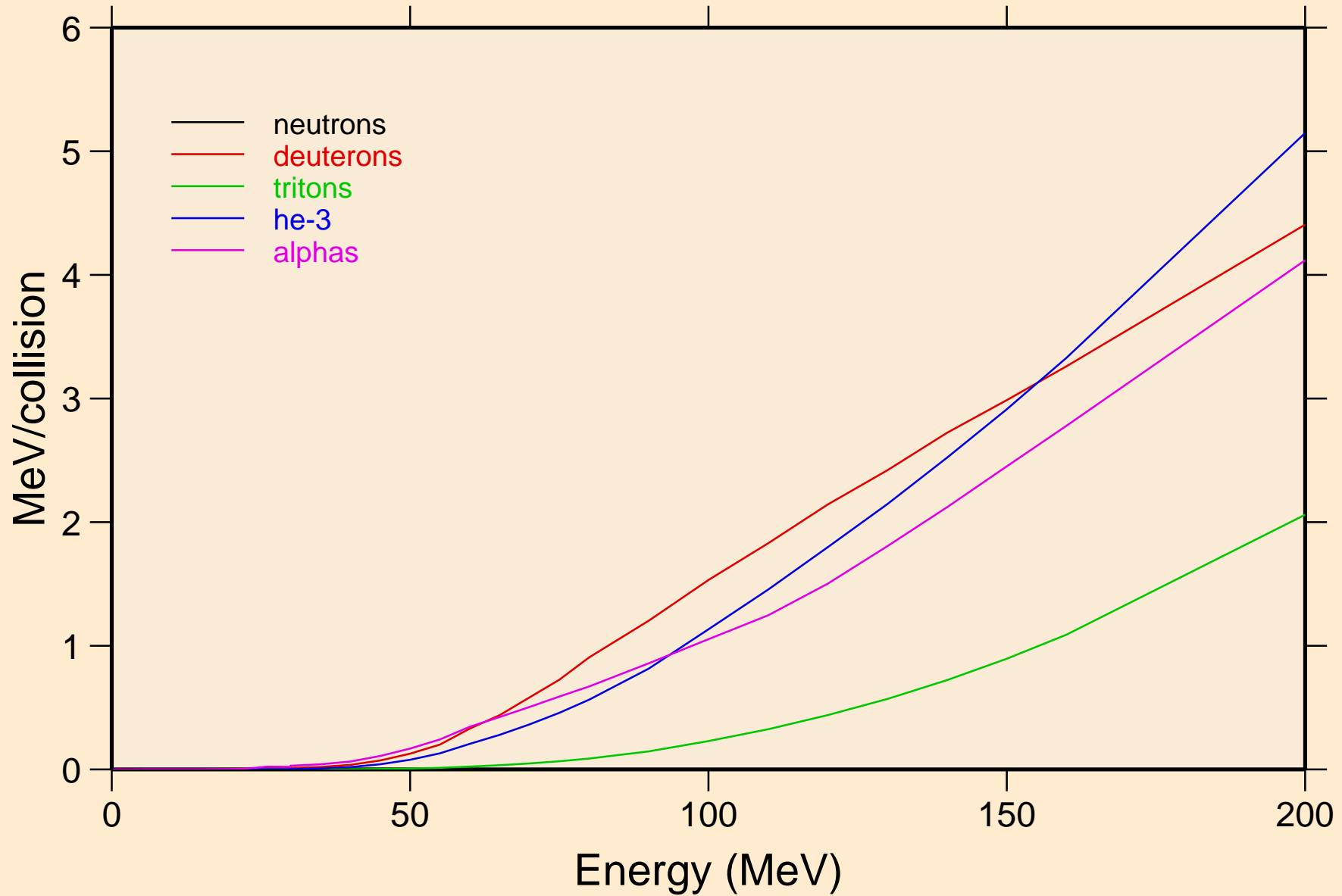

SM131 PROTON ACER TENDL-2023 LIBRARY; T=0.K  
Recoil Heating

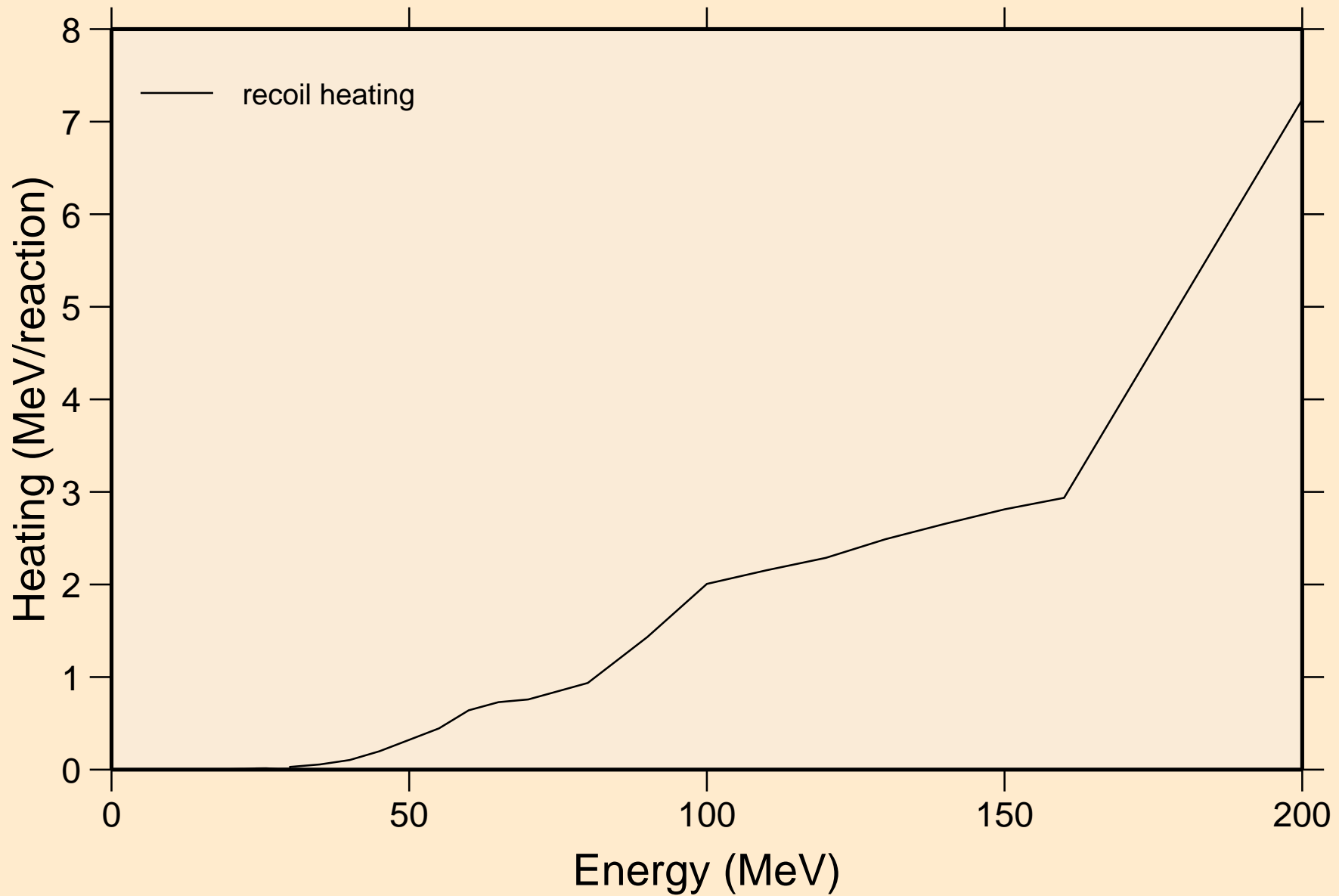

# SM131 PROTON ACER TENDL-2023 LIBRARY; T=0.K

## Particle production cross sections

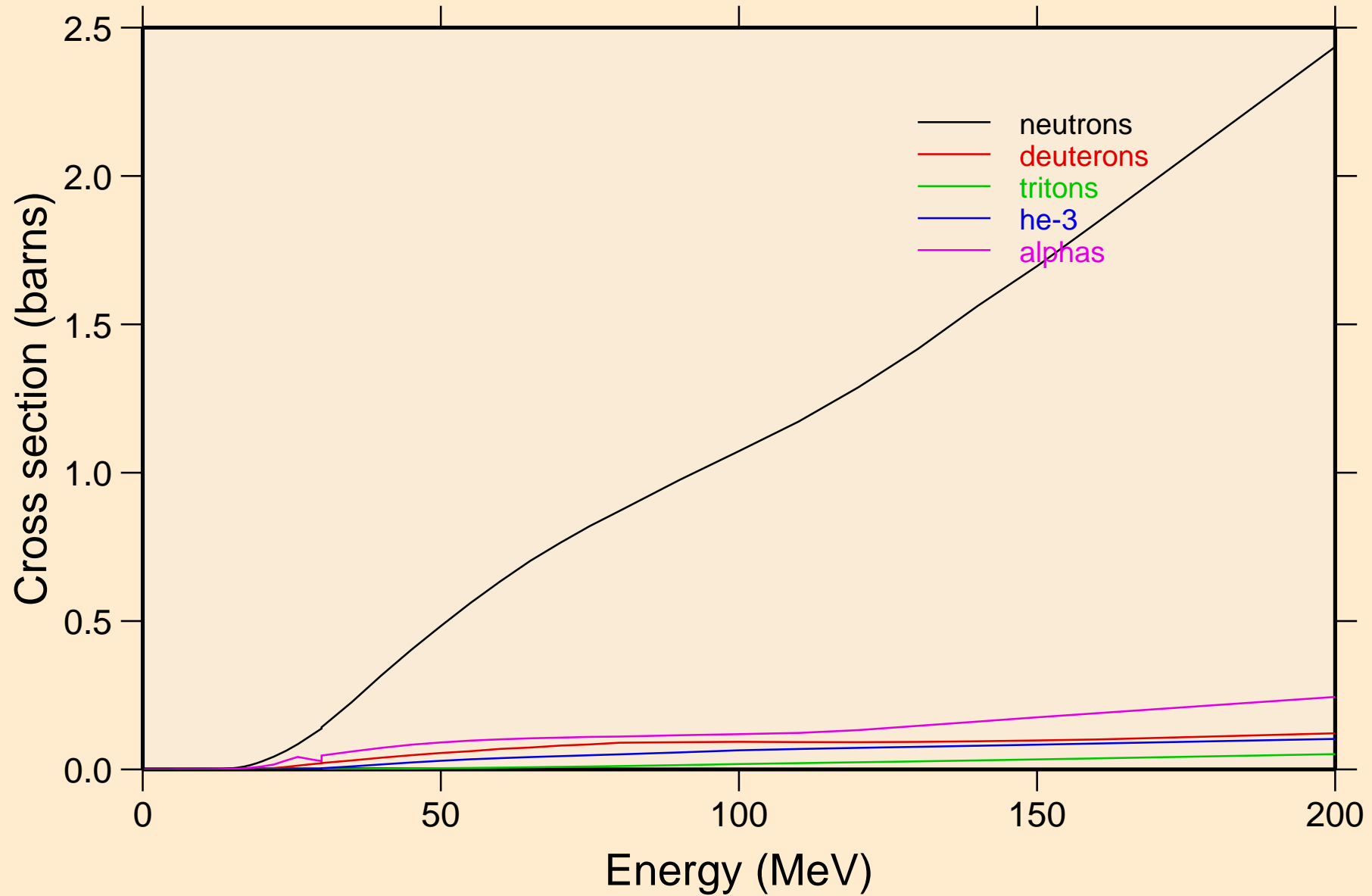

SM131 PROTON ACER TENDL-2023 LIBRARY; T=0.K  
neutrons from (p,n)

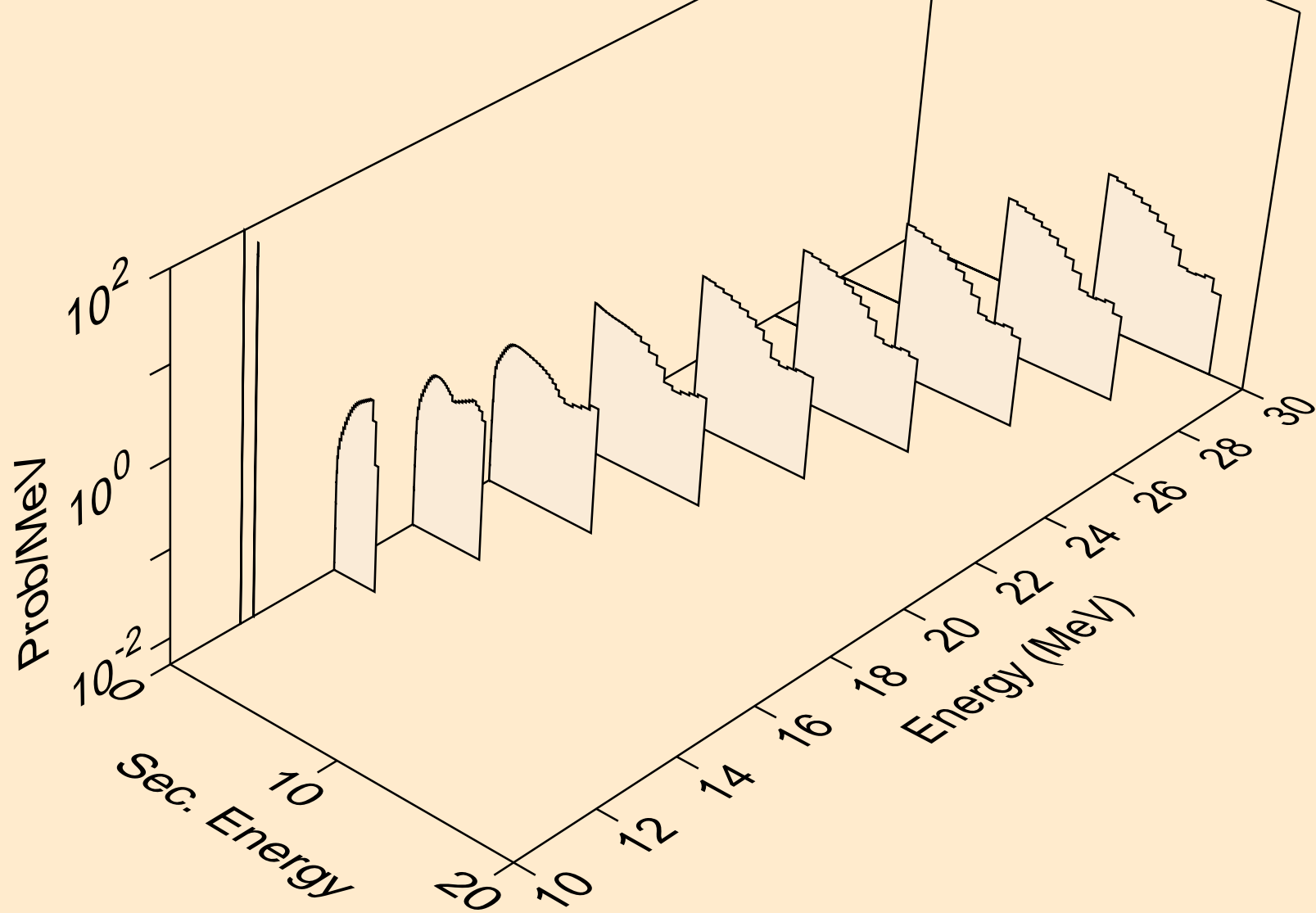

SM131 PROTON ACER TENDL-2023 LIBRARY; T=0.K  
neutrons from (p,x)

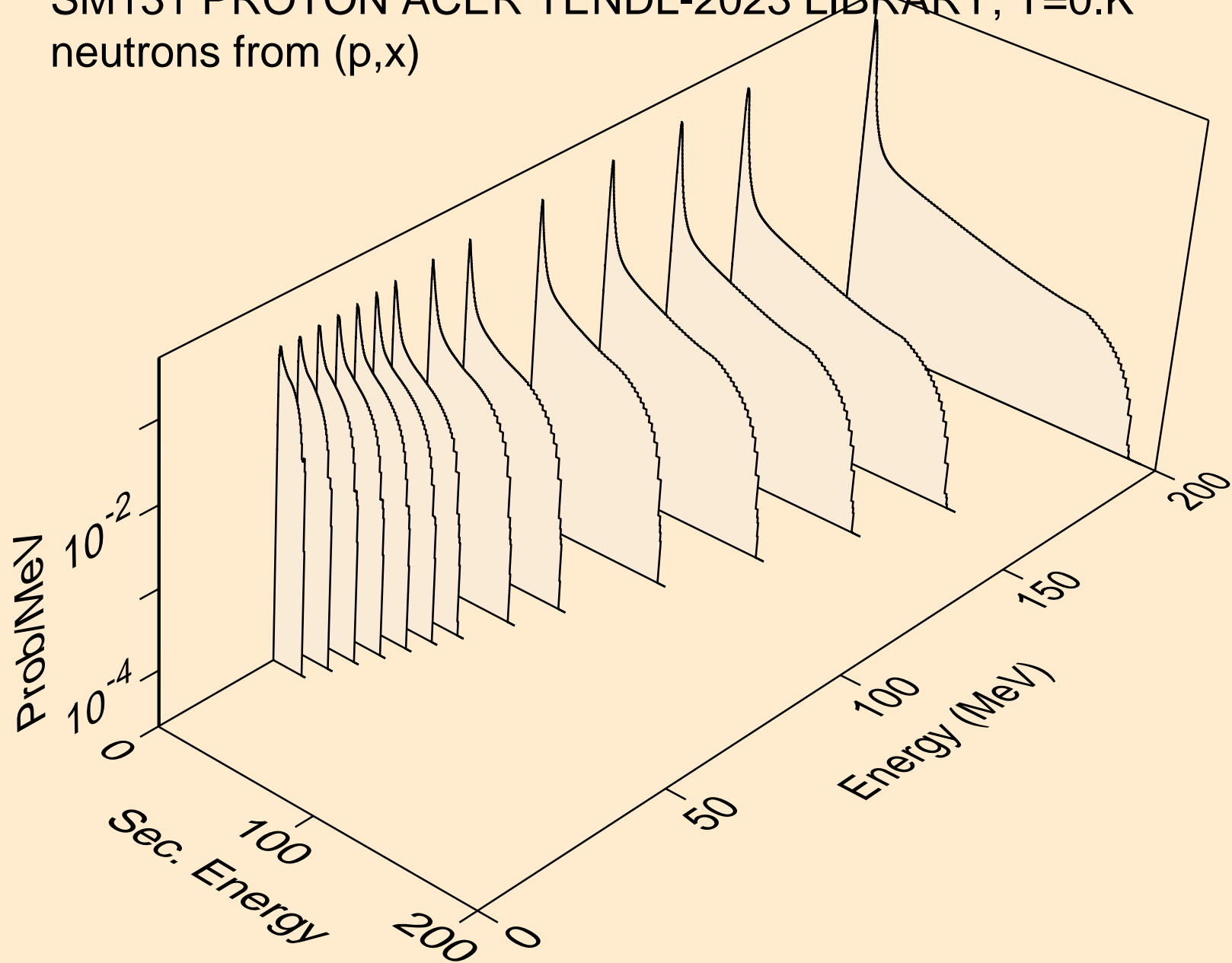

SM131 PROTON ACER TENDL-2023 LIBRARY; T=0.K  
neutrons from (p,2n)

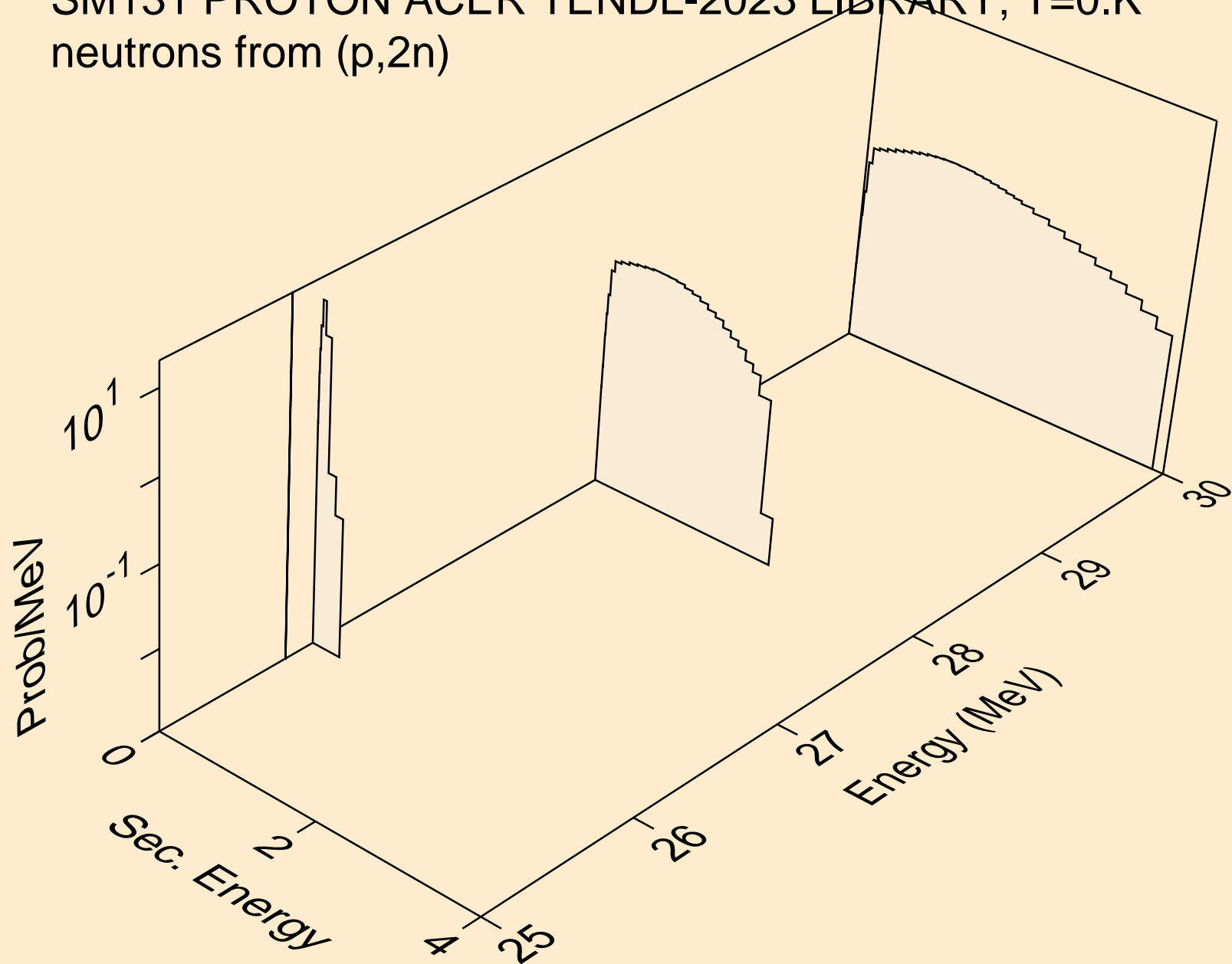

SM131 PROTON ACER TENDL-2023 LIBRARY; T=0.K  
neutrons from (p,n\*)a

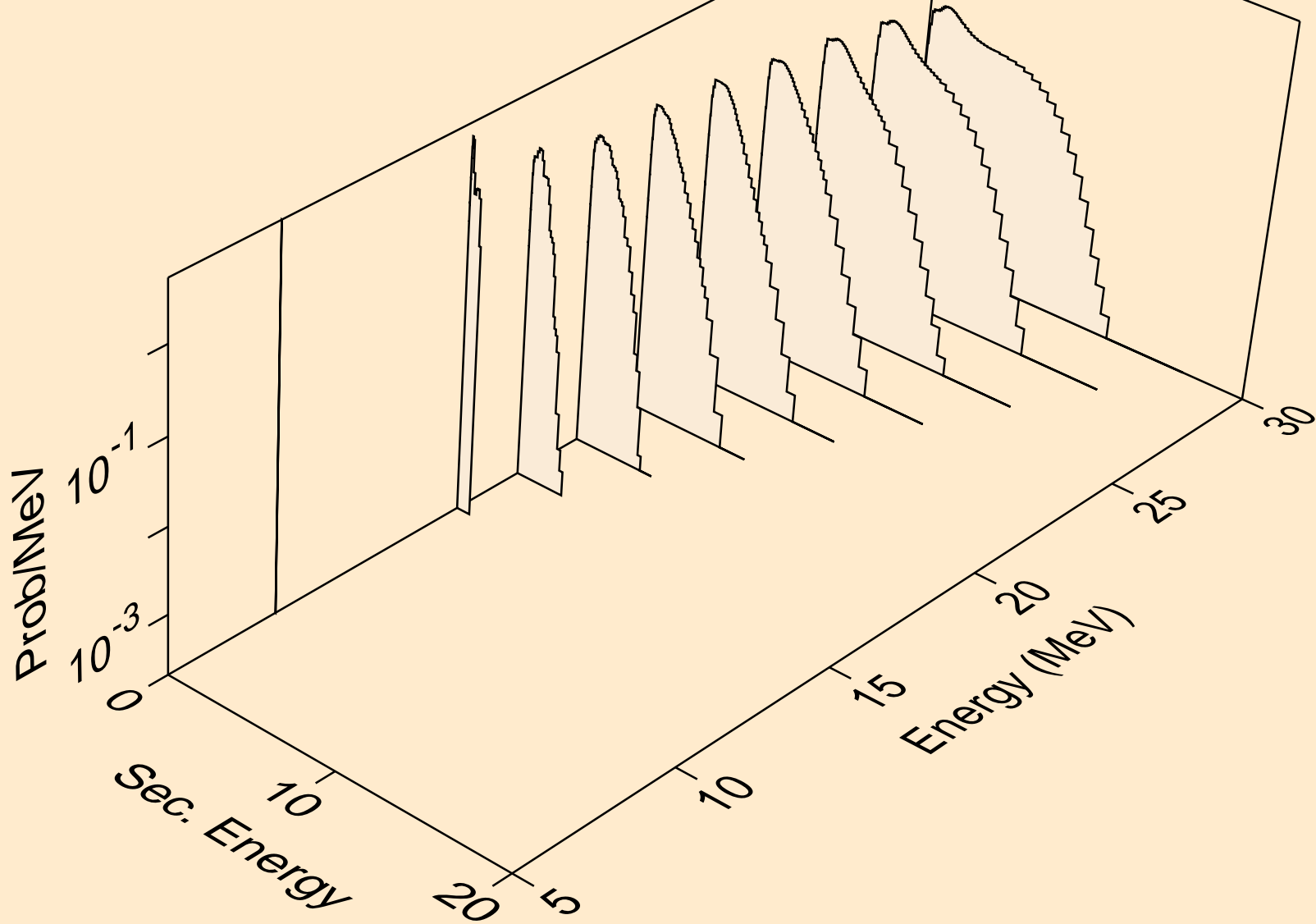

SM131 PROTON ACER TENDL-2023 LIBRARY; T=0.K  
neutrons from (p,n\*)p

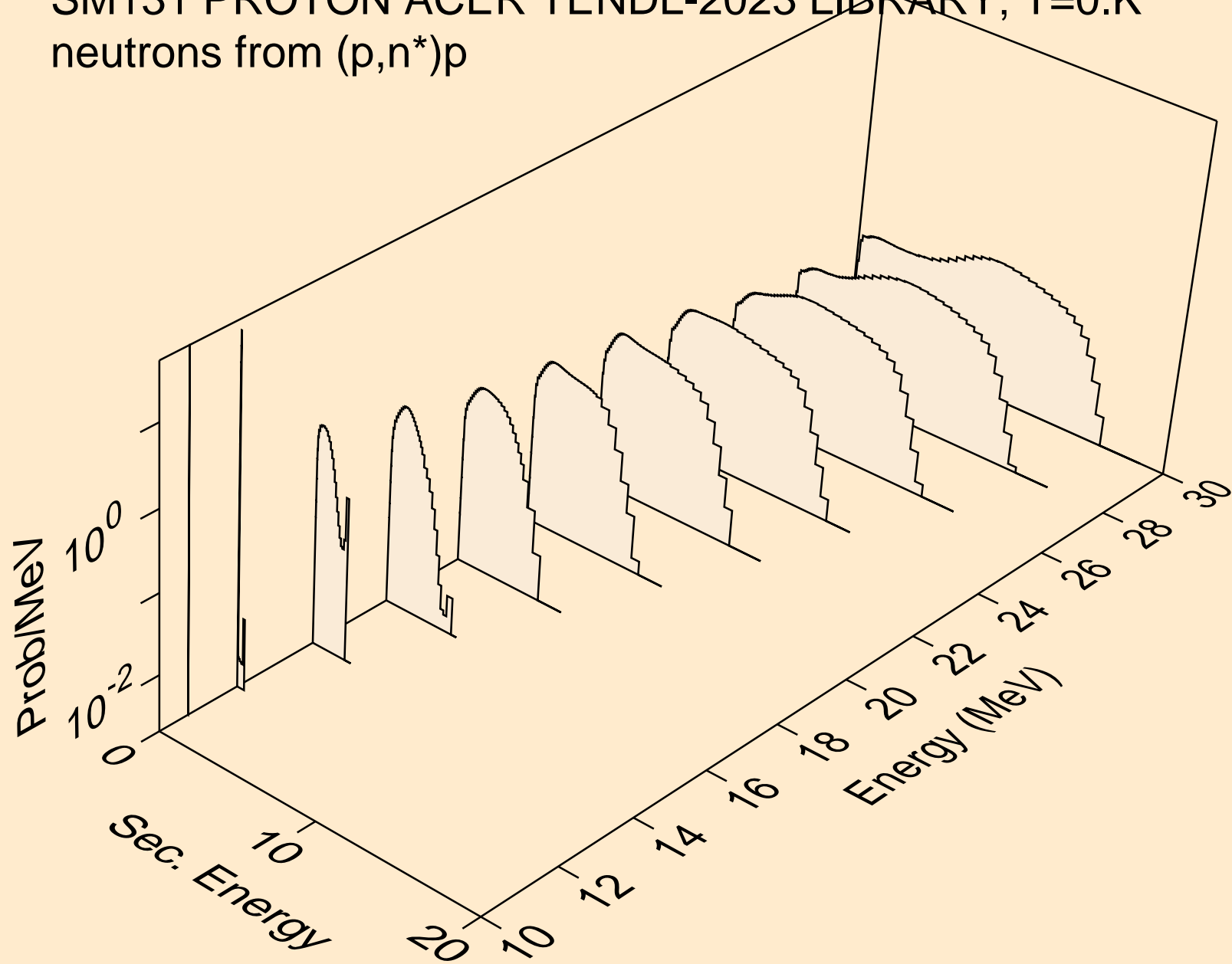



SM131 PROTON ACER TENDL-2023 LIBRARY; T=0.K  
neutrons from (p,n\*)d

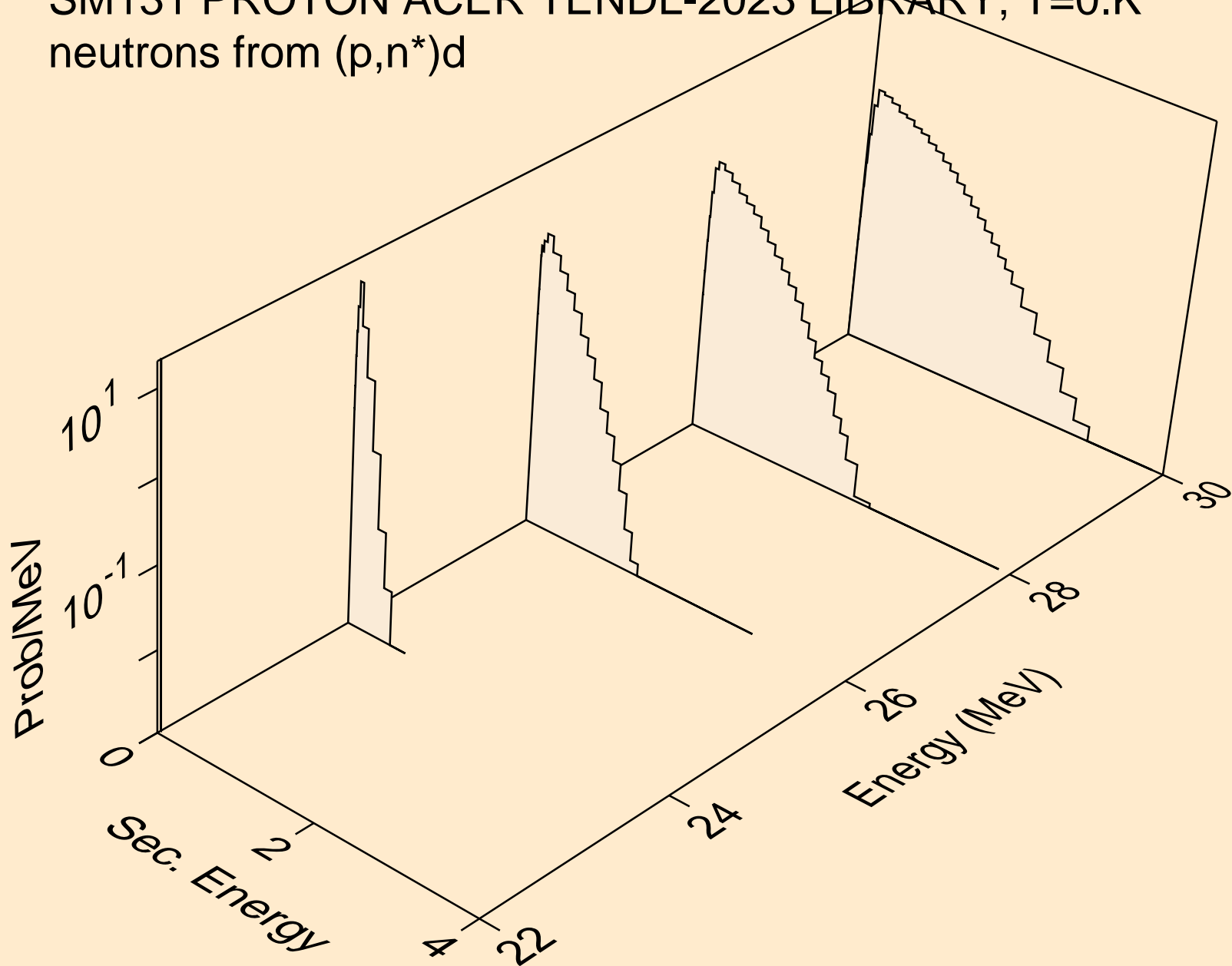

SM131 PROTON ACER TENDL-2023 LIBRARY; T=0.K  
neutrons from (p,2np)

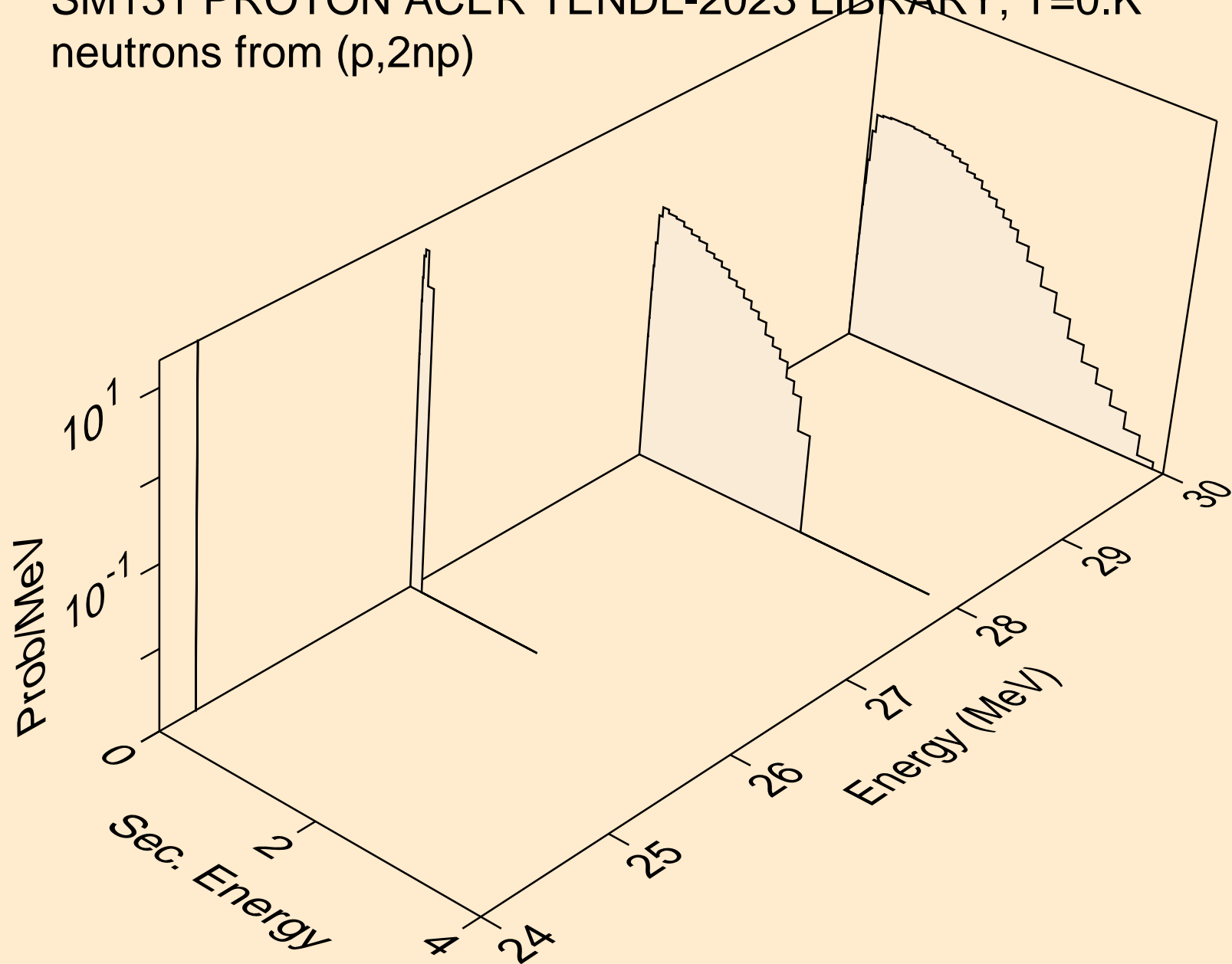

SM131 PROTON ACER TENDL-2023 LIBRARY; T=0.K  
neutrons from (p,n2p)

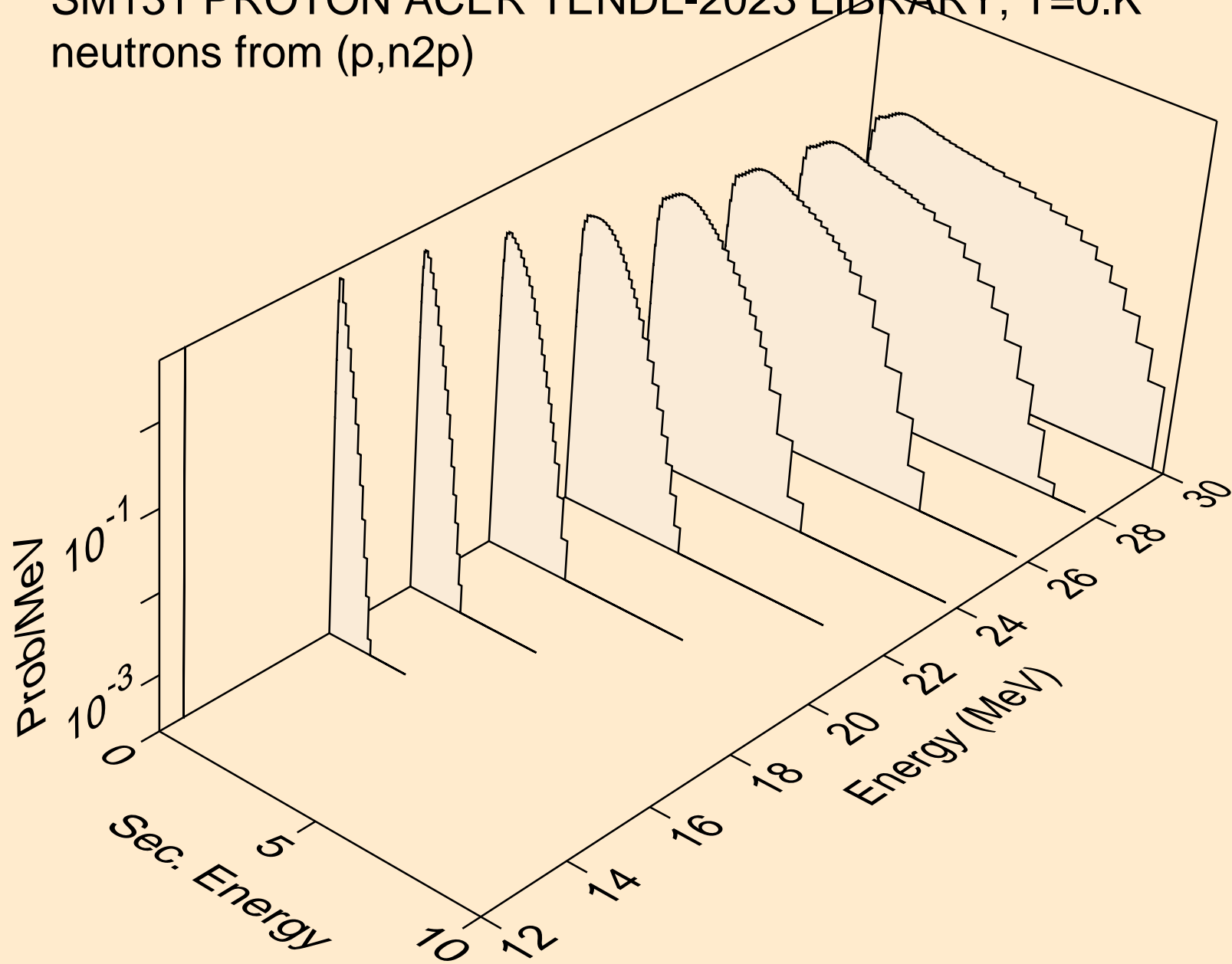

SM131 PROTON ACER TENDL-2023 LIBRARY; T=0.K  
neutrons from (p,npa)

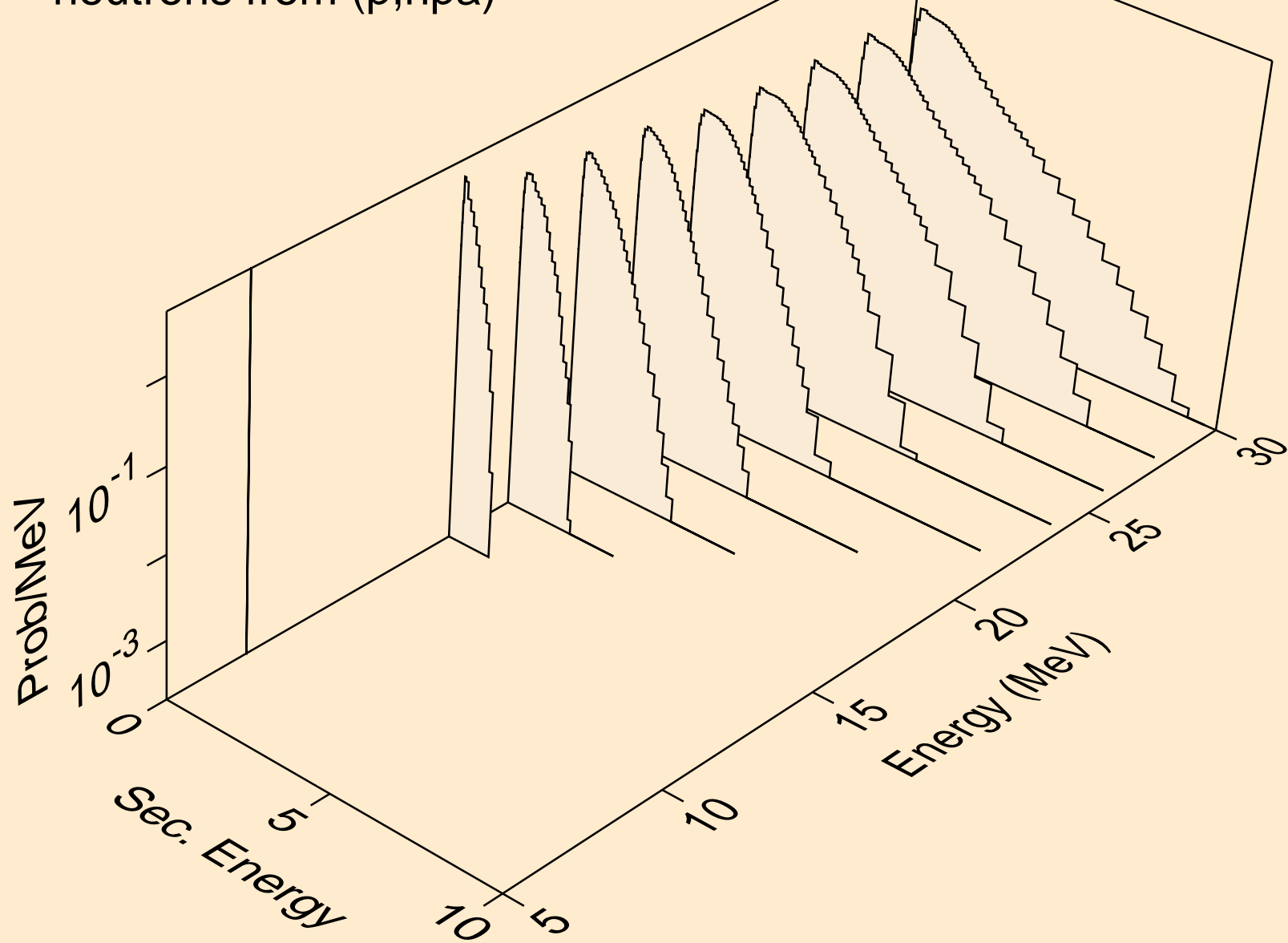

SM131 PROTON ACER TENDL-2023 LIBRARY; T=0.K  
deuterons from (p,x)

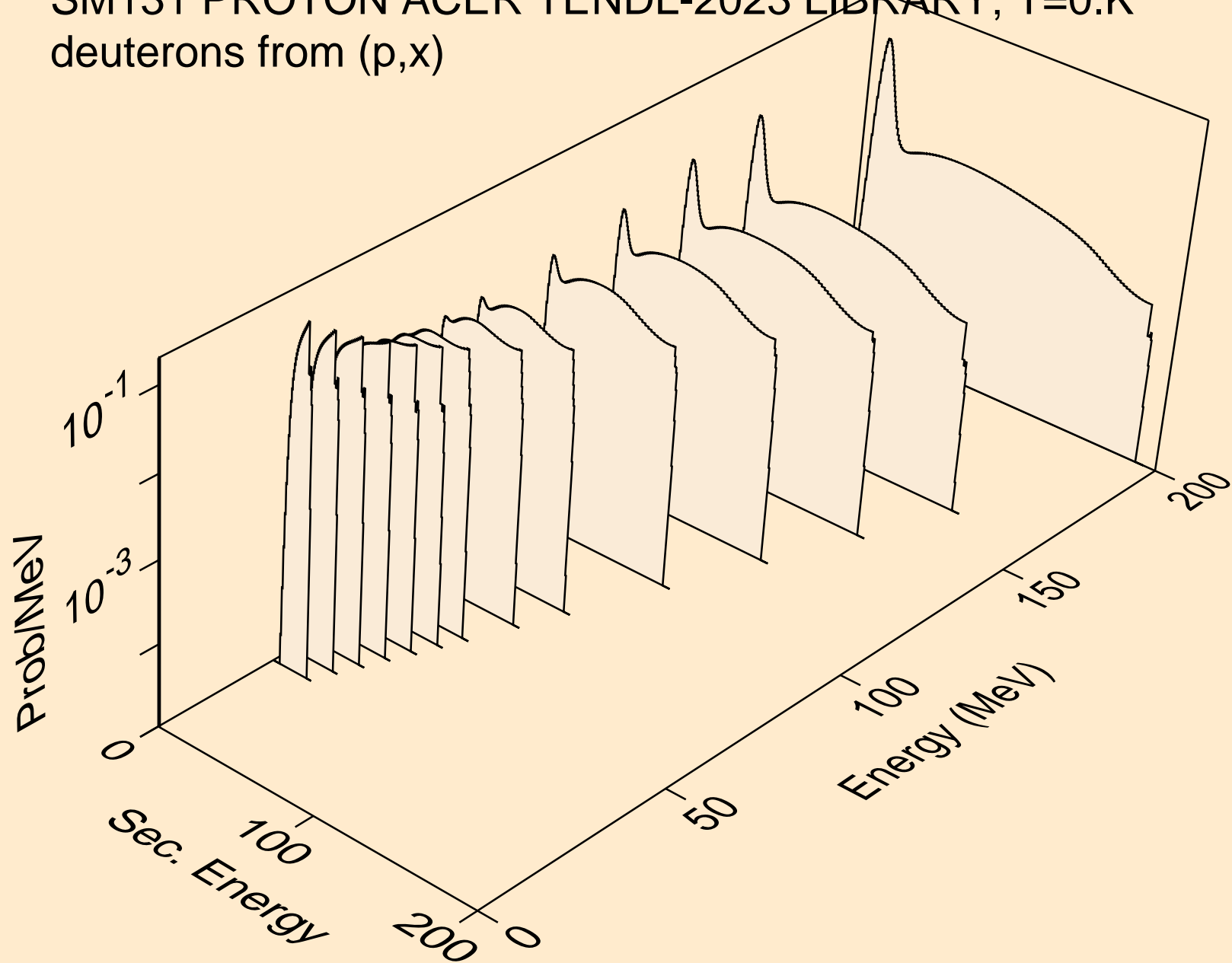

SM131 PROTON ACER TENDL-2023 LIBRARY; T=0.K  
deuterons from (p,n\*)d

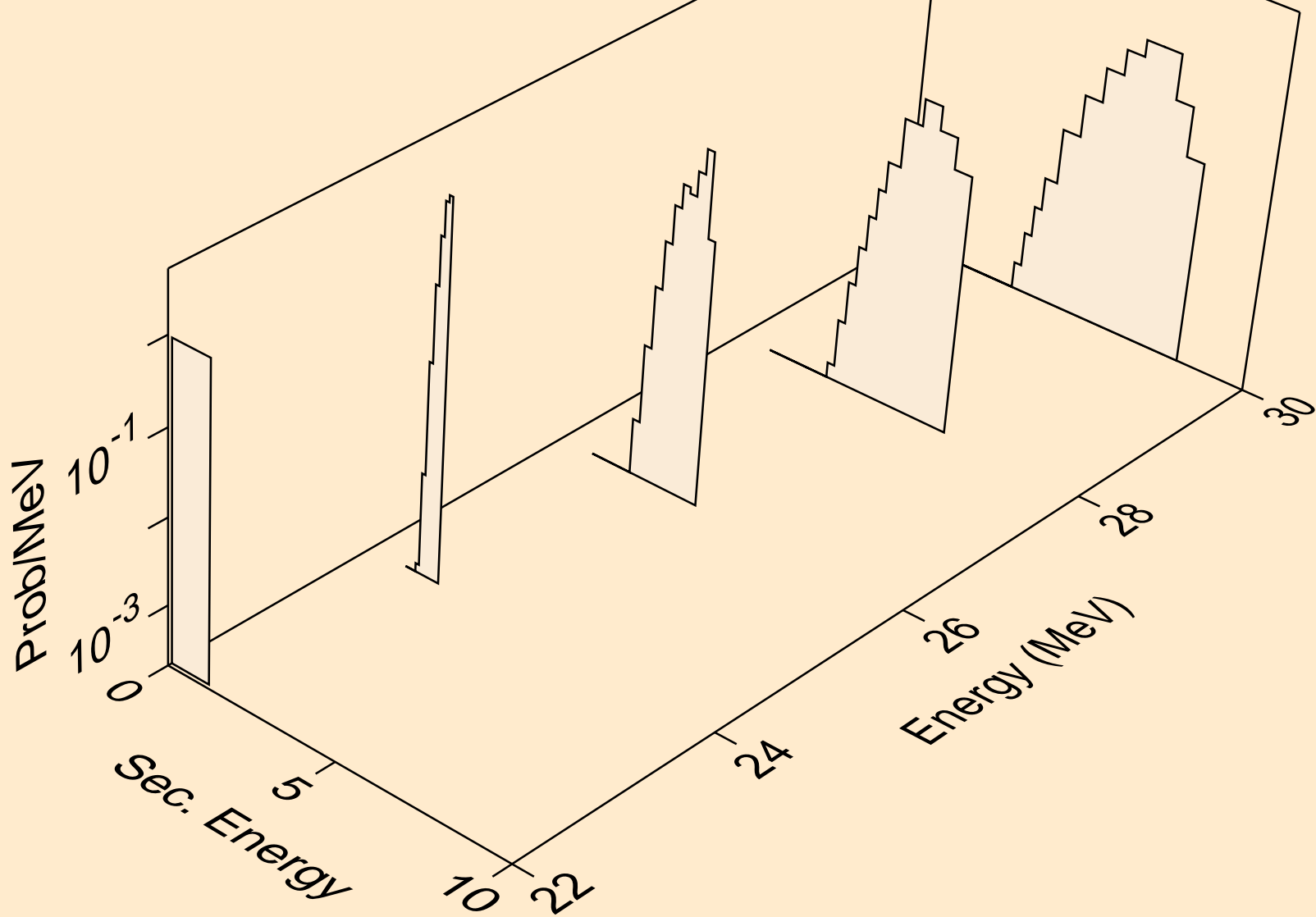

SM131 PROTON ACER TENDL-2023 LIBRARY; T=0.K  
deuterons from (p,d)

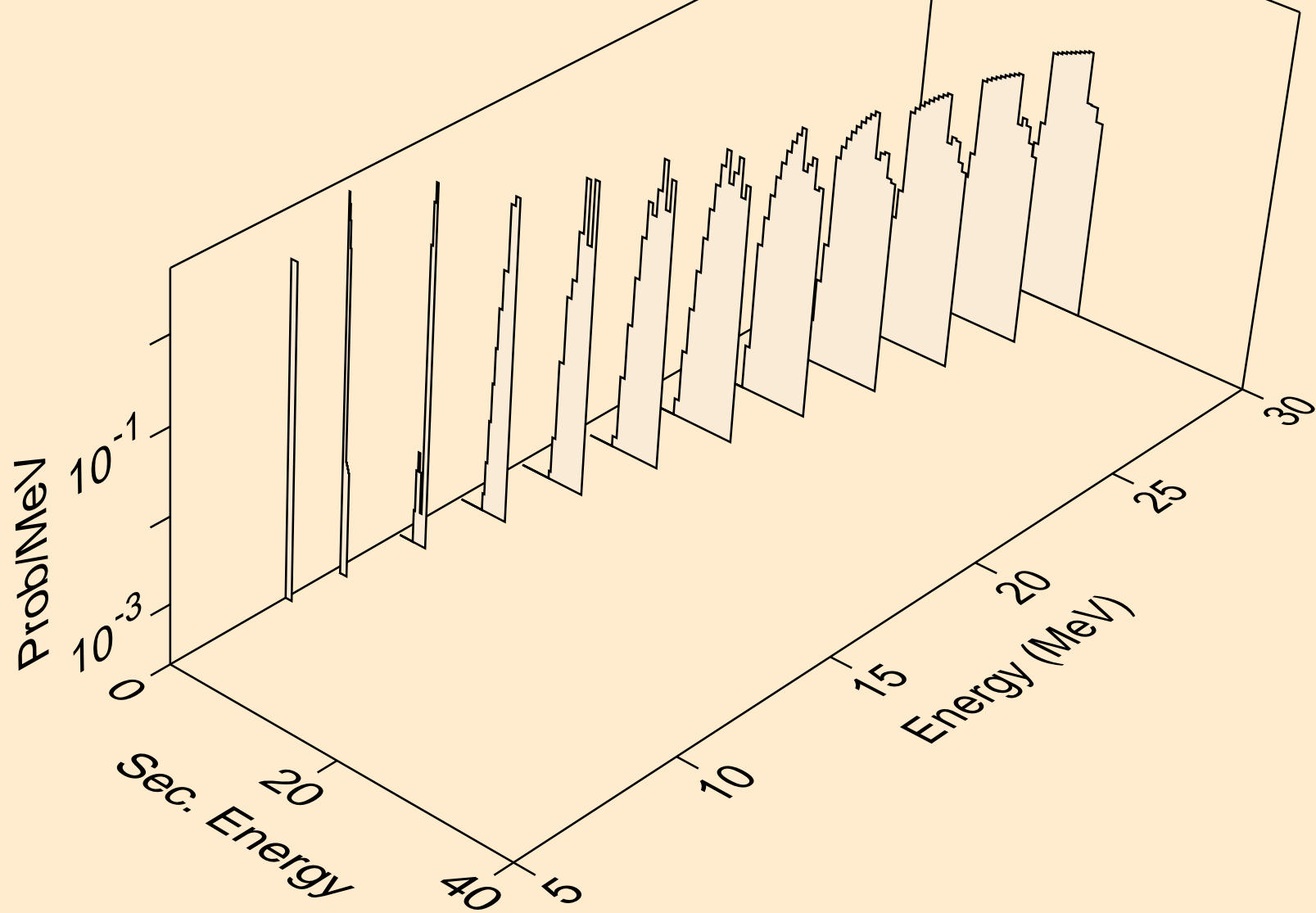

SM131 PROTON ACER TENDL-2023 LIBRARY; T=0.K  
deuterons from (p,pd)

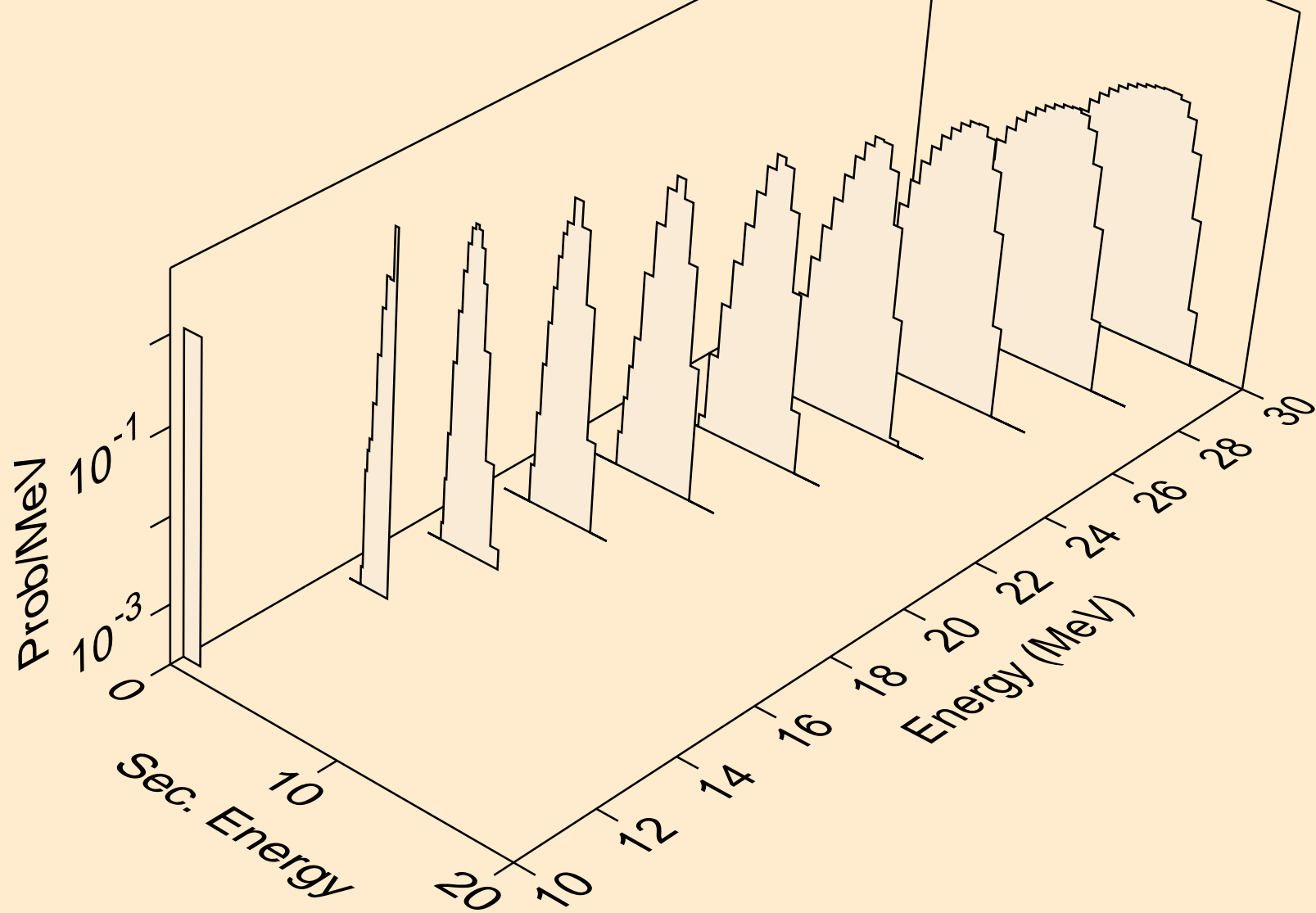



SM131 PROTON ACER TENDL-2023 LIBRARY; T=0.K  
deuterons from (p,da)

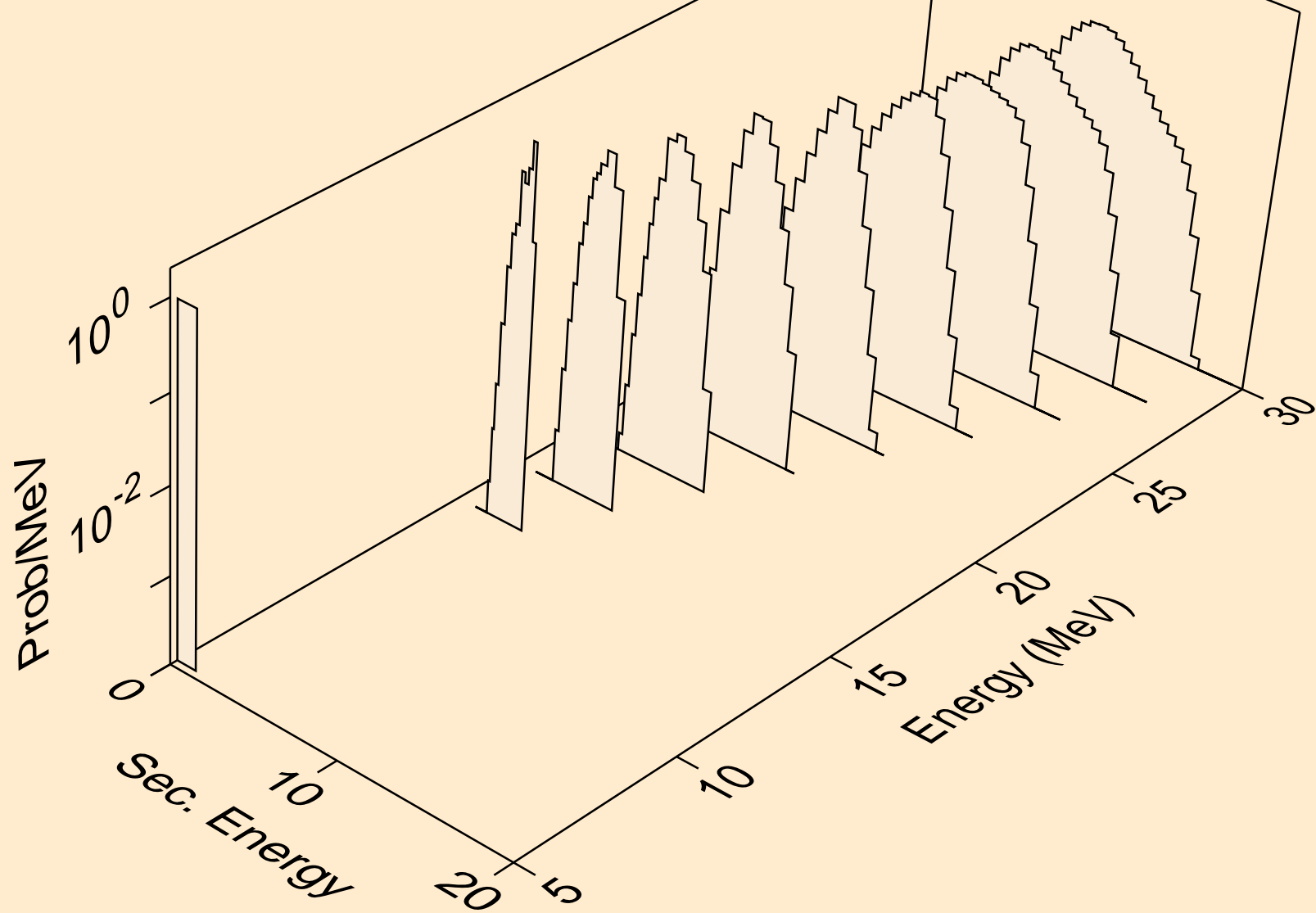

SM131 PROTON ACER TENDL-2023 LIBRARY; T=0.K  
tritons from (p,x)

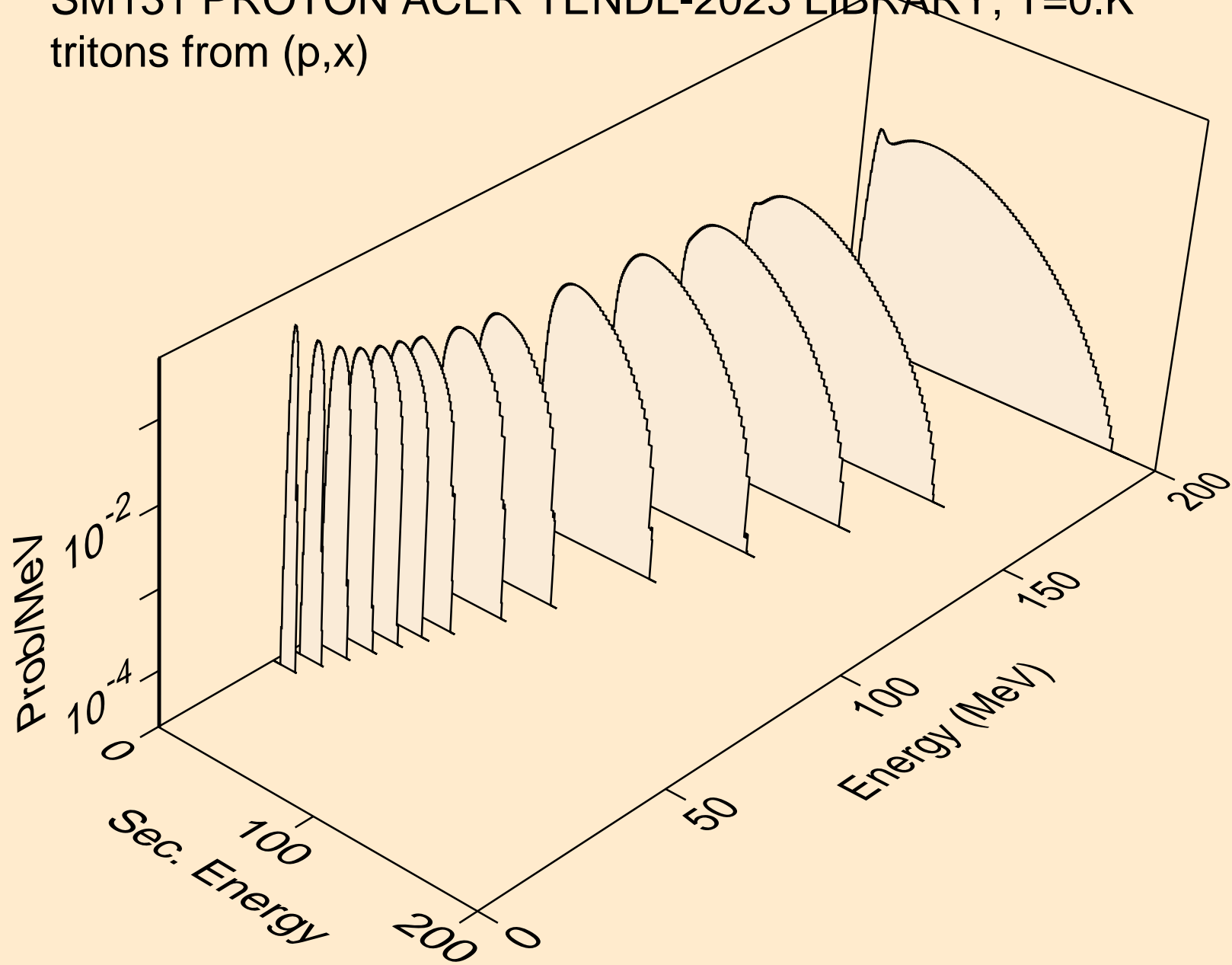

SM131 PROTON ACER TENDL-2023 LIBRARY; T=0.K  
tritons from (p,t)

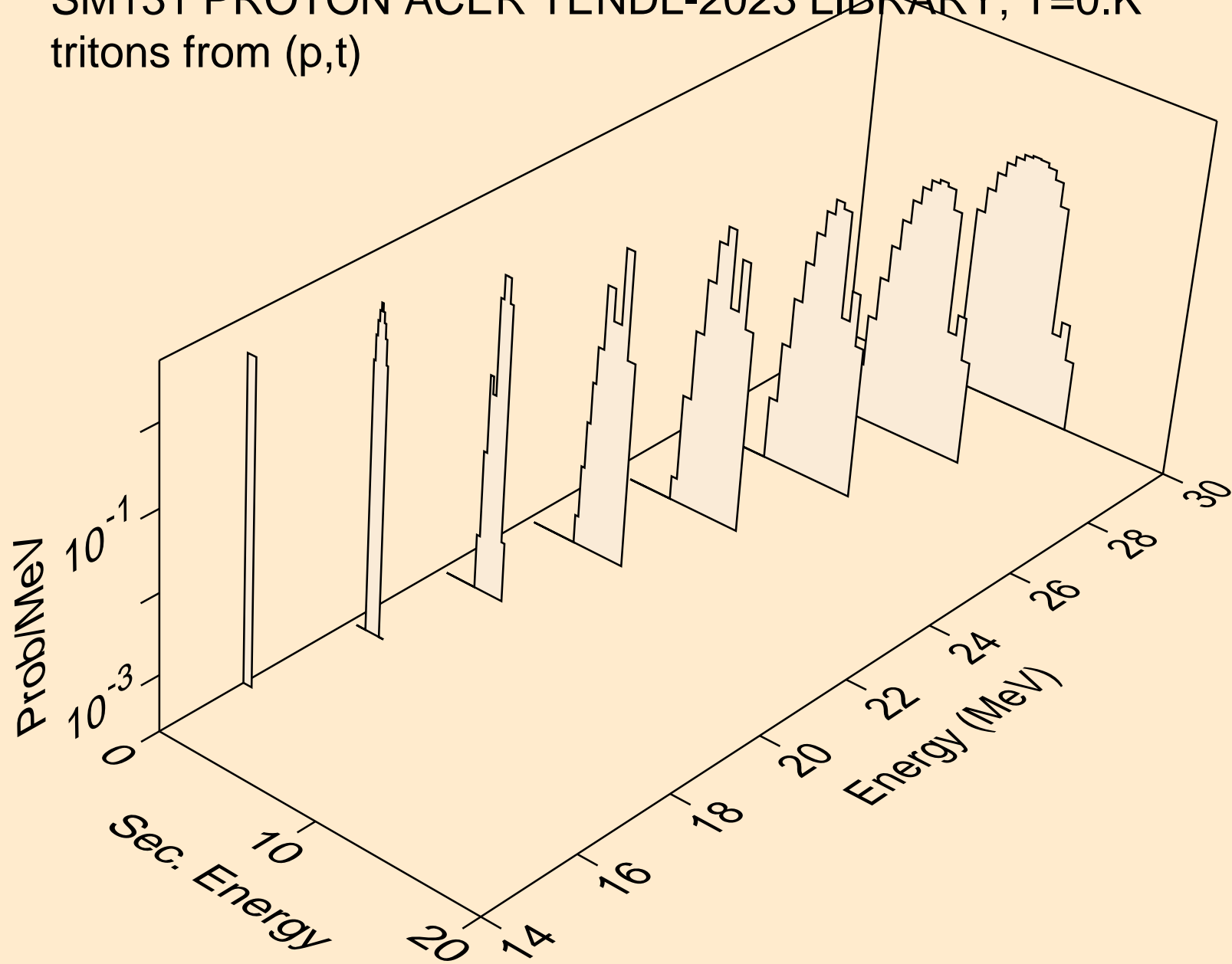

SM131 PROTON ACER TENDL-2023 LIBRARY; T=0.K  
tritons from (p,pt)

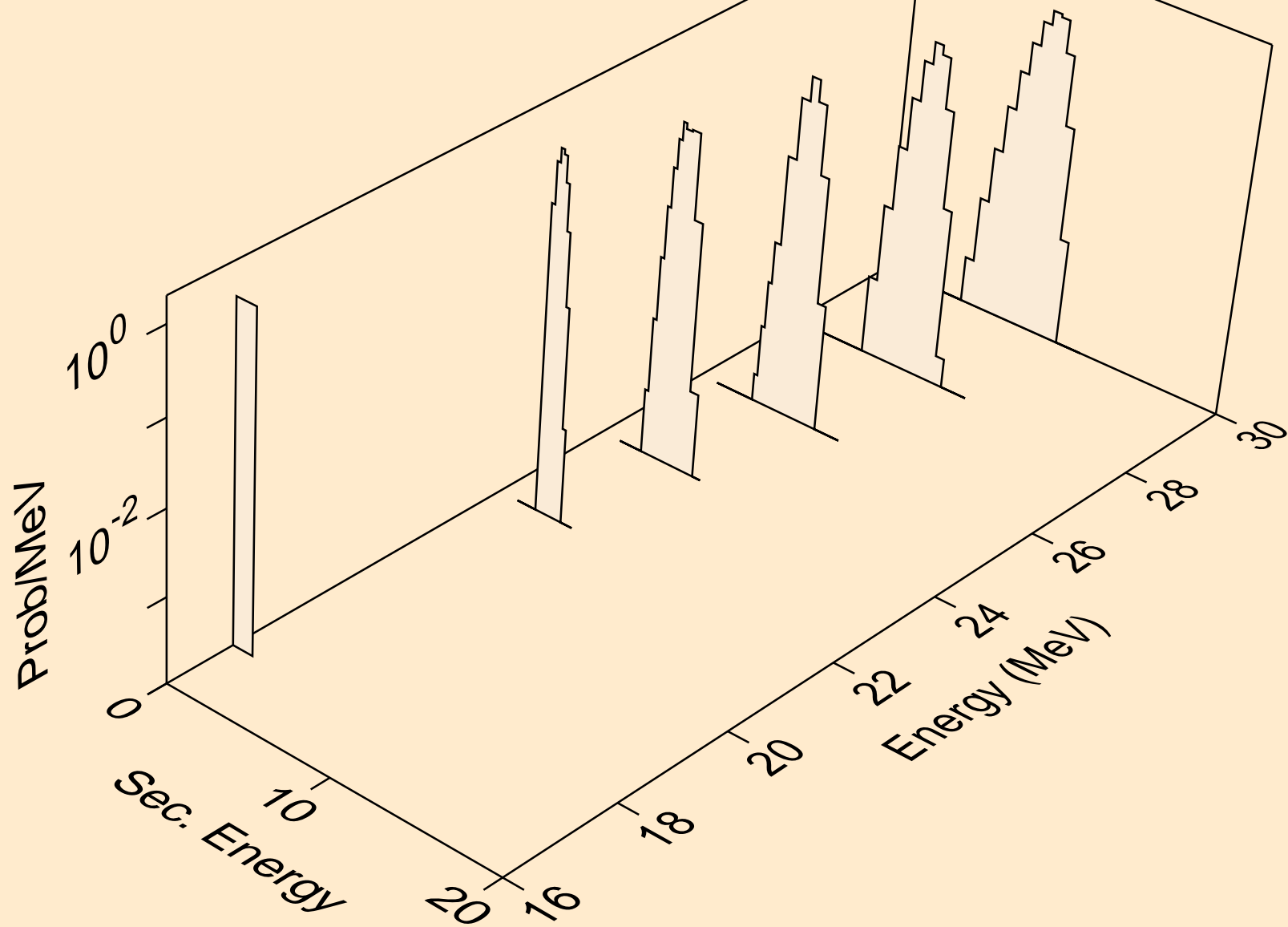

SM131 PROTON ACER TENDL-2023 LIBRARY; T=0.K  
he3s from (p,x)

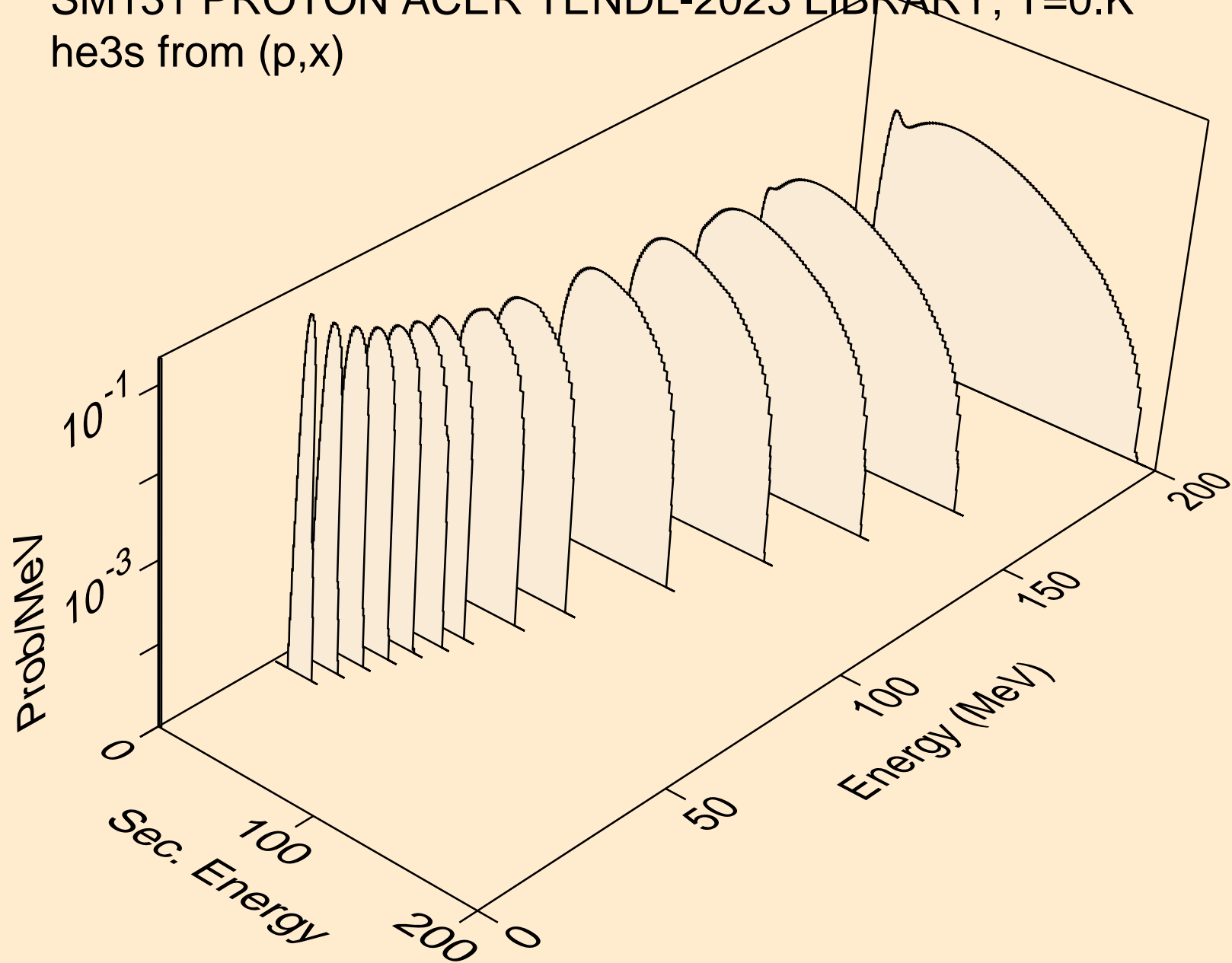

SM131 PROTON ACER TENDL-2023 LIBRARY; T=0.K  
he3s from (p,he3)

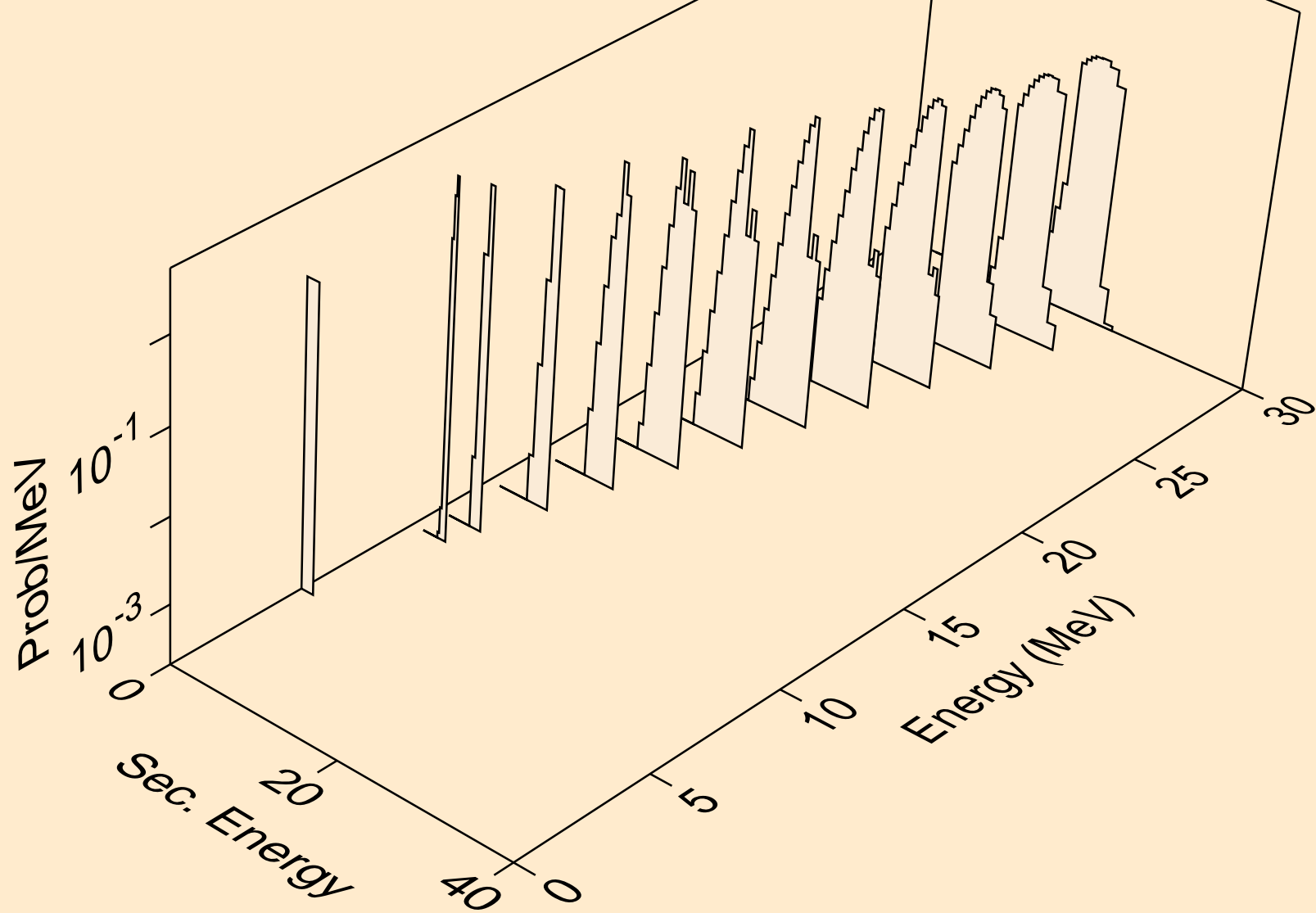

SM131 PROTON ACER TENDL-2023 LIBRARY; T=0.K  
alphas from (p,x)

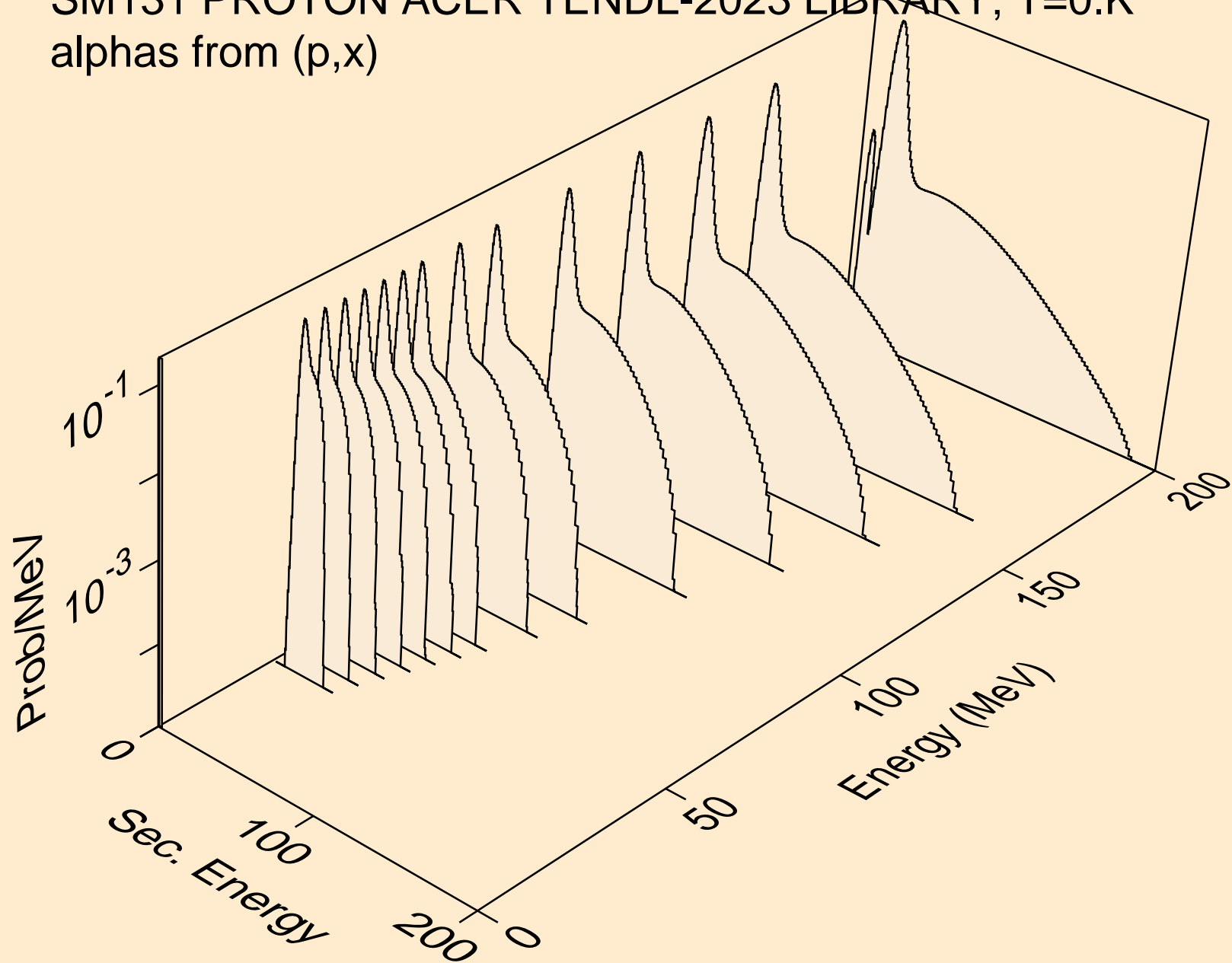

SM131 PROTON ACER TENDL-2023 LIBRARY; T=0.K  
alphas from (p,n\*)a

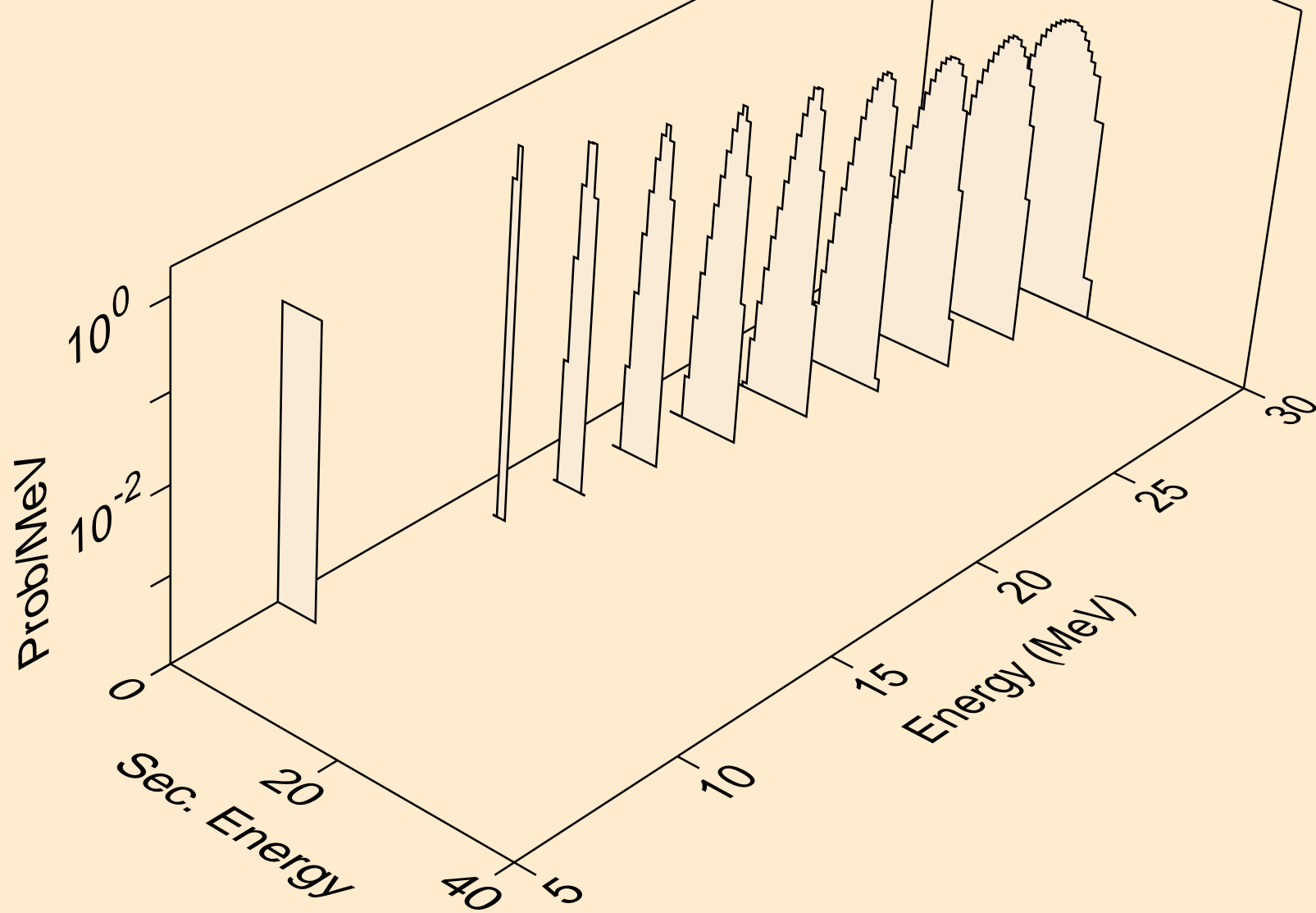



SM131 PROTON ACER TENDL-2023 LIBRARY; T=0.K  
alphas from (p,npa)

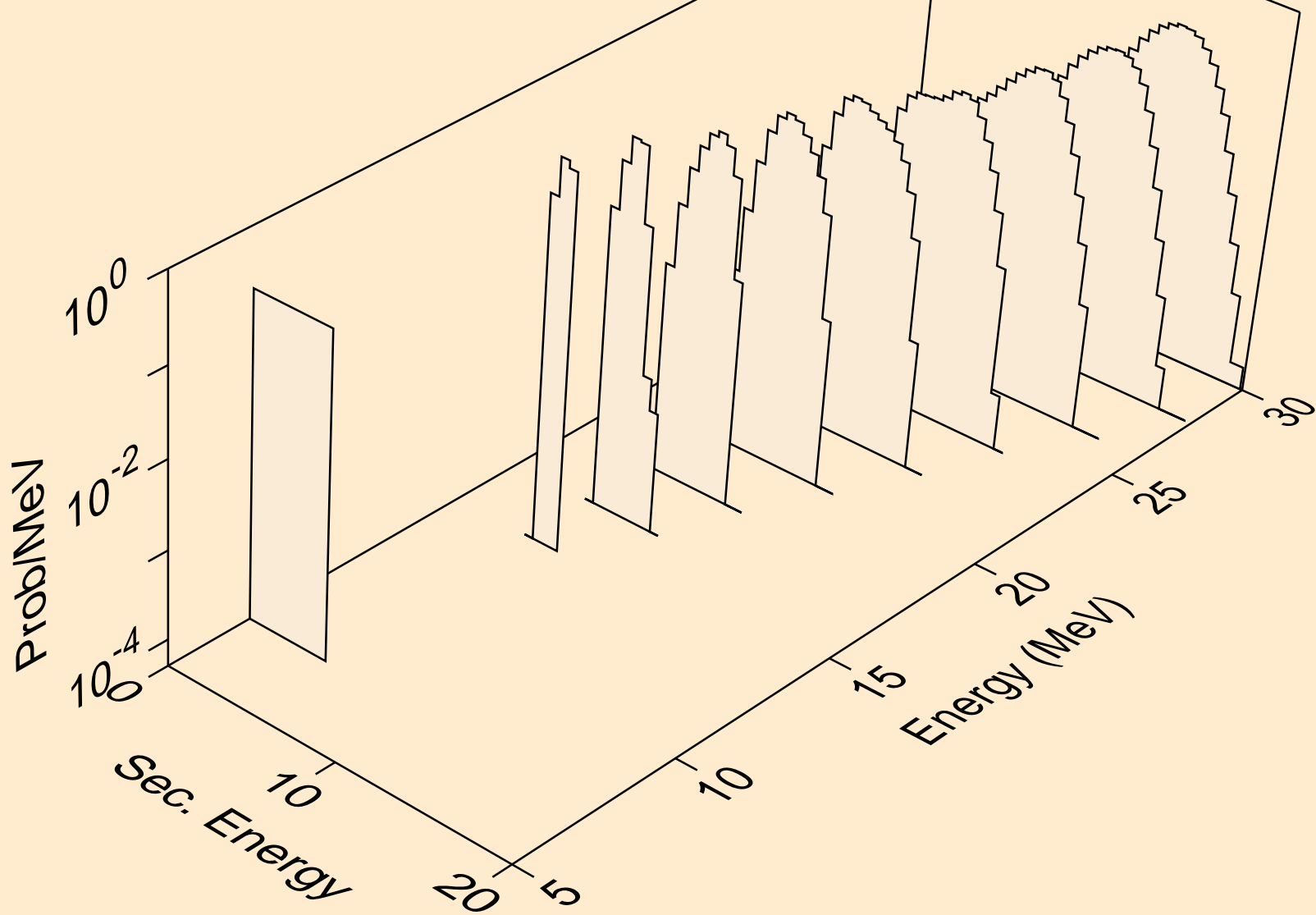

SM131 PROTON ACER TENDL-2023 LIBRARY; T=0.K  
alphas from (p,a)

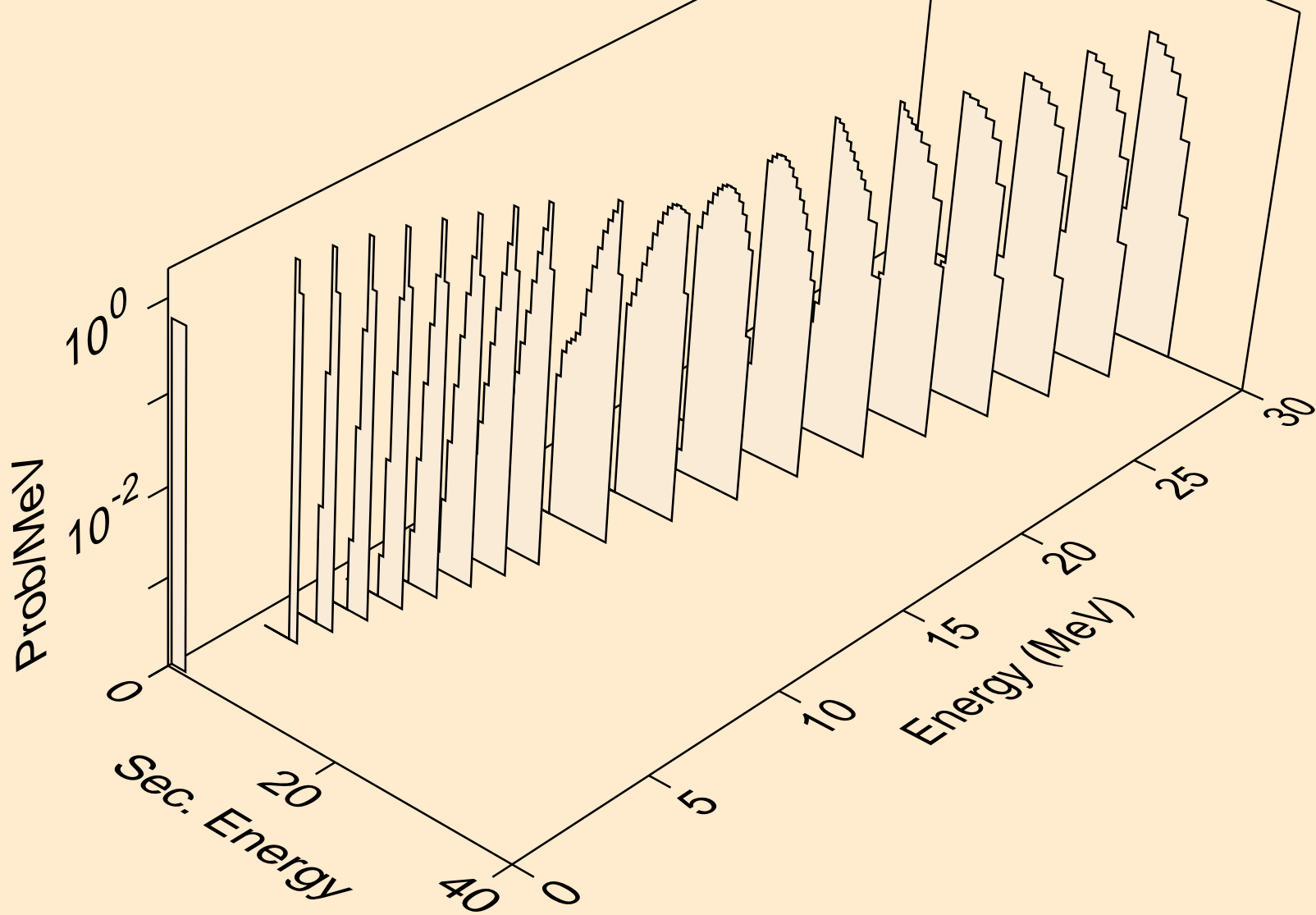

SM131 PROTON ACER TENDL-2023 LIBRARY; T=0.K  
alphas from (p,2a)

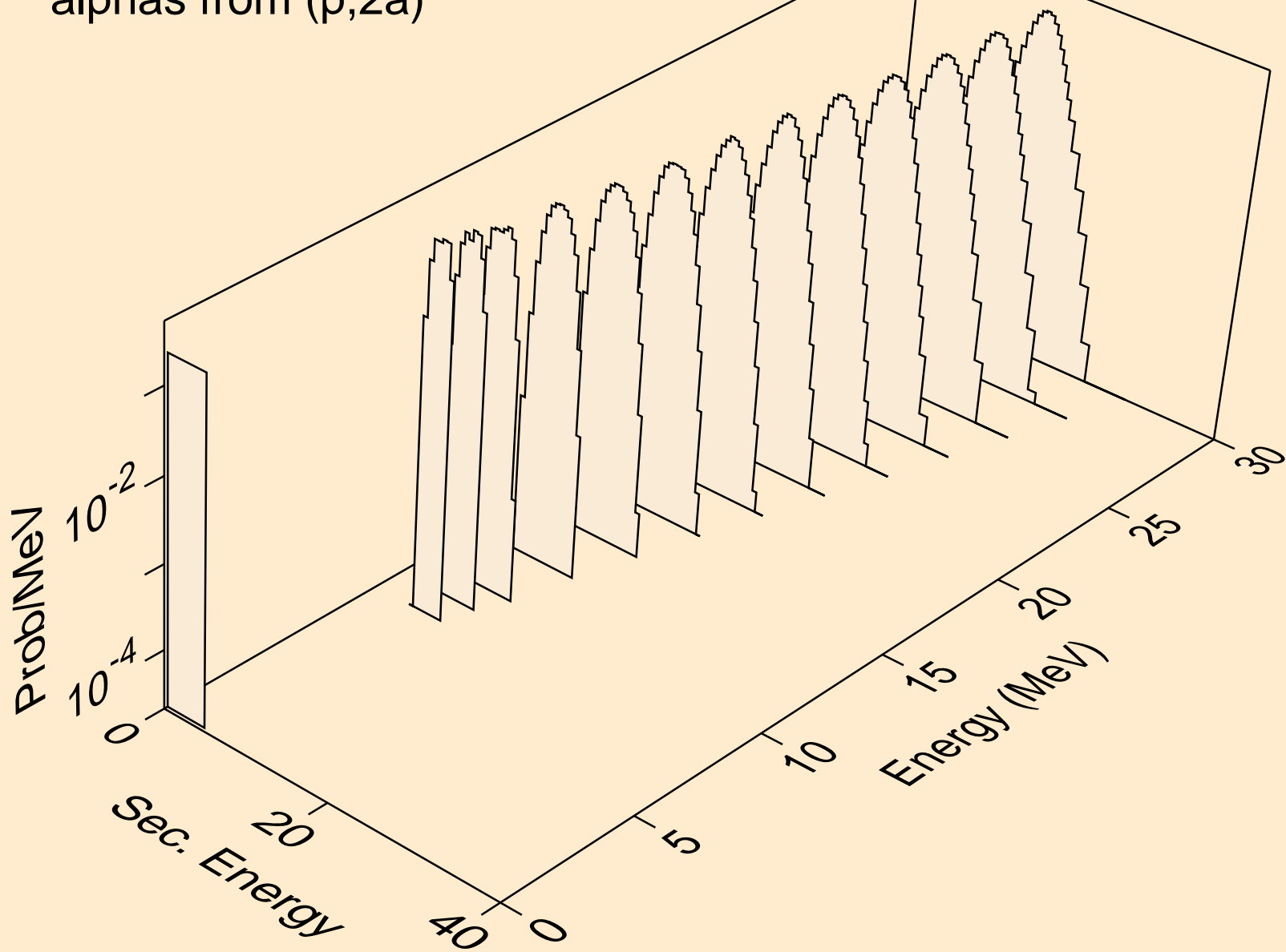

SM131 PROTON ACER TENDL-2023 LIBRARY; T=0.K  
alphas from (p,pa)

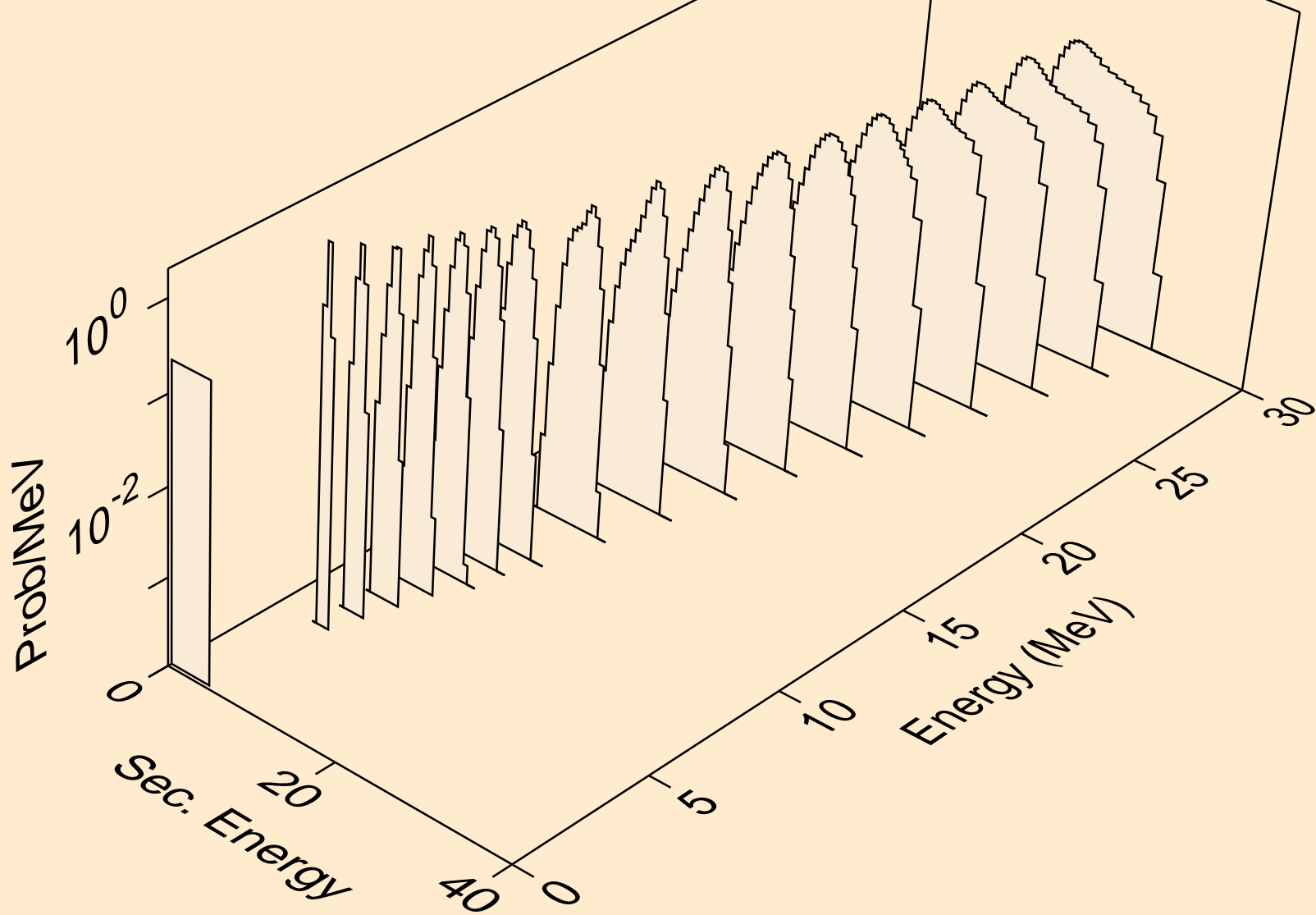

SM131 PROTON ACER TENDL-2023 LIBRARY; T=0.K  
alphas from (p,da)

