

SM161 PROTON ACER TENDL-2023 LIBRARY; T=0.K

Principal cross sections

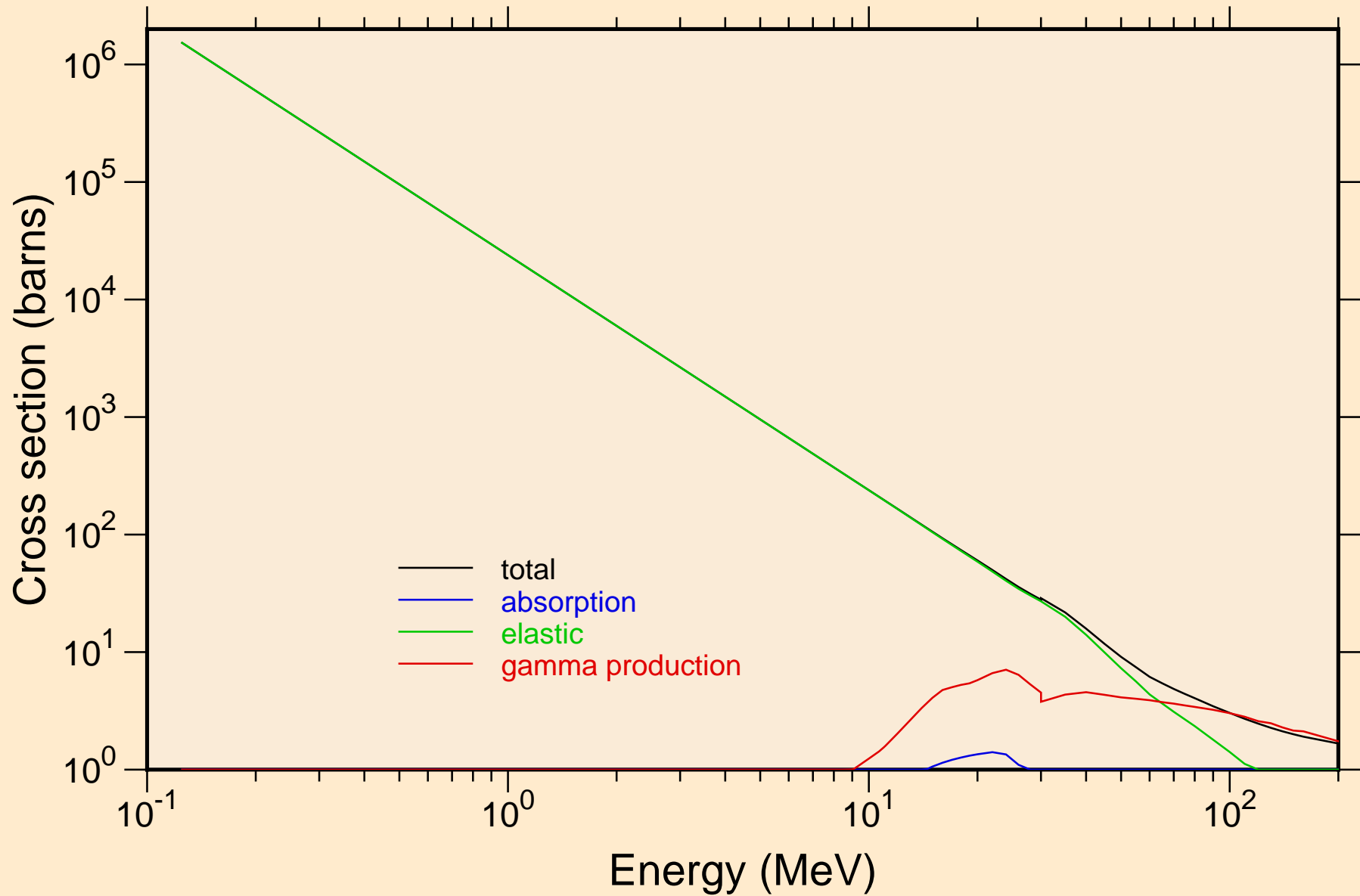

SM161 PROTON ACER TENDL-2023 LIBRARY; T=0.K

Heating

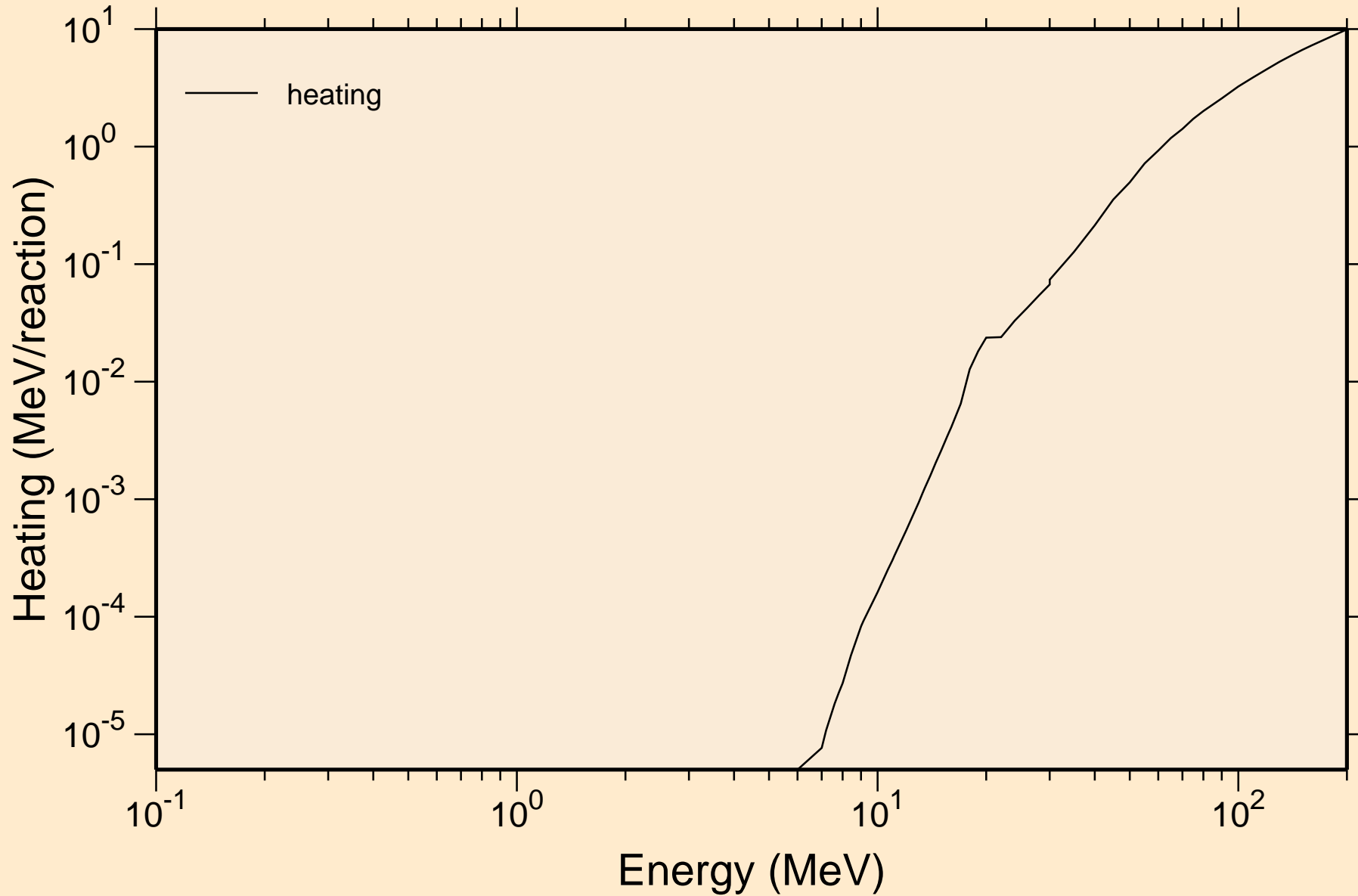

SM161 PROTON ACER TENDL-2023 LIBRARY; T=0.K

Principal cross sections

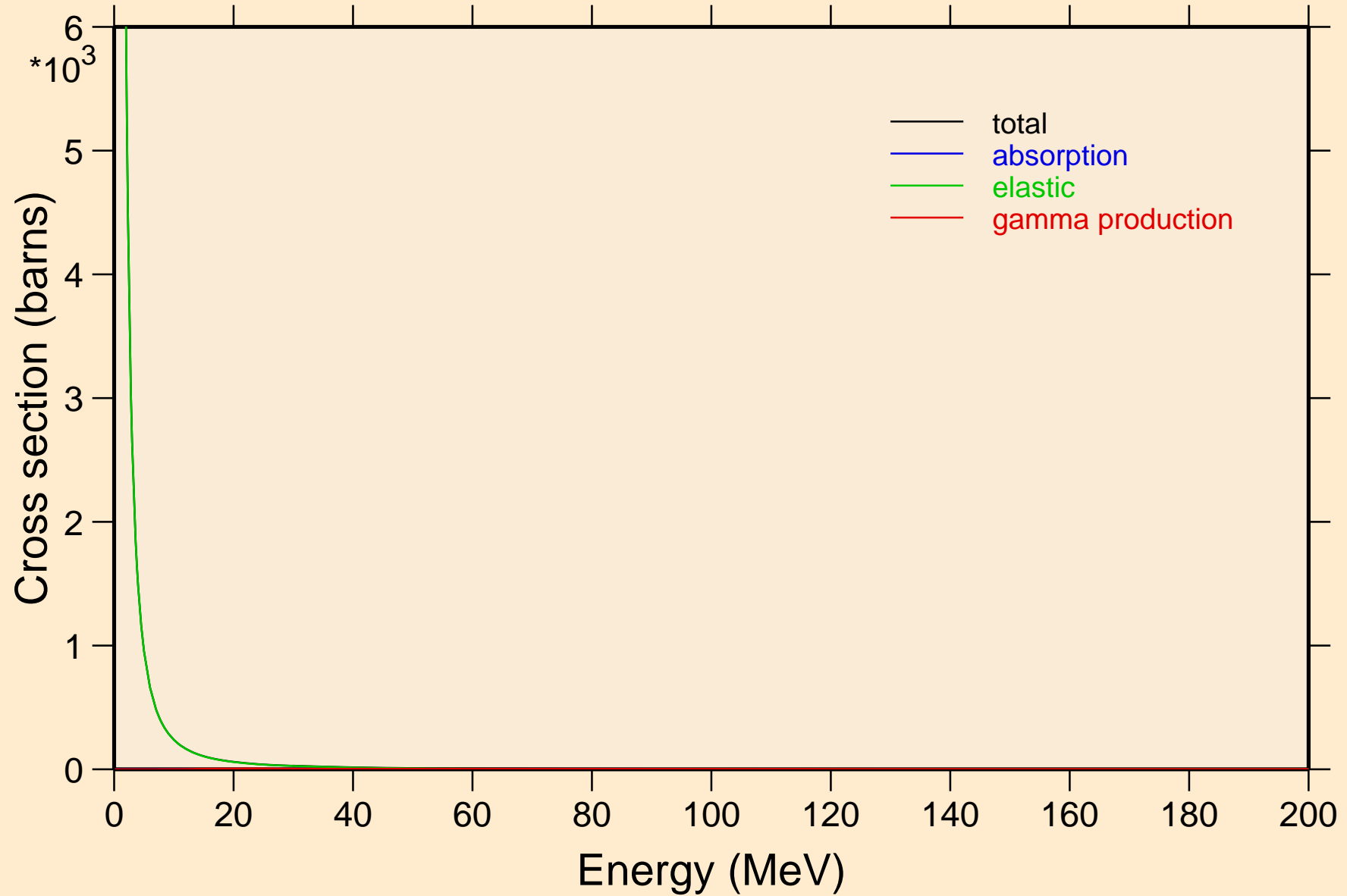

SM161 PROTON ACER TENDL-2023 LIBRARY; T=0.K

Heating

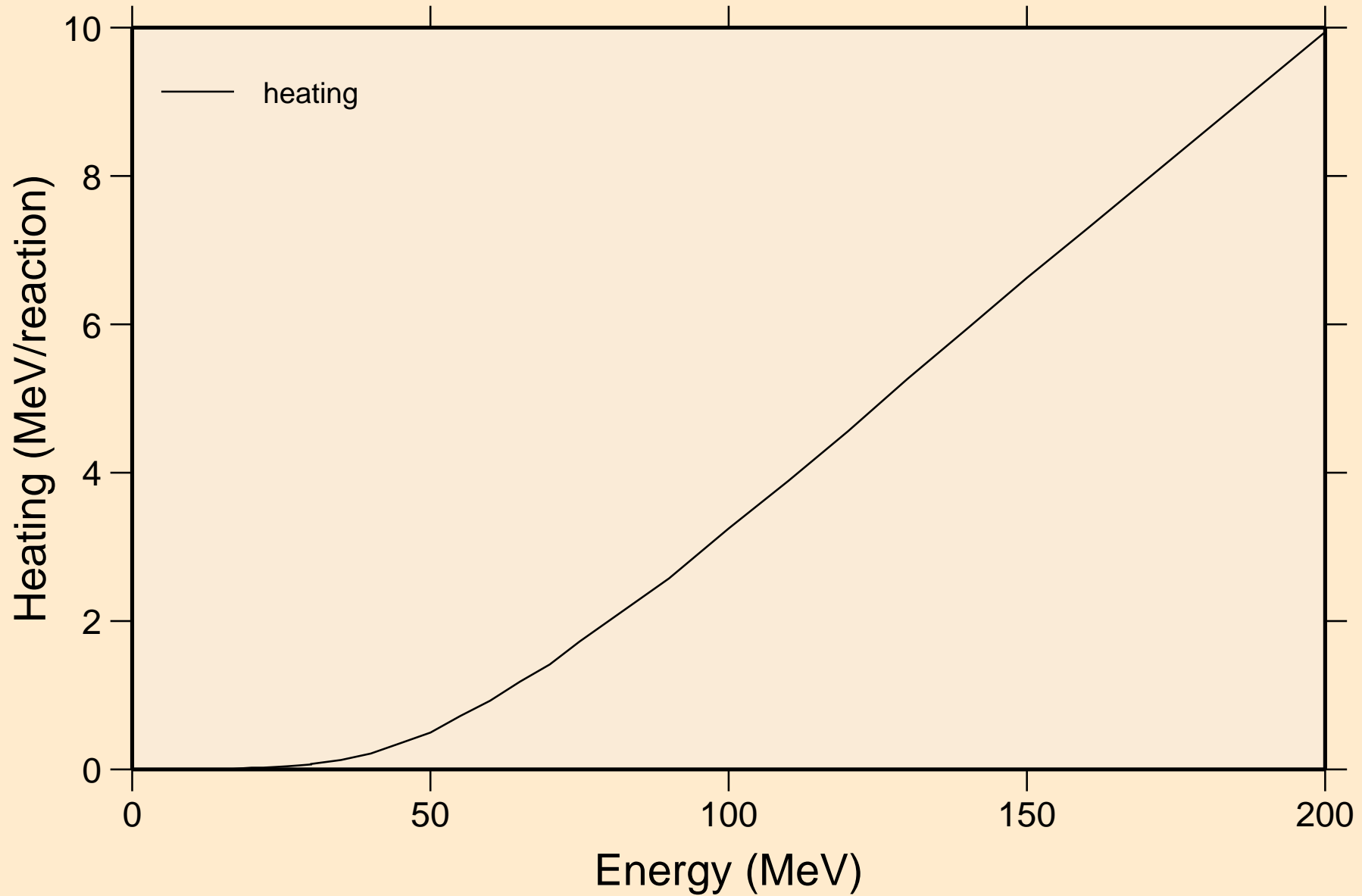

SM161 PROTON ACER TENDL-2023 LIBRARY; T=0.K

Threshold reactions

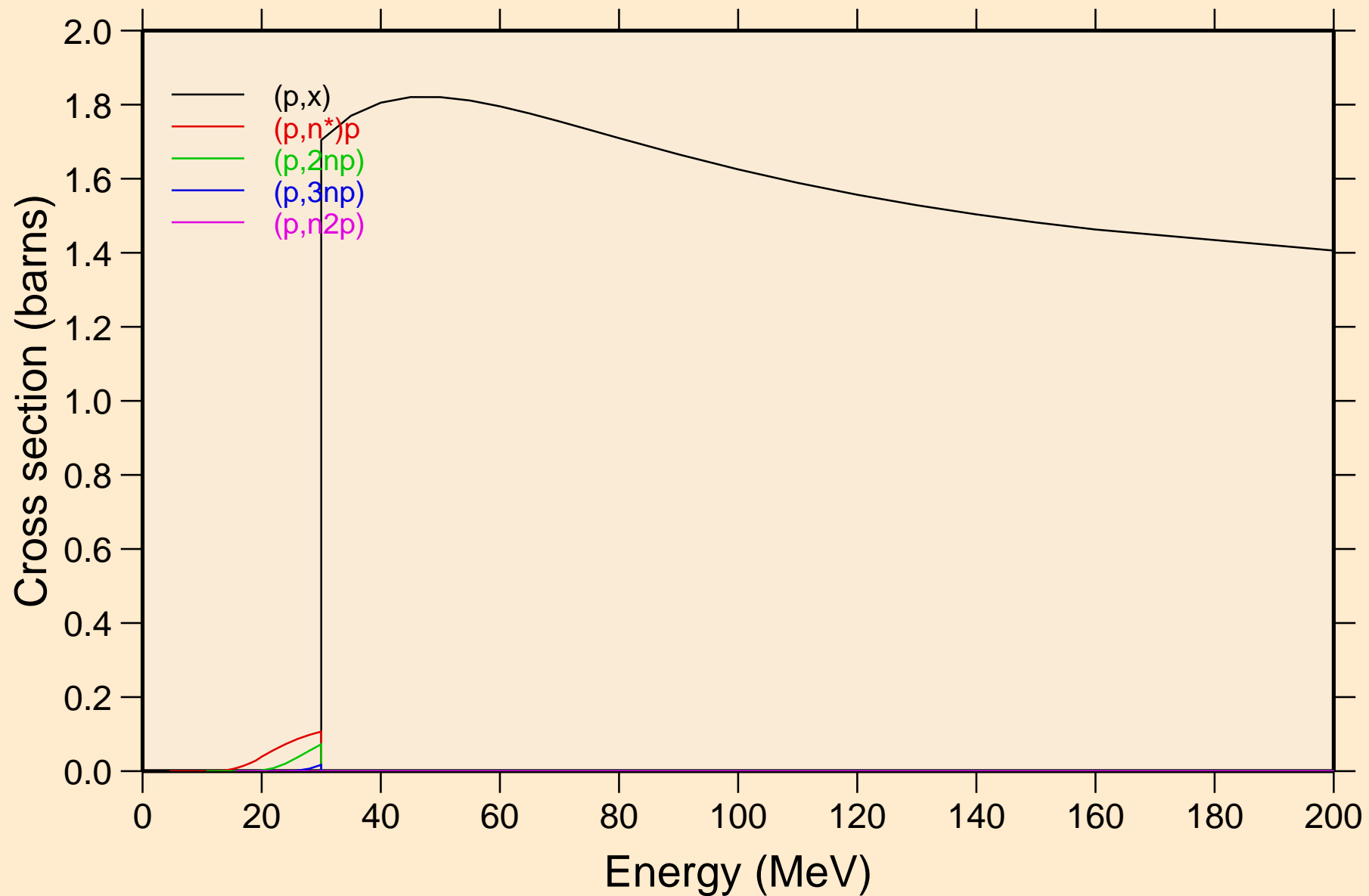

SM161 PROTON ACER TENDL-2023 LIBRARY; T=0.K

Threshold reactions

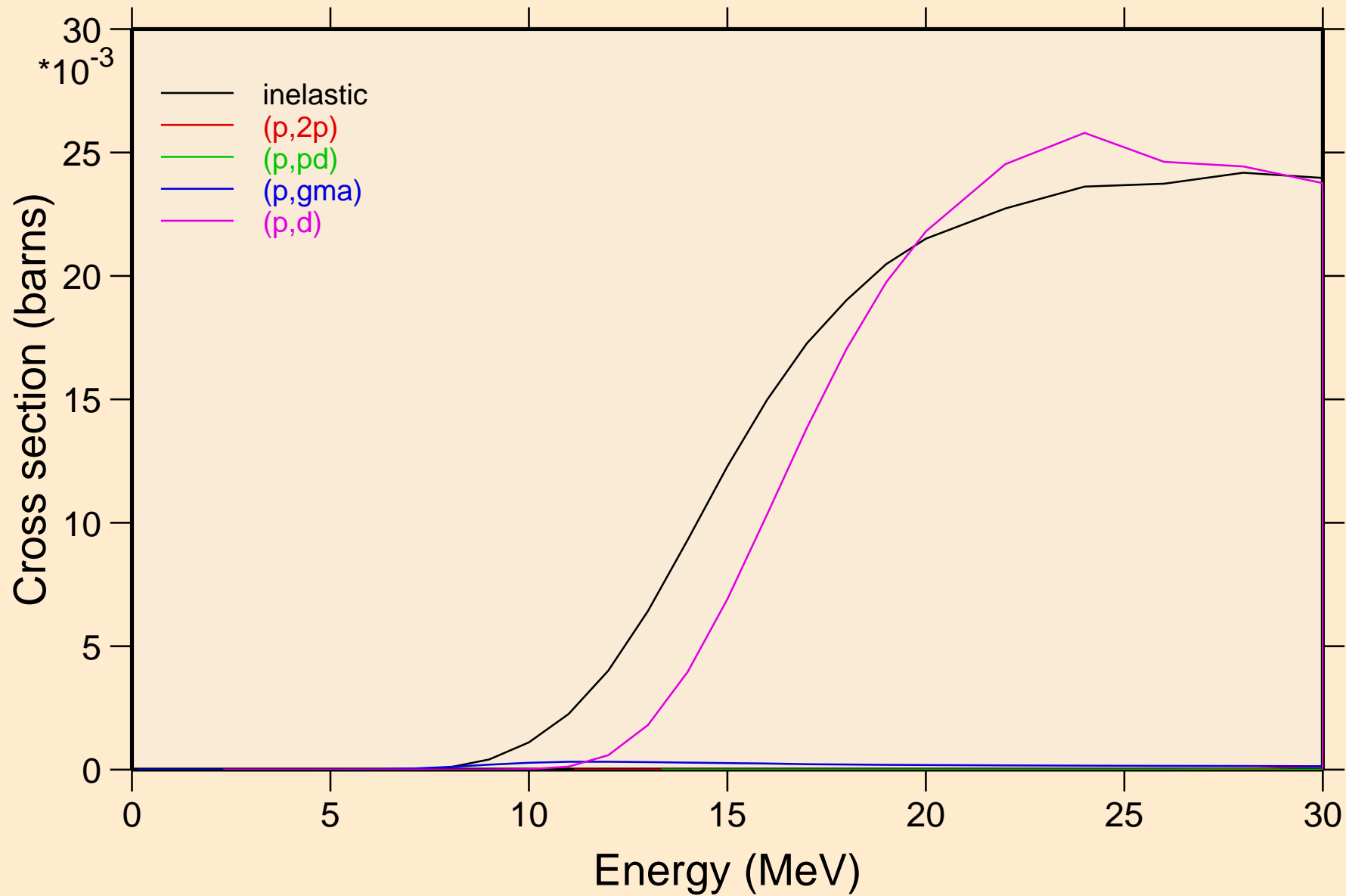

SM161 PROTON ACER TENDL-2023 LIBRARY; T=0.K
Threshold reactions

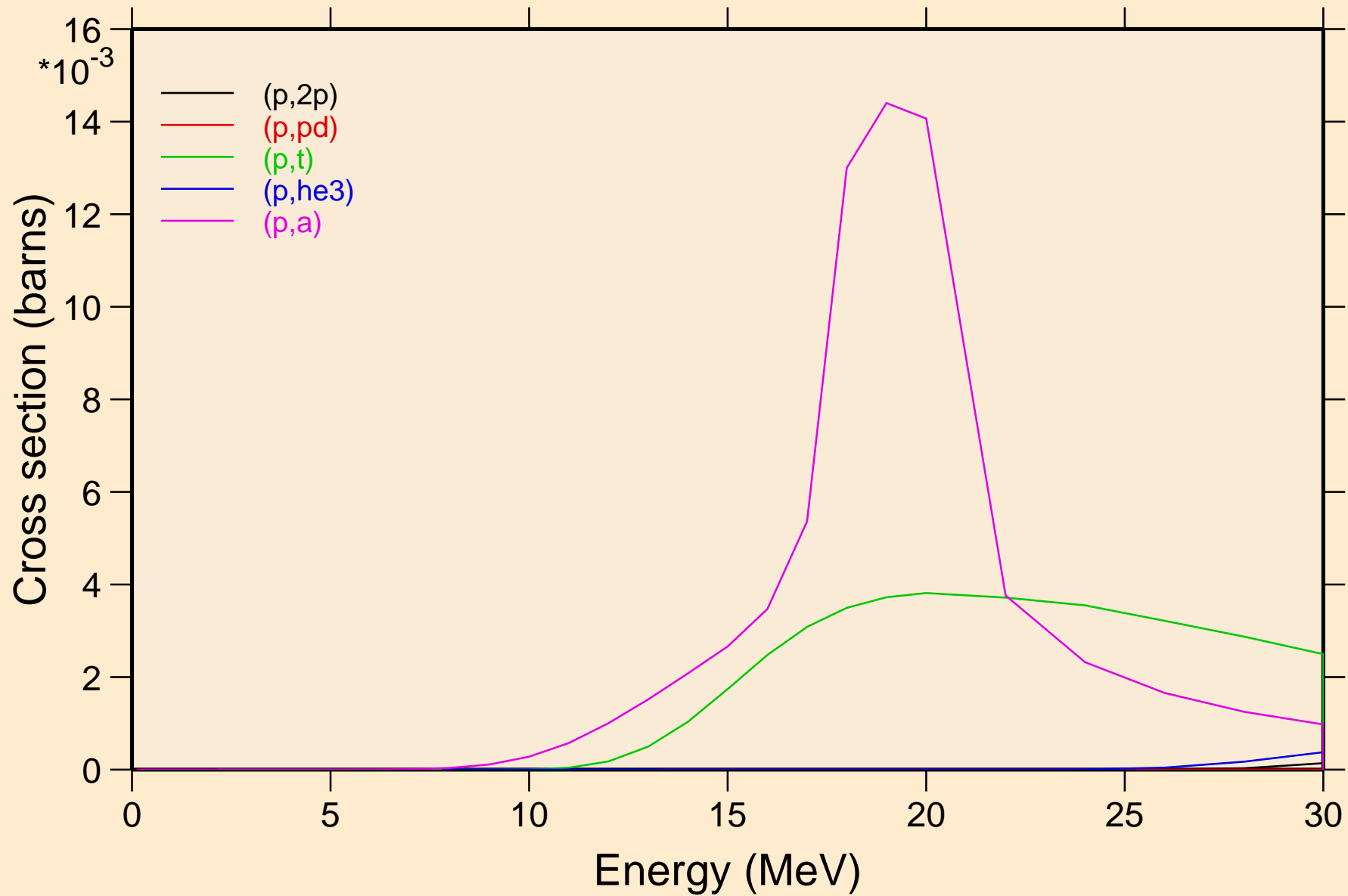

SM161 PROTON ACER TENDL-2023 LIBRARY; T=0.K
Threshold reactions

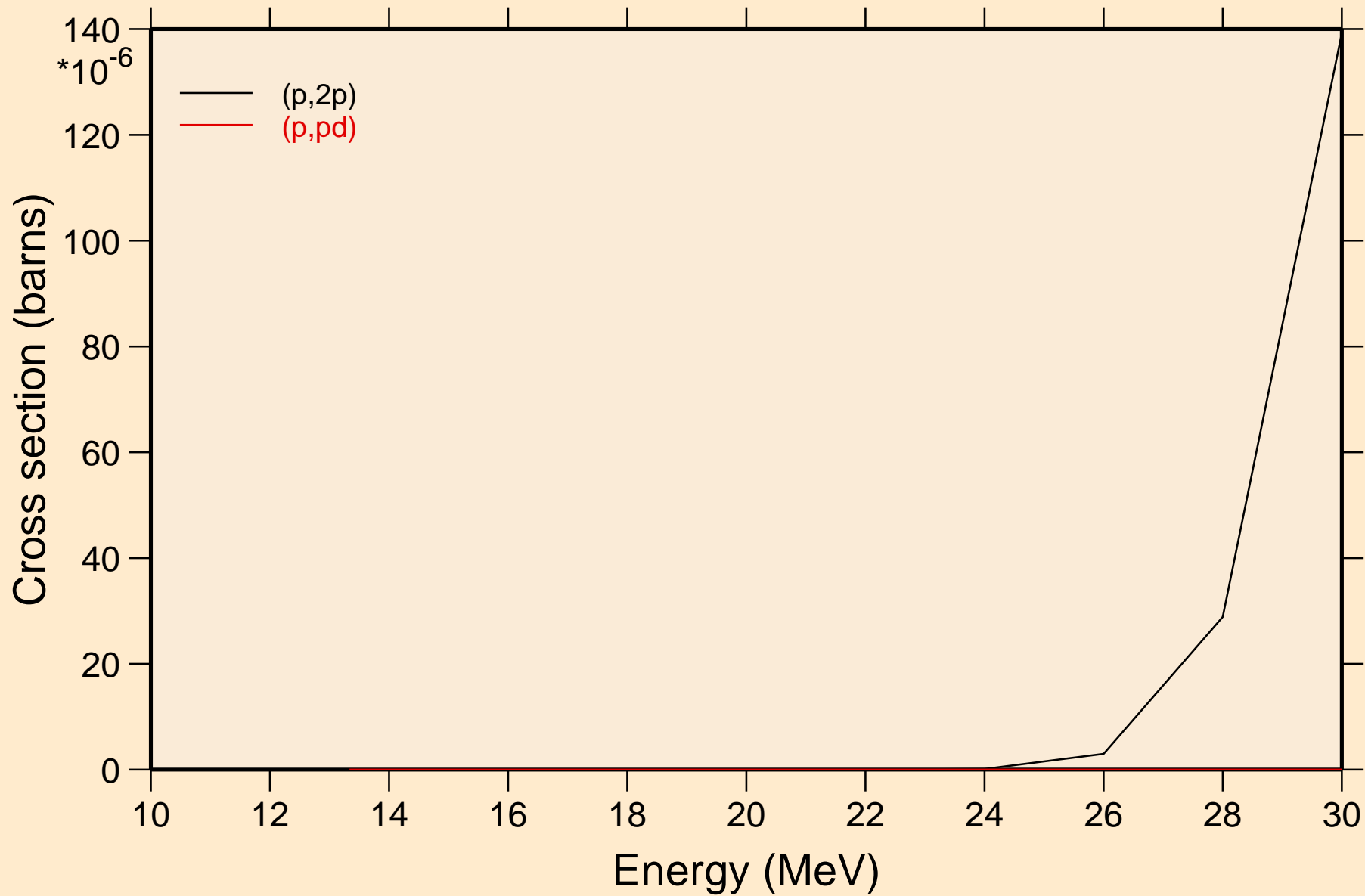

SM161 PROTON ACER TENDL-2023 LIBRARY; T=0.K
angular distribution for elastic

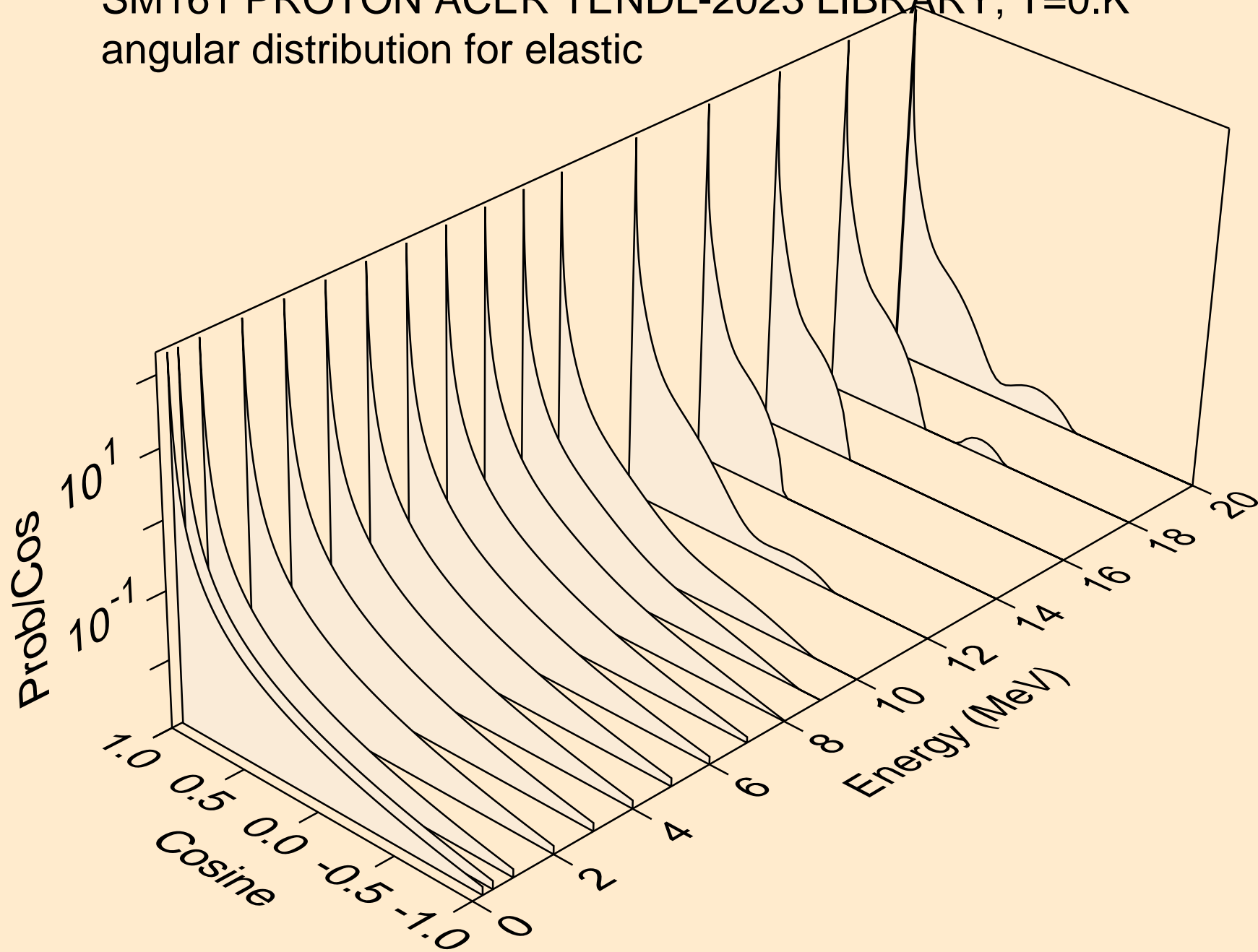

SM161 PROTON ACER TENDL-2023 LIBRARY; T=0.K
angular distribution for elastic

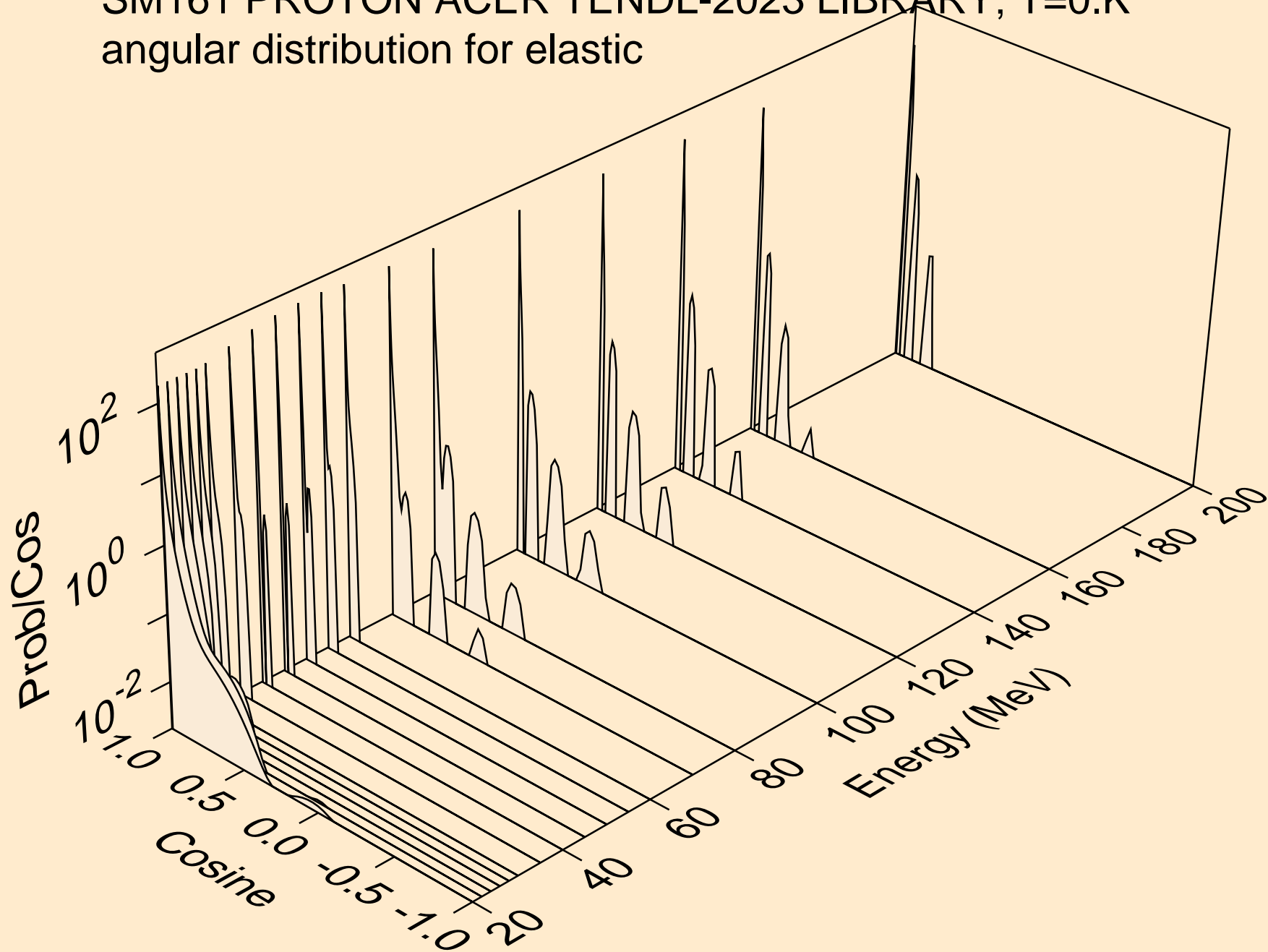

SM161 PROTON ACER TENDL-2023 LIBRARY; T=0.K
Proton emission for (p,x)

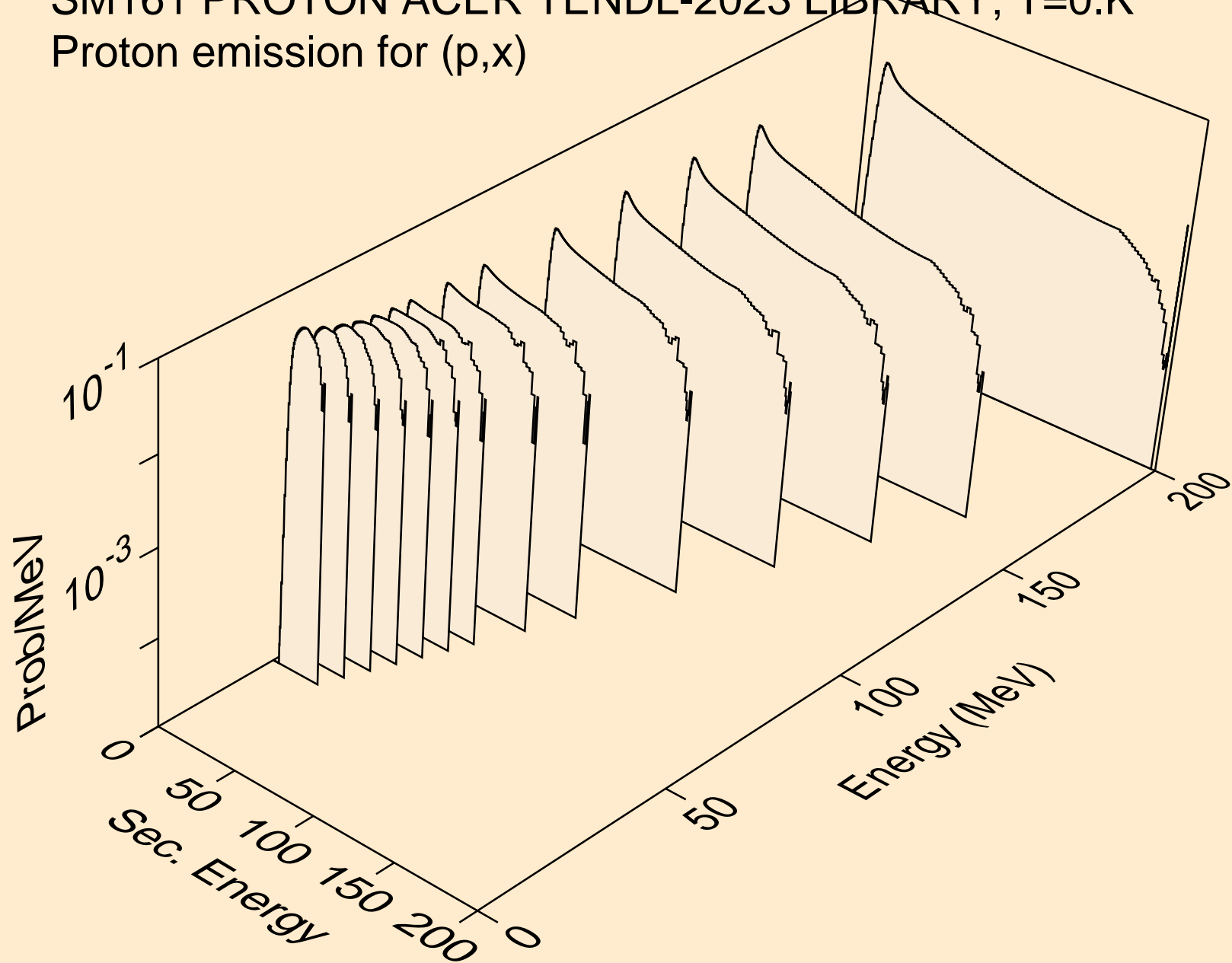

SM161 PROTON ACER TENDL-2023 LIBRARY; T=0.K
Proton emission for (p,n*)p

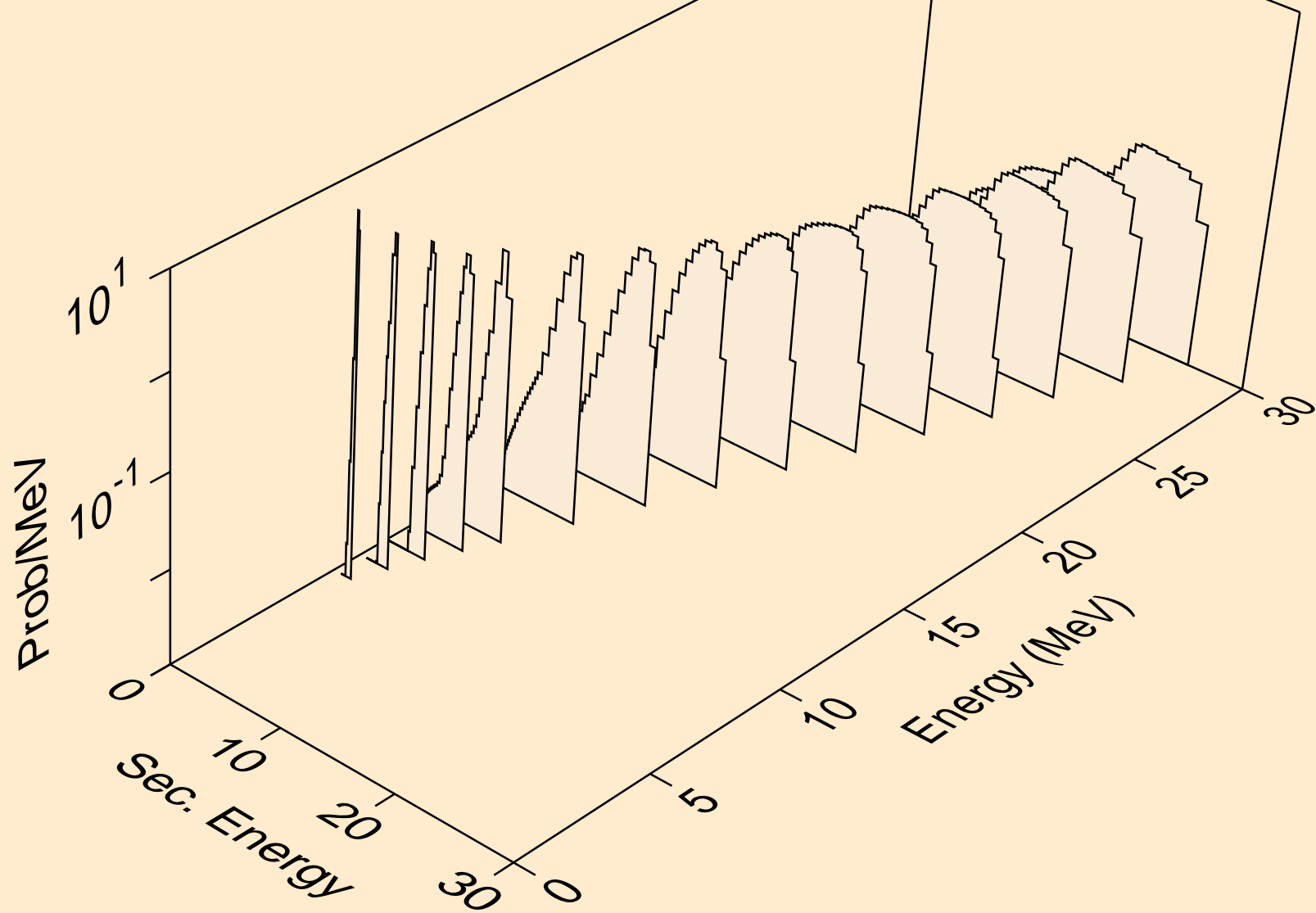

SM161 PROTON ACER TENDL-2023 LIBRARY; T=0.K
Proton emission for (p,2np)

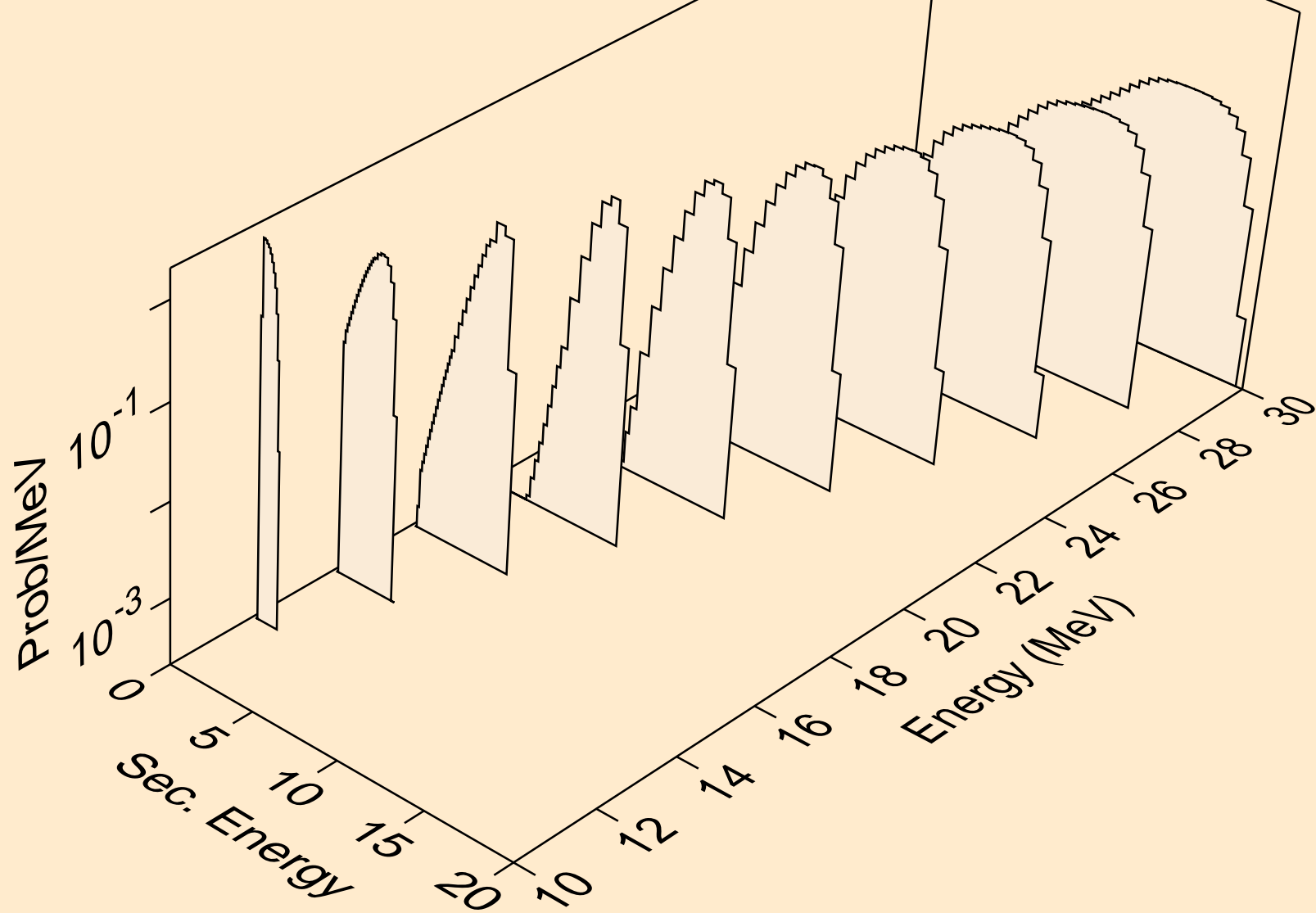

SM161 PROTON ACER TENDL-2023 LIBRARY; T=0.K
Proton emission for (p,3np)

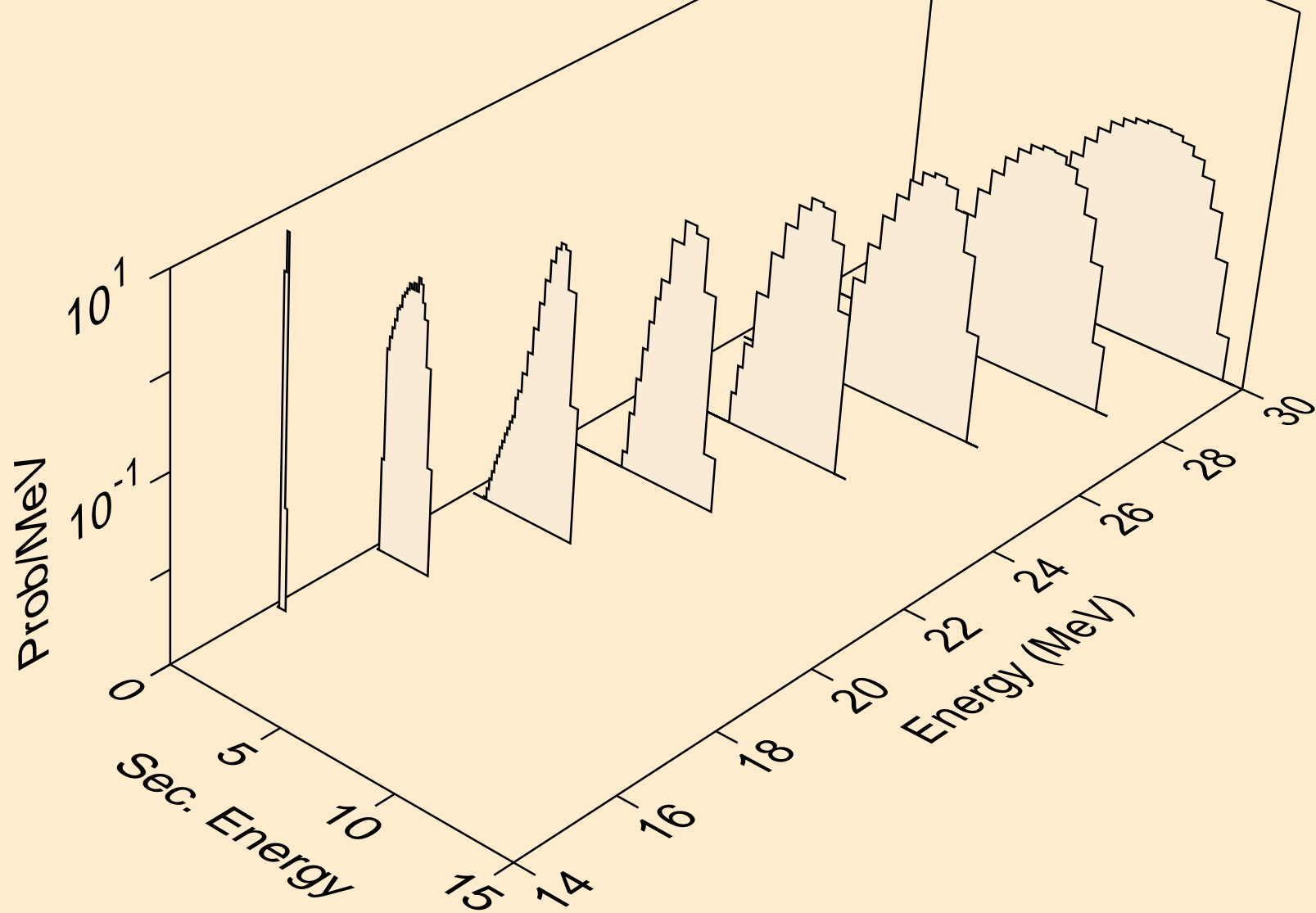

SM161 PROTON ACER TENDL-2023 LIBRARY; T=0.K
Proton emission for (p,n2p)

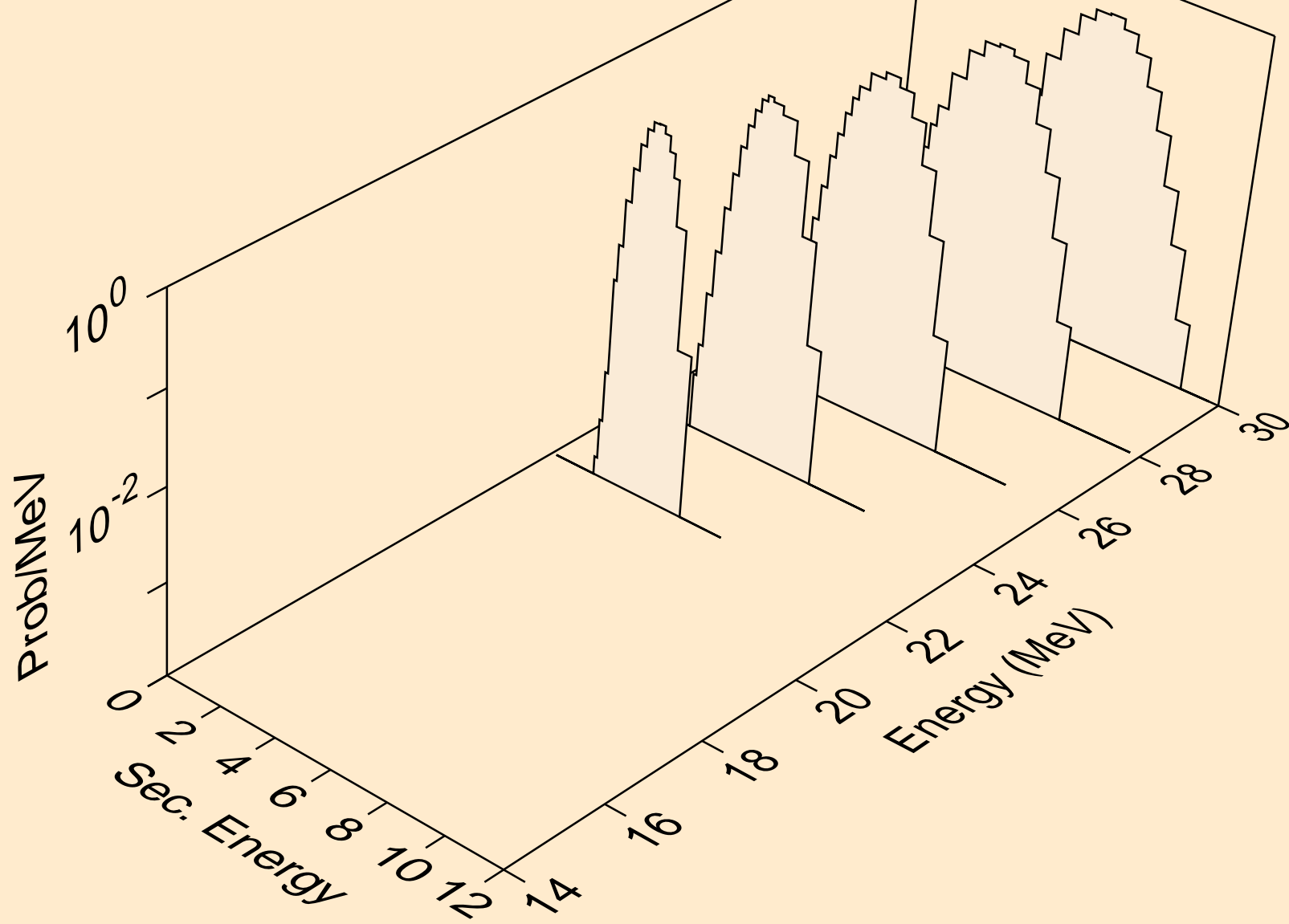

SM161 PROTON ACER TENDL-2023 LIBRARY; T=0.K
Proton emission for inelastic

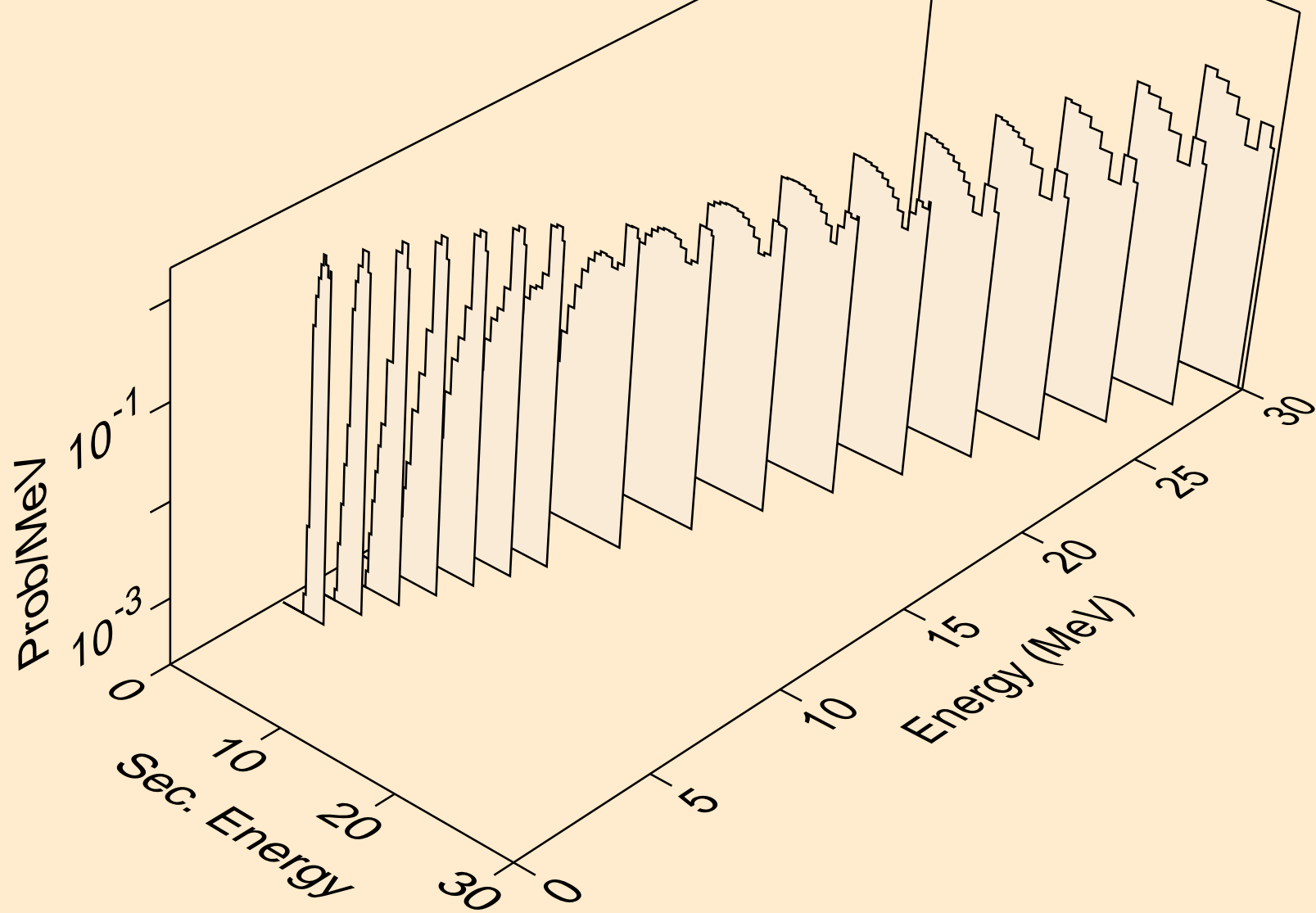

SM161 PROTON ACER TENDL-2023 LIBRARY; T=0.K
Proton emission for (p,2p)

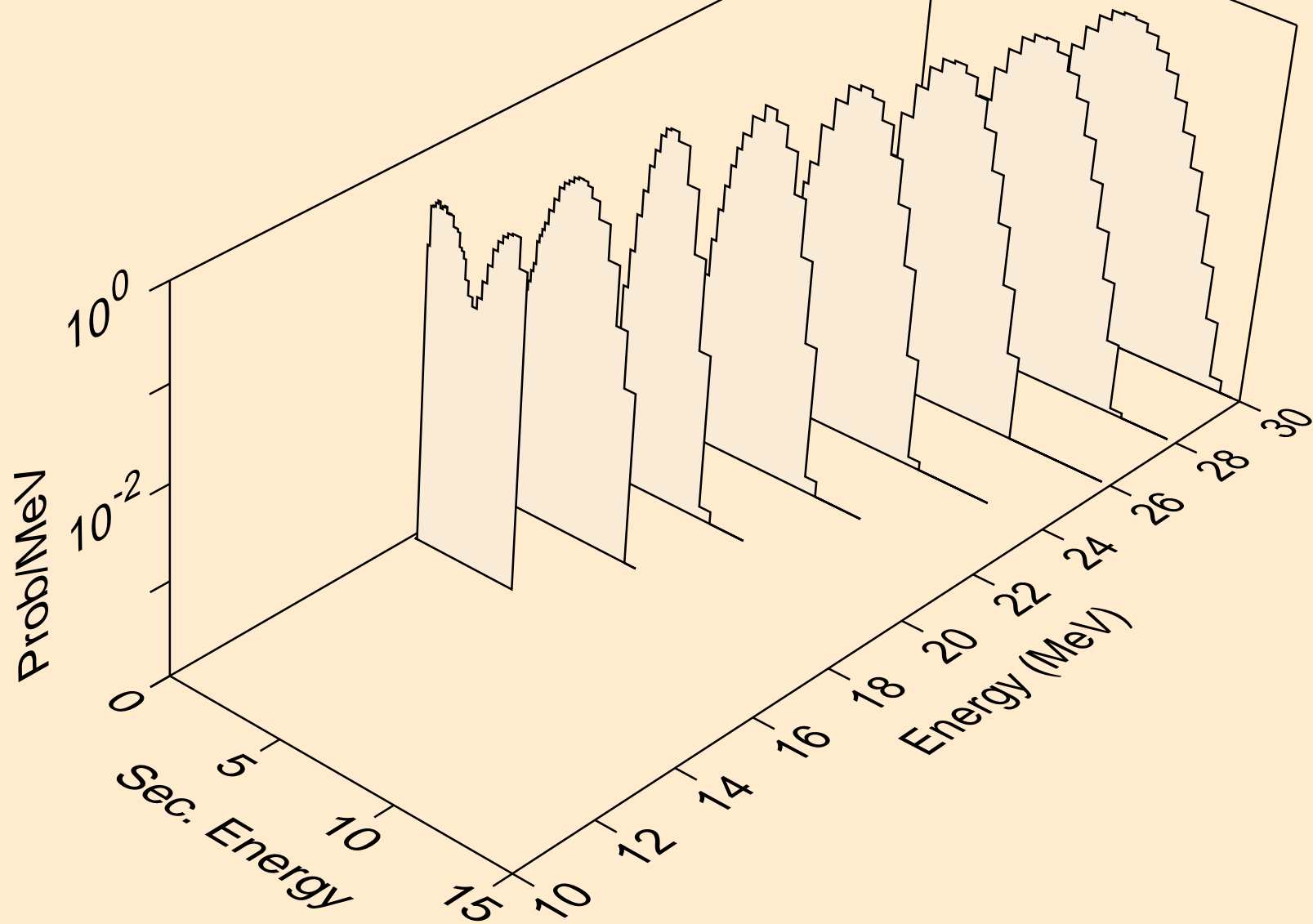

SM161 PROTON ACER TENDL-2023 LIBRARY; T=0.K
Proton emission for (p,pd)

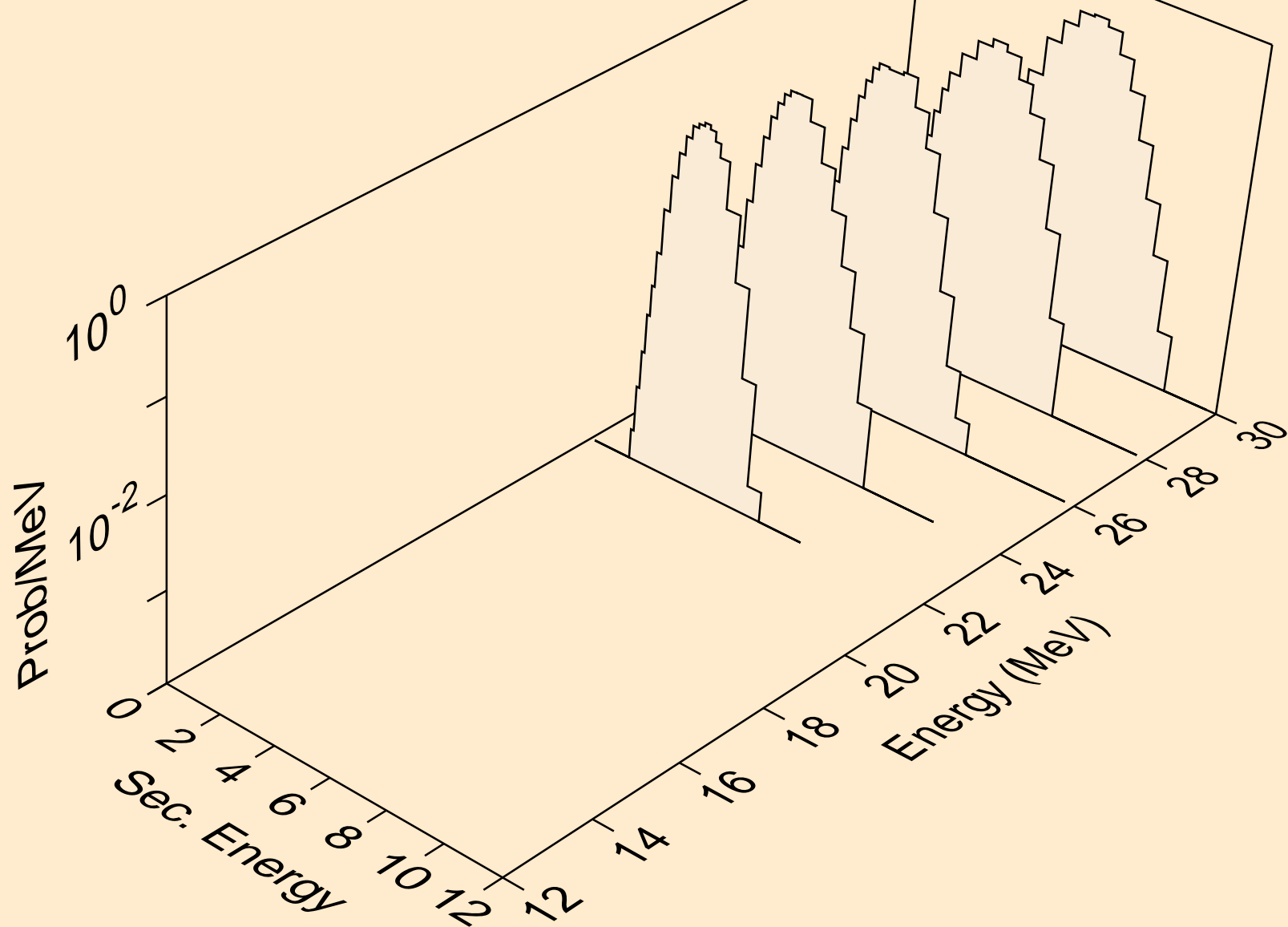

SM161 PROTON ACER TENDL-2023 LIBRARY; T=0.K
Photon emission for (z,n)

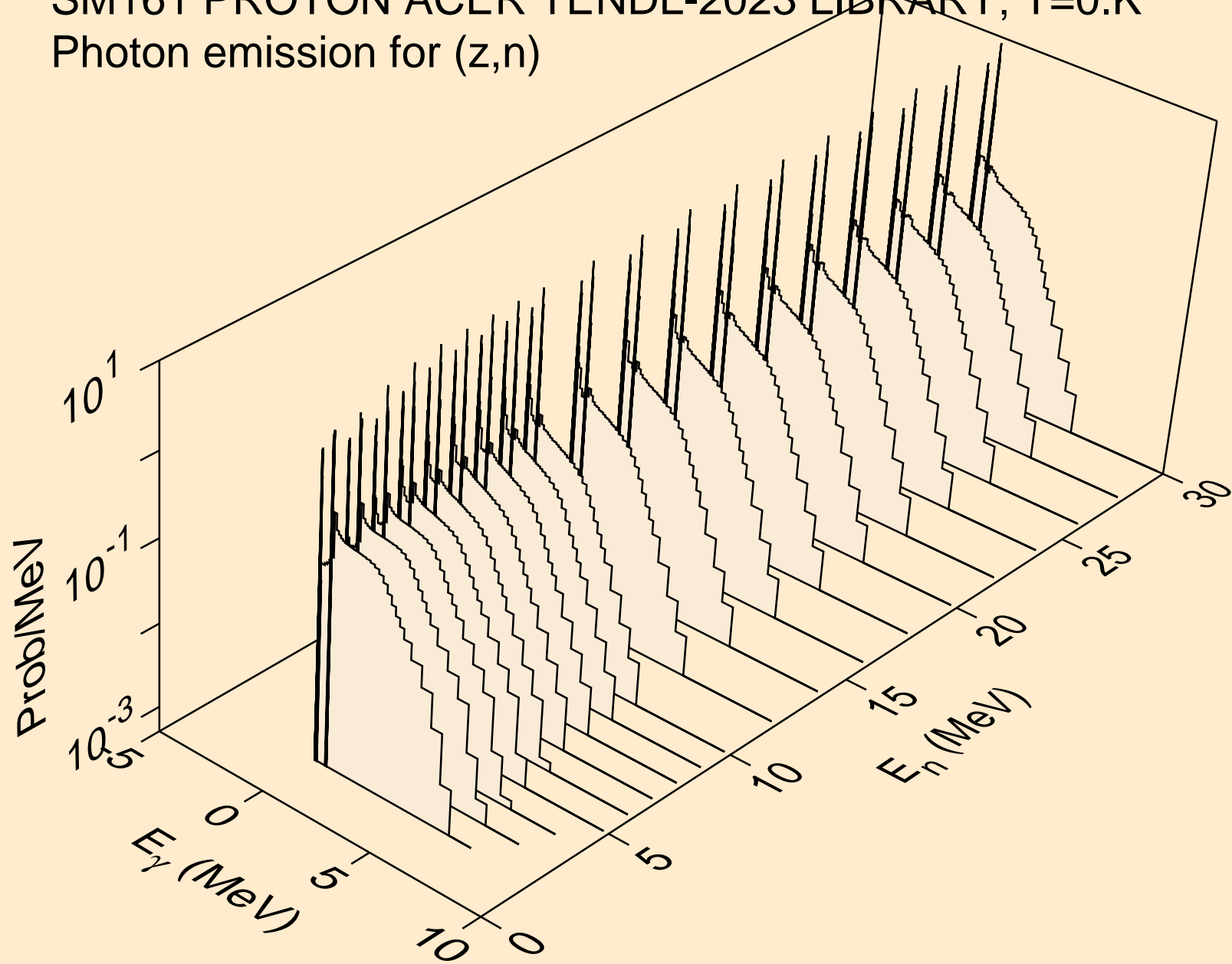

SM161 PROTON ACER TENDL-2023 LIBRARY; T=0.K
Photon emission for (z,x)

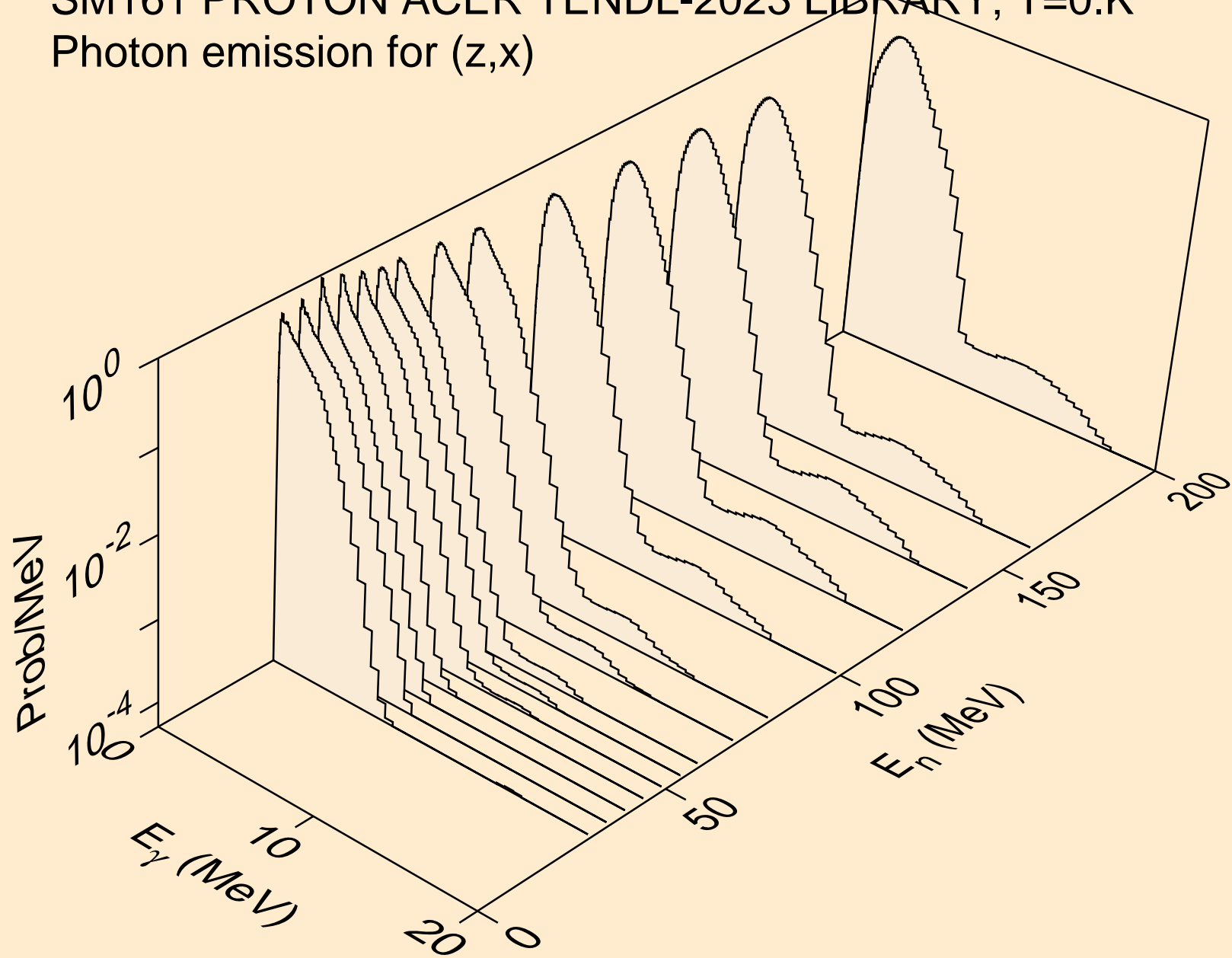

SM161 PROTON ACER TENDL-2023 LIBRARY; T=0.K
Photon emission for (n,2nd)

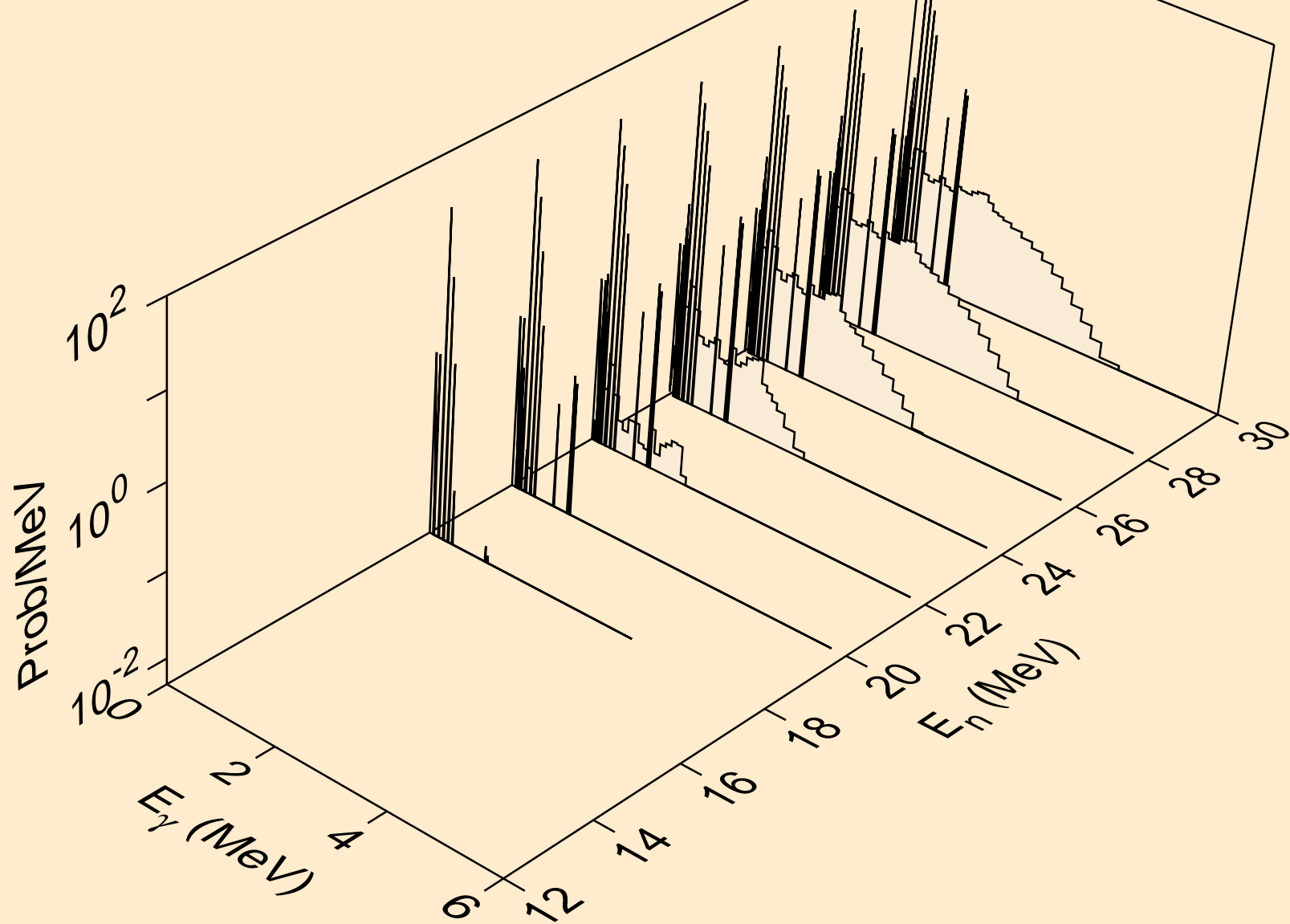

SM161 PROTON ACER TENDL-2023 LIBRARY; T=0.K
Photon emission for (n,2n)

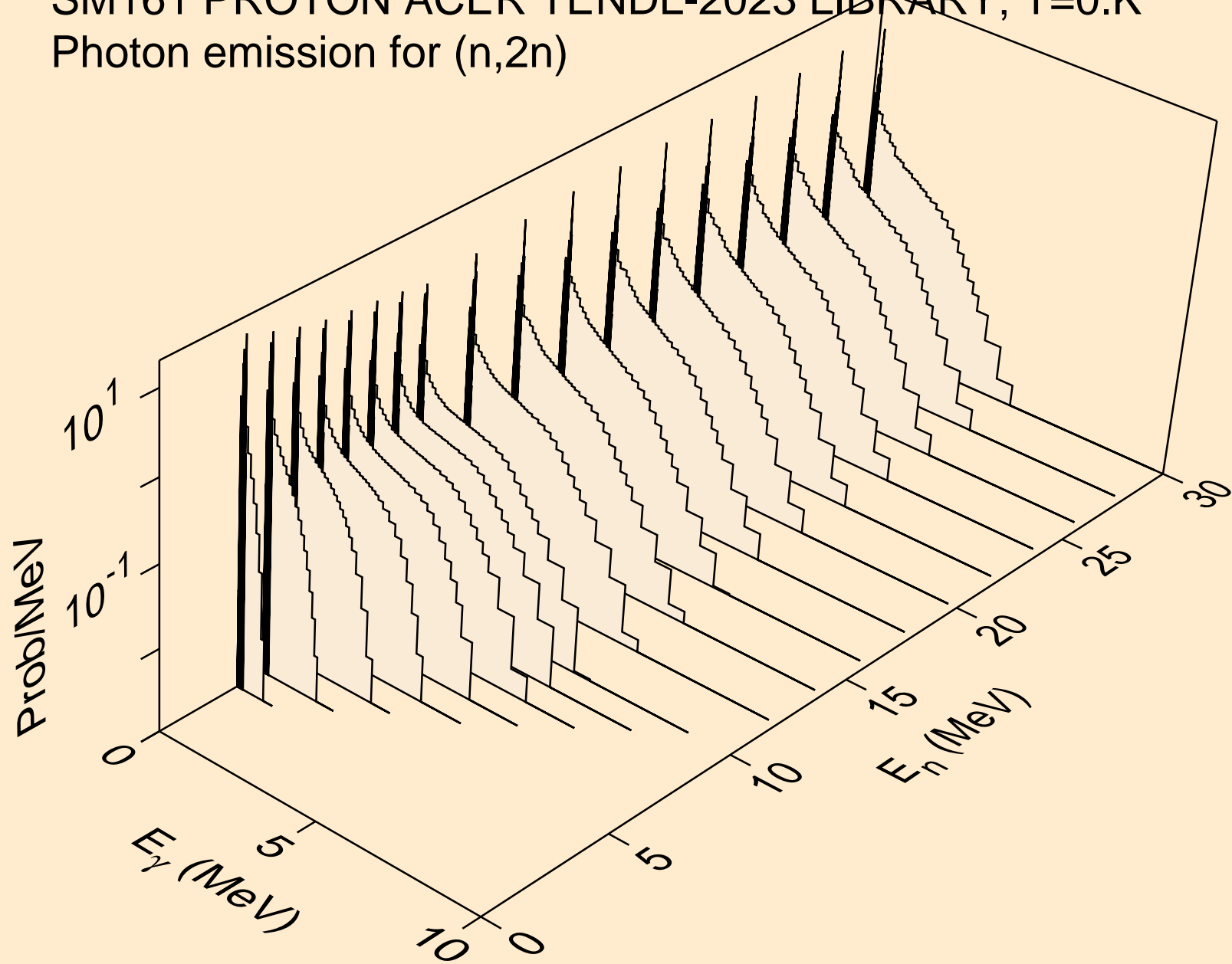

SM161 PROTON ACER TENDL-2023 LIBRARY; T=0.K
Photon emission for (n,3n)

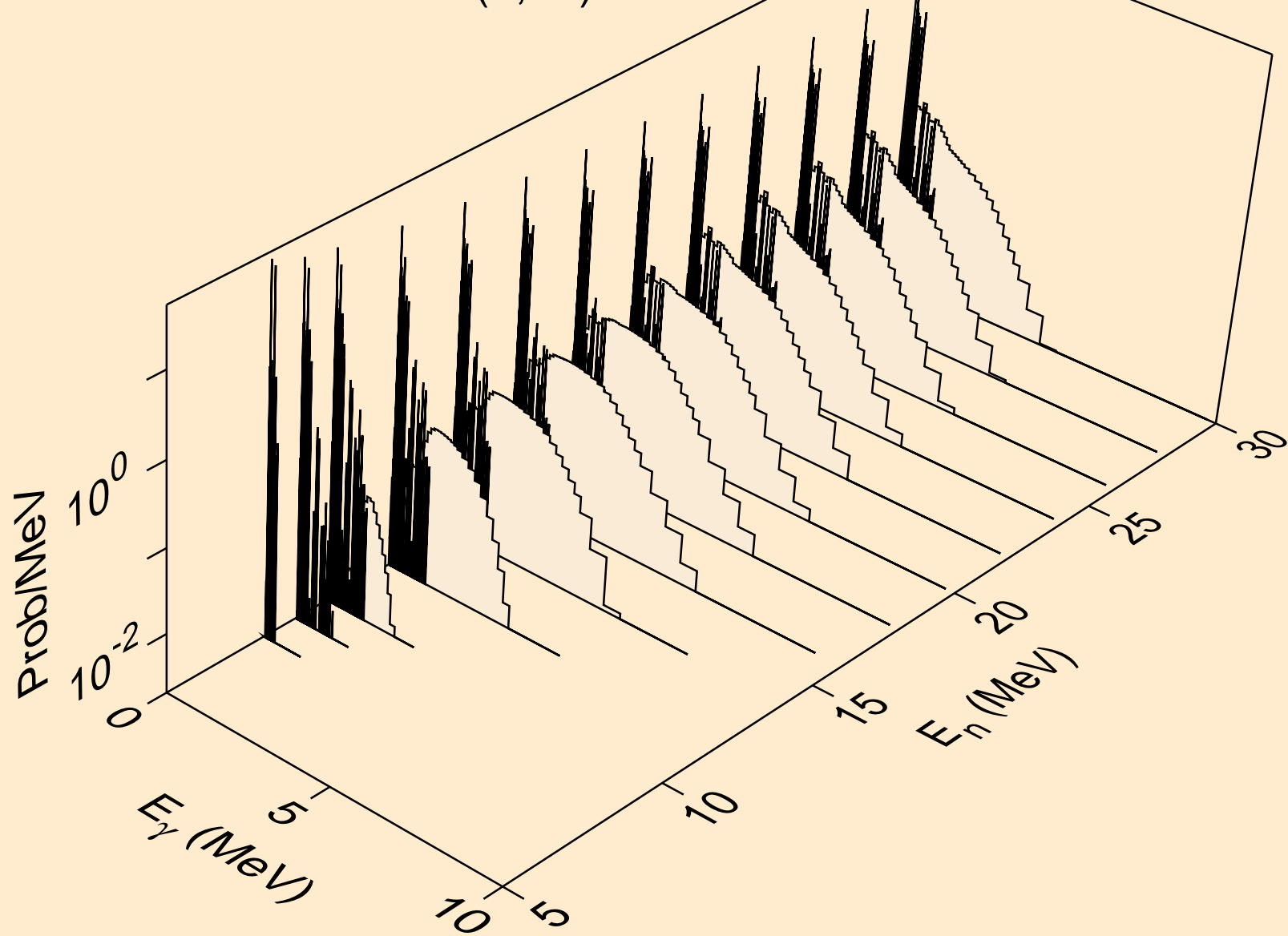

SM161 PROTON ACER TENDL-2023 LIBRARY; T=0.K
Photon emission for (n,n*)a

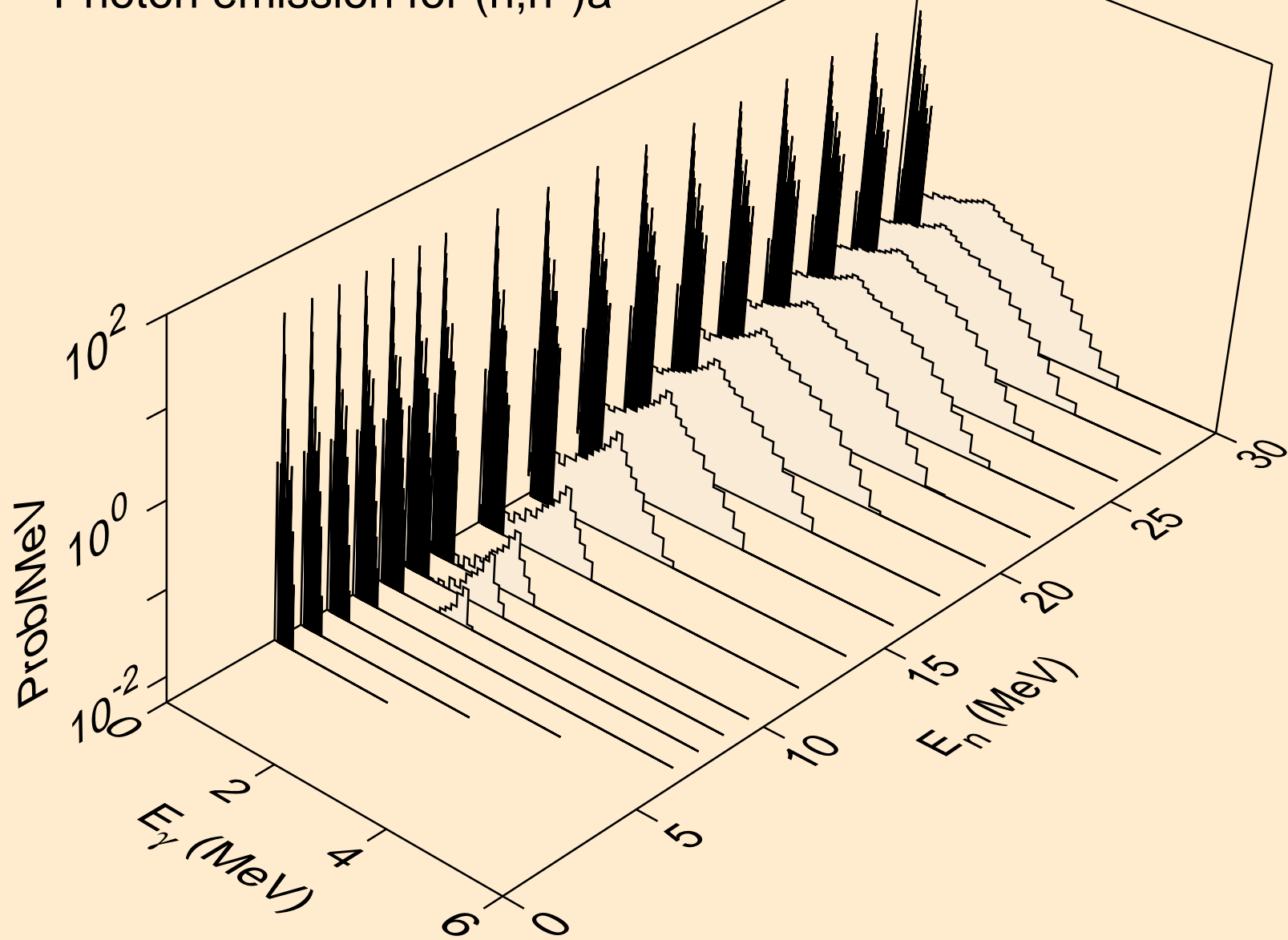

SM161 PROTON ACER TENDL-2023 LIBRARY; T=0.K
Photon emission for (n,2n)a

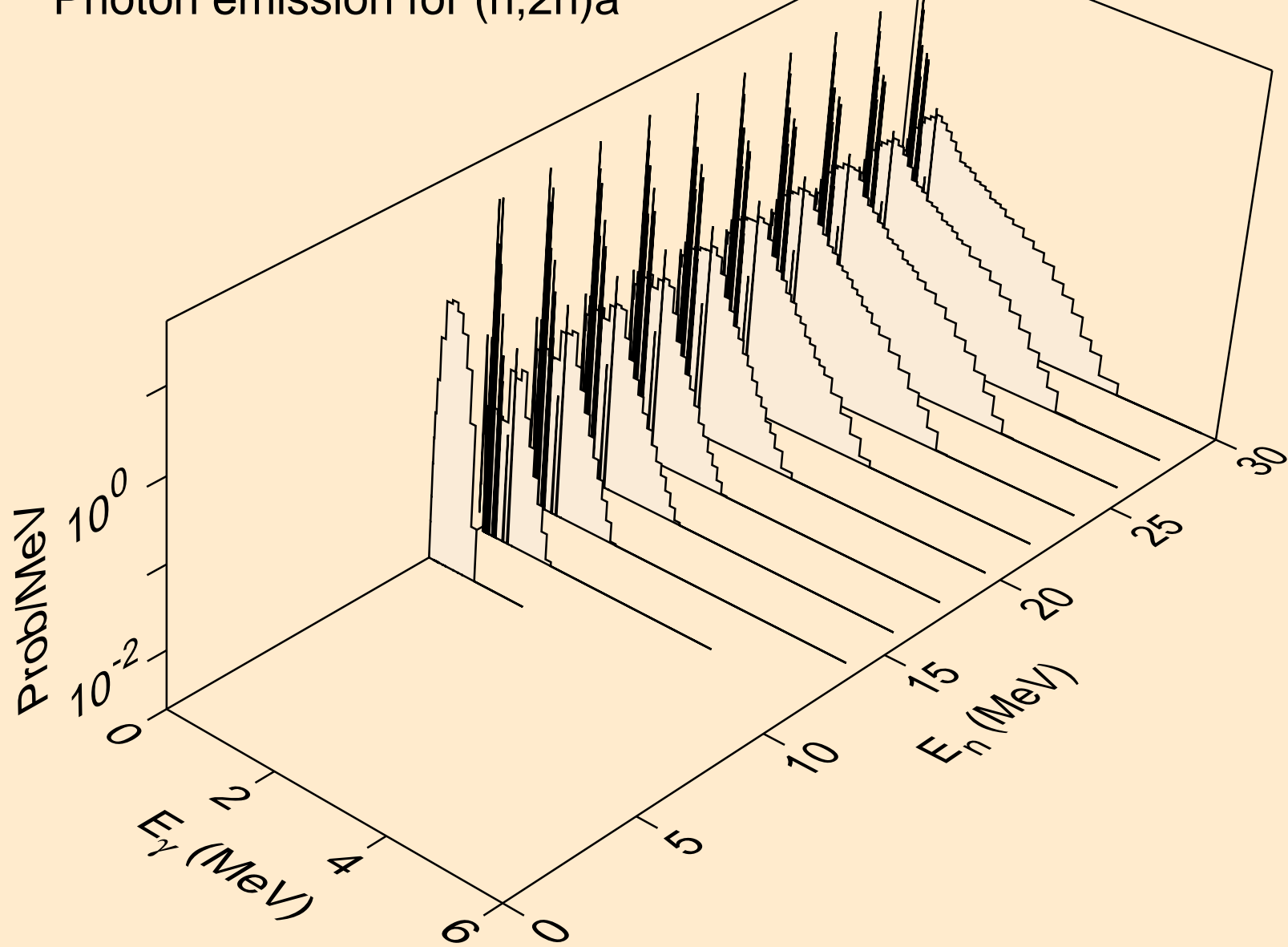

SM161 PROTON ACER TENDL-2023 LIBRARY; T=0.K
Photon emission for (n,3n)a

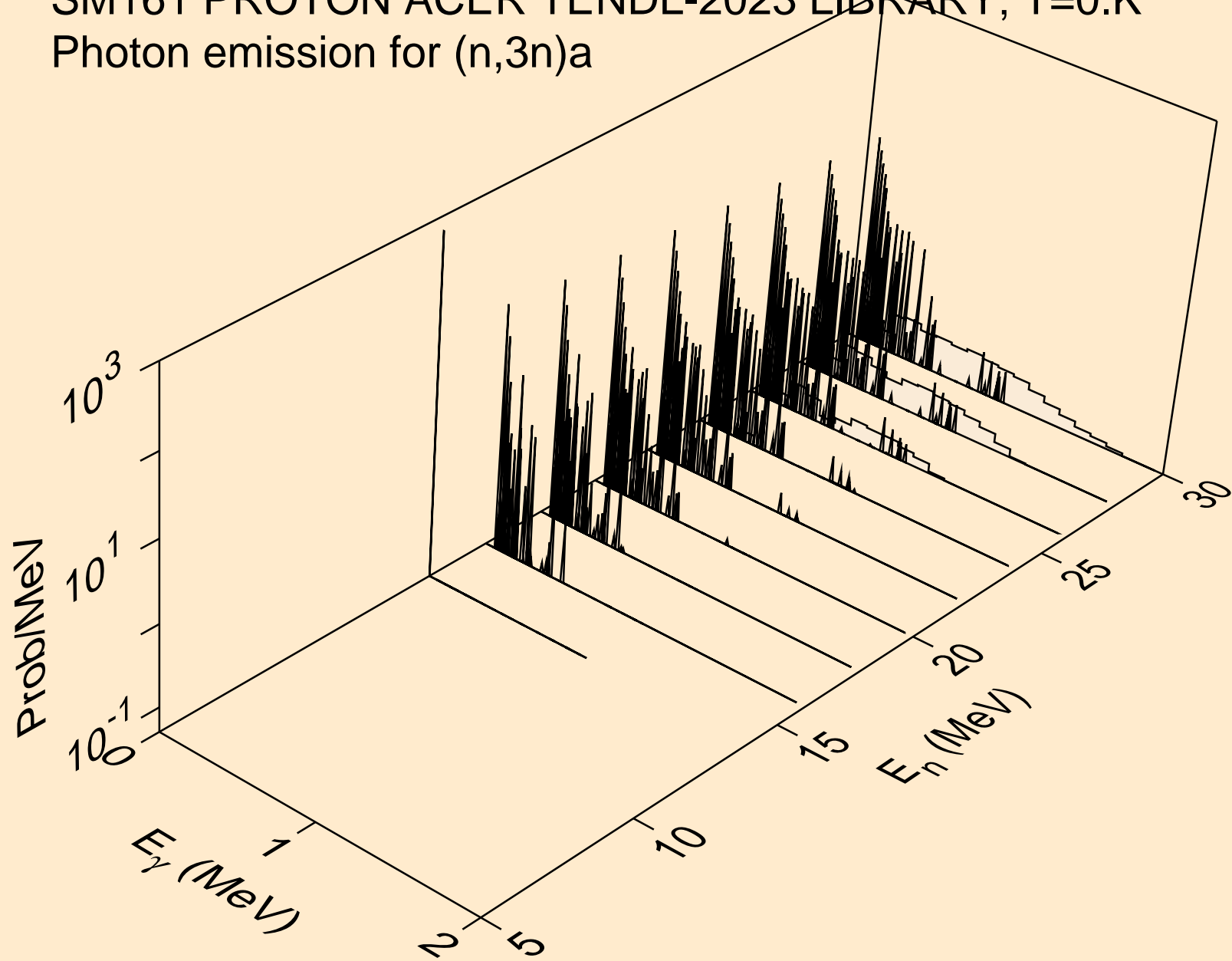

SM161 PROTON ACER TENDL-2023 LIBRARY; T=0.K
Photon emission for (n,n*)p

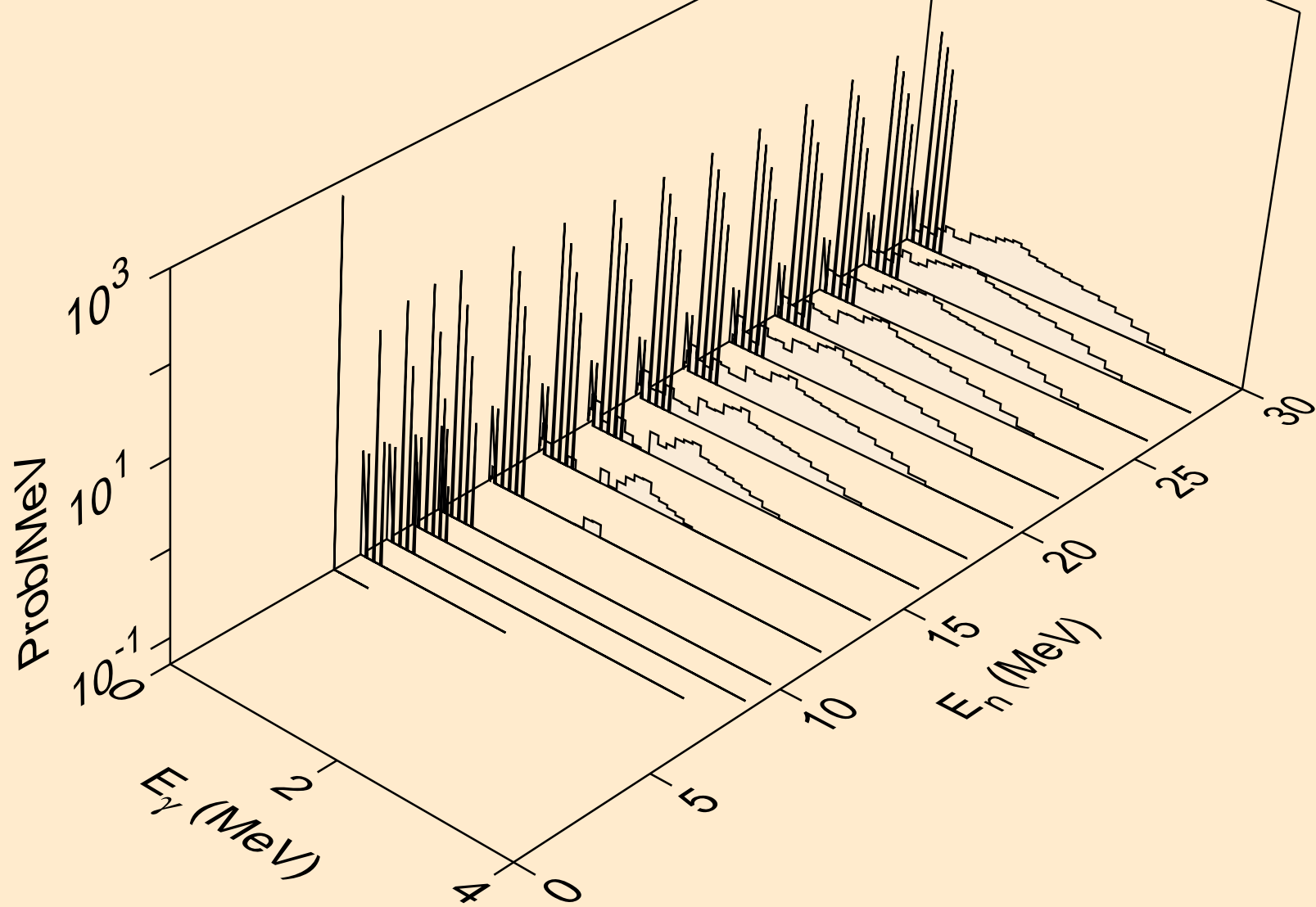

SM161 PROTON ACER TENDL-2023 LIBRARY; T=0.K
Photon emission for (n,n*)d

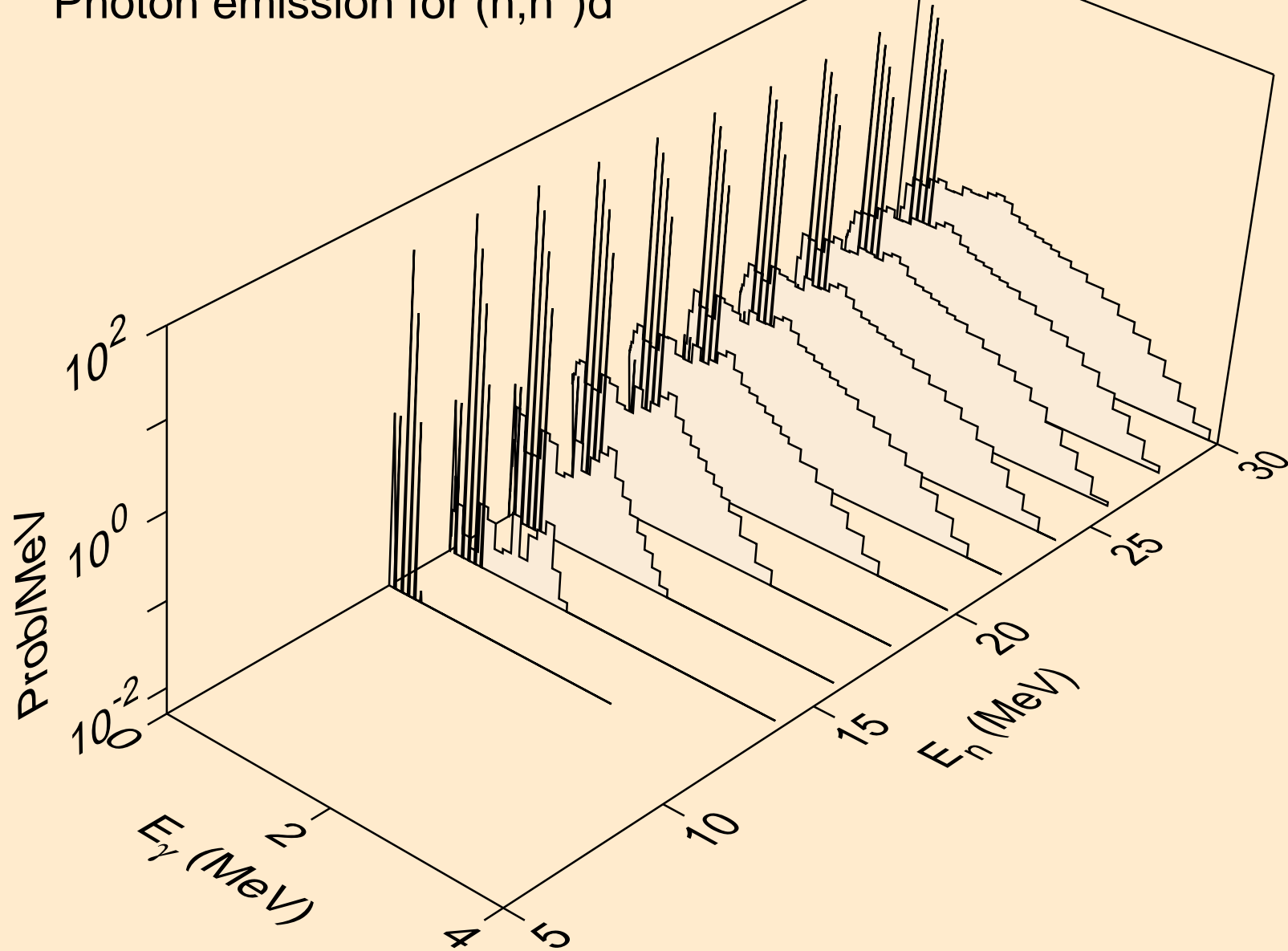

SM161 PROTON ACER TENDL-2023 LIBRARY; T=0.K
Photon emission for (n,n*)t

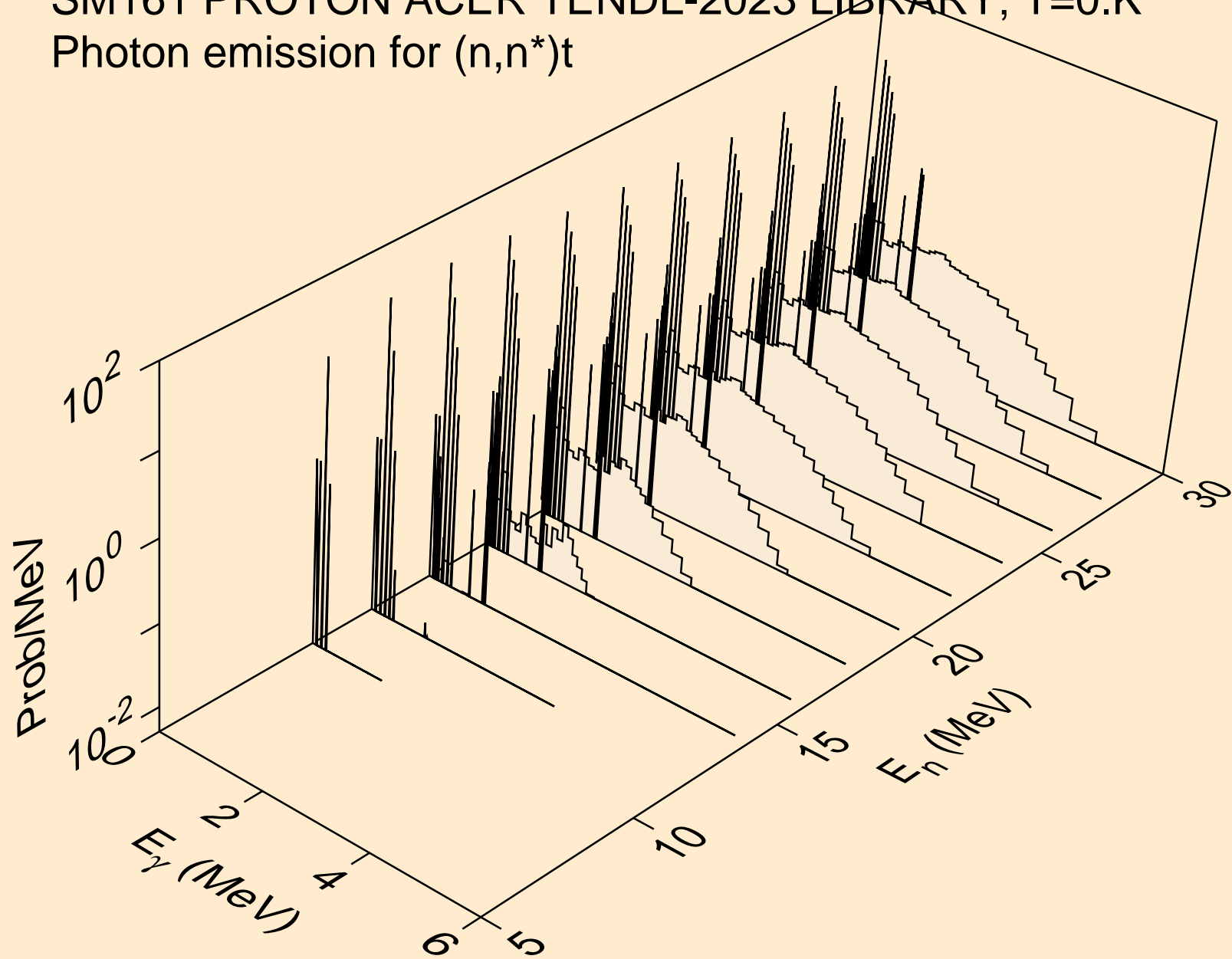

SM161 PROTON ACER TENDL-2023 LIBRARY; T=0.K
Photon emission for (n,n*)he3

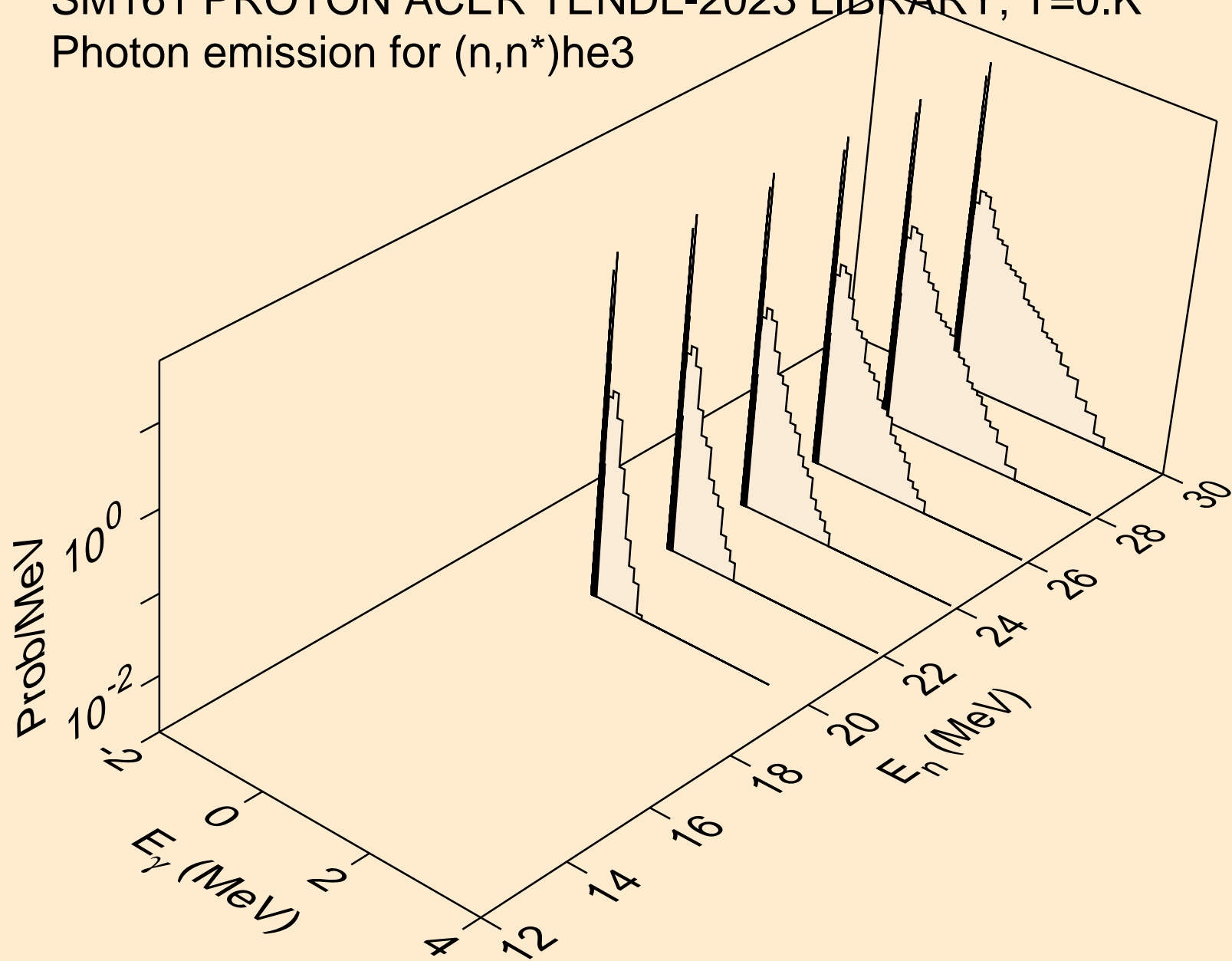

SM161 PROTON ACER TENDL-2023 LIBRARY; T=0.K
Photon emission for (n,4n)

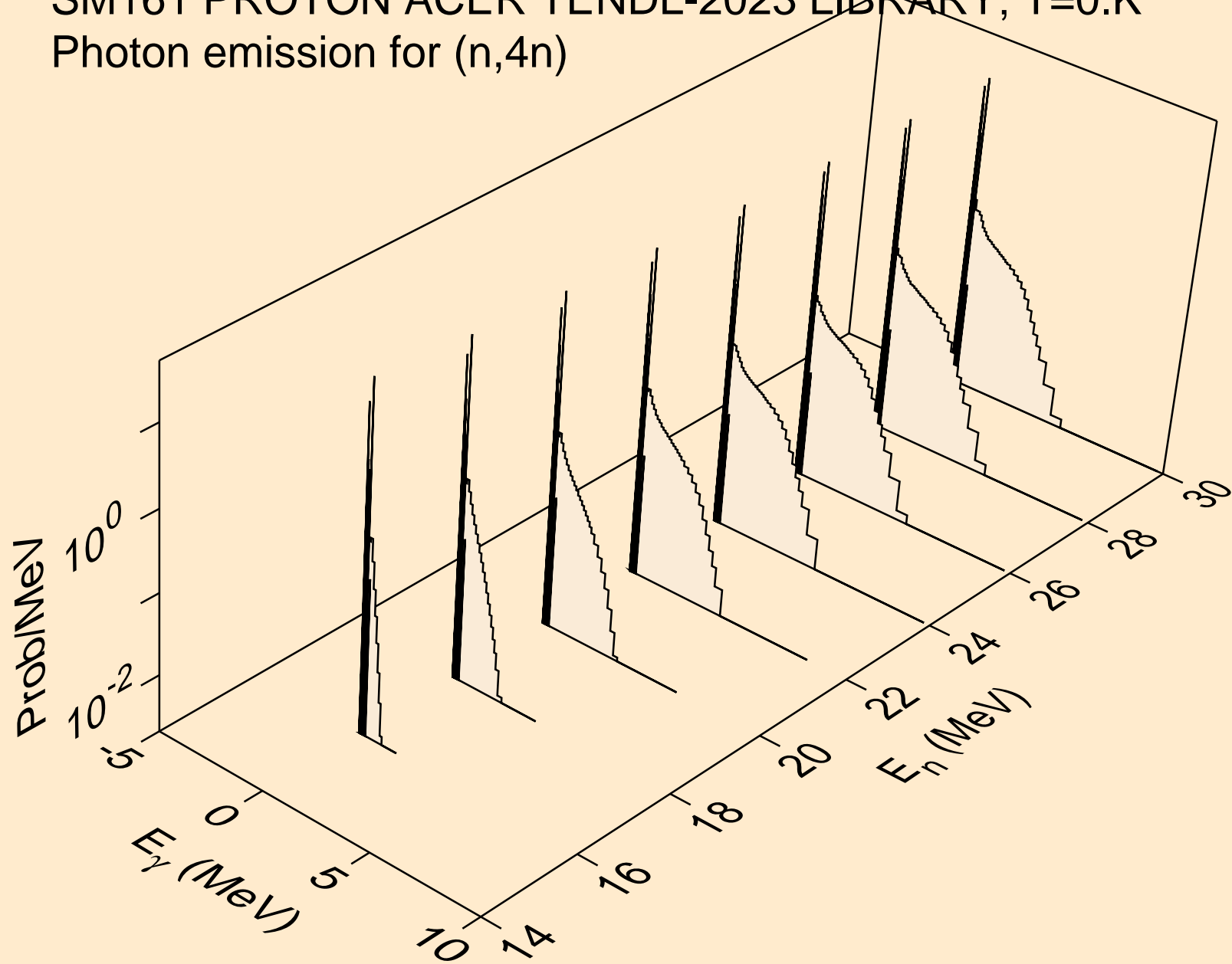

SM161 PROTON ACER TENDL-2023 LIBRARY; T=0.K
Photon emission for (n,2np)

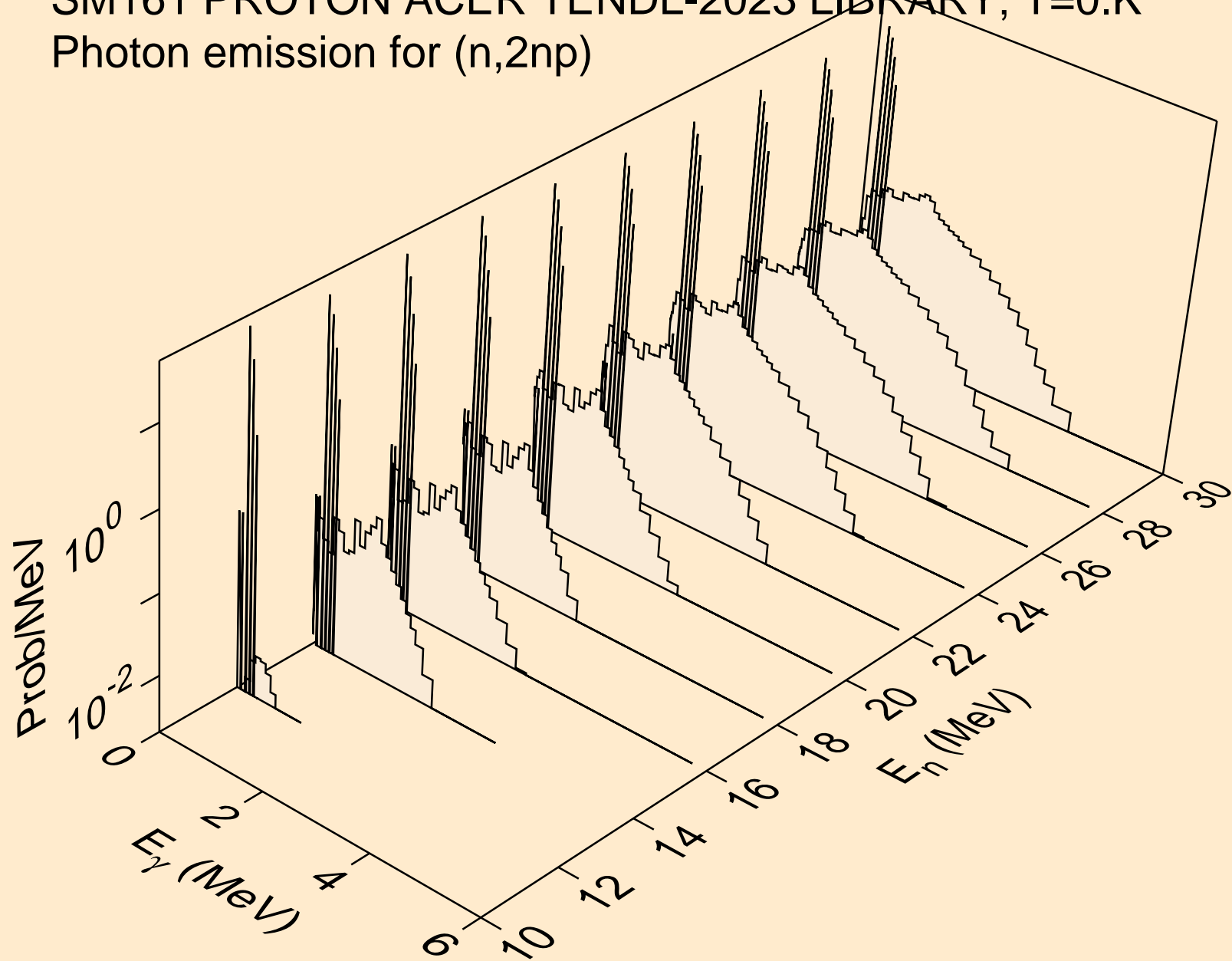

SM161 PROTON ACER TENDL-2023 LIBRARY; T=0.K
Photon emission for (n,3np)

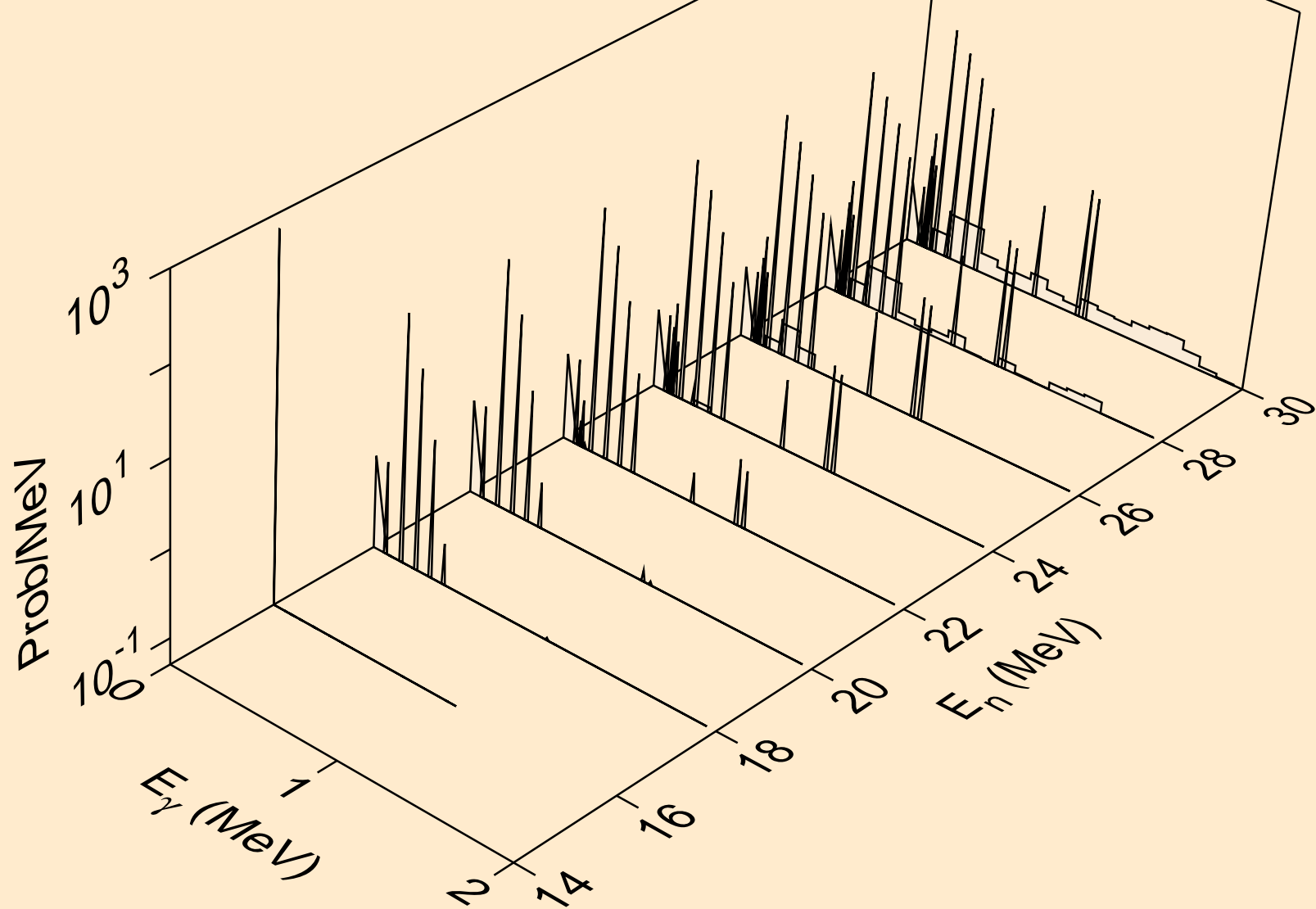

SM161 PROTON ACER TENDL-2023 LIBRARY; T=0.K
Photon emission for (n,n2p)

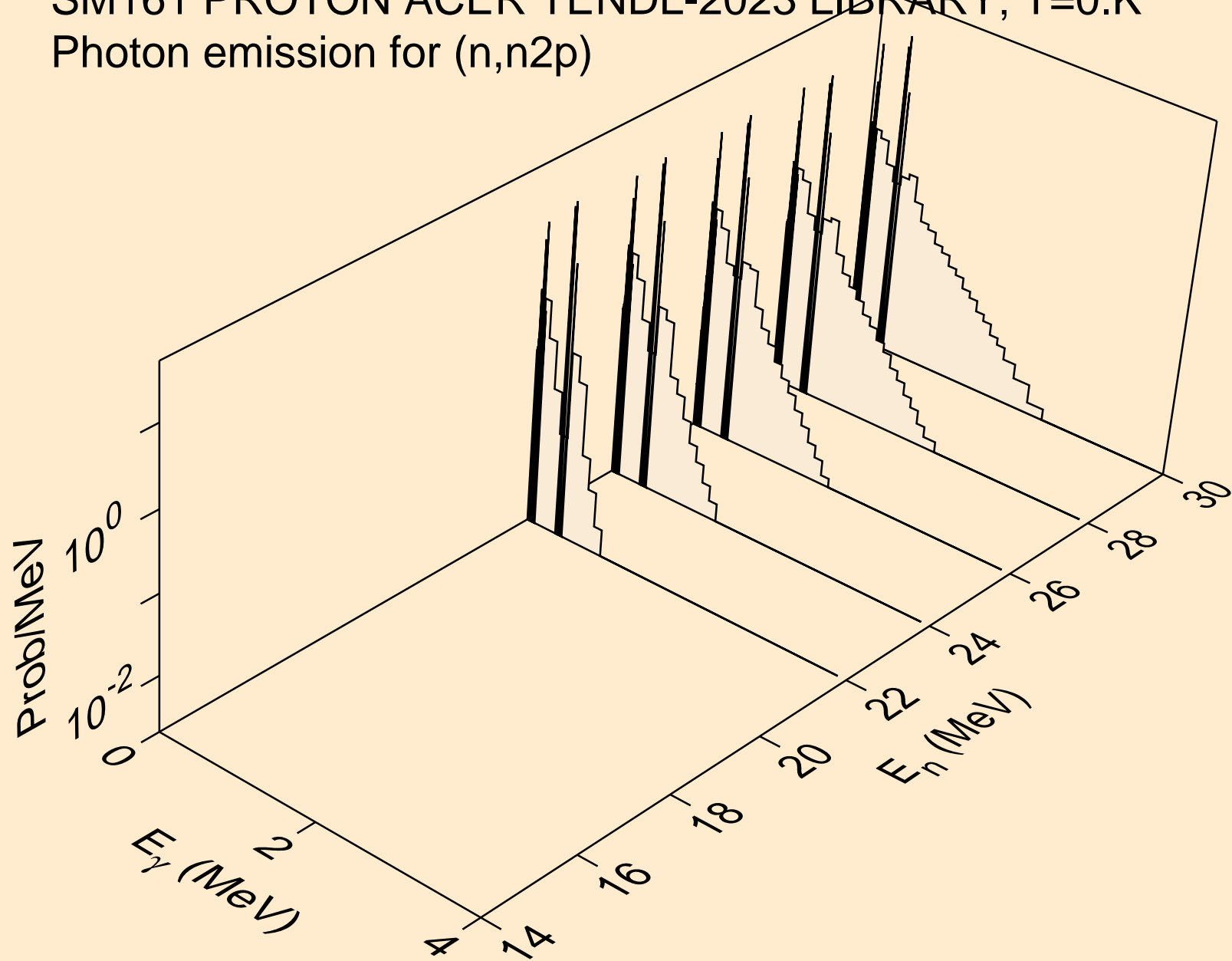

SM161 PROTON ACER TENDL-2023 LIBRARY; T=0.K
Photon emission for (n,gma)

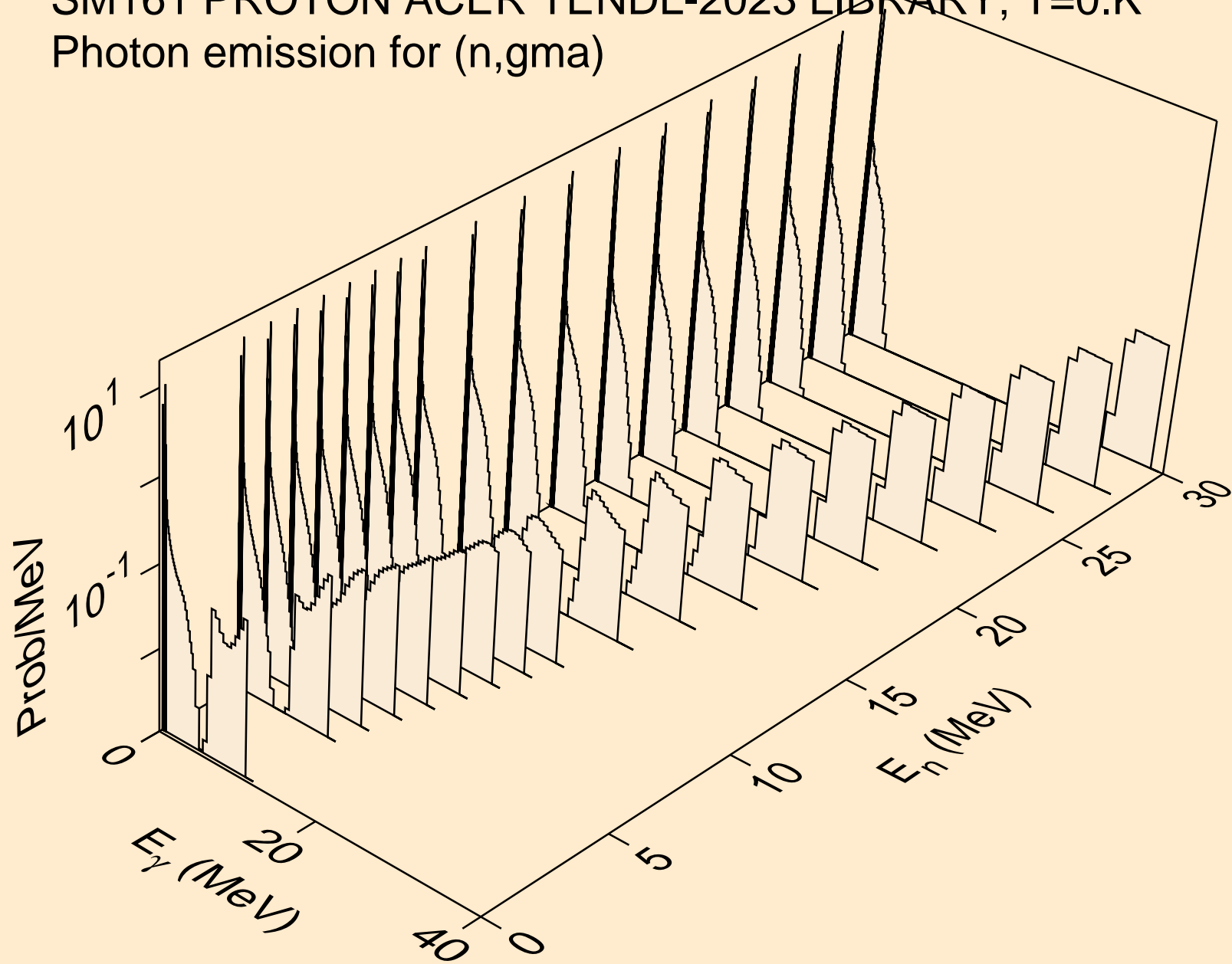

SM161 PROTON ACER TENDL-2023 LIBRARY; T=0.K
Photon emission for inelastic

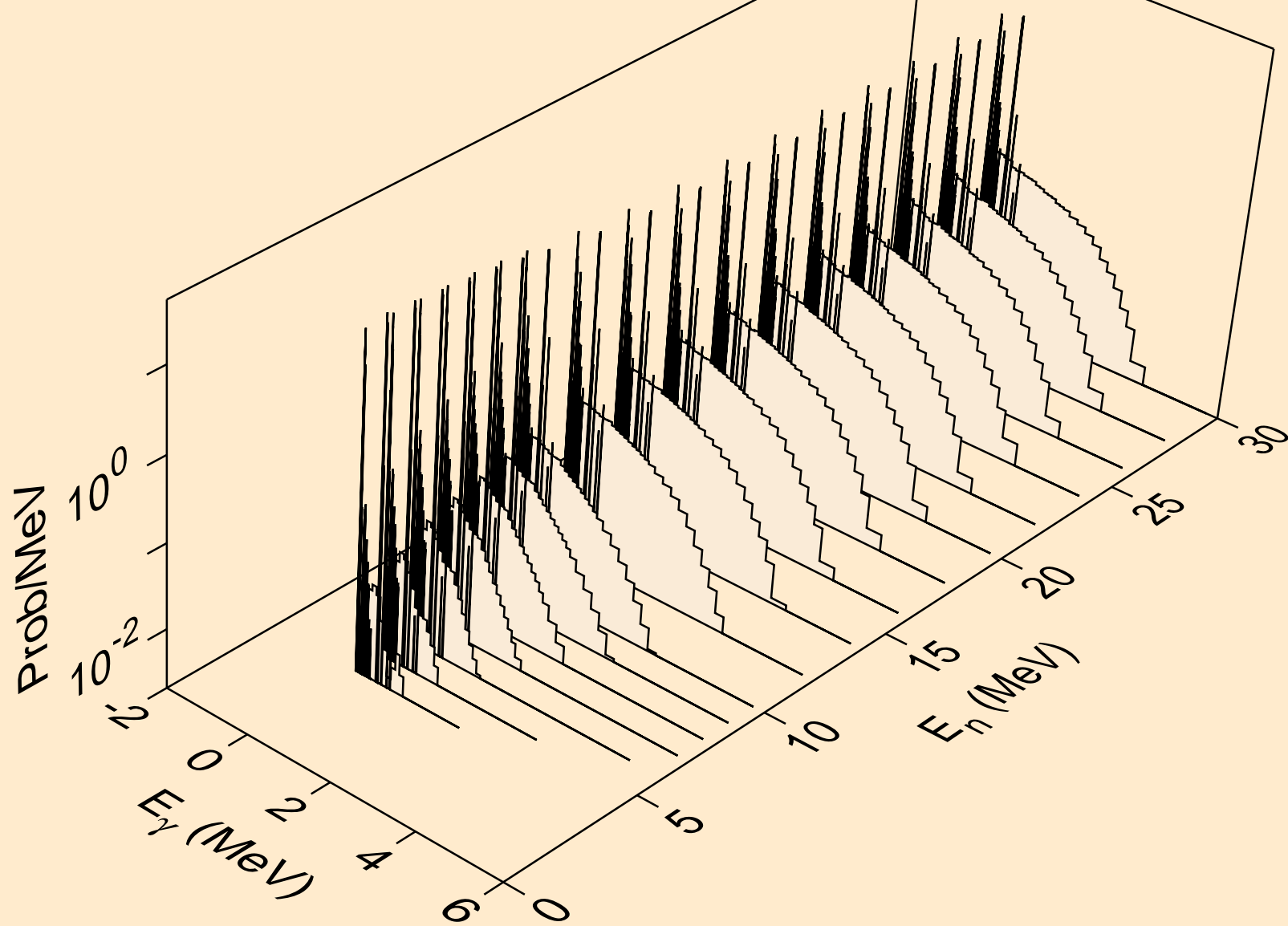

SM161 PROTON ACER TENDL-2023 LIBRARY; T=0.K
Photon emission for (n,d)

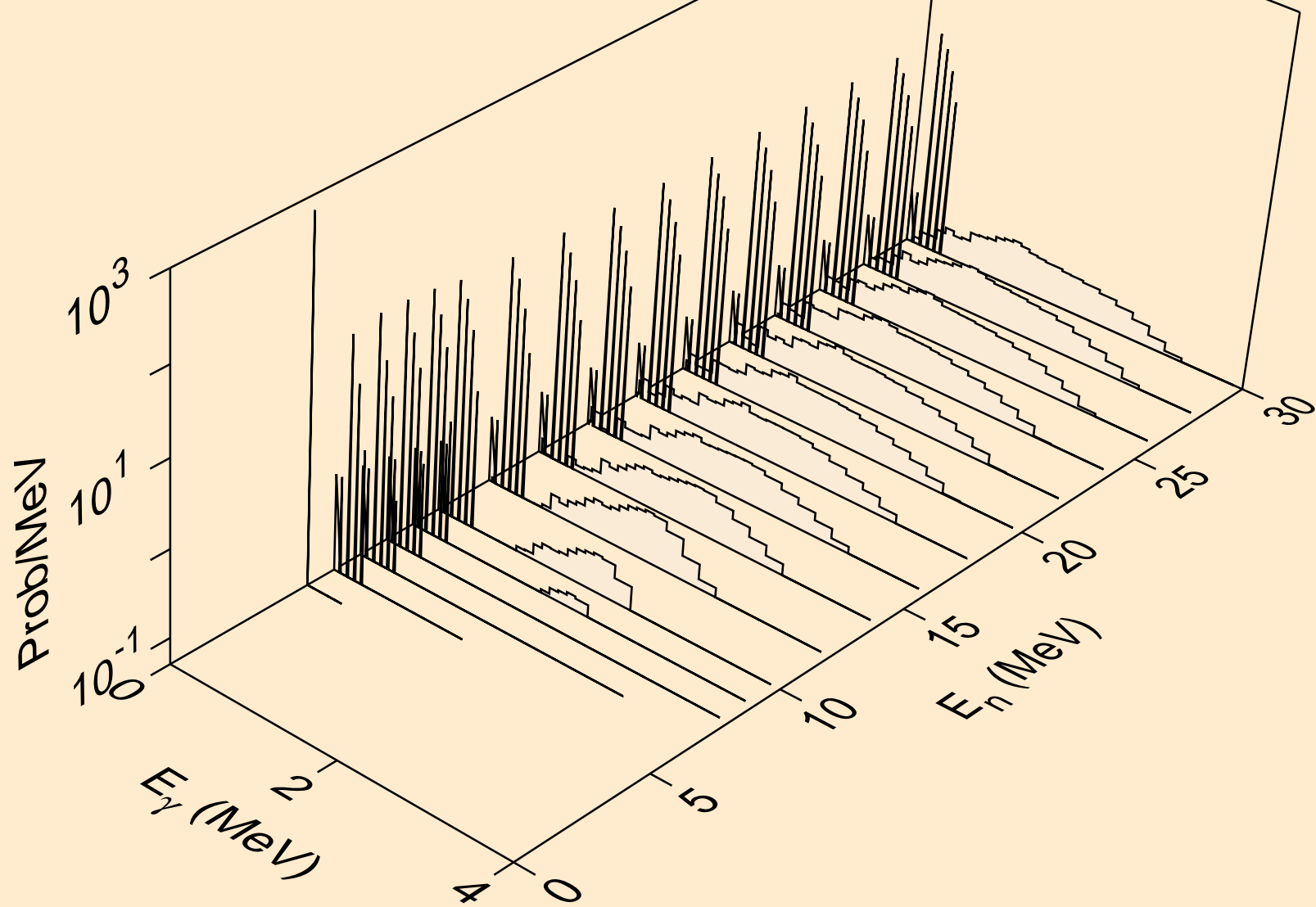

SM161 PROTON ACER TENDL-2023 LIBRARY; T=0.K
Photon emission for (n,t)

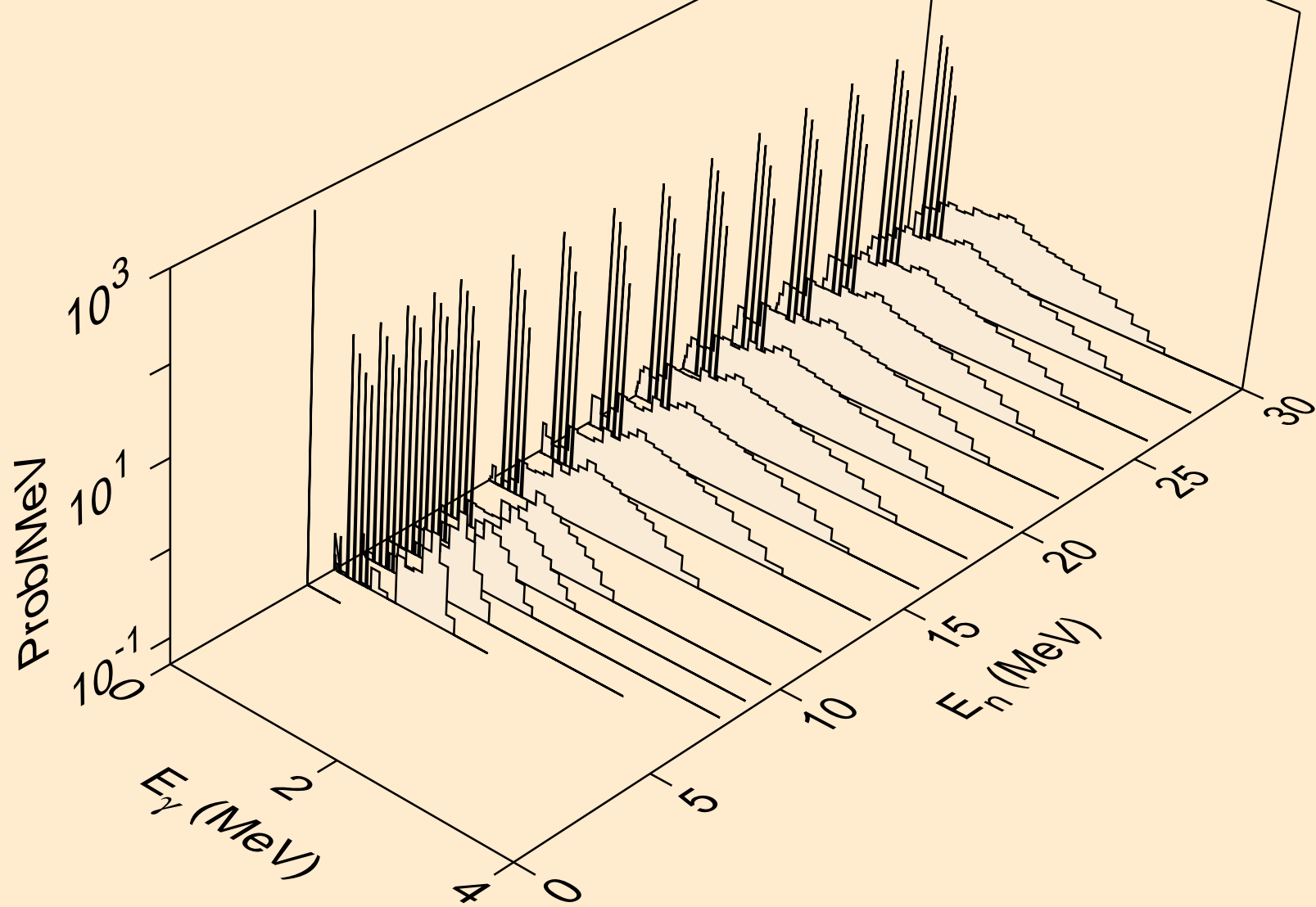

SM161 PROTON ACER TENDL-2023 LIBRARY; T=0.K
Photon emission for (n,he3)

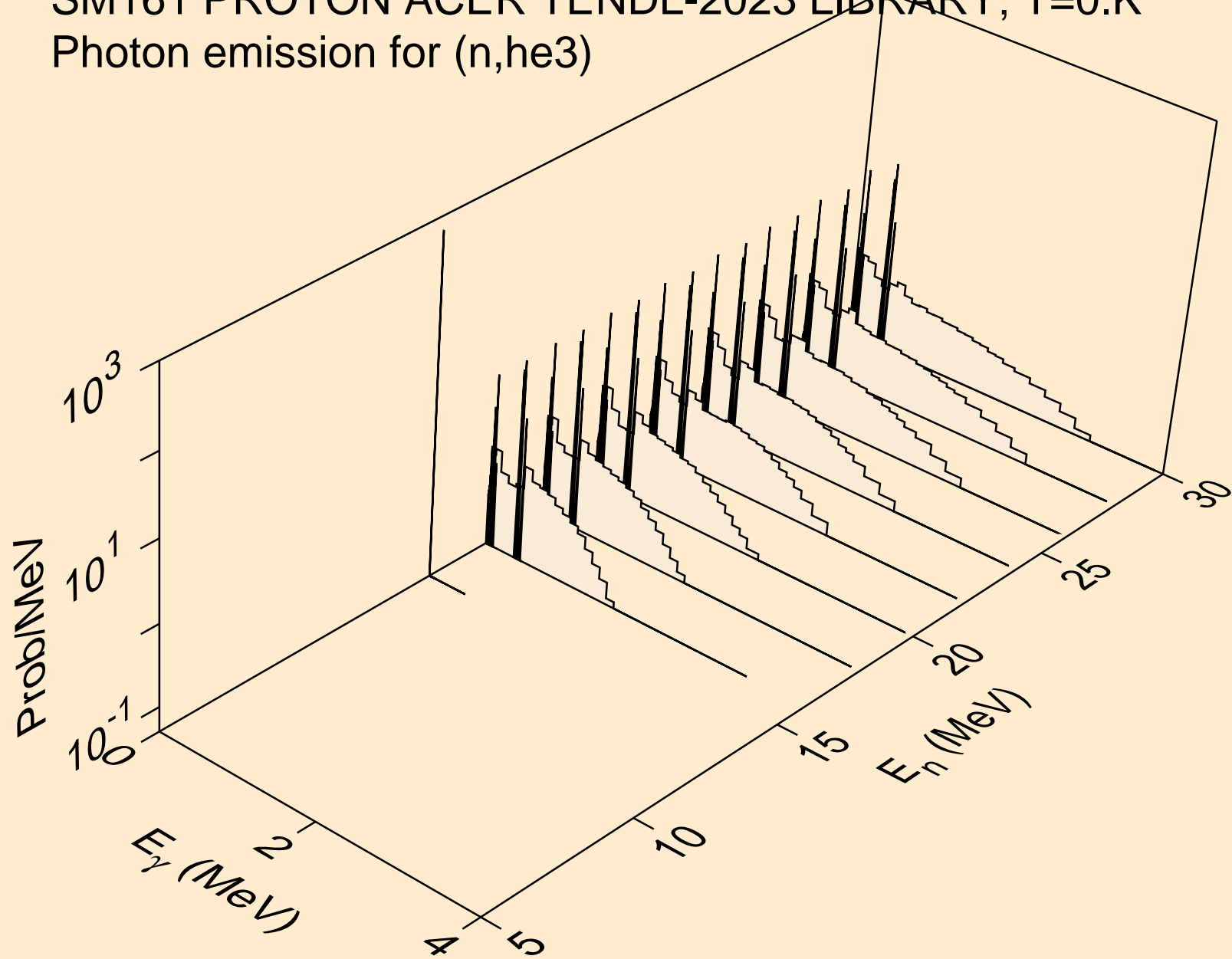

SM161 PROTON ACER TENDL-2023 LIBRARY; T=0.K
Photon emission for (n,a)

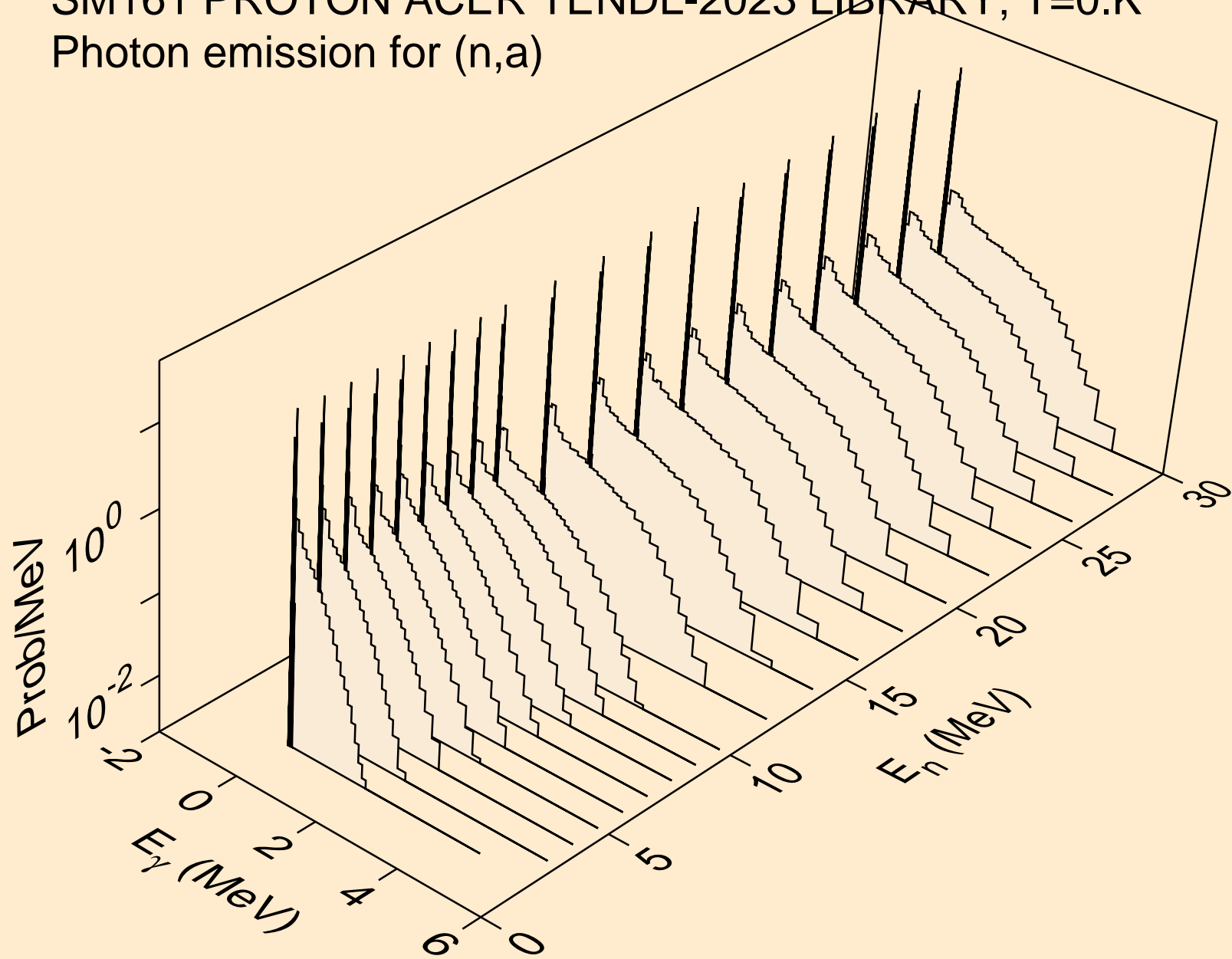

SM161 PROTON ACER TENDL-2023 LIBRARY; T=0.K
Photon emission for (n,2p)

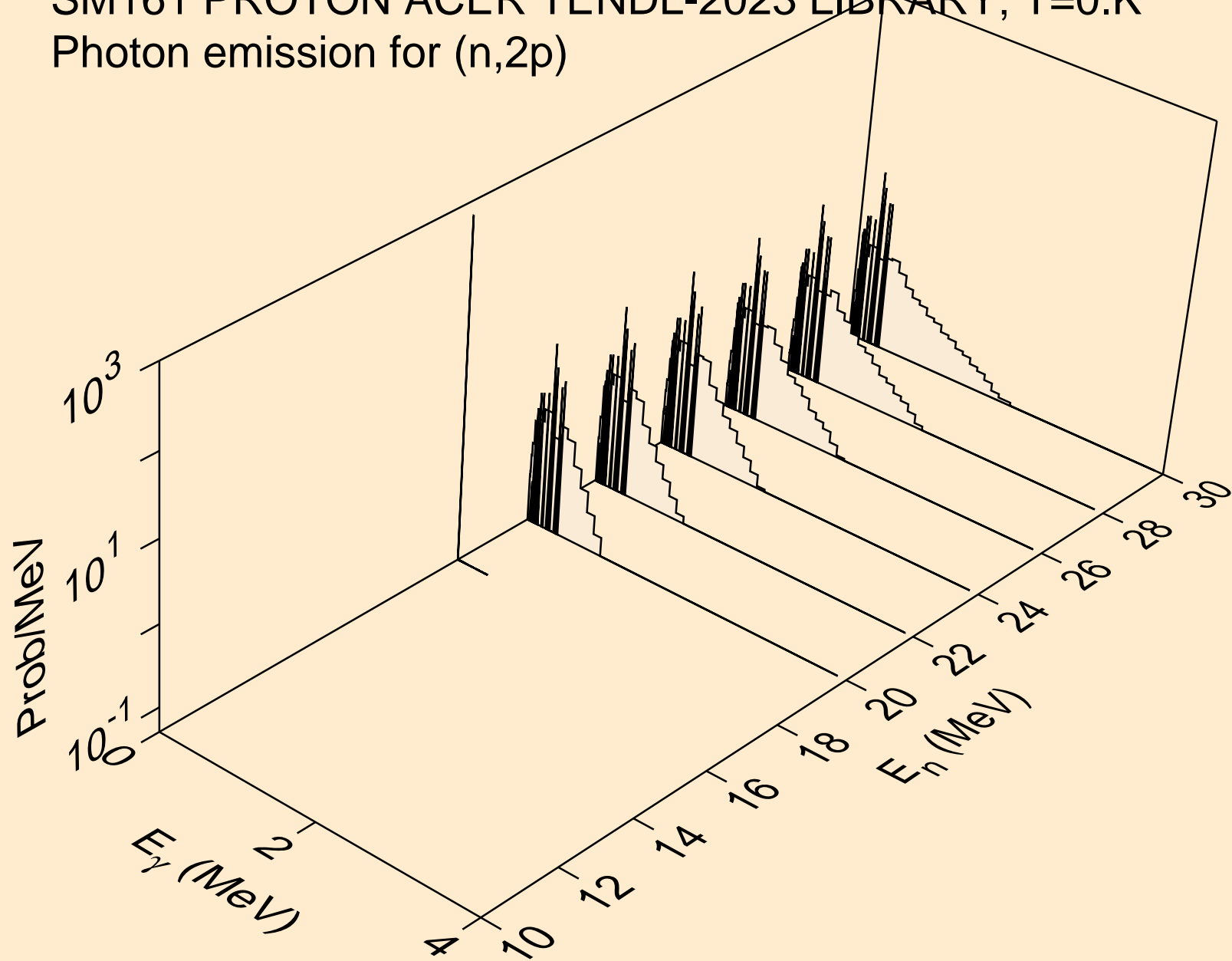

SM161 PROTON ACER TENDL-2023 LIBRARY; T=0.K
Photon emission for (n,pd)

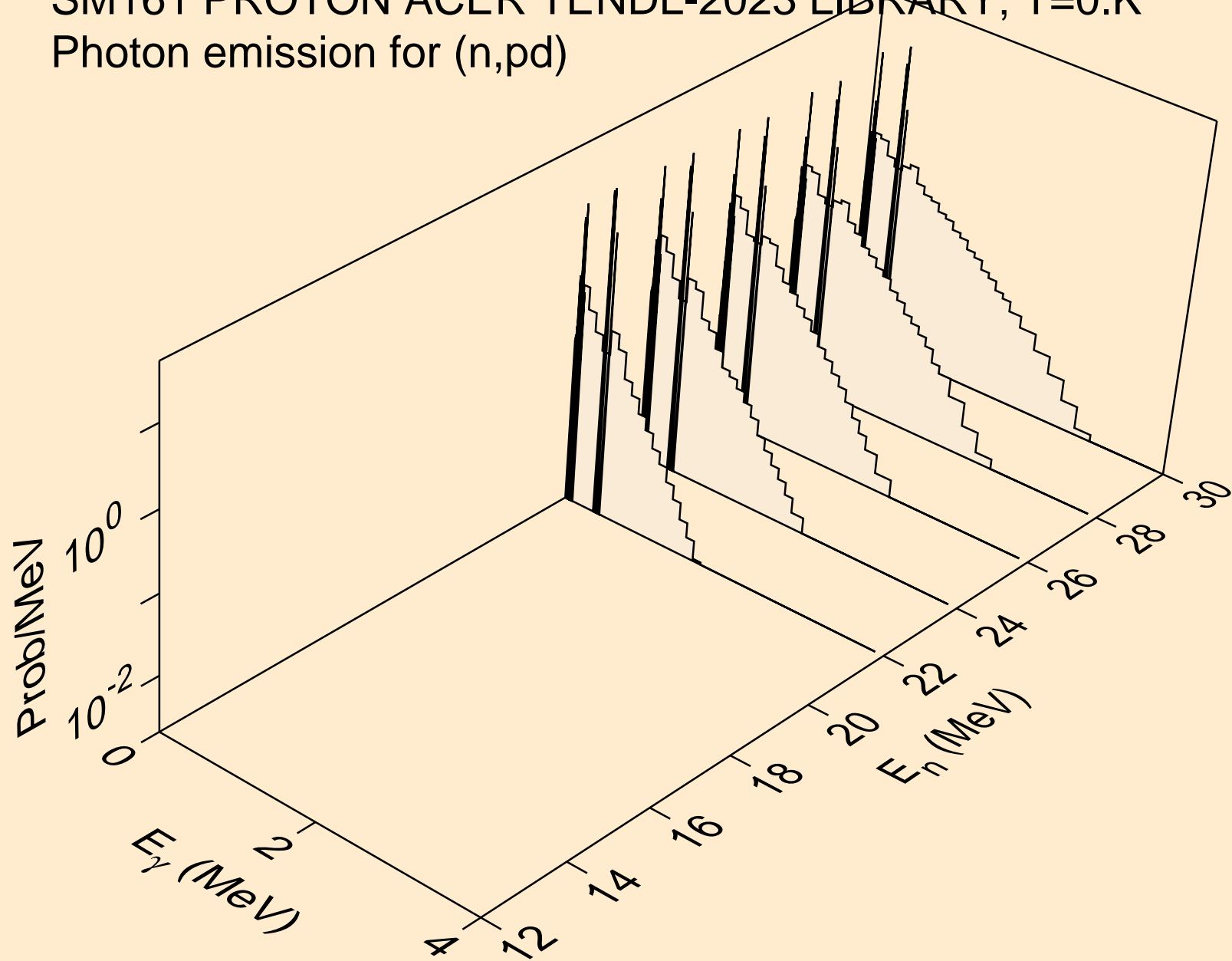

SM161 PROTON ACER TENDL-2023 LIBRARY; T=0.K
Particle heating contributions

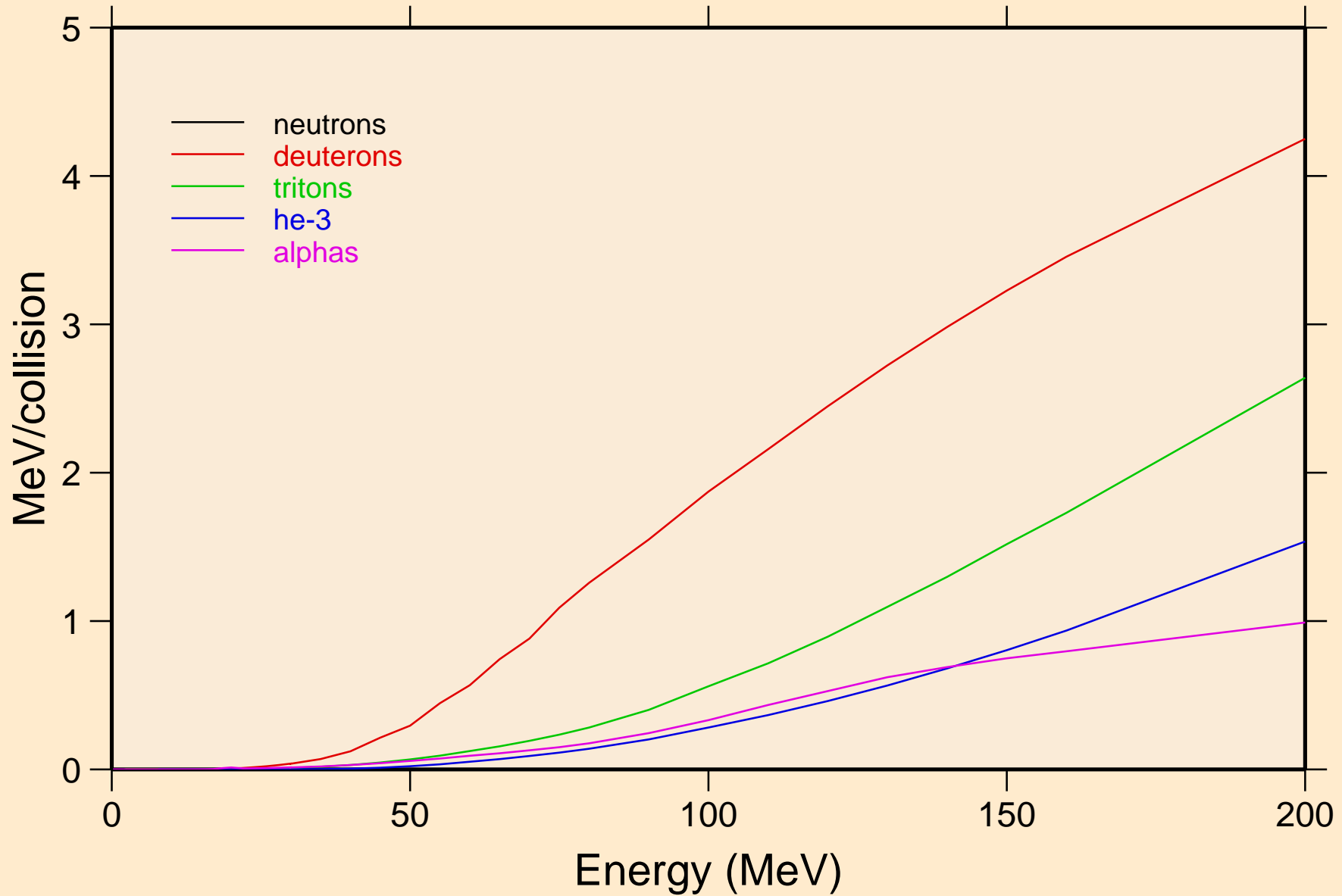

SM161 PROTON ACER TENDL-2023 LIBRARY; T=0.K
Recoil Heating

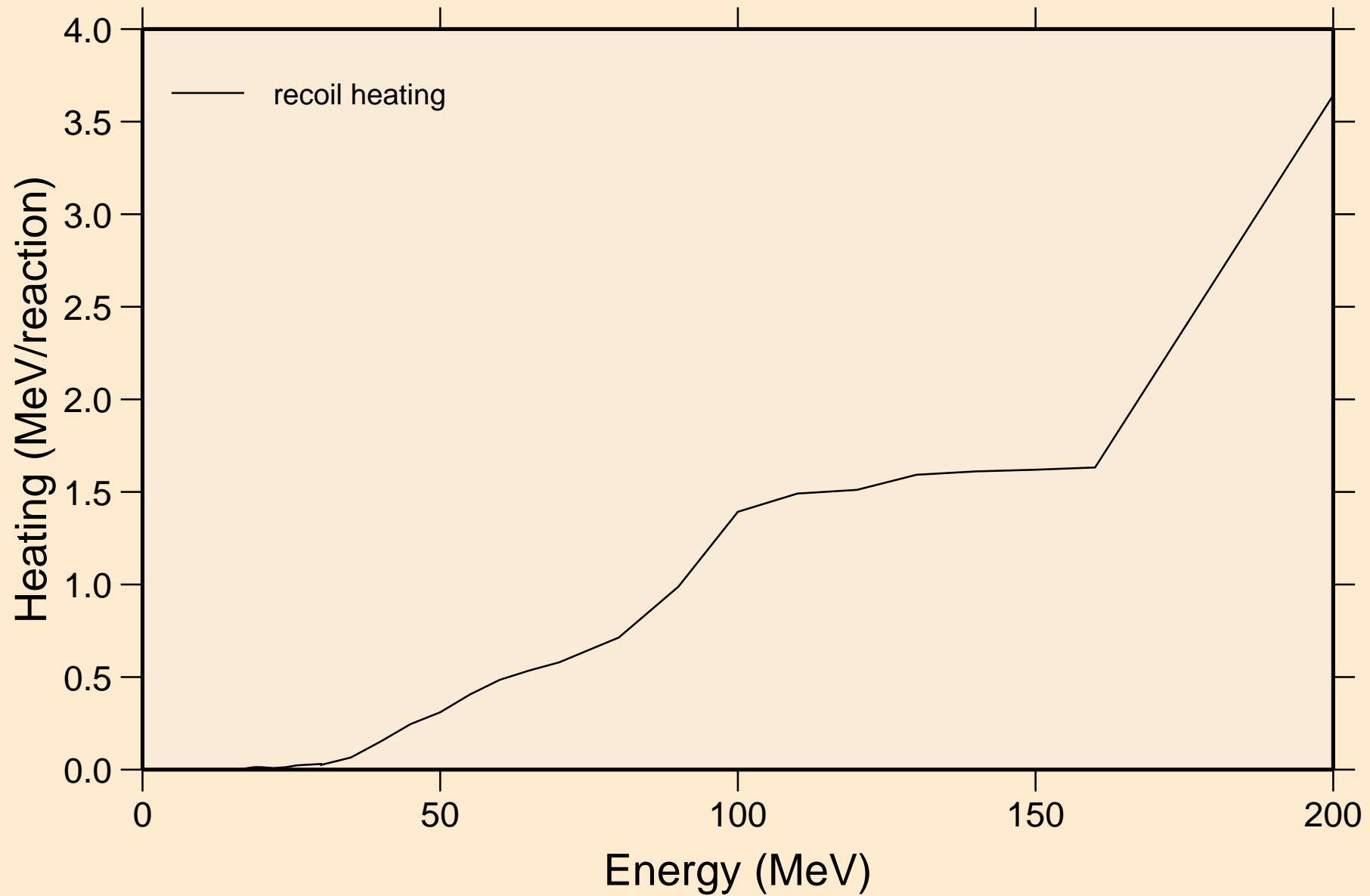

SM161 PROTON ACER TENDL-2023 LIBRARY; T=0.K
Particle production cross sections

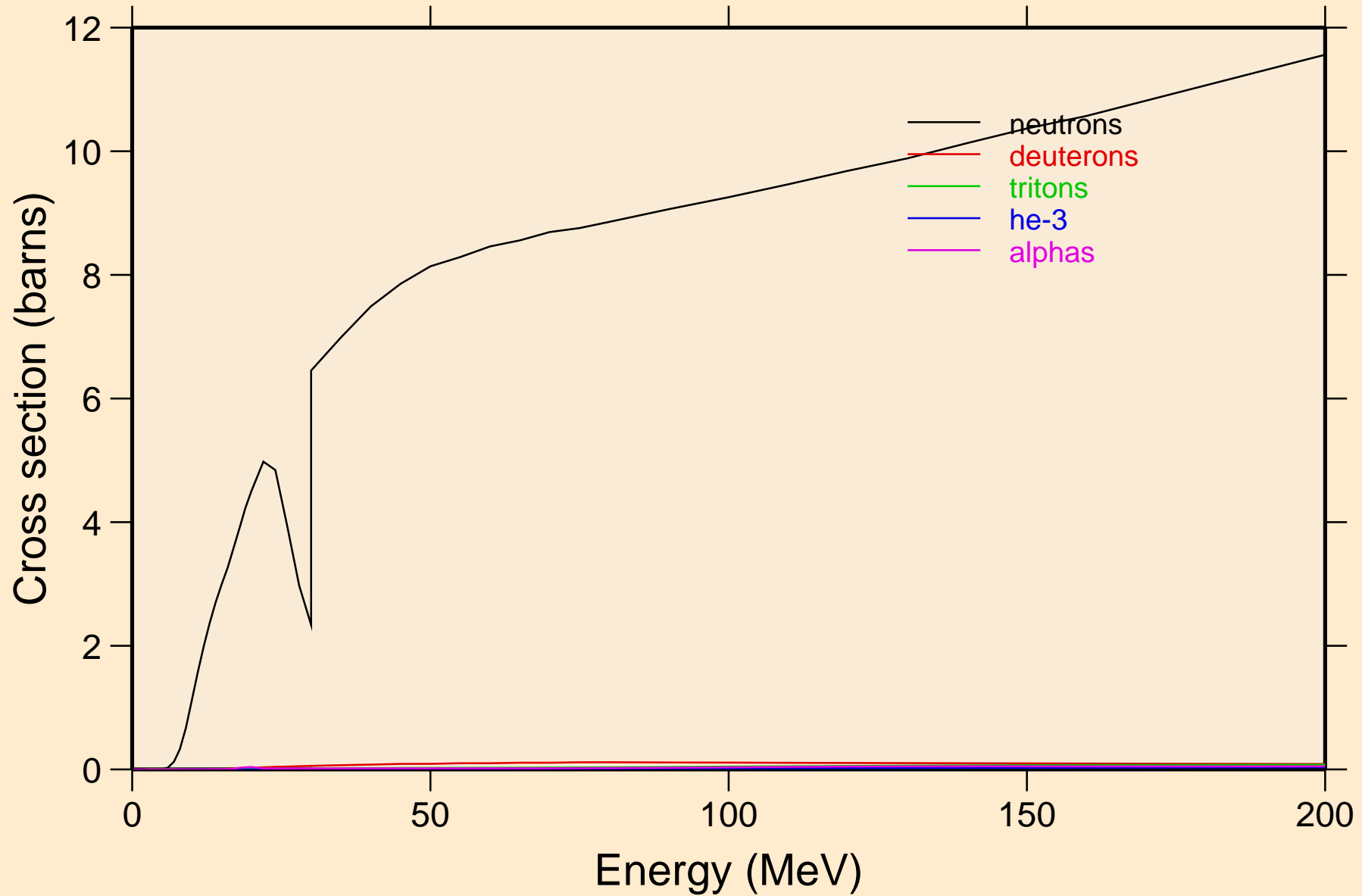

SM161 PROTON ACER TENDL-2023 LIBRARY; T=0.K
neutrons from (p,n)

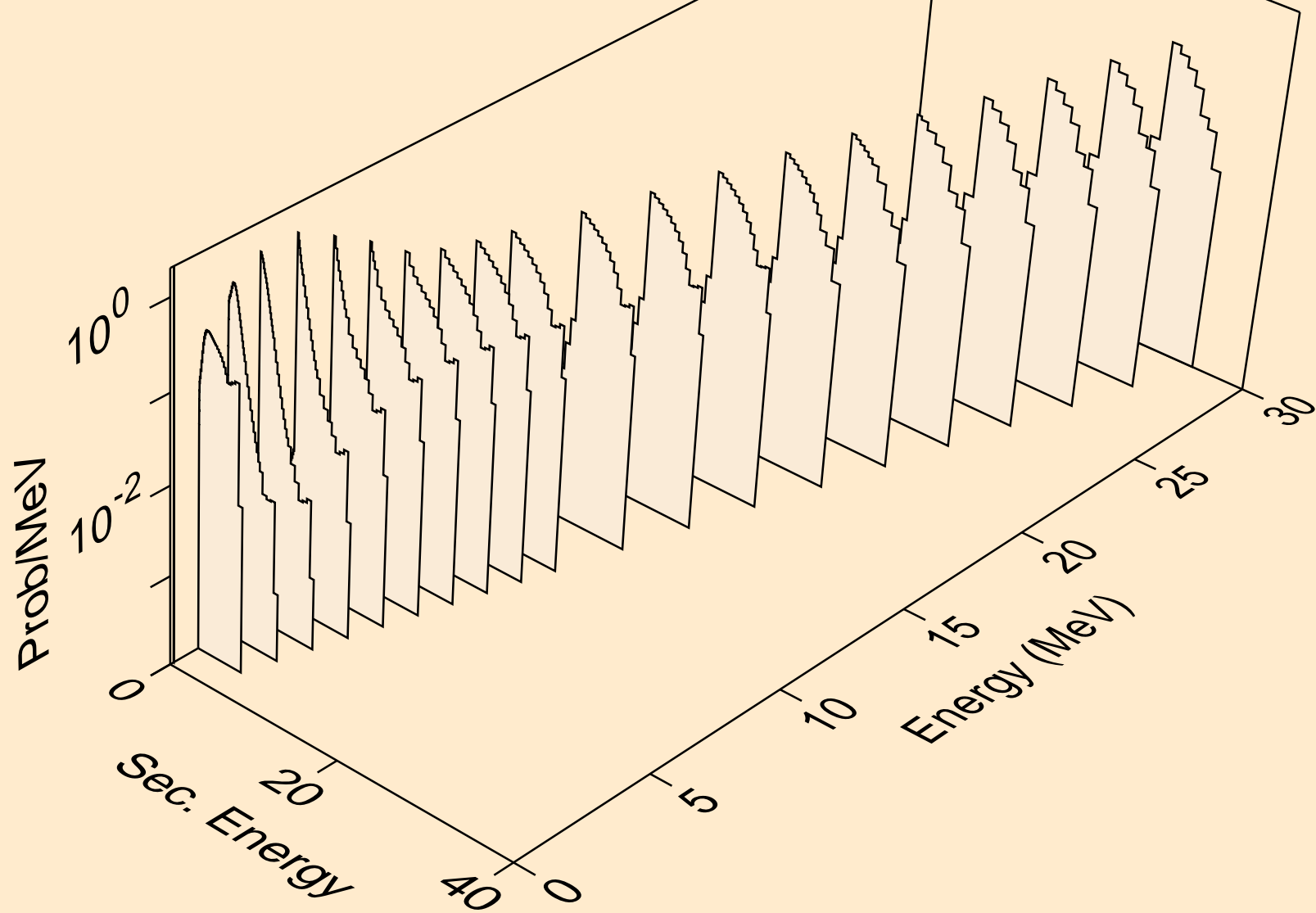

SM161 PROTON ACER TENDL-2023 LIBRARY; T=0.K
neutrons from (p,x)

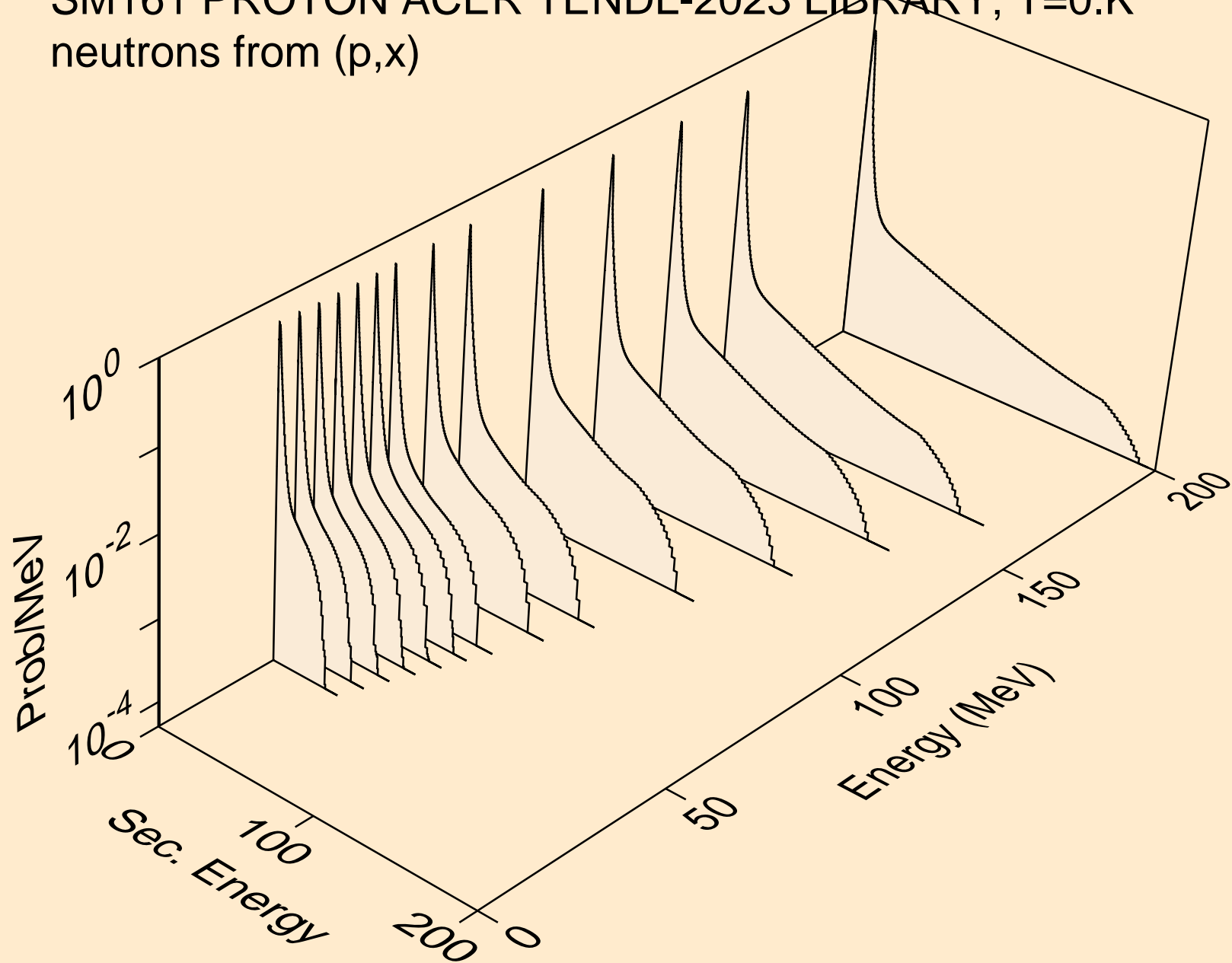

SM161 PROTON ACER TENDL-2023 LIBRARY; T=0.K
neutrons from (p,2nd)

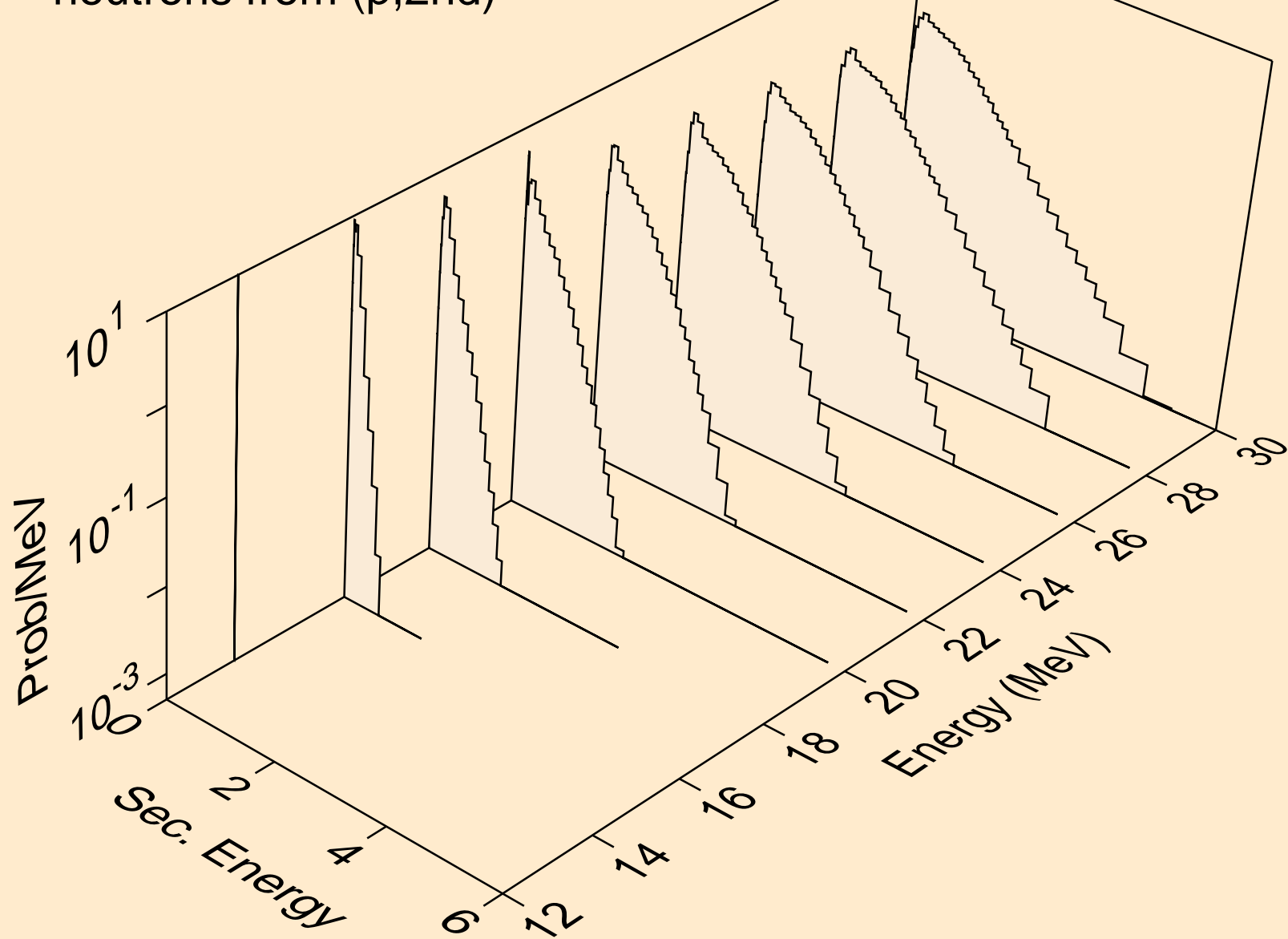

SM161 PROTON ACER TENDL-2023 LIBRARY; T=0.K
neutrons from (p,2n)

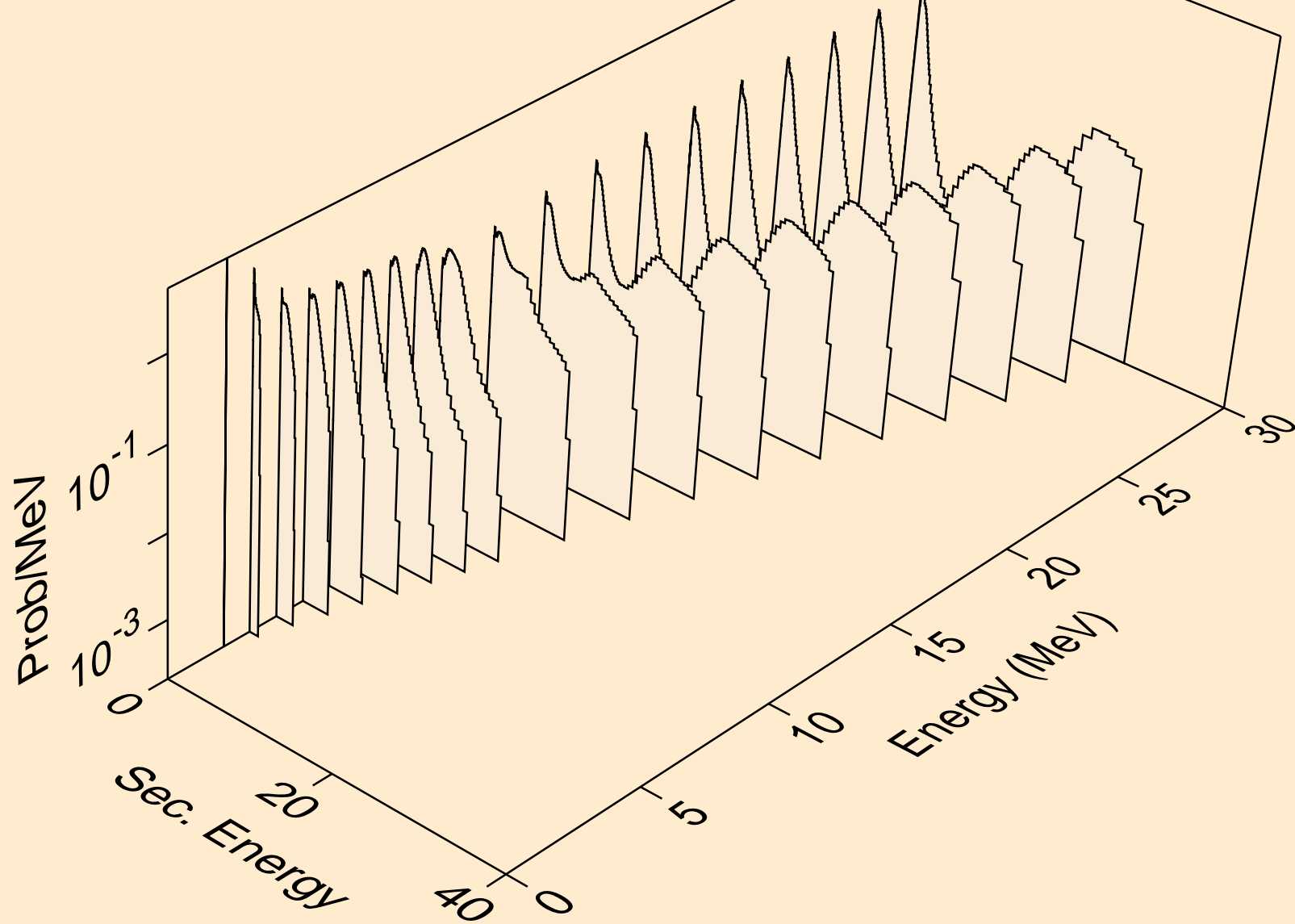

SM161 PROTON ACER TENDL-2023 LIBRARY; T=0.K
neutrons from (p,3n)

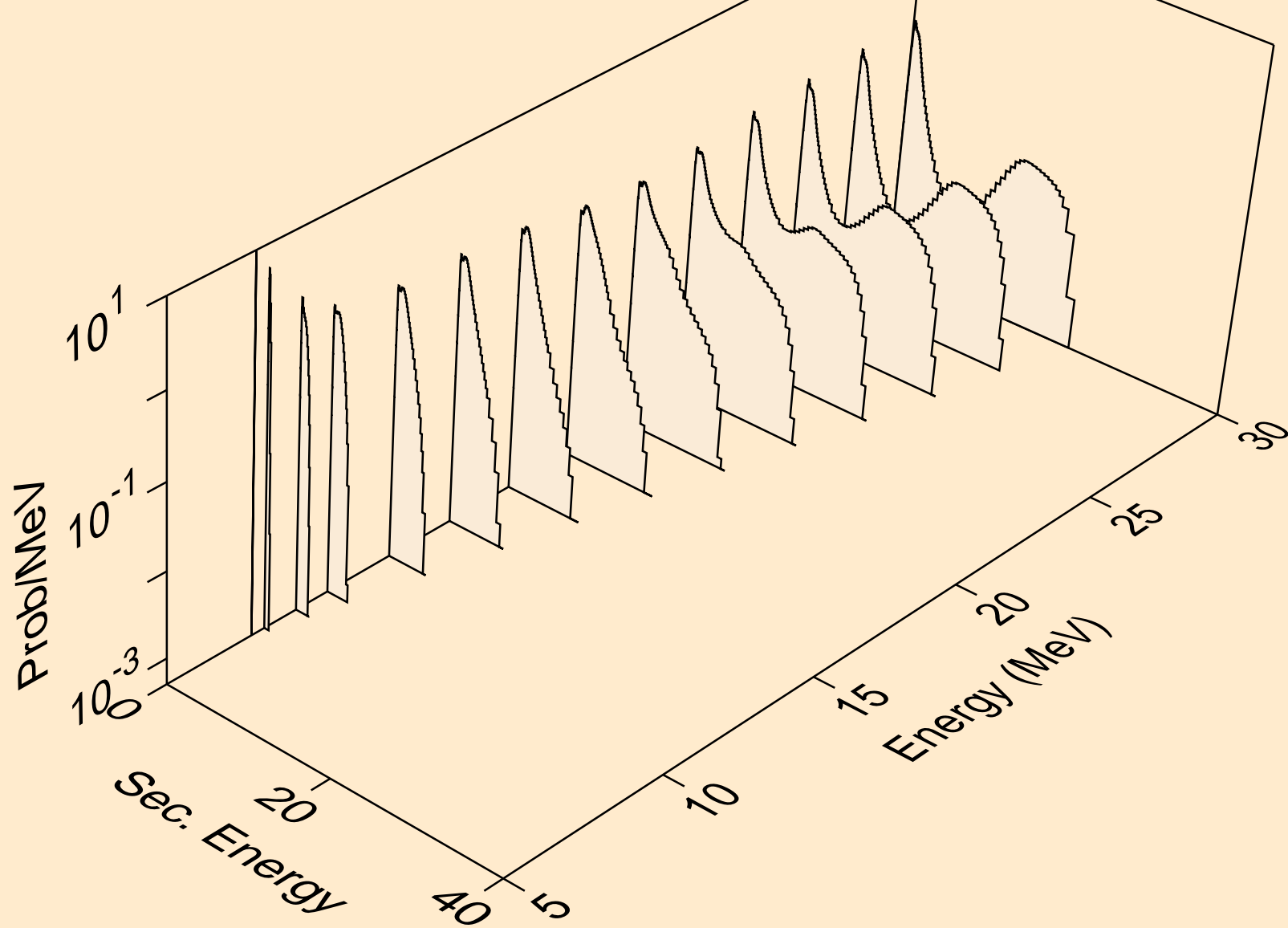

SM161 PROTON ACER TENDL-2023 LIBRARY; T=0.K
neutrons from (p,n*)a

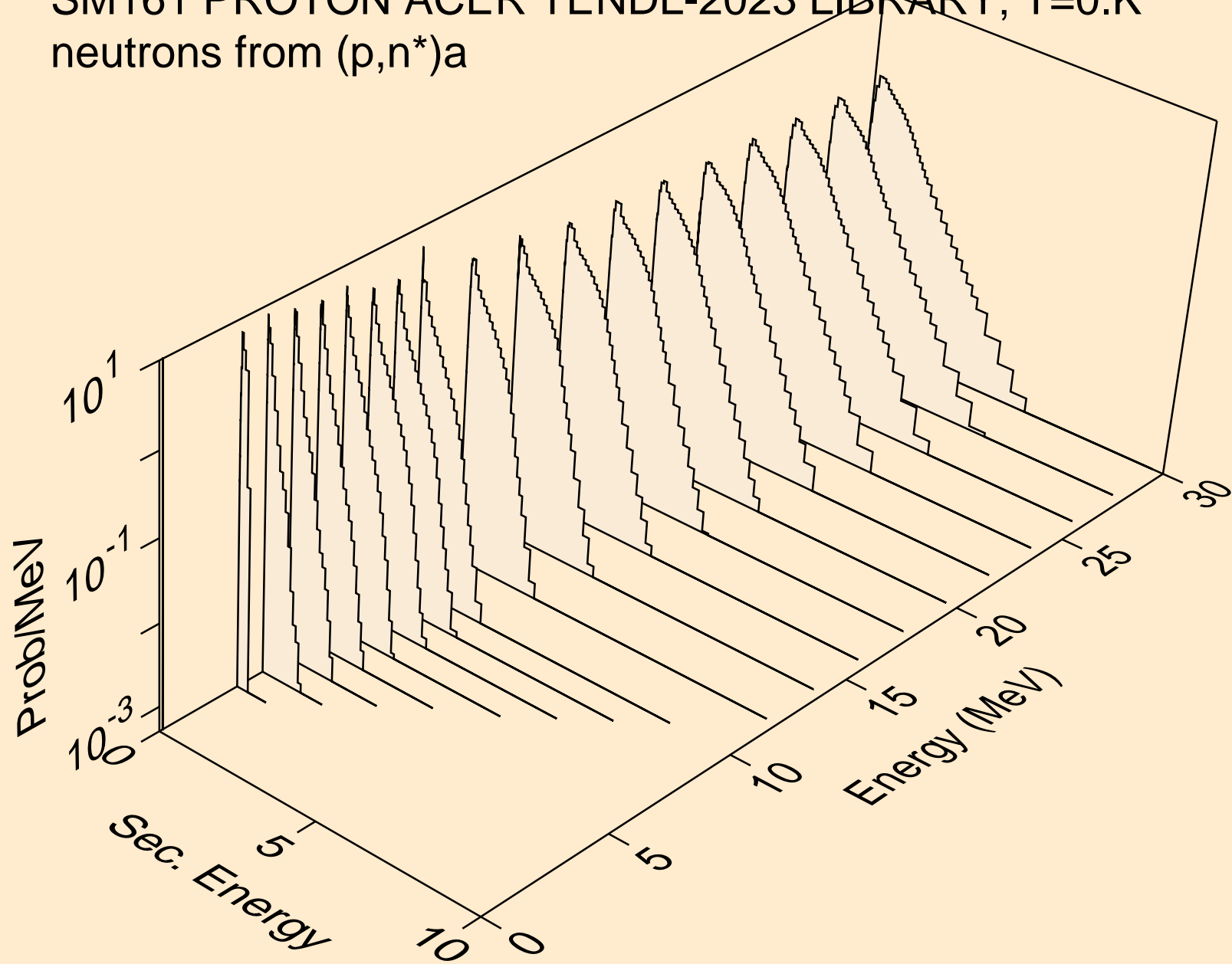

SM161 PROTON ACER TENDL-2023 LIBRARY; T=0.K
neutrons from (p,2n)a

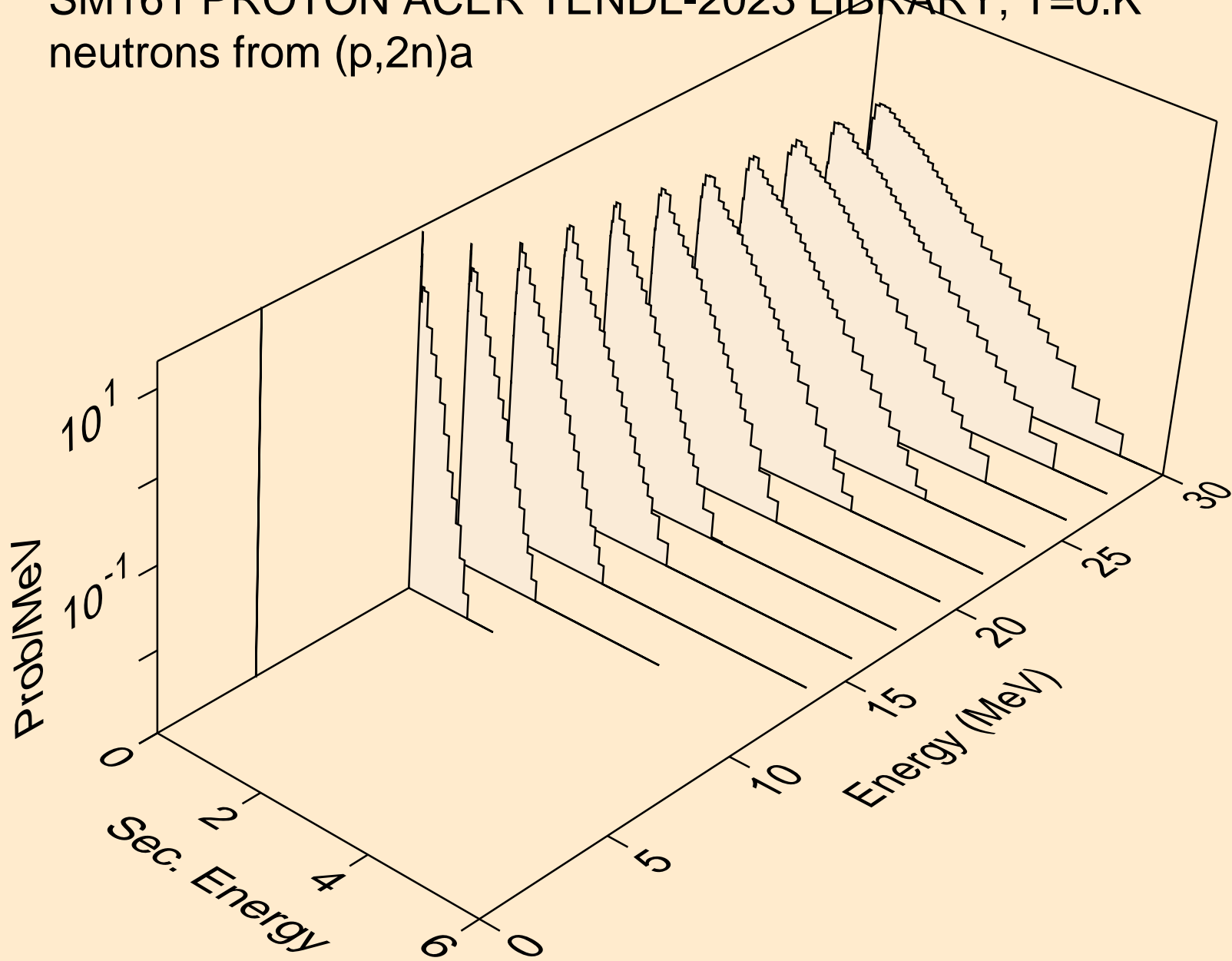

SM161 PROTON ACER TENDL-2023 LIBRARY; T=0.K
neutrons from (p,3n)a

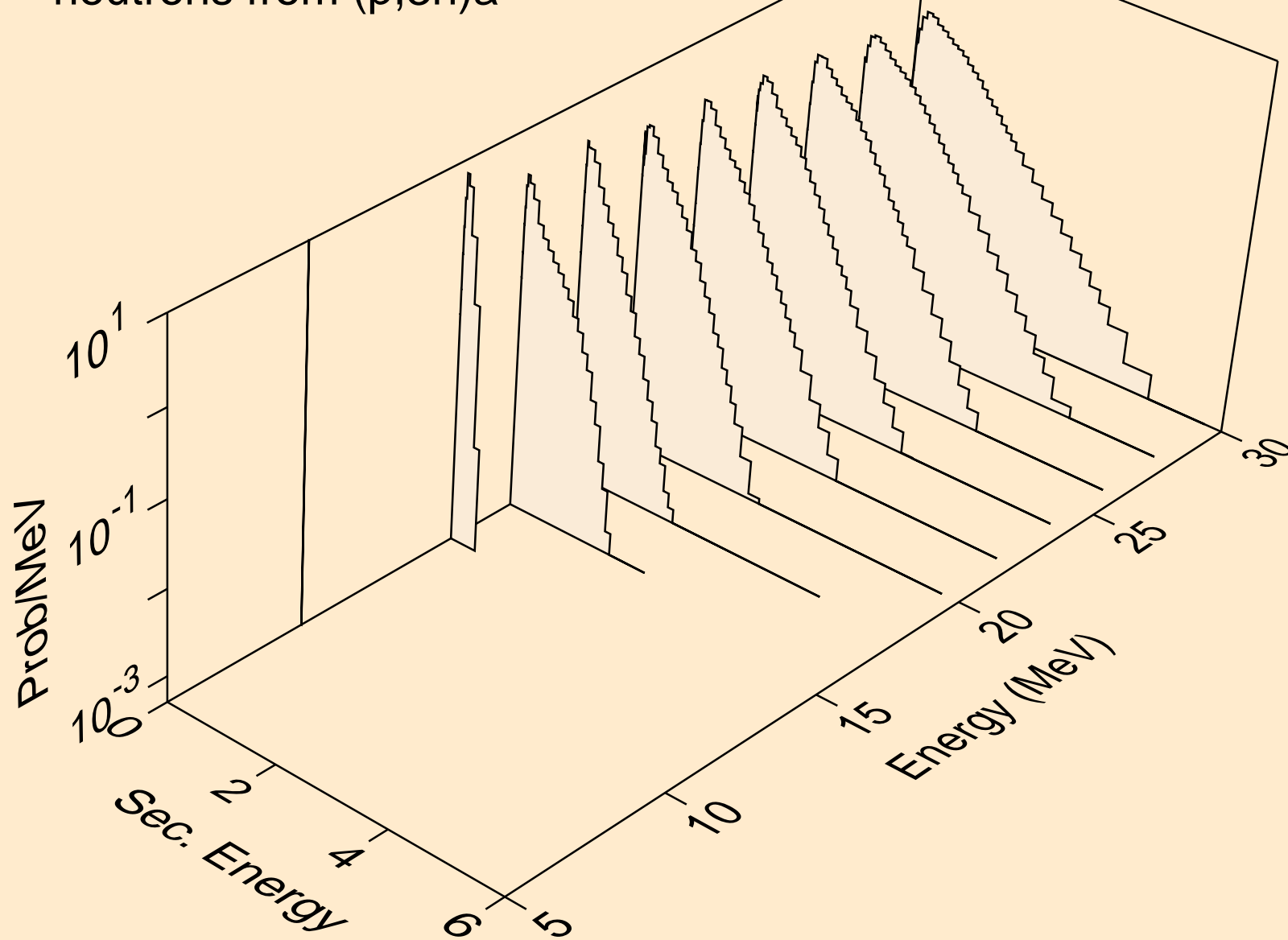

SM161 PROTON ACER TENDL-2023 LIBRARY; T=0.K
neutrons from (p,n*)p

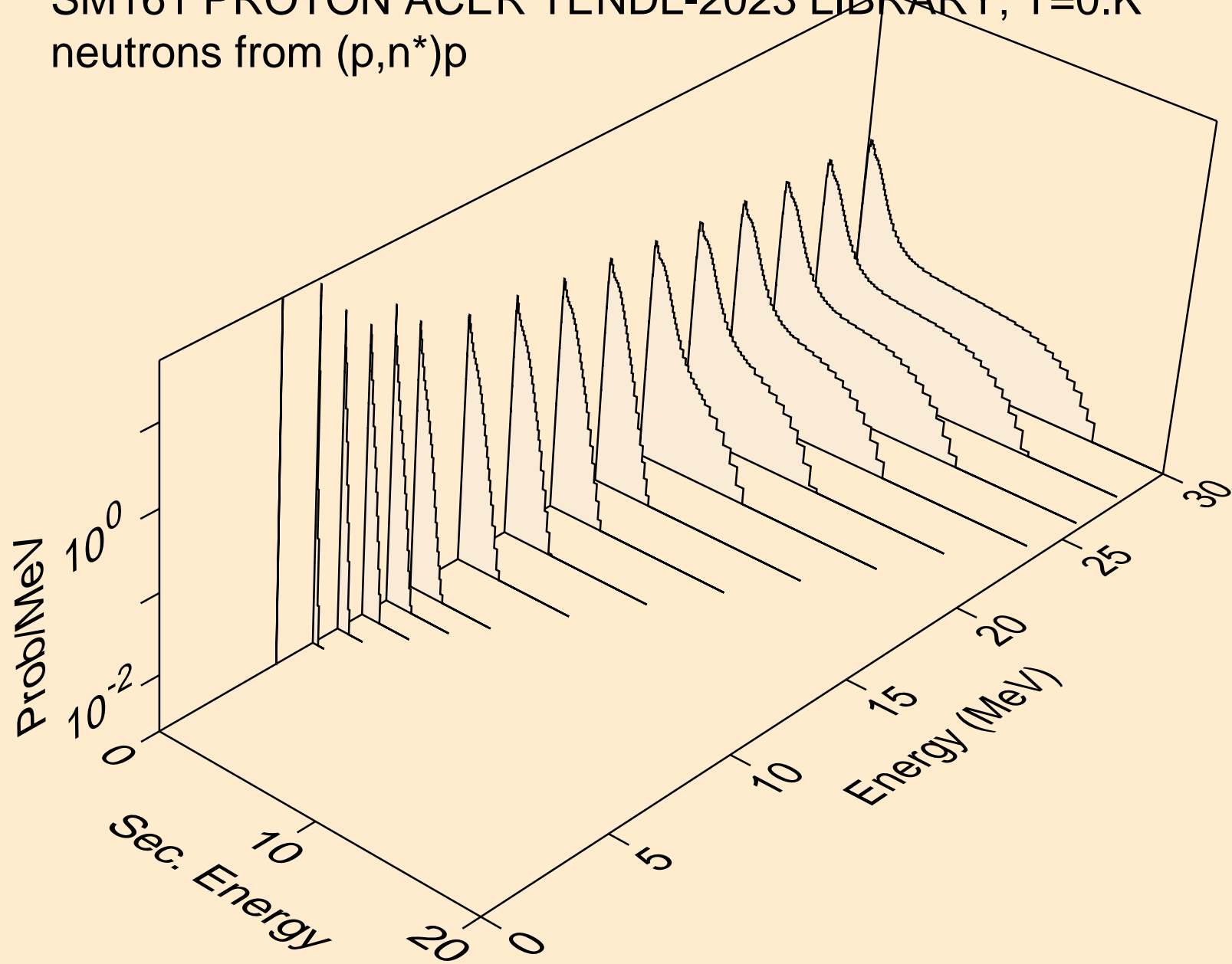

SM161 PROTON ACER TENDL-2023 LIBRARY; T=0.K
neutrons from (p,n*)d

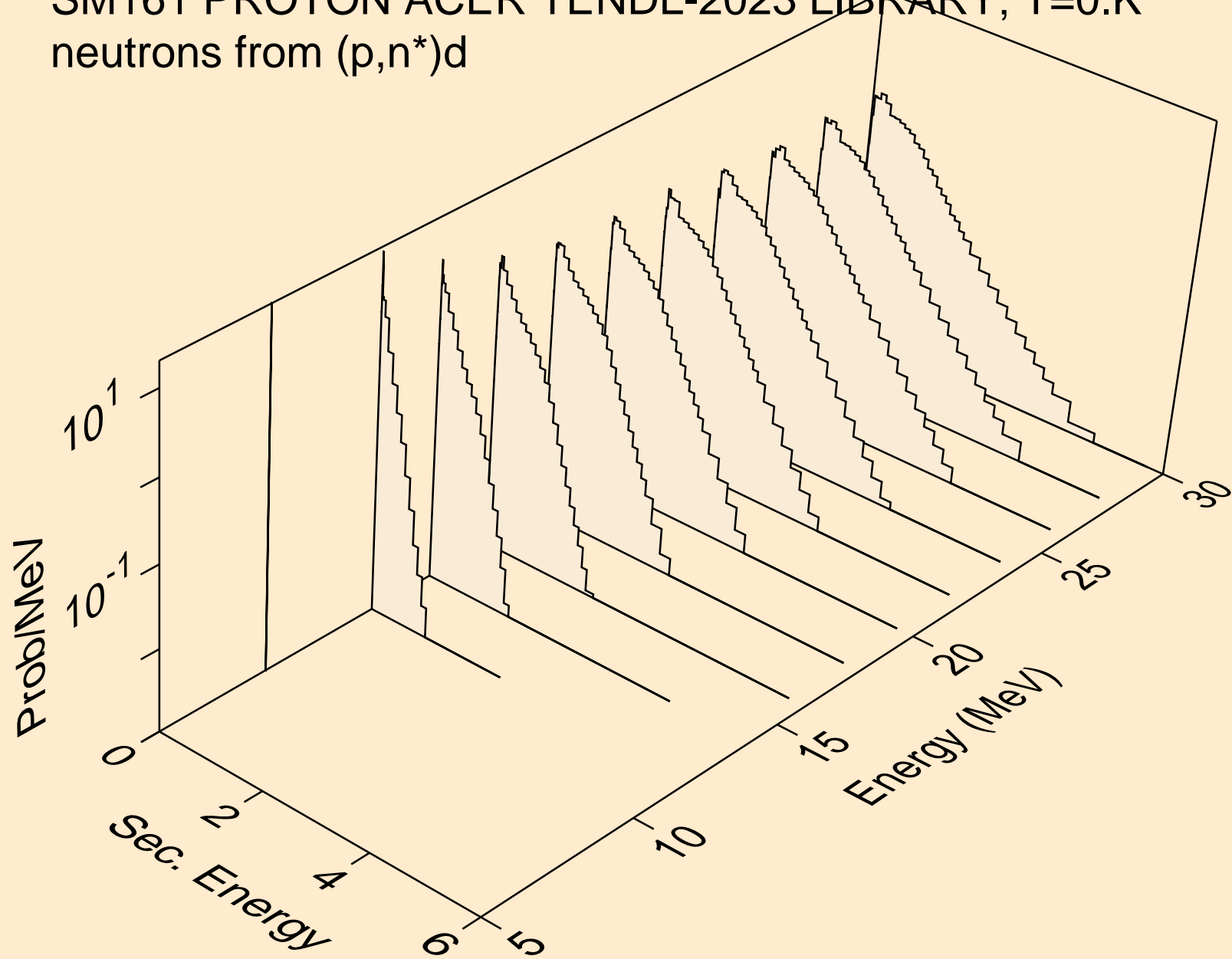

SM161 PROTON ACER TENDL-2023 LIBRARY; T=0.K
neutrons from (p,n*)t

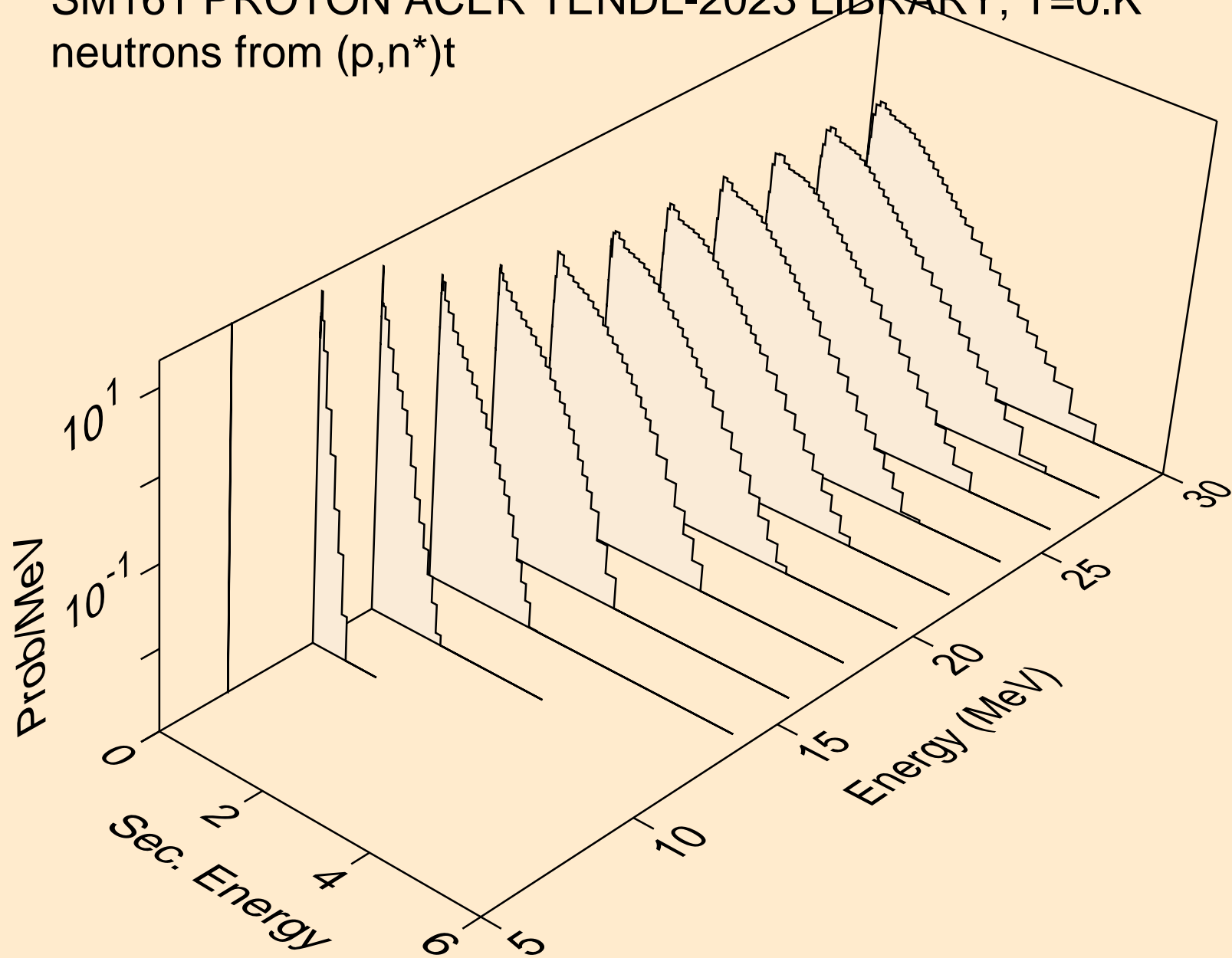

SM161 PROTON ACER TENDL-2023 LIBRARY; T=0.K
neutrons from (p,n*)he3

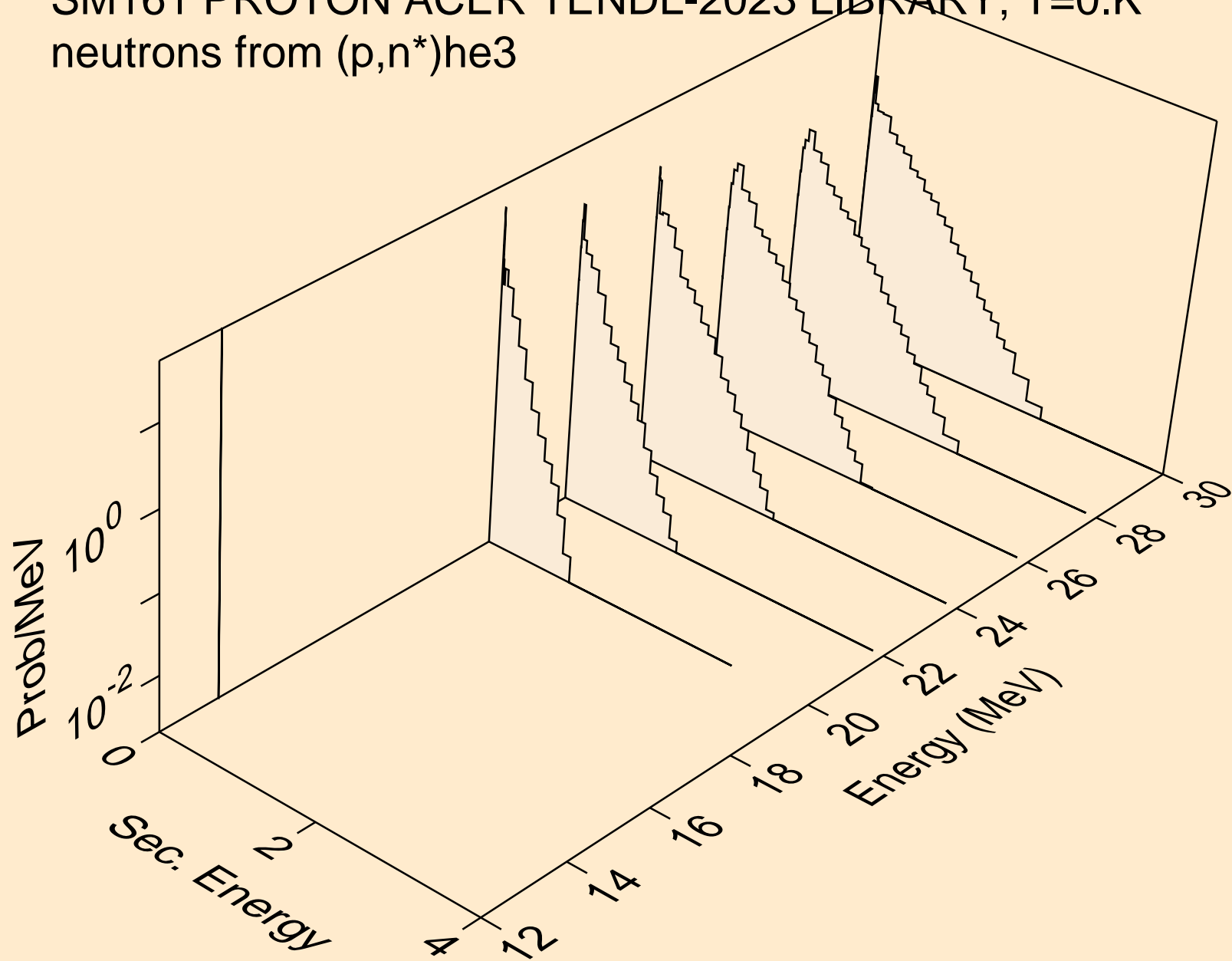

SM161 PROTON ACER TENDL-2023 LIBRARY; T=0.K
neutrons from (p,4n)

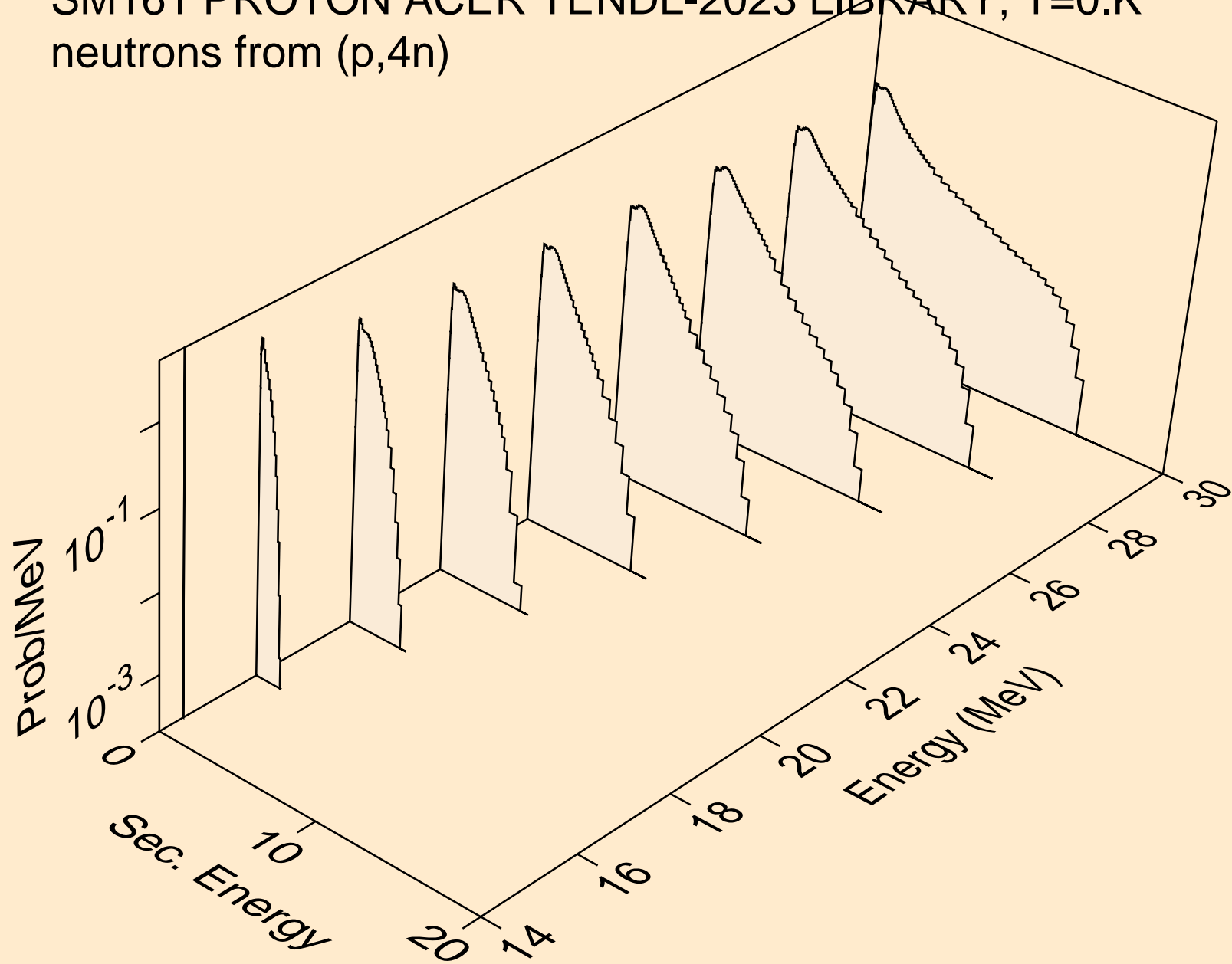

SM161 PROTON ACER TENDL-2023 LIBRARY; T=0.K
neutrons from (p,2np)

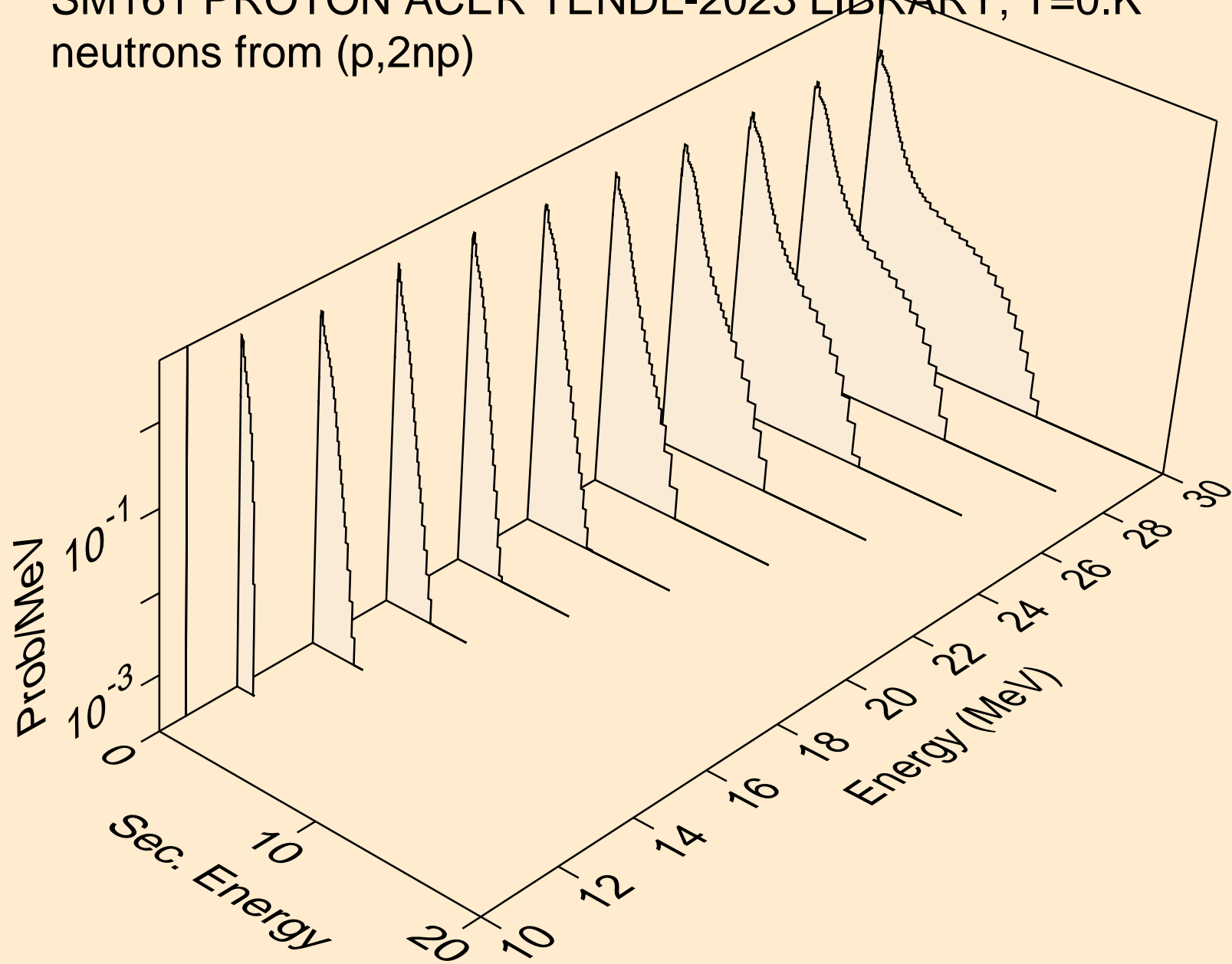

SM161 PROTON ACER TENDL-2023 LIBRARY; T=0.K
neutrons from (p,3np)

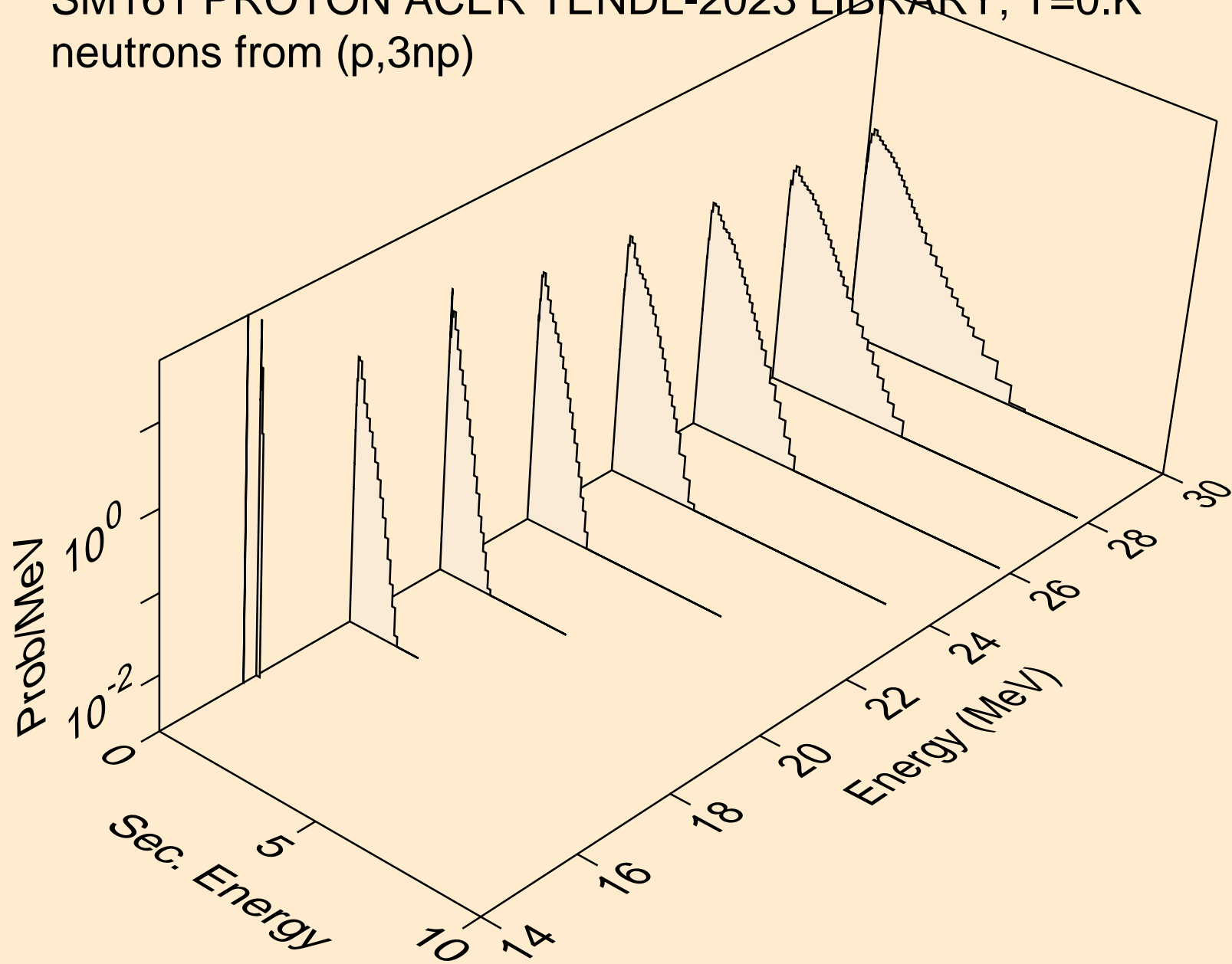

SM161 PROTON ACER TENDL-2023 LIBRARY; T=0.K
neutrons from (p,n2p)

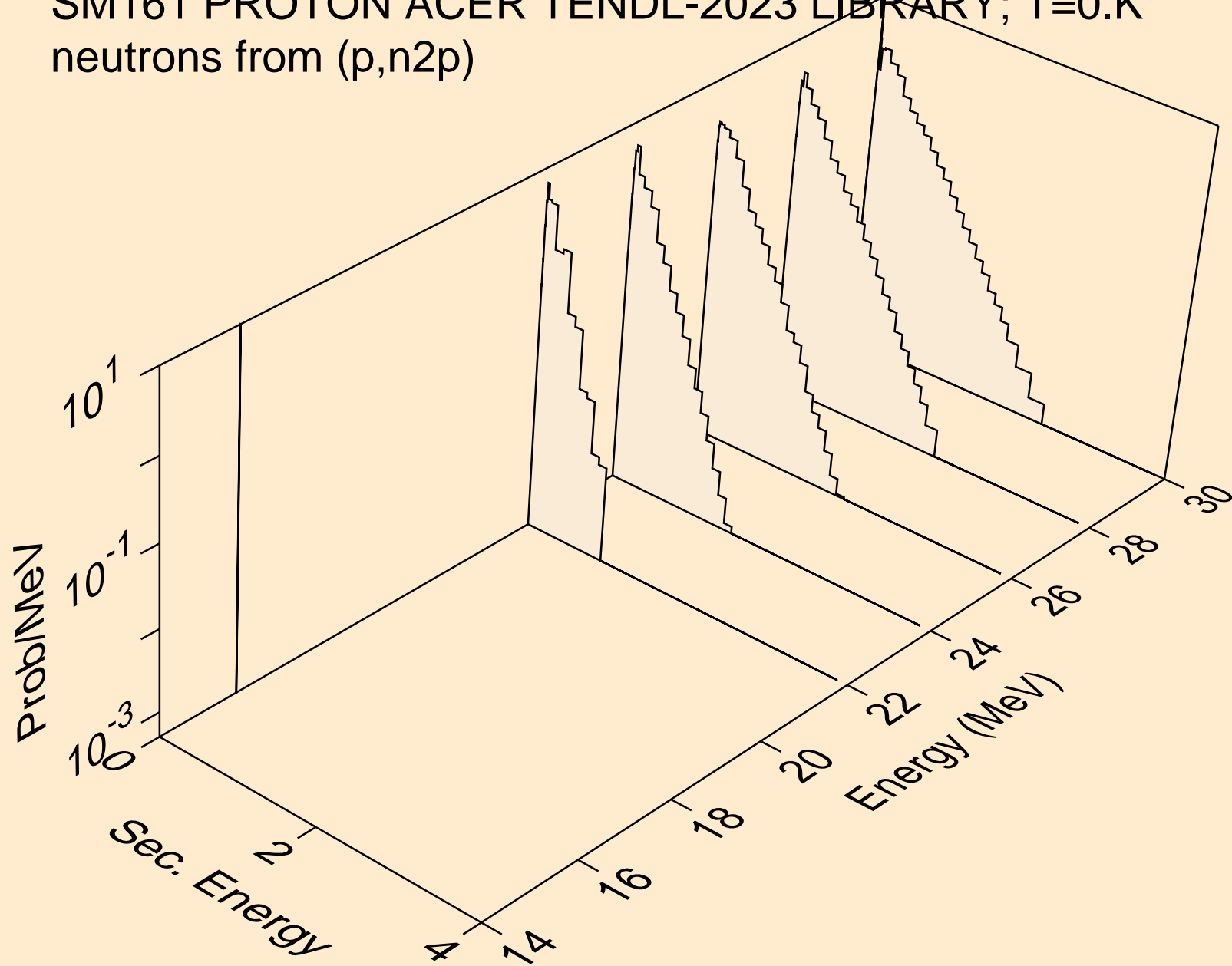

SM161 PROTON ACER TENDL-2023 LIBRARY; T=0.K
deuterons from (p,x)

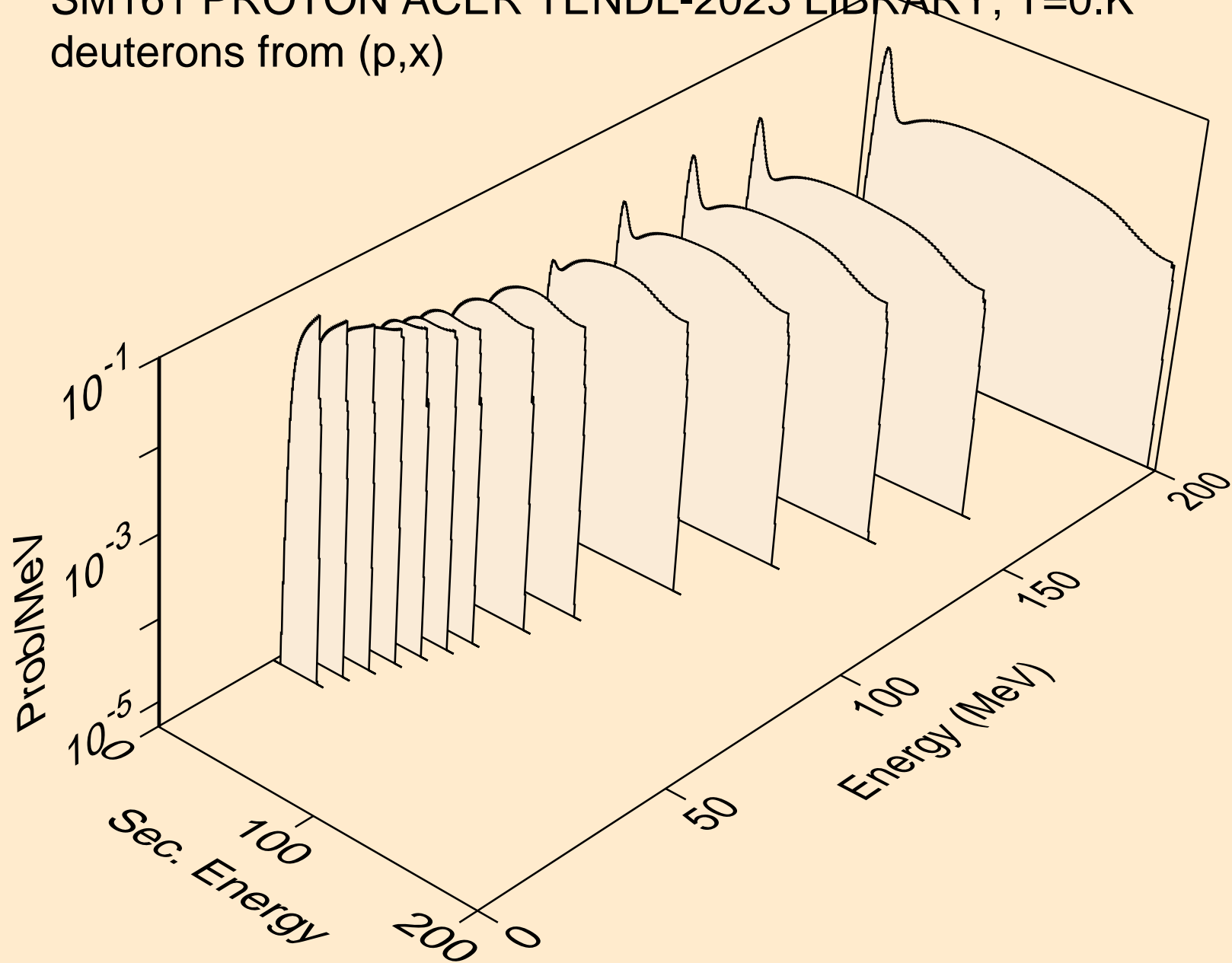

SM161 PROTON ACER TENDL-2023 LIBRARY; T=0.K
deuterons from (p,2nd)

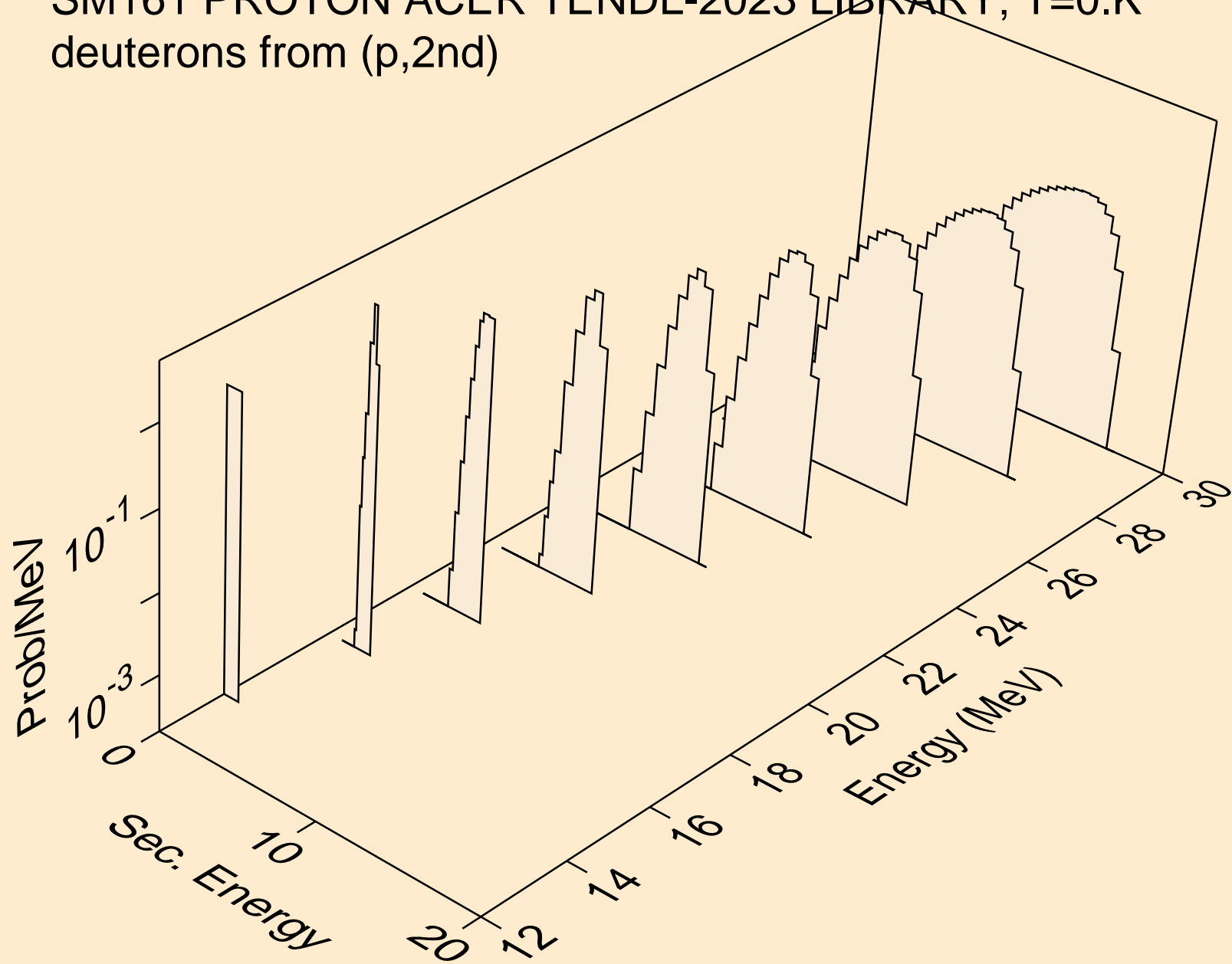

SM161 PROTON ACER TENDL-2023 LIBRARY; T=0.K
deuterons from (p,n*)d

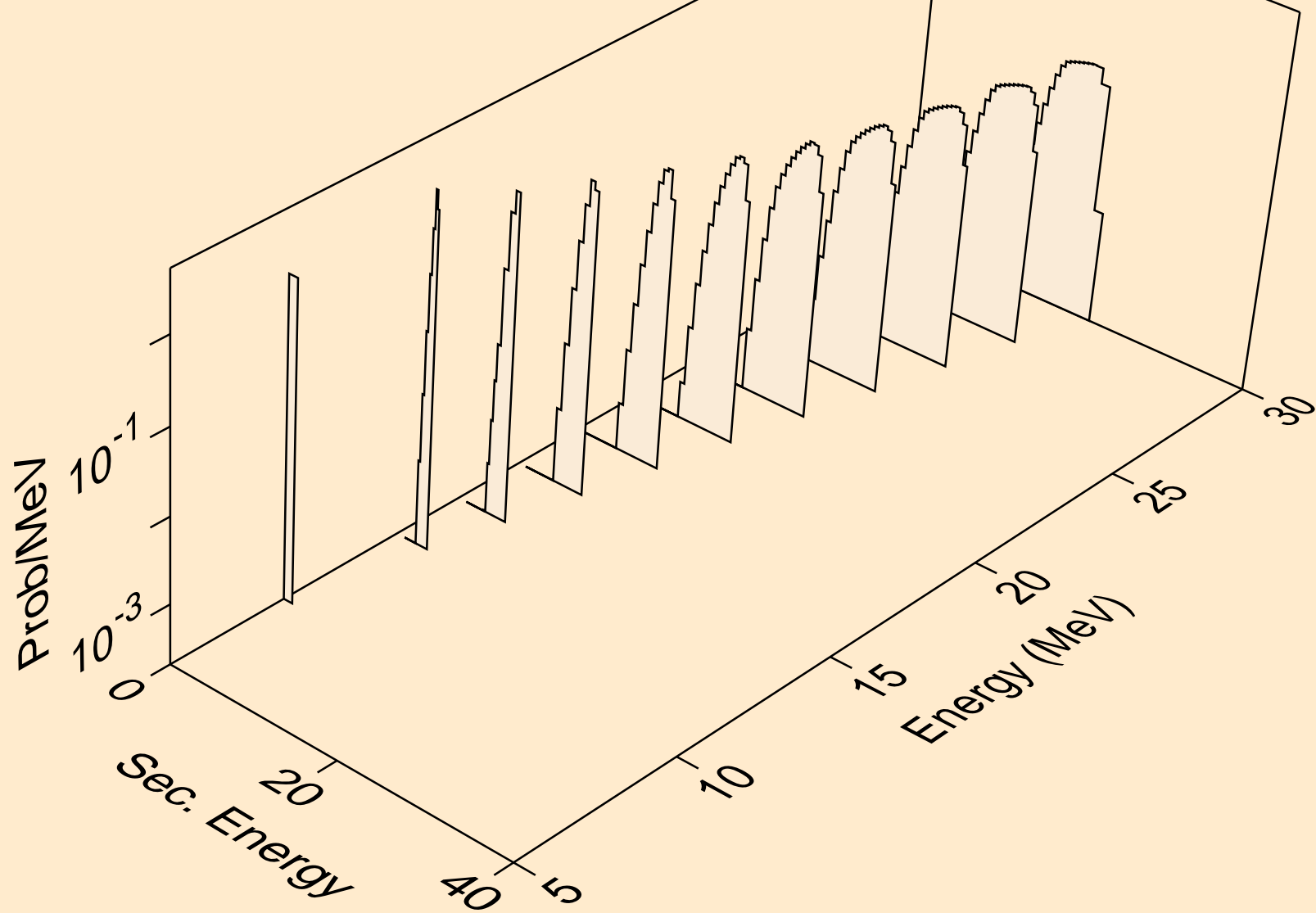

SM161 PROTON ACER TENDL-2023 LIBRARY; T=0.K
deuterons from (p,d)

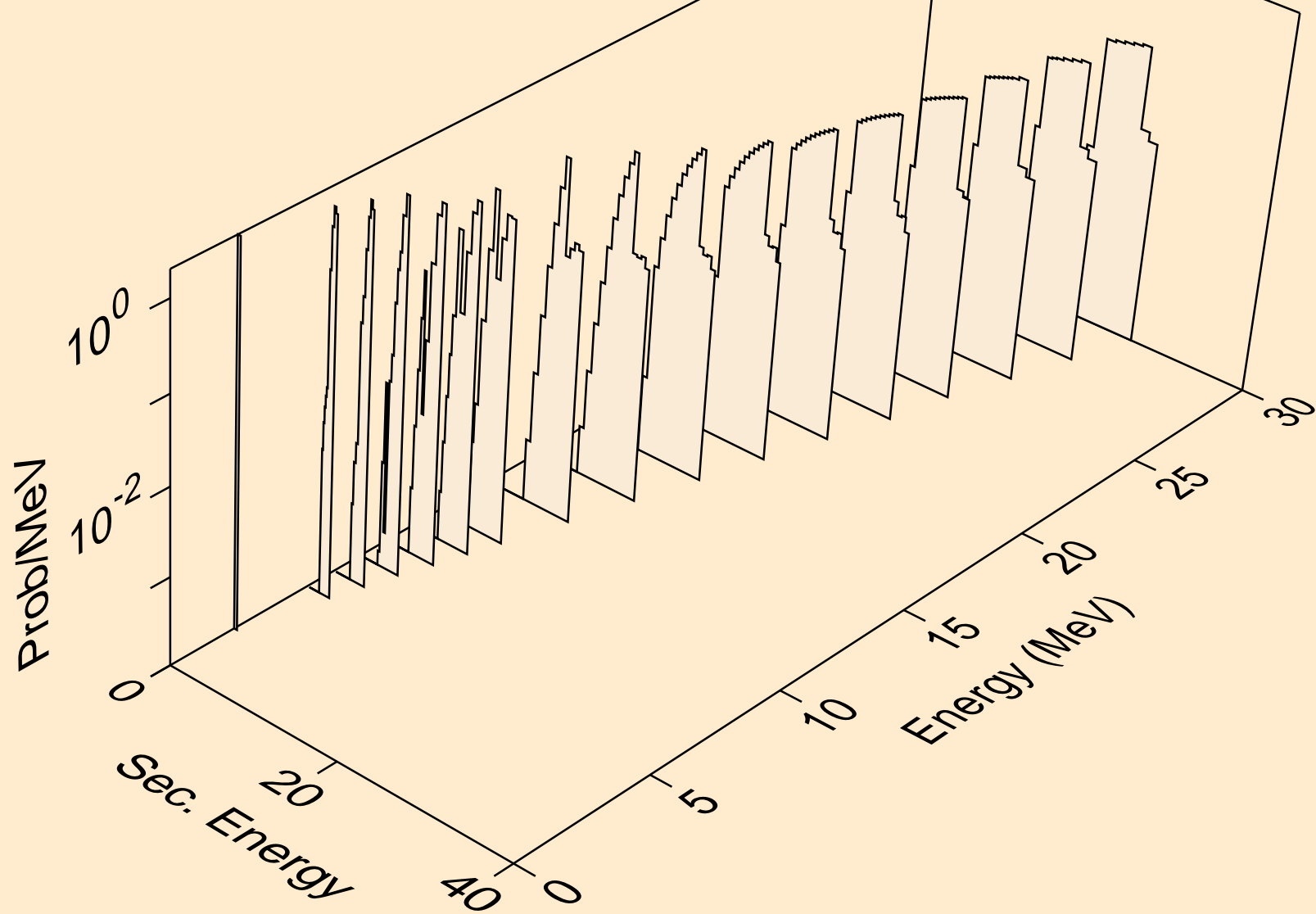

SM161 PROTON ACER TENDL-2023 LIBRARY; T=0.K
deuterons from (p,pd)

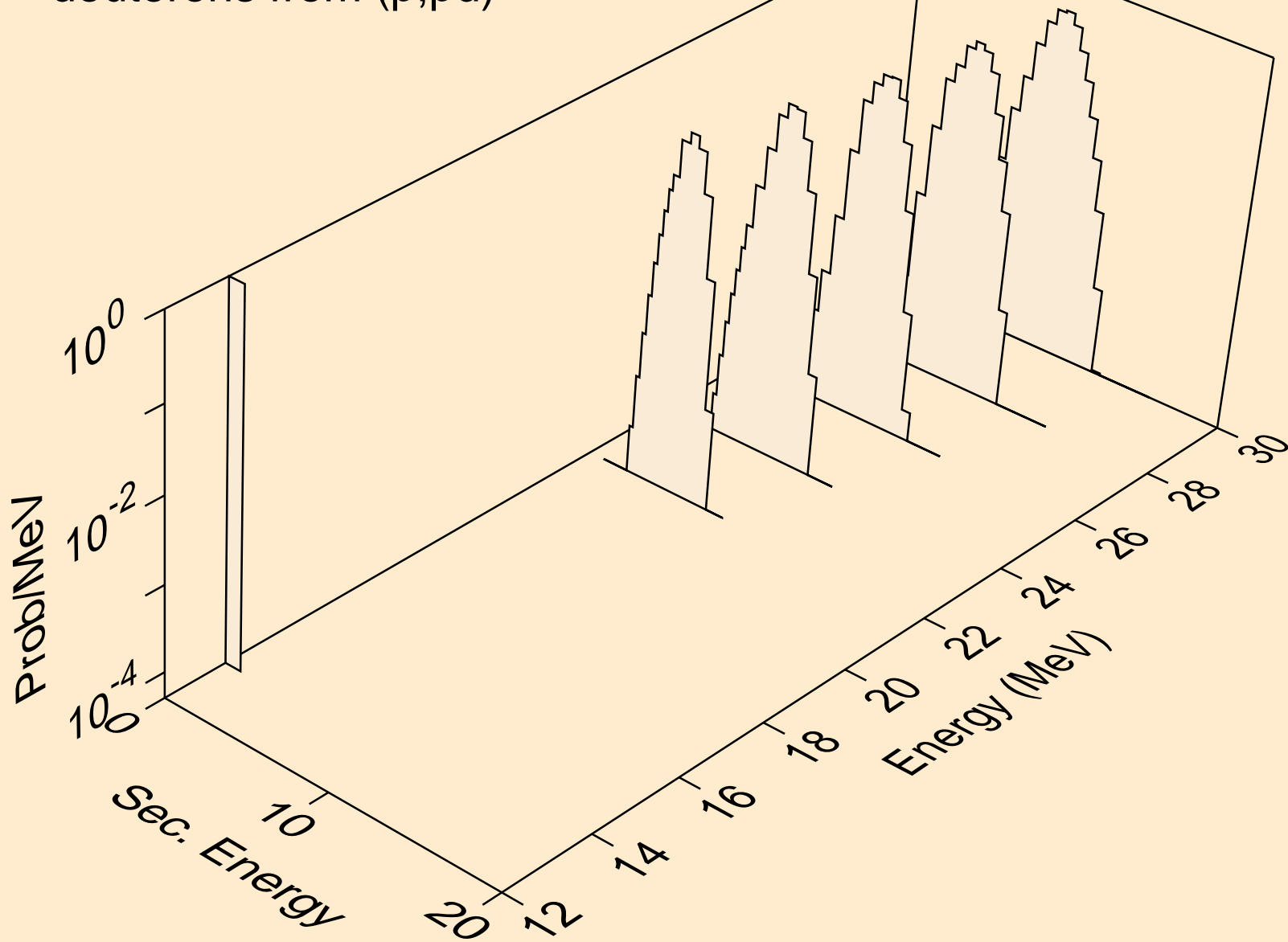

SM161 PROTON ACER TENDL-2023 LIBRARY; T=0.K
tritons from (p,x)

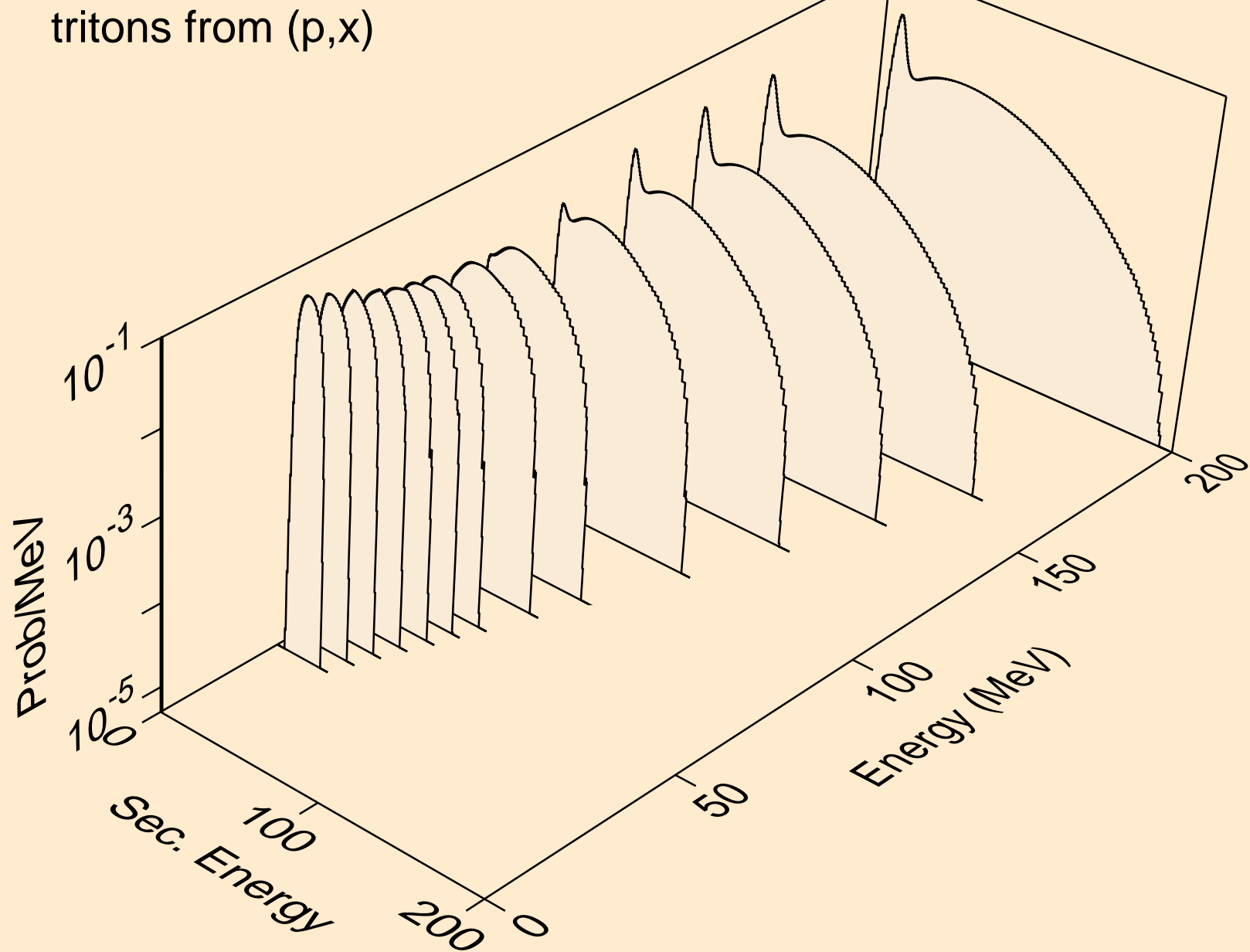

SM161 PROTON ACER TENDL-2023 LIBRARY; T=0.K
tritons from (p,n*)t

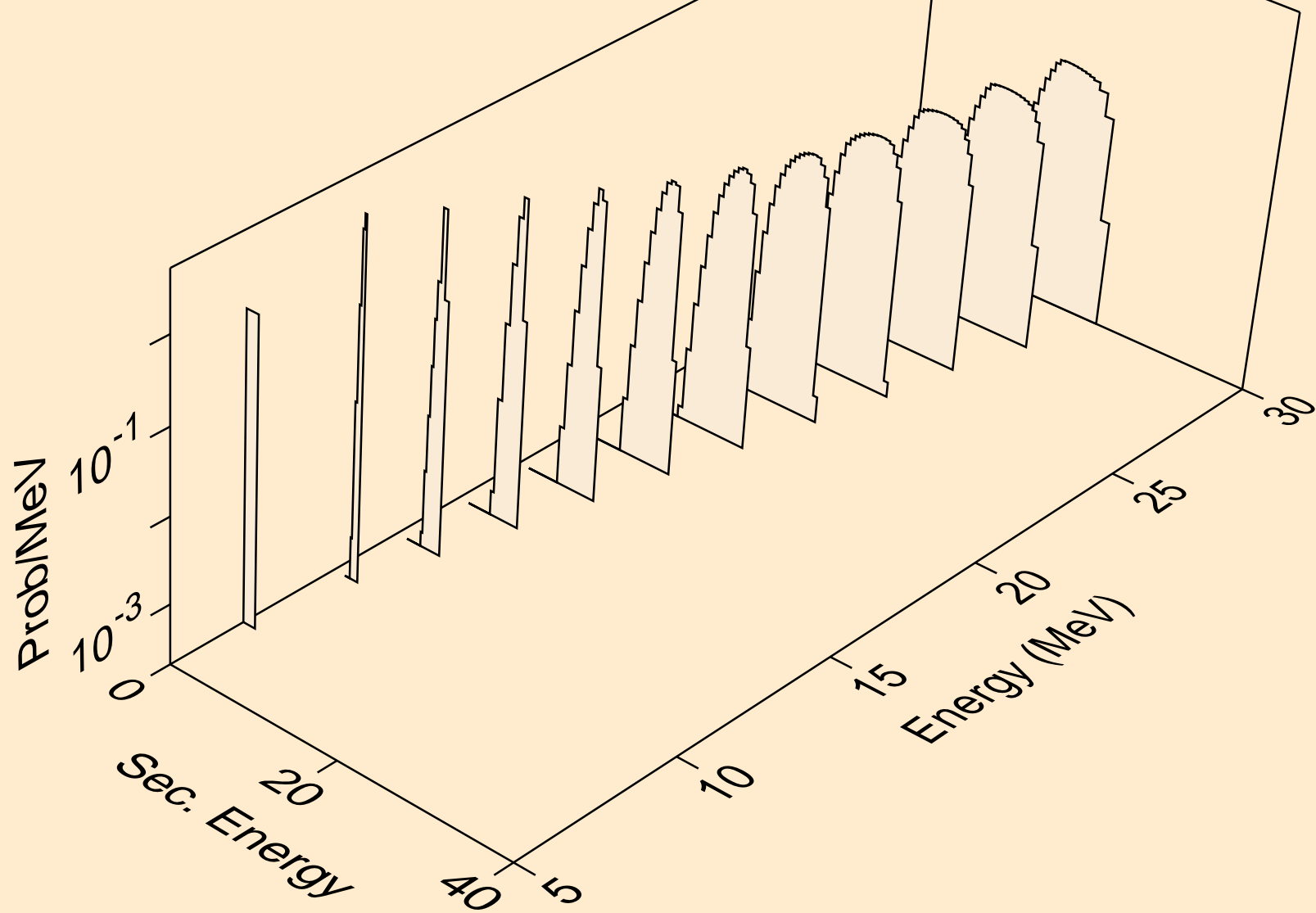

SM161 PROTON ACER TENDL-2023 LIBRARY; T=0.K
tritons from (p,t)

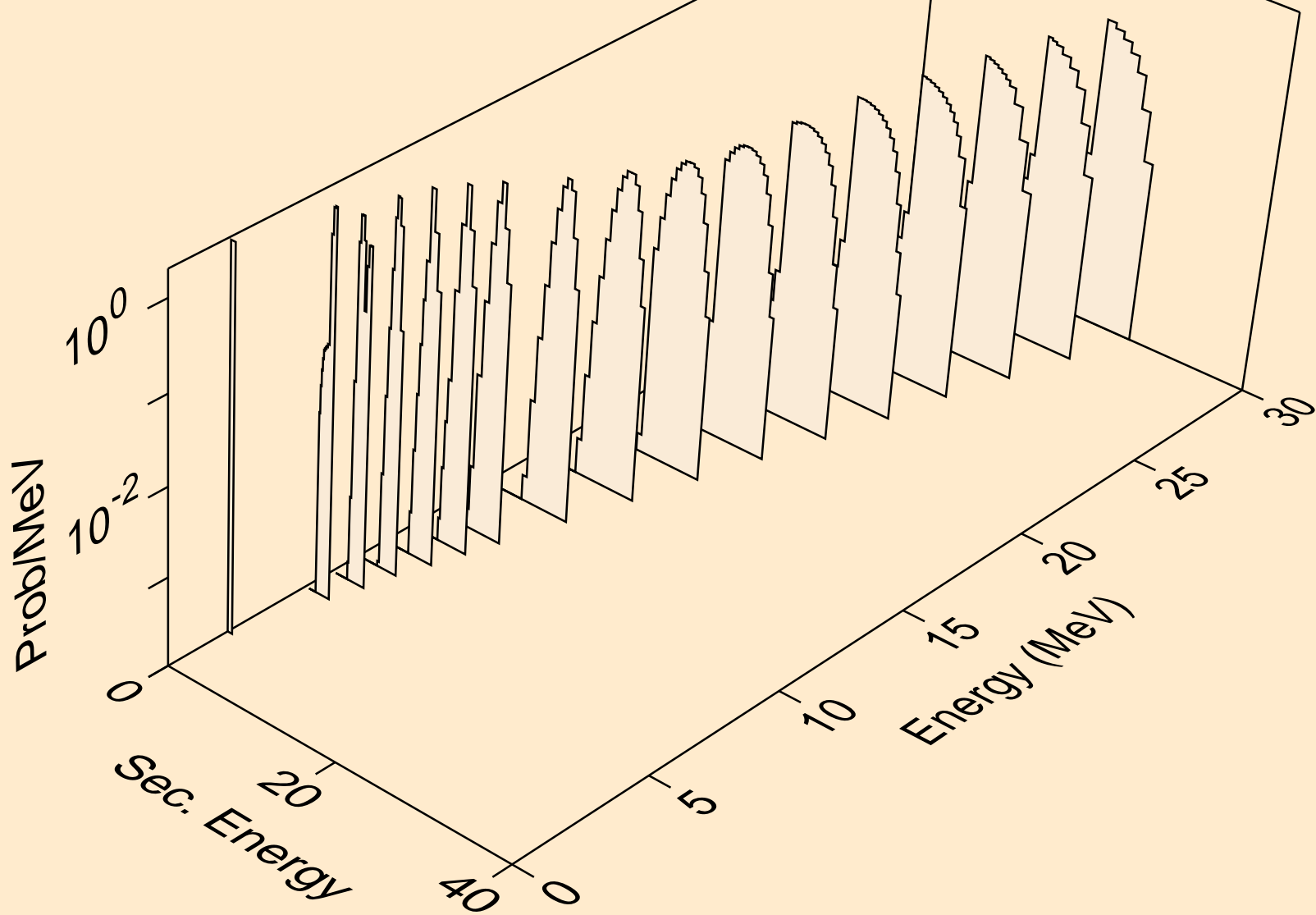

SM161 PROTON ACER TENDL-2023 LIBRARY; T=0.K
he3s from (p,x)

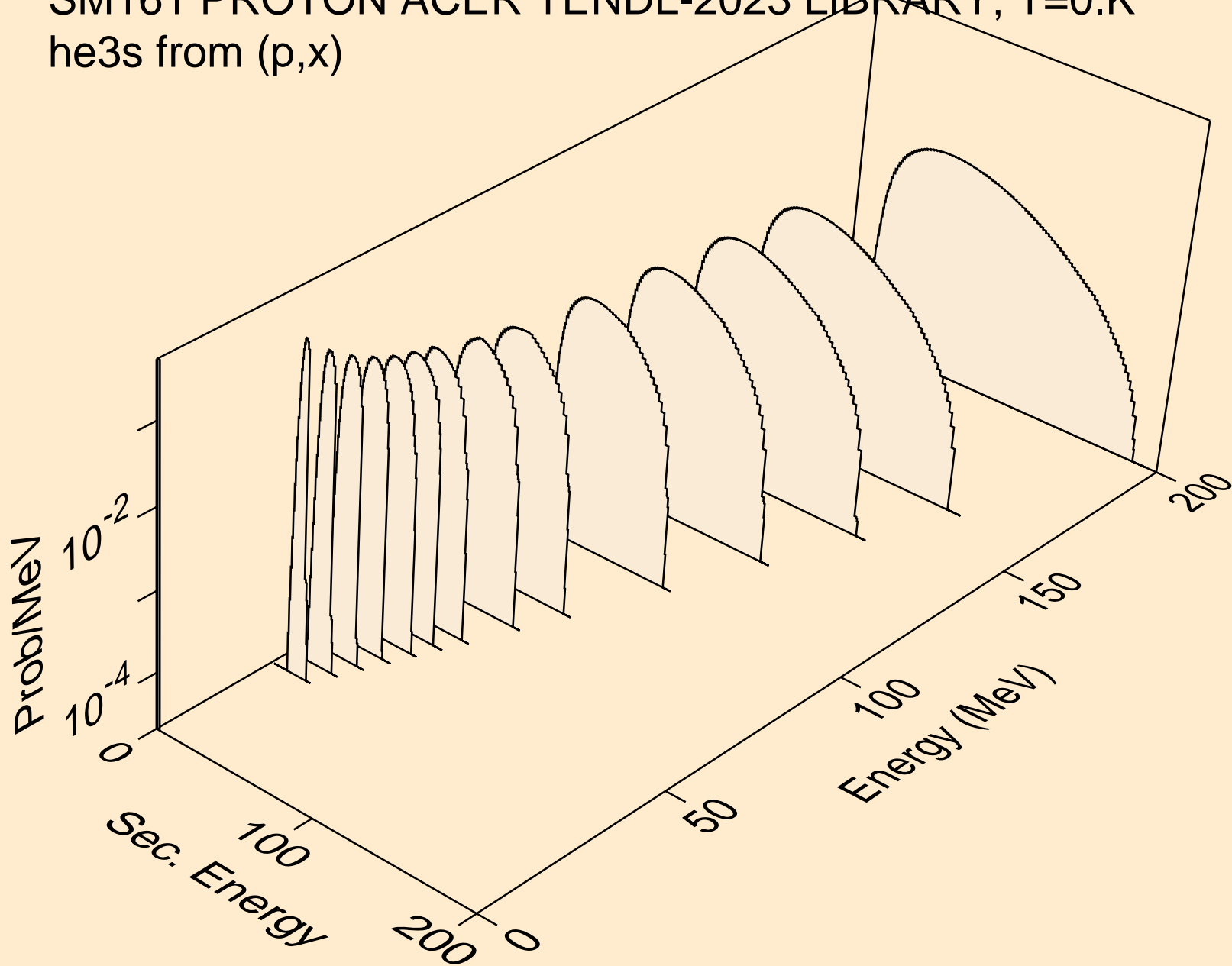

SM161 PROTON ACER TENDL-2023 LIBRARY; T=0.K
he3s from (p,n*)he3

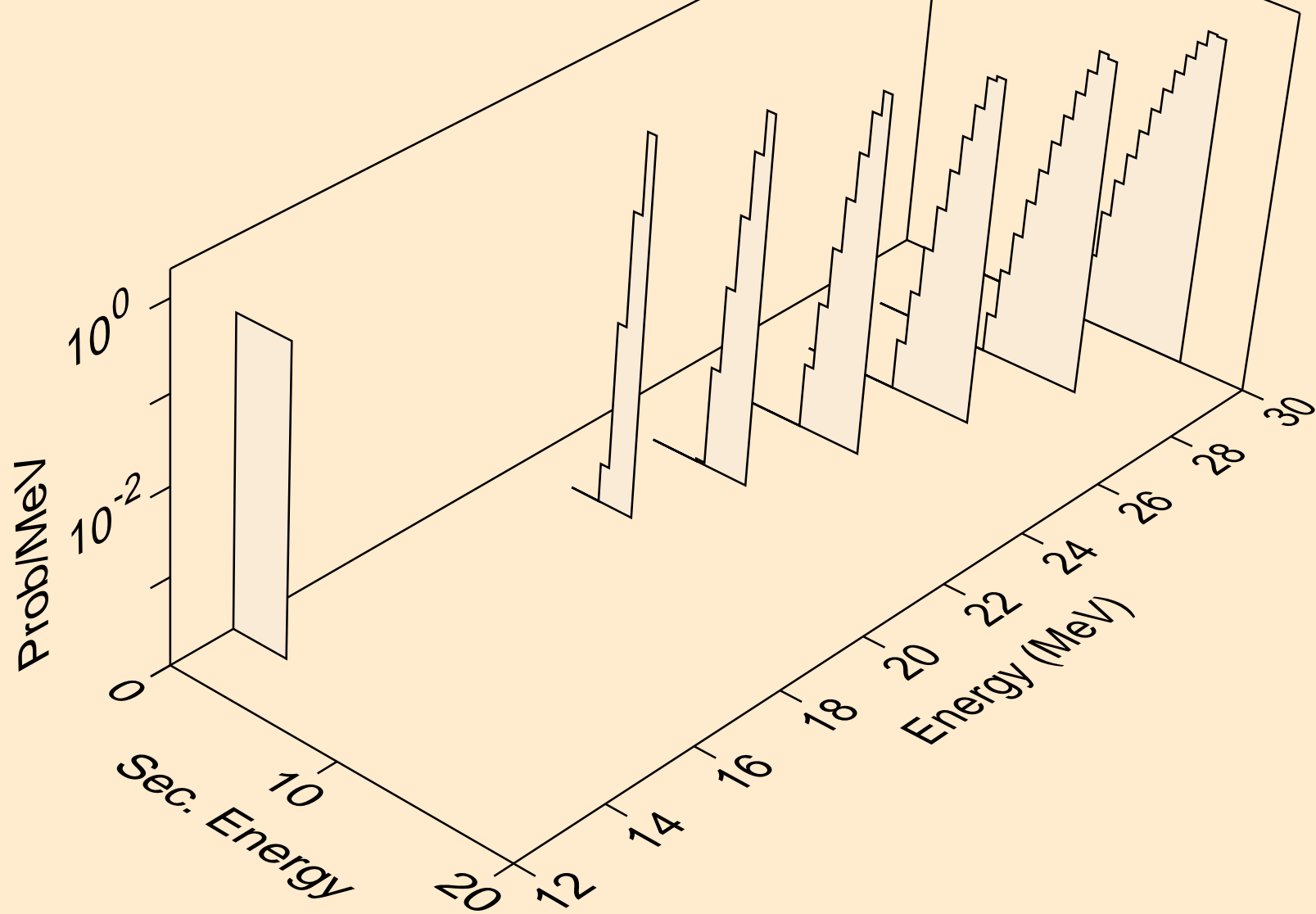

SM161 PROTON ACER TENDL-2023 LIBRARY; T=0.K
he3s from (p,he3)

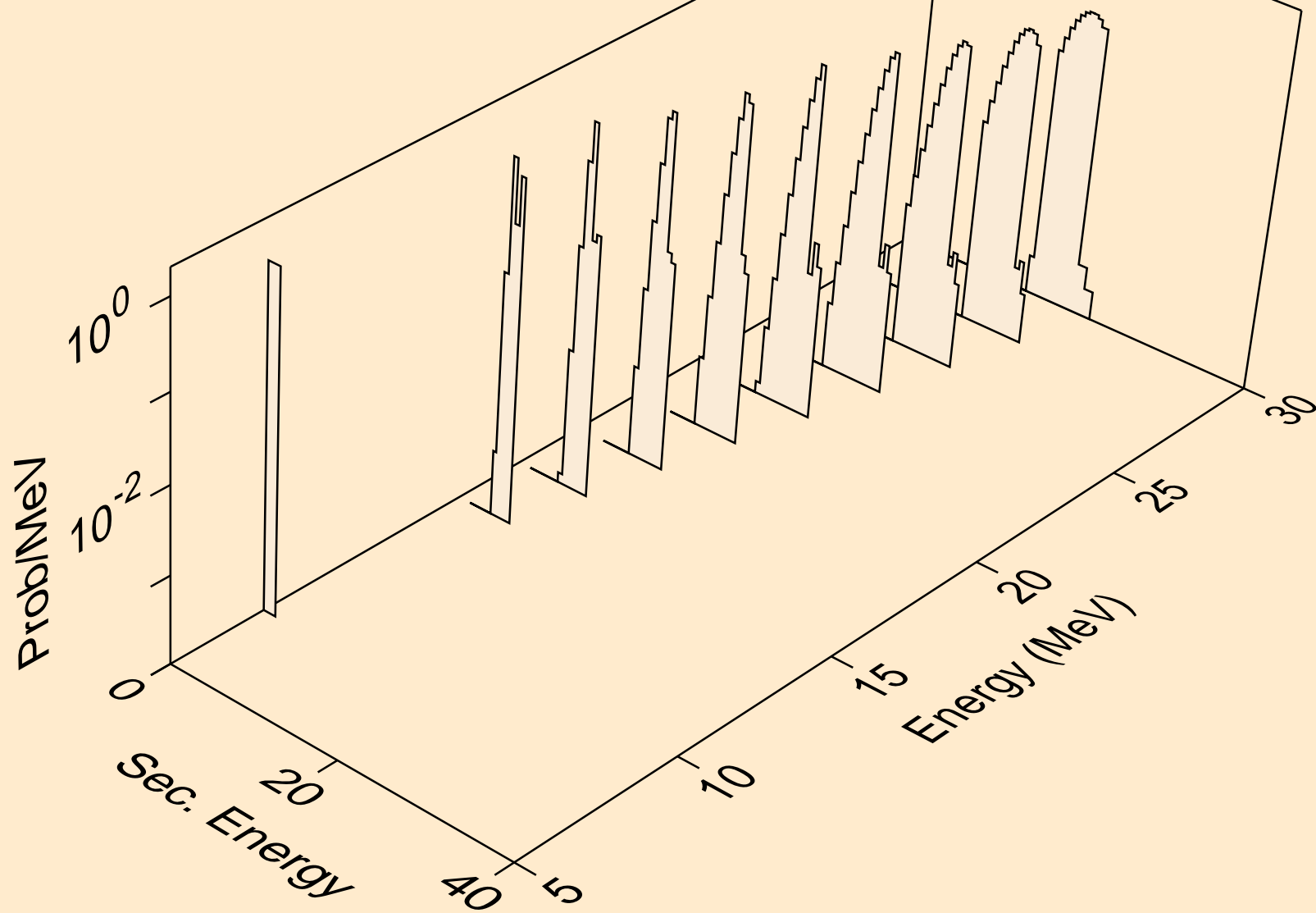

SM161 PROTON ACER TENDL-2023 LIBRARY; T=0.K
alphas from (p,x)

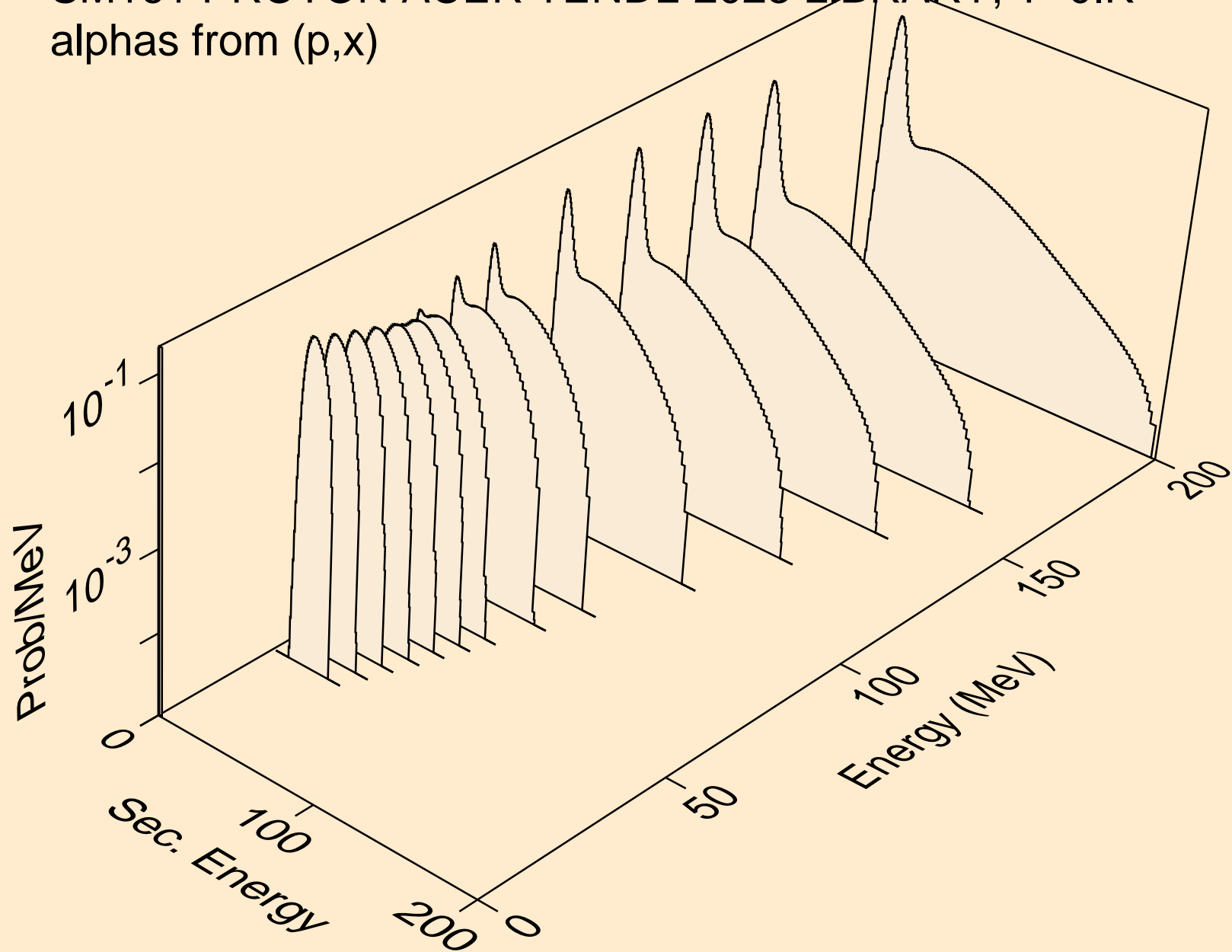

SM161 PROTON ACER TENDL-2023 LIBRARY; T=0.K
alphas from (p,n*)a

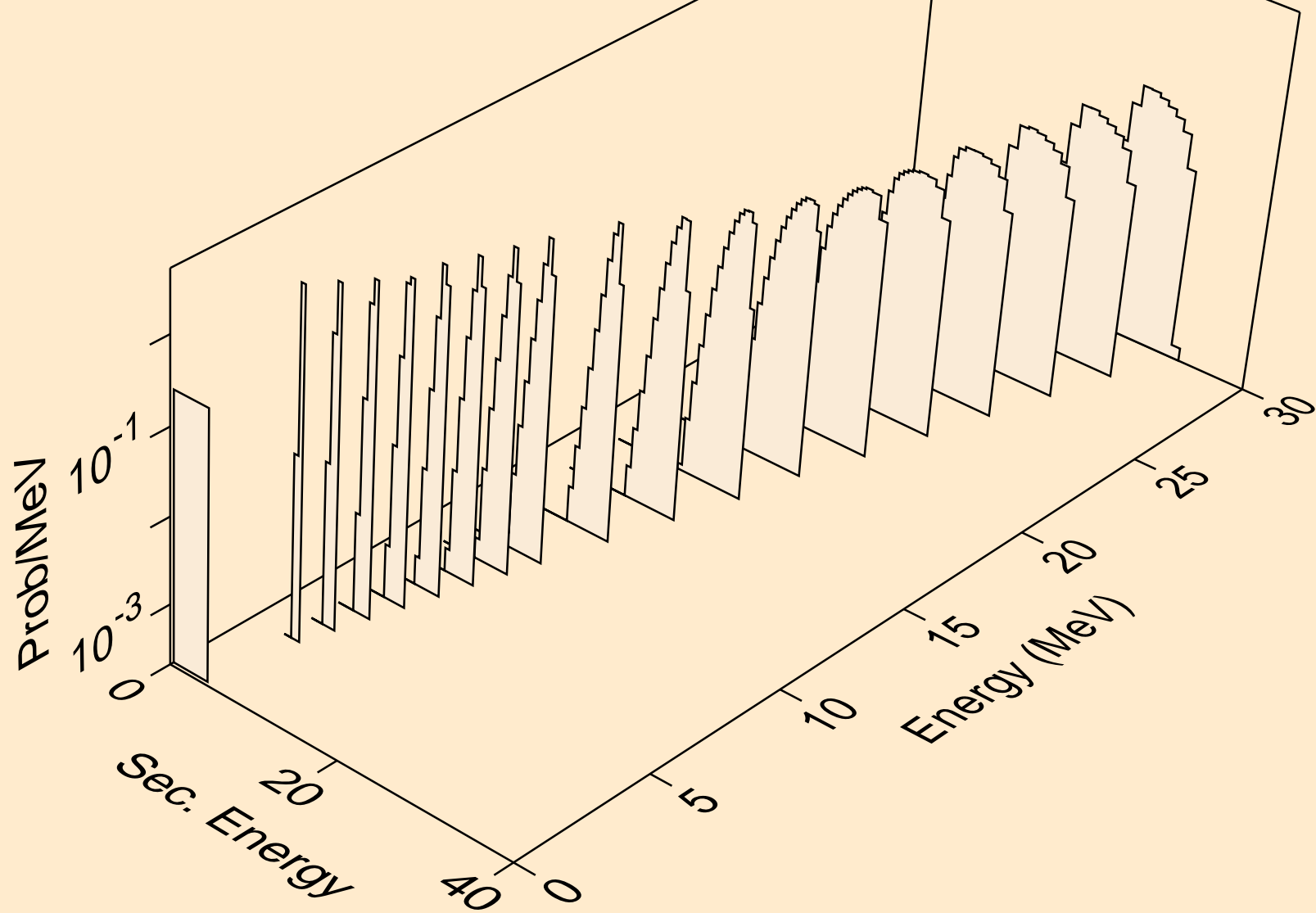

SM161 PROTON ACER TENDL-2023 LIBRARY; T=0.K
alphas from (p,2n)a

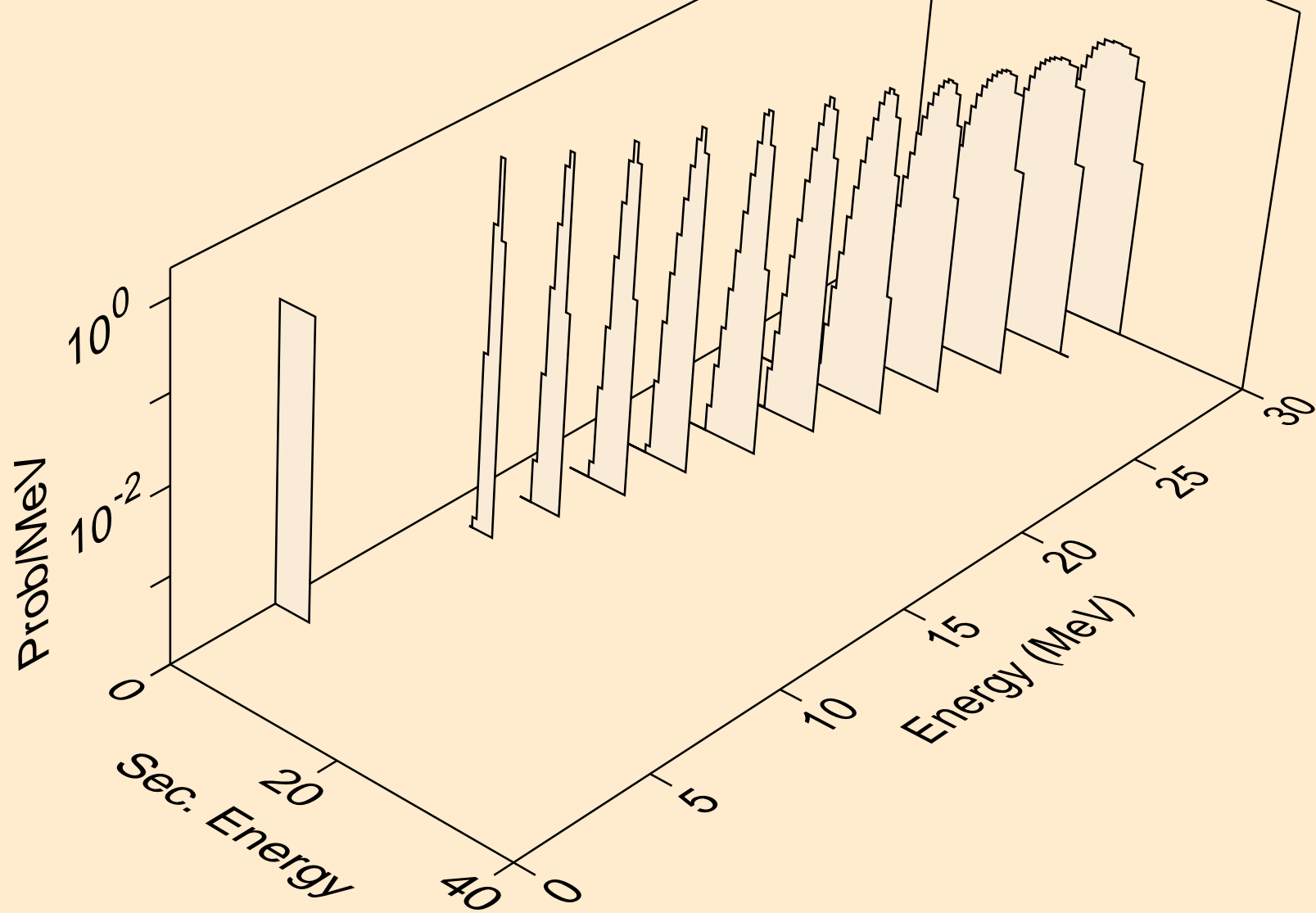

SM161 PROTON ACER TENDL-2023 LIBRARY; T=0.K
alphas from (p,3n)a

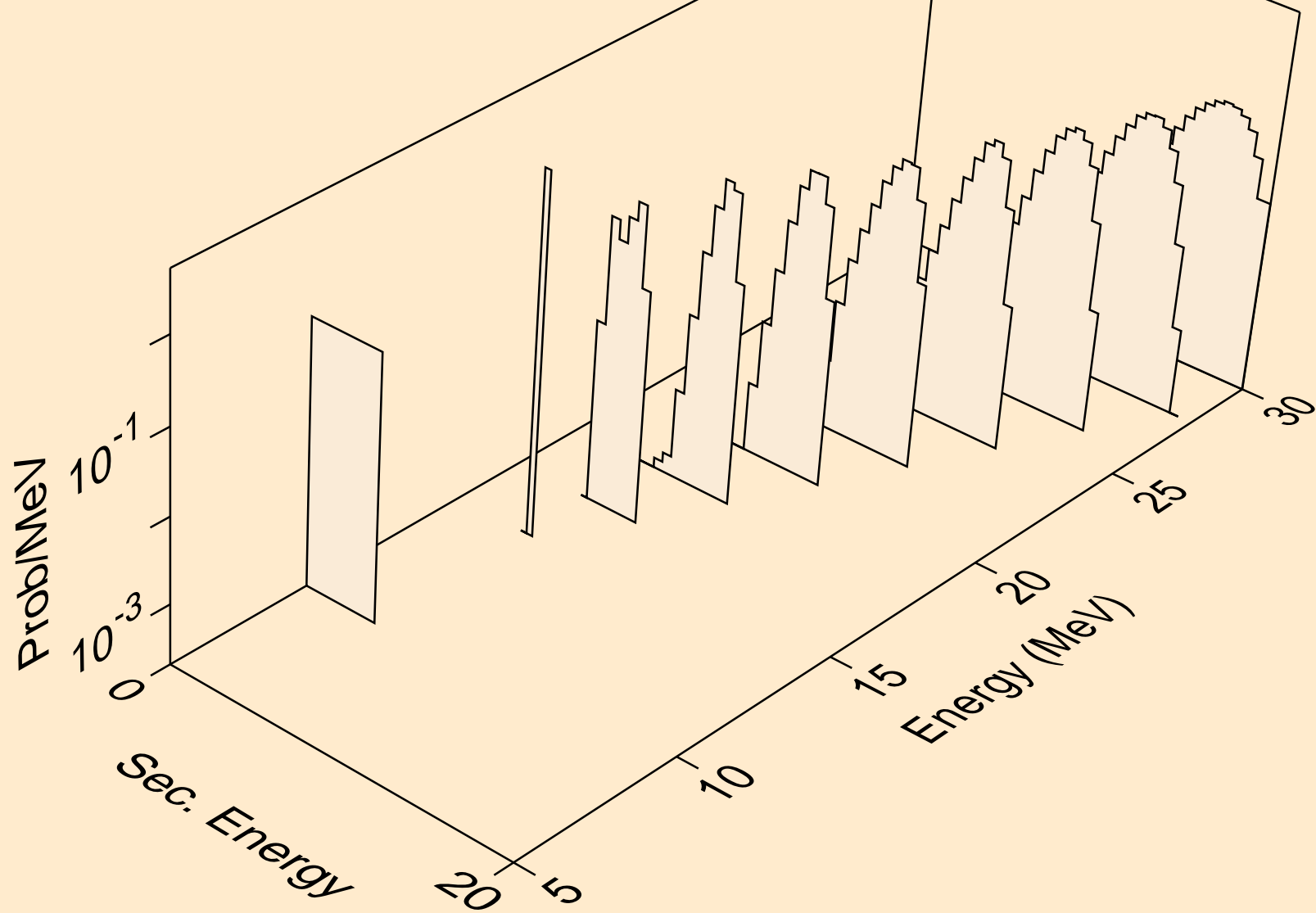

SM161 PROTON ACER TENDL-2023 LIBRARY; T=0.K
alphas from (p,a)

