

# W173 PROTON ACER TENDL-2023 LIBRARY; T=0.K

## Principal cross sections

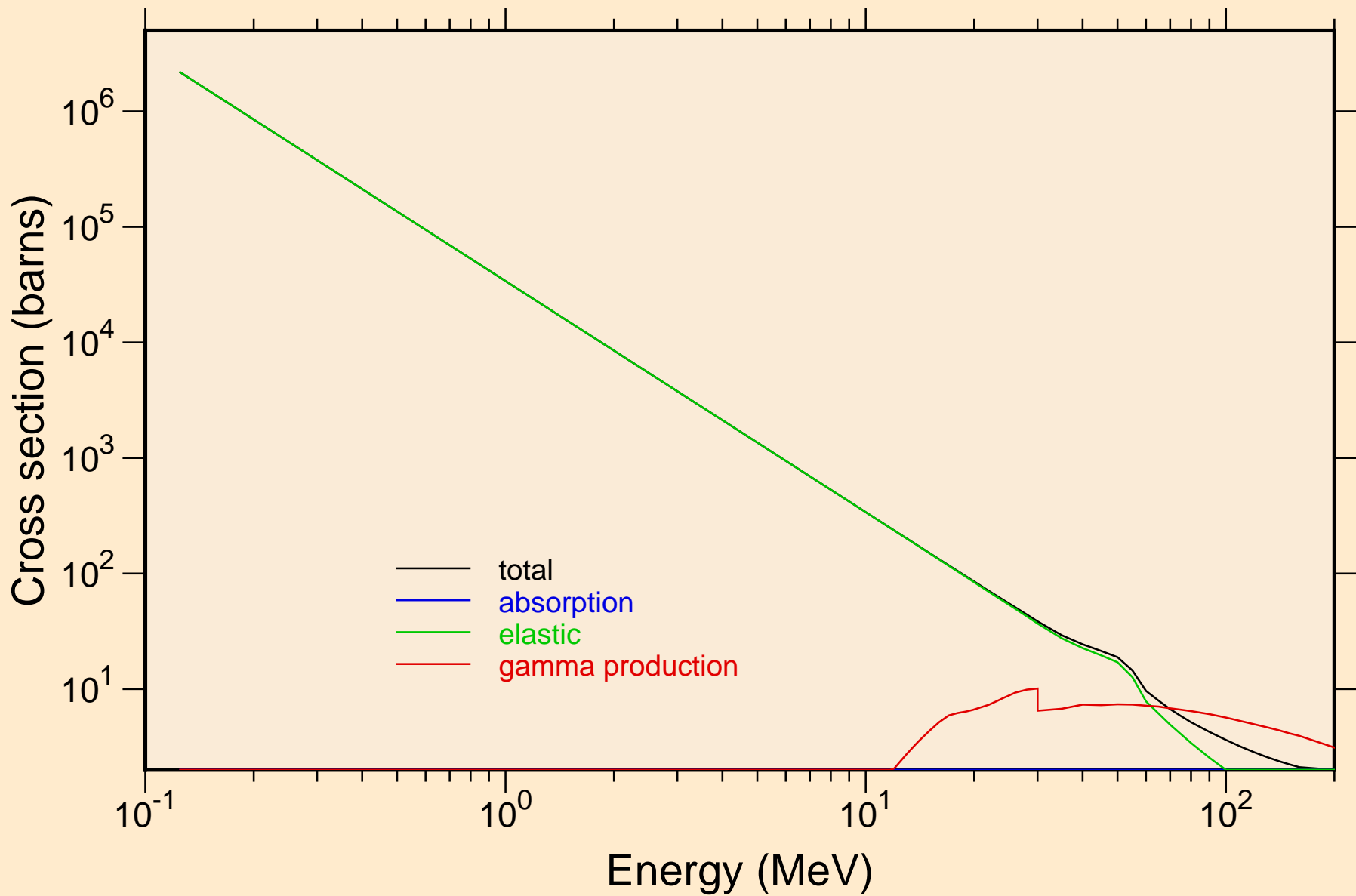

W173 PROTON ACER TENDL-2023 LIBRARY; T=0.K  
Heating

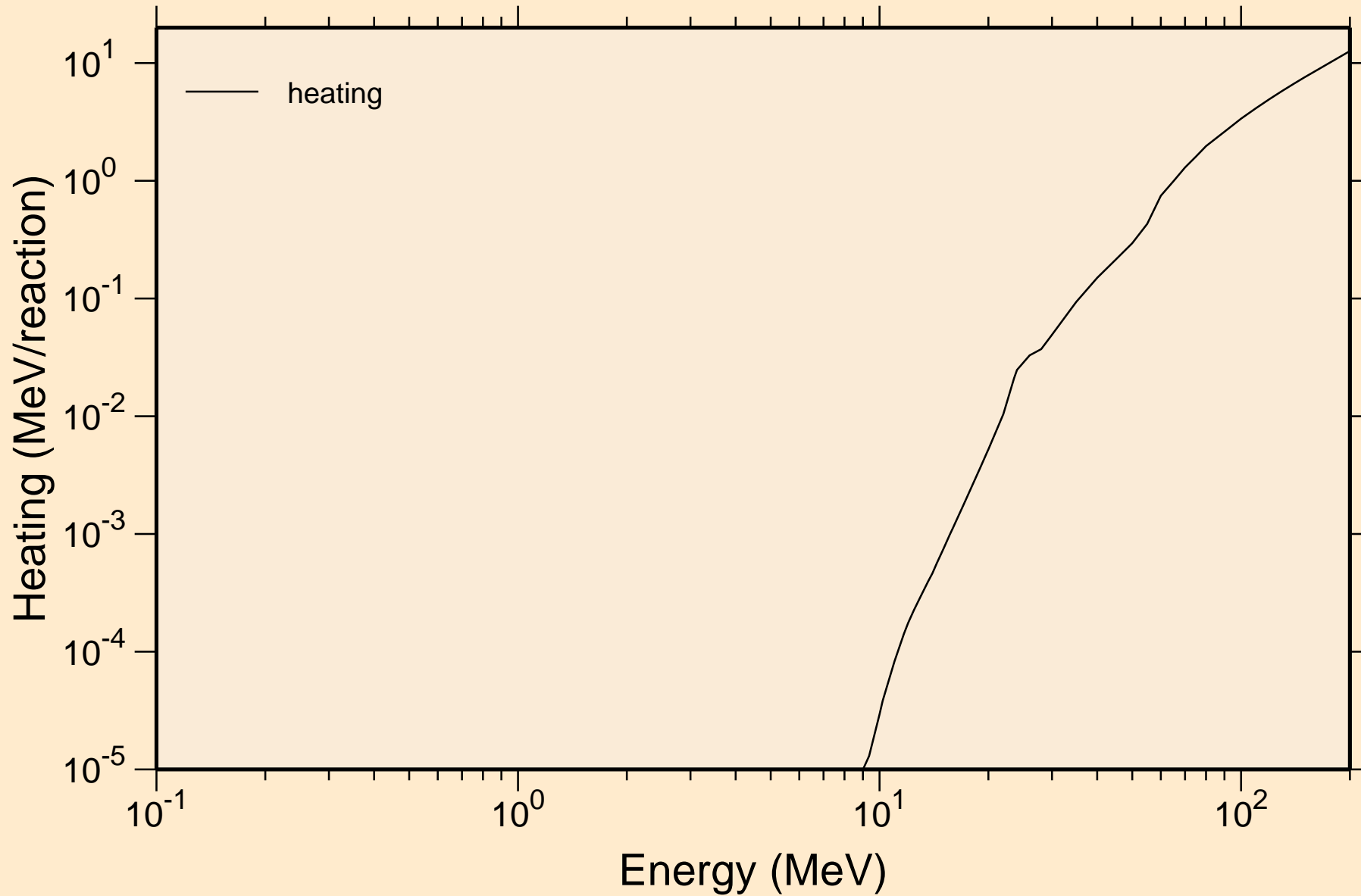

# W173 PROTON ACER TENDL-2023 LIBRARY; T=0.K

## Principal cross sections

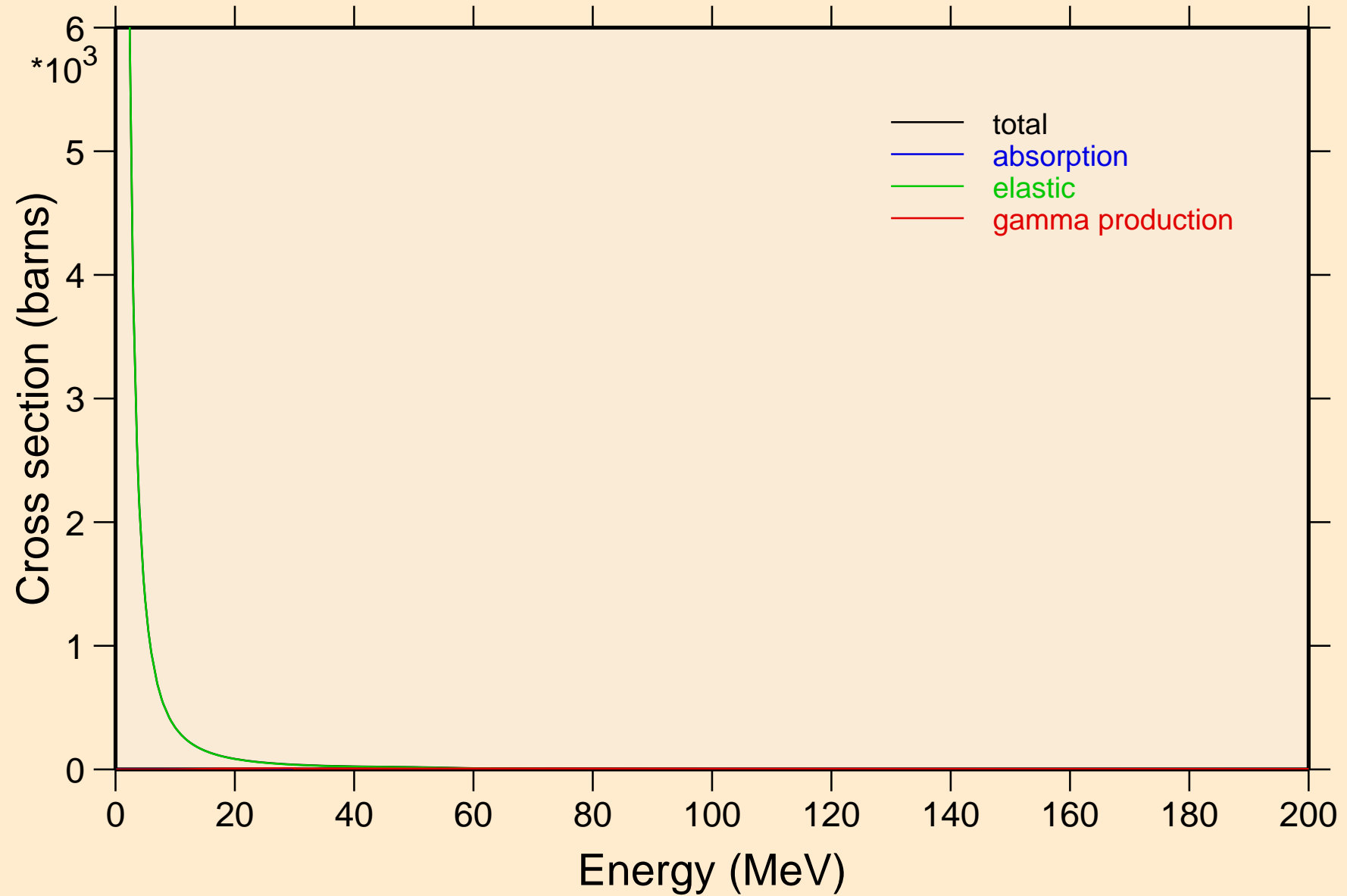

W173 PROTON ACER TENDL-2023 LIBRARY; T=0.K

Heating

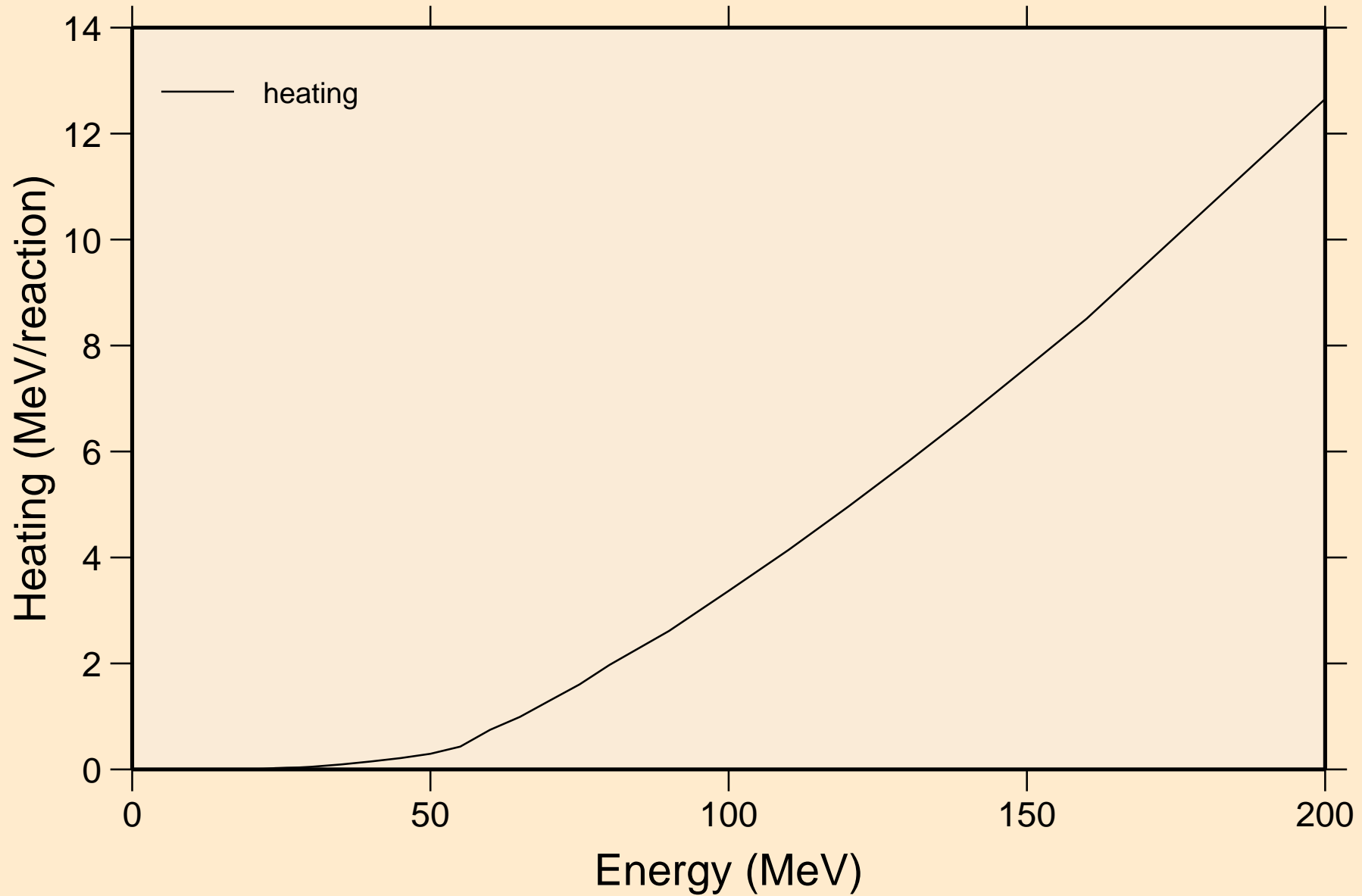

W173 PROTON ACER TENDL-2023 LIBRARY; T=0.K  
Threshold reactions

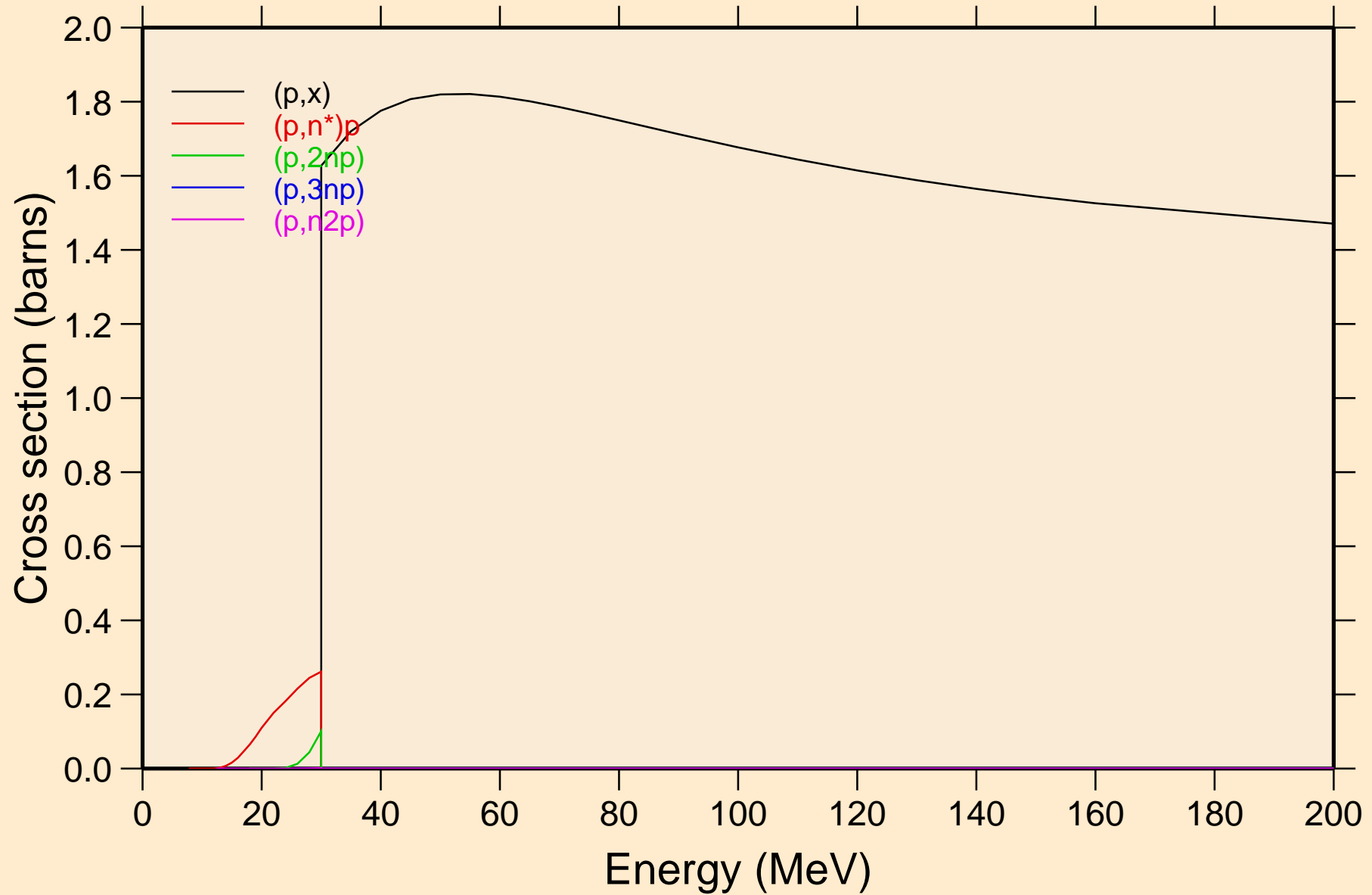

W173 PROTON ACER TENDL-2023 LIBRARY; T=0.K  
Threshold reactions

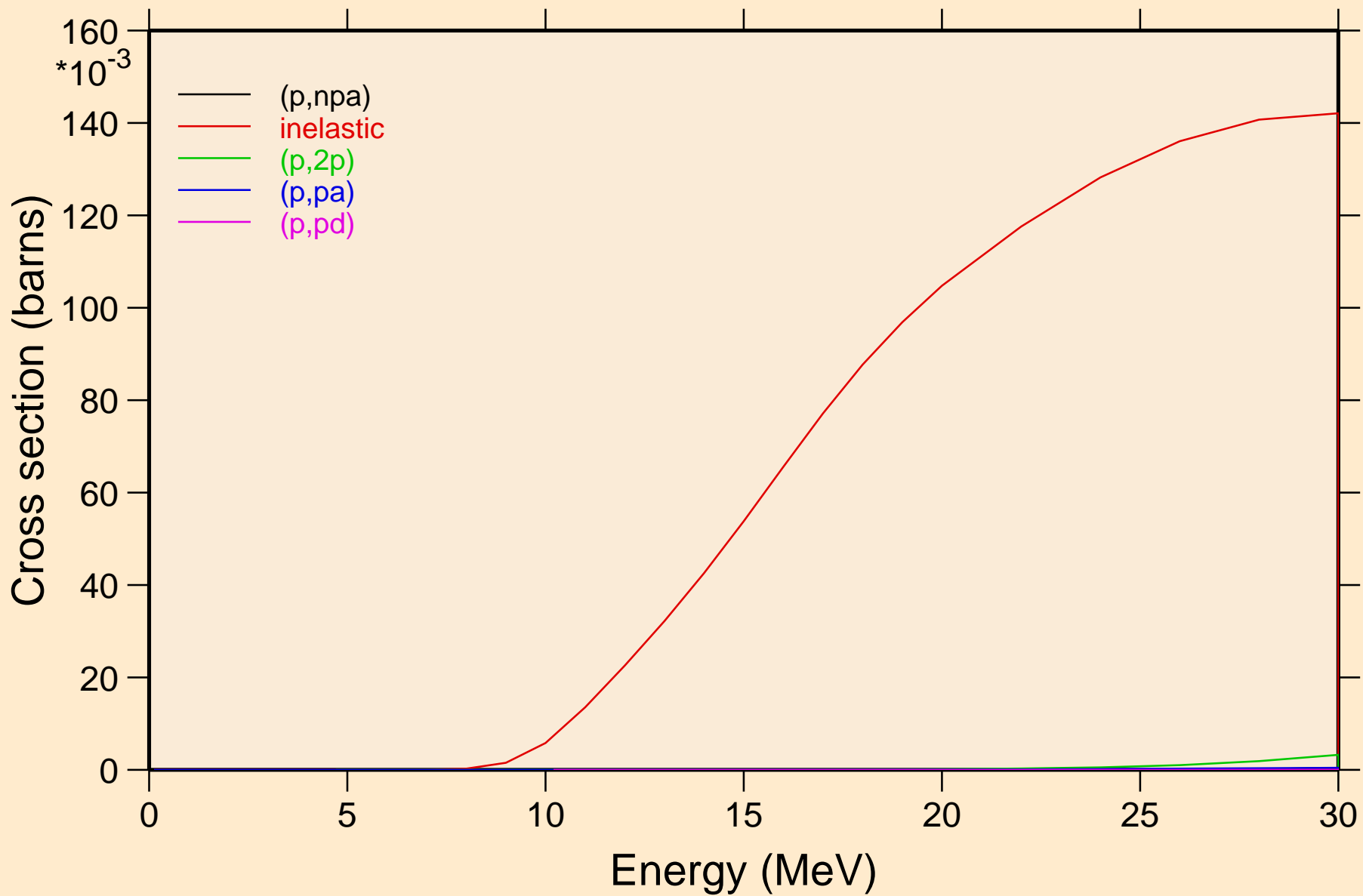

W173 PROTON ACER TENDL-2023 LIBRARY; T=0.K  
Threshold reactions

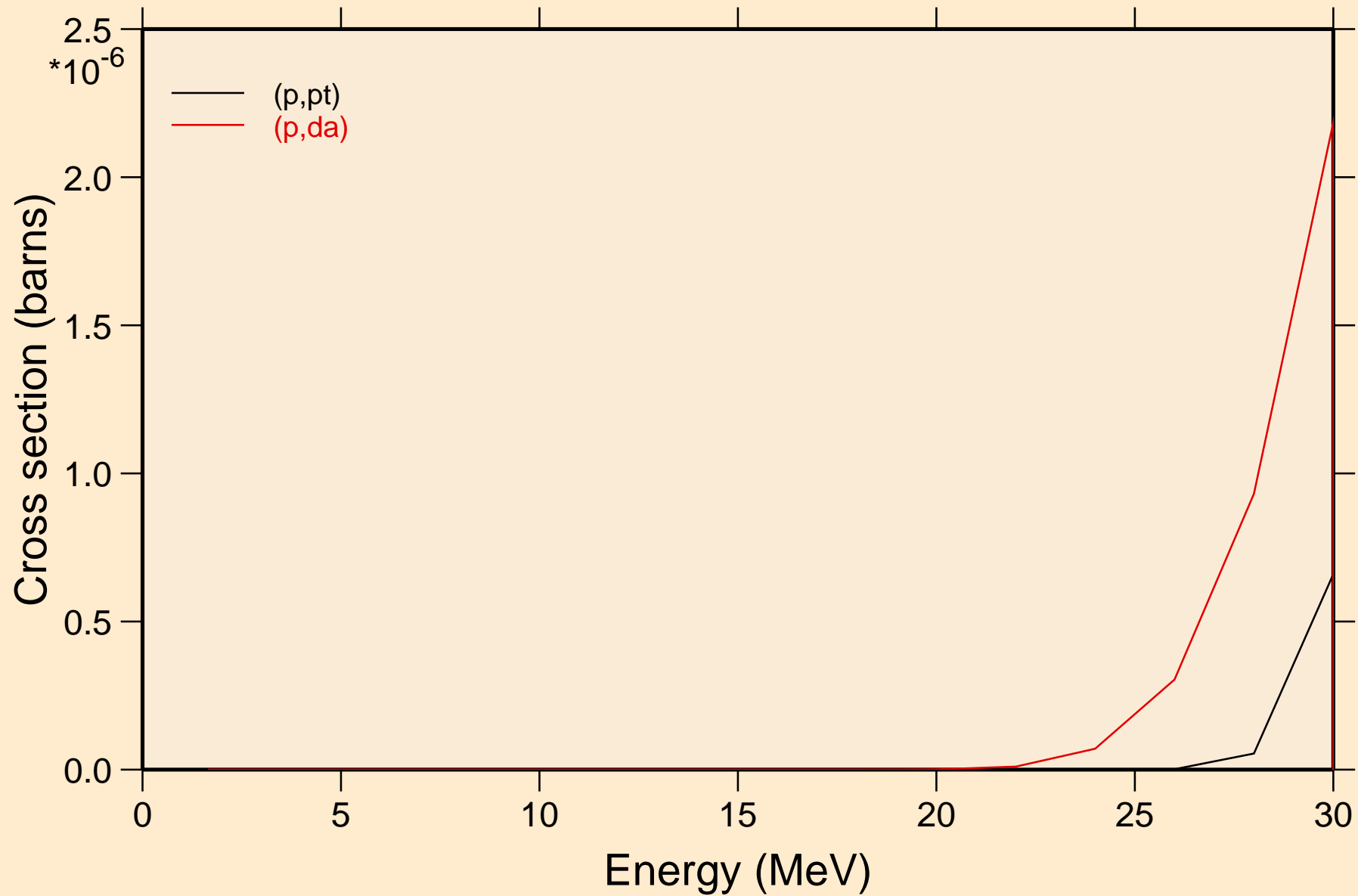

W173 PROTON ACER TENDL-2023 LIBRARY; T=0.K  
angular distribution for elastic

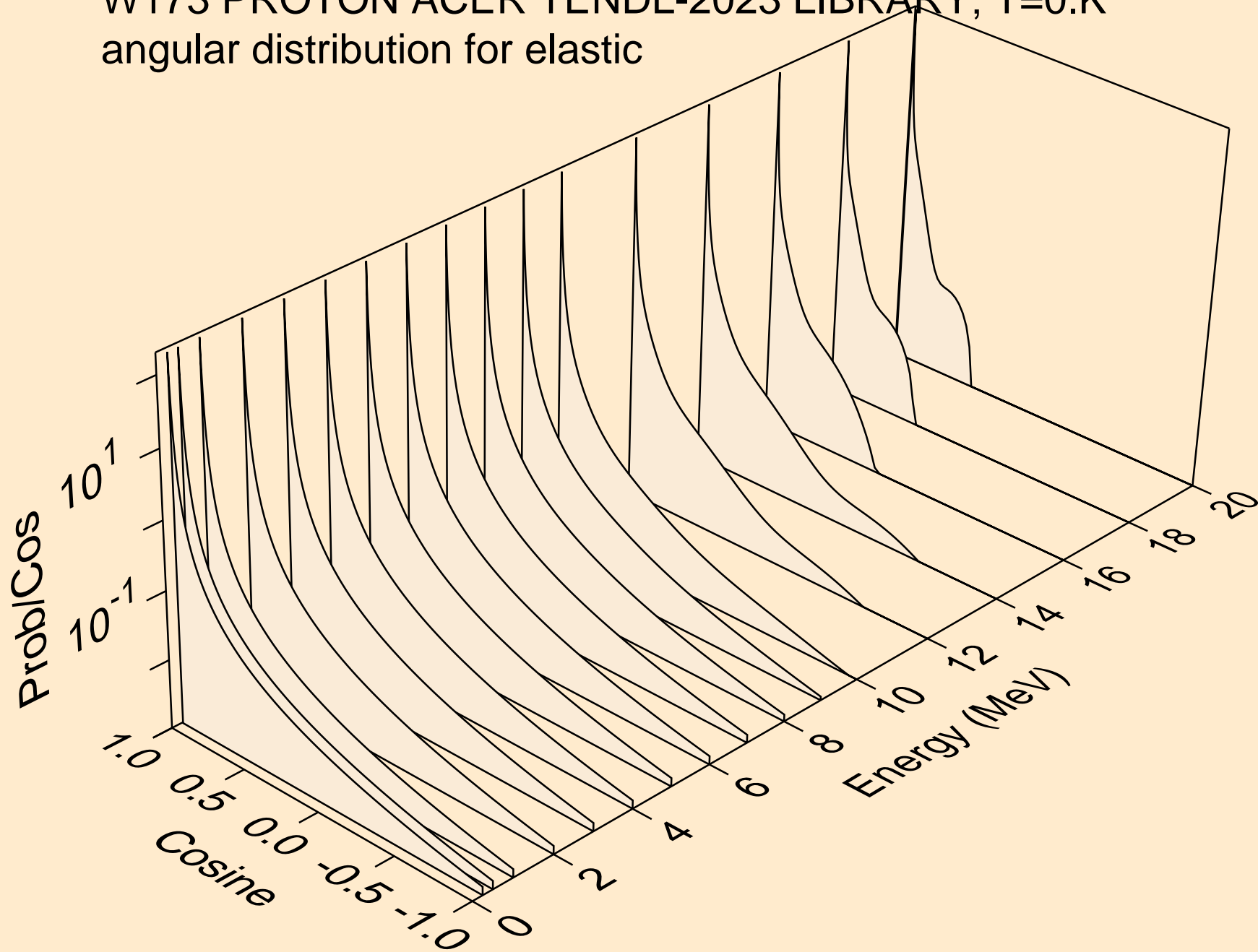



W173 PROTON ACER TENDL-2023 LIBRARY; T=0.K  
angular distribution for elastic

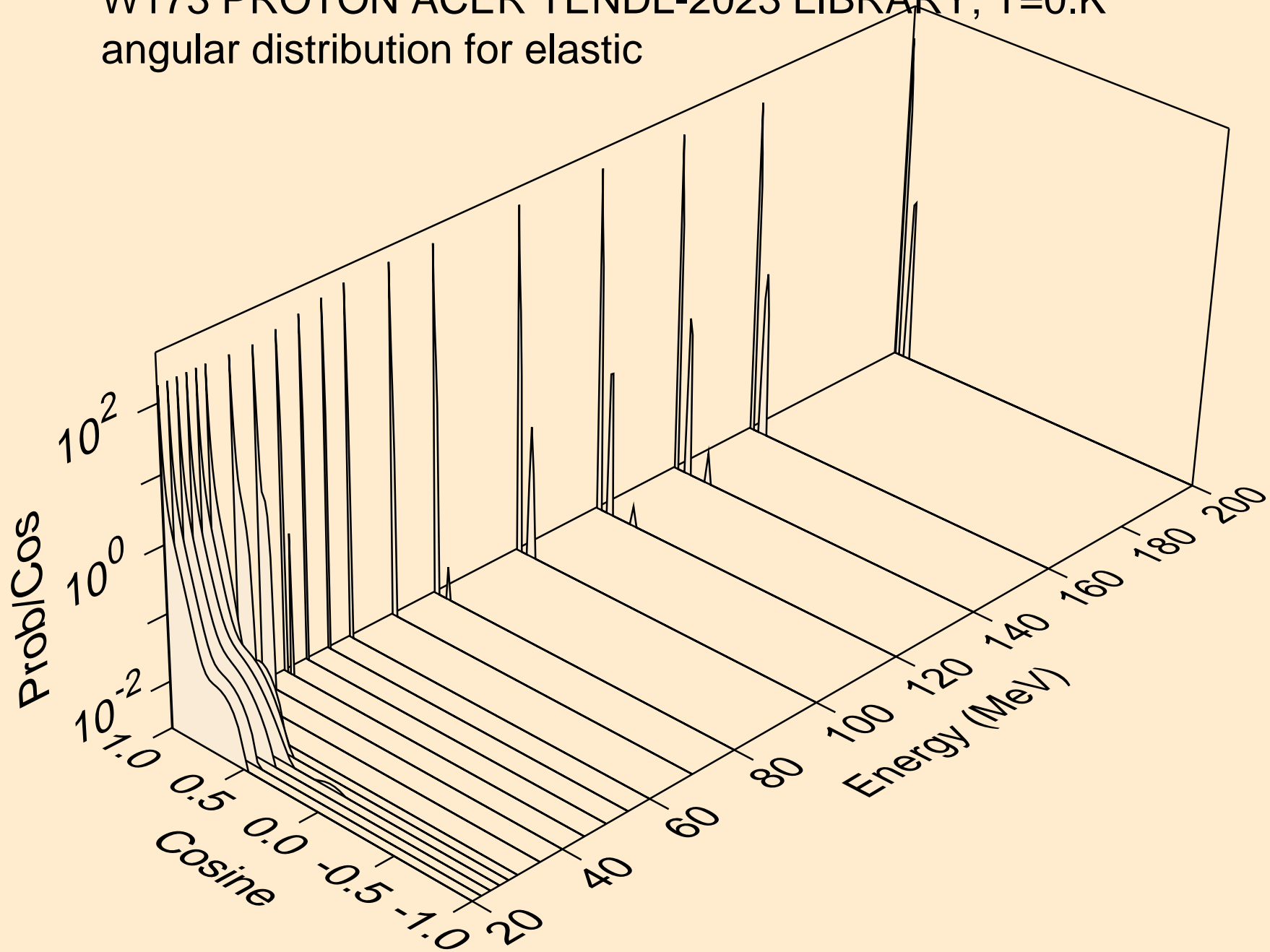

W173 PROTON ACER TENDL-2023 LIBRARY; T=0.K  
Proton emission for (p,x)

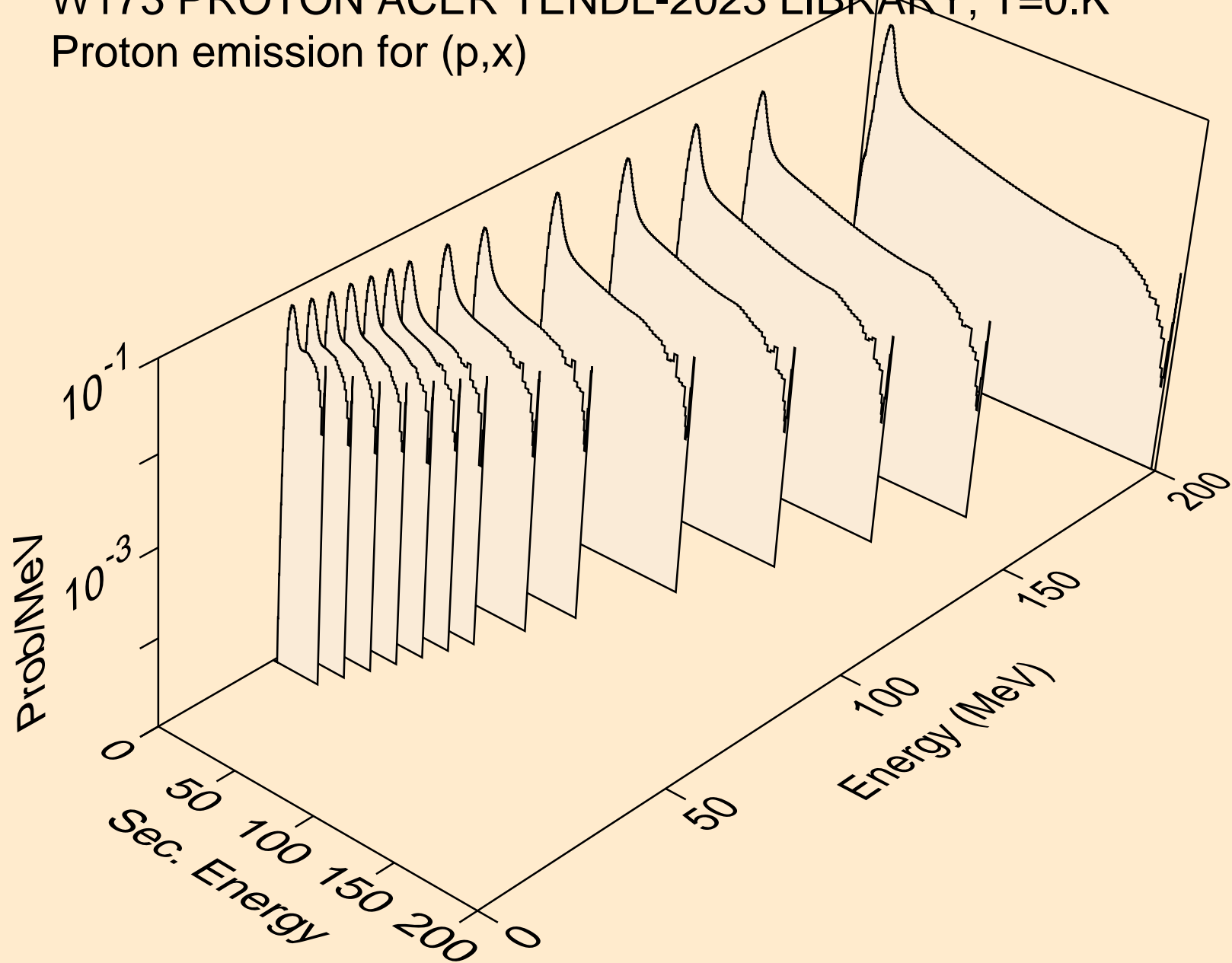

W173 PROTON ACER TENDL-2023 LIBRARY; T=0.K  
Proton emission for (p,n\*)p

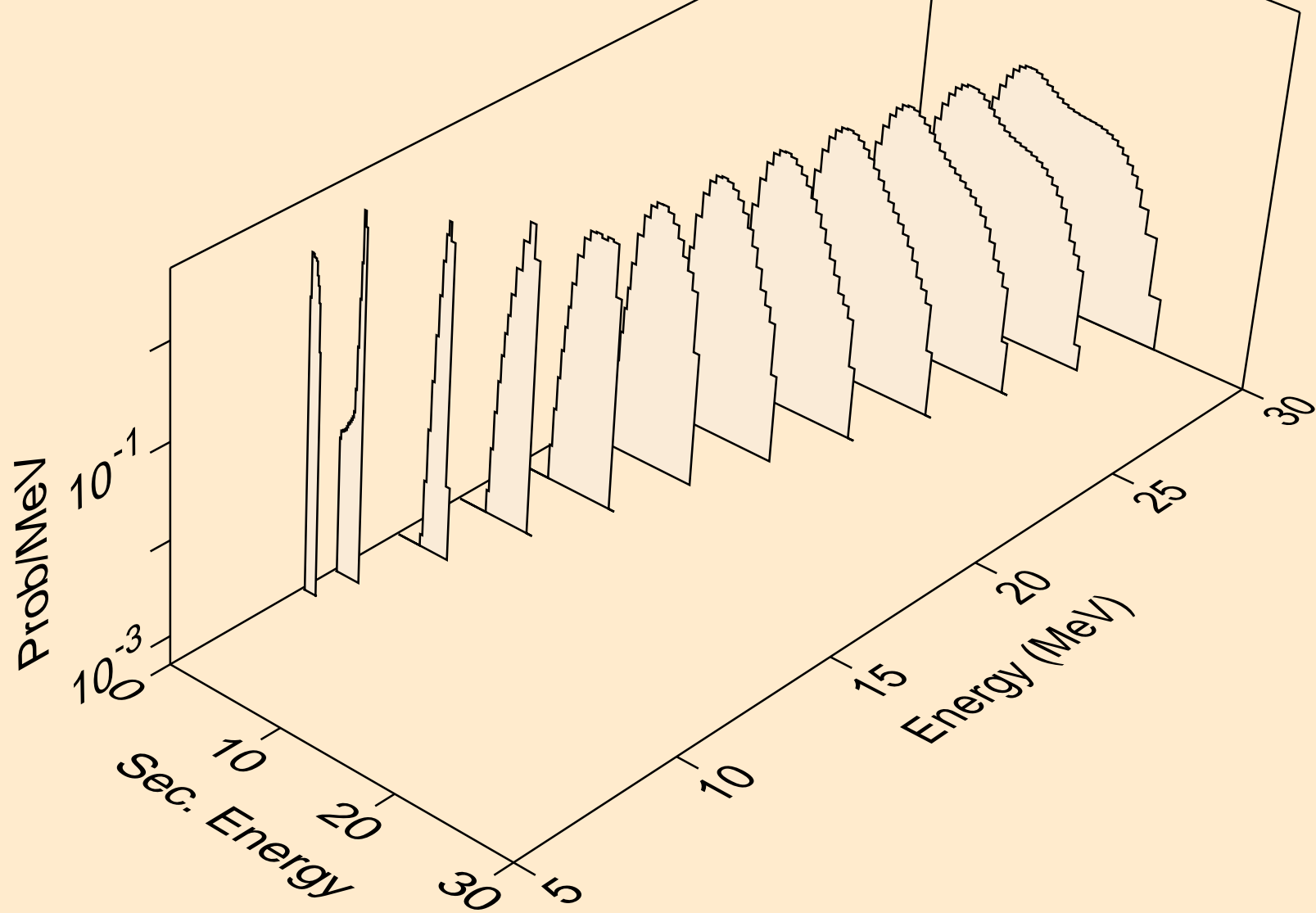

W173 PROTON ACER TENDL-2023 LIBRARY; T=0.K  
Proton emission for (p,2np)

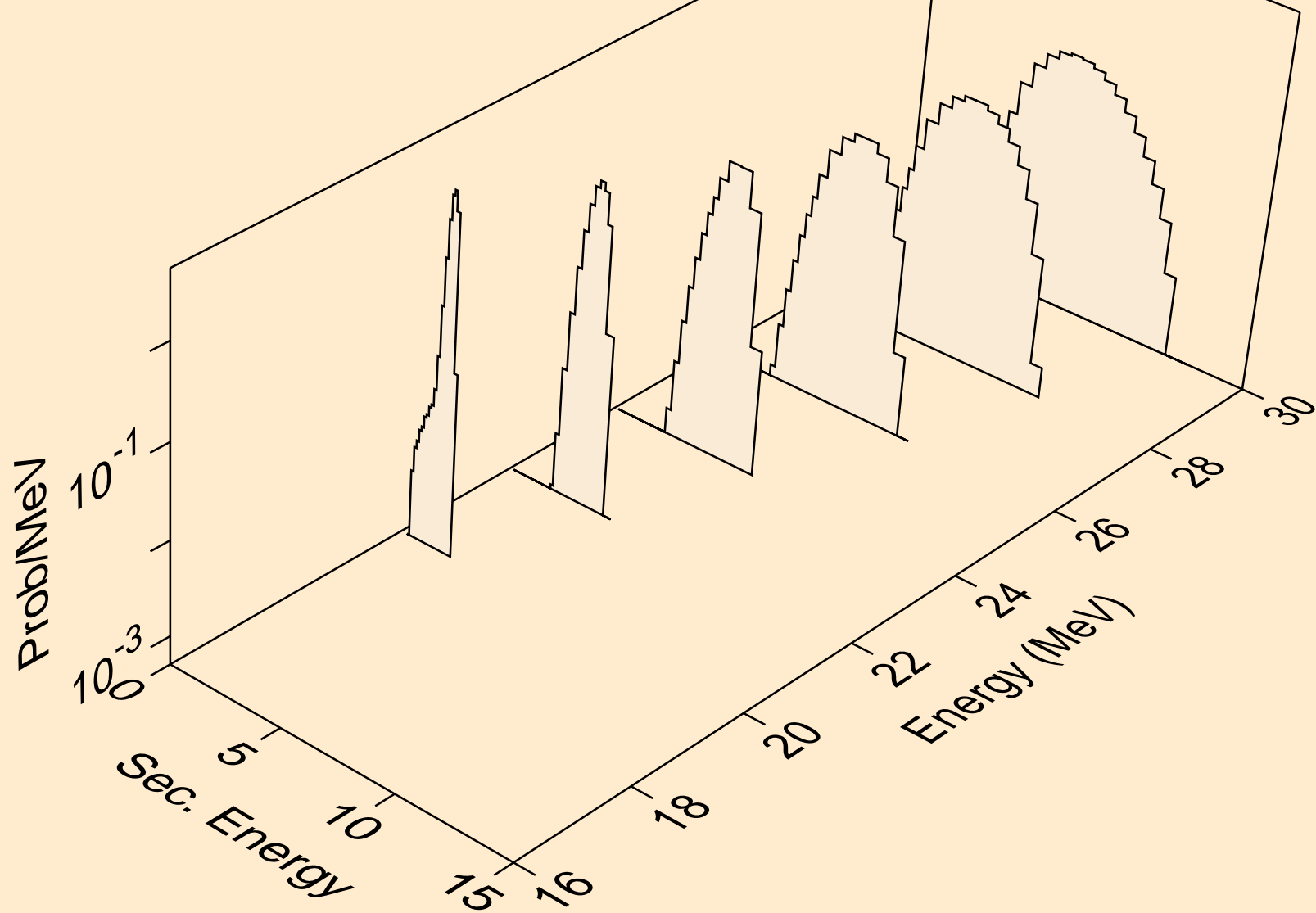

W173 PROTON ACER TENDL-2023 LIBRARY; T=0.K  
Proton emission for (p,3np)

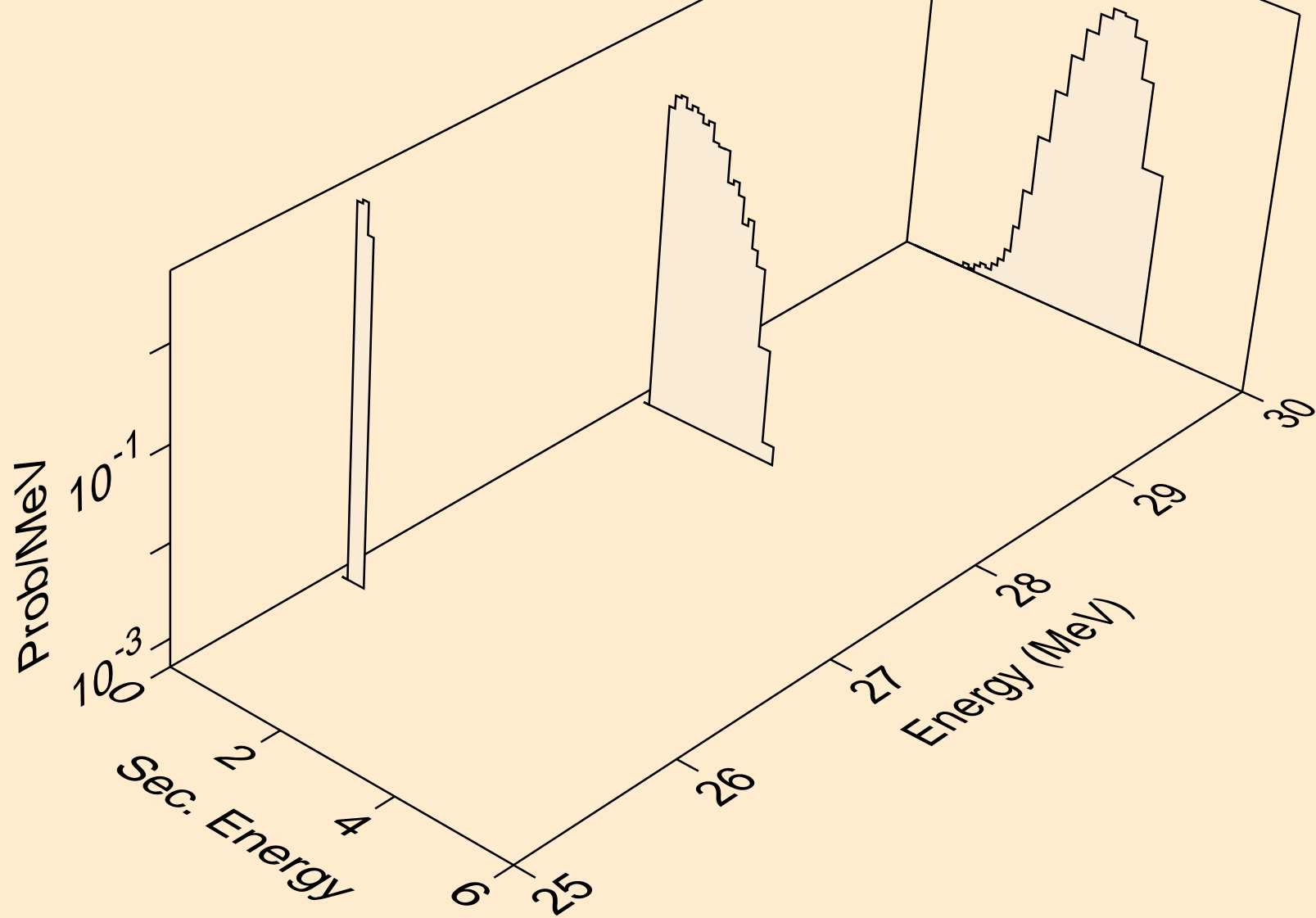

W173 PROTON ACER TENDL-2023 LIBRARY; T=0.K  
Proton emission for (p,n2p)

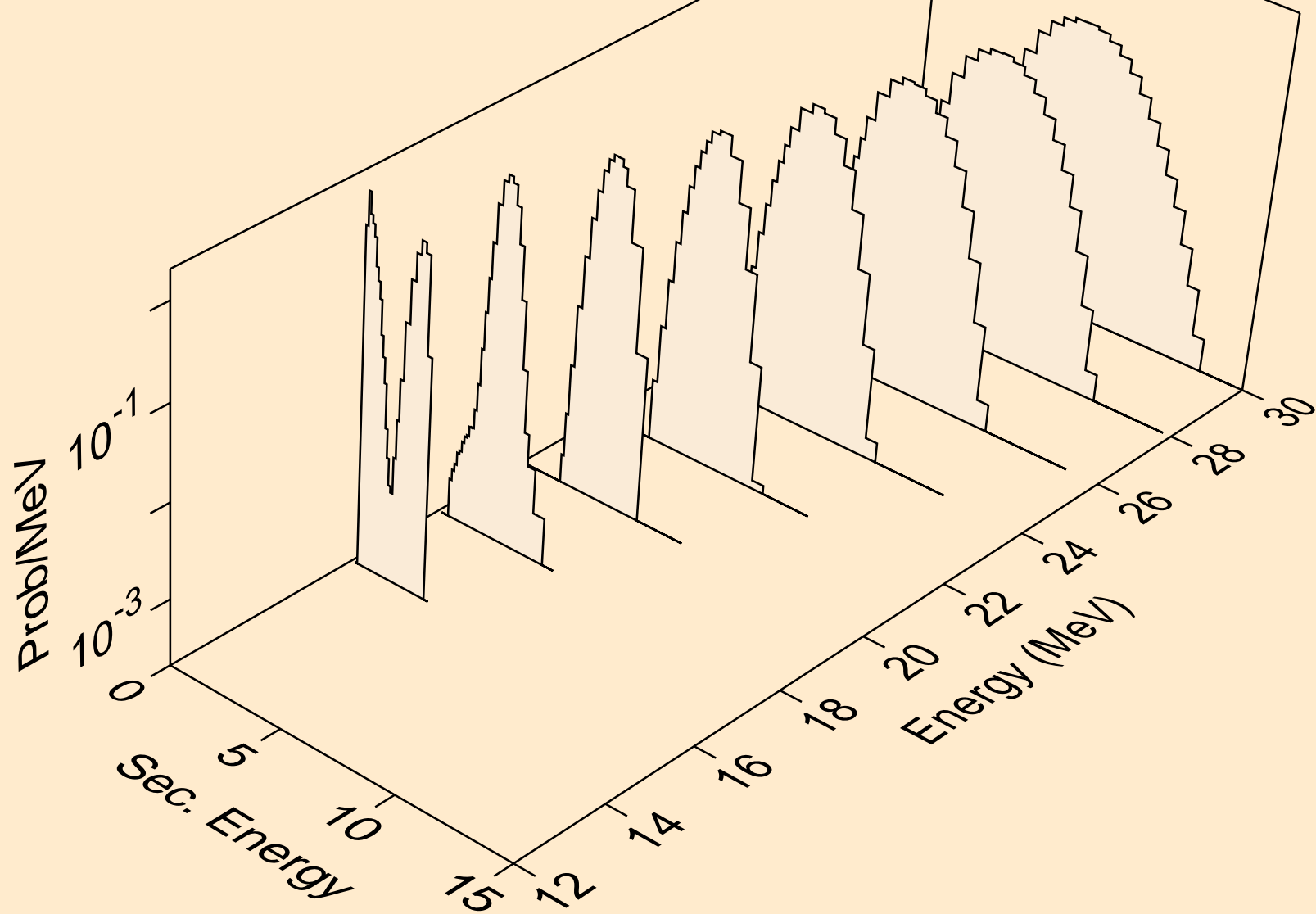

W173 PROTON ACER TENDL-2023 LIBRARY; T=0.K  
Proton emission for (p,npa)

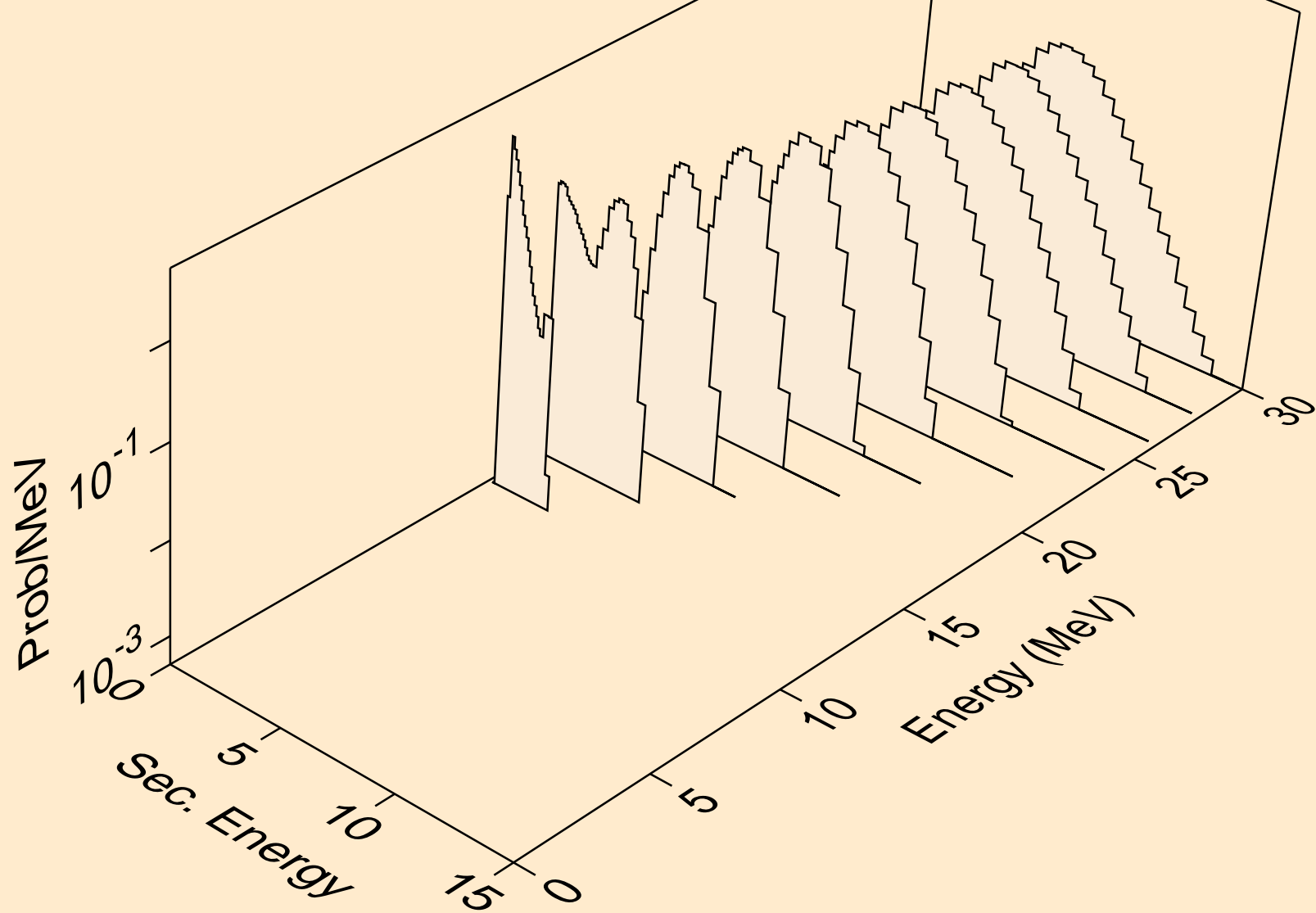

W173 PROTON ACER TENDL-2023 LIBRARY; T=0.K  
Proton emission for inelastic

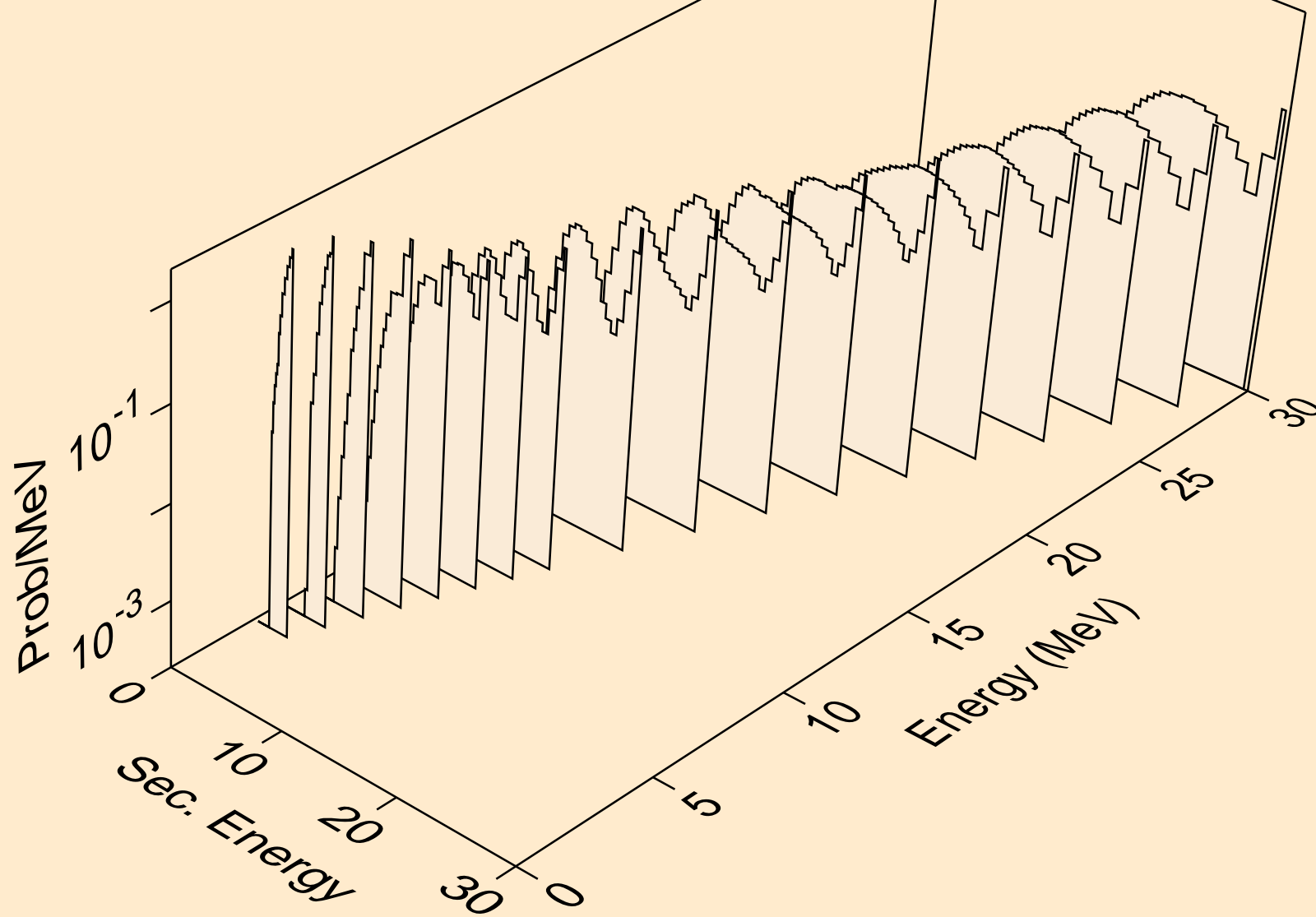



W173 PROTON ACER TENDL-2023 LIBRARY; T=0.K  
Proton emission for (p,2p)

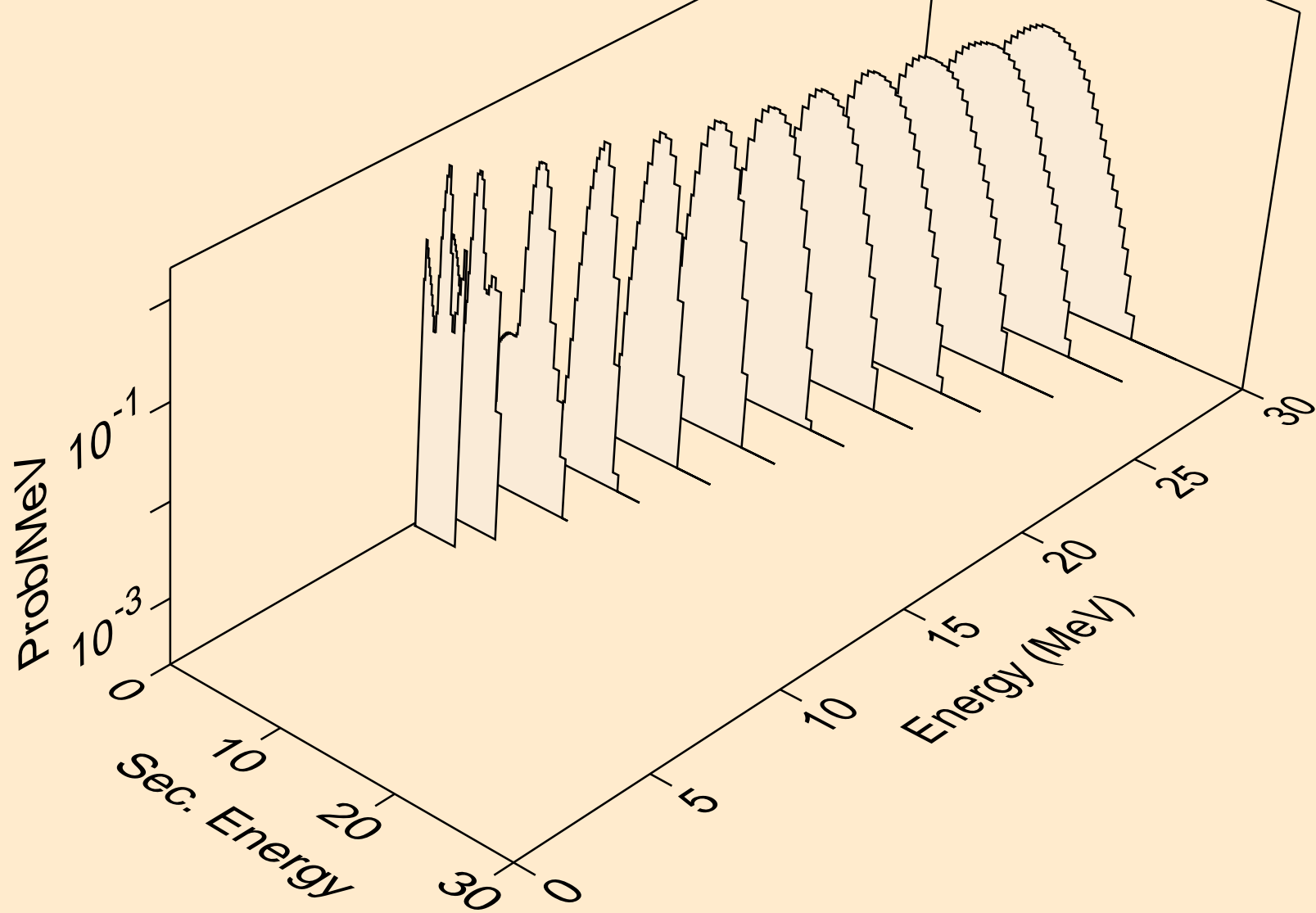

W173 PROTON ACER TENDL-2023 LIBRARY; T=0.K  
Proton emission for (p,pa)

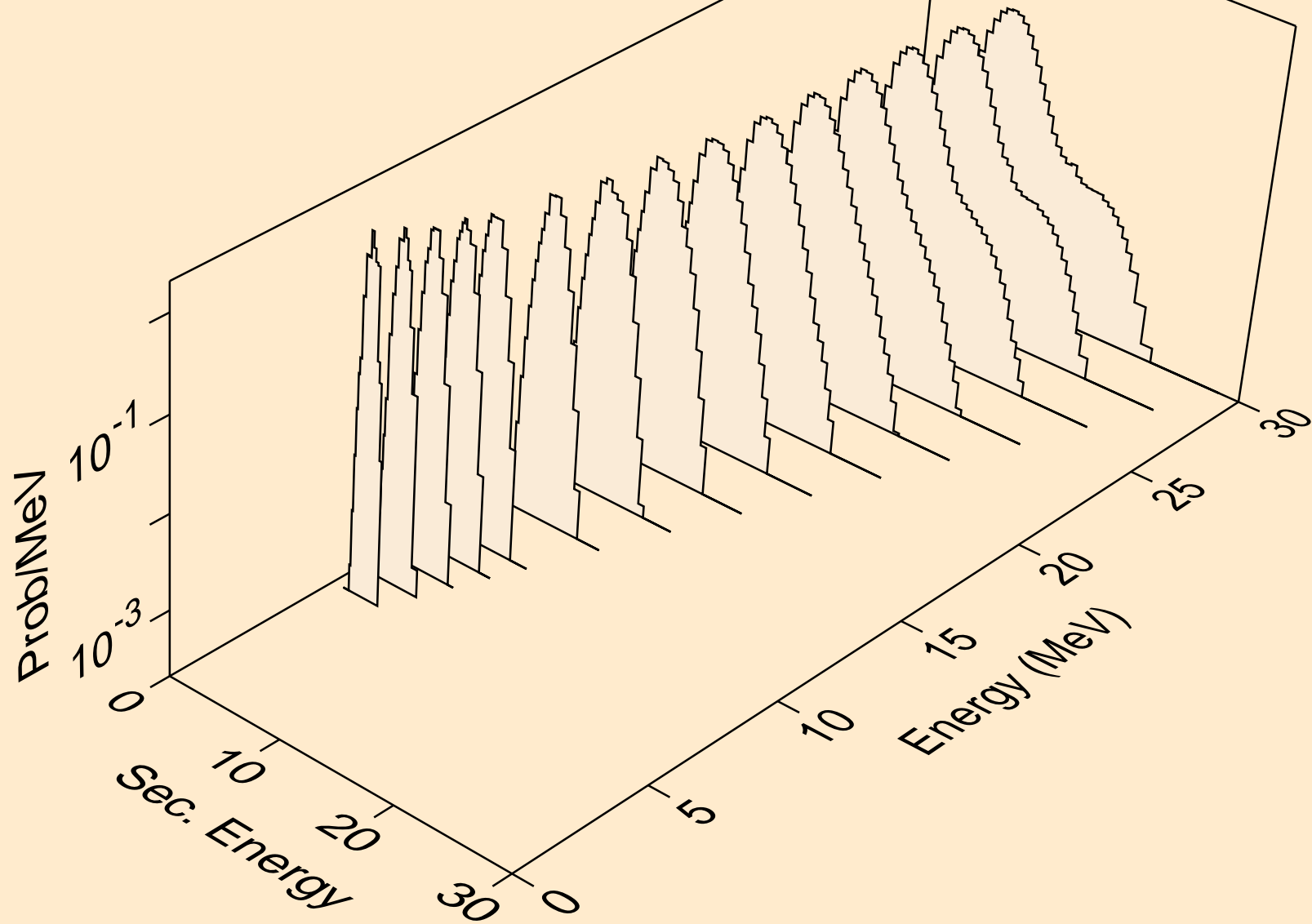

W173 PROTON ACER TENDL-2023 LIBRARY; T=0.K  
Proton emission for (p,pd)

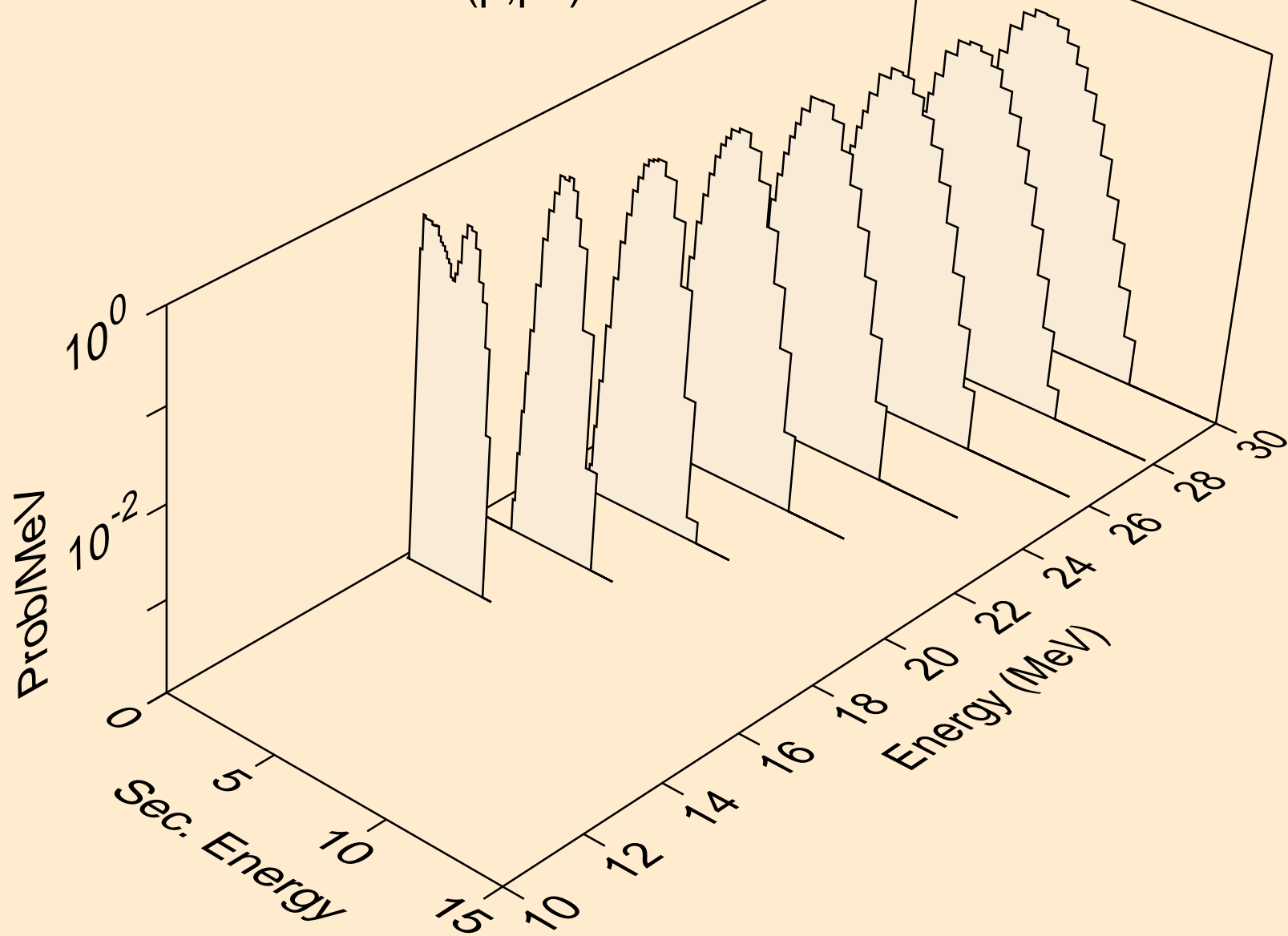

W173 PROTON ACER TENDL-2023 LIBRARY; T=0.K  
Proton emission for (p,pt)

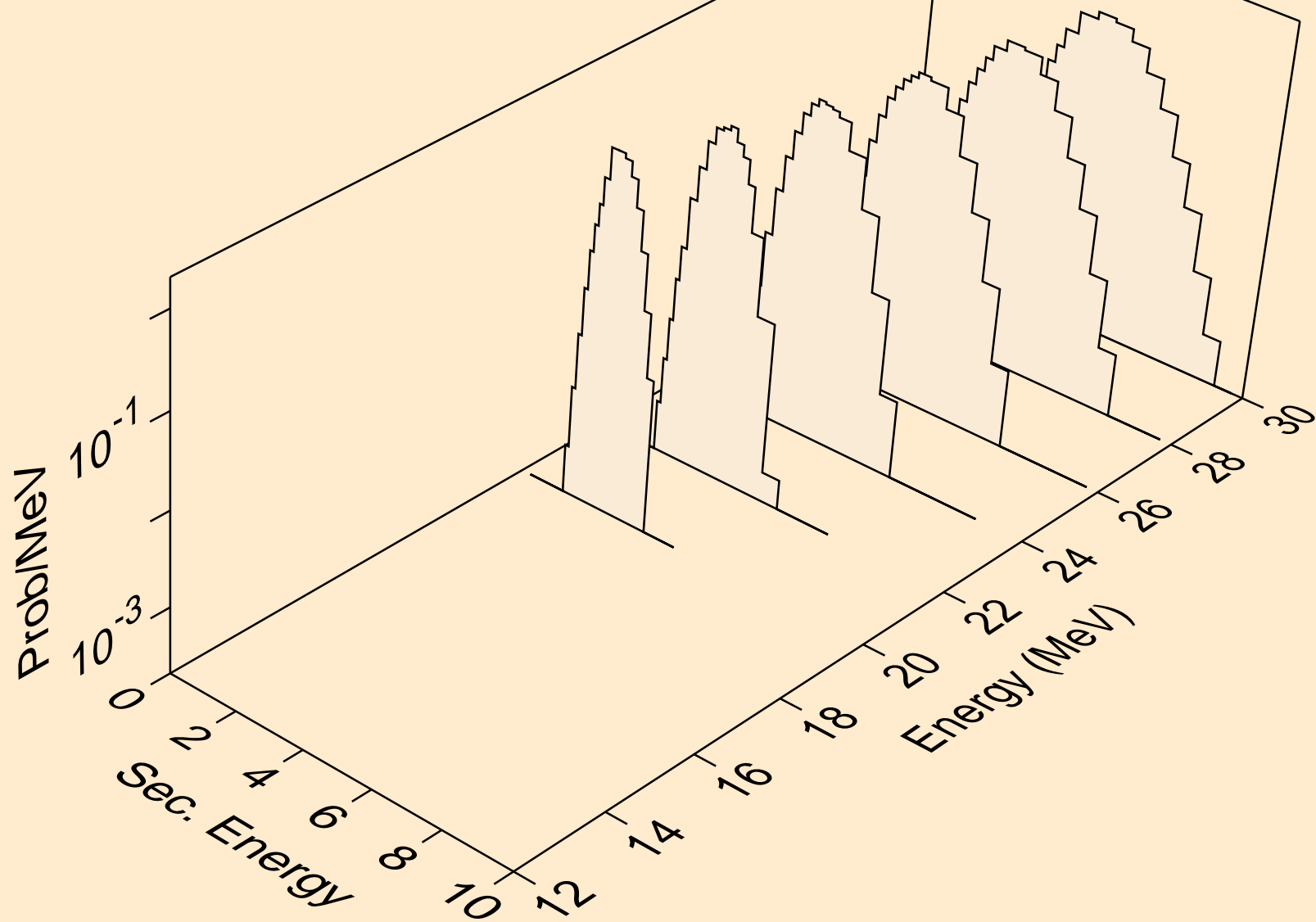

W173 PROTON ACER TENDL-2023 LIBRARY; T=0.K  
Photon emission for (z,n)

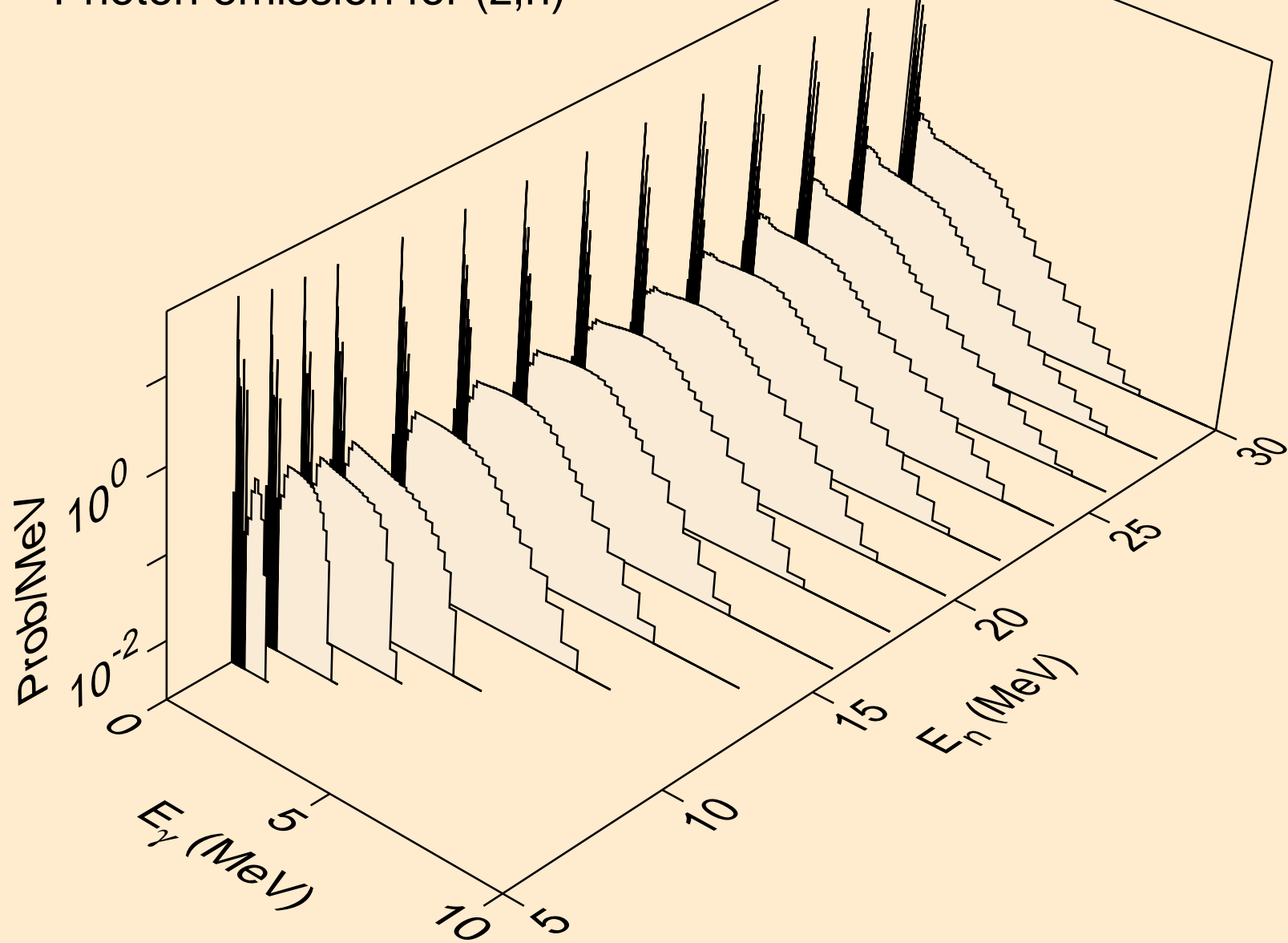

W173 PROTON ACER TENDL-2023 LIBRARY; T=0.K  
Photon emission for (z,x)

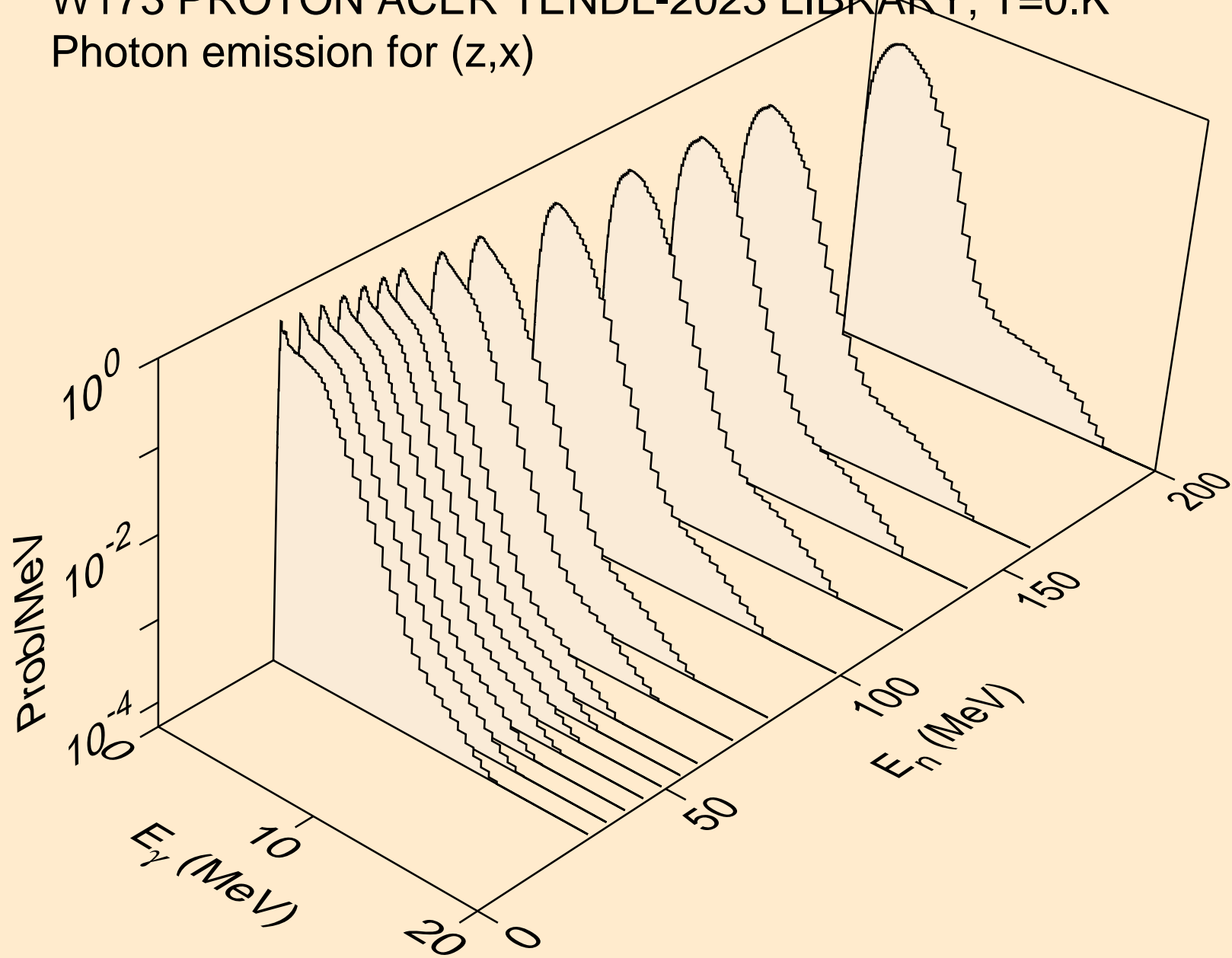

W173 PROTON ACER TENDL-2023 LIBRARY; T=0.K  
Photon emission for (n,2nd)

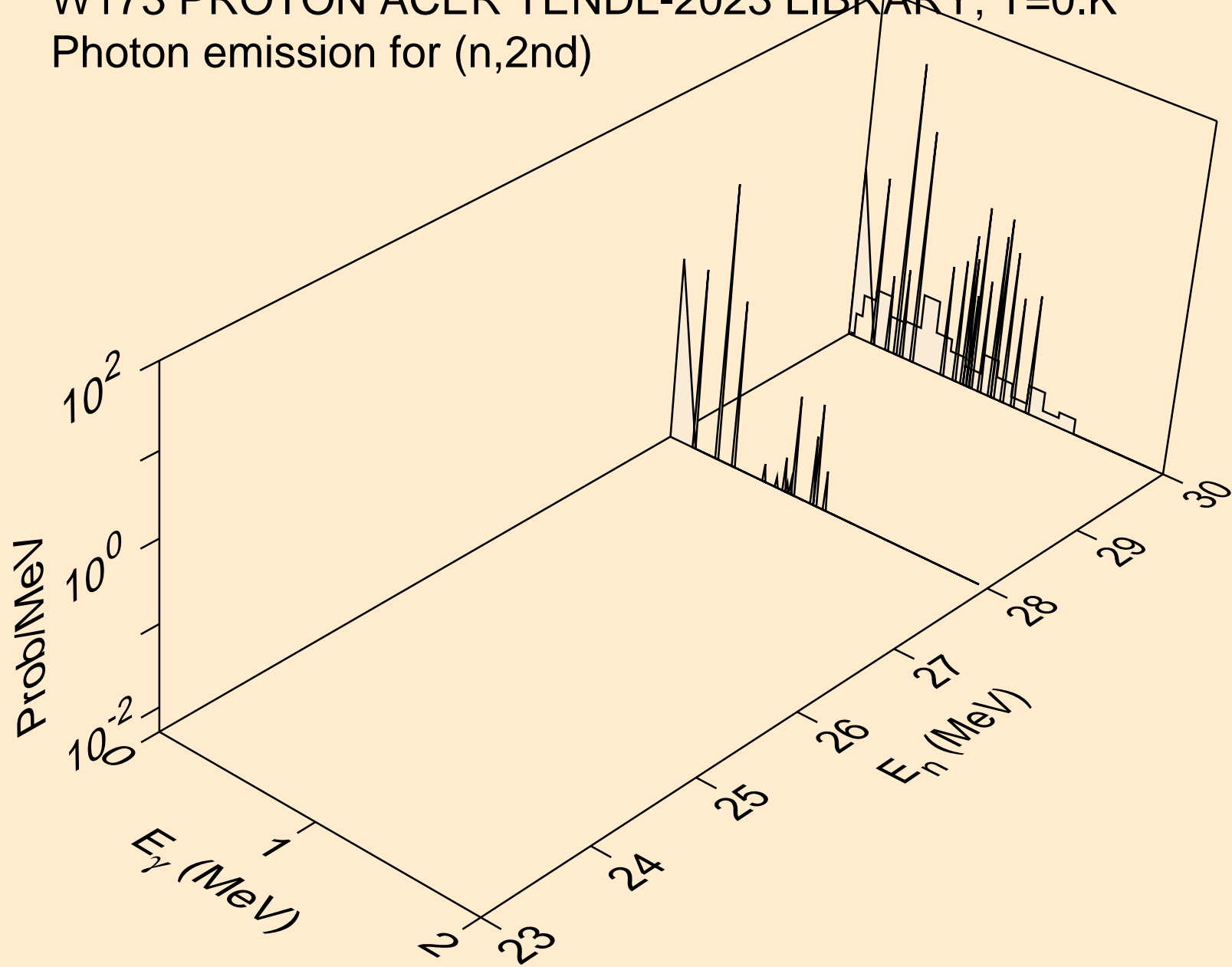

W173 PROTON ACER TENDL-2023 LIBRARY; T=0.K  
Photon emission for (n,2n)

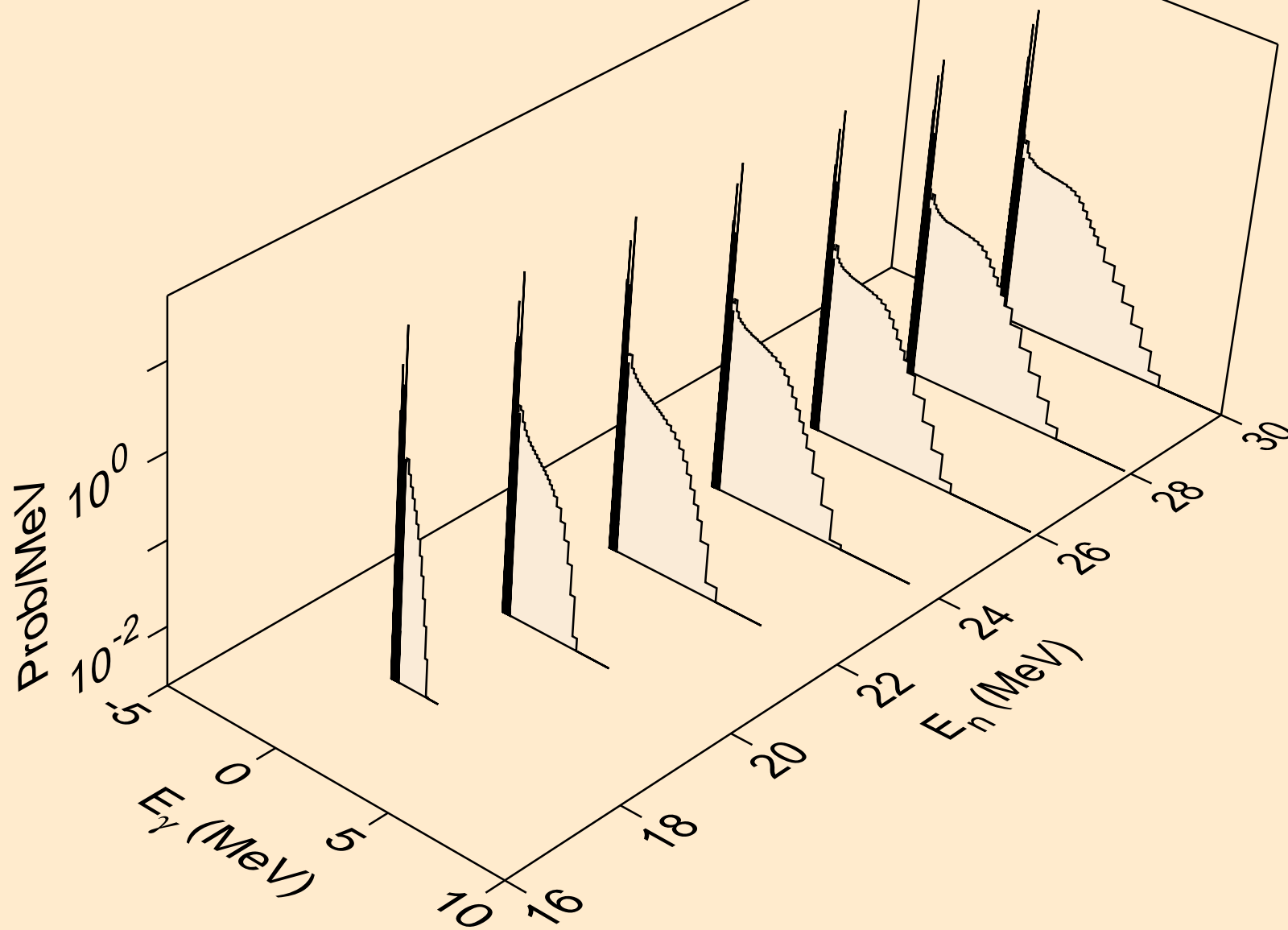



W173 PROTON ACER TENDL-2023 LIBRARY; T=0.K  
Photon emission for (n,3n)

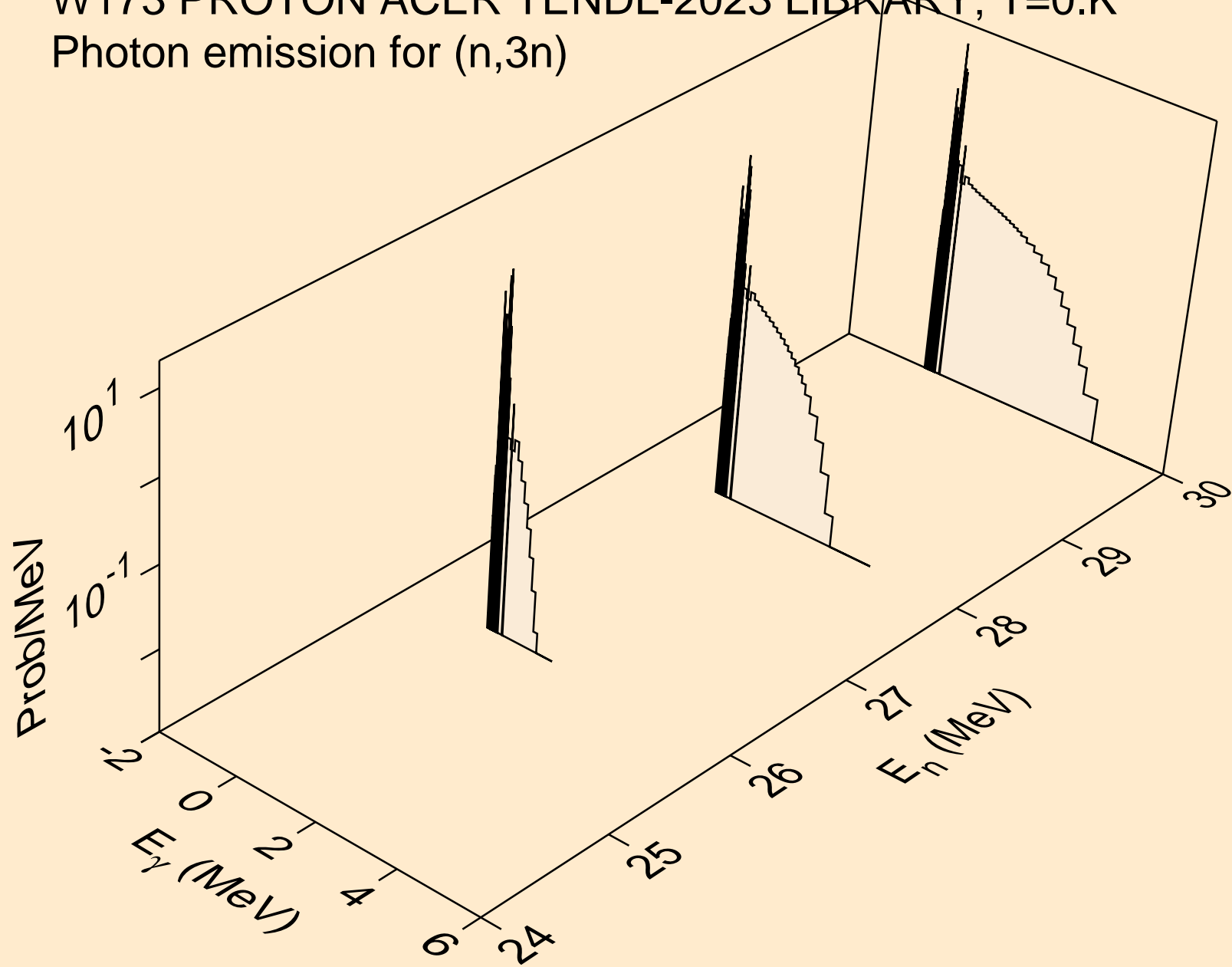

W173 PROTON ACER TENDL-2023 LIBRARY; T=0.K  
Photon emission for (n,n\*)a

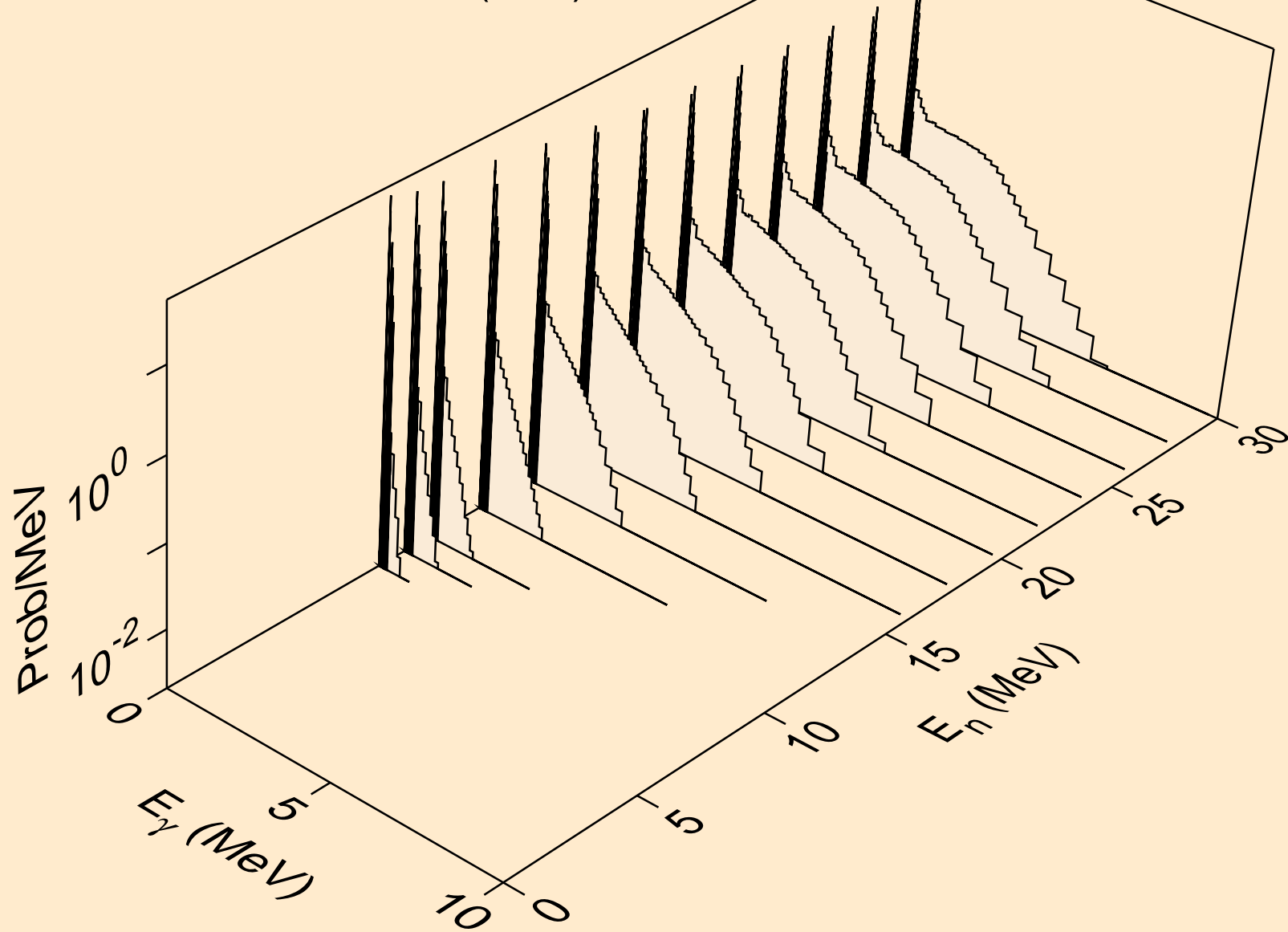

W173 PROTON ACER TENDL-2023 LIBRARY; T=0.K  
Photon emission for (n,2n)a

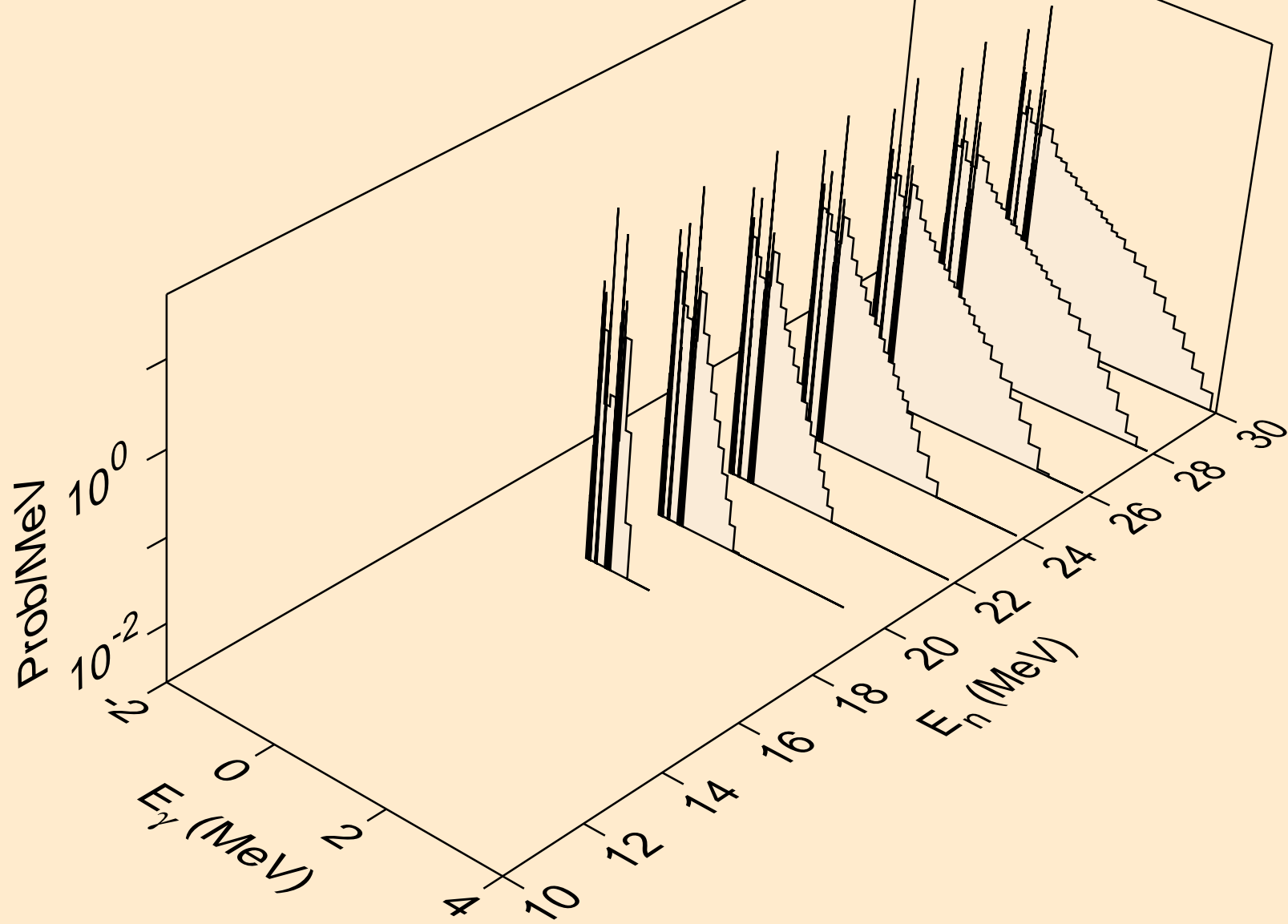

W173 PROTON ACER TENDL-2023 LIBRARY; T=0.K  
Photon emission for (n,3n)a

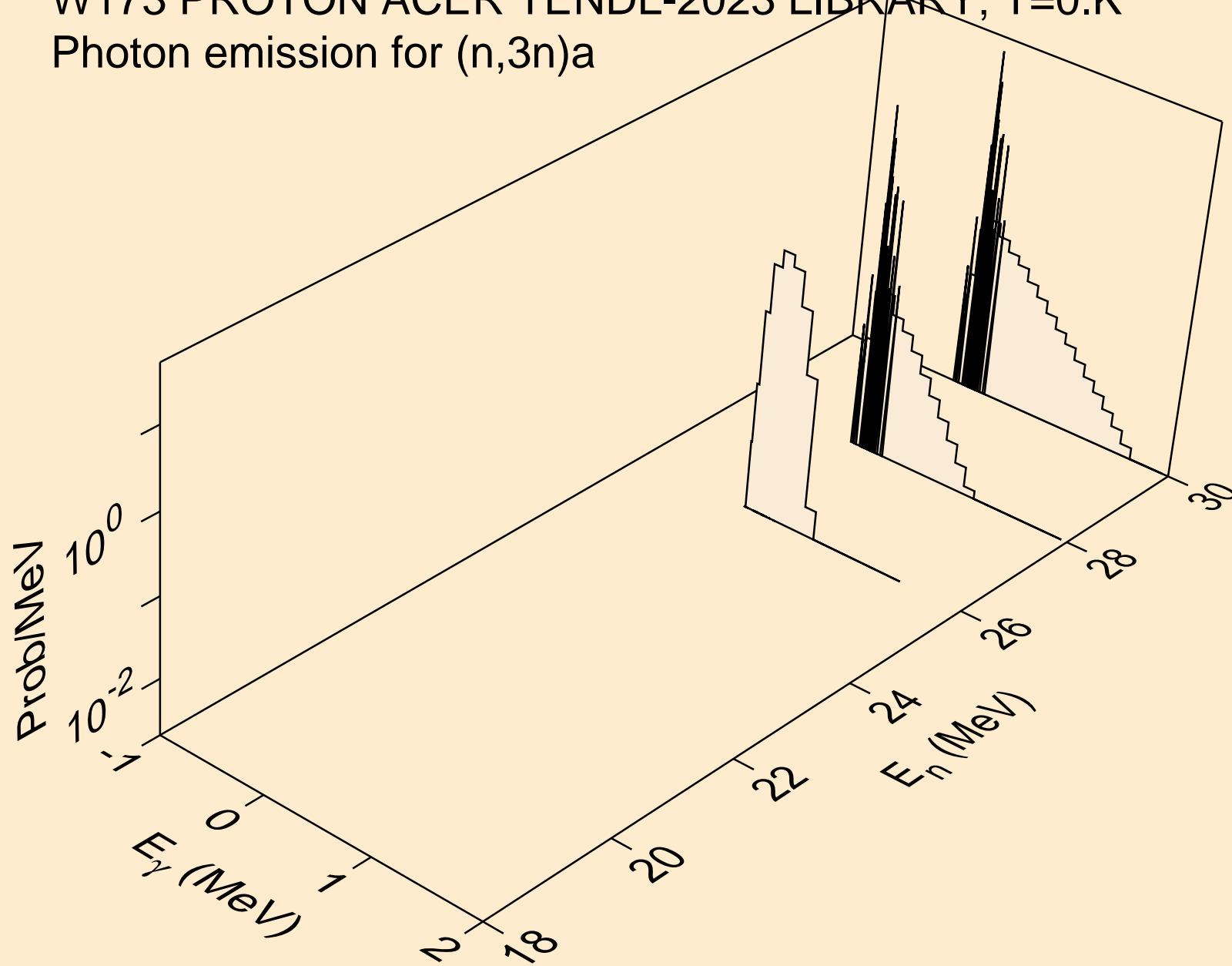

W173 PROTON ACER TENDL-2023 LIBRARY; T=0.K  
Photon emission for (n,n\*)p

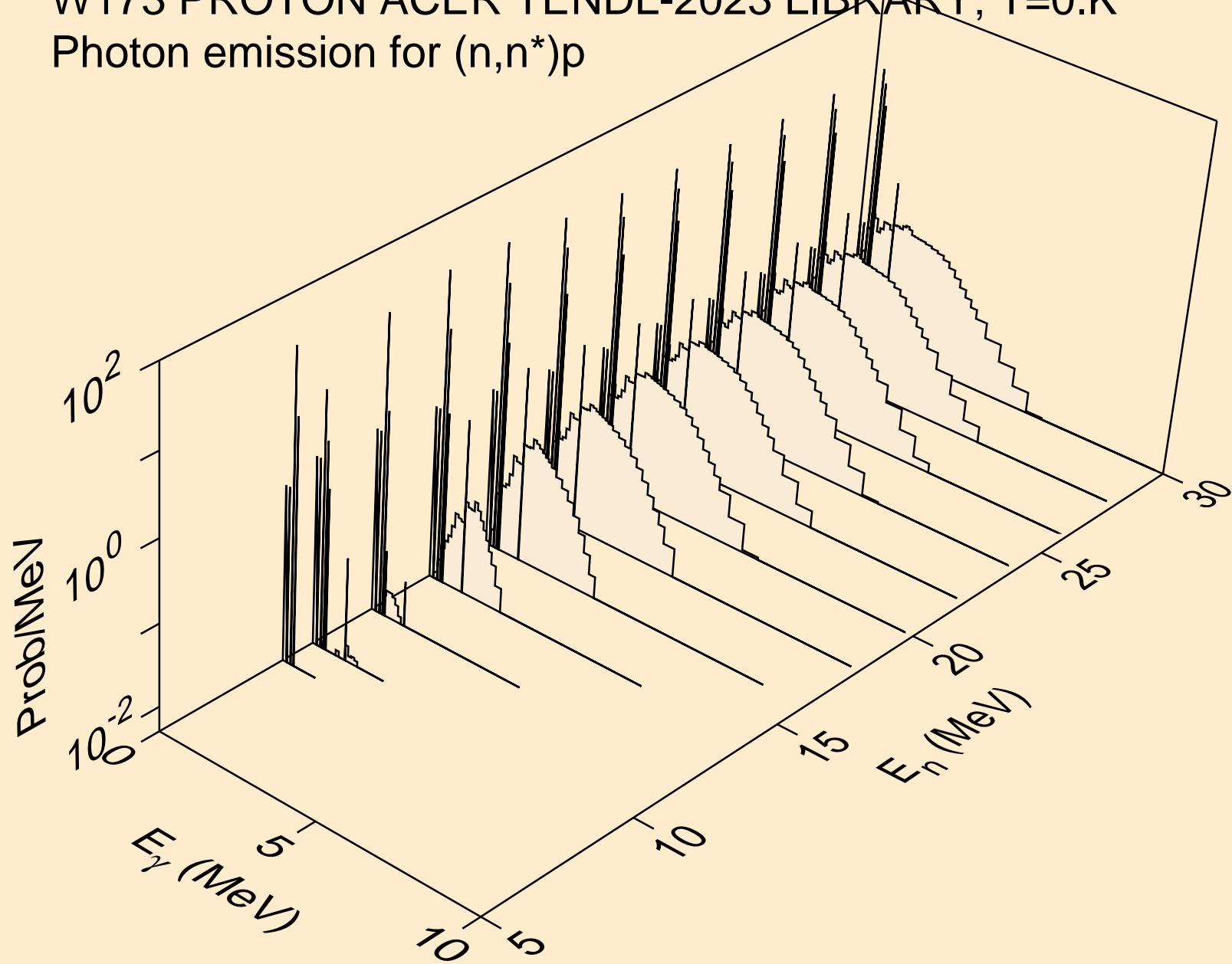

W173 PROTON ACER TENDL-2023 LIBRARY; T=0.K  
Photon emission for (n,n\*)2a

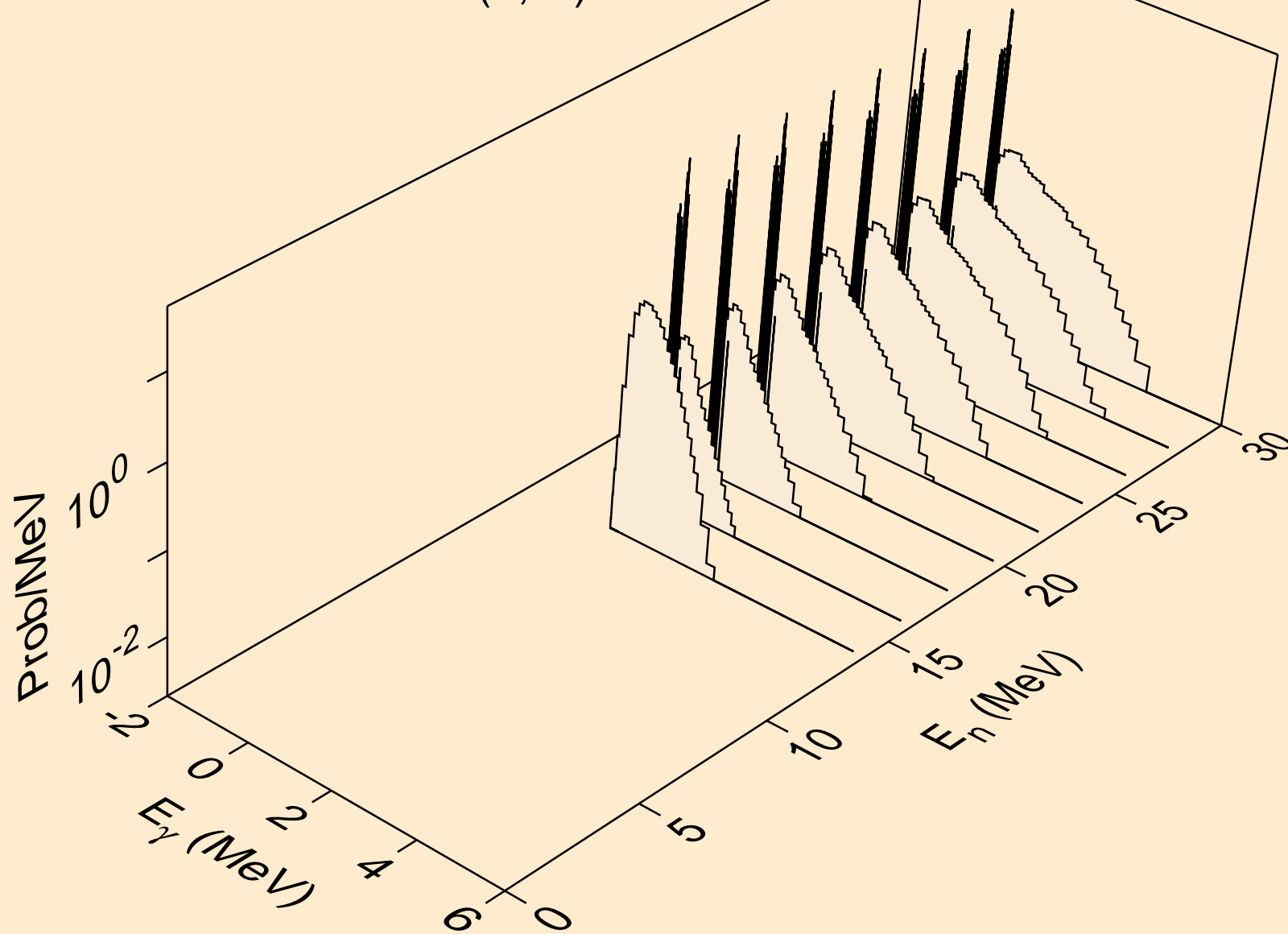

W173 PROTON ACER TENDL-2023 LIBRARY; T=0.K  
Photon emission for (n,n\*)d

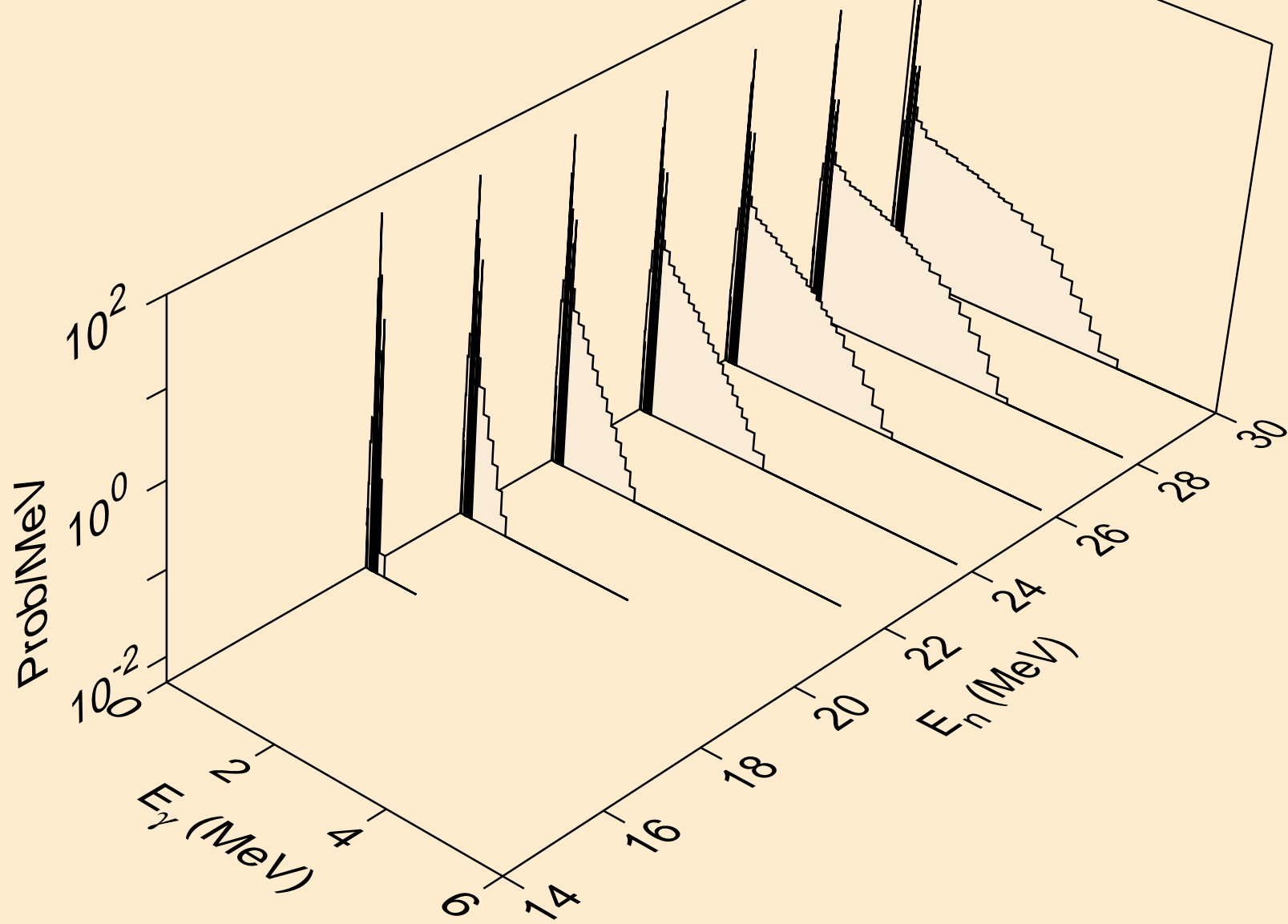

W173 PROTON ACER TENDL-2023 LIBRARY; T=0.K  
Photon emission for (n,n\*)t

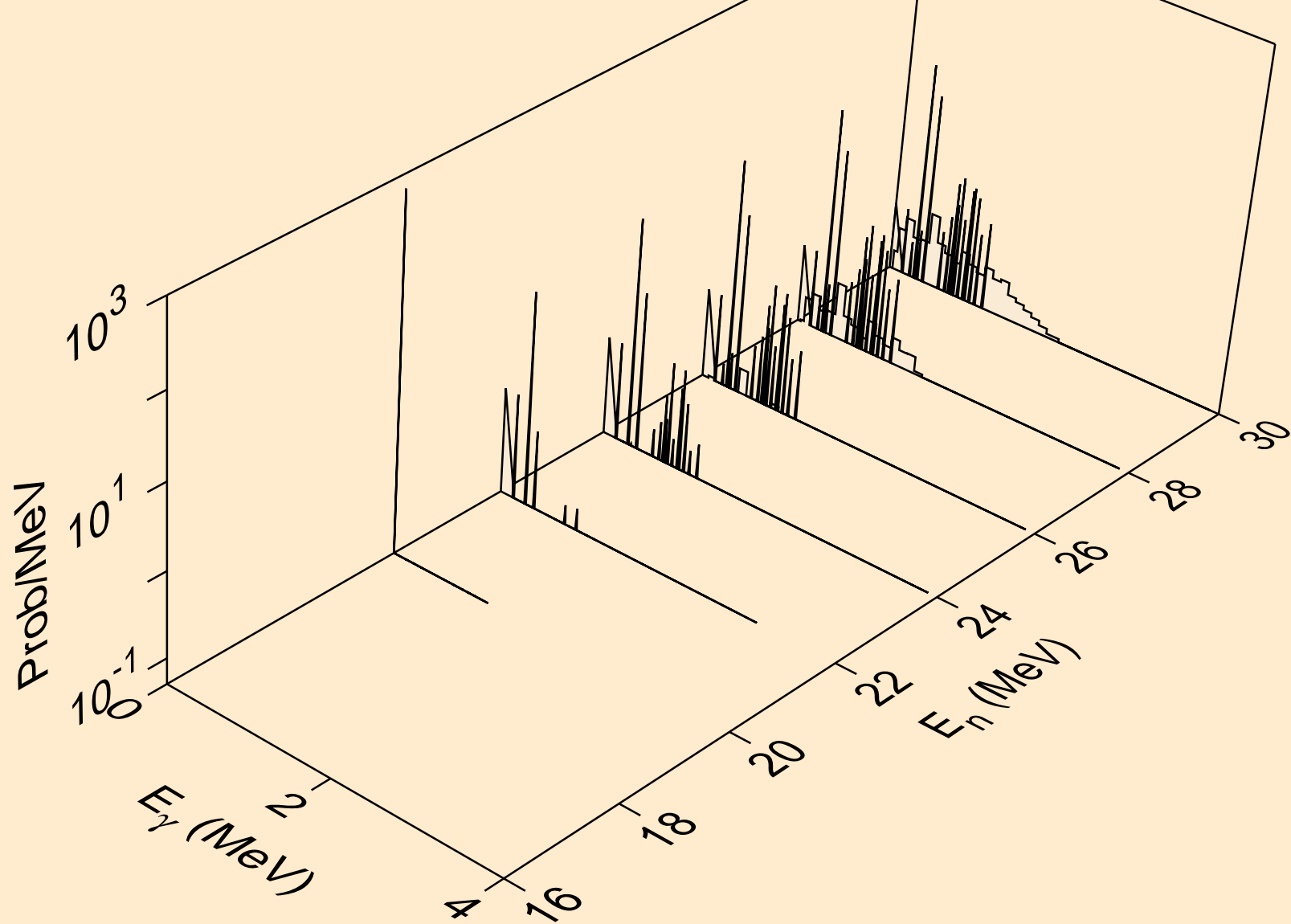



W173 PROTON ACER TENDL-2023 LIBRARY; T=0.K  
Photon emission for (n,n\*)he3

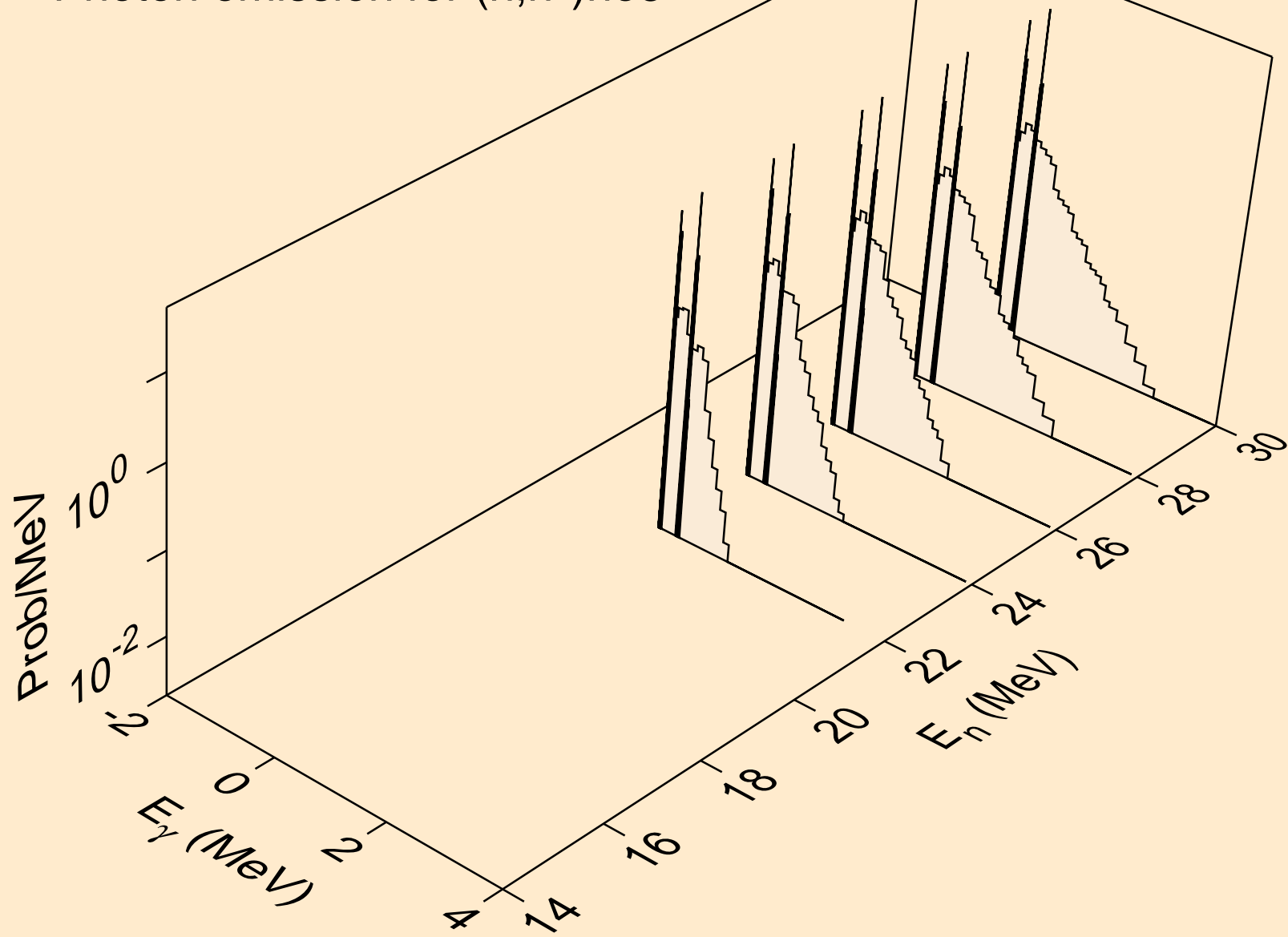

W173 PROTON ACER TENDL-2023 LIBRARY; T=0.K  
Photon emission for (n,2np)

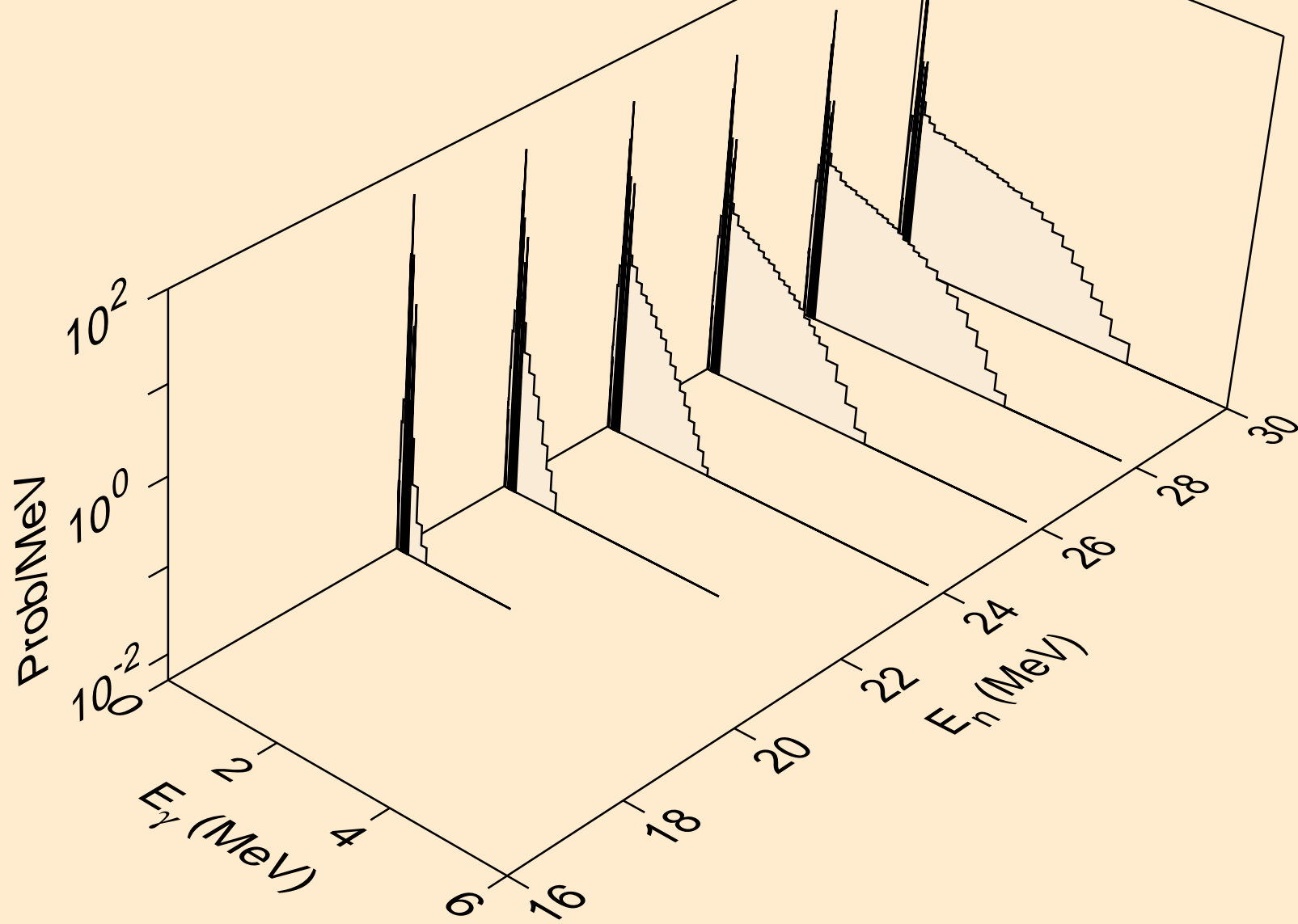

W173 PROTON ACER TENDL-2023 LIBRARY; T=0.K  
Photon emission for (n,3np)

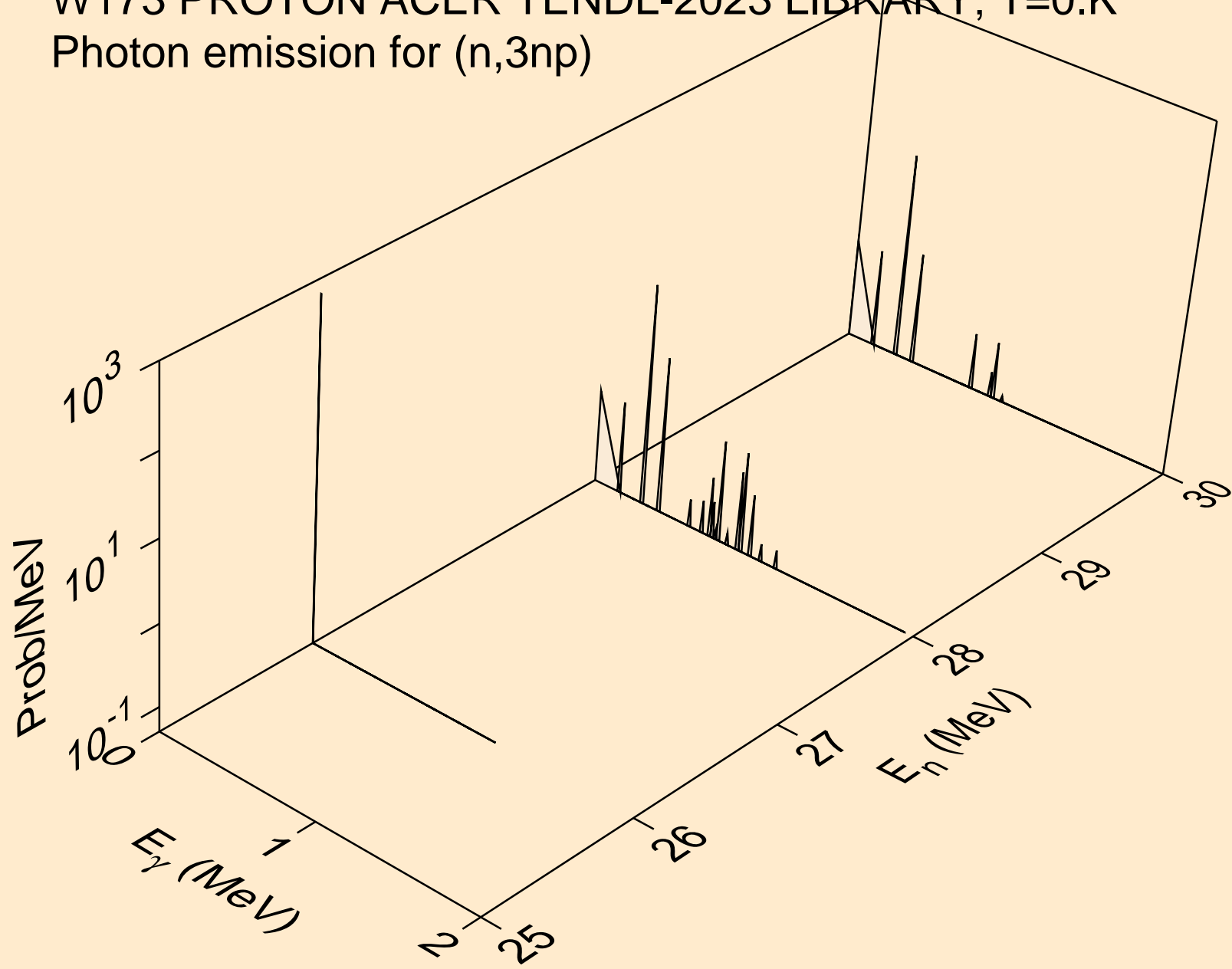

W173 PROTON ACER TENDL-2023 LIBRARY; T=0.K  
Photon emission for (n,n2p)

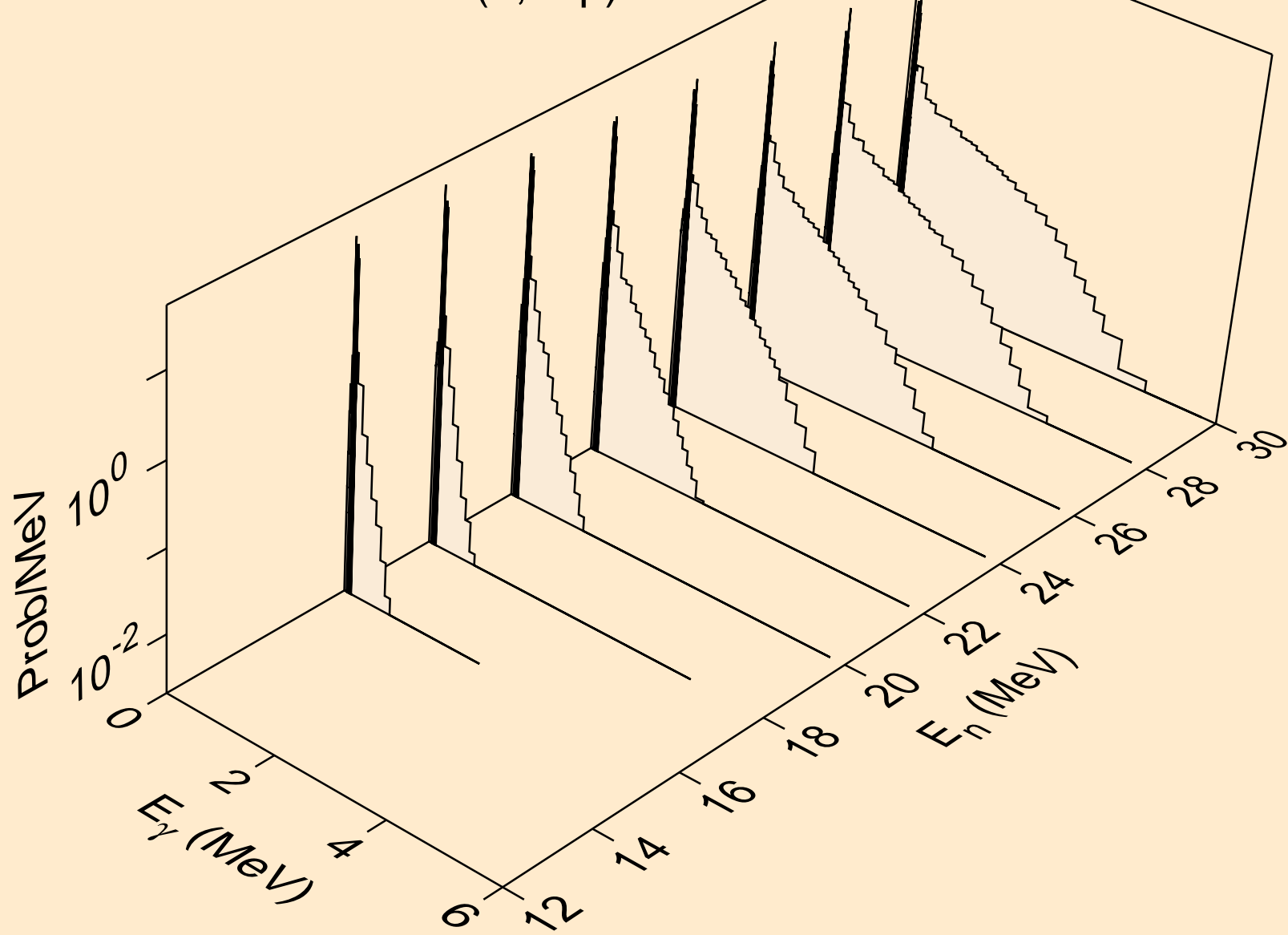

W173 PROTON ACER TENDL-2023 LIBRARY; T=0.K  
Photon emission for (n,npa)

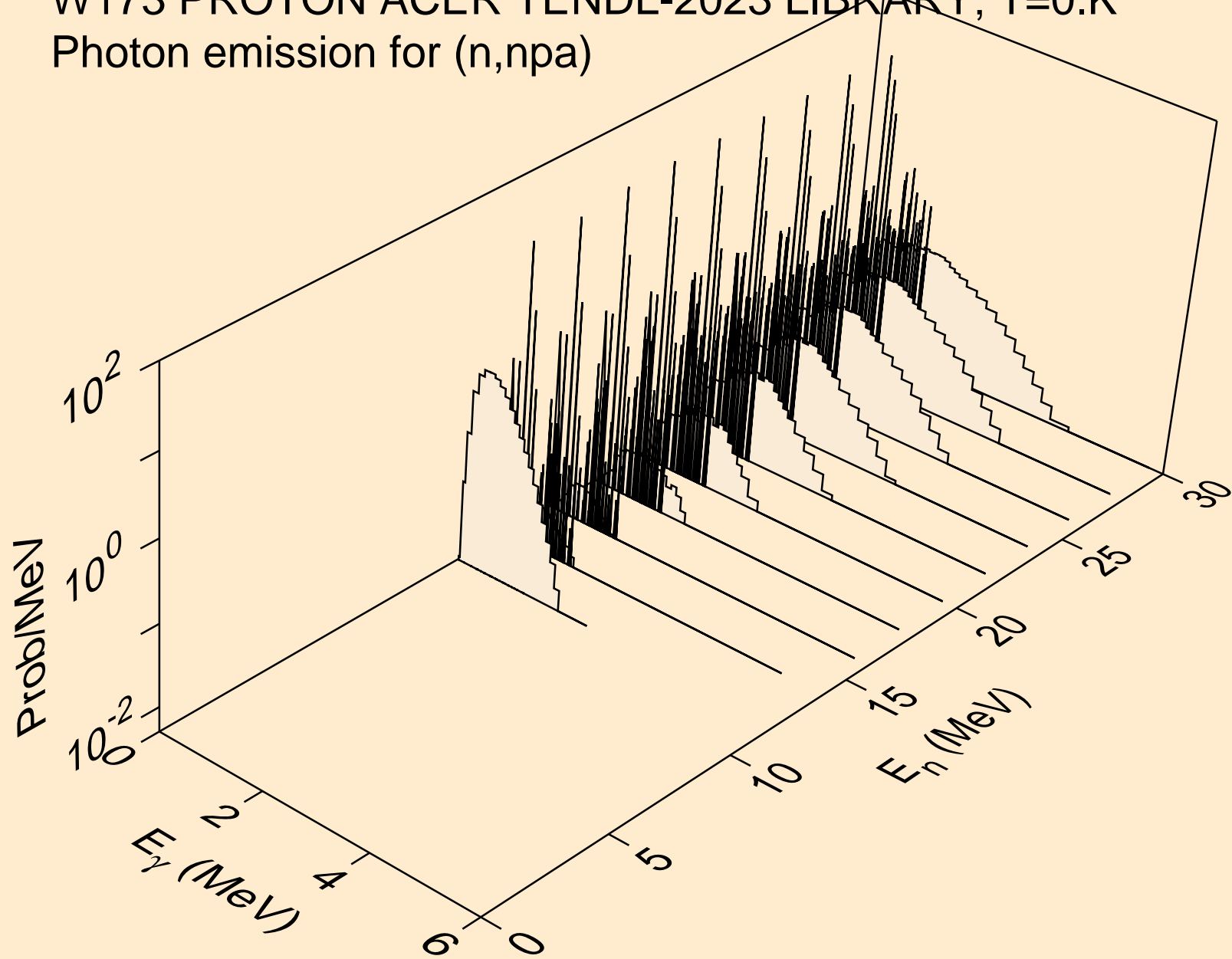

W173 PROTON ACER TENDL-2023 LIBRARY; T=0.K  
Photon emission for (n,gma)

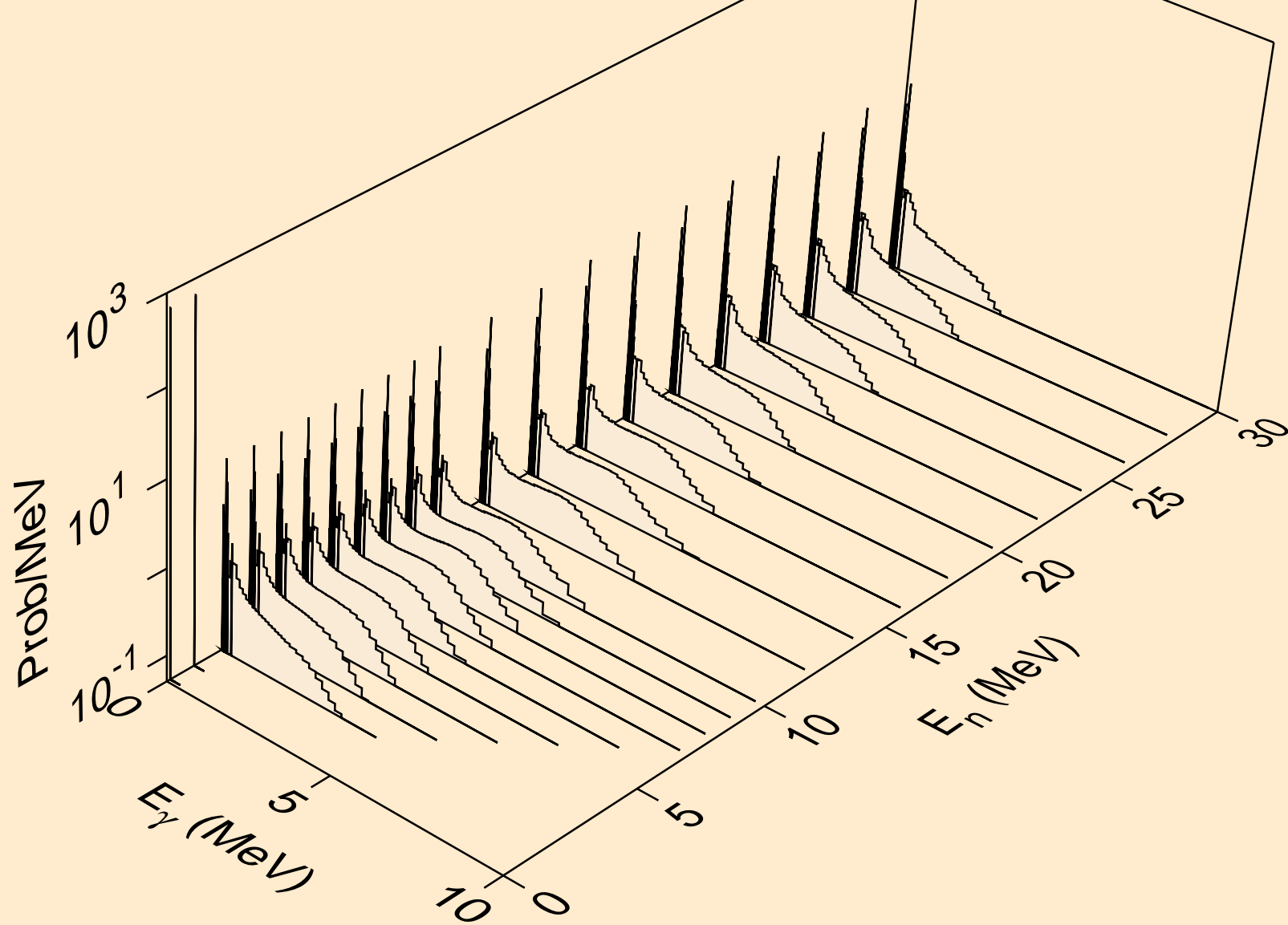

W173 PROTON ACER TENDL-2023 LIBRARY; T=0.K  
Photon emission for inelastic

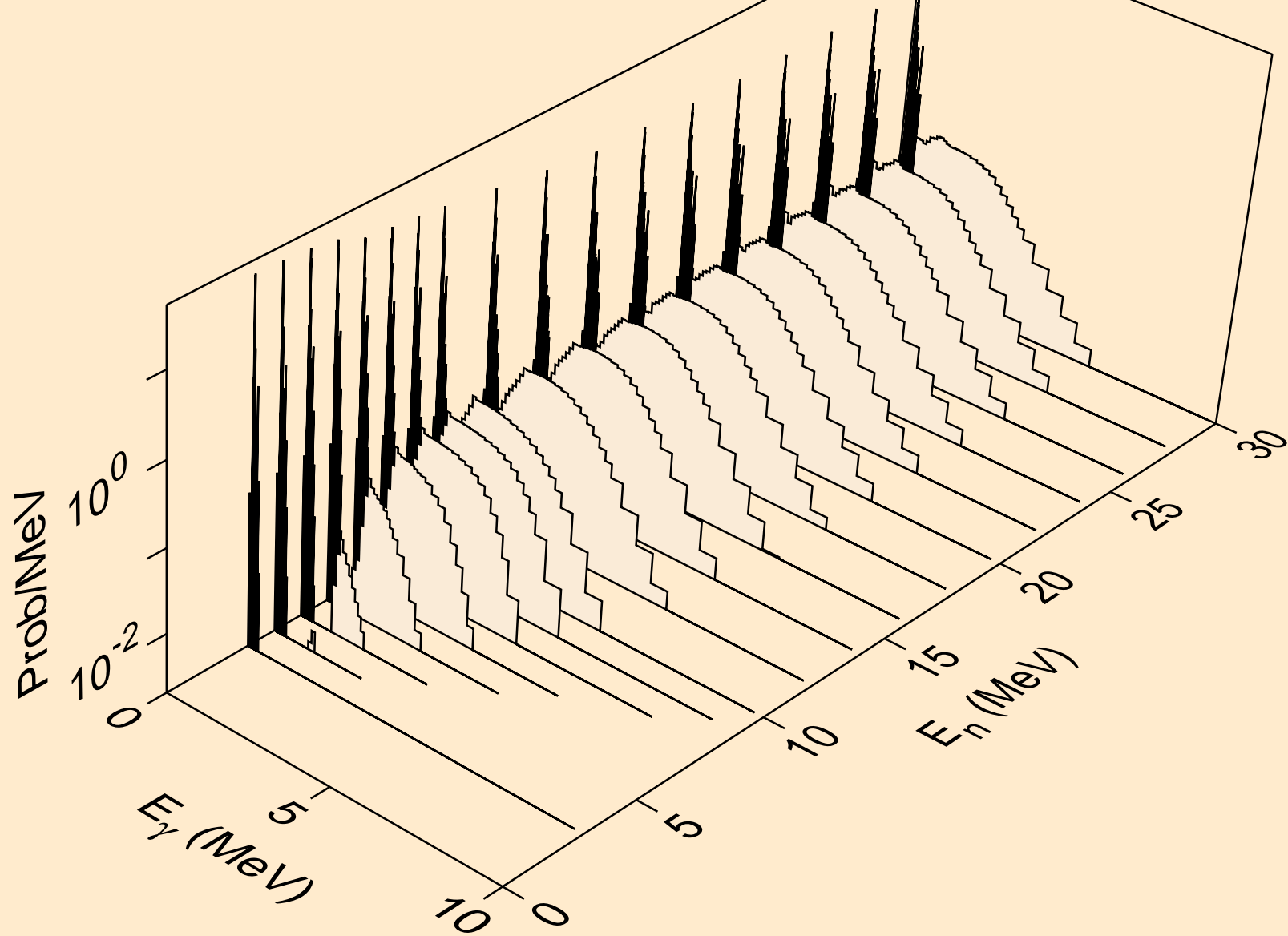

W173 PROTON ACER TENDL-2023 LIBRARY; T=0.K  
Photon emission for (n,d)

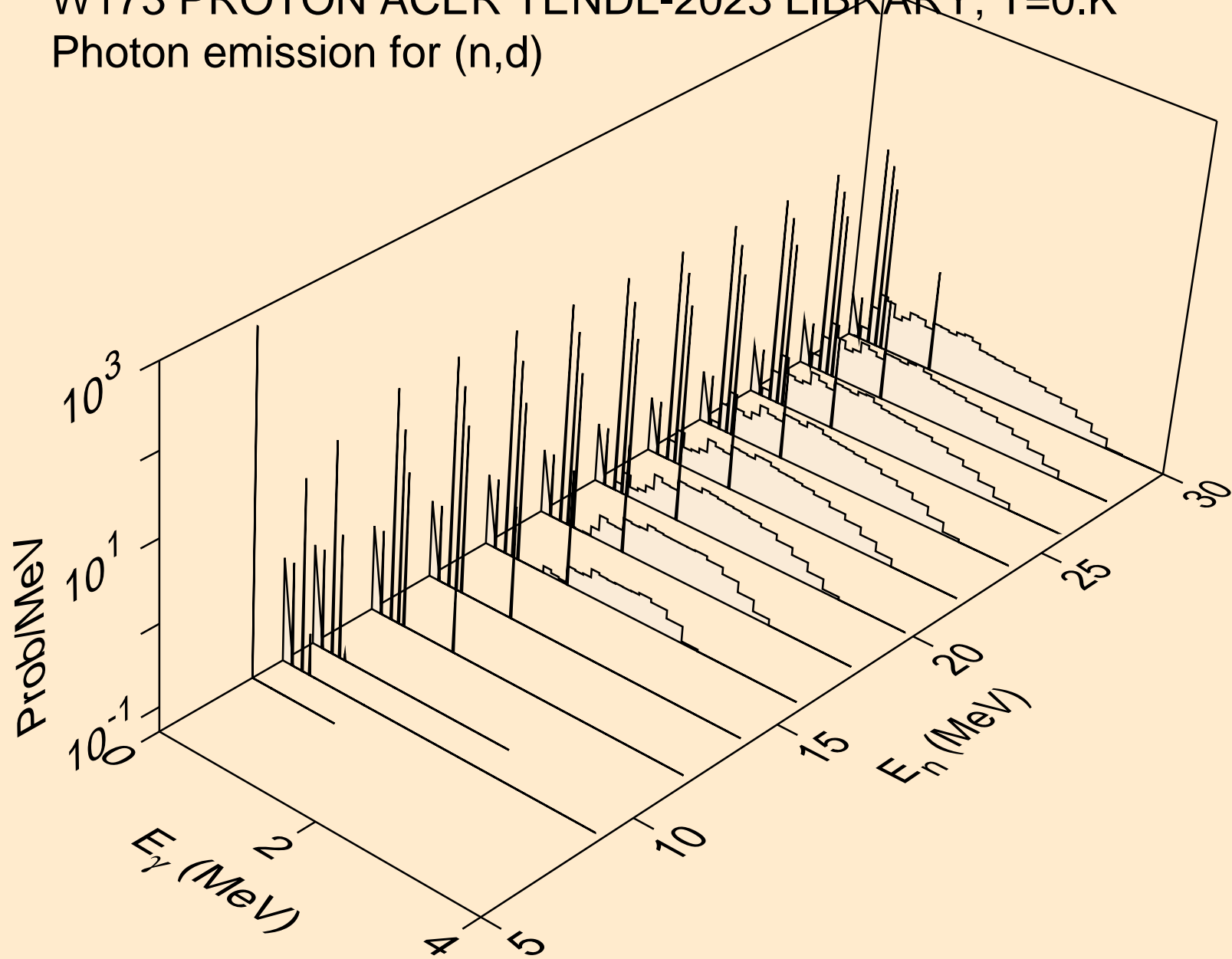



W173 PROTON ACER TENDL-2023 LIBRARY; T=0.K  
Photon emission for (n,t)

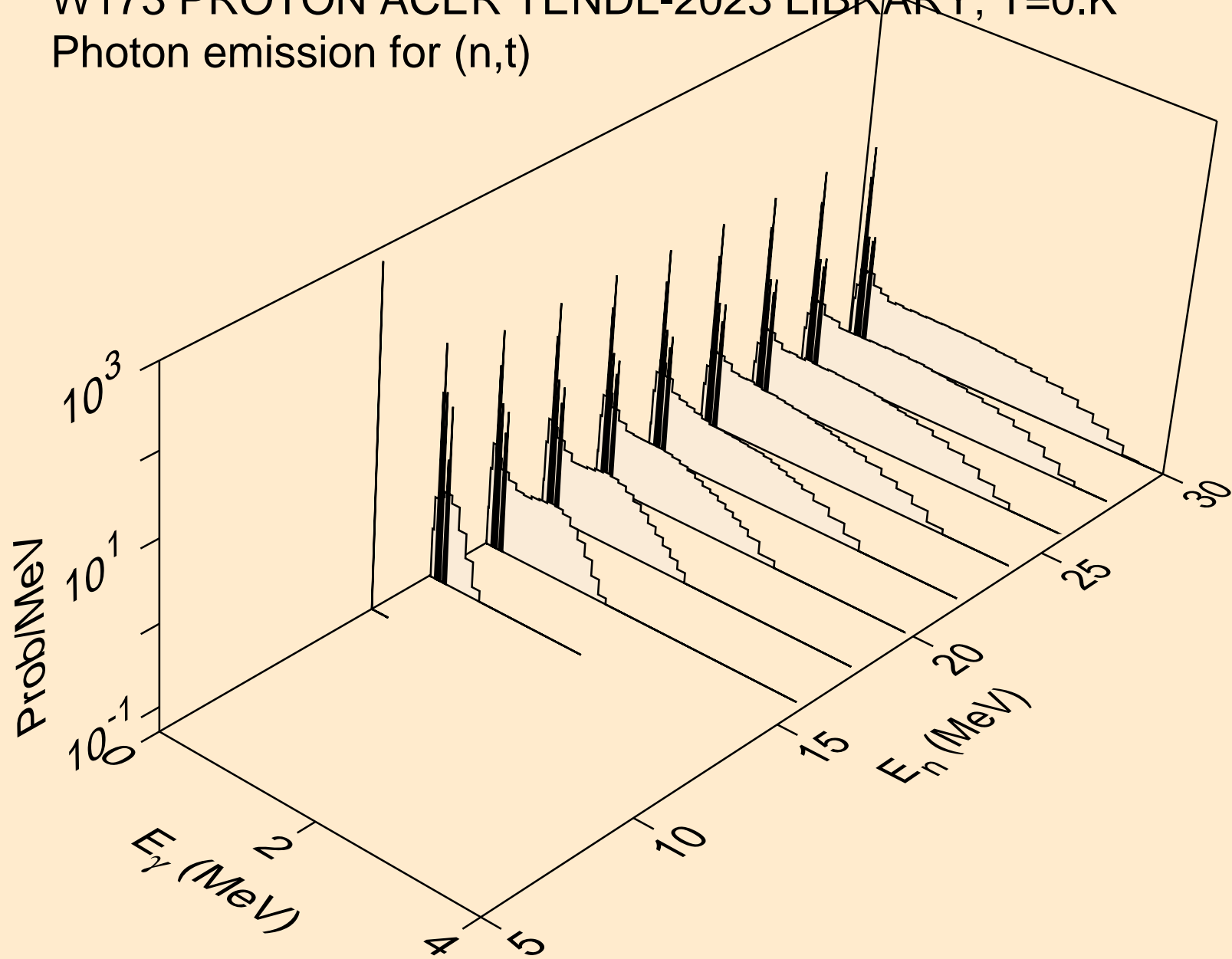

W173 PROTON ACER TENDL-2023 LIBRARY; T=0.K  
Photon emission for (n,he3)

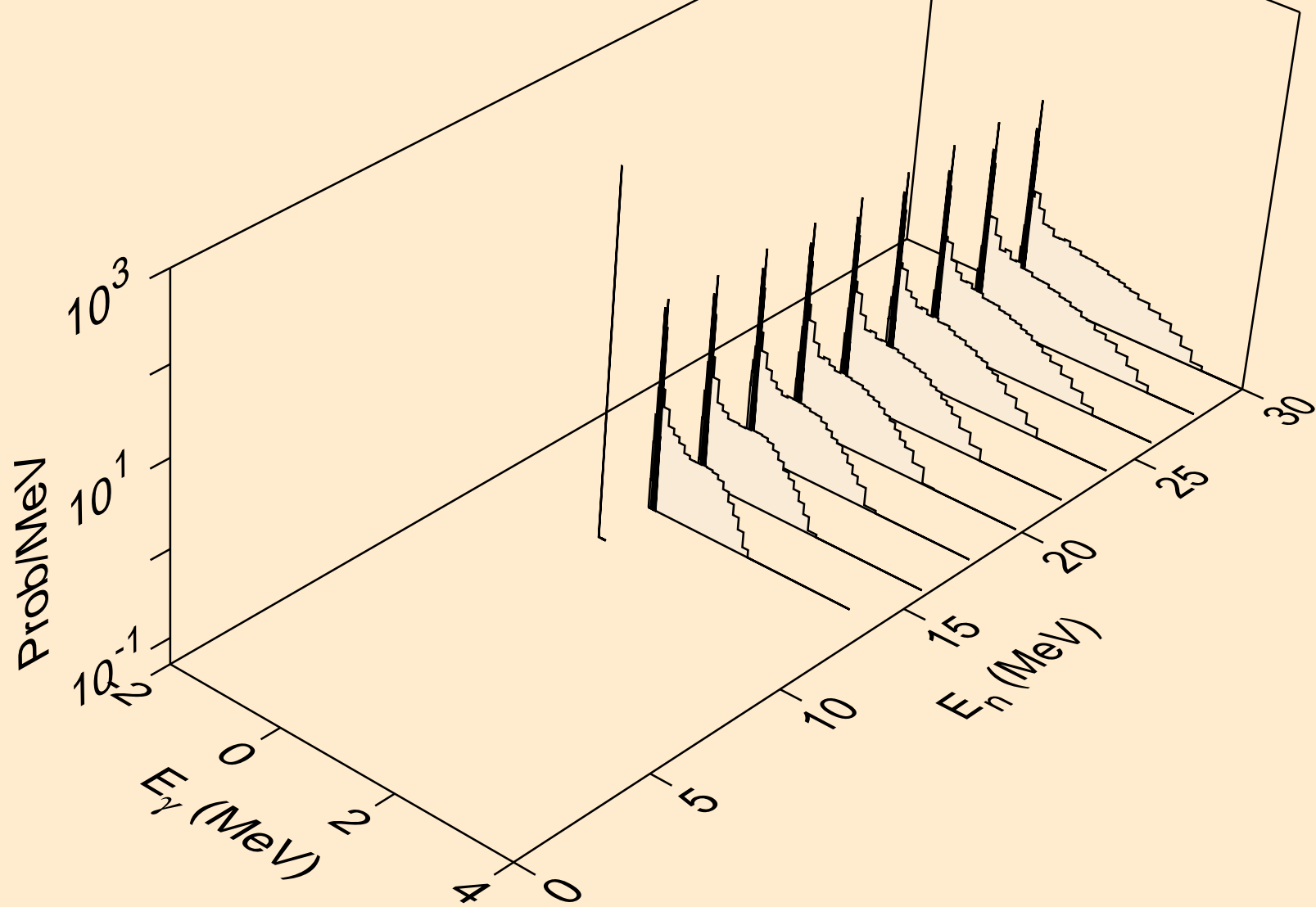

W173 PROTON ACER TENDL-2023 LIBRARY; T=0.K  
Photon emission for (n,a)

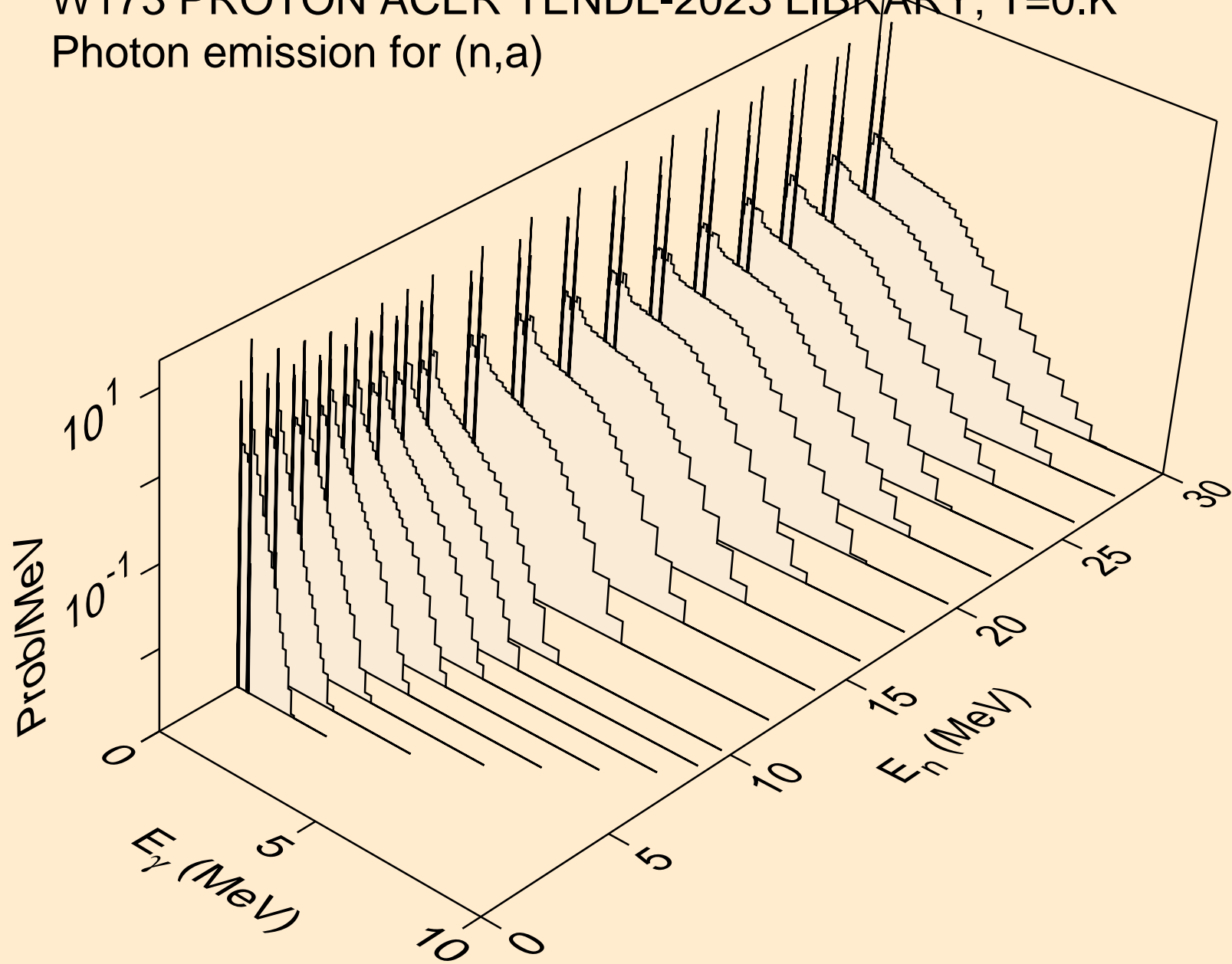

W173 PROTON ACER TENDL-2023 LIBRARY; T=0.K  
Photon emission for (n,2a)

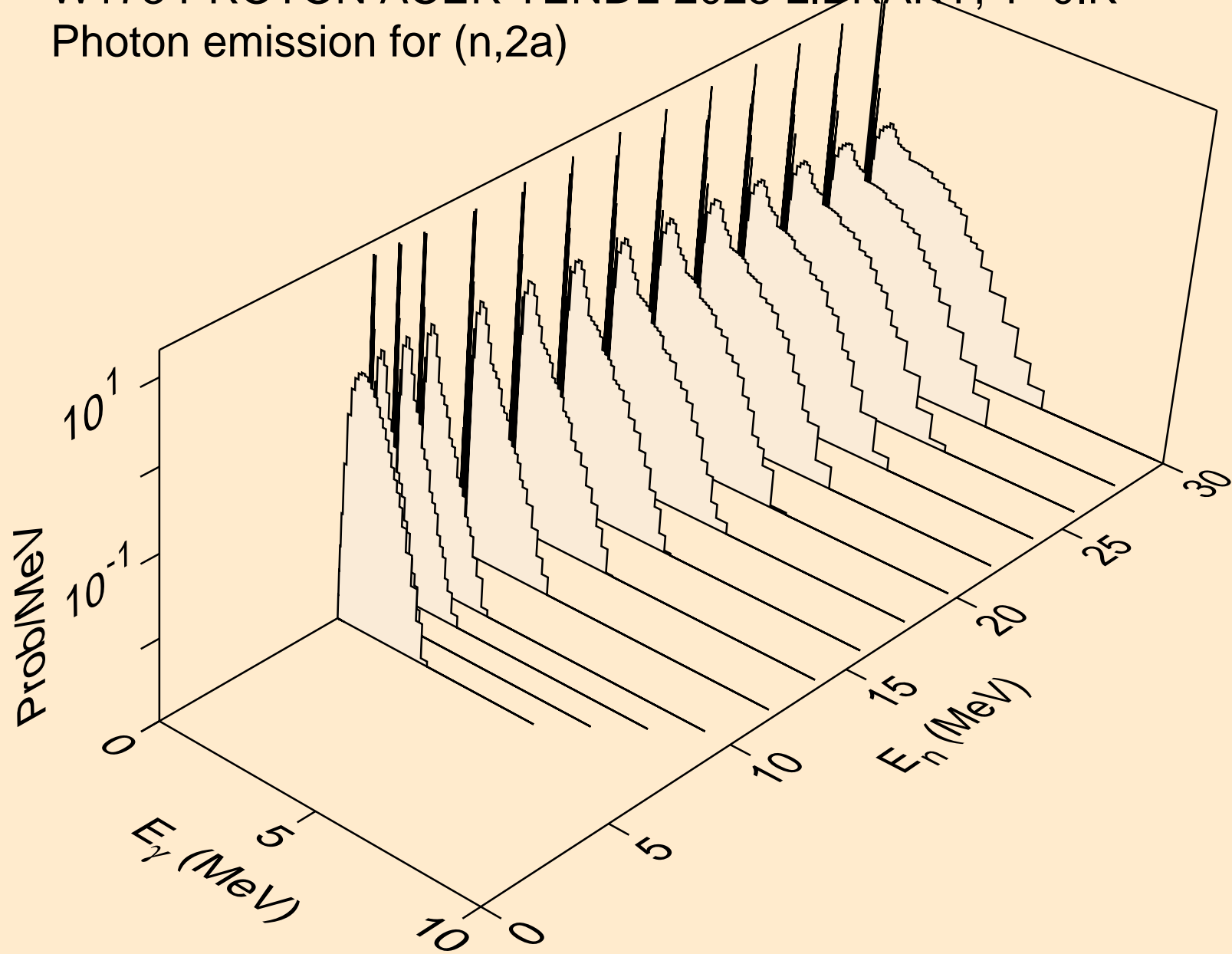

W173 PROTON ACER TENDL-2023 LIBRARY; T=0.K  
Photon emission for (n,2p)

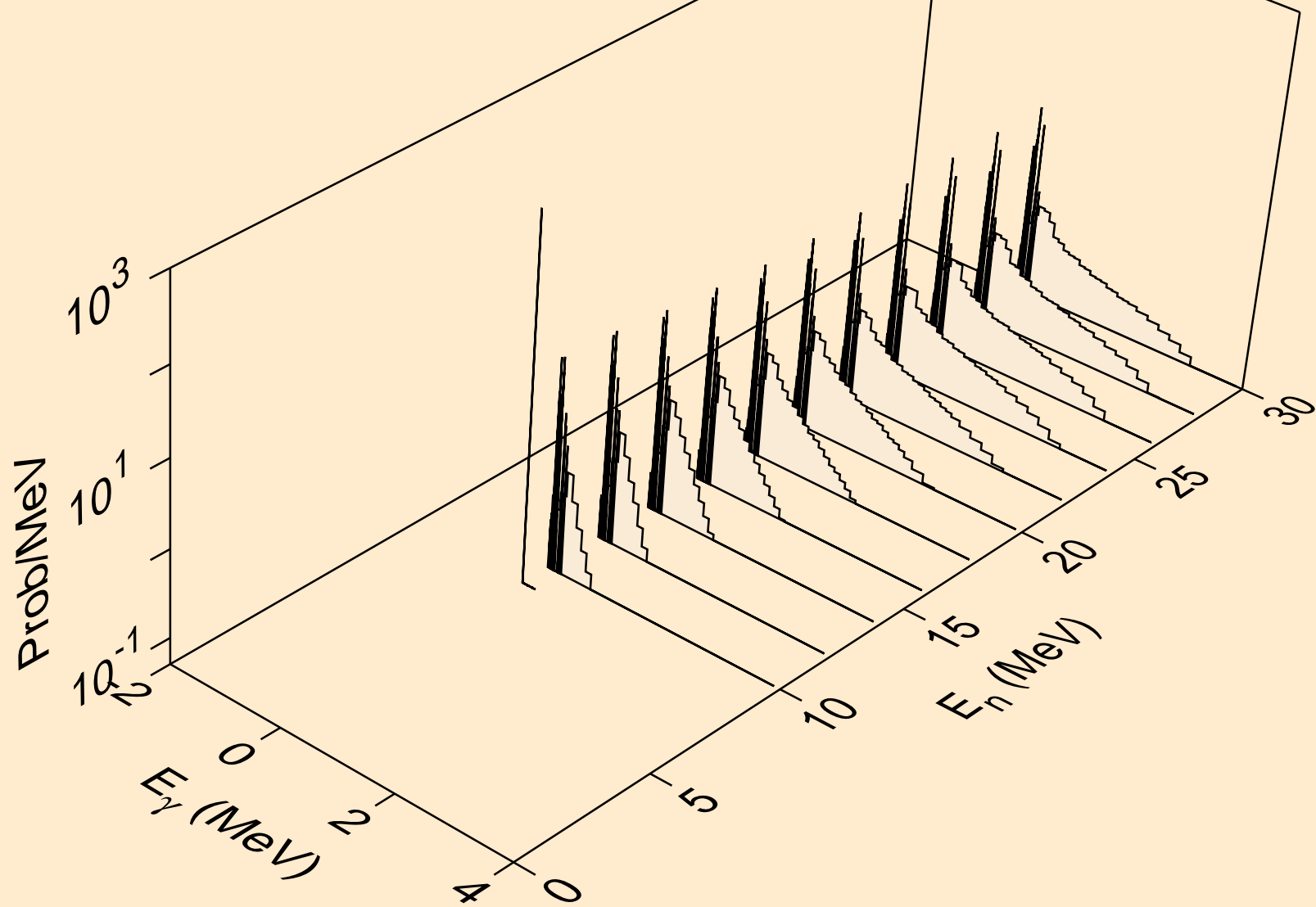

W173 PROTON ACER TENDL-2023 LIBRARY; T=0.K  
Photon emission for (n,p)

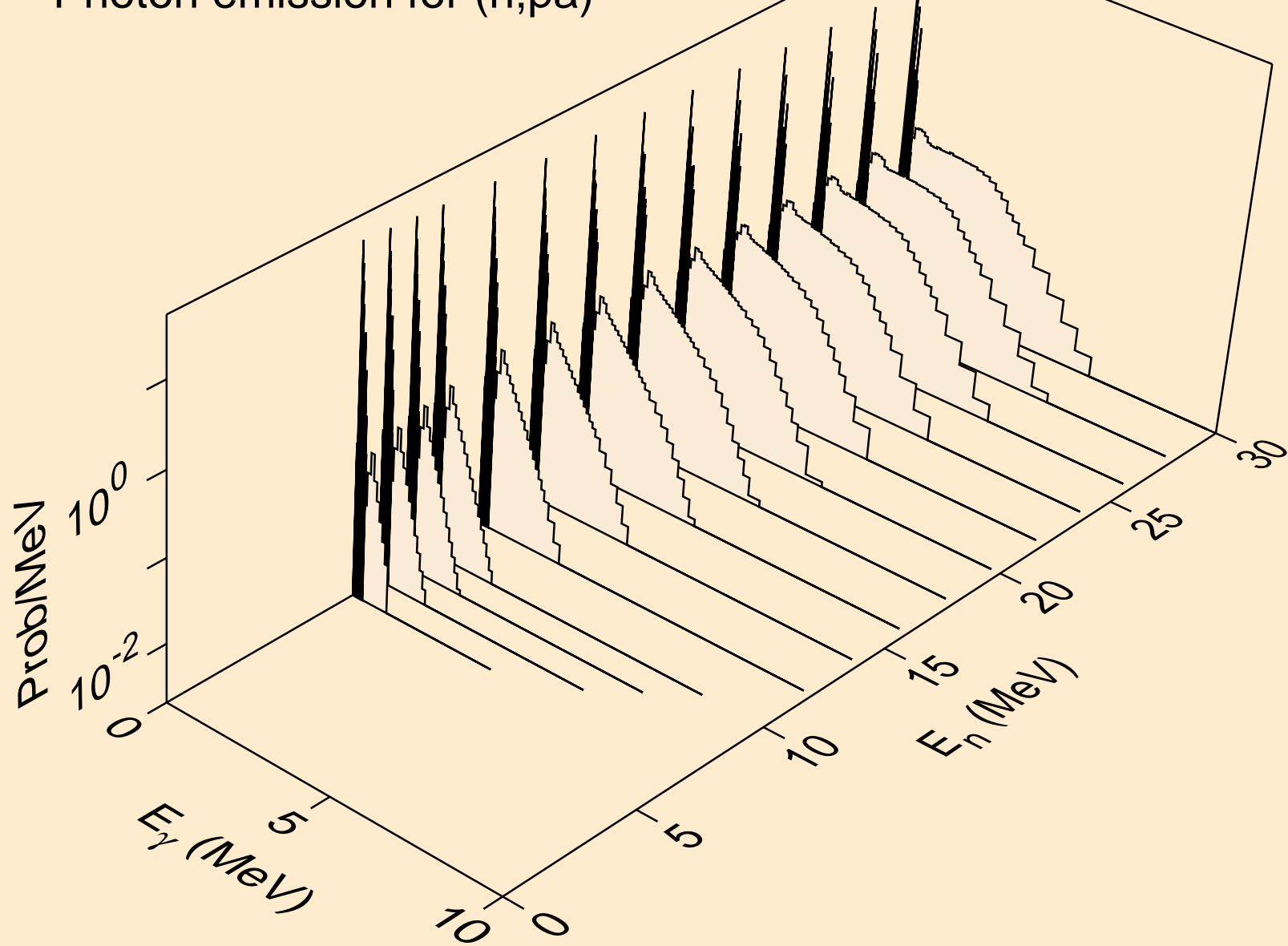

W173 PROTON ACER TENDL-2023 LIBRARY; T=0.K  
Photon emission for (n,pd)

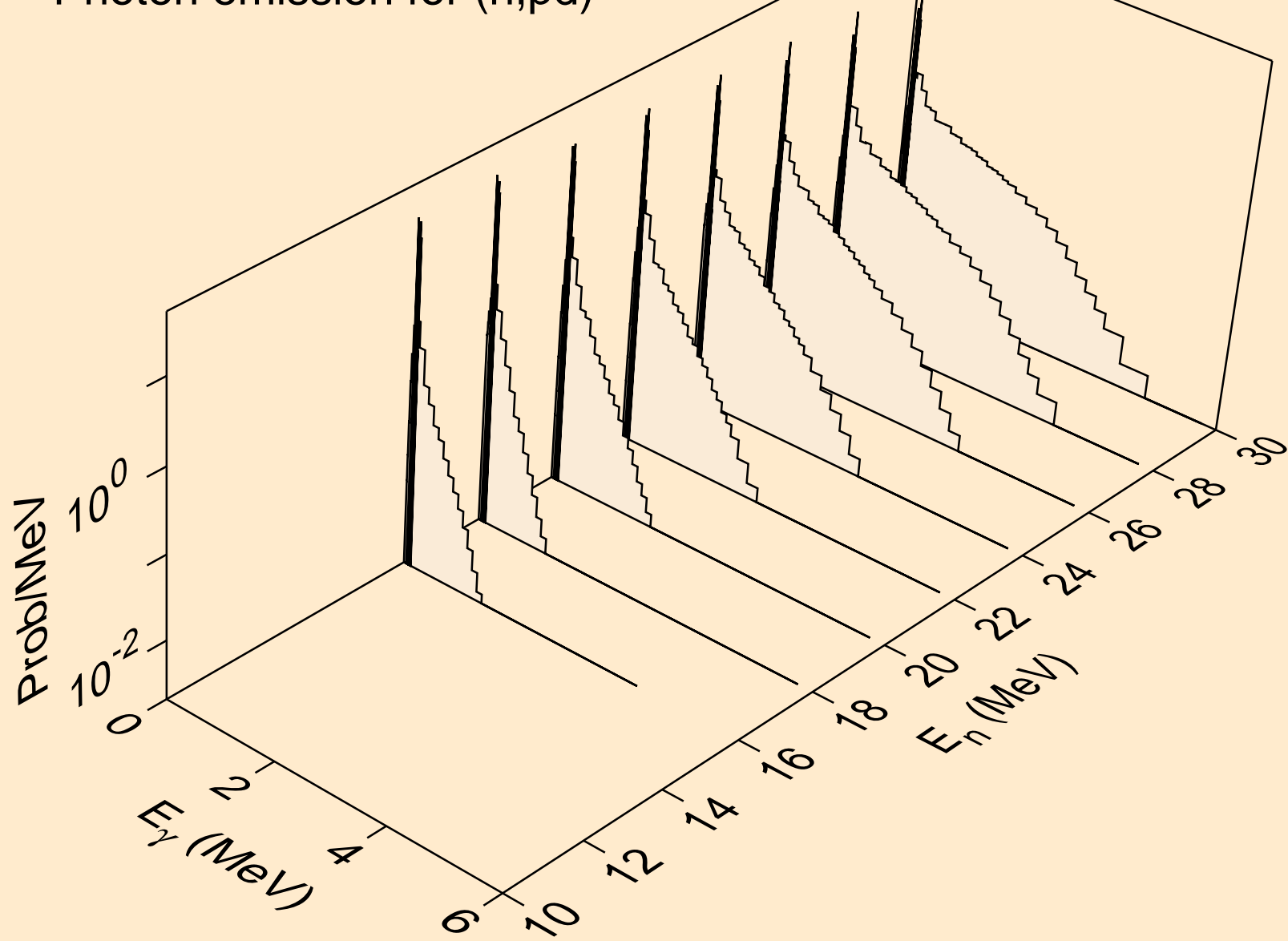

W173 PROTON ACER TENDL-2023 LIBRARY; T=0.K  
Photon emission for (n,pt)

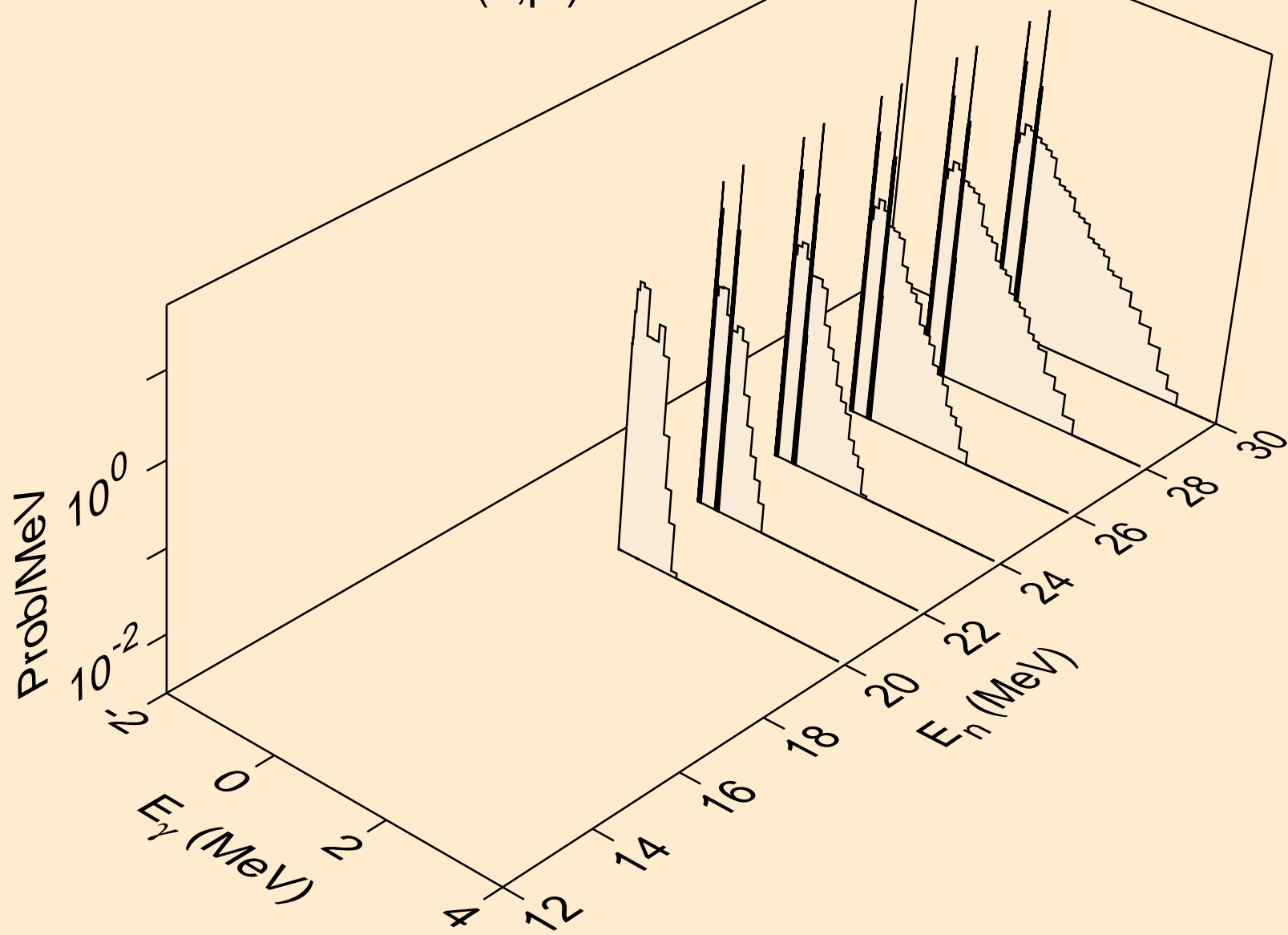



W173 PROTON ACER TENDL-2023 LIBRARY; T=0.K  
Photon emission for (n,da)

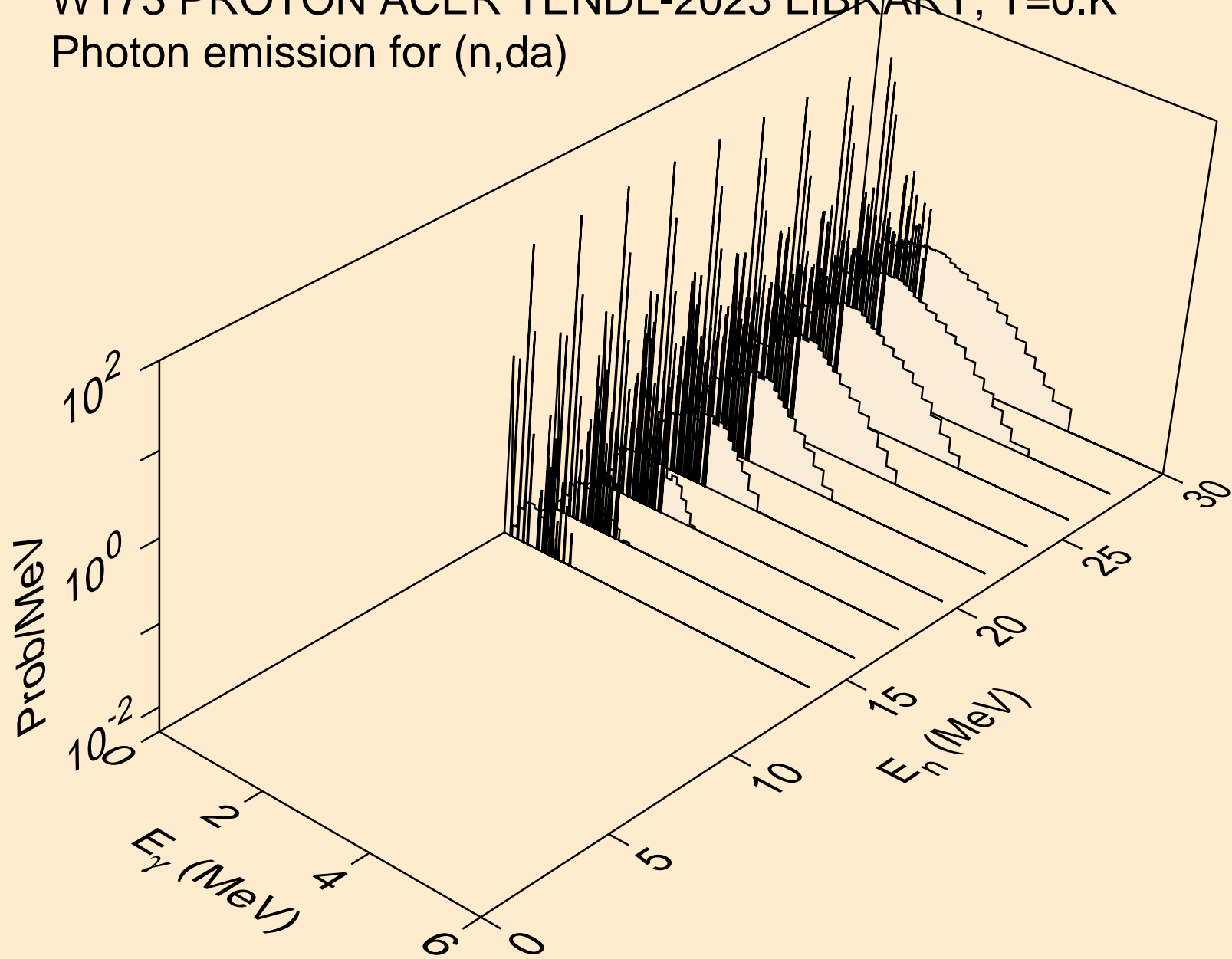

W173 PROTON ACER TENDL-2023 LIBRARY; T=0.K  
Particle heating contributions

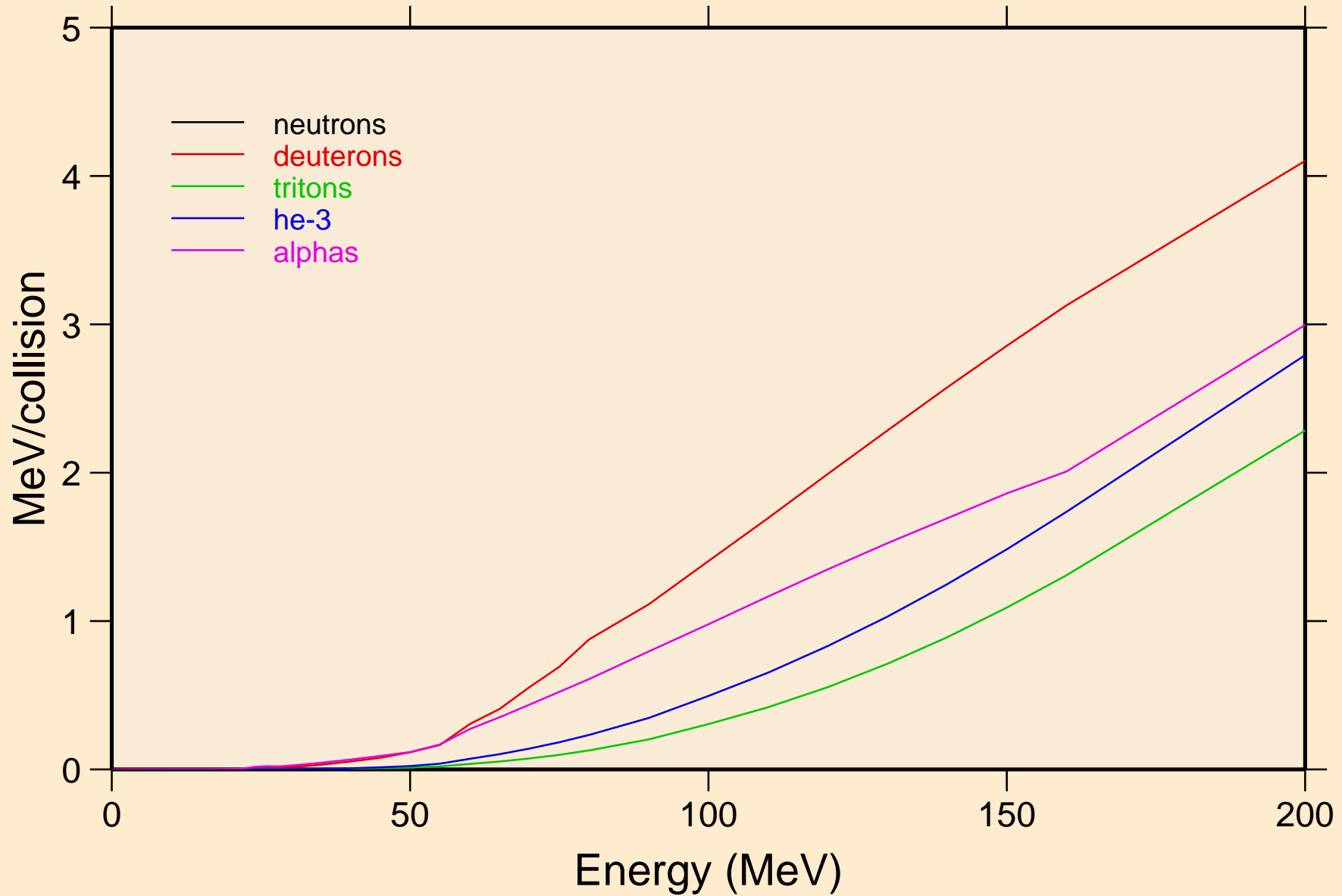

# W173 PROTON ACER TENDL-2023 LIBRARY; T=0.K

## Recoil Heating

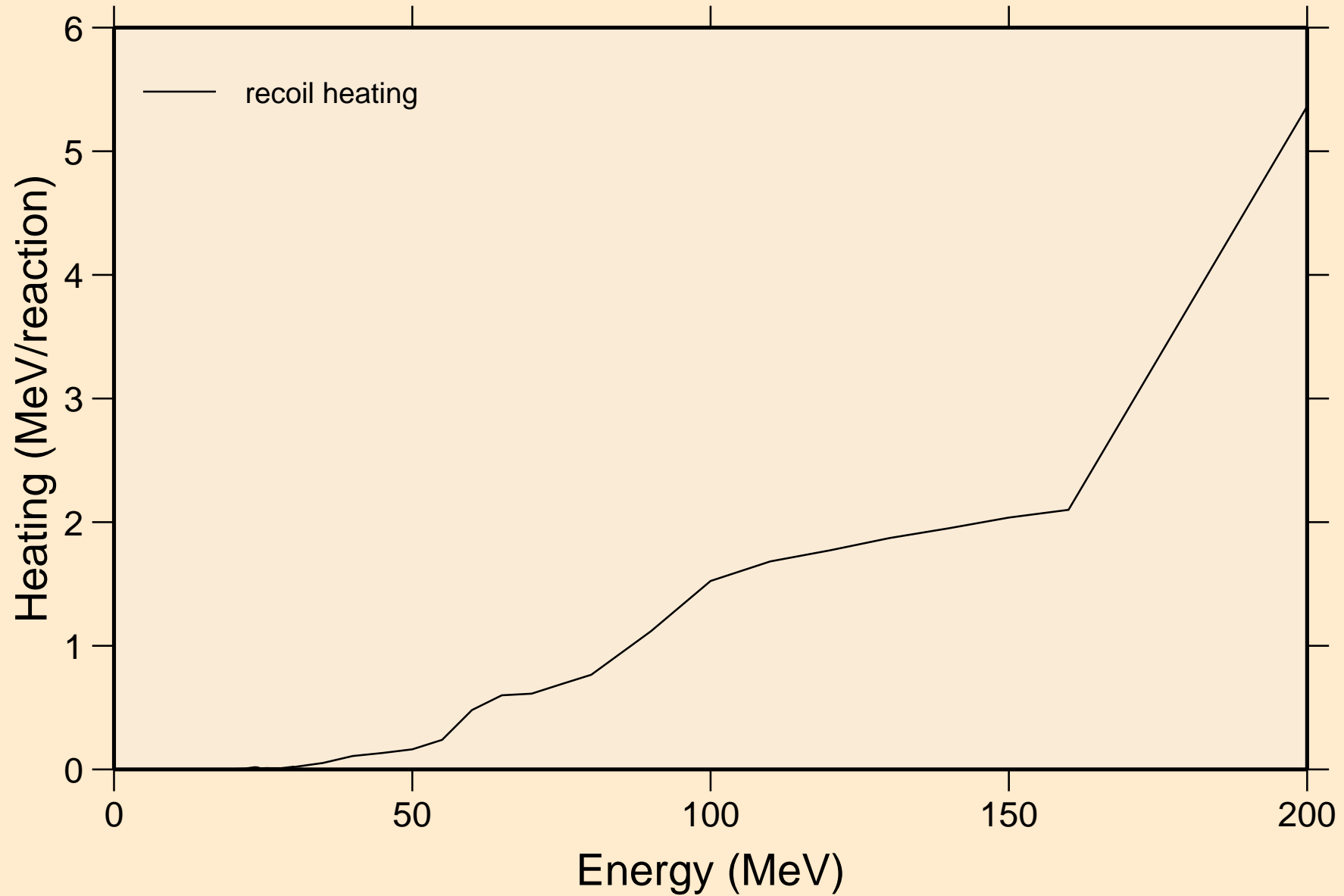

W173 PROTON ACER TENDL-2023 LIBRARY; T=0.K  
Particle production cross sections

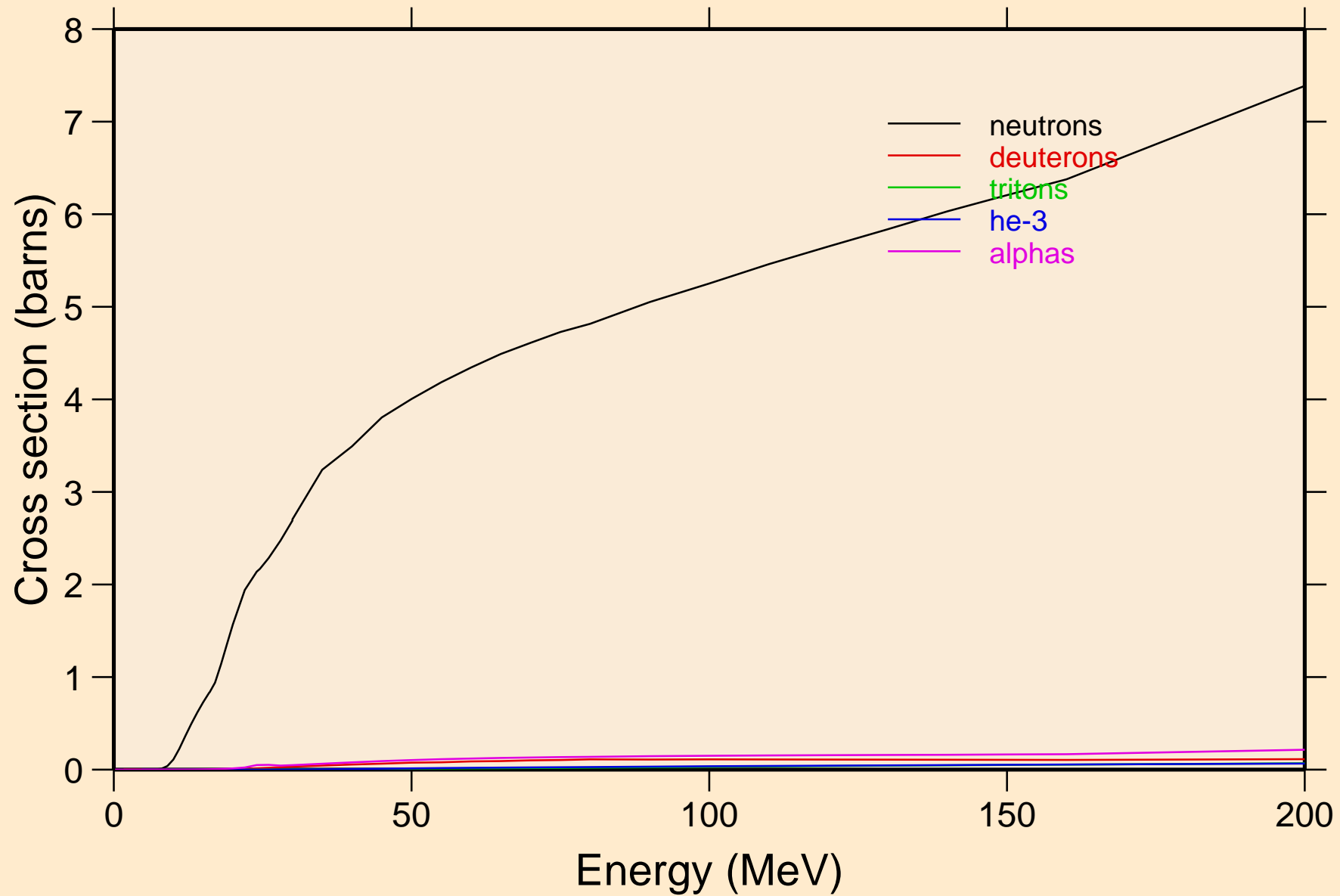

W173 PROTON ACER TENDL-2023 LIBRARY; T=0.K  
neutrons from (p,n)

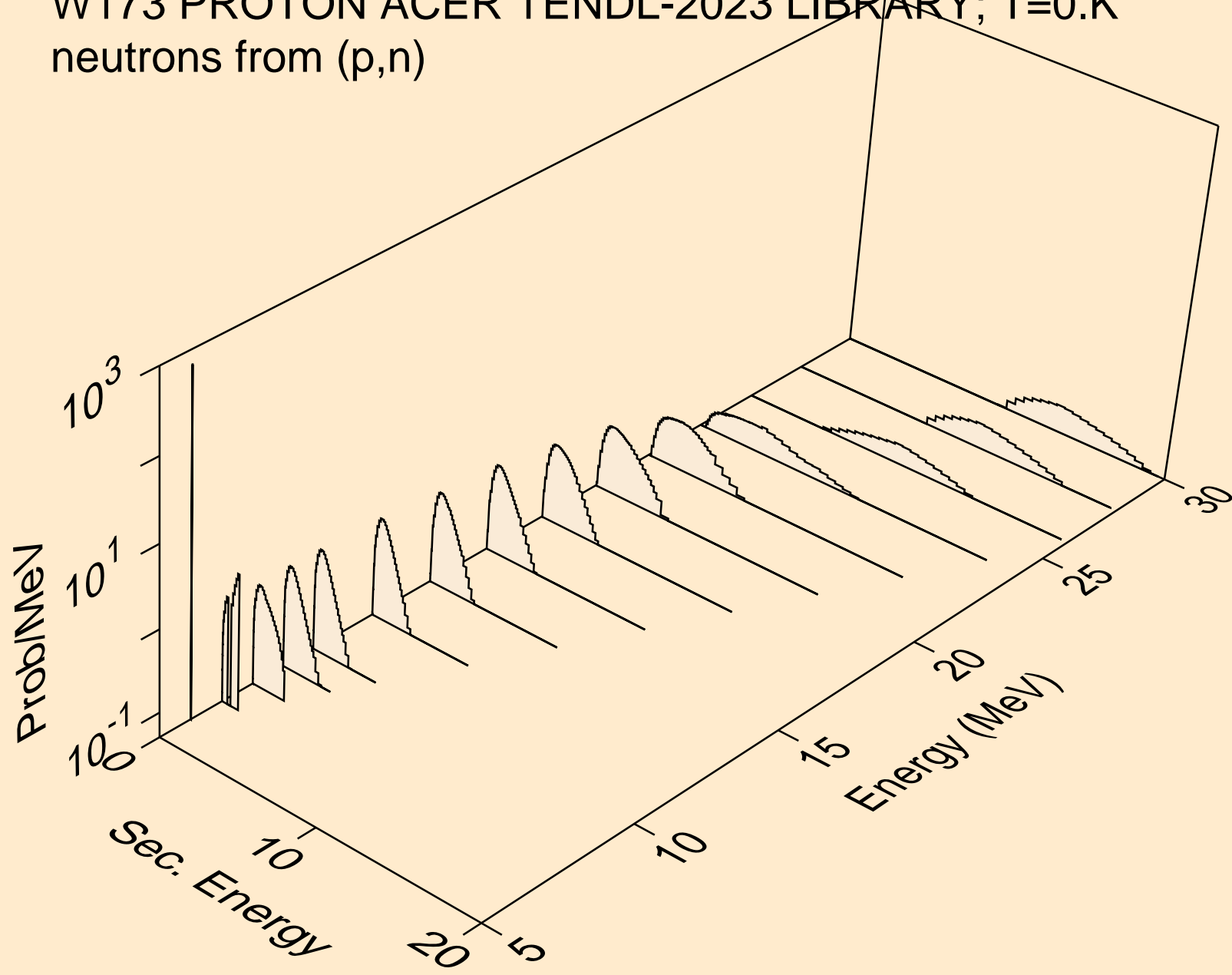

W173 PROTON ACER TENDL-2023 LIBRARY; T=0.K  
neutrons from (p,x)

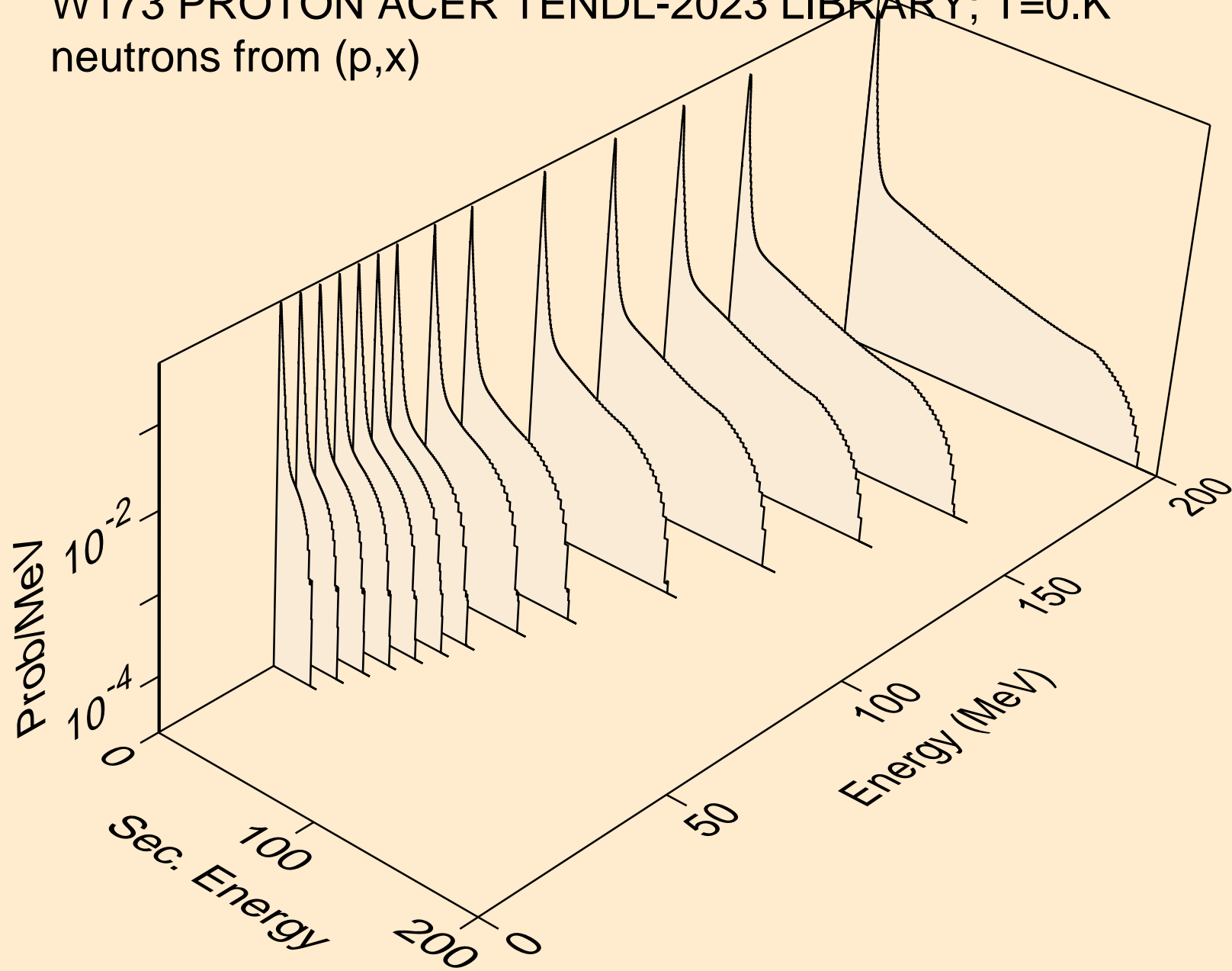

W173 PROTON ACER TENDL-2023 LIBRARY; T=0.K  
neutrons from (p,2nd)

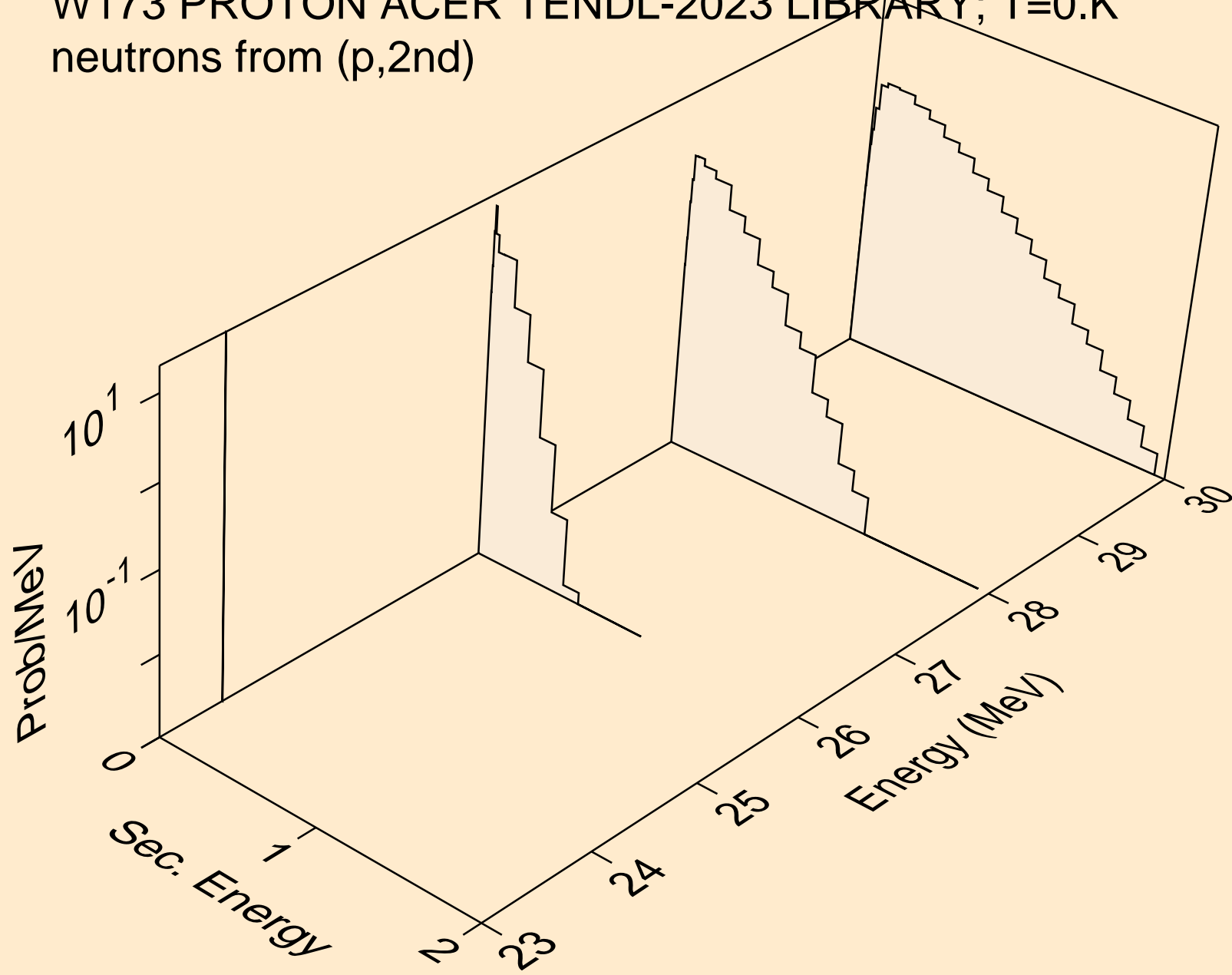

W173 PROTON ACER TENDL-2023 LIBRARY; T=0.K  
neutrons from (p,2n)

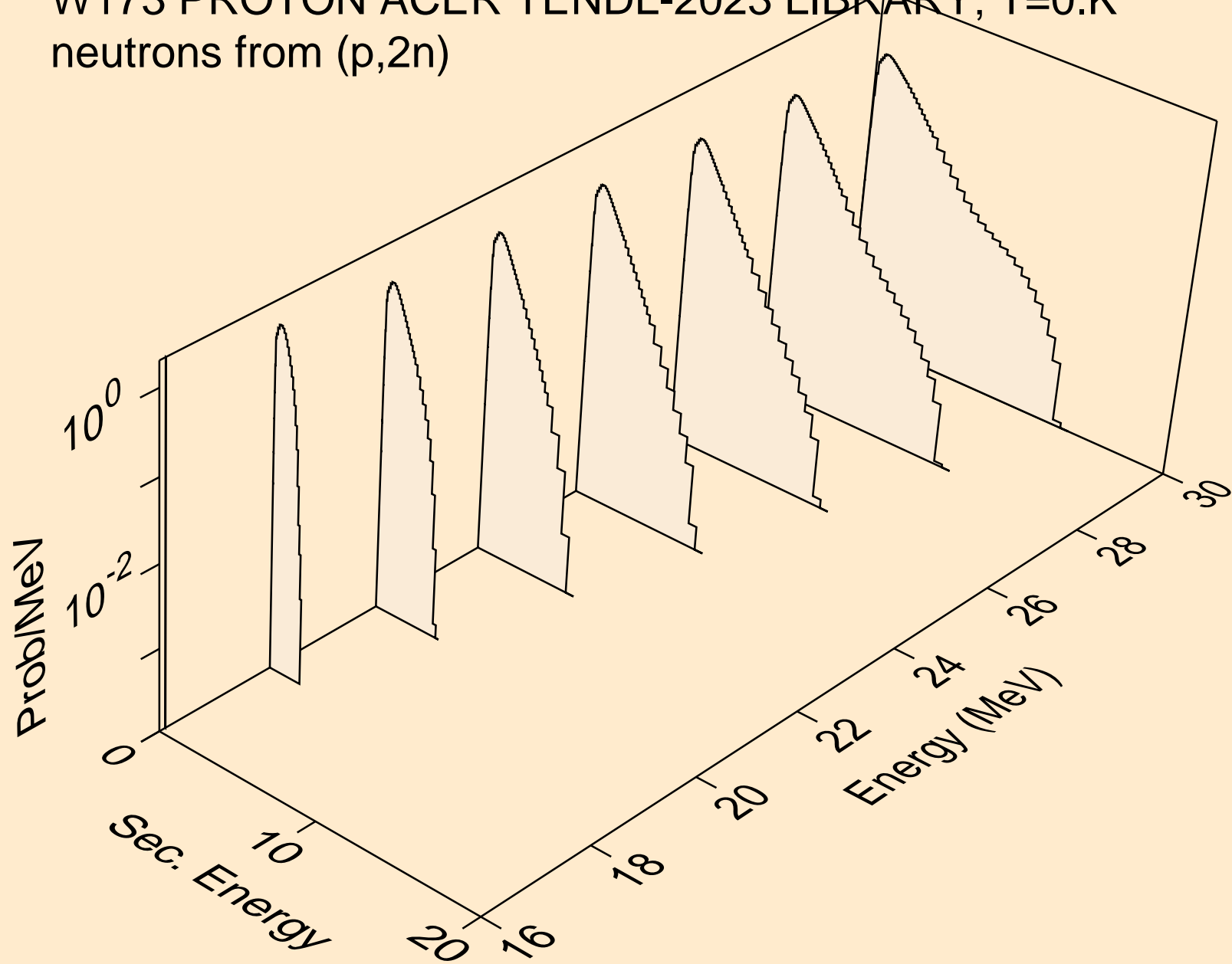



W173 PROTON ACER TENDL-2023 LIBRARY; T=0.K  
neutrons from (p,3n)

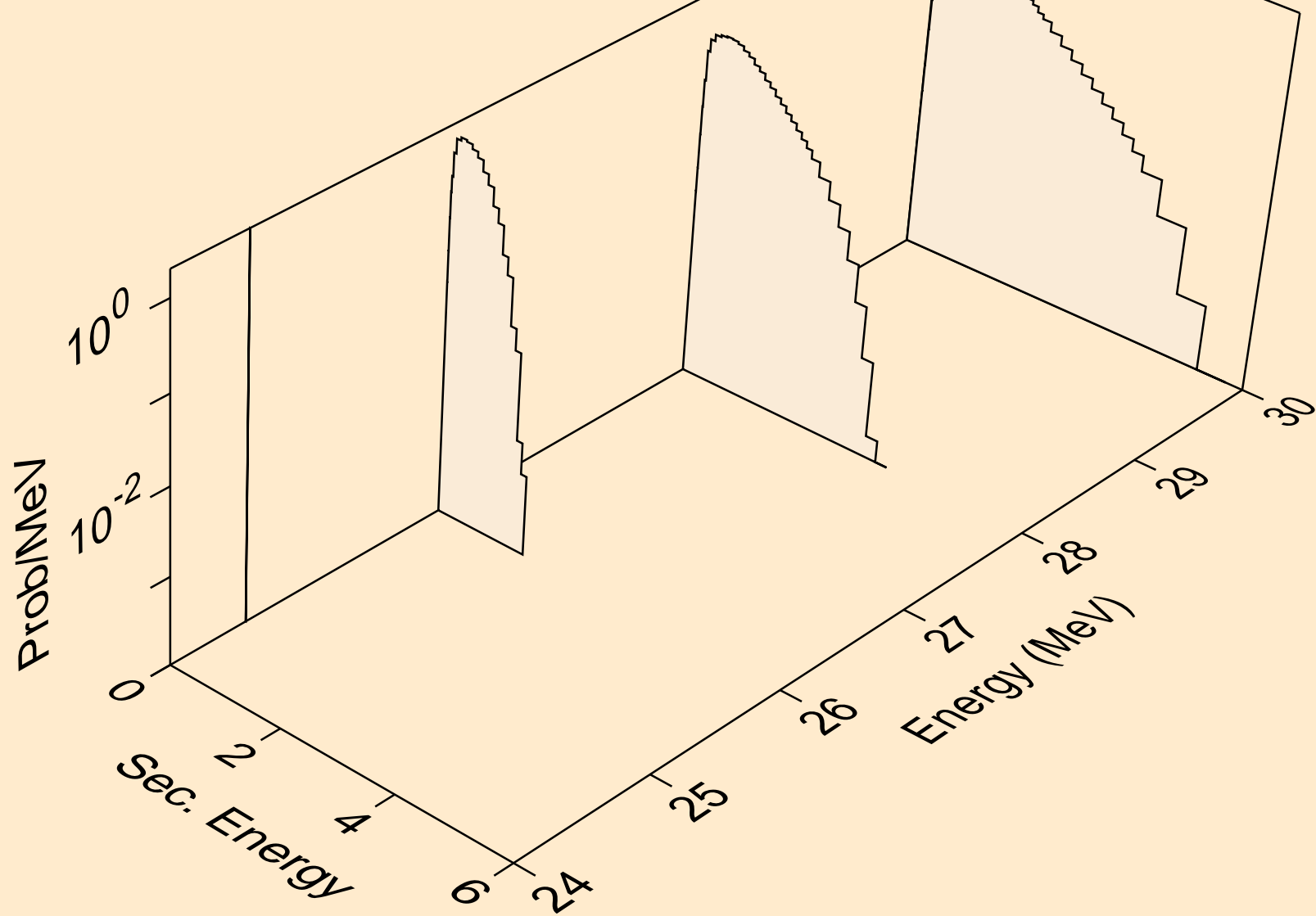

W173 PROTON ACER TENDL-2023 LIBRARY; T=0.K  
neutrons from (p,n\*)a

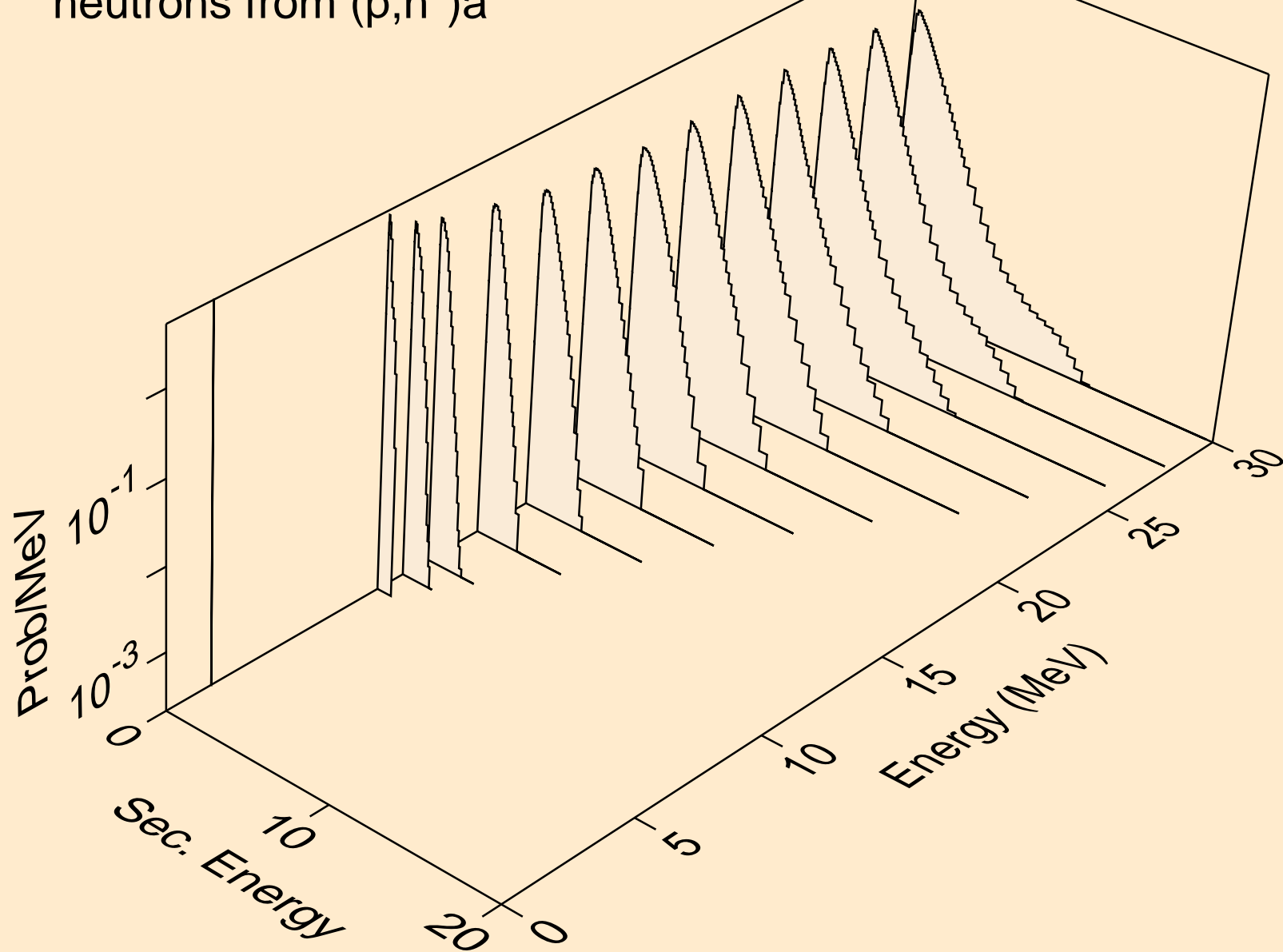

W173 PROTON ACER TENDL-2023 LIBRARY; T=0.K  
neutrons from (p,2n)a

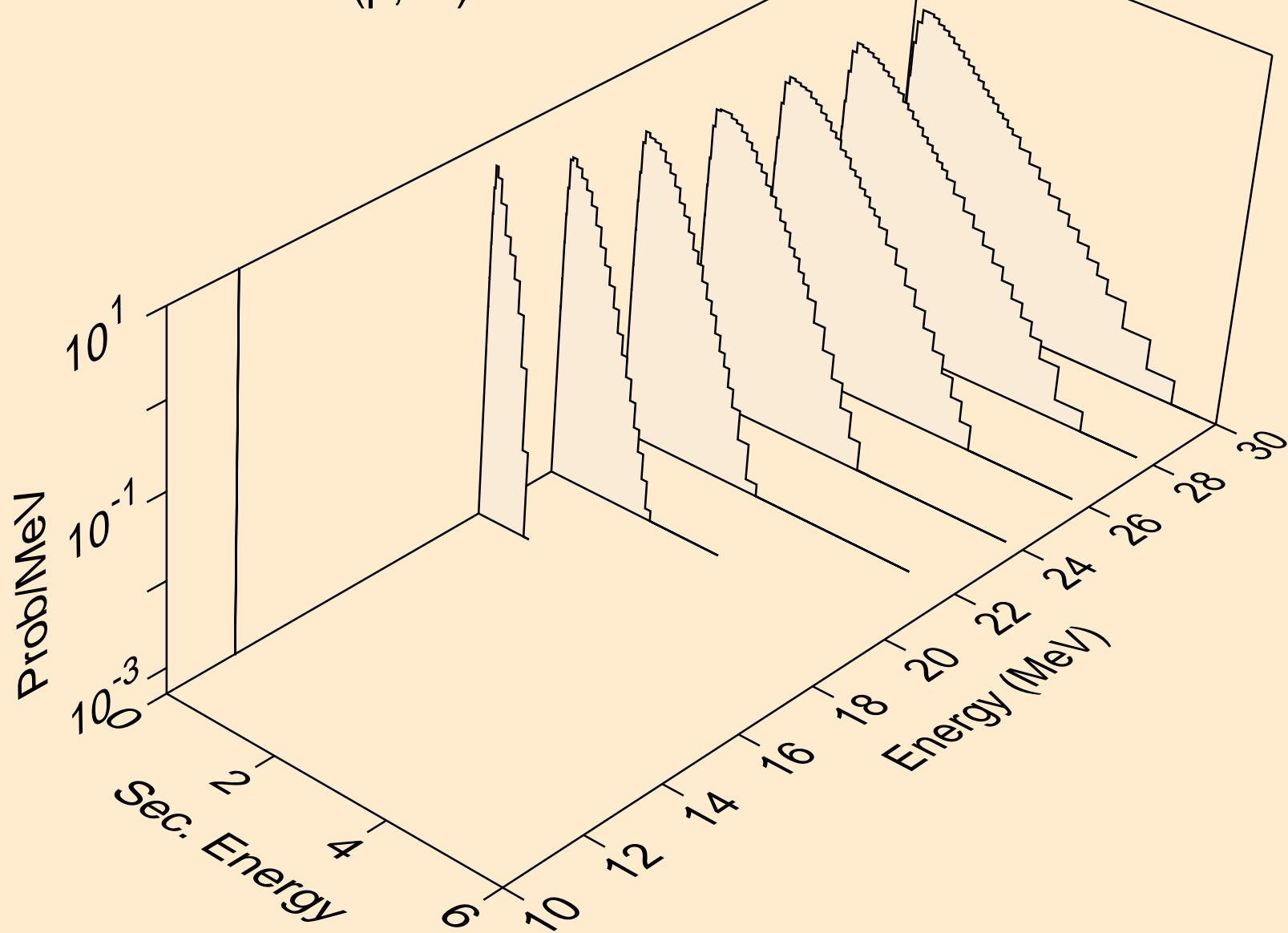

W173 PROTON ACER TENDL-2023 LIBRARY; T=0.K  
neutrons from (p,3n)a

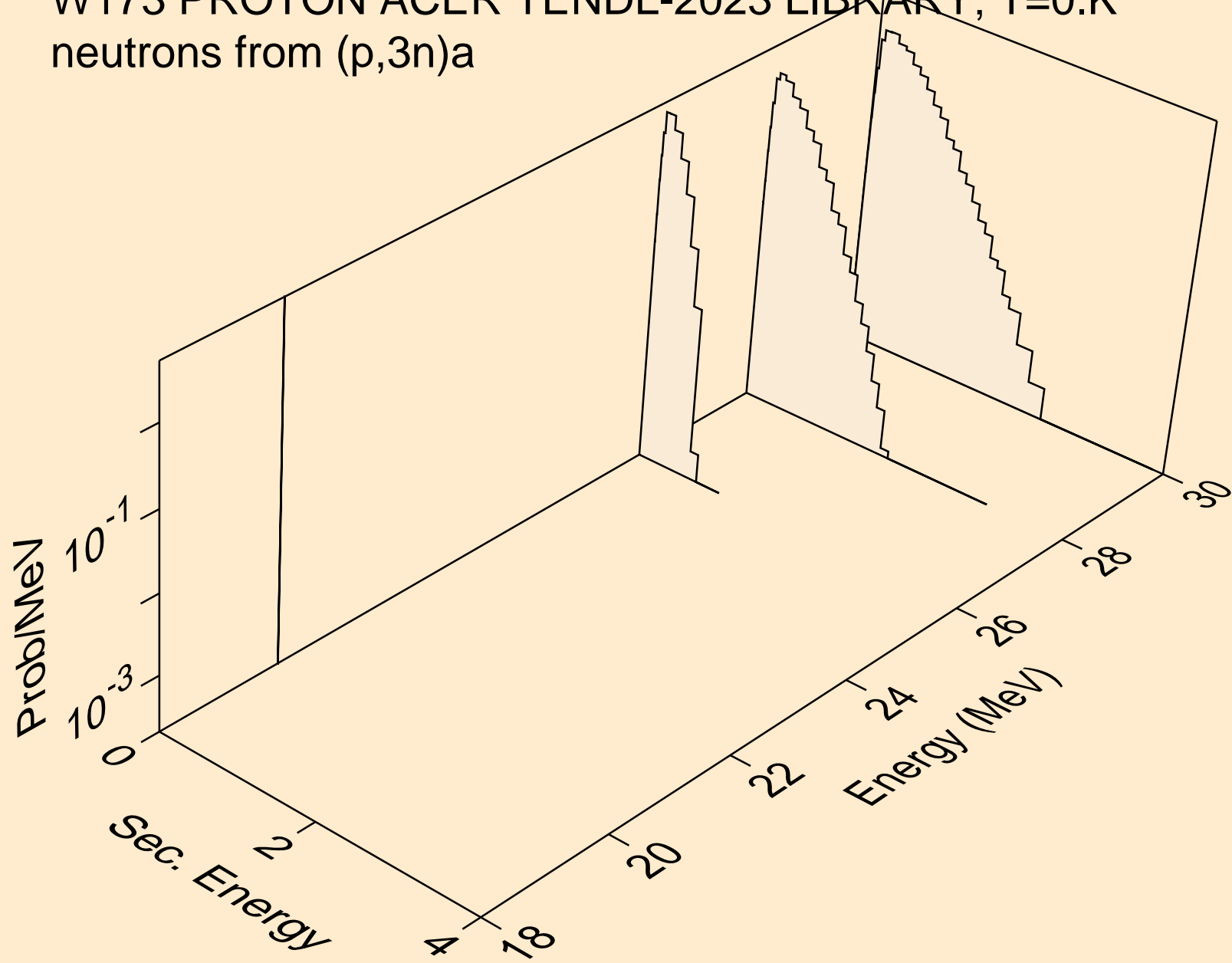

W173 PROTON ACER TENDL-2023 LIBRARY; T=0.K  
neutrons from (p,n\*)p

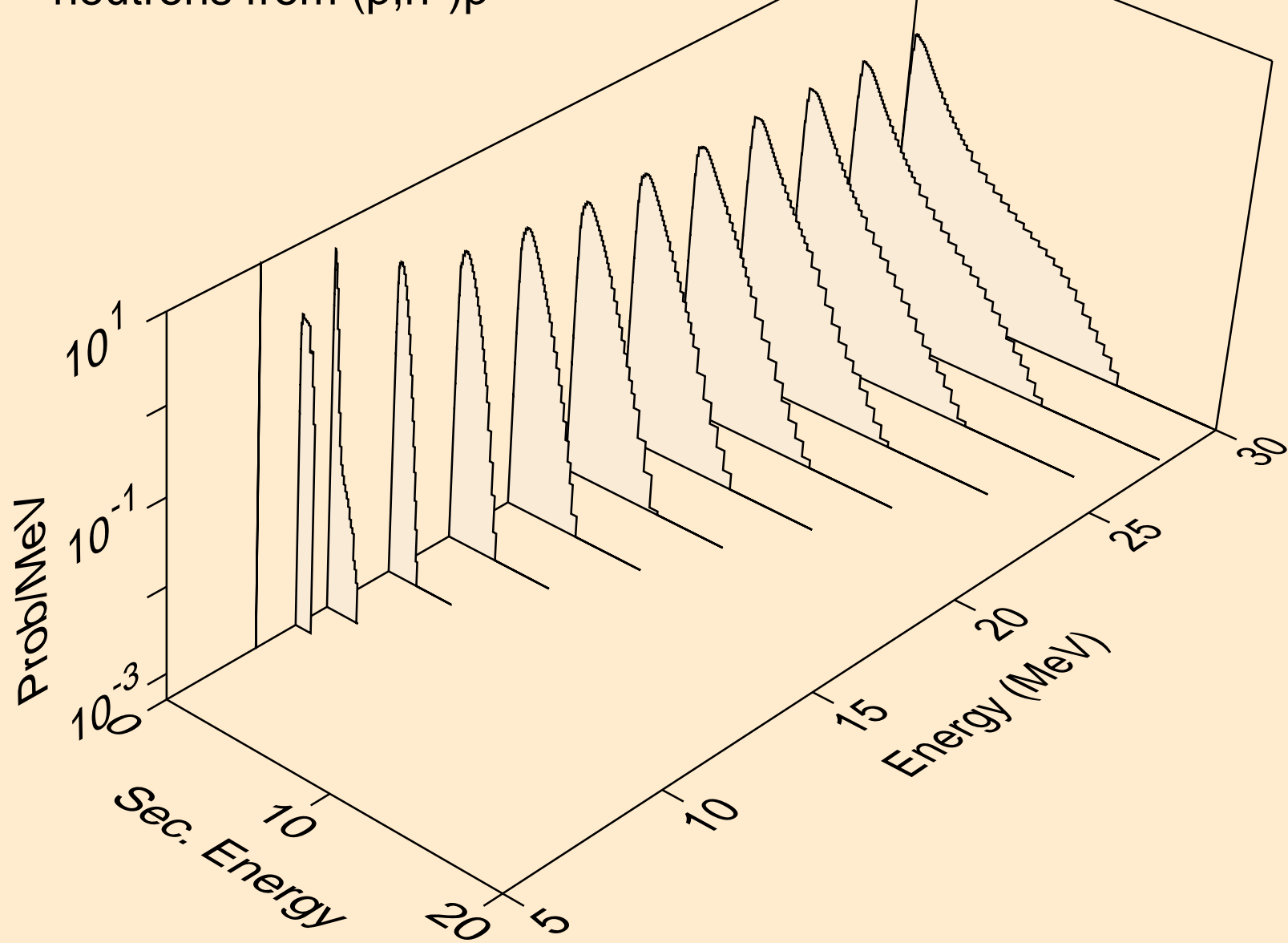

W173 PROTON ACER TENDL-2023 LIBRARY; T=0.K  
neutrons from (p,n\*)2a

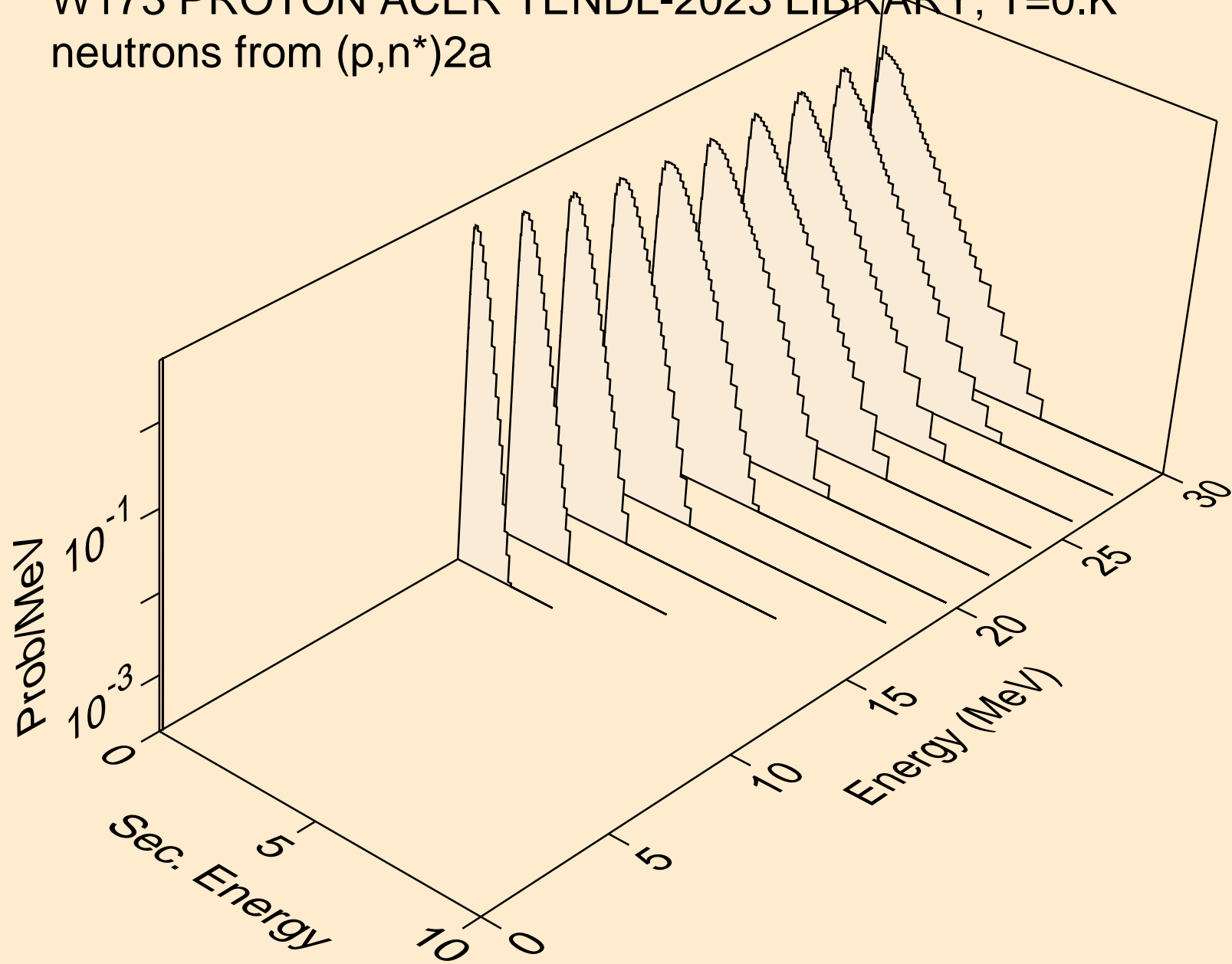

W173 PROTON ACER TENDL-2023 LIBRARY; T=0.K  
neutrons from (p,n\*)d

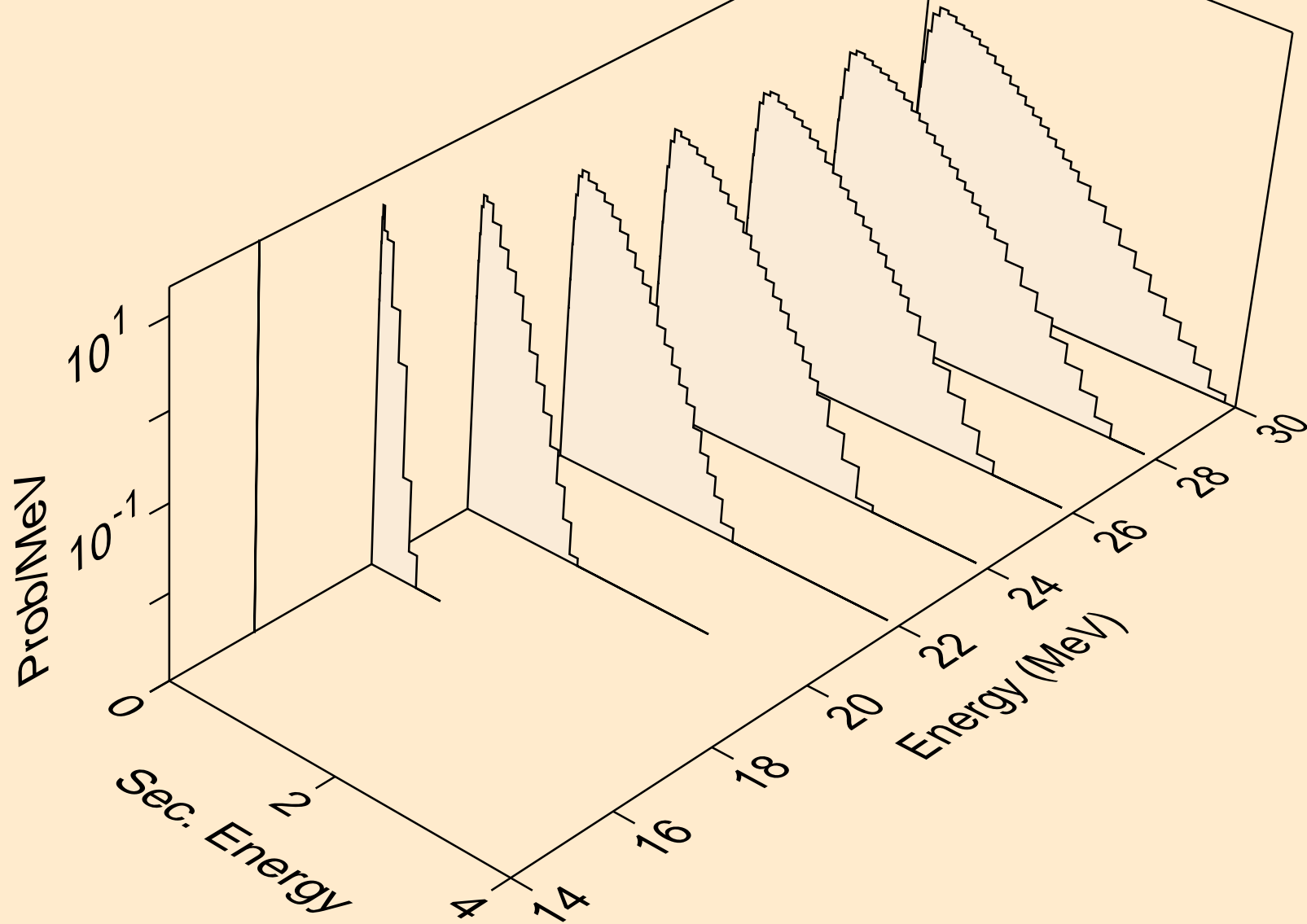

W173 PROTON ACER TENDL-2023 LIBRARY; T=0.K  
neutrons from (p,n\*)t

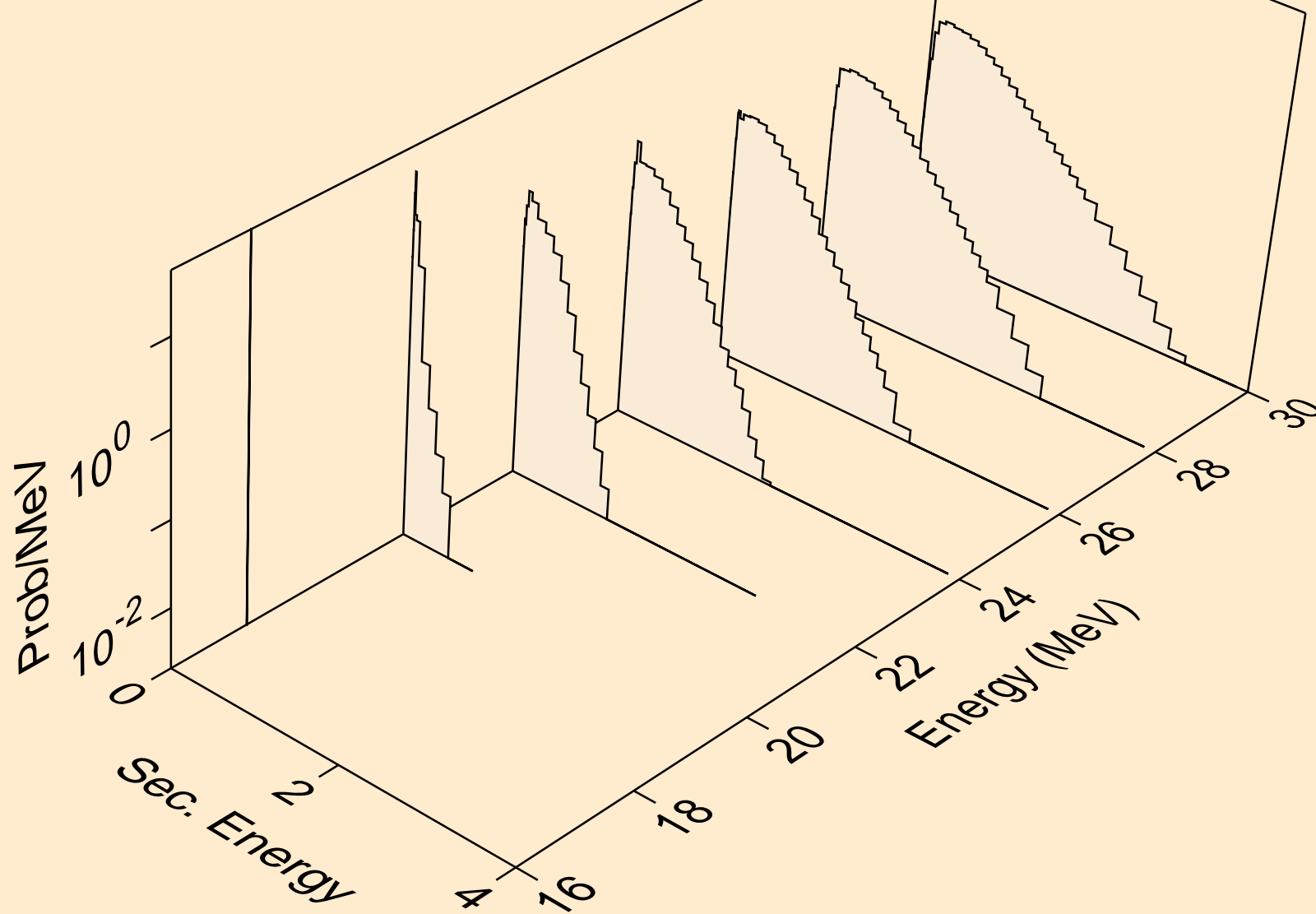



W173 PROTON ACER TENDL-2023 LIBRARY; T=0.K  
neutrons from (p,n\*)he3

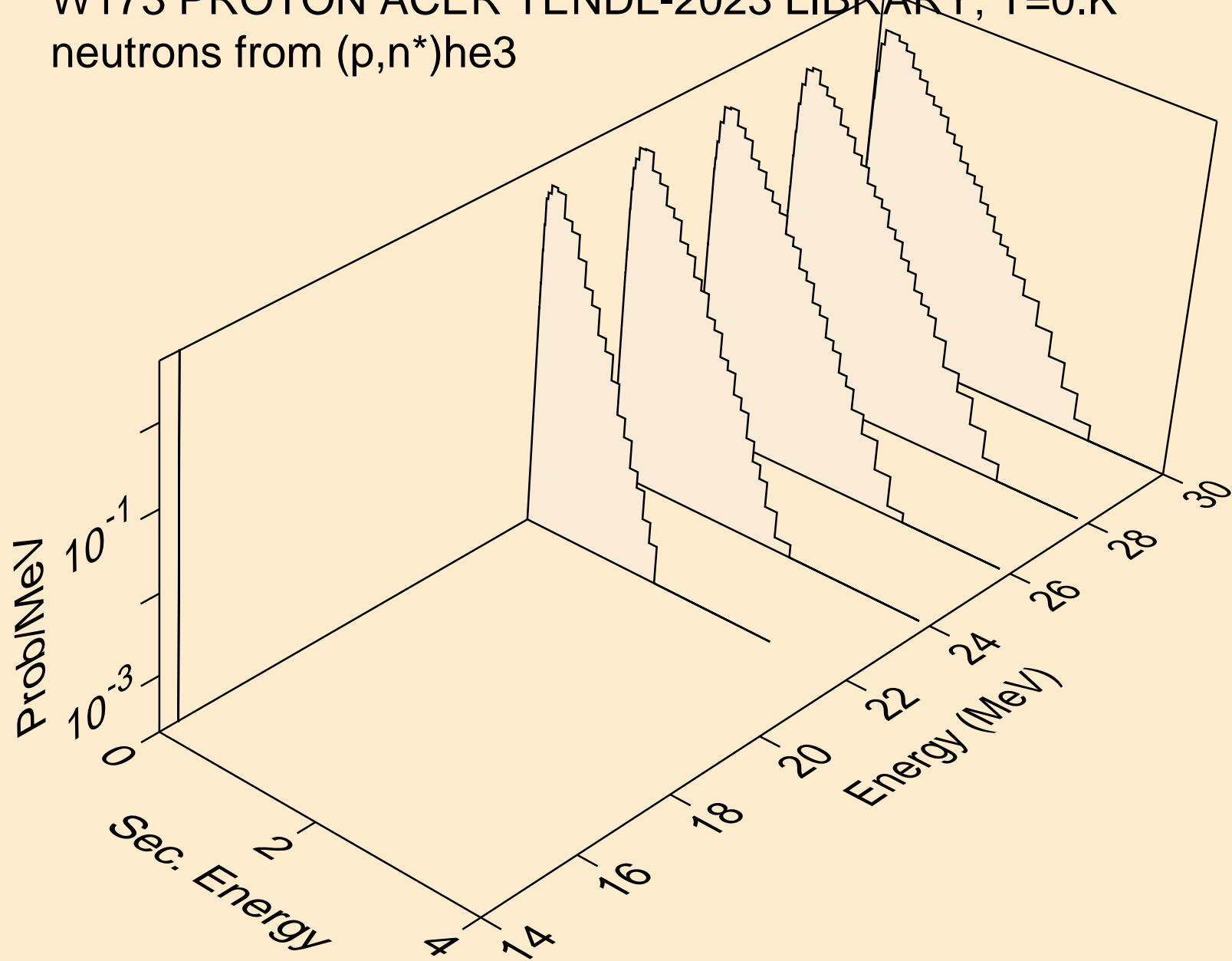

W173 PROTON ACER TENDL-2023 LIBRARY; T=0.K  
neutrons from (p,2np)

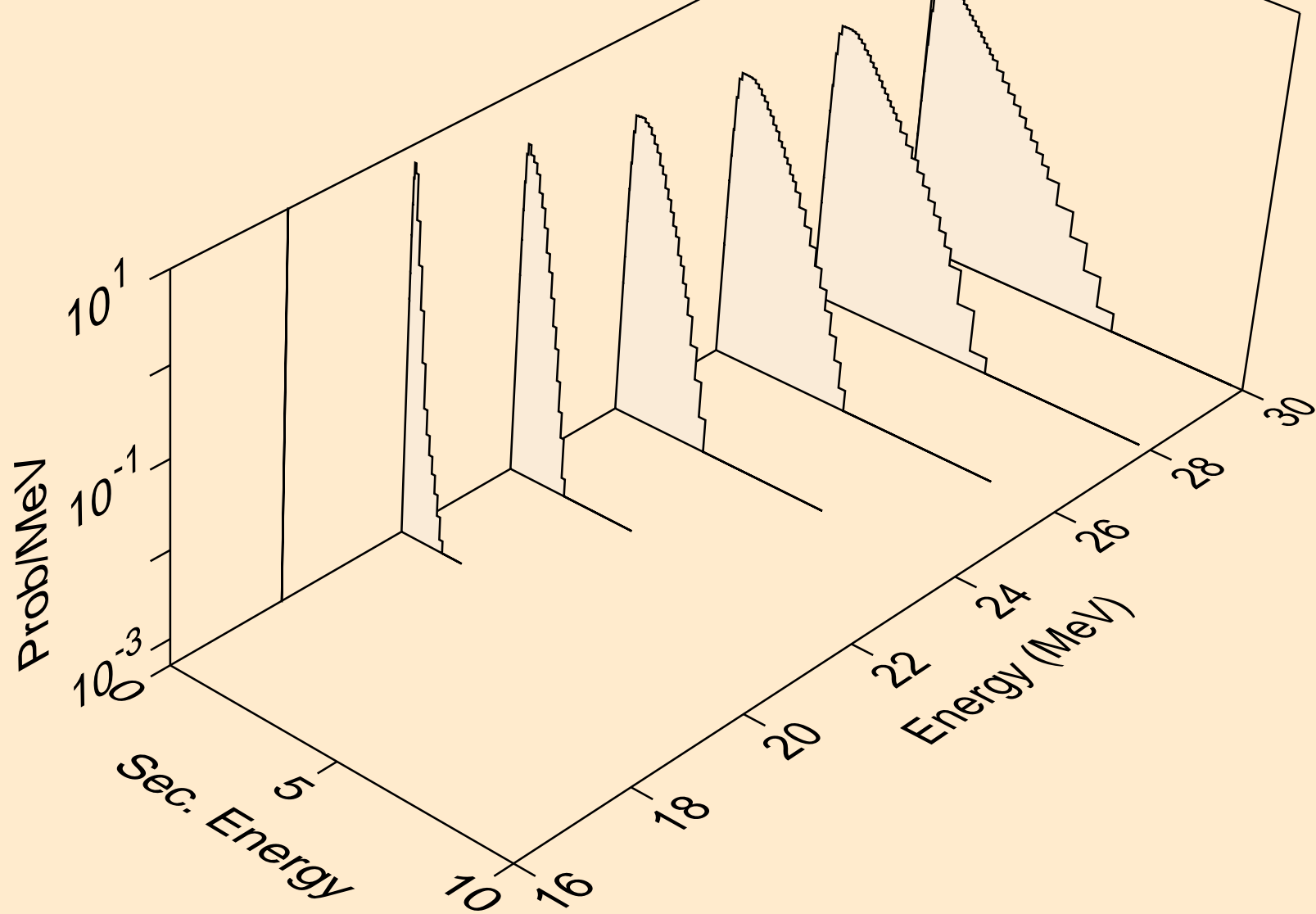

W173 PROTON ACER TENDL-2023 LIBRARY; T=0.K  
neutrons from (p,3np)

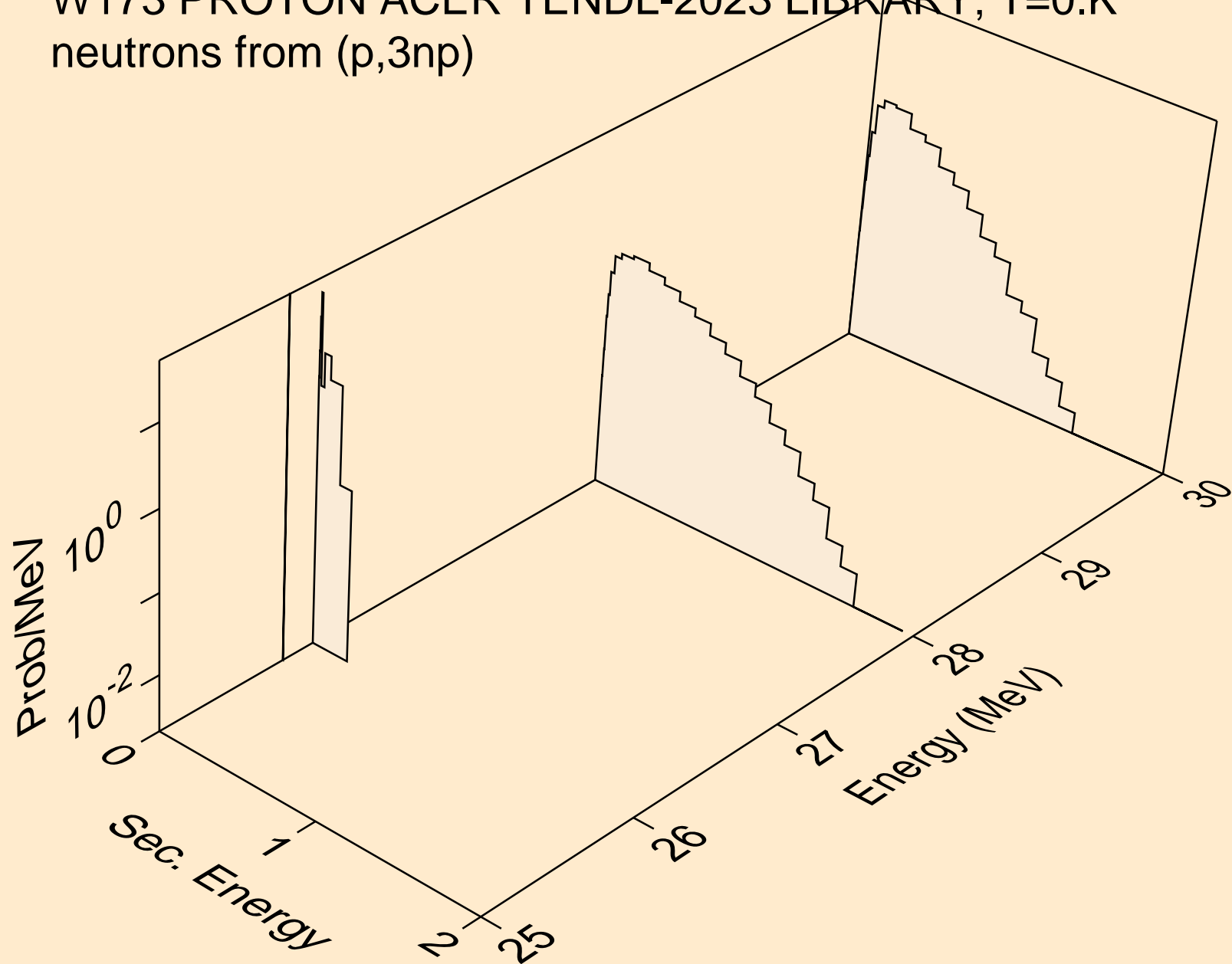

W173 PROTON ACER TENDL-2023 LIBRARY; T=0.K  
neutrons from (p,n2p)

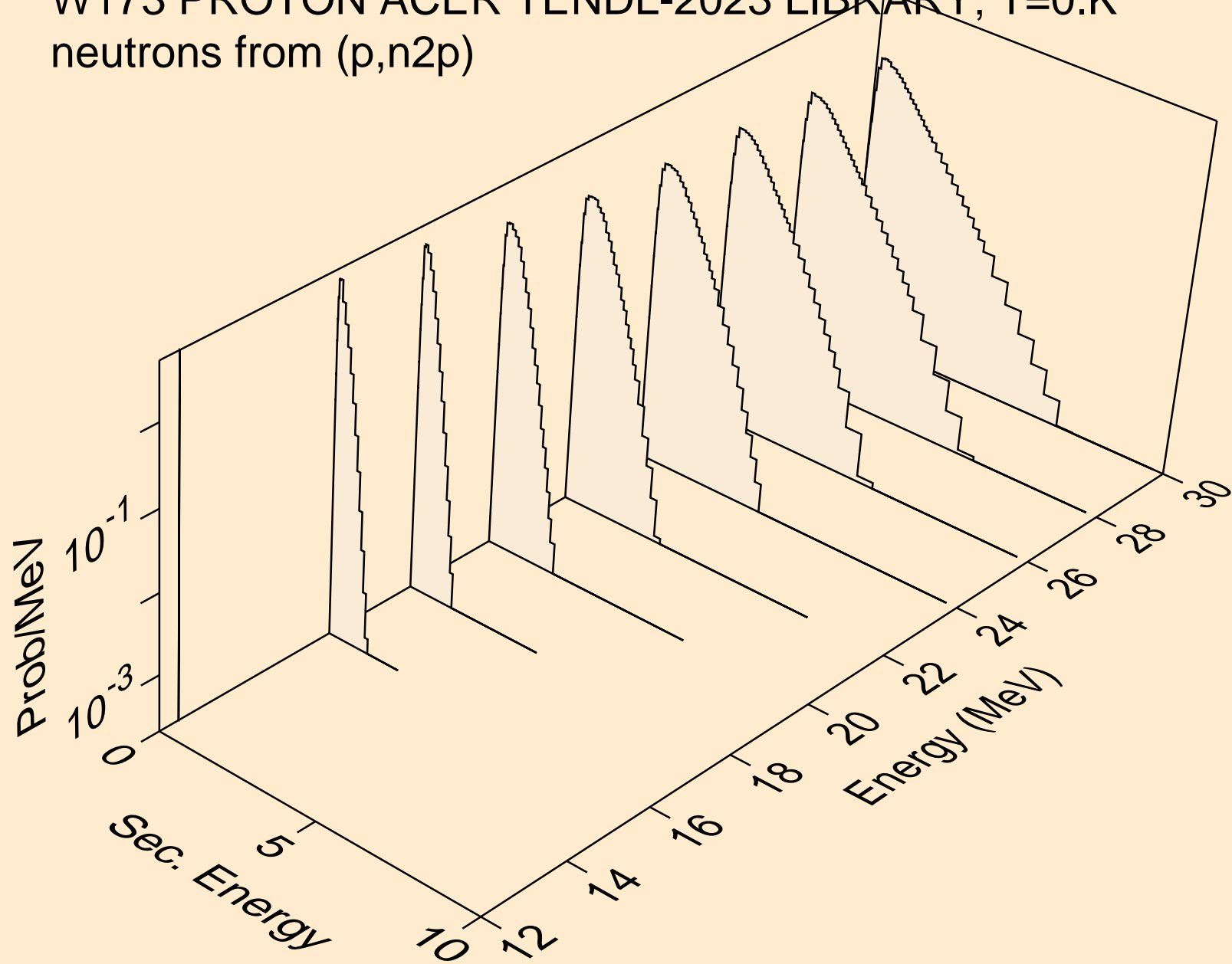

W173 PROTON ACER TENDL-2023 LIBRARY; T=0.K  
neutrons from (p,npa)

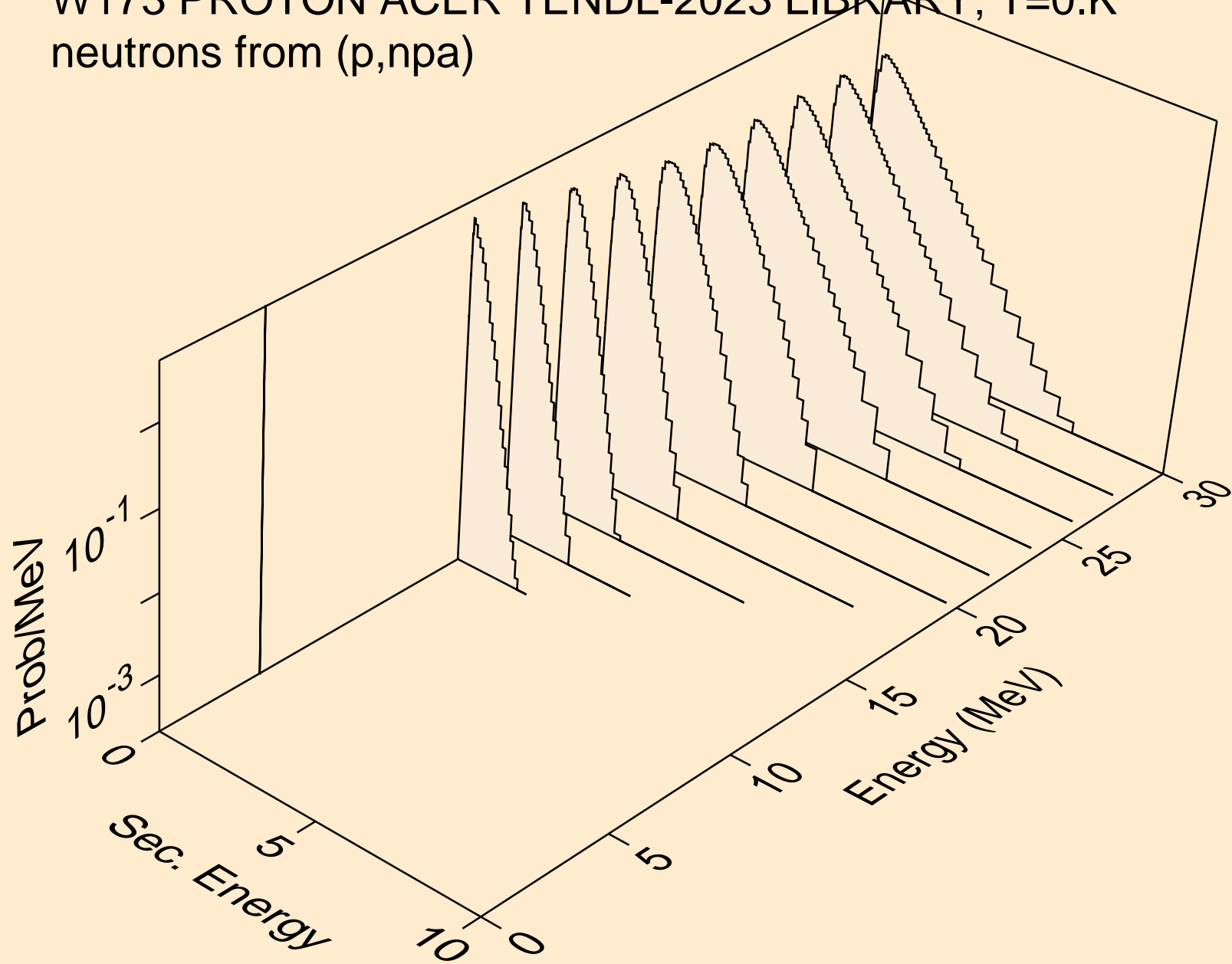

W173 PROTON ACER TENDL-2023 LIBRARY; T=0.K  
deuterons from (p,x)

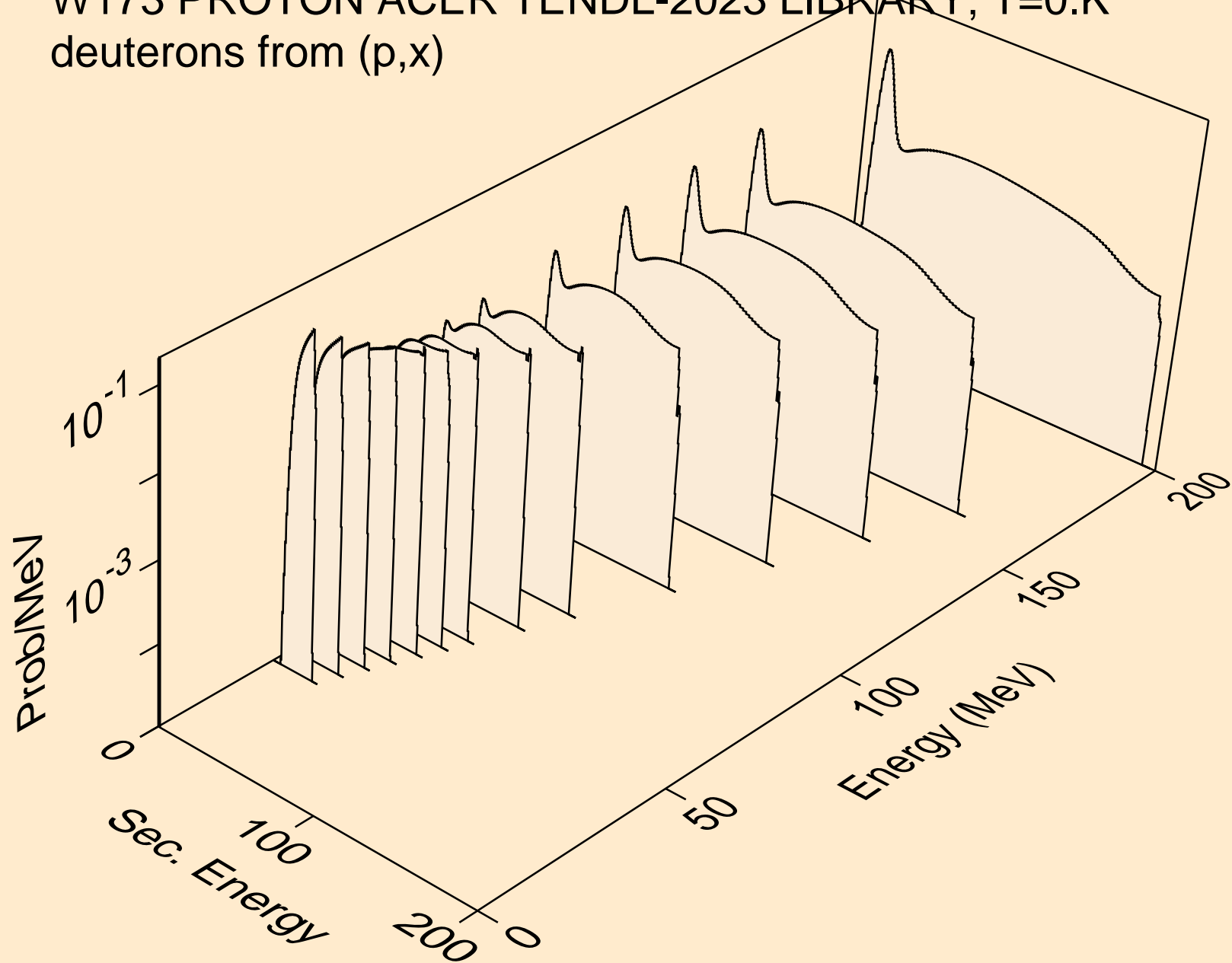

W173 PROTON ACER TENDL-2023 LIBRARY; T=0.K  
deuterons from (p,2nd)

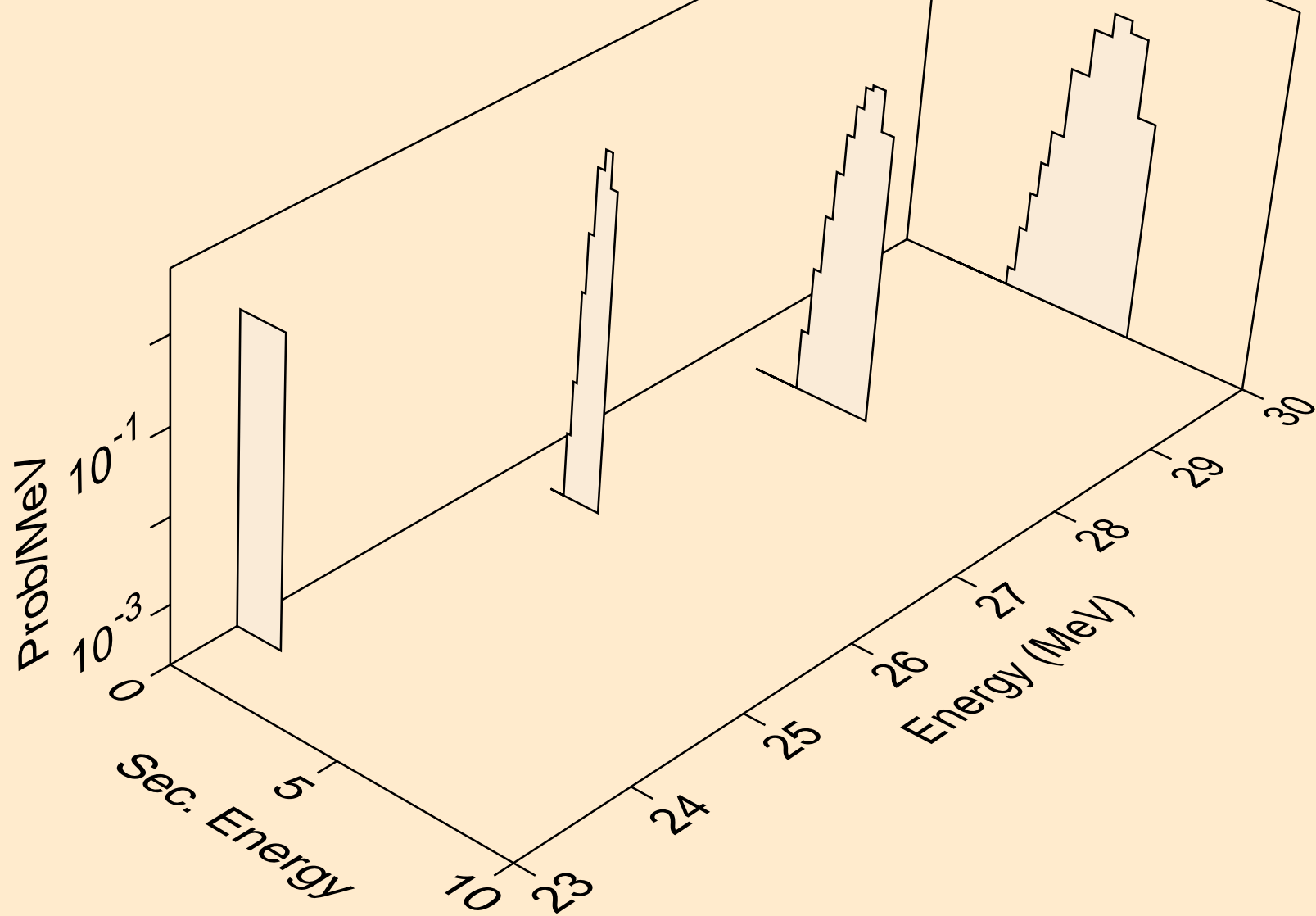

W173 PROTON ACER TENDL-2023 LIBRARY; T=0.K  
deuterons from (p,n\*)d

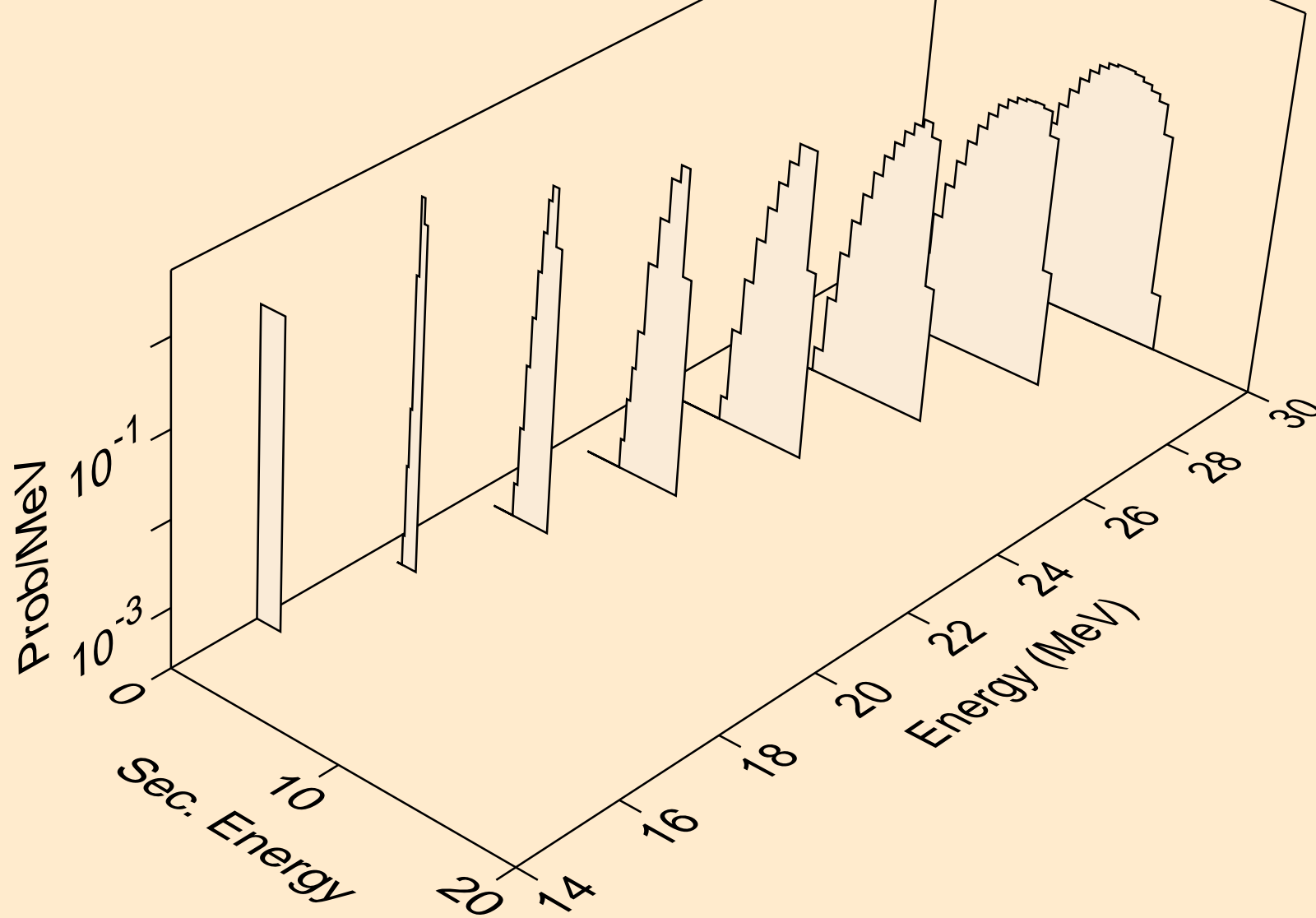



W173 PROTON ACER TENDL-2023 LIBRARY; T=0.K  
deuterons from (p,d)

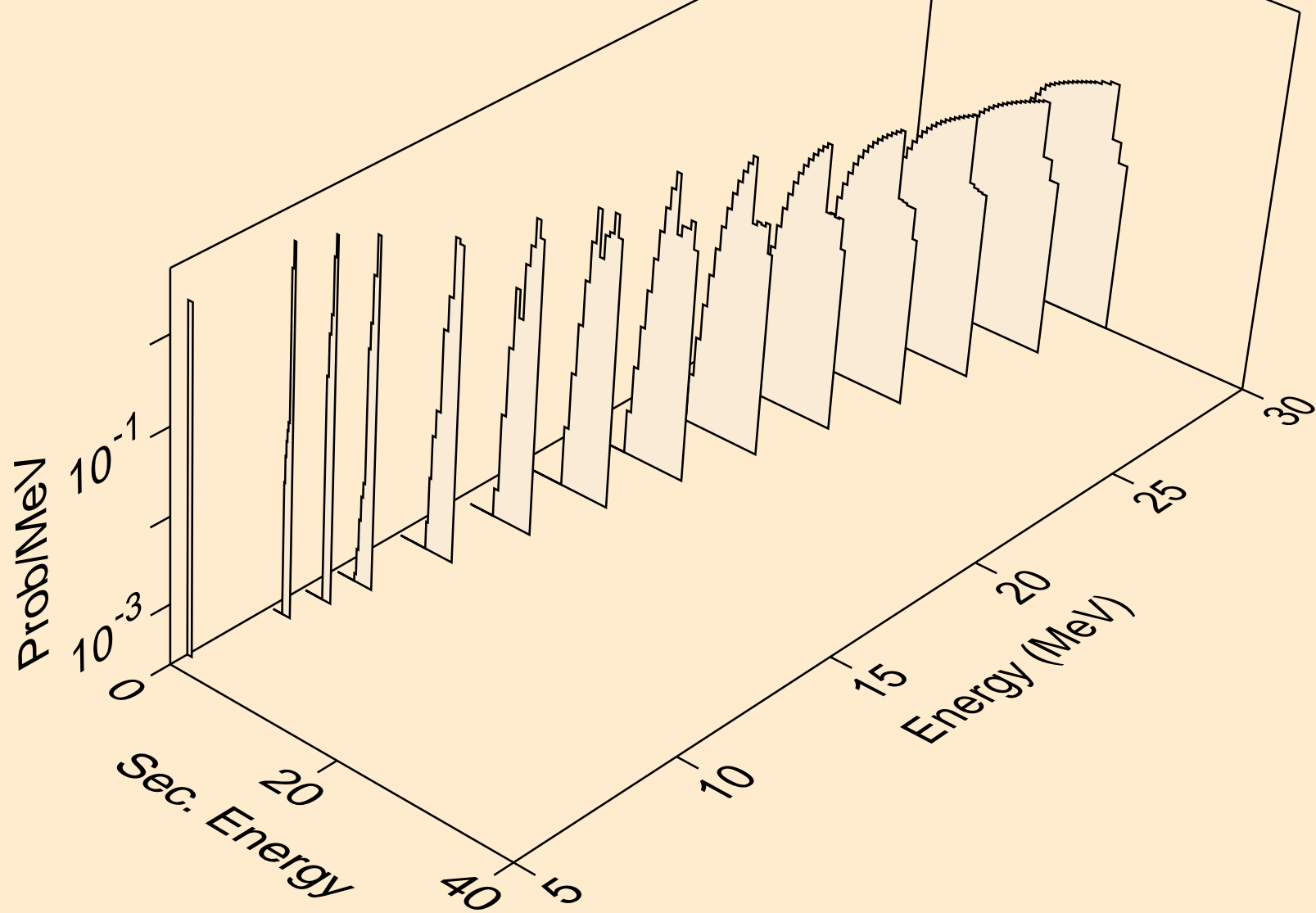

W173 PROTON ACER TENDL-2023 LIBRARY; T=0.K  
deuterons from (p,pd)

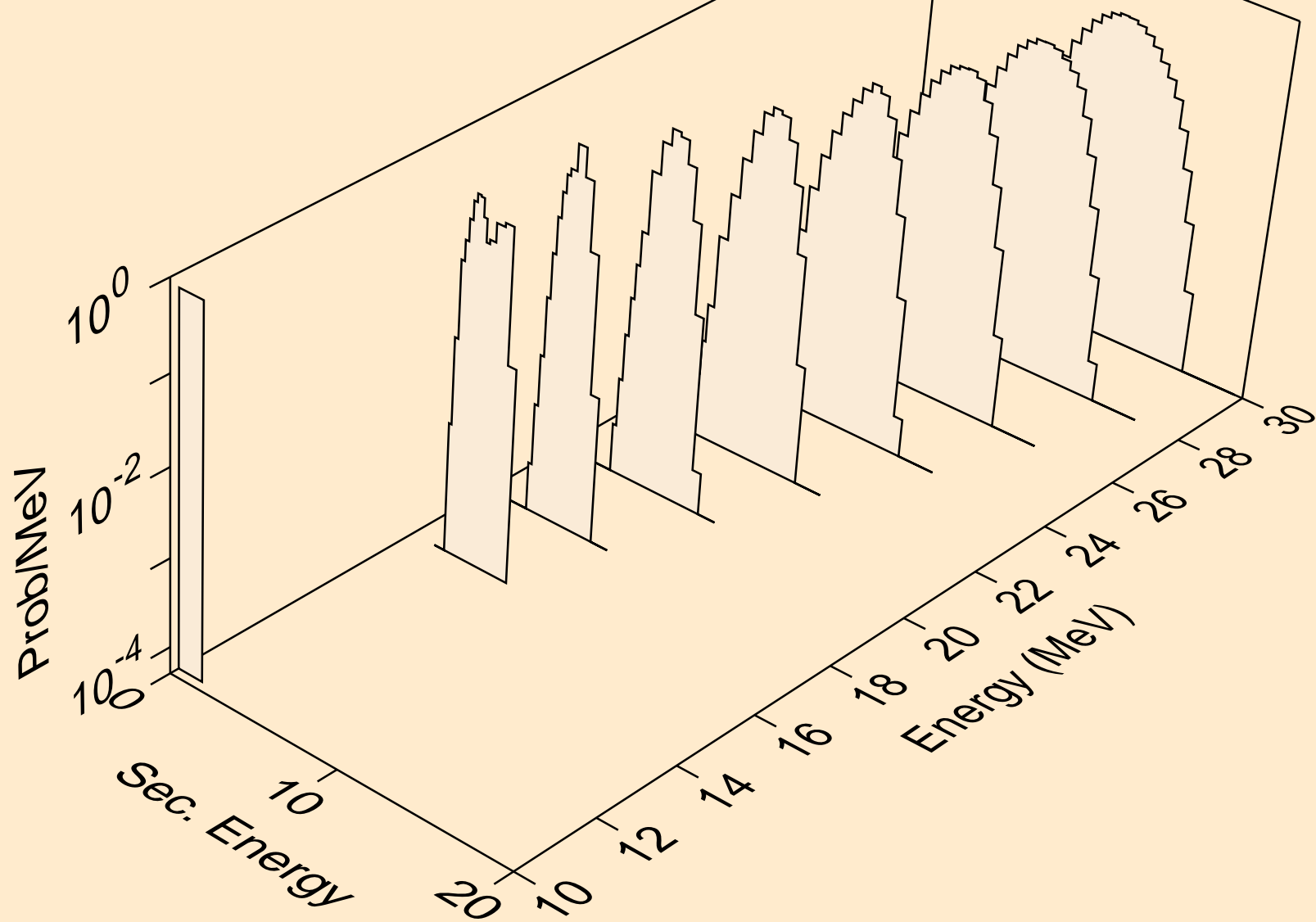

W173 PROTON ACER TENDL-2023 LIBRARY; T=0.K  
deuterons from (p,da)

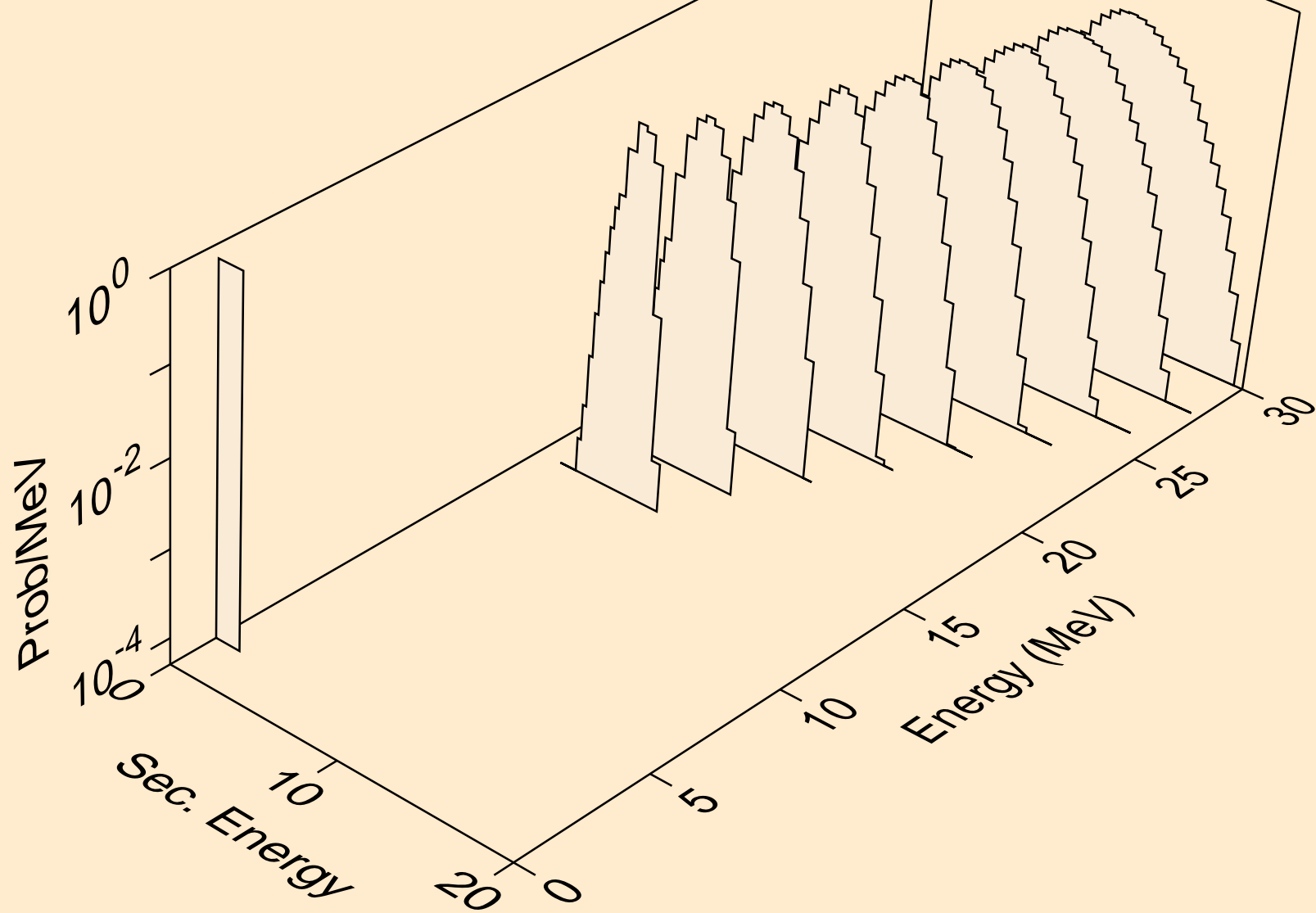

W173 PROTON ACER TENDL-2023 LIBRARY; T=0.K  
tritons from (p,x)

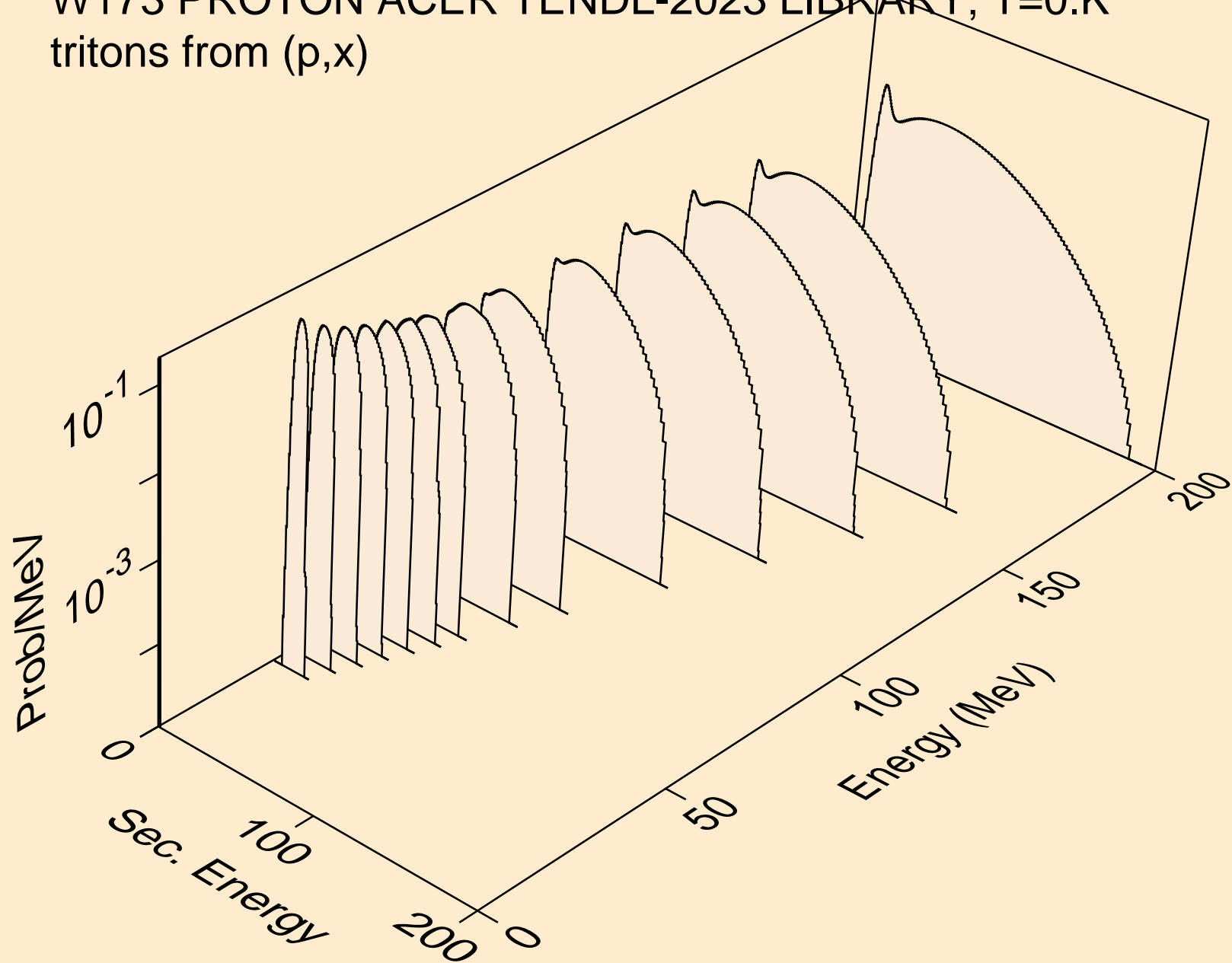

W173 PROTON ACER TENDL-2023 LIBRARY; T=0.K  
tritons from (p,n\*)t

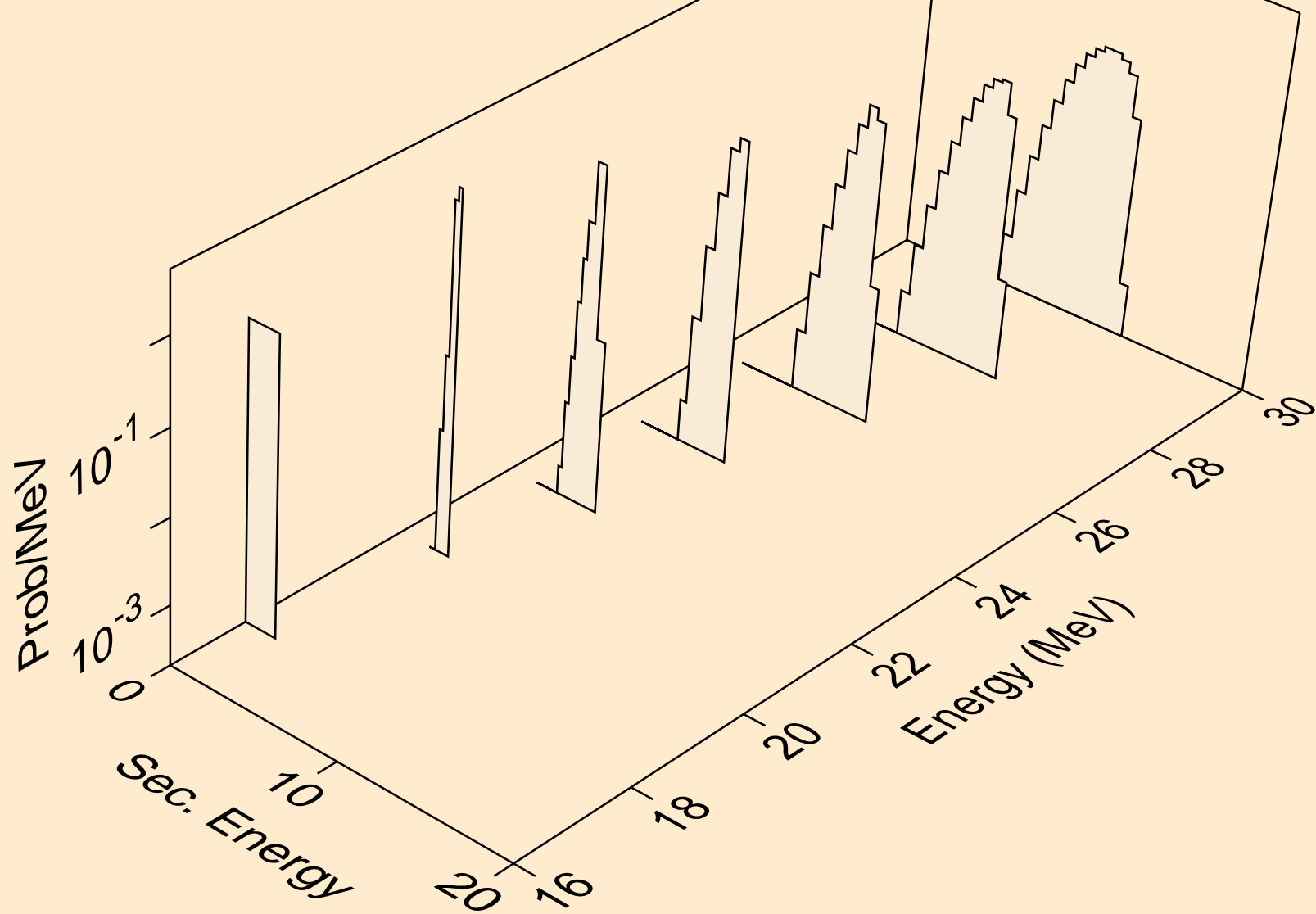

W173 PROTON ACER TENDL-2023 LIBRARY; T=0.K  
tritons from (p,t)

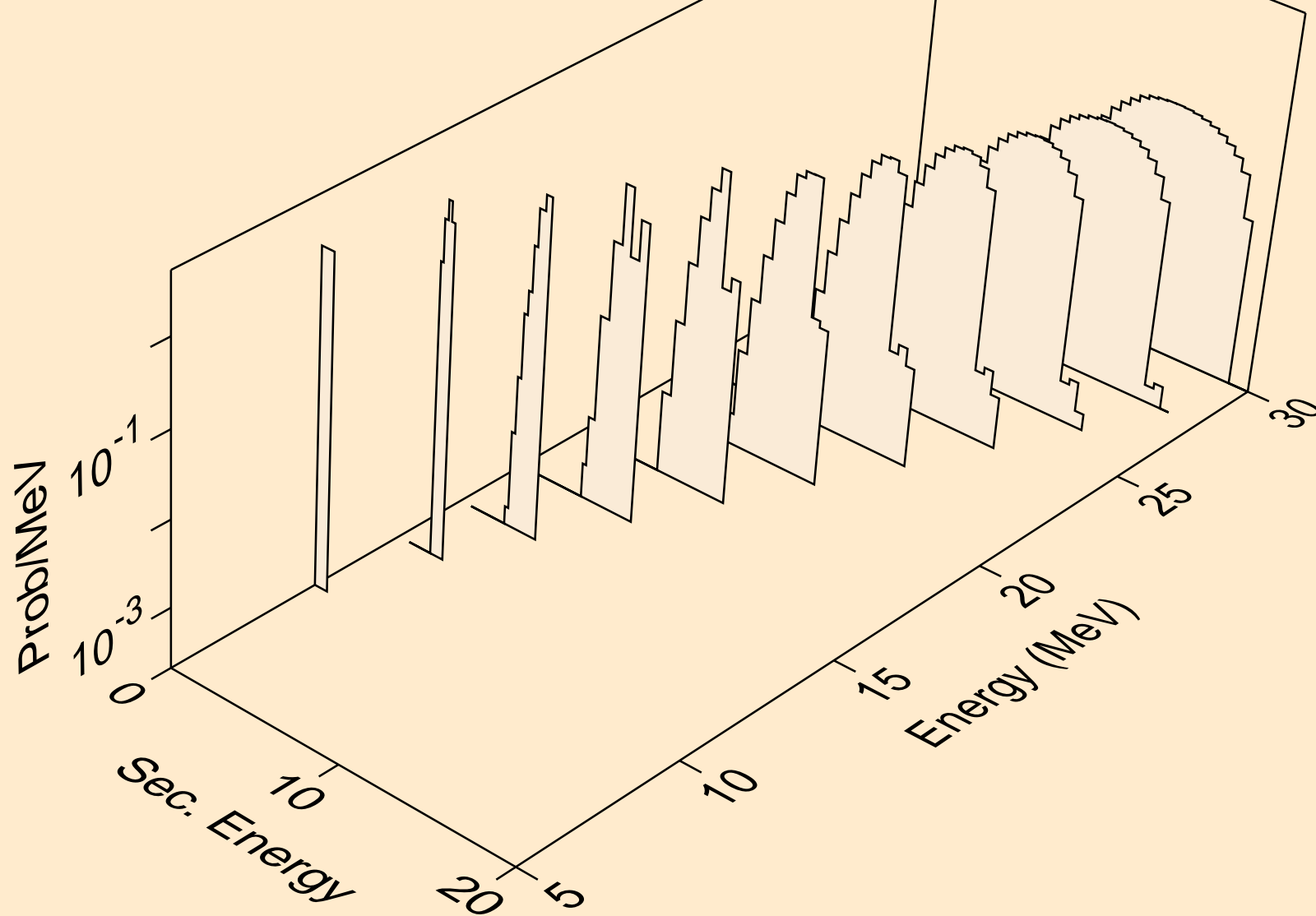

W173 PROTON ACER TENDL-2023 LIBRARY; T=0.K  
tritons from (p,pt)

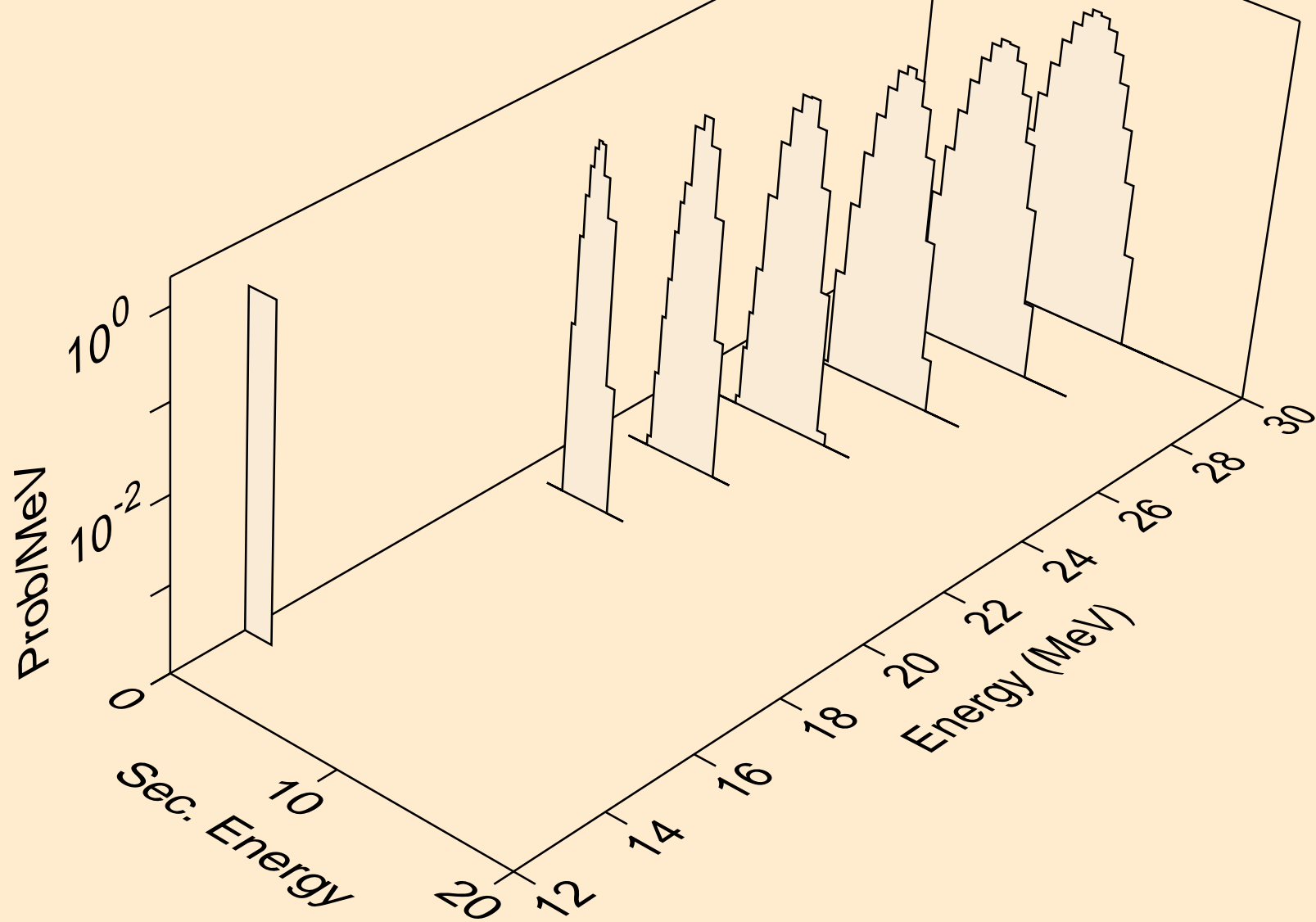

W173 PROTON ACER TENDL-2023 LIBRARY; T=0.K  
he3s from (p,x)

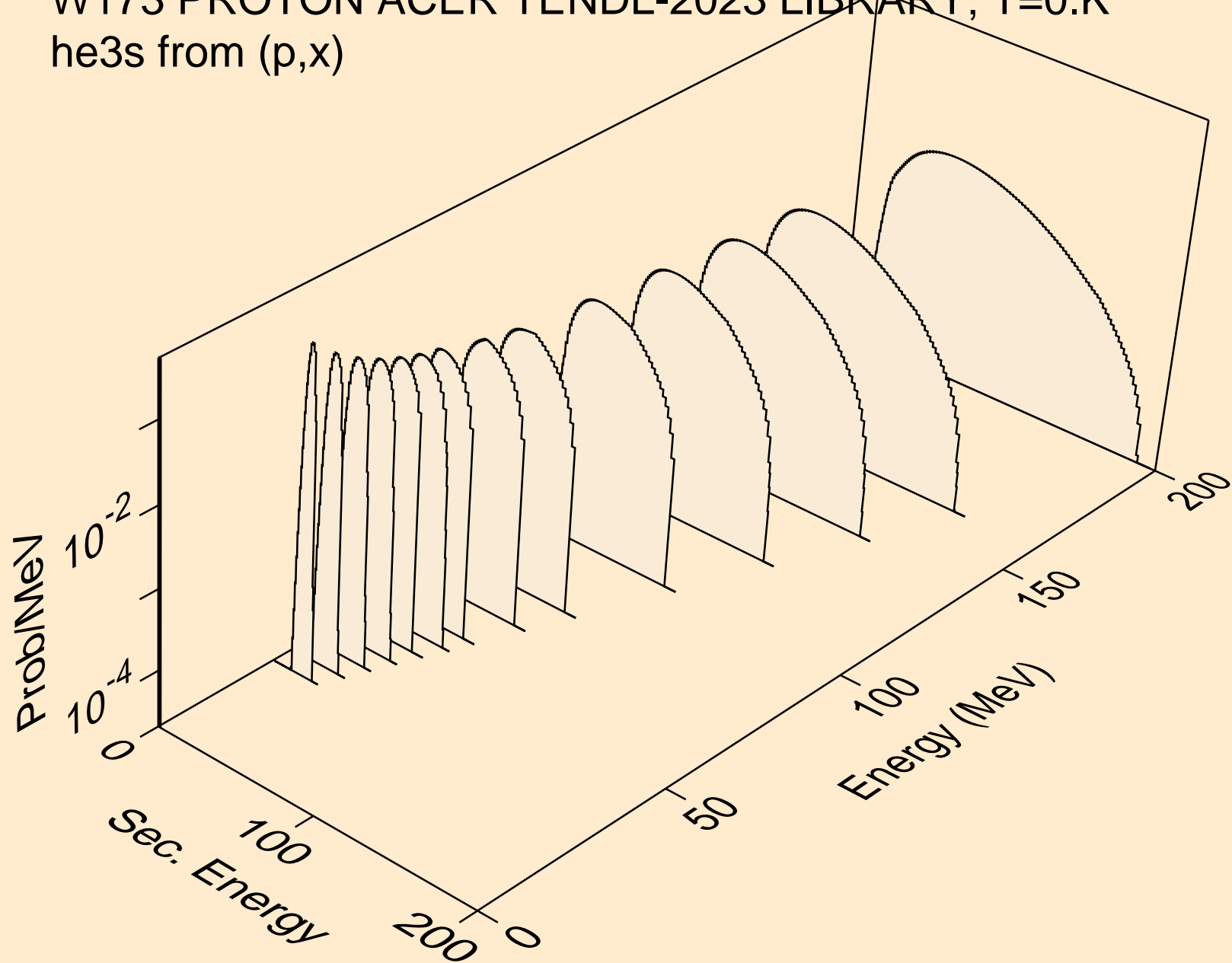



W173 PROTON ACER TENDL-2023 LIBRARY; T=0.K  
he3s from (p,n\*)he3

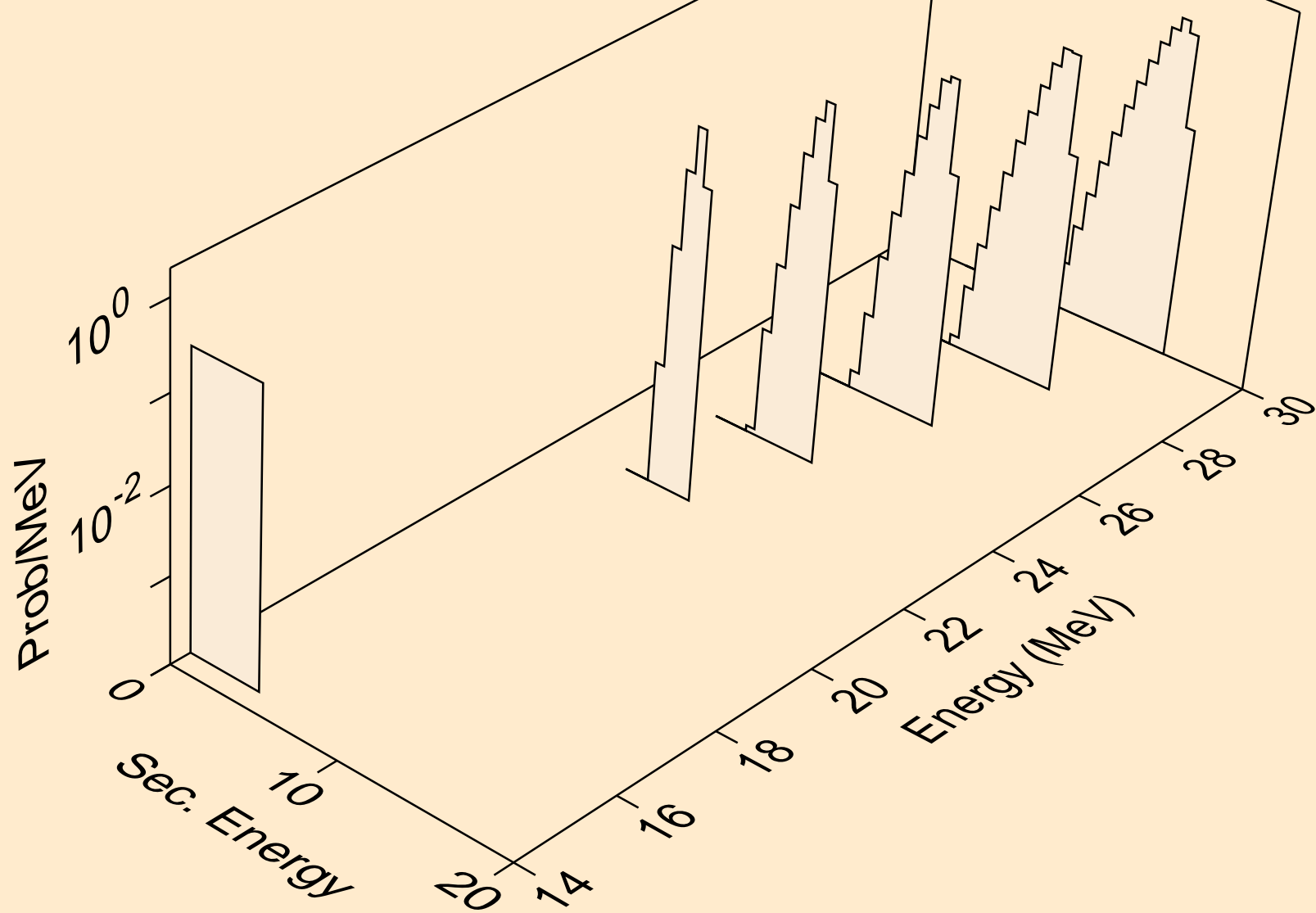

W173 PROTON ACER TENDL-2023 LIBRARY; T=0.K  
he3s from (p,he3)

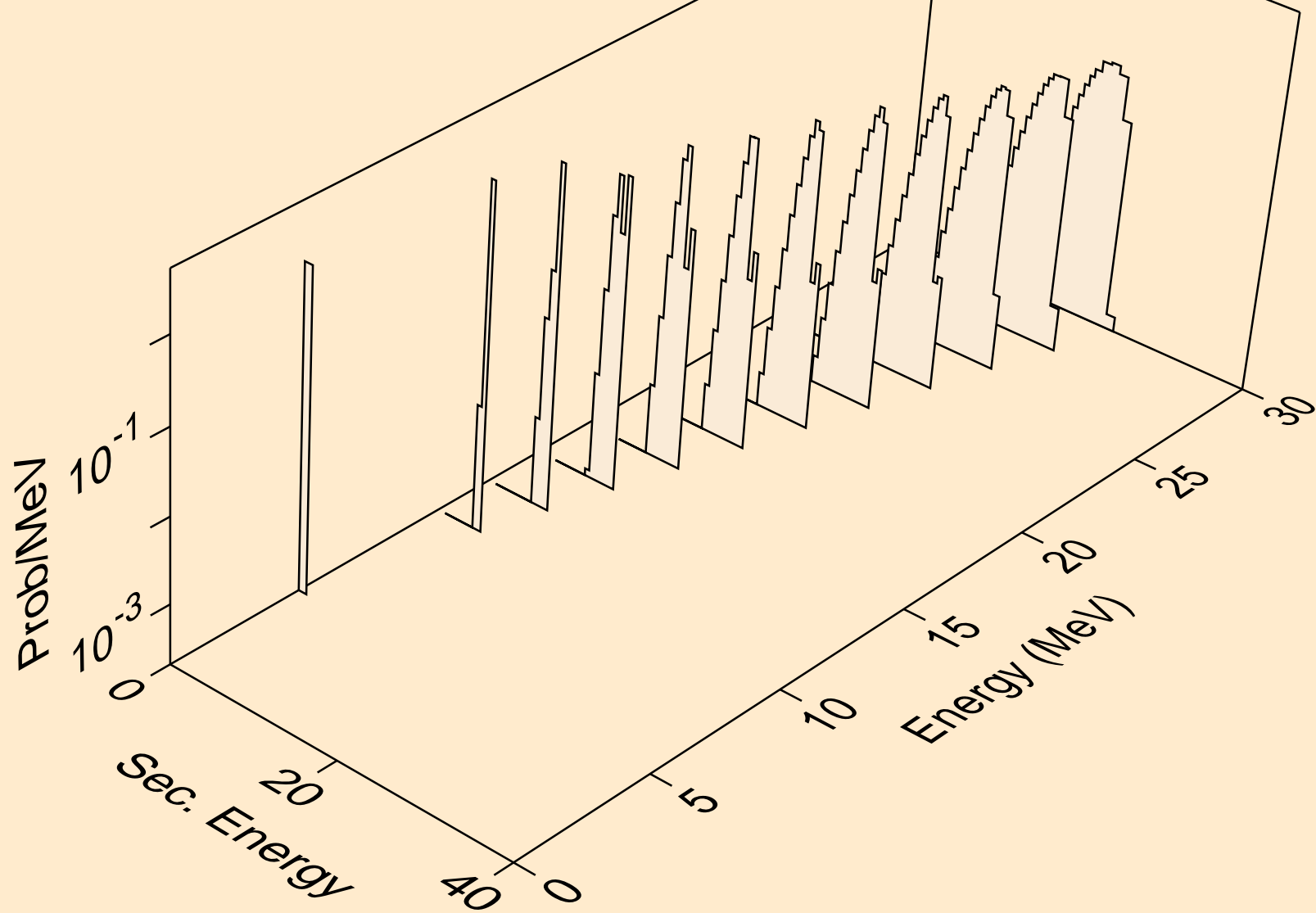

W173 PROTON ACER TENDL-2023 LIBRARY; T=0.K  
alphas from (p,x)

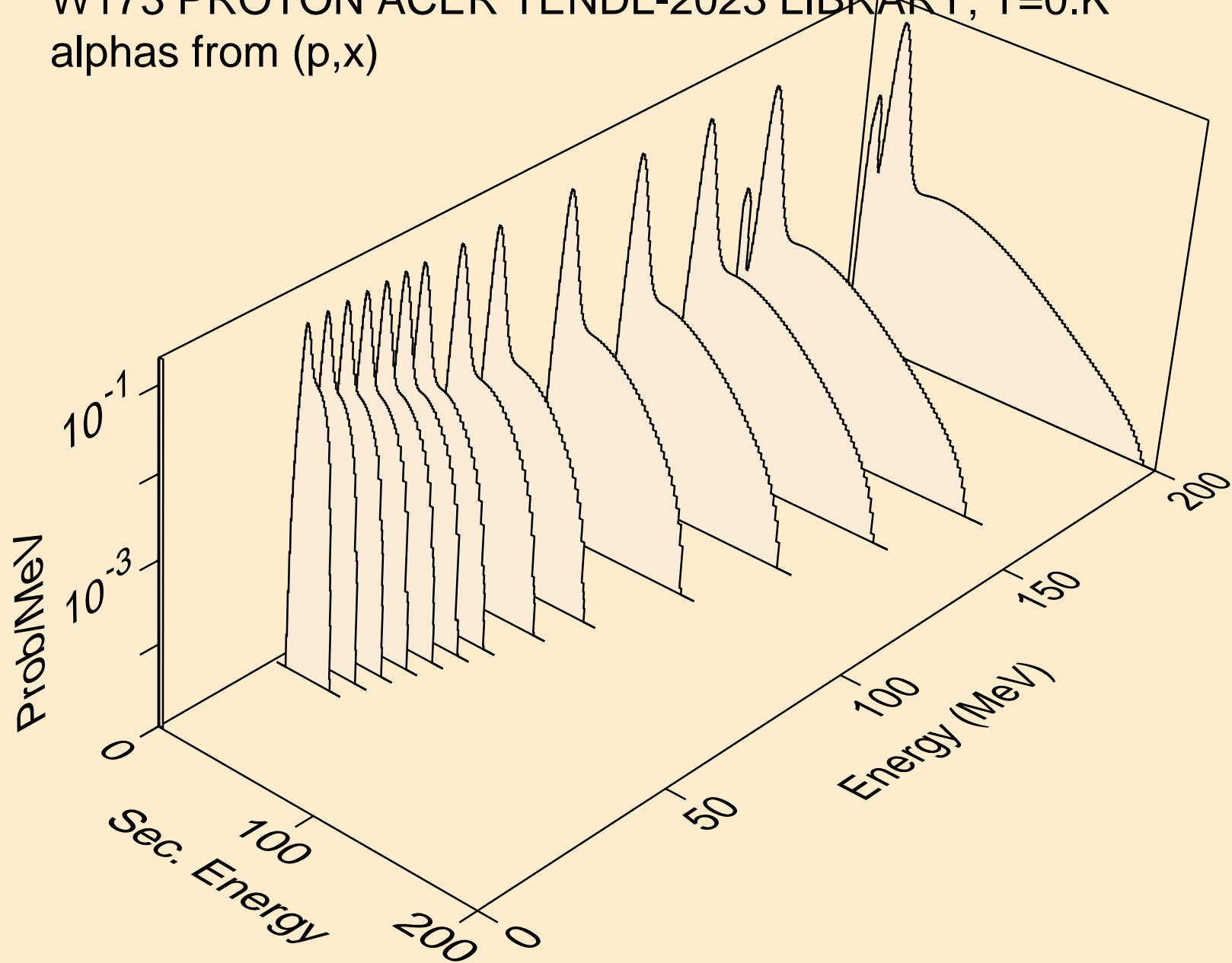

W173 PROTON ACER TENDL-2023 LIBRARY; T=0.K  
alphas from (p,n\*)a

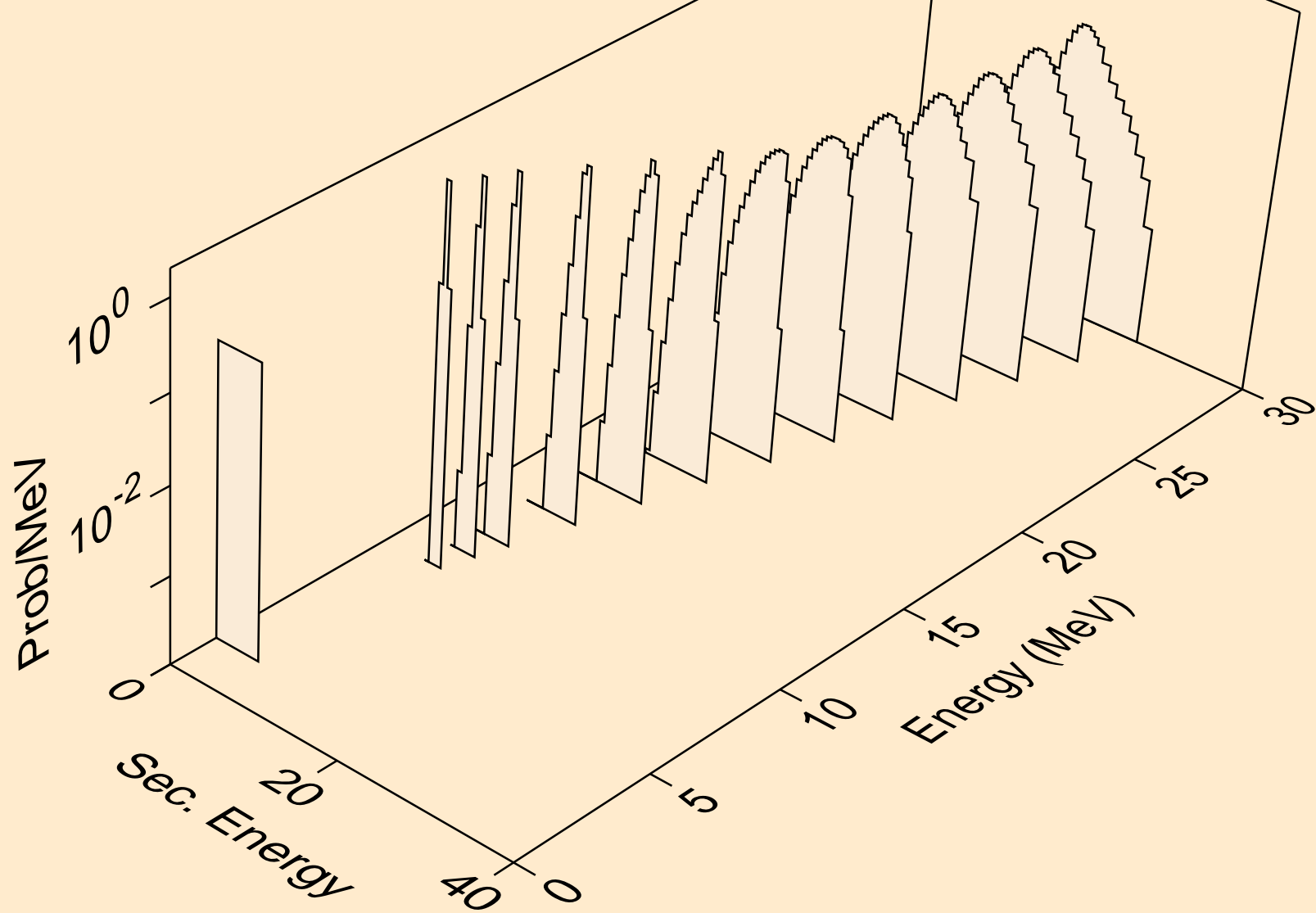

W173 PROTON ACER TENDL-2023 LIBRARY; T=0.K  
alphas from (p,2n)a

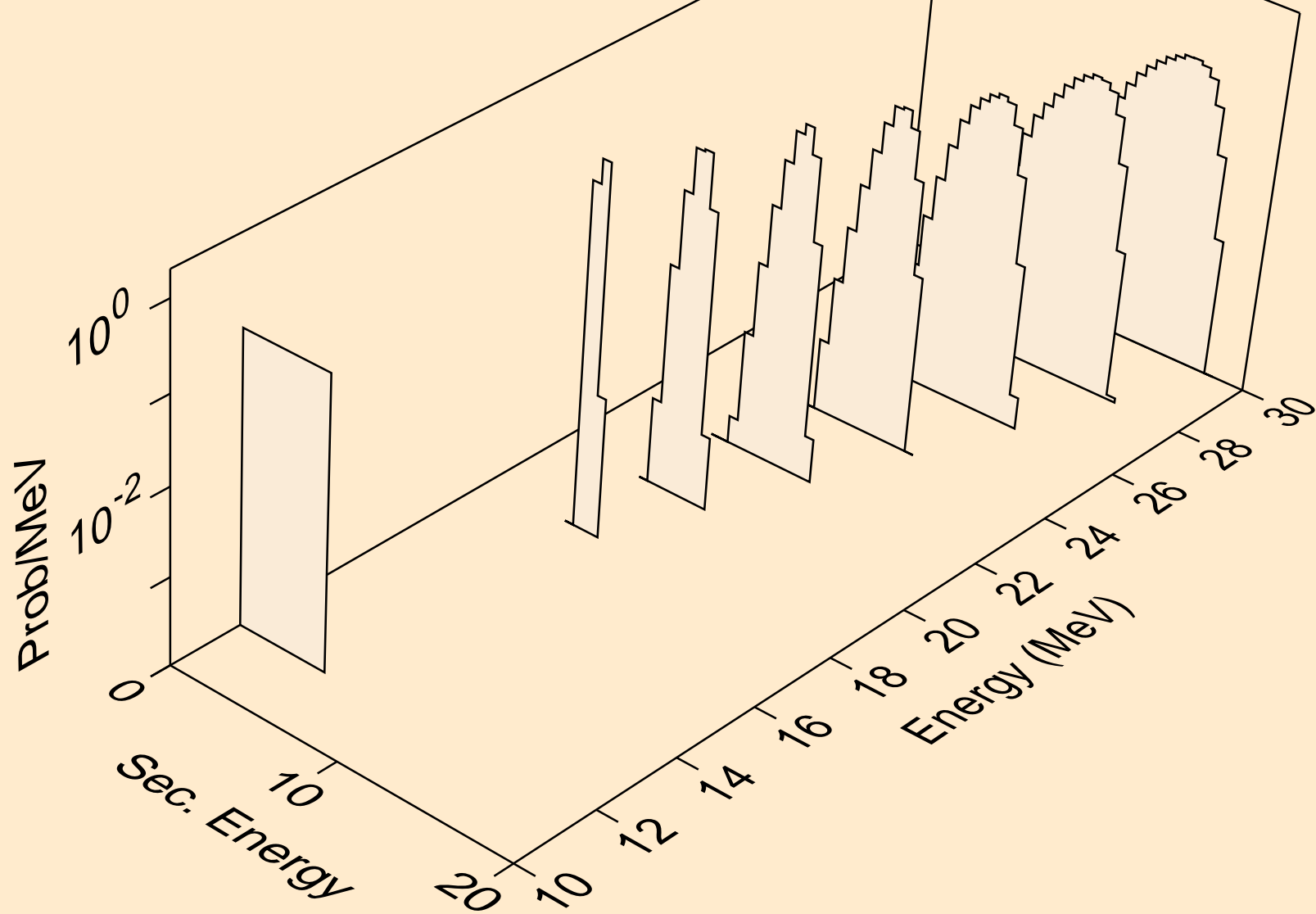

W173 PROTON ACER TENDL-2023 LIBRARY; T=0.K  
alphas from (p,3n)a

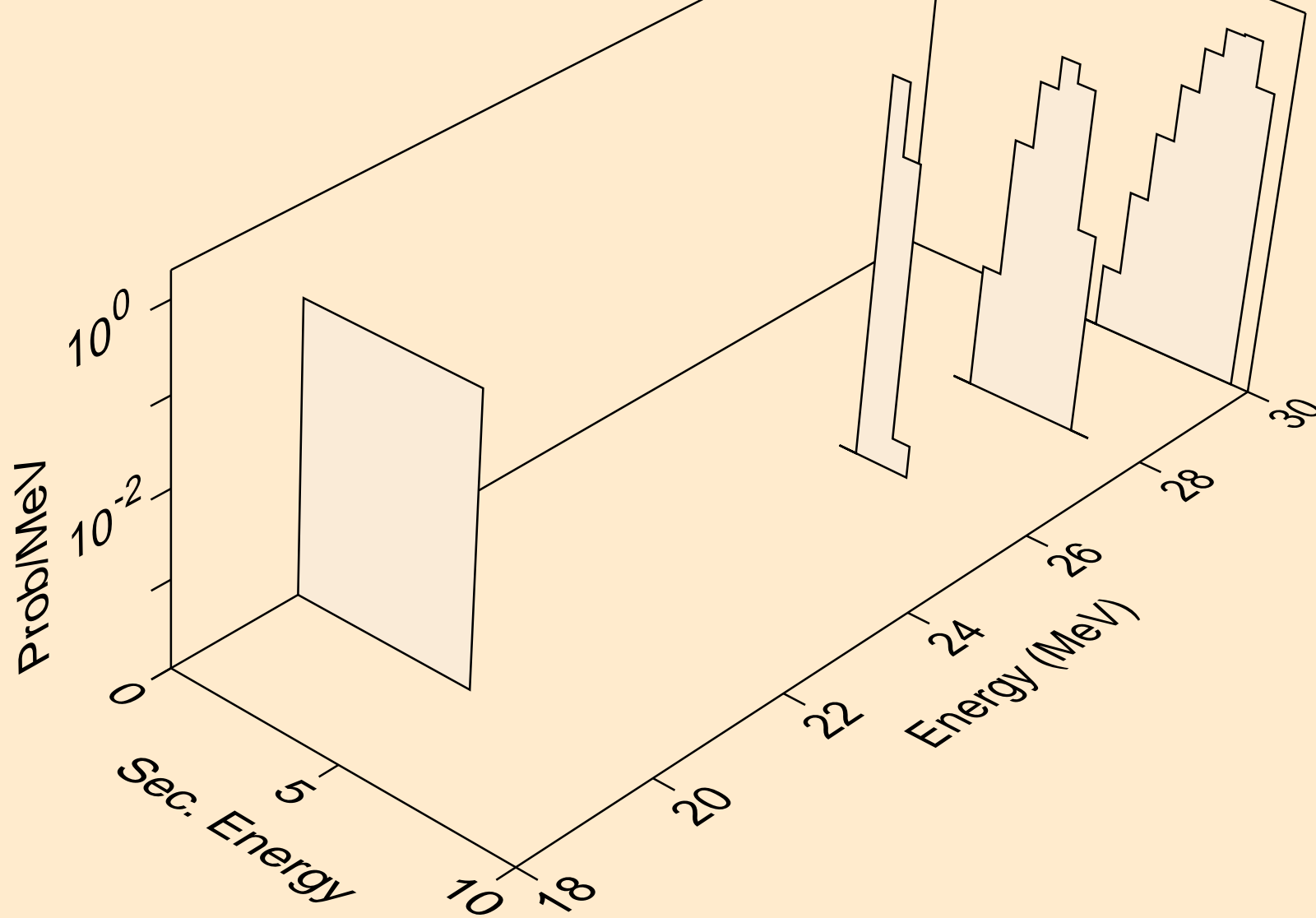

W173 PROTON ACER TENDL-2023 LIBRARY; T=0.K  
alphas from (p,n\*)2a

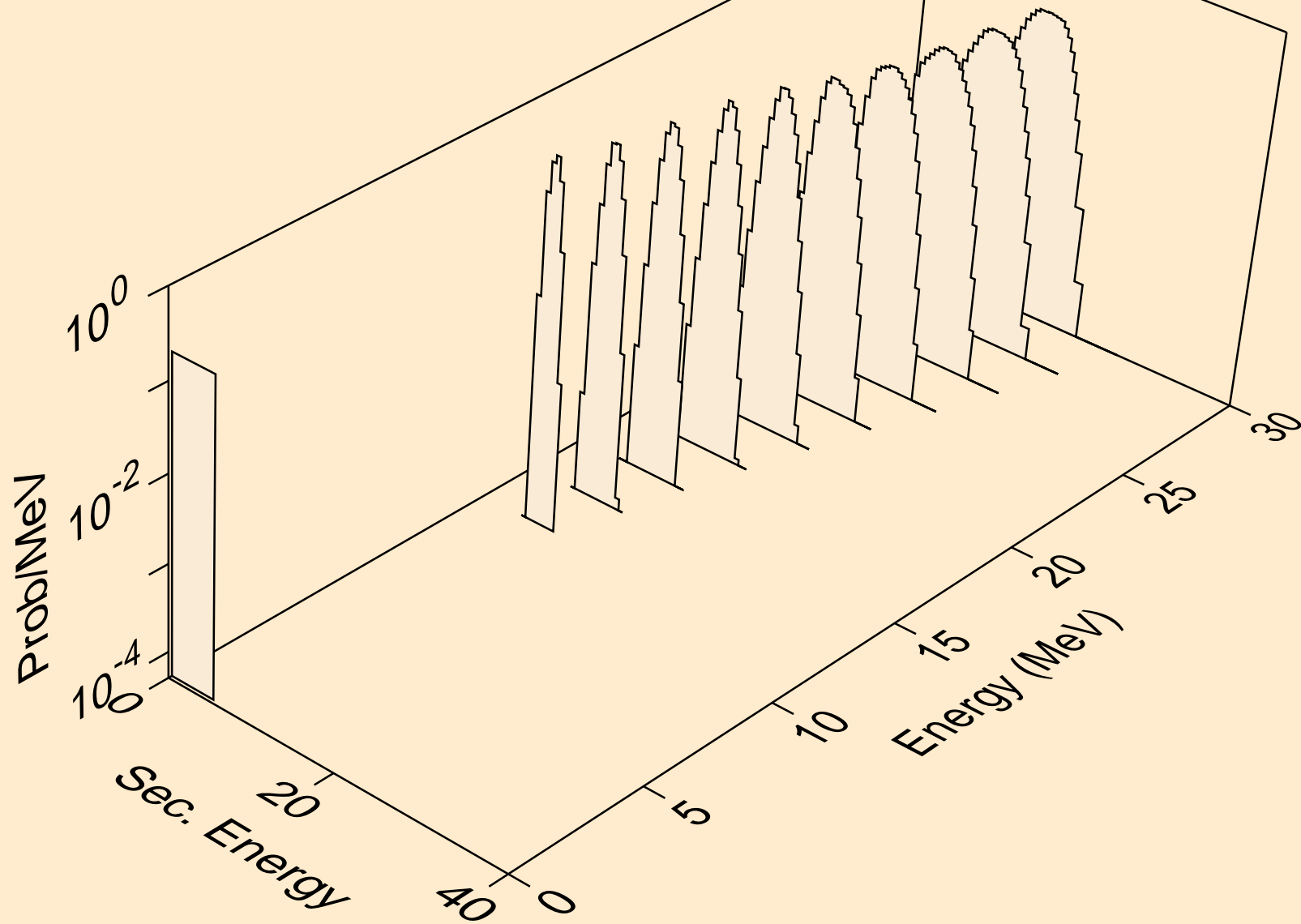

W173 PROTON ACER TENDL-2023 LIBRARY; T=0.K  
alphas from (p,npa)

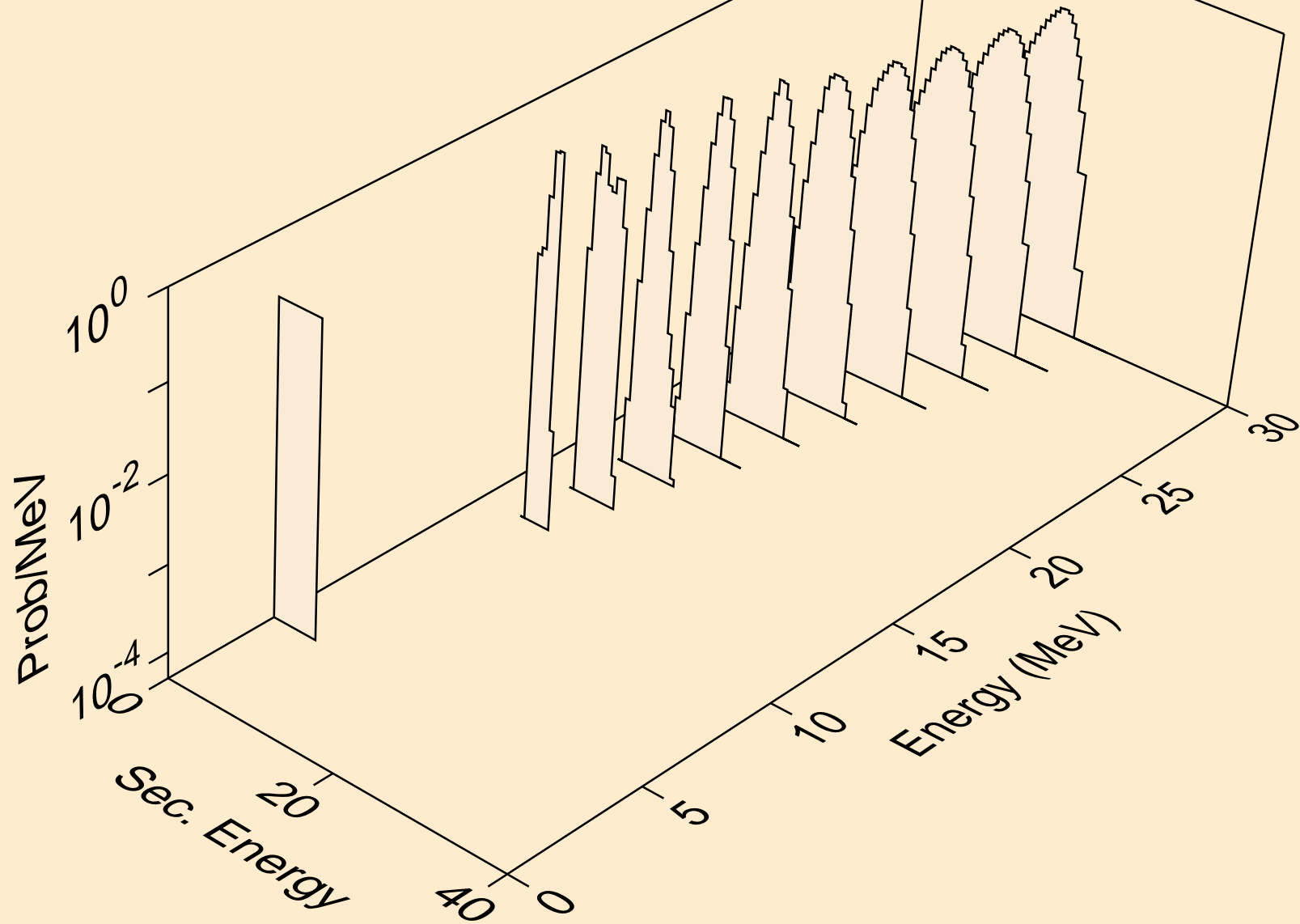



W173 PROTON ACER TENDL-2023 LIBRARY; T=0.K  
alphas from (p,a)

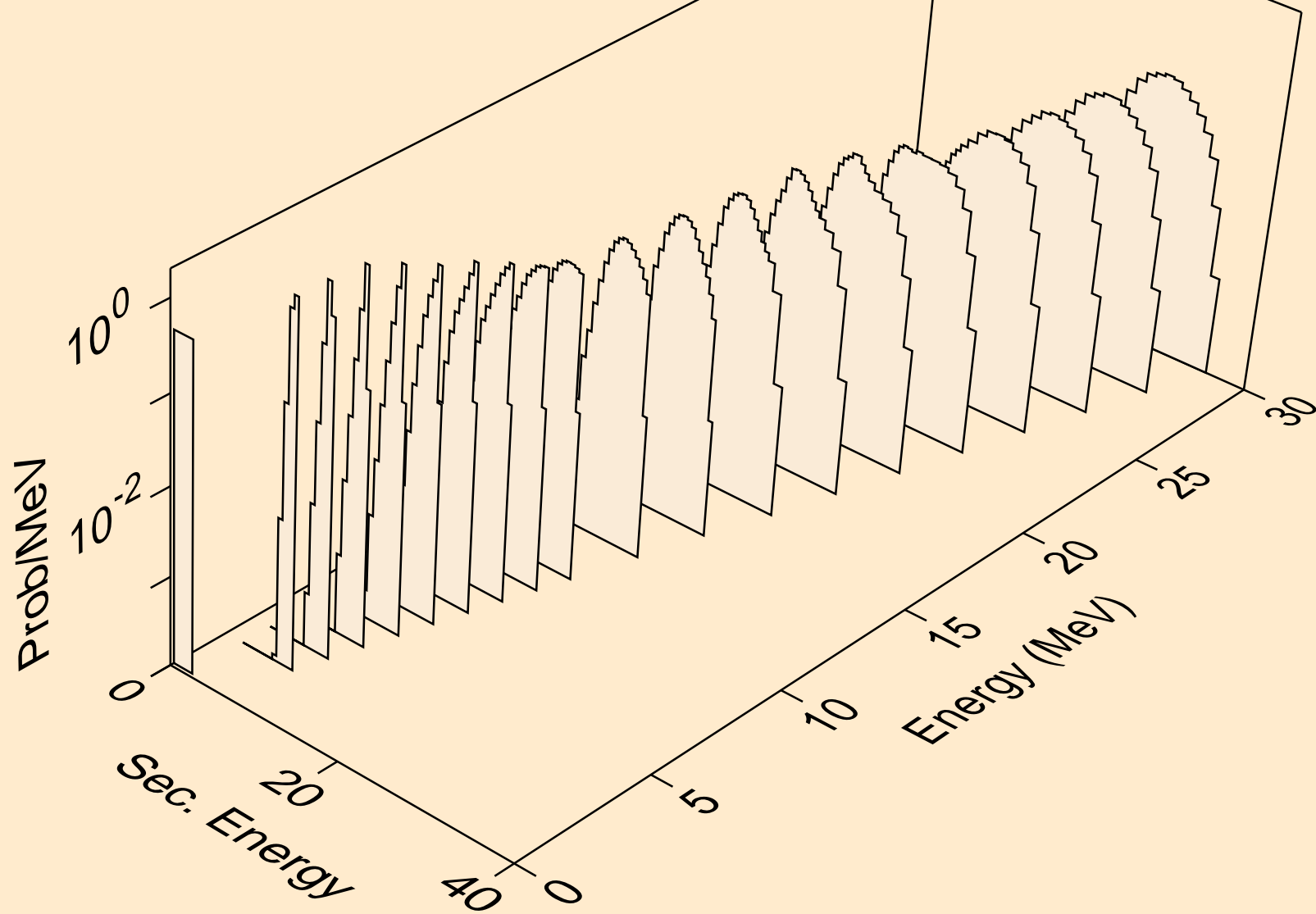

W173 PROTON ACER TENDL-2023 LIBRARY; T=0.K  
alphas from (p,2a)

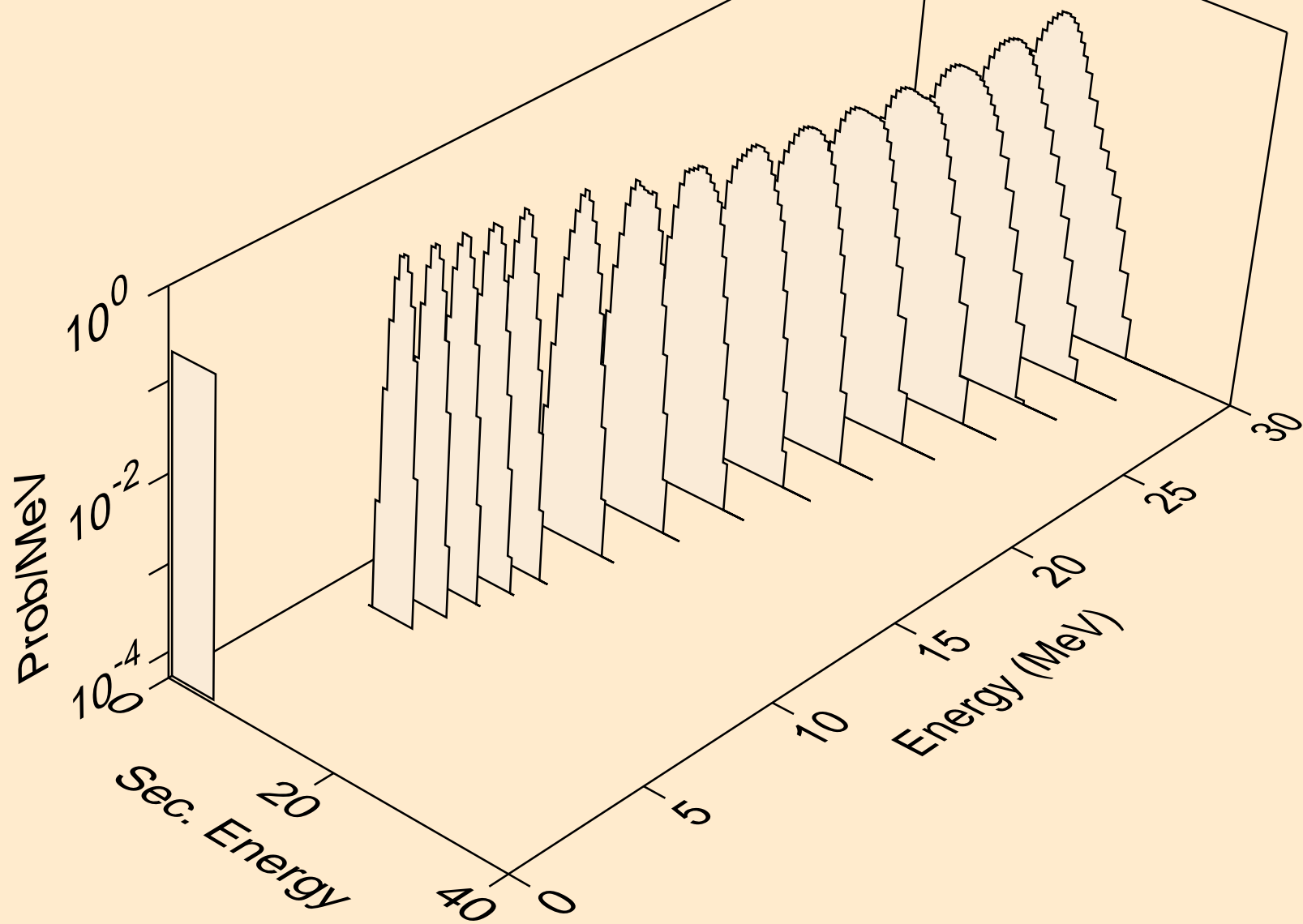

W173 PROTON ACER TENDL-2023 LIBRARY; T=0.K  
alphas from (p,pa)

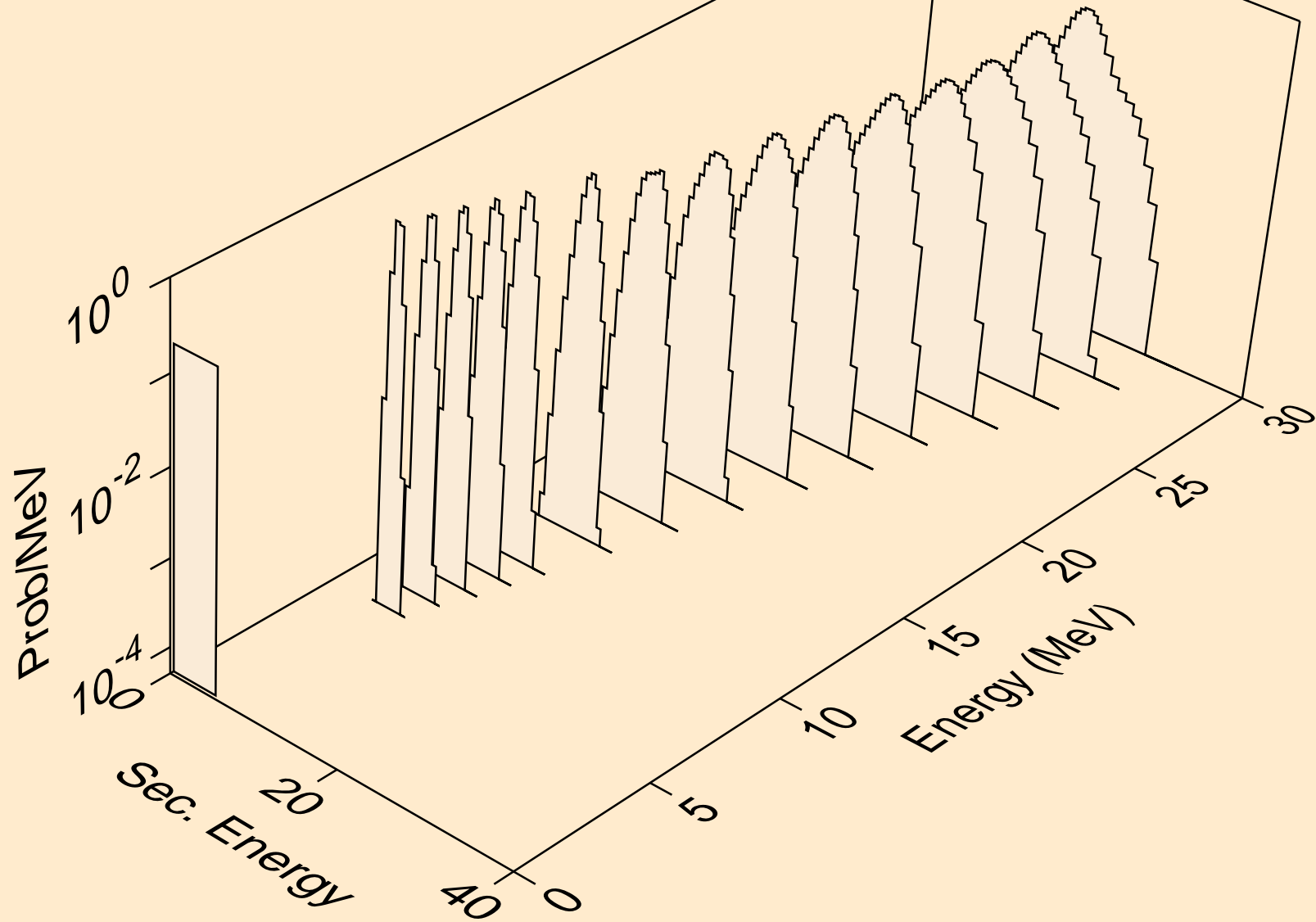

W173 PROTON ACER TENDL-2023 LIBRARY; T=0.K  
alphas from (p,da)

