

XE124 PROTON ACER TENDL-2023 LIBRARY; T=0.K

Principal cross sections

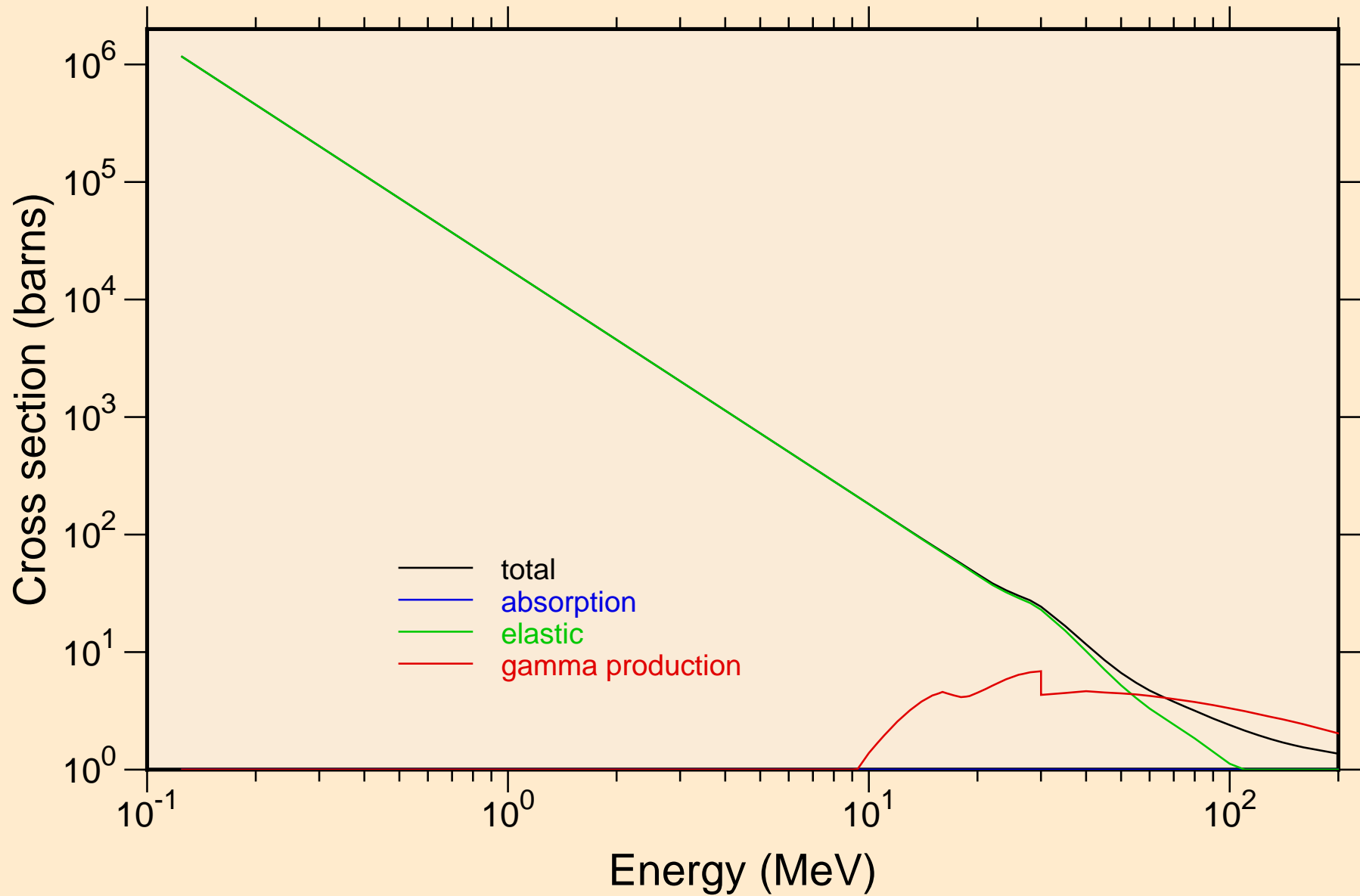

XE124 PROTON ACER TENDL-2023 LIBRARY; T=0.K
Heating

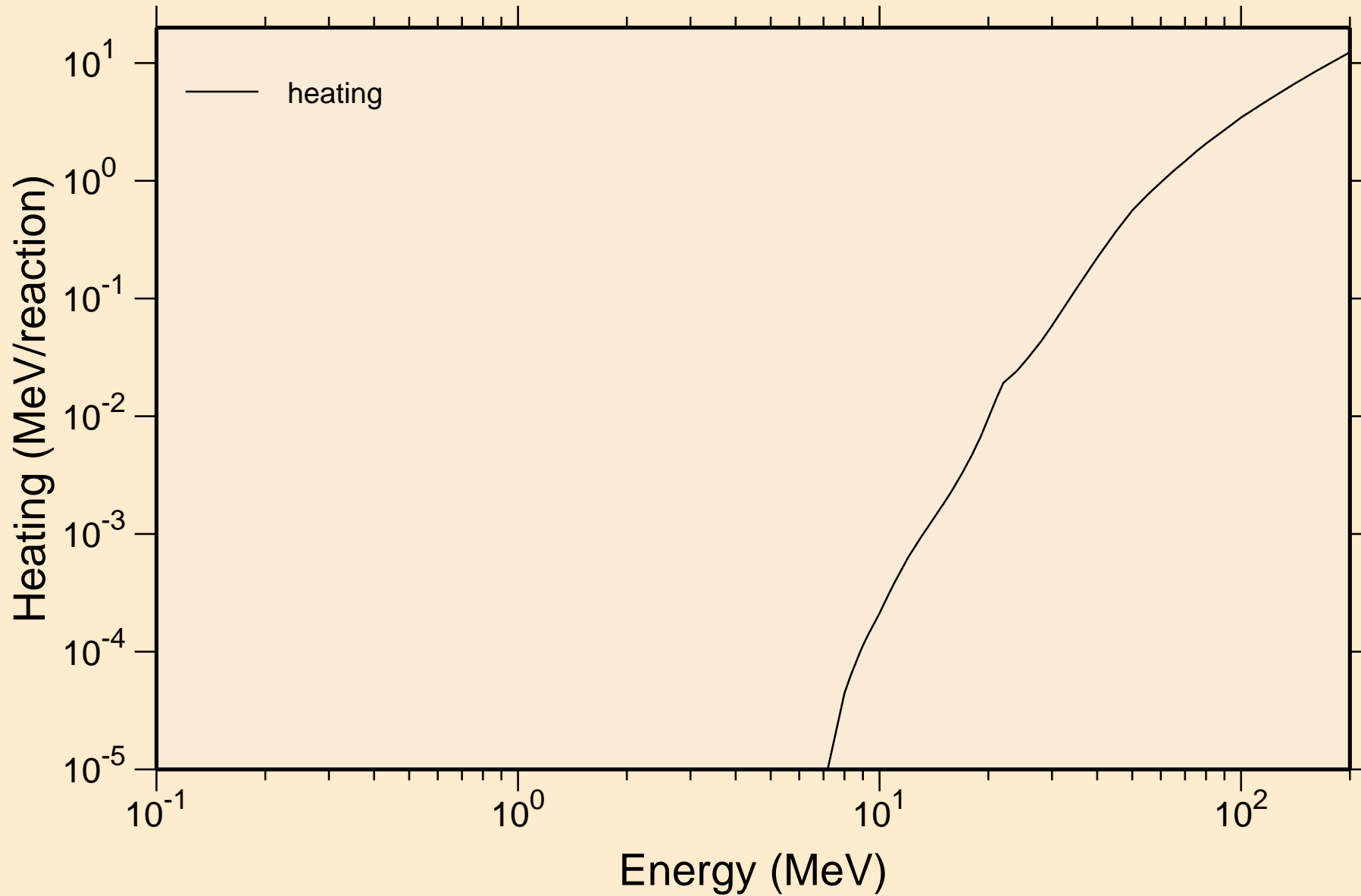

XE124 PROTON ACER TENDL-2023 LIBRARY; T=0.K

Principal cross sections

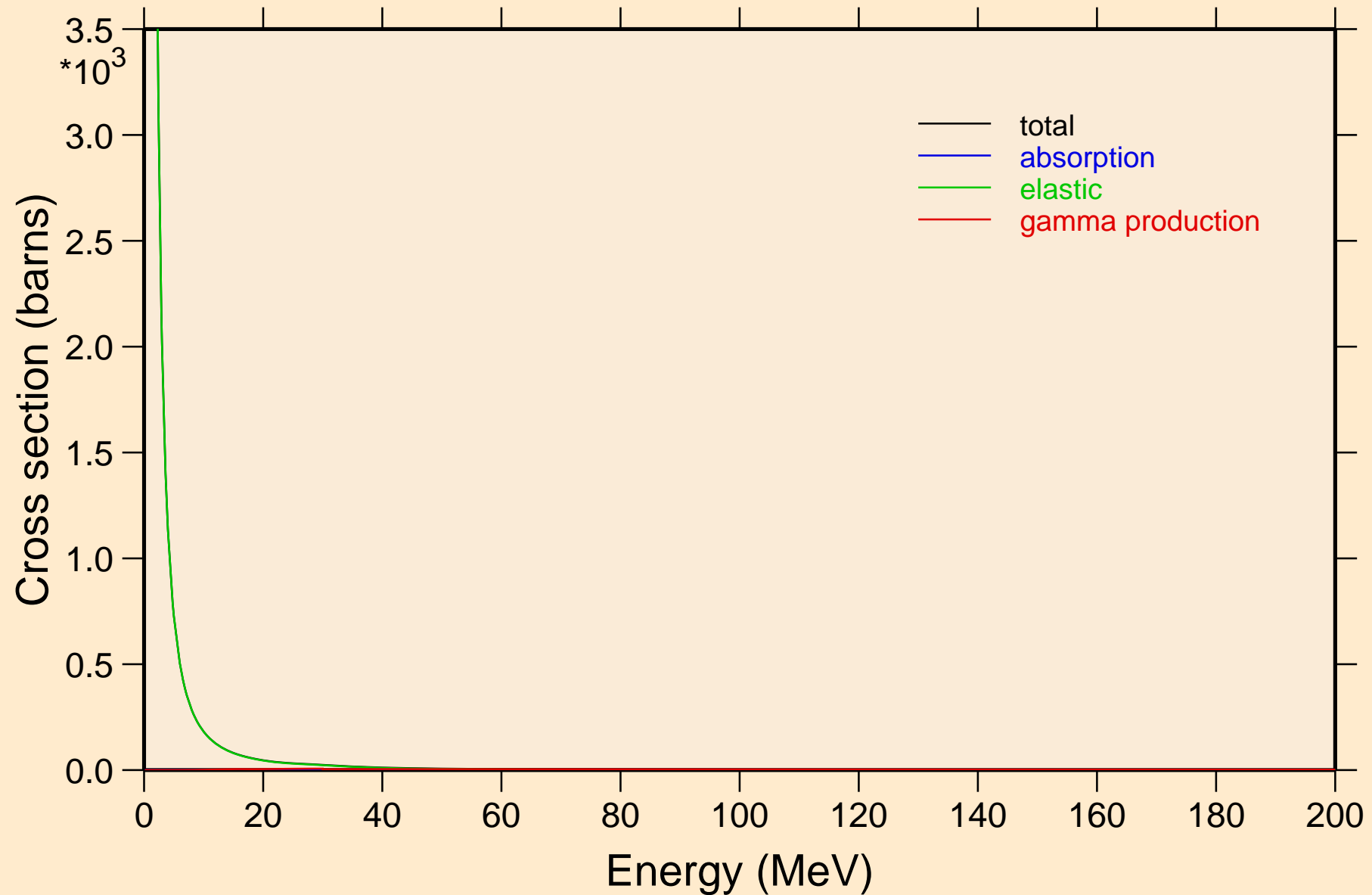

XE124 PROTON ACER TENDL-2023 LIBRARY; T=0.K

Heating

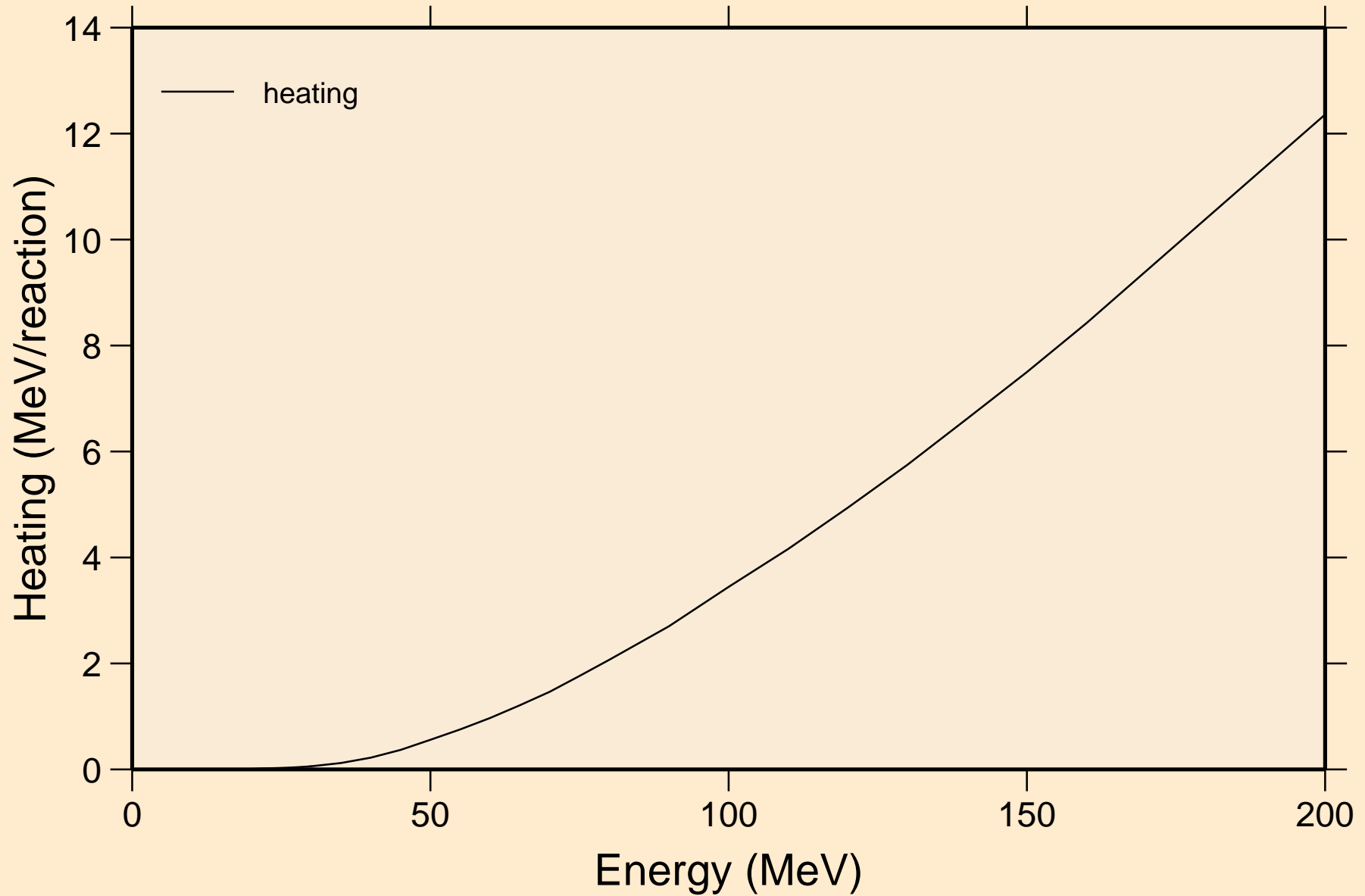

XE124 PROTON ACER TENDL-2023 LIBRARY; T=0.K

Threshold reactions

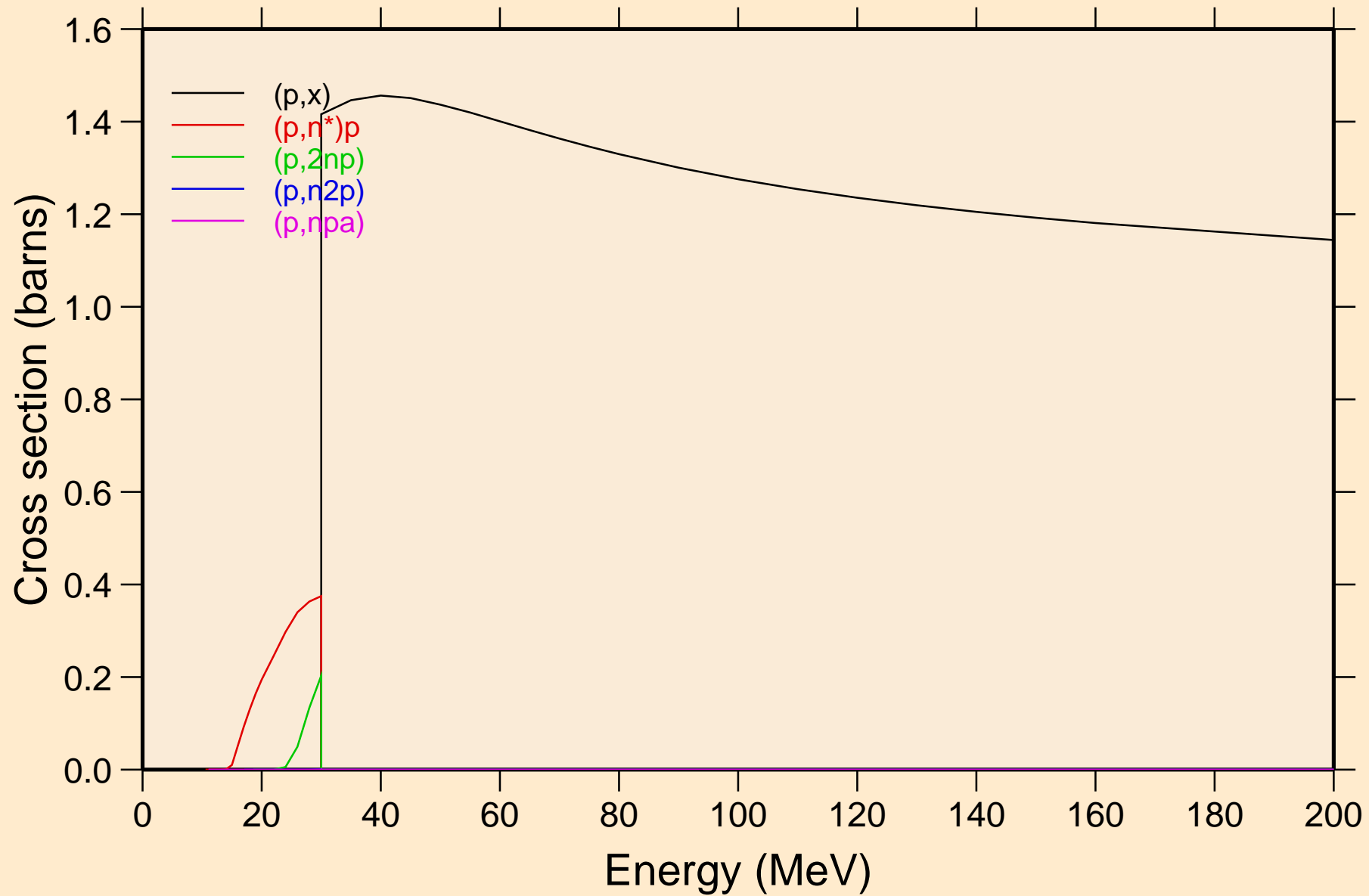

XE124 PROTON ACER TENDL-2023 LIBRARY; T=0.K

Threshold reactions

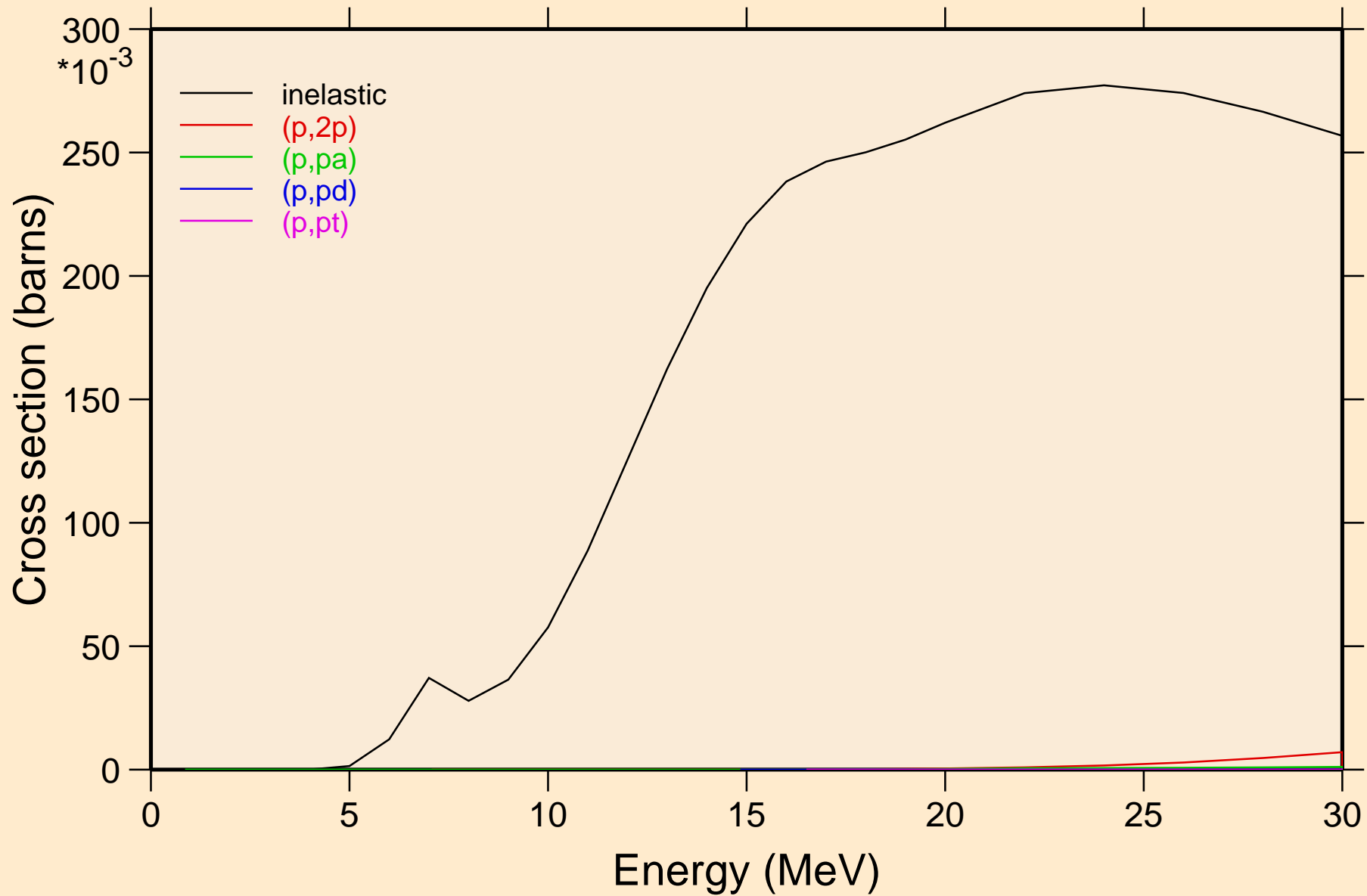

XE124 PROTON ACER TENDL-2023 LIBRARY; T=0.K
Threshold reactions

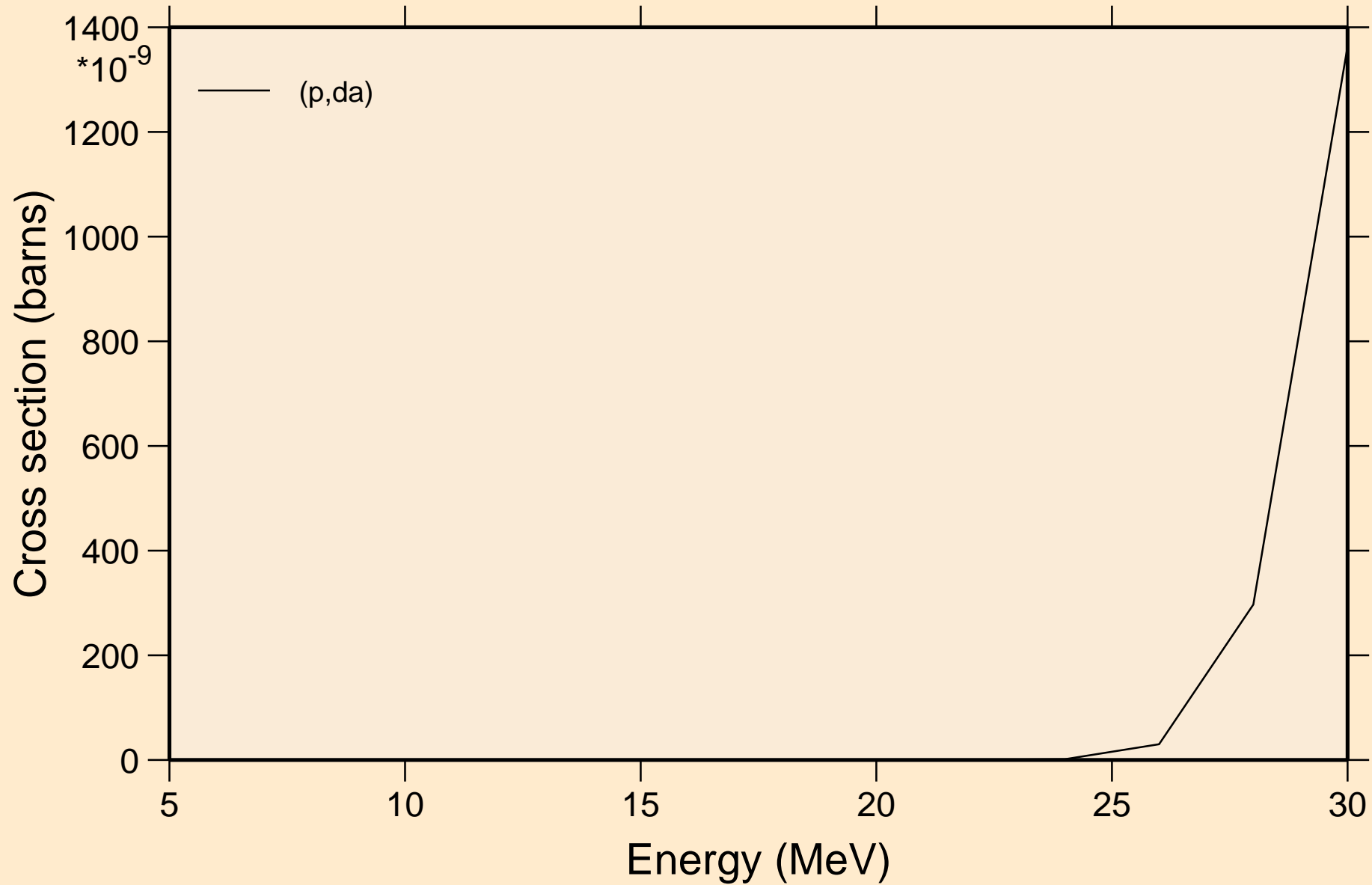

XE124 PROTON ACER TENDL-2023 LIBRARY; T=0.K
angular distribution for elastic

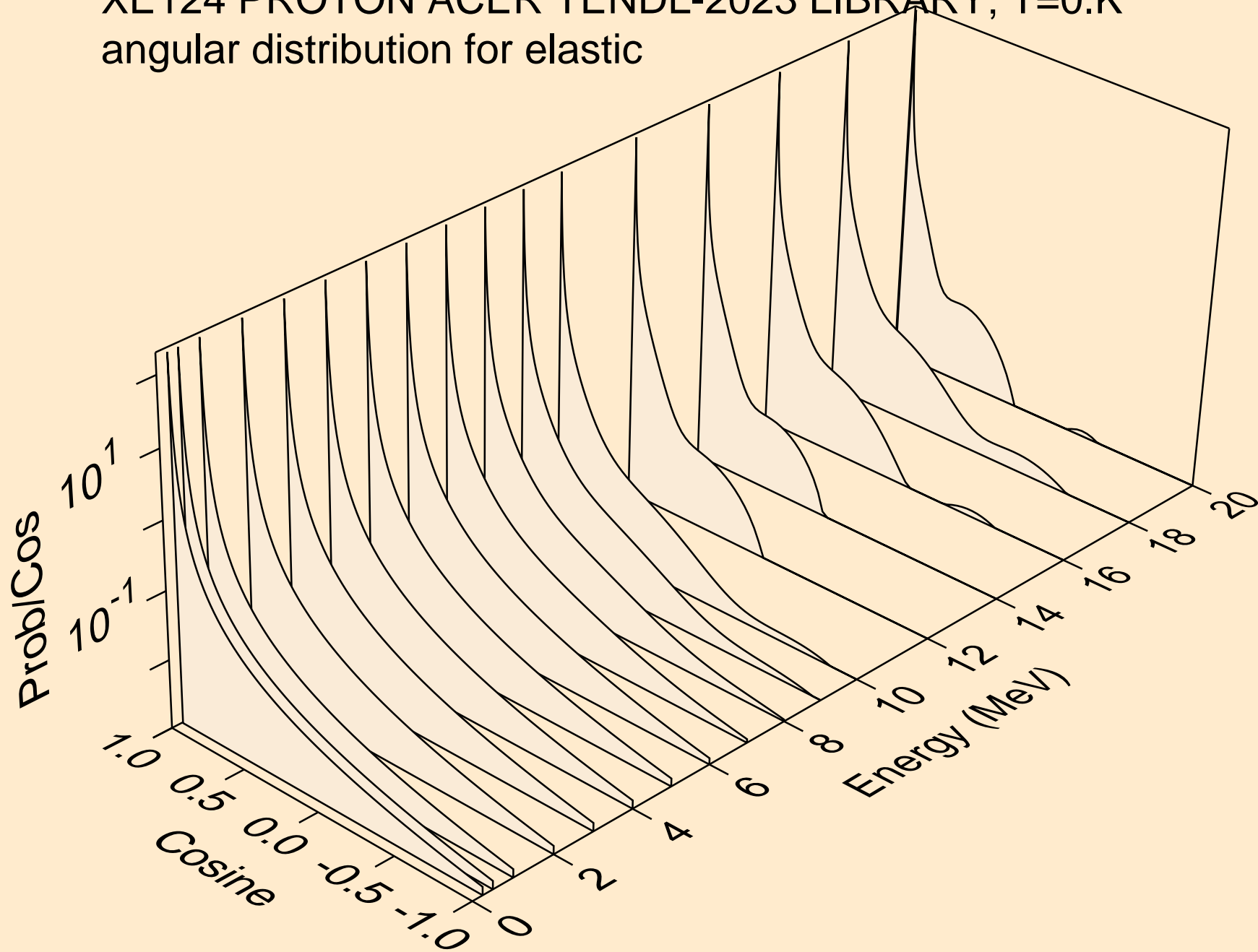

XE124 PROTON ACER TENDL-2023 LIBRARY; T=0.K
angular distribution for elastic

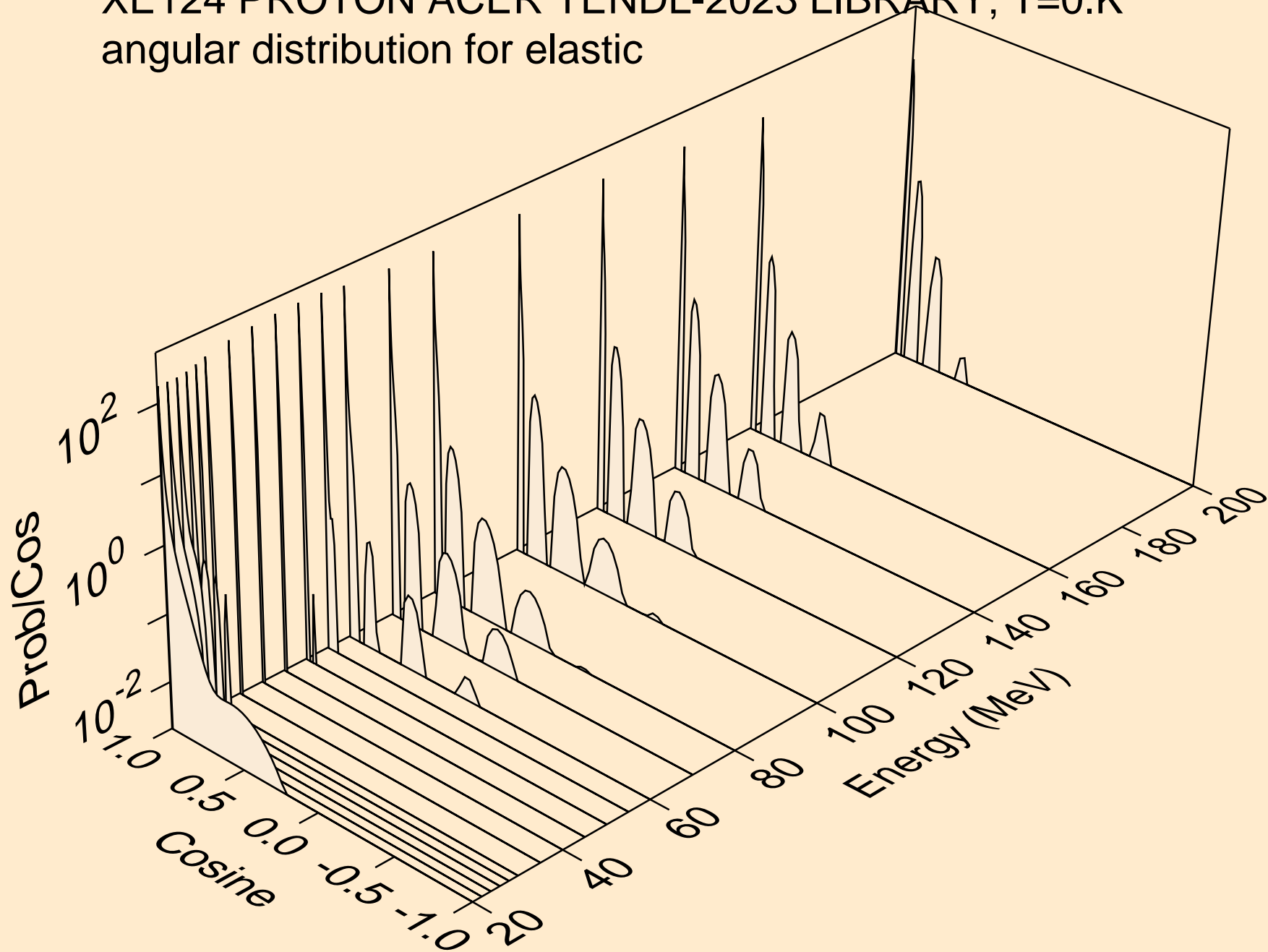

XE124 PROTON ACER TENDL-2023 LIBRARY; T=0.K
Proton emission for (p,x)

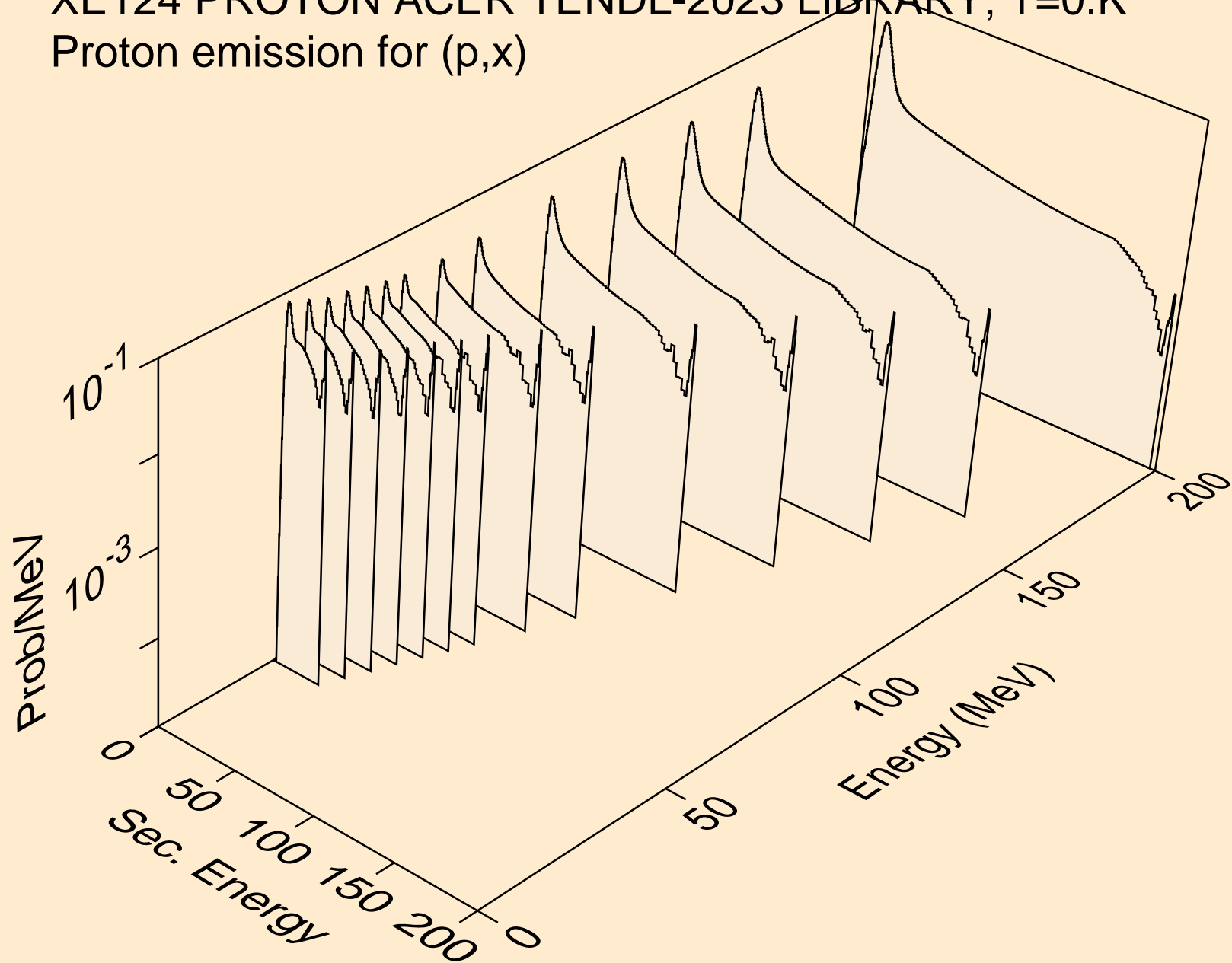

XE124 PROTON ACER TENDL-2023 LIBRARY; T=0.K
Proton emission for (p,n*)p

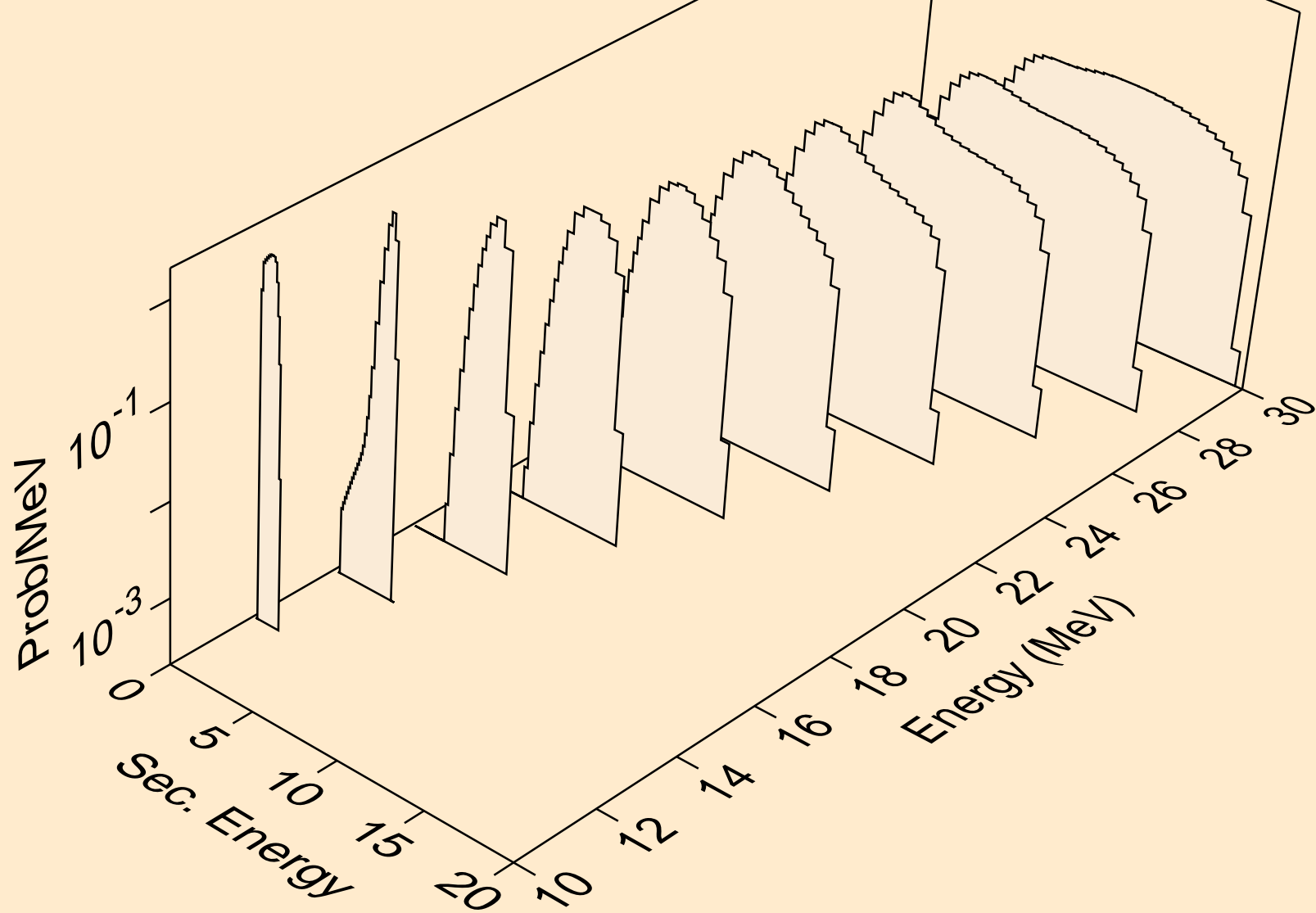

XE124 PROTON ACER TENDL-2023 LIBRARY; T=0.K
Proton emission for (p,2np)

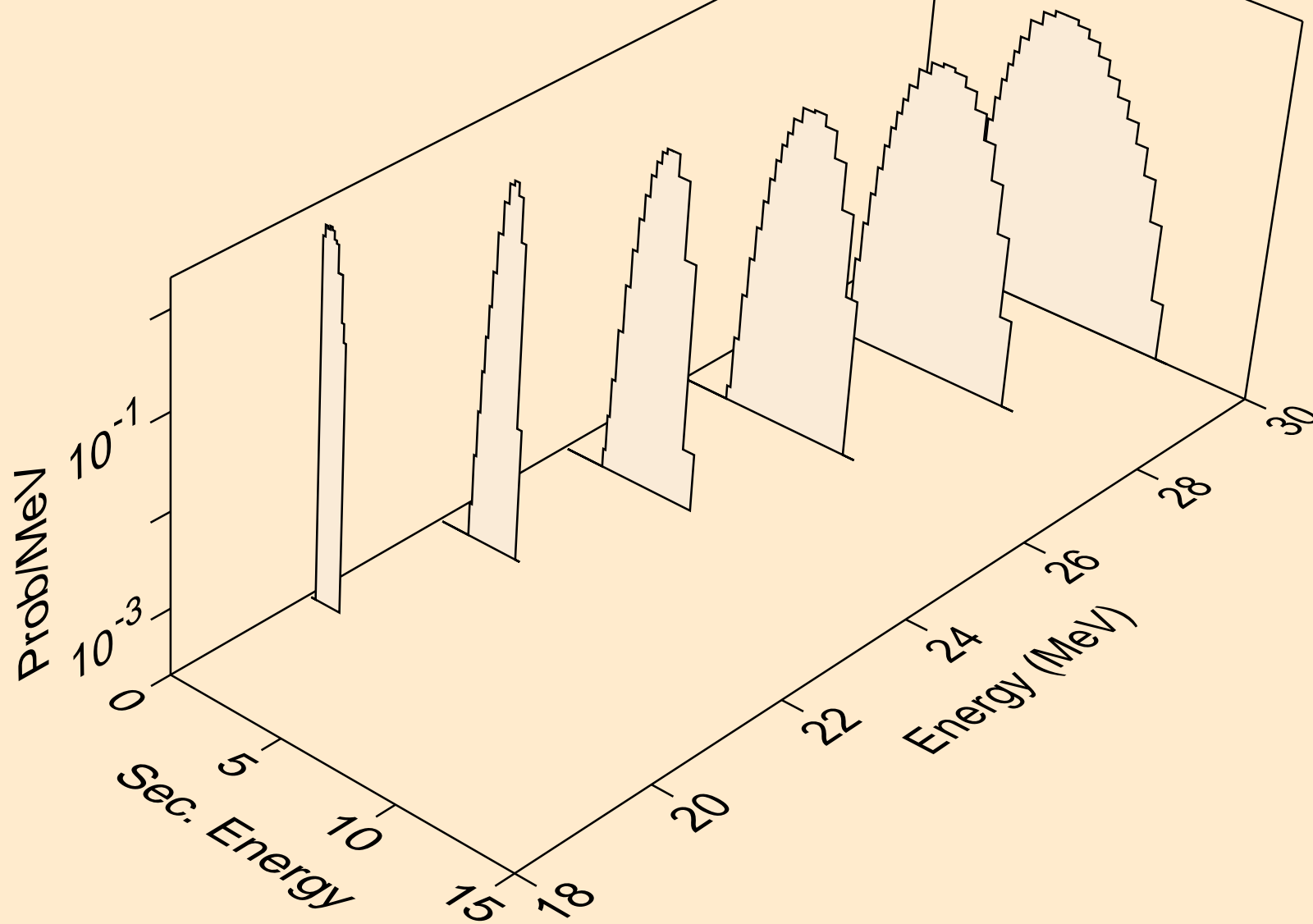

XE124 PROTON ACER TENDL-2023 LIBRARY; T=0.K
Proton emission for (p,n2p)

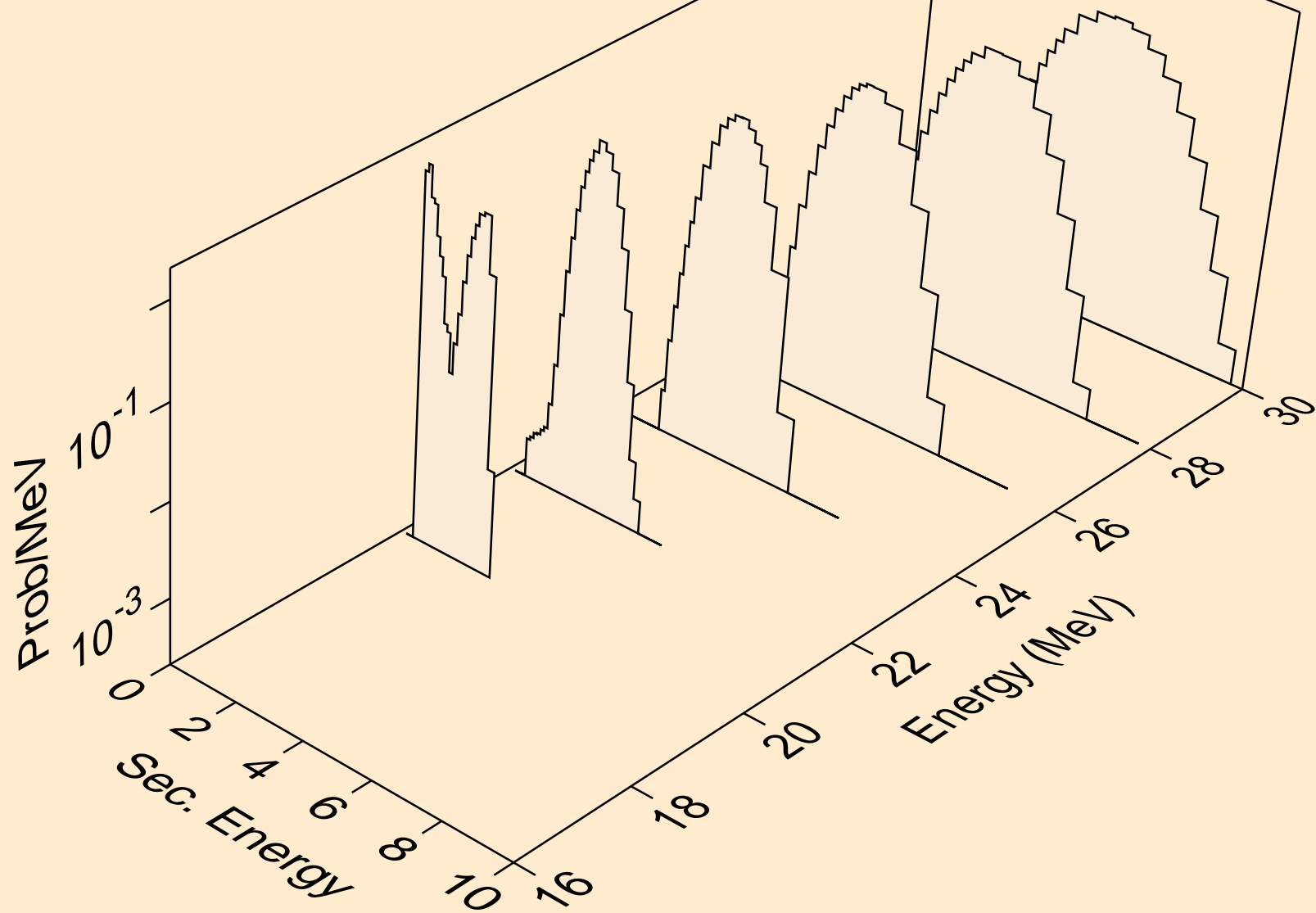

XE124 PROTON ACER TENDL-2023 LIBRARY; T=0.K
Proton emission for (p,npa)

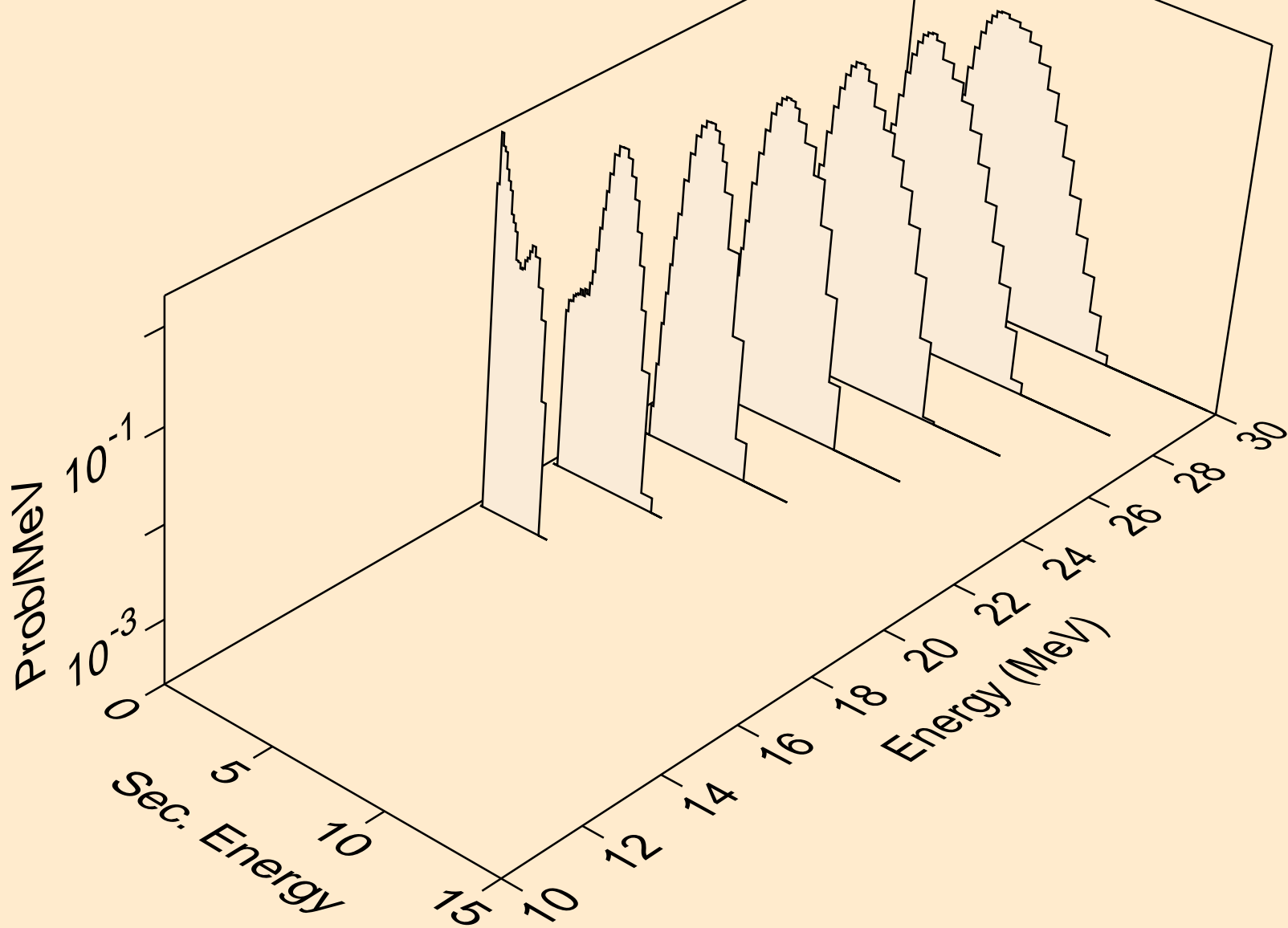

XE124 PROTON ACER TENDL-2023 LIBRARY; T=0.K
Proton emission for inelastic

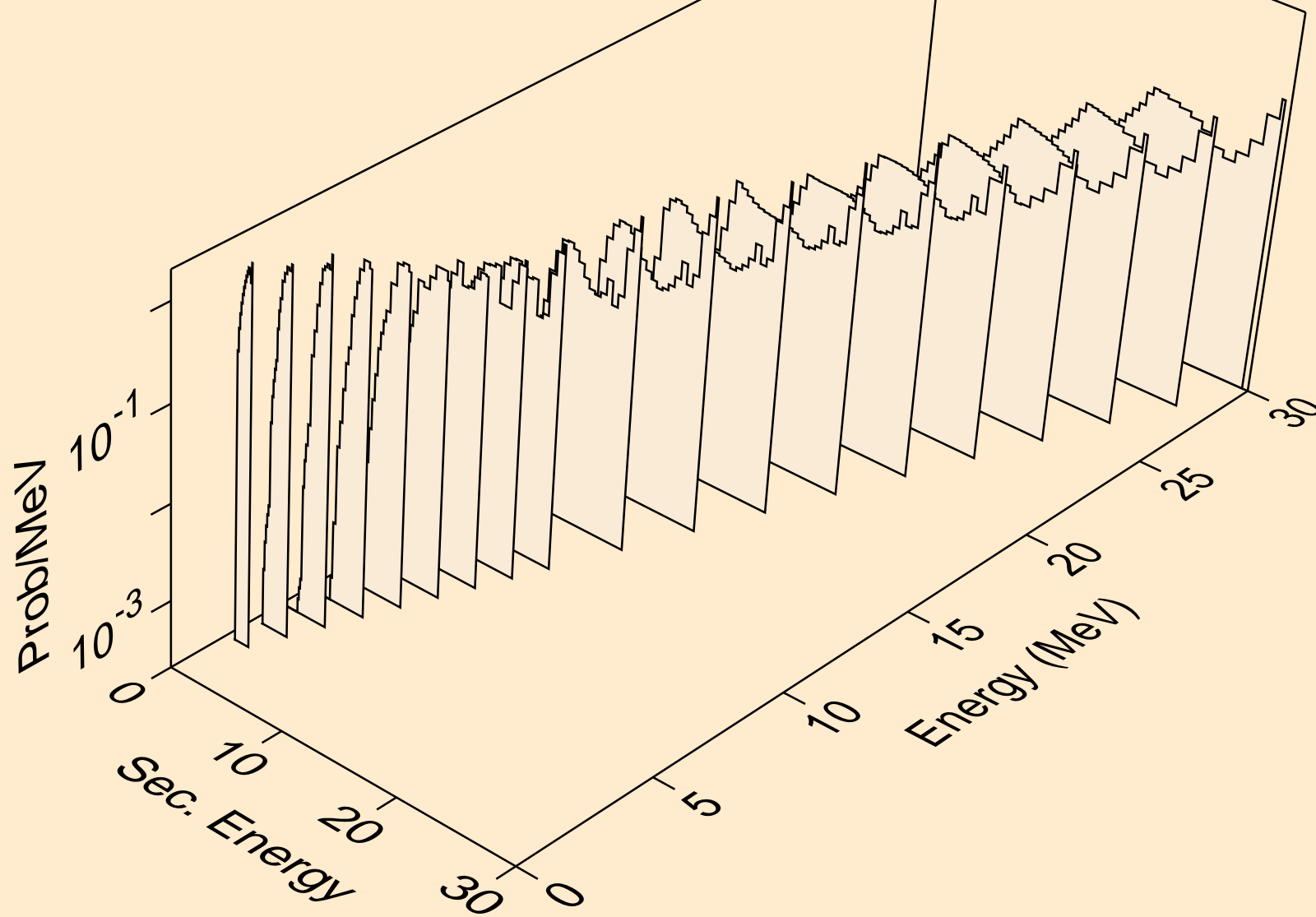

XE124 PROTON ACER TENDL-2023 LIBRARY; T=0.K
Proton emission for (p,2p)

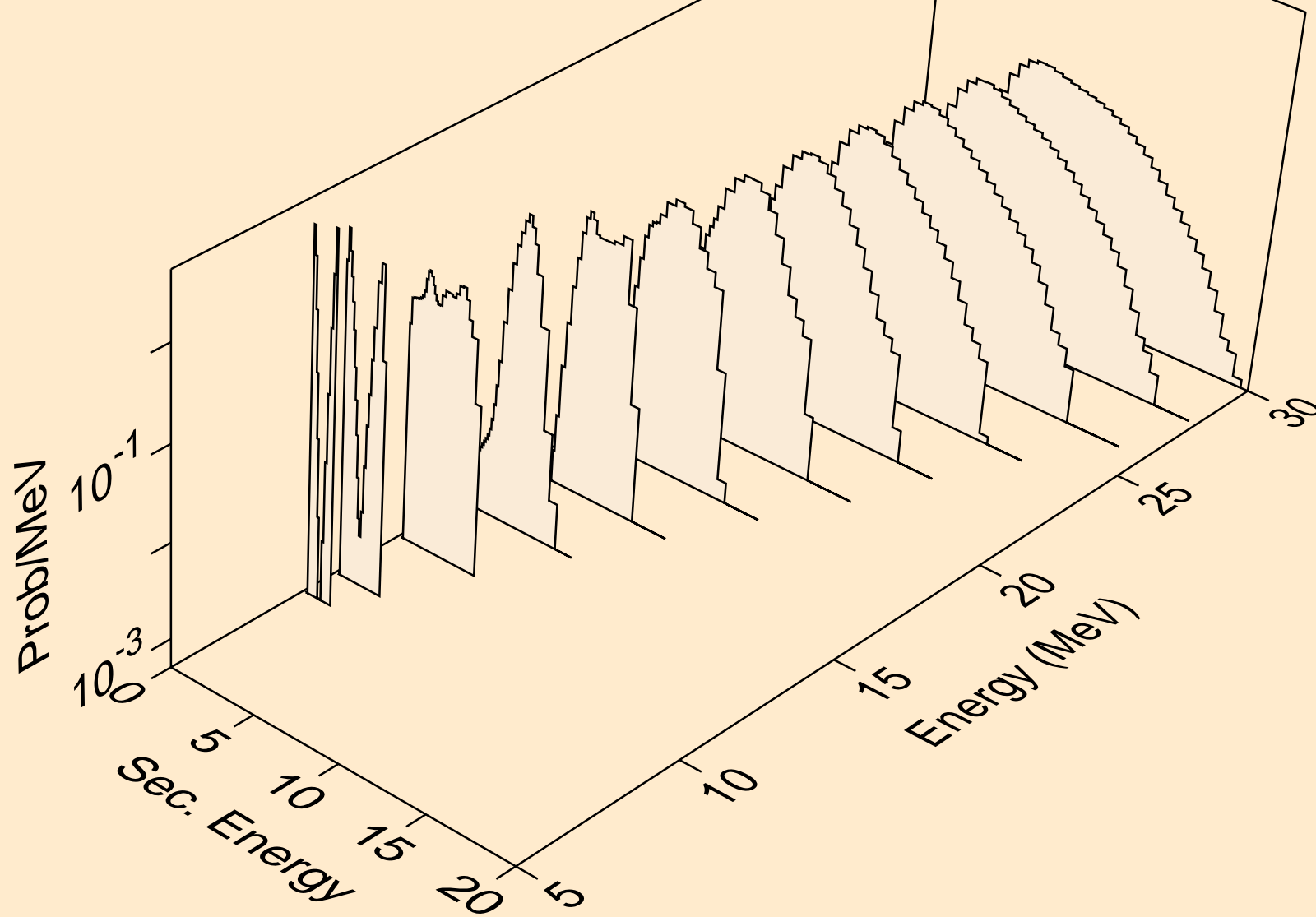

XE124 PROTON ACER TENDL-2023 LIBRARY; T=0.K
Proton emission for (p,pa)

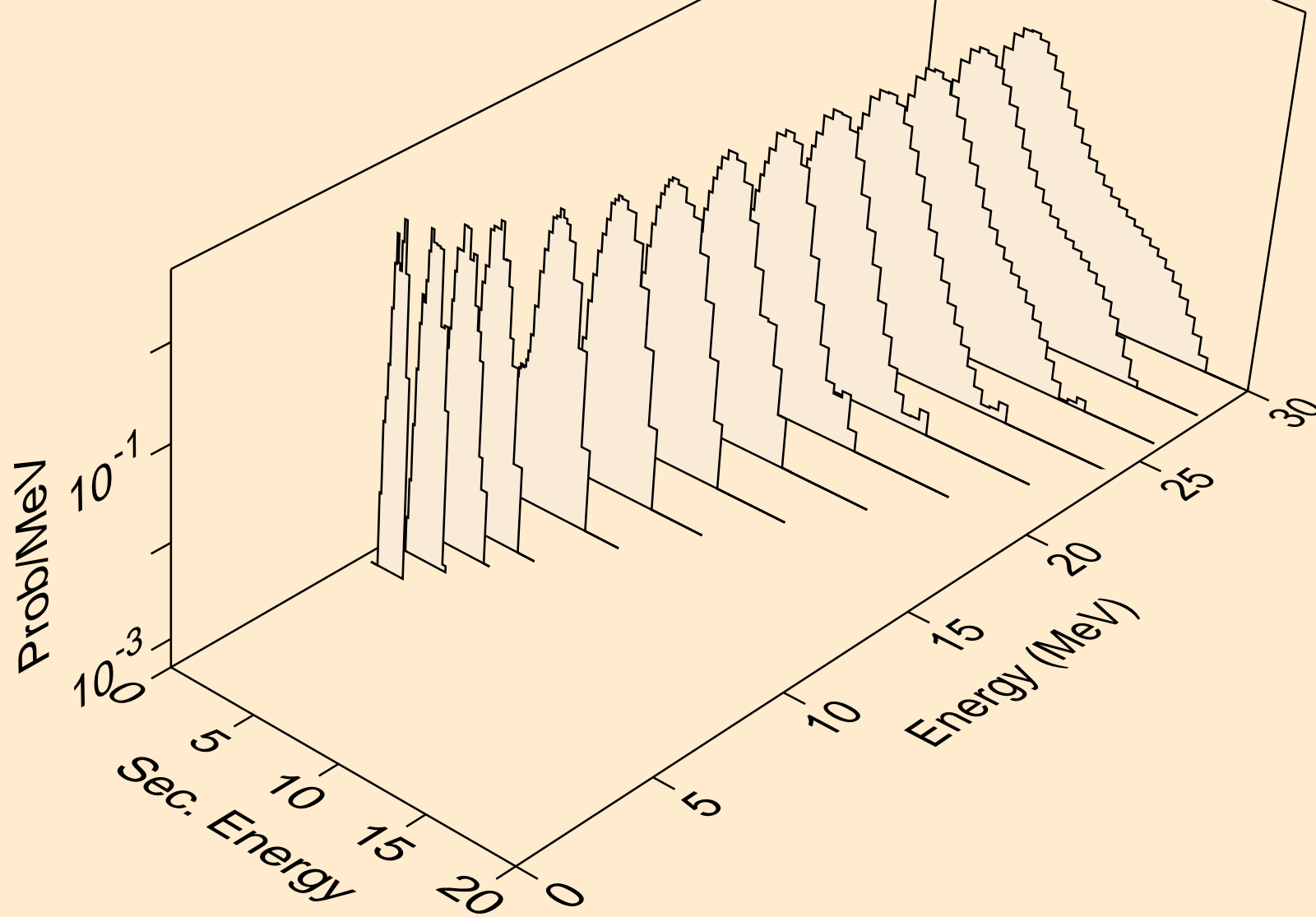

XE124 PROTON ACER TENDL-2023 LIBRARY; T=0.K
Proton emission for (p,pd)

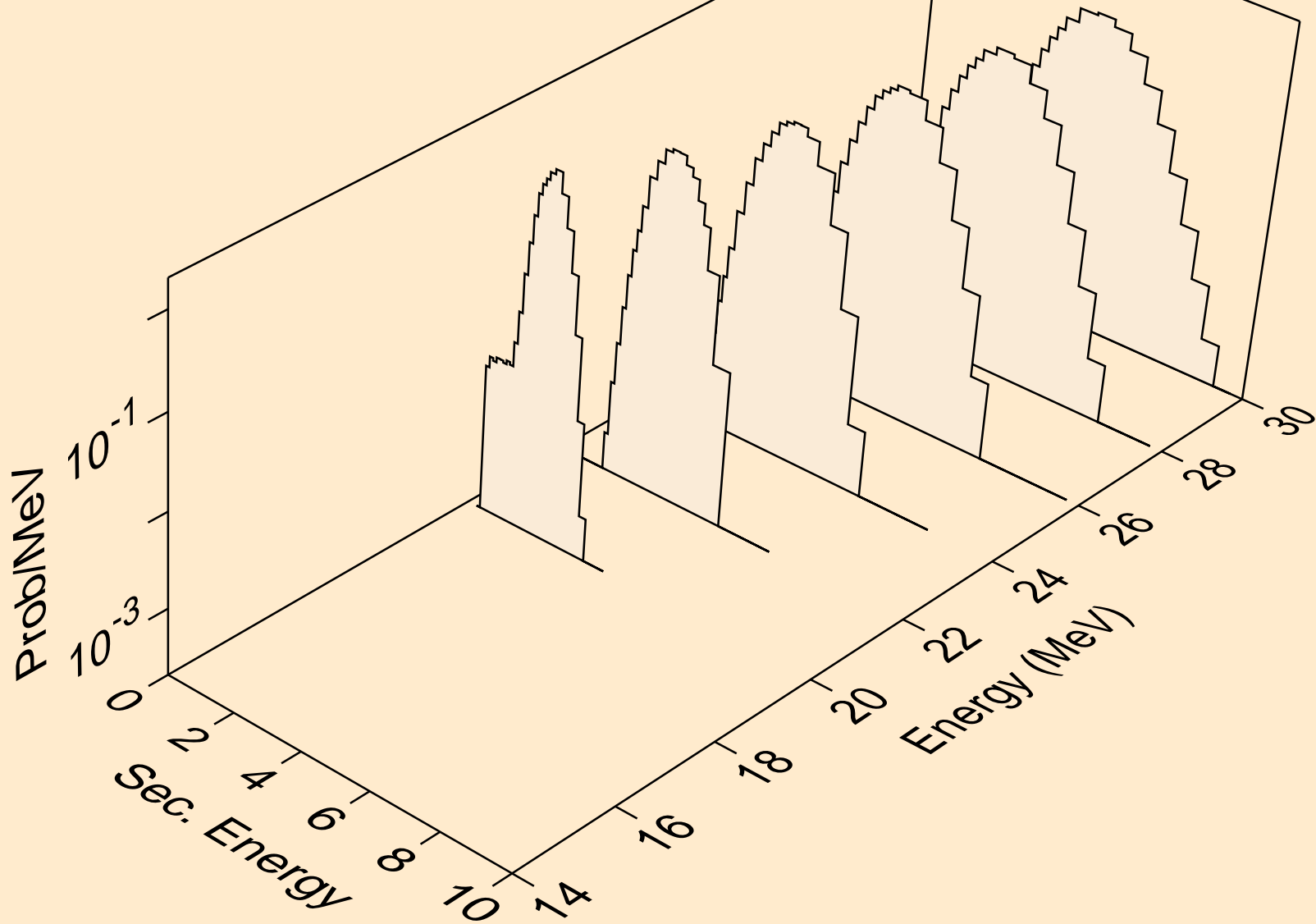

XE124 PROTON ACER TENDL-2023 LIBRARY; T=0.K
Proton emission for (p,pt)

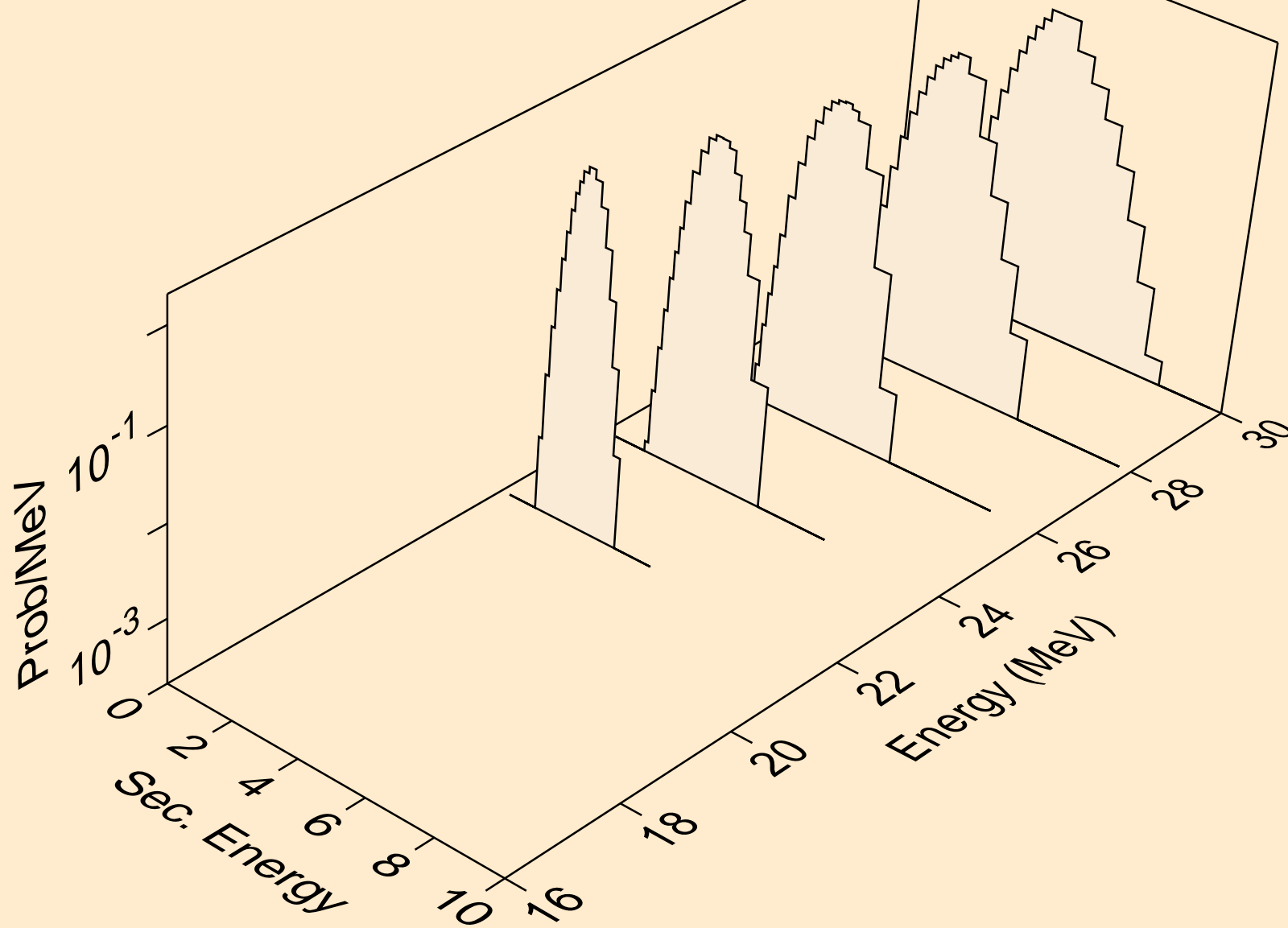

XE124 PROTON ACER TENDL-2023 LIBRARY; T=0.K
Photon emission for (z,n)

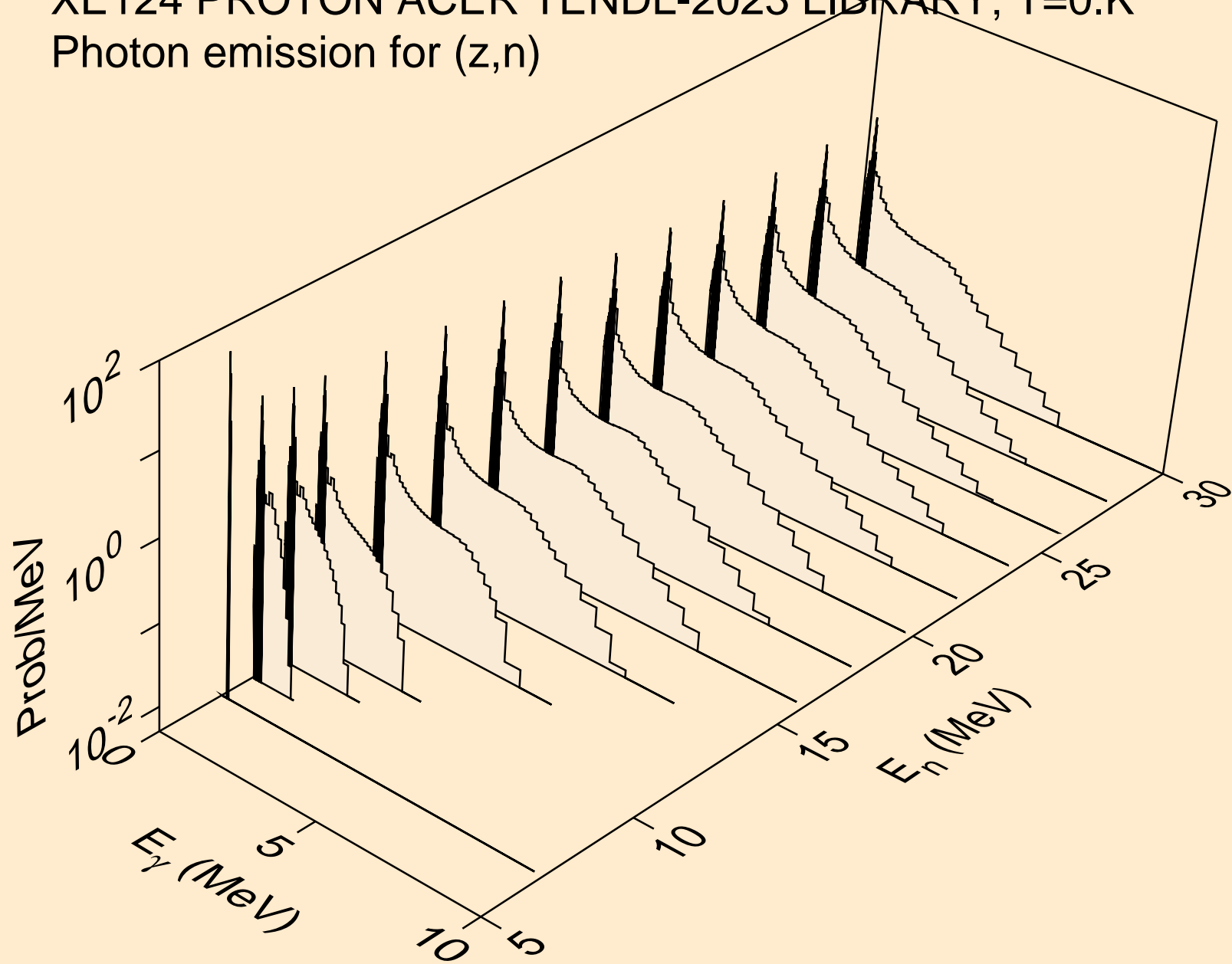

XE124 PROTON ACER TENDL-2023 LIBRARY; T=0.K
Photon emission for (z,x)

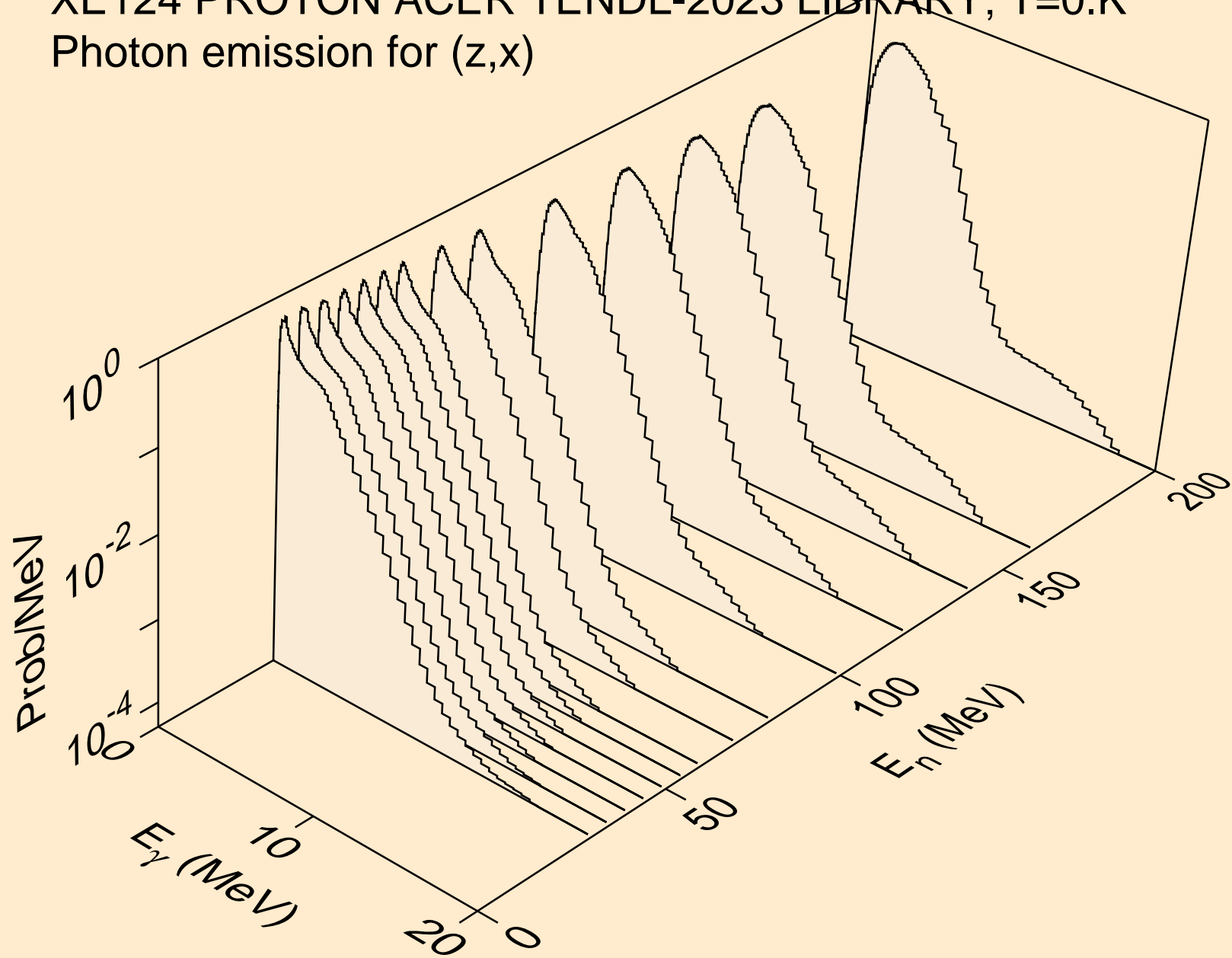

XE124 PROTON ACER TENDL-2023 LIBRARY; T=0.K
Photon emission for (n,2n)

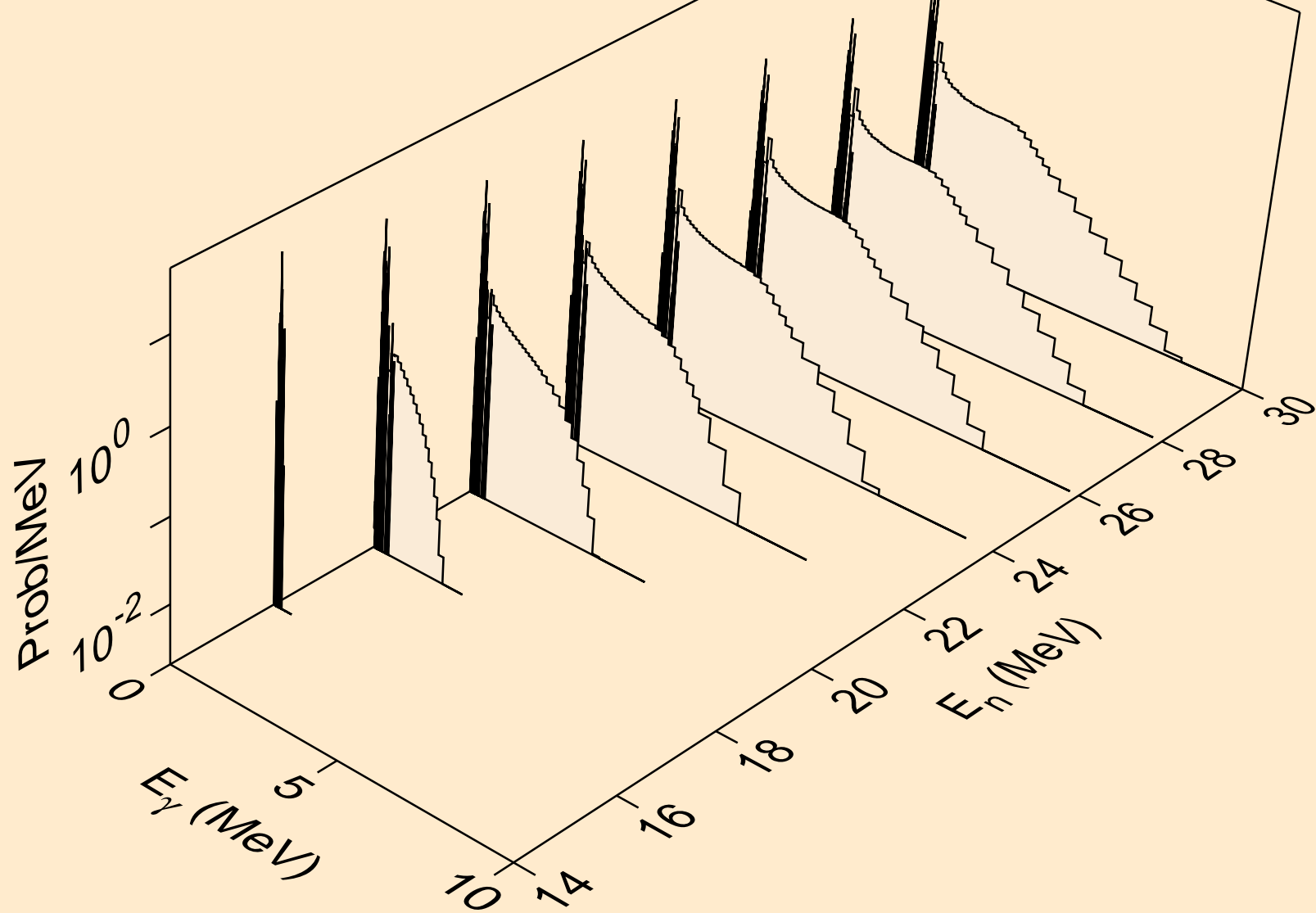

XE124 PROTON ACER TENDL-2023 LIBRARY; T=0.K
Photon emission for (n,3n)

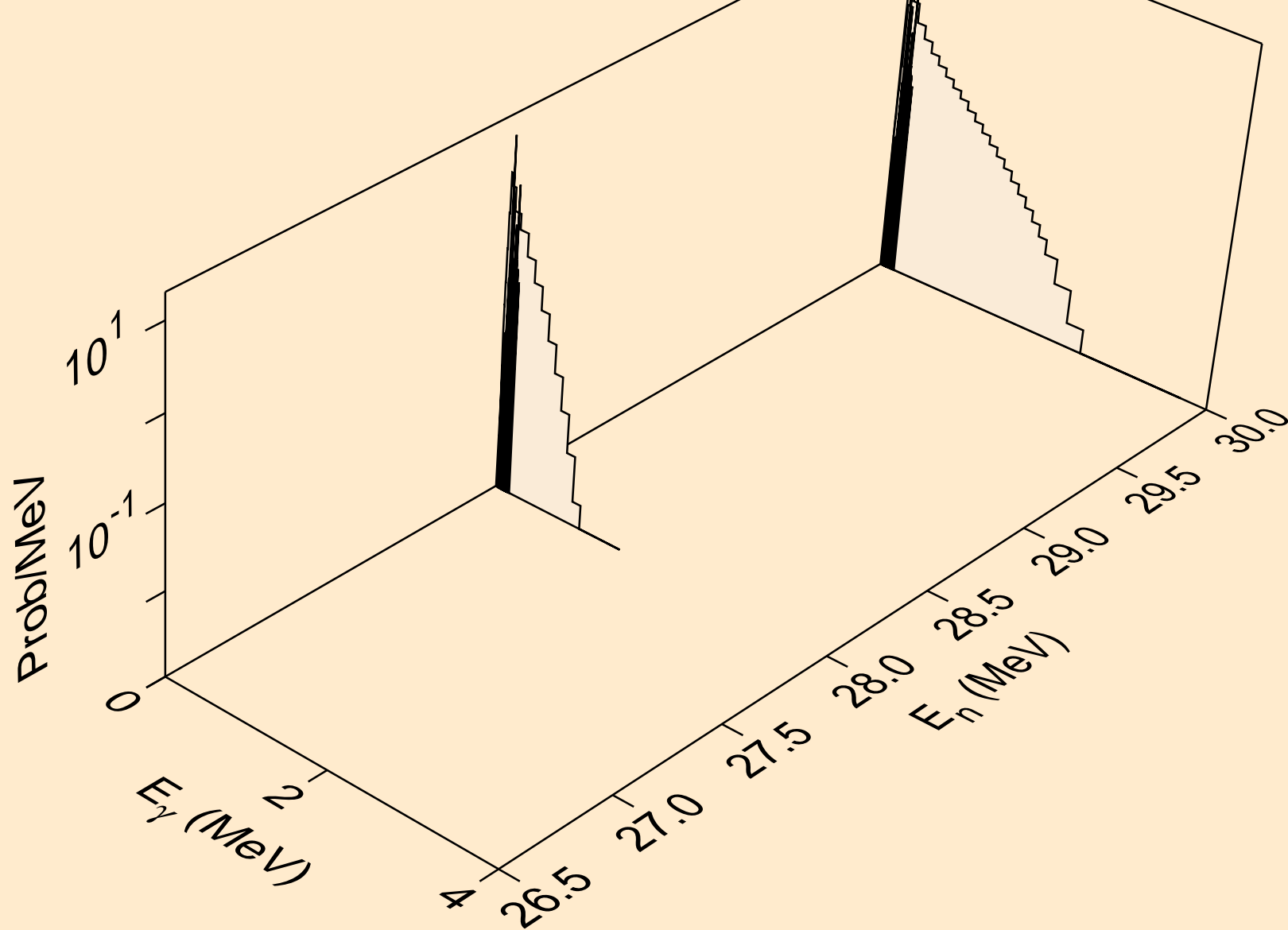

XE124 PROTON ACER TENDL-2023 LIBRARY; T=0.K
Photon emission for (n,n*)a

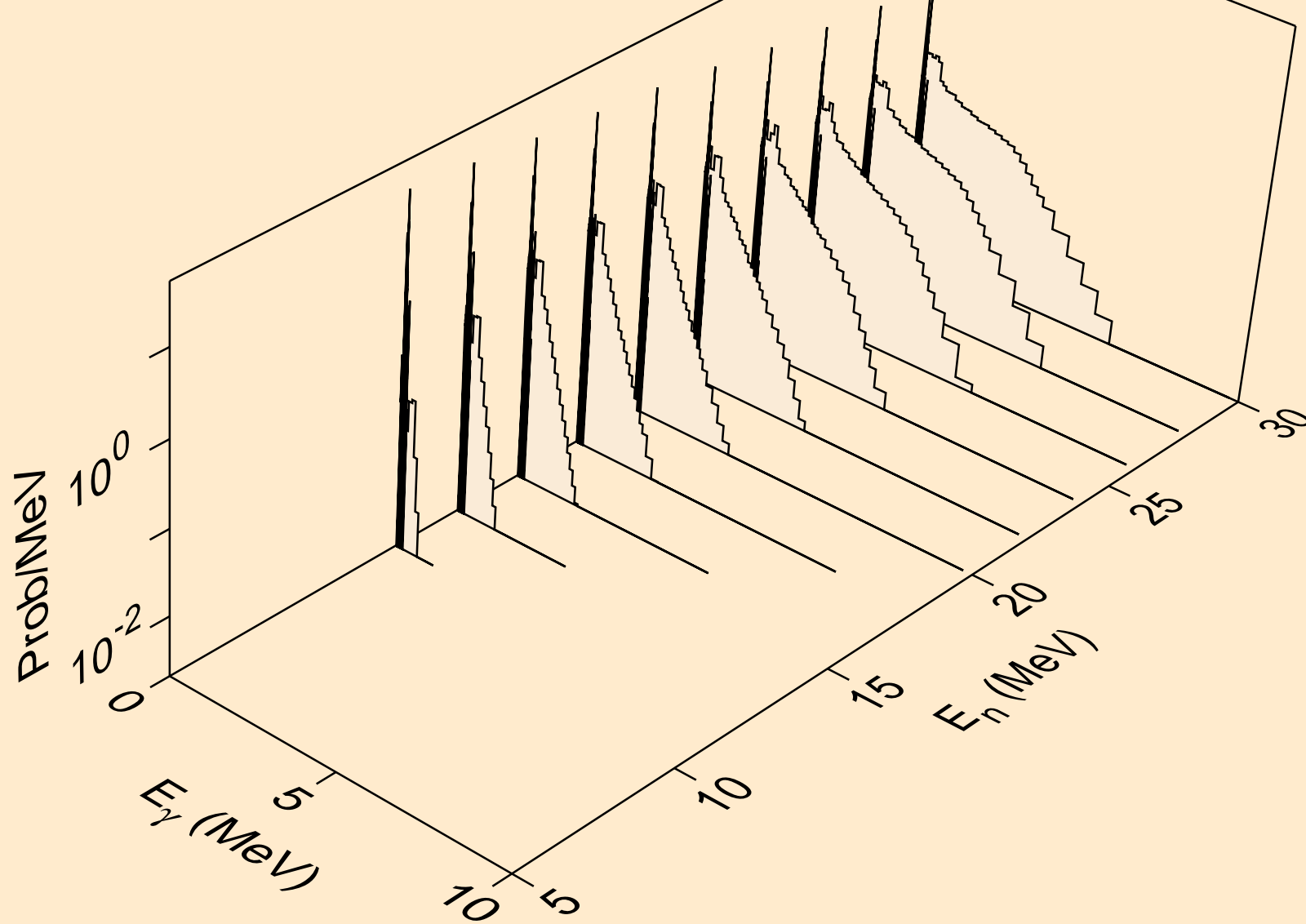

XE124 PROTON ACER TENDL-2023 LIBRARY; T=0.K
Photon emission for (n,2n)a

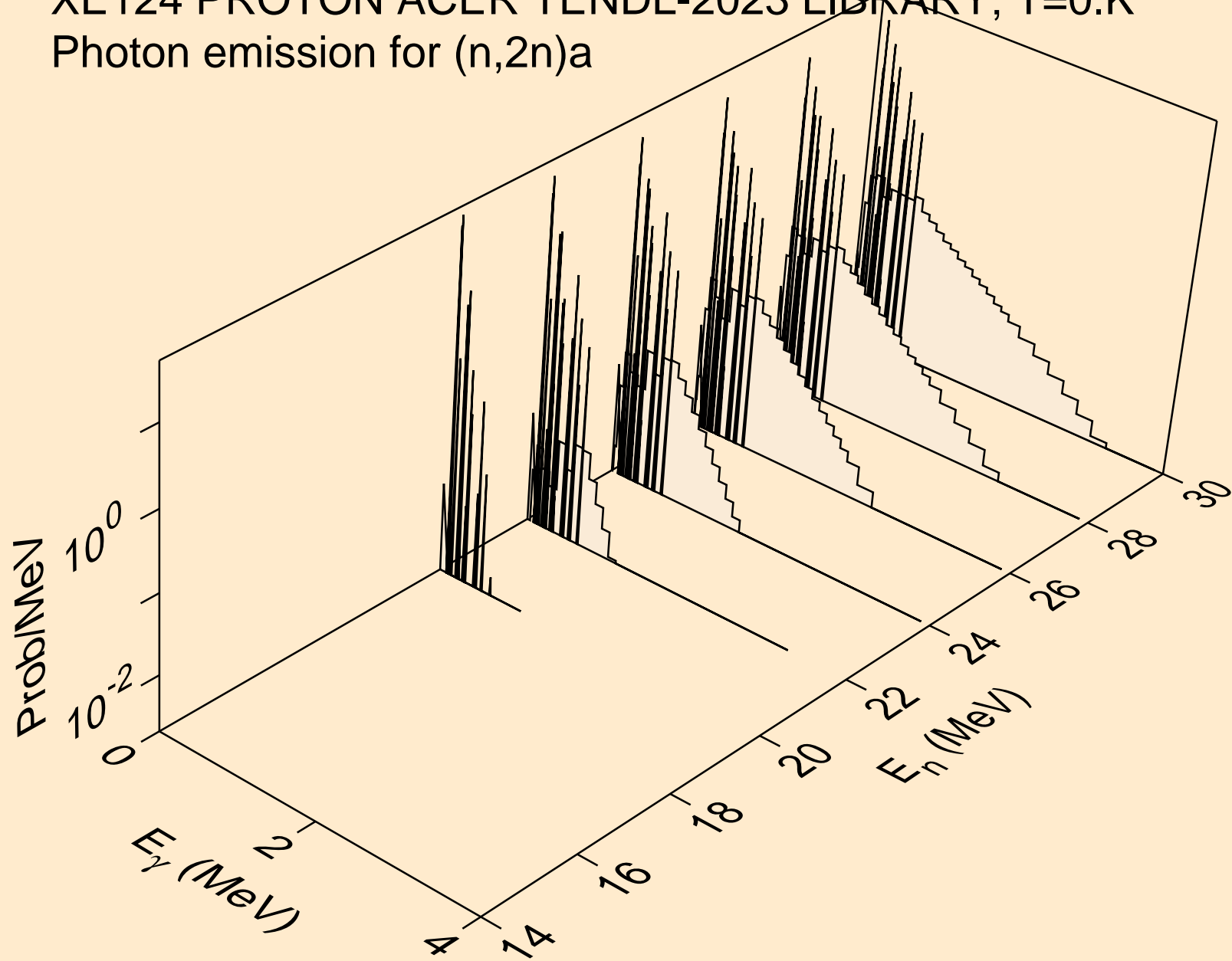

XE124 PROTON ACER TENDL-2023 LIBRARY; T=0.K
Photon emission for (n,n*)p

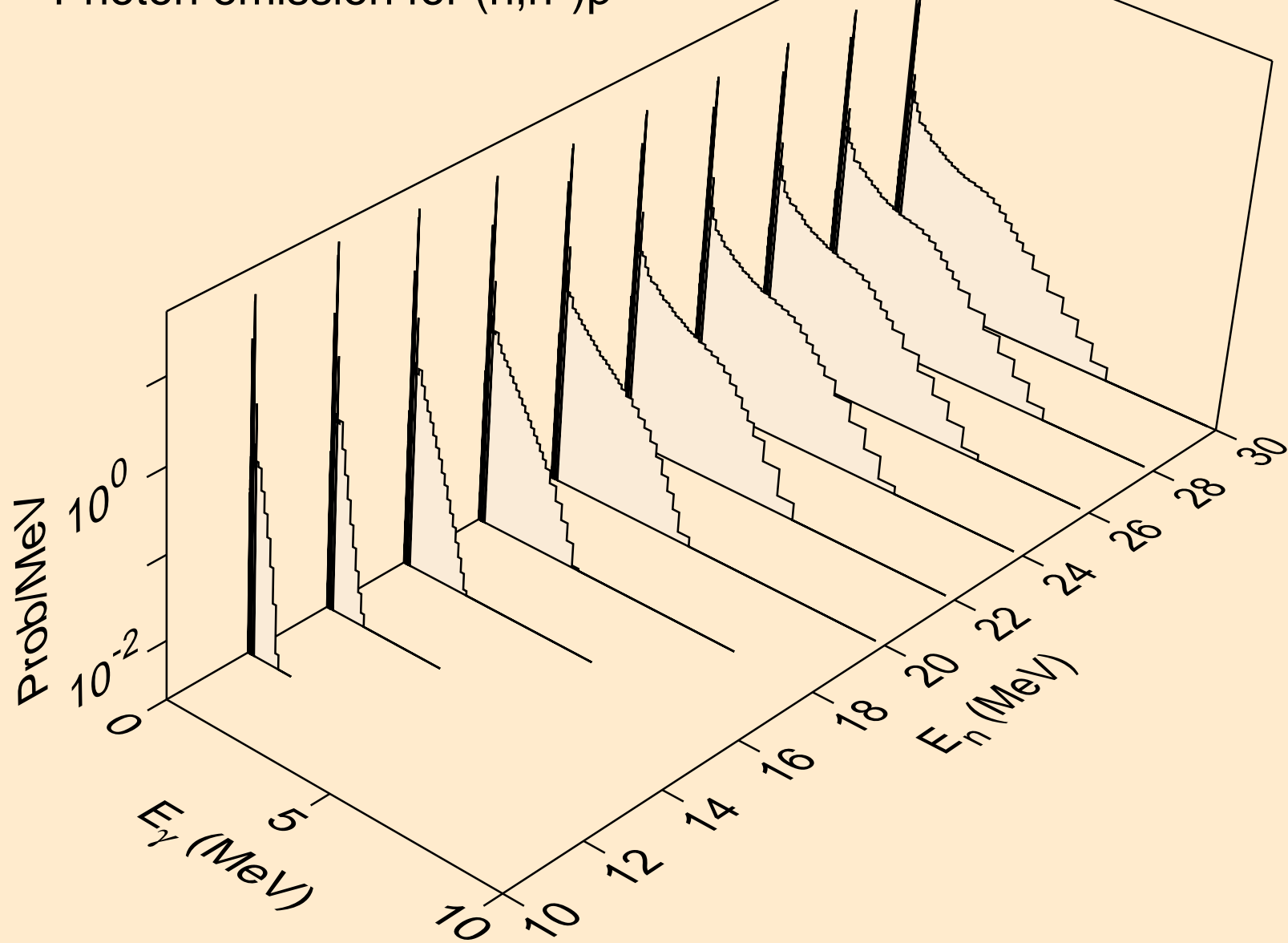

XE124 PROTON ACER TENDL-2023 LIBRARY; T=0.K
Photon emission for (n,n*)2a

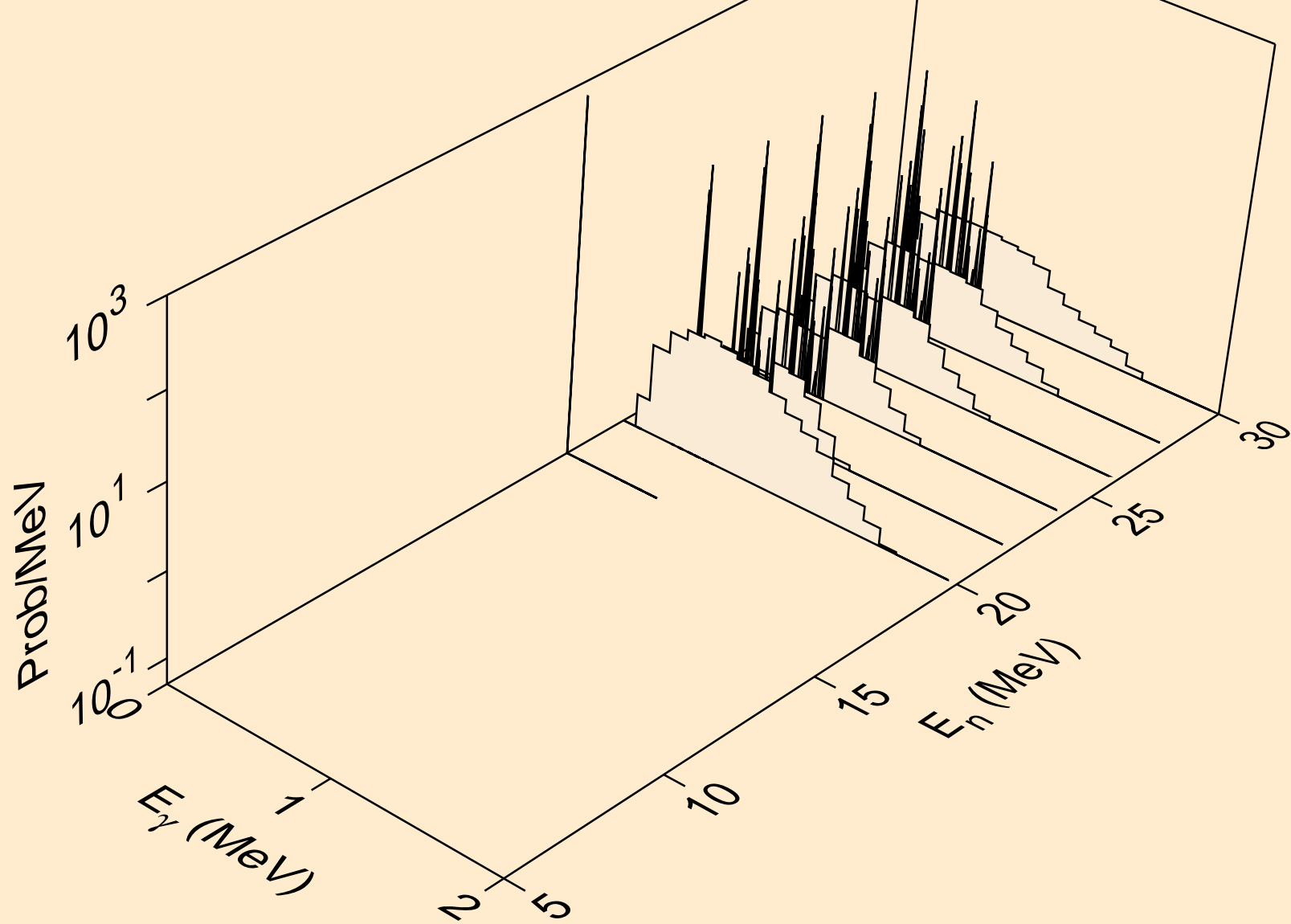

XE124 PROTON ACER TENDL-2023 LIBRARY; T=0.K
Photon emission for (n,n*)d

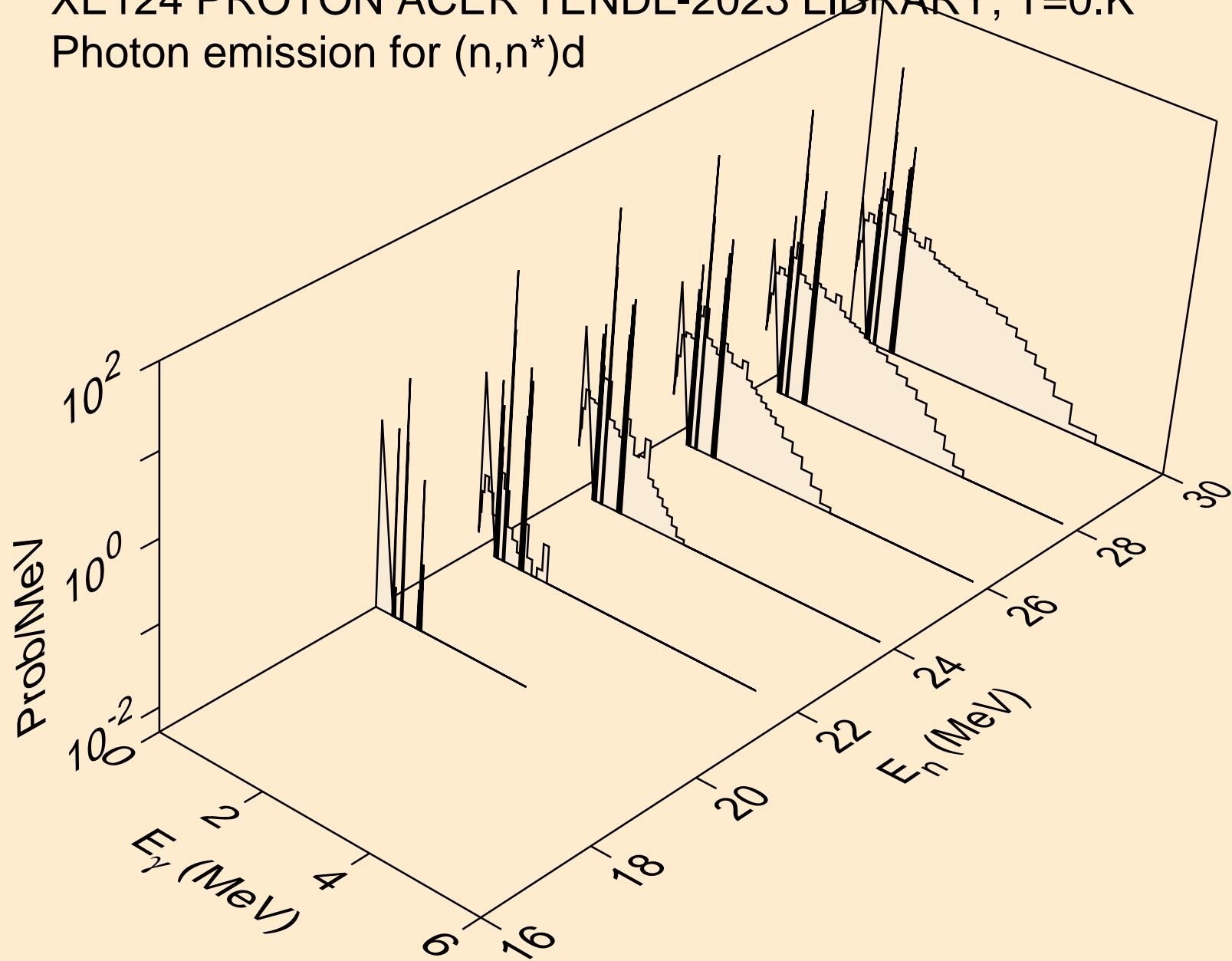

XE124 PROTON ACER TENDL-2023 LIBRARY; T=0.K

Photon emission for (n,n*)t

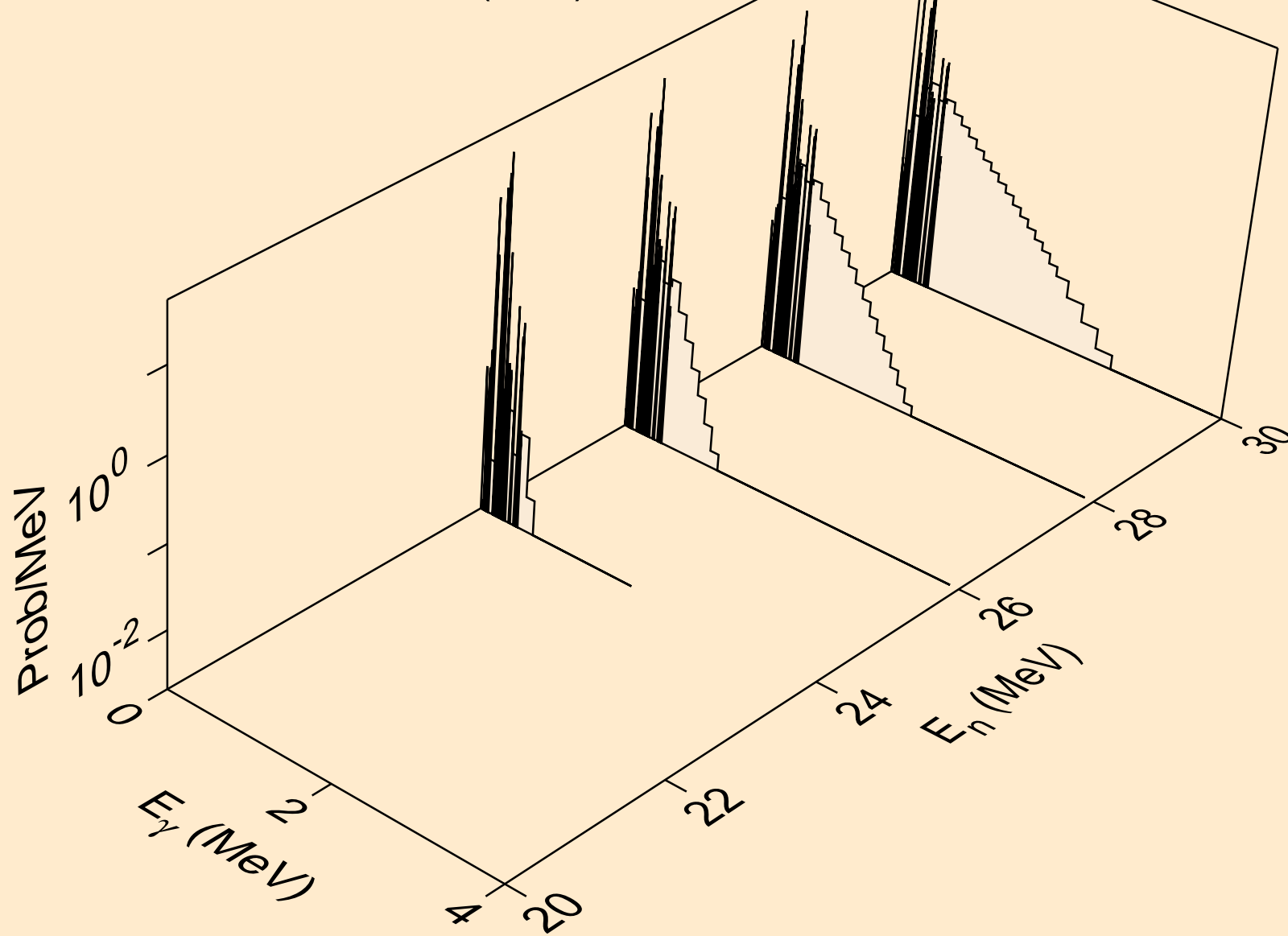

XE124 PROTON ACER TENDL-2023 LIBRARY; T=0.K
Photon emission for (n,n*)he3

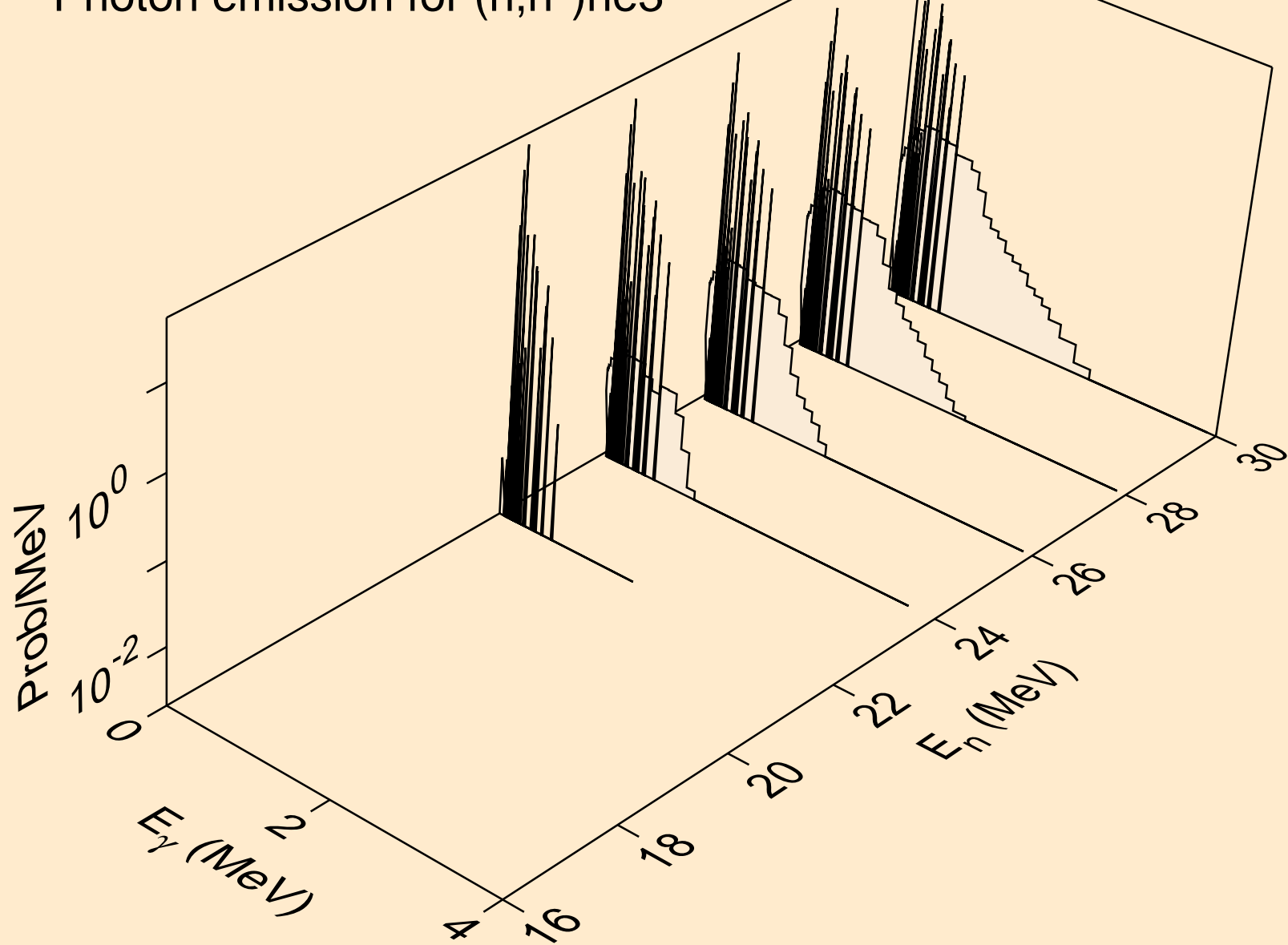

XE124 PROTON ACER TENDL-2023 LIBRARY; T=0.K
Photon emission for (n,2np)

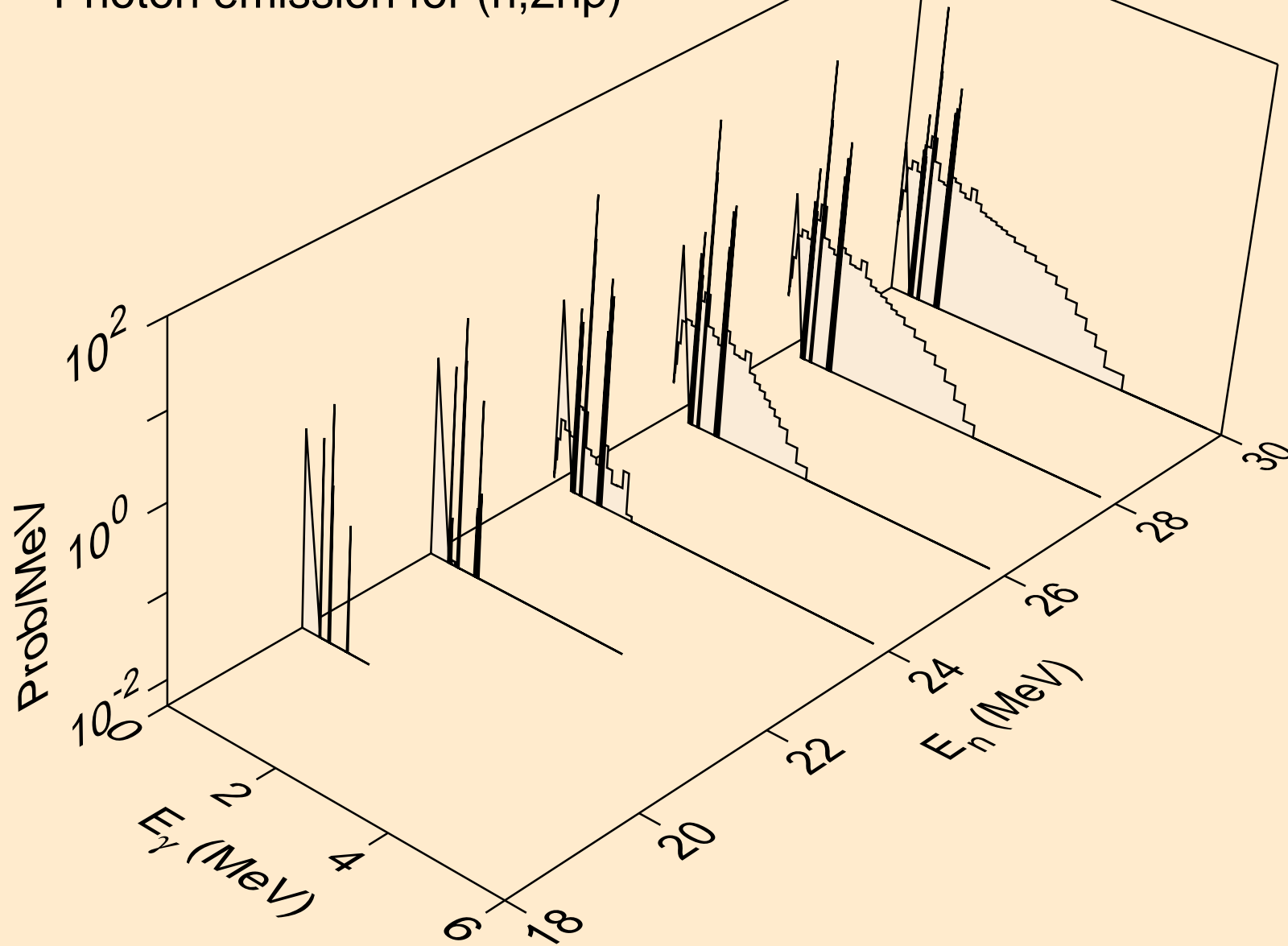

XE124 PROTON ACER TENDL-2023 LIBRARY; T=0.K
Photon emission for (n,n2p)

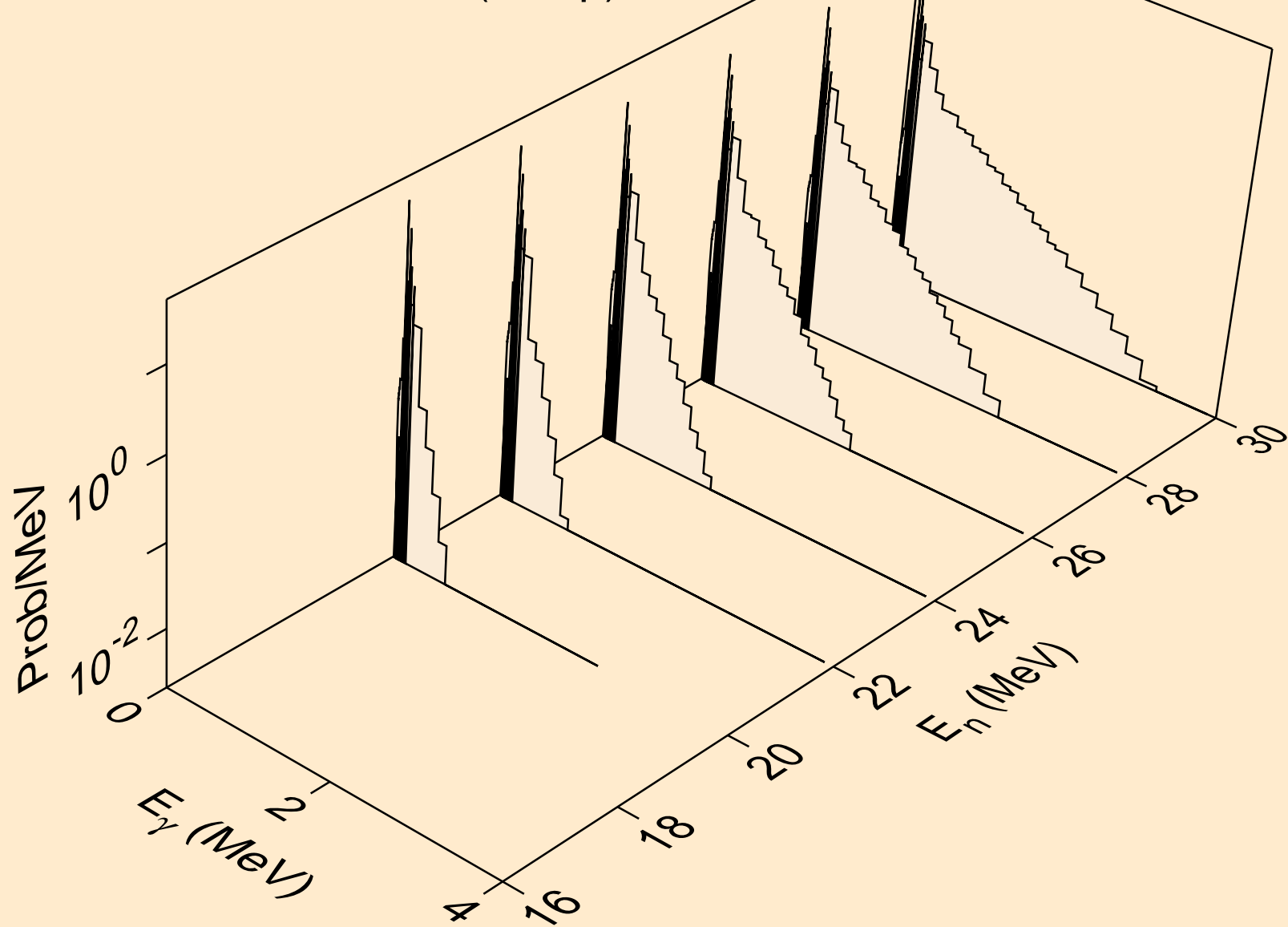

XE124 PROTON ACER TENDL-2023 LIBRARY; T=0.K
Photon emission for (n,npa)

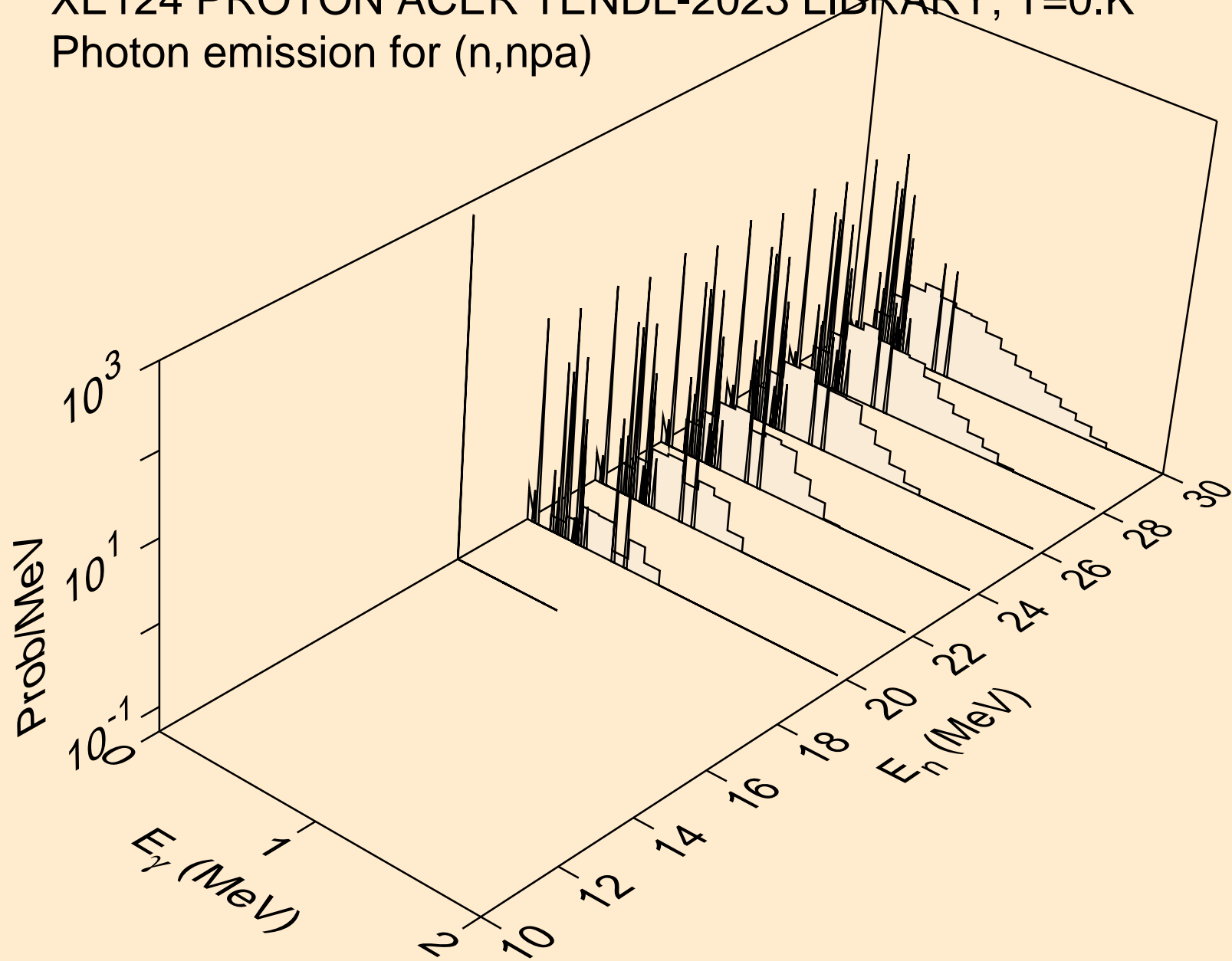

XE124 PROTON ACER TENDL-2023 LIBRARY; T=0.K
Photon emission for (n,gma)

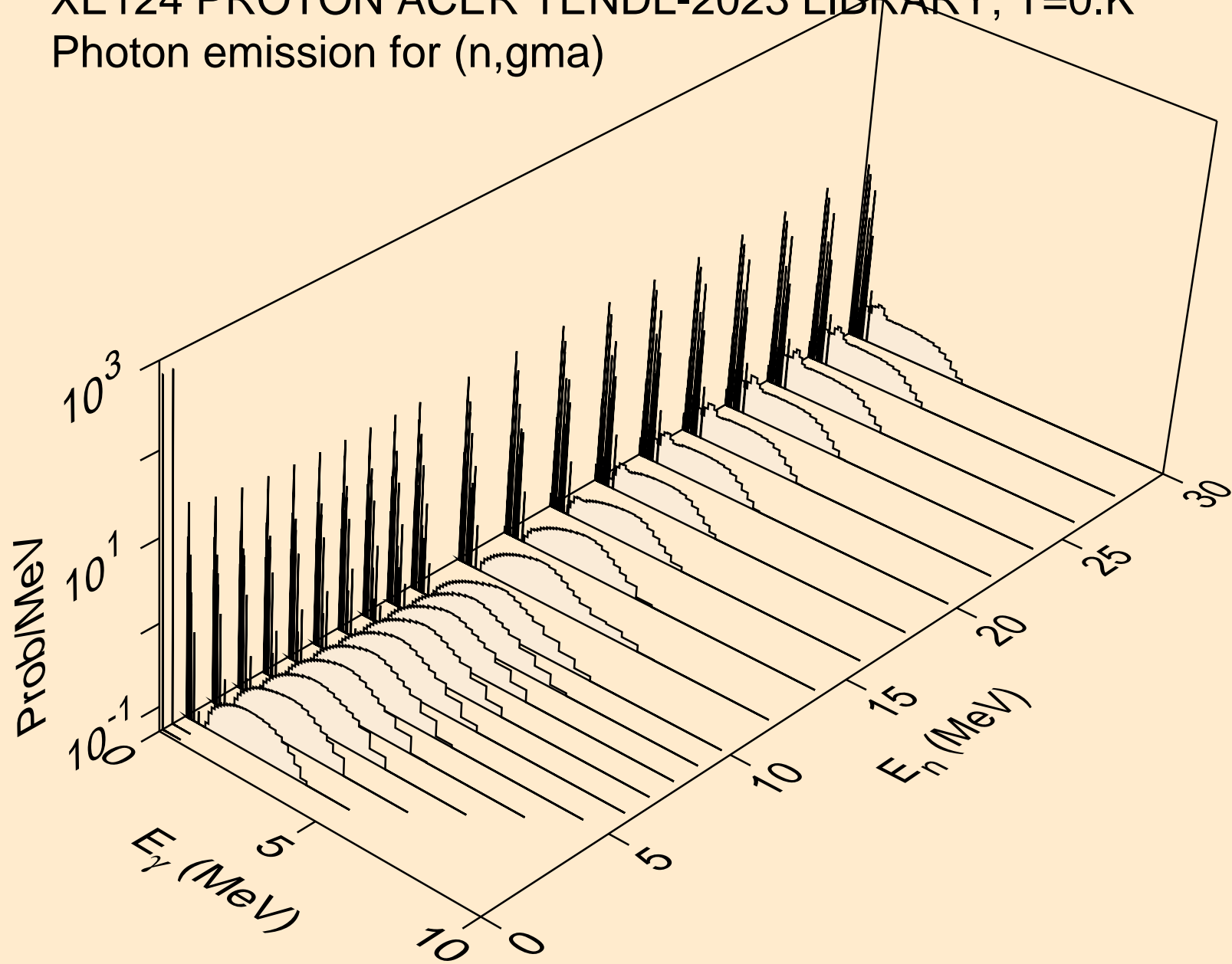

XE124 PROTON ACER TENDL-2023 LIBRARY; T=0.K
Photon emission for inelastic

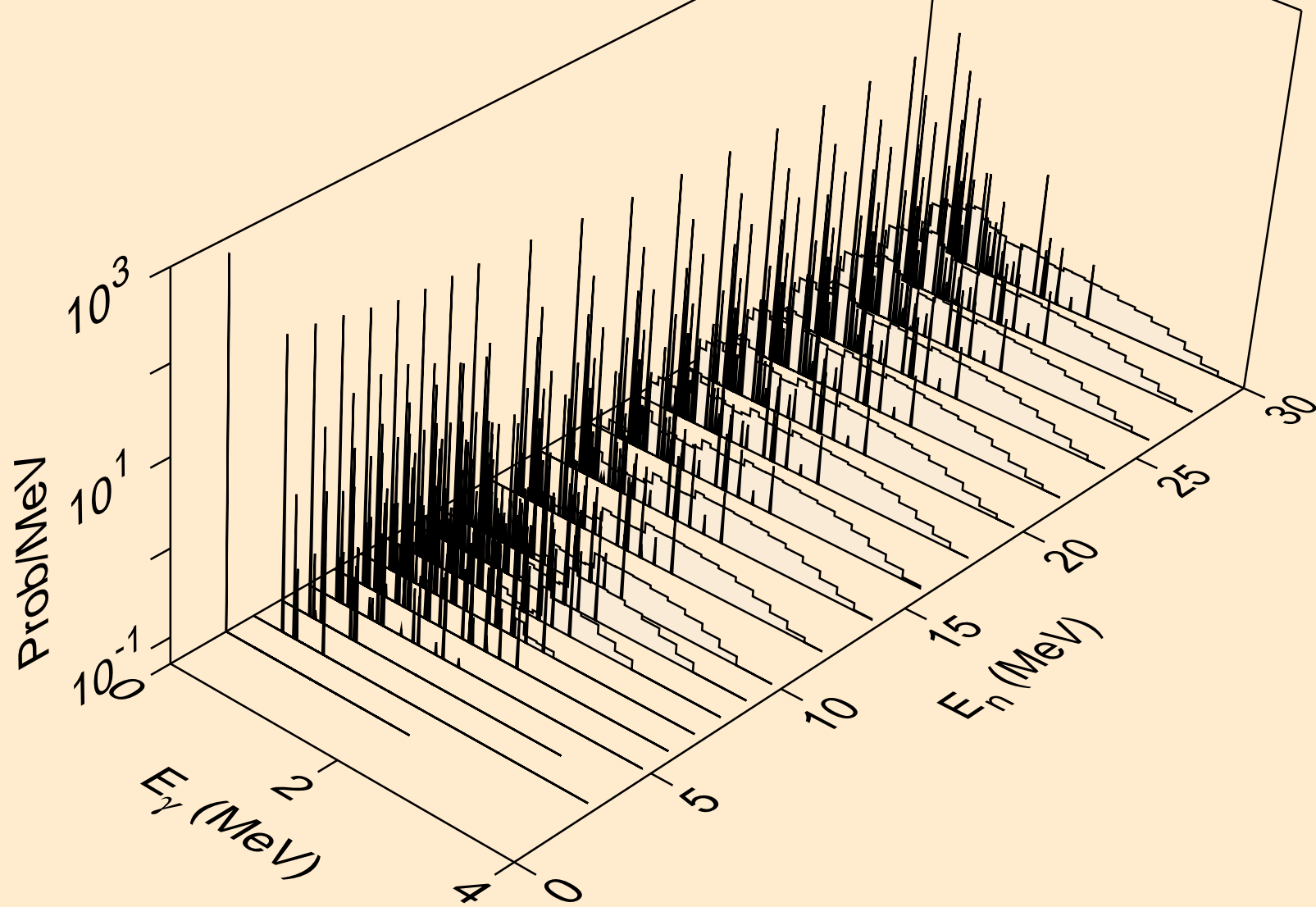

XE124 PROTON ACER TENDL-2023 LIBRARY; T=0.K
Photon emission for (n,d)

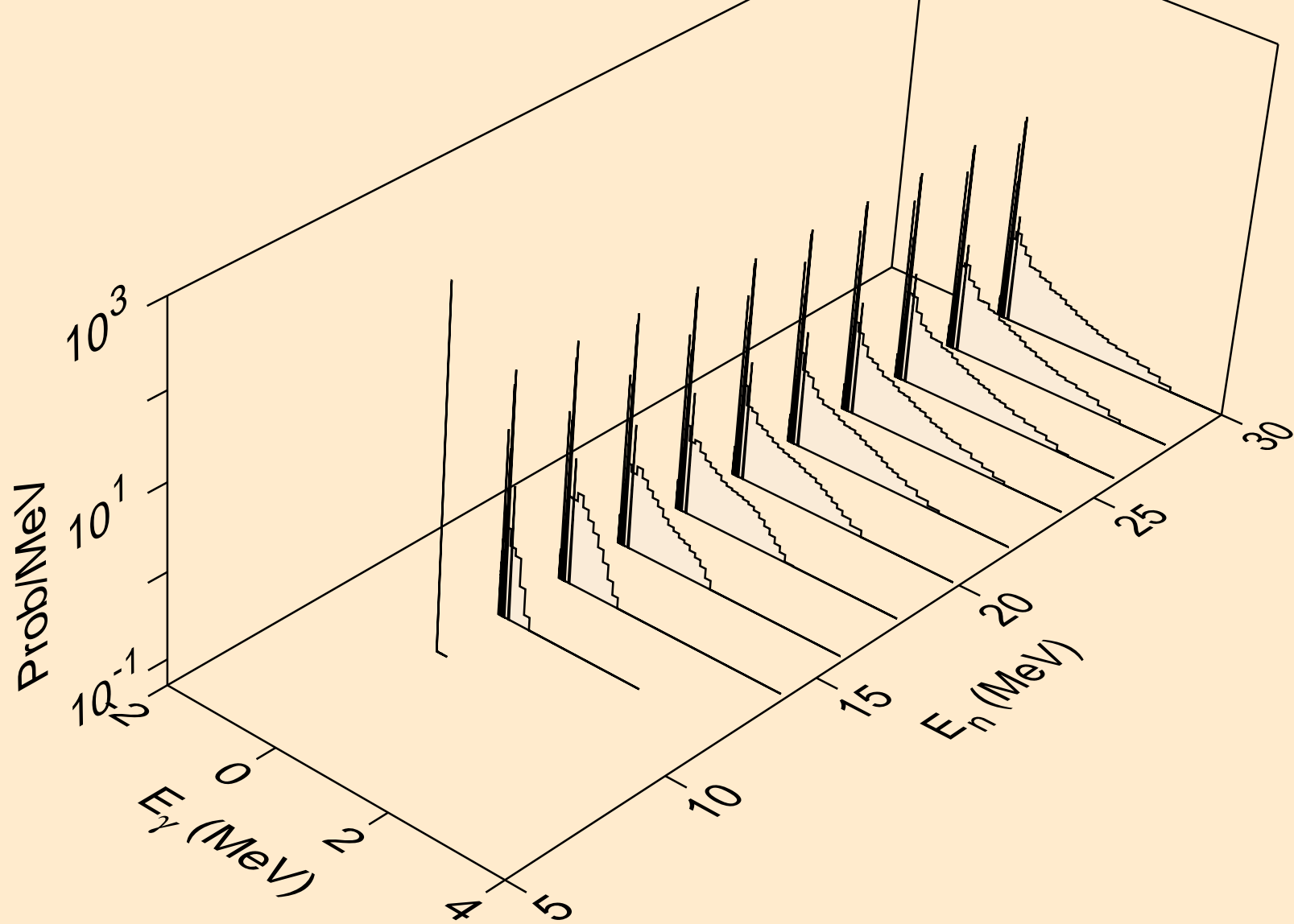

XE124 PROTON ACER TENDL-2023 LIBRARY; T=0.K
Photon emission for (n,t)

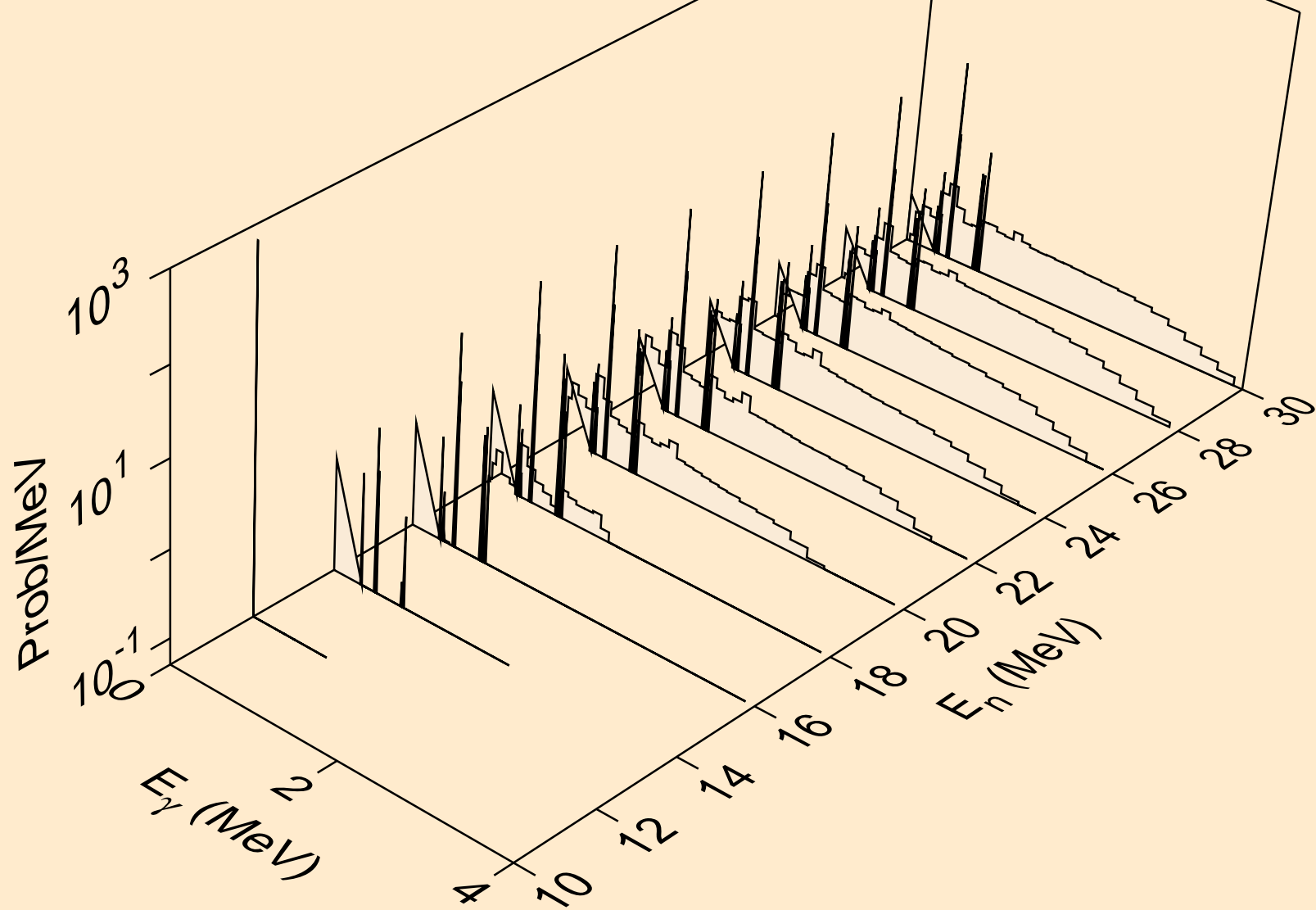

XE124 PROTON ACER TENDL-2023 LIBRARY; T=0.K
Photon emission for (n,he3)

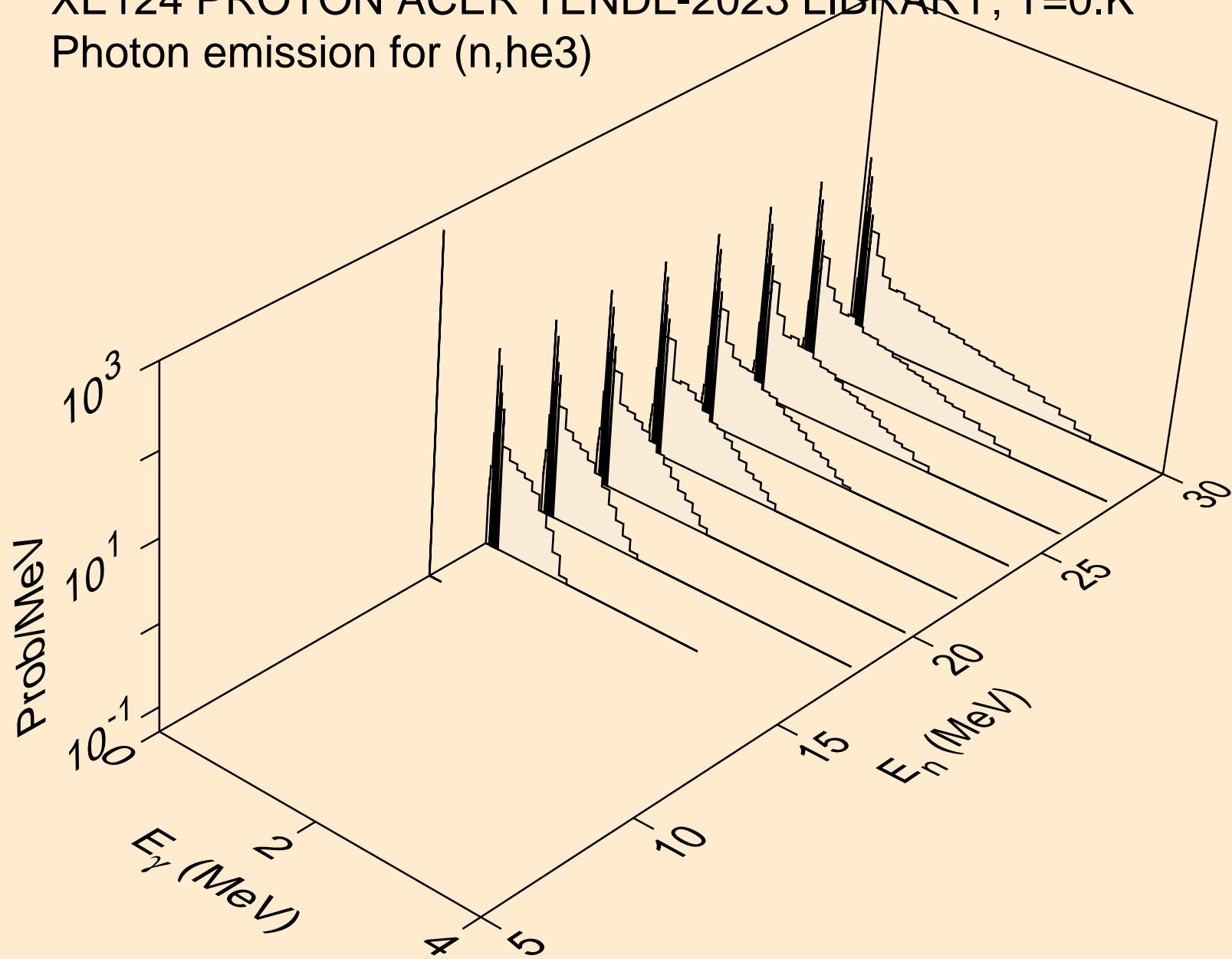

XE124 PROTON ACER TENDL-2023 LIBRARY; T=0.K
Photon emission for (n,a)

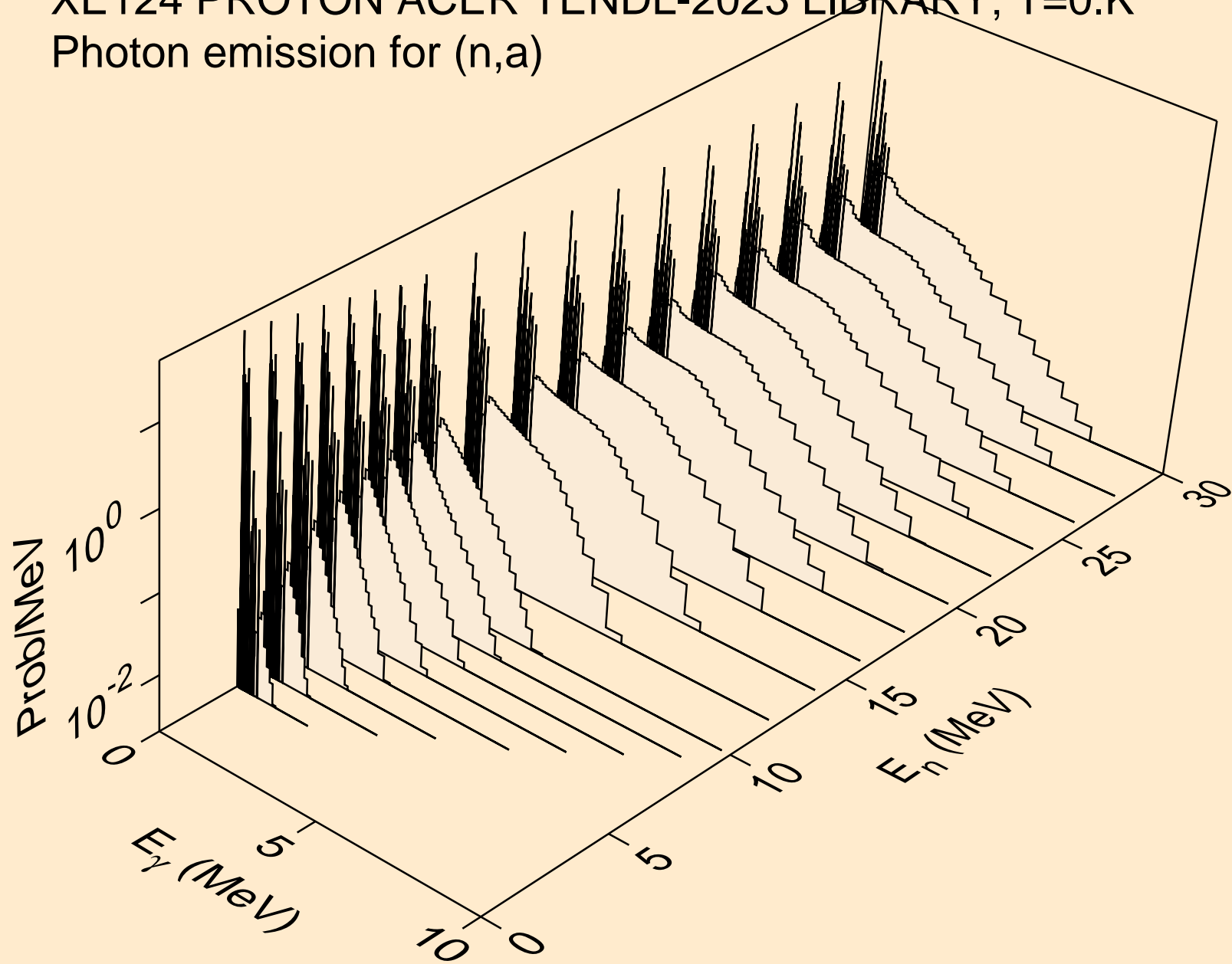

XE124 PROTON ACER TENDL-2023 LIBRARY; T=0.K
Photon emission for (n,2a)

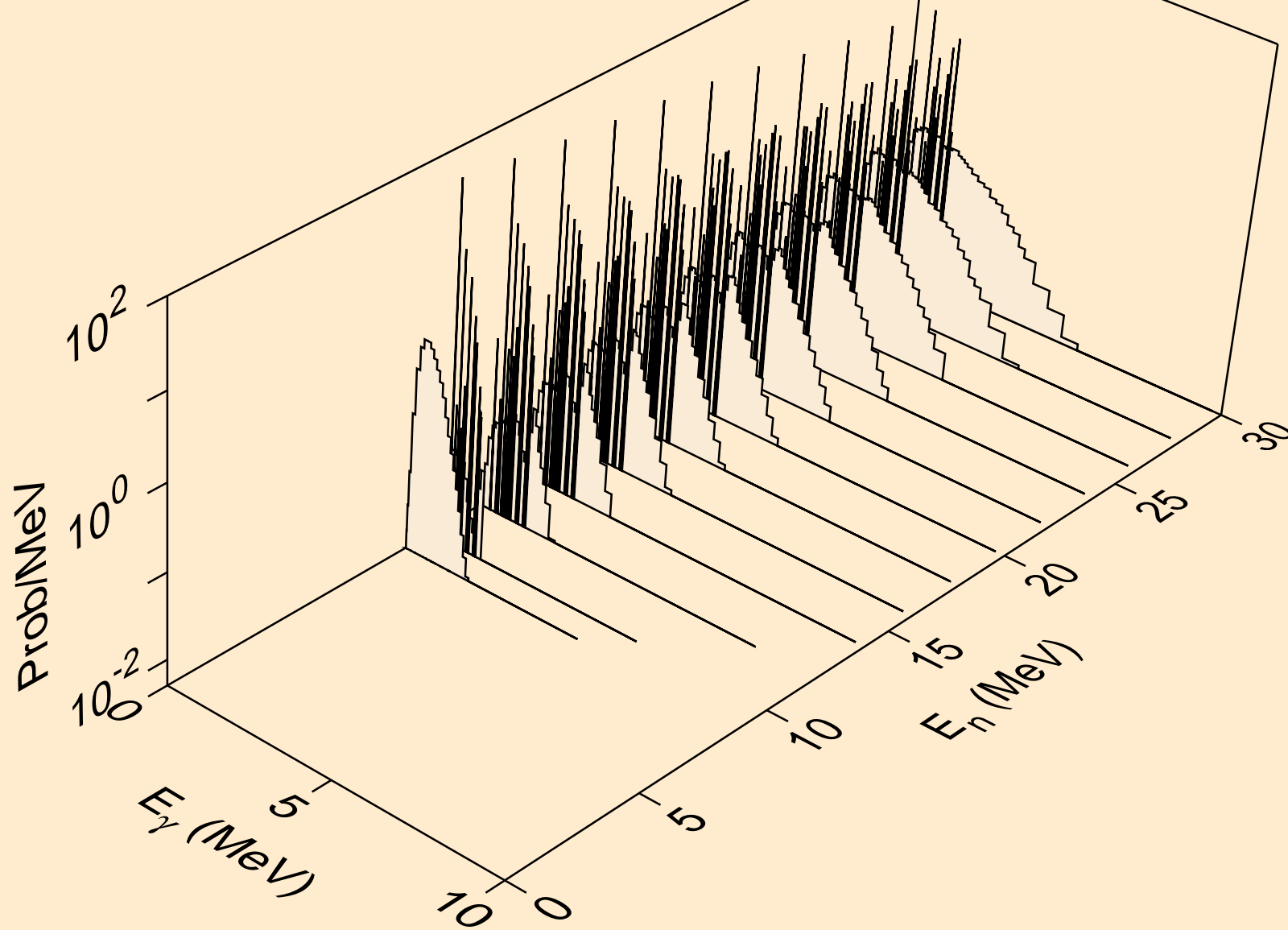

XE124 PROTON ACER TENDL-2023 LIBRARY; T=0.K
Photon emission for (n,2p)

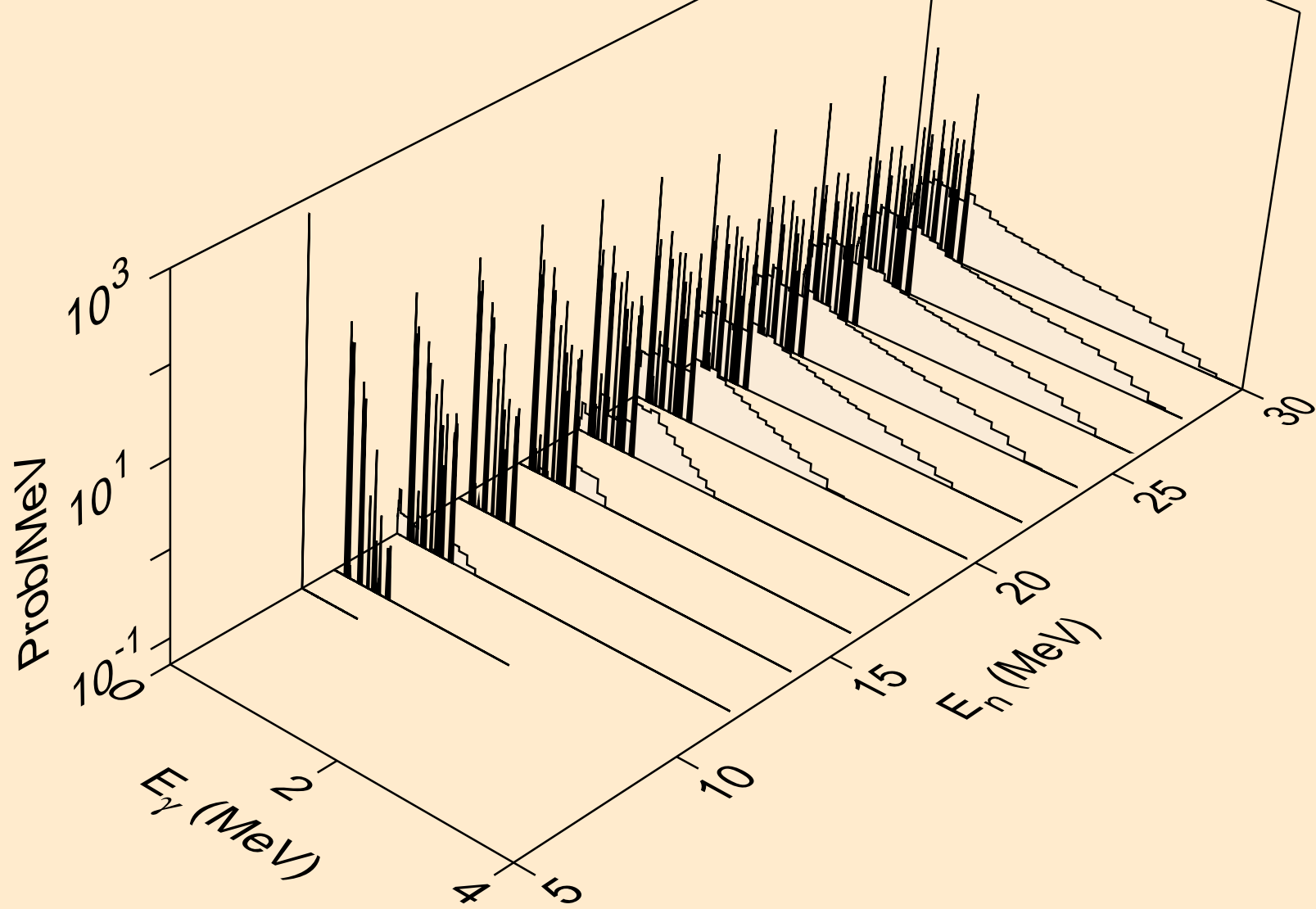

XE124 PROTON ACER TENDL-2023 LIBRARY; T=0.K
Photon emission for (n,pa)

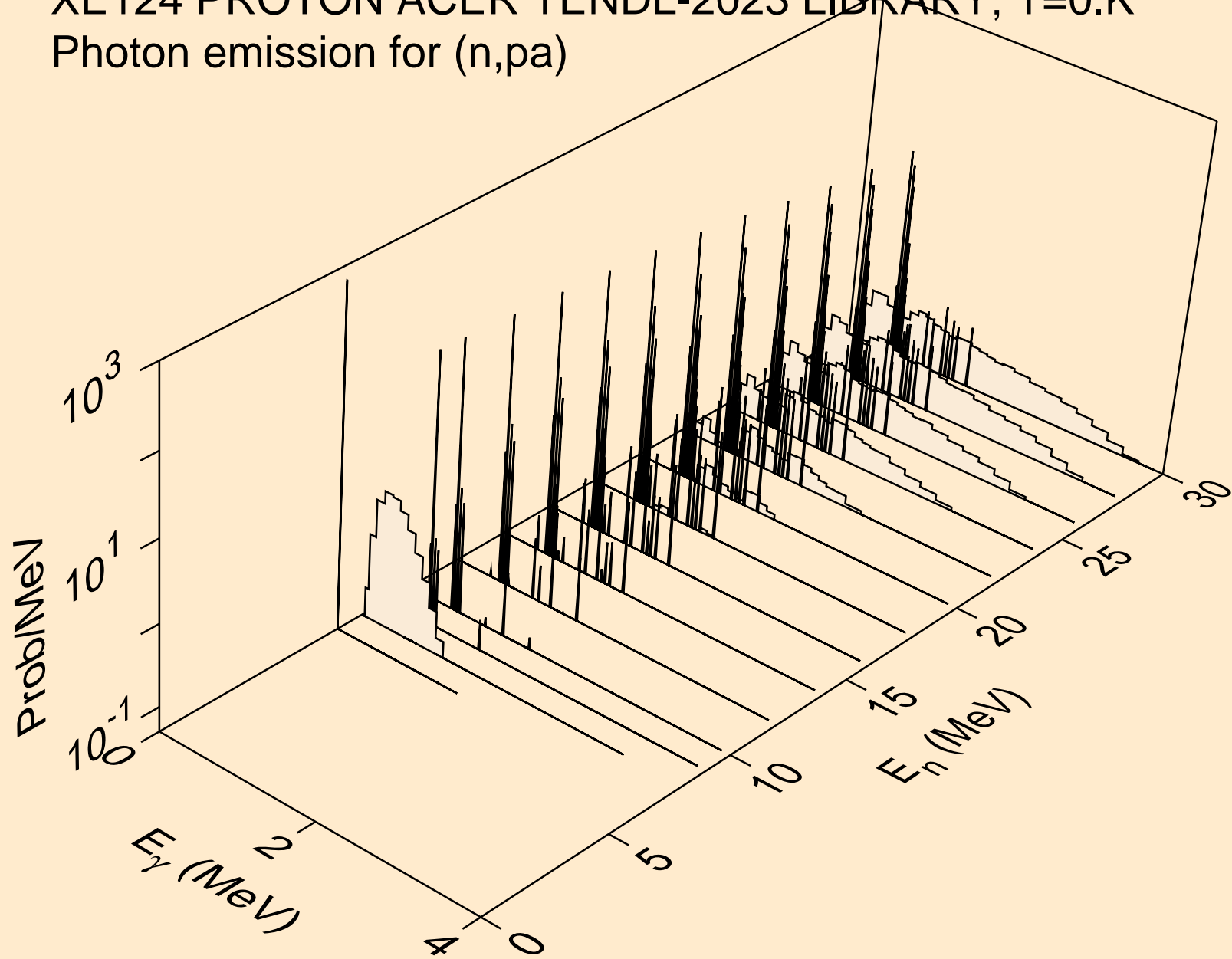

XE124 PROTON ACER TENDL-2023 LIBRARY; T=0.K
Photon emission for (n,pd)

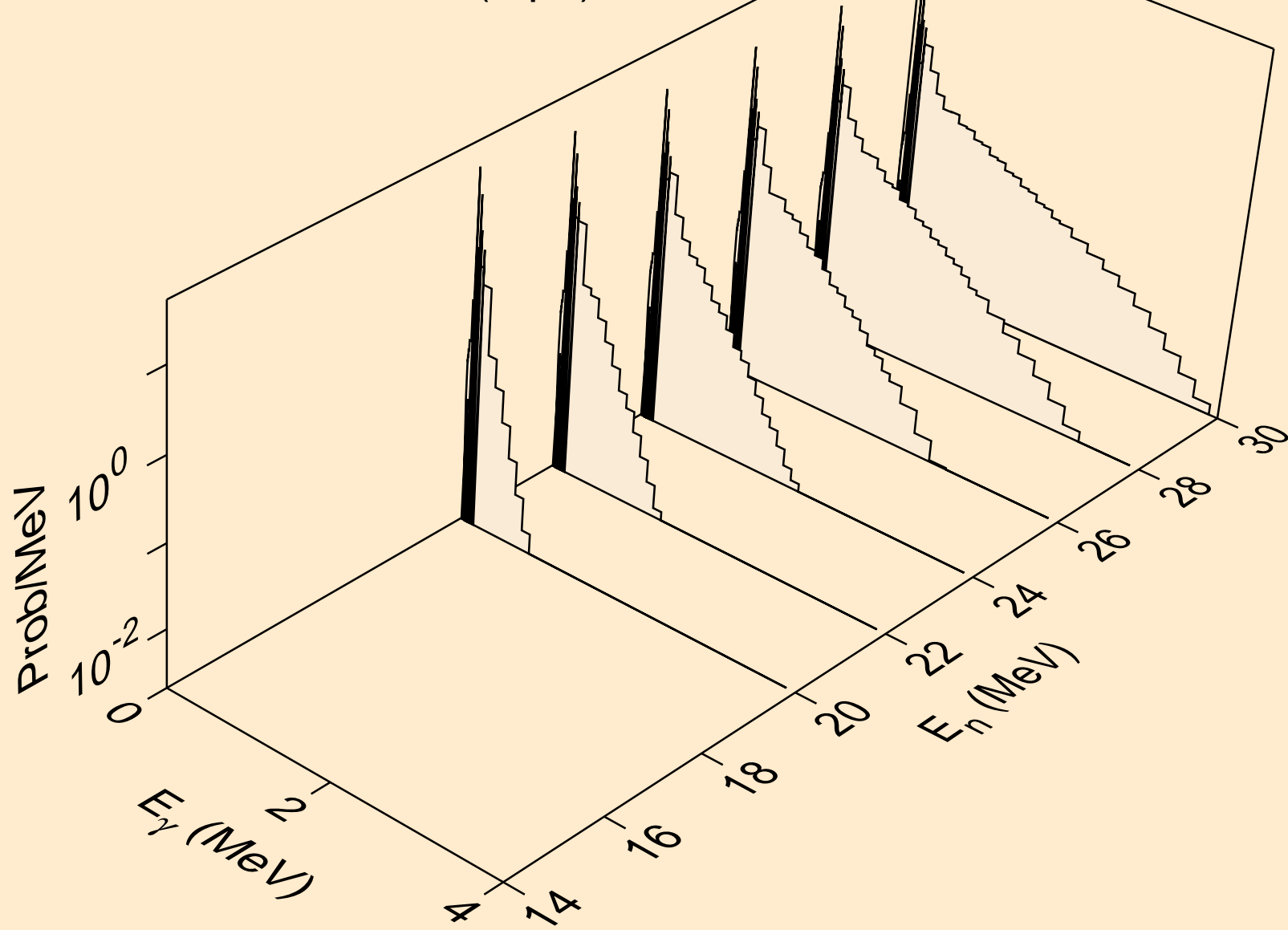

XE124 PROTON ACER TENDL-2023 LIBRARY; T=0.K
Photon emission for (n,pt)

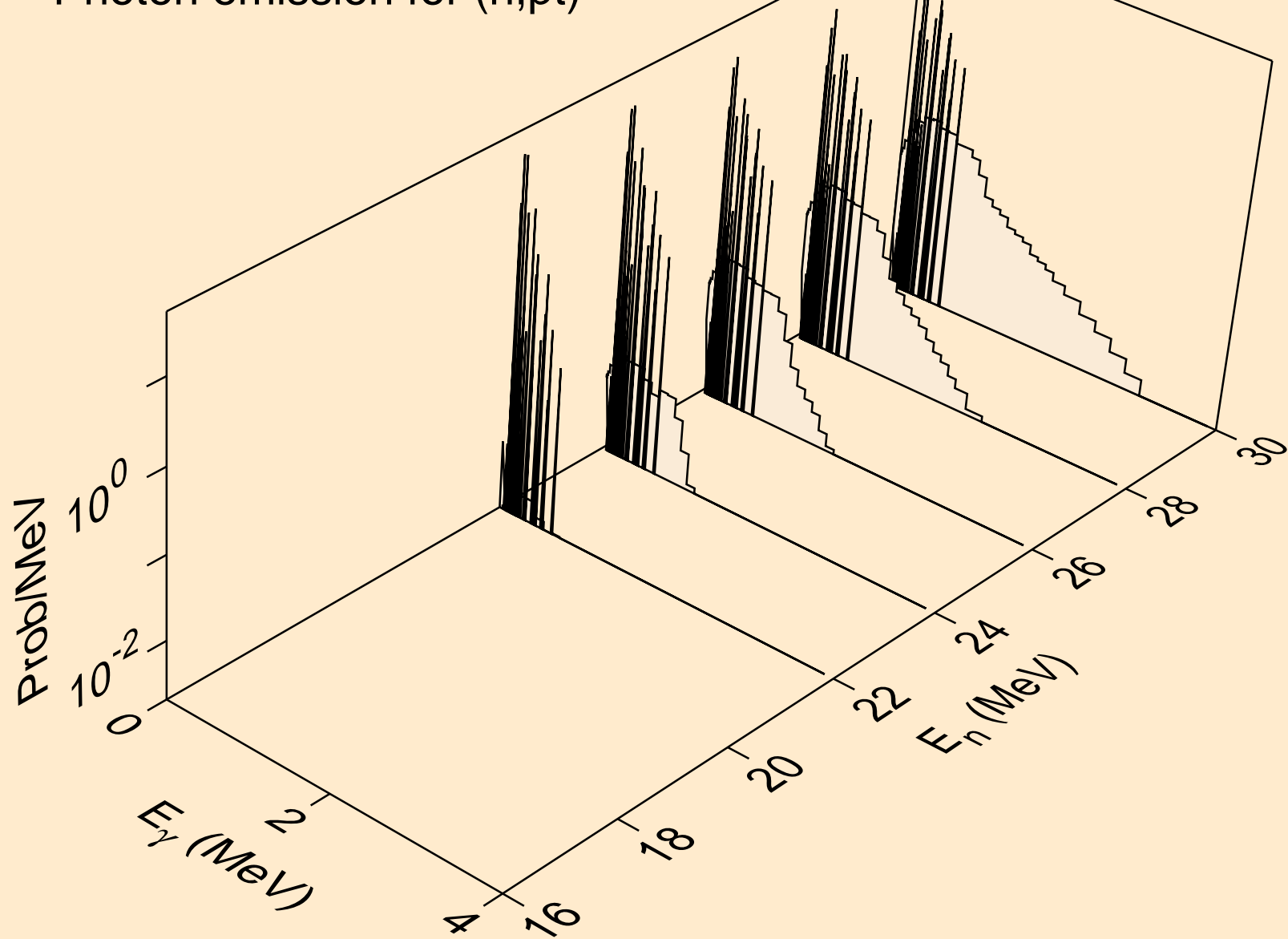

XE124 PROTON ACER TENDL-2023 LIBRARY; T=0.K
Photon emission for (n,da)

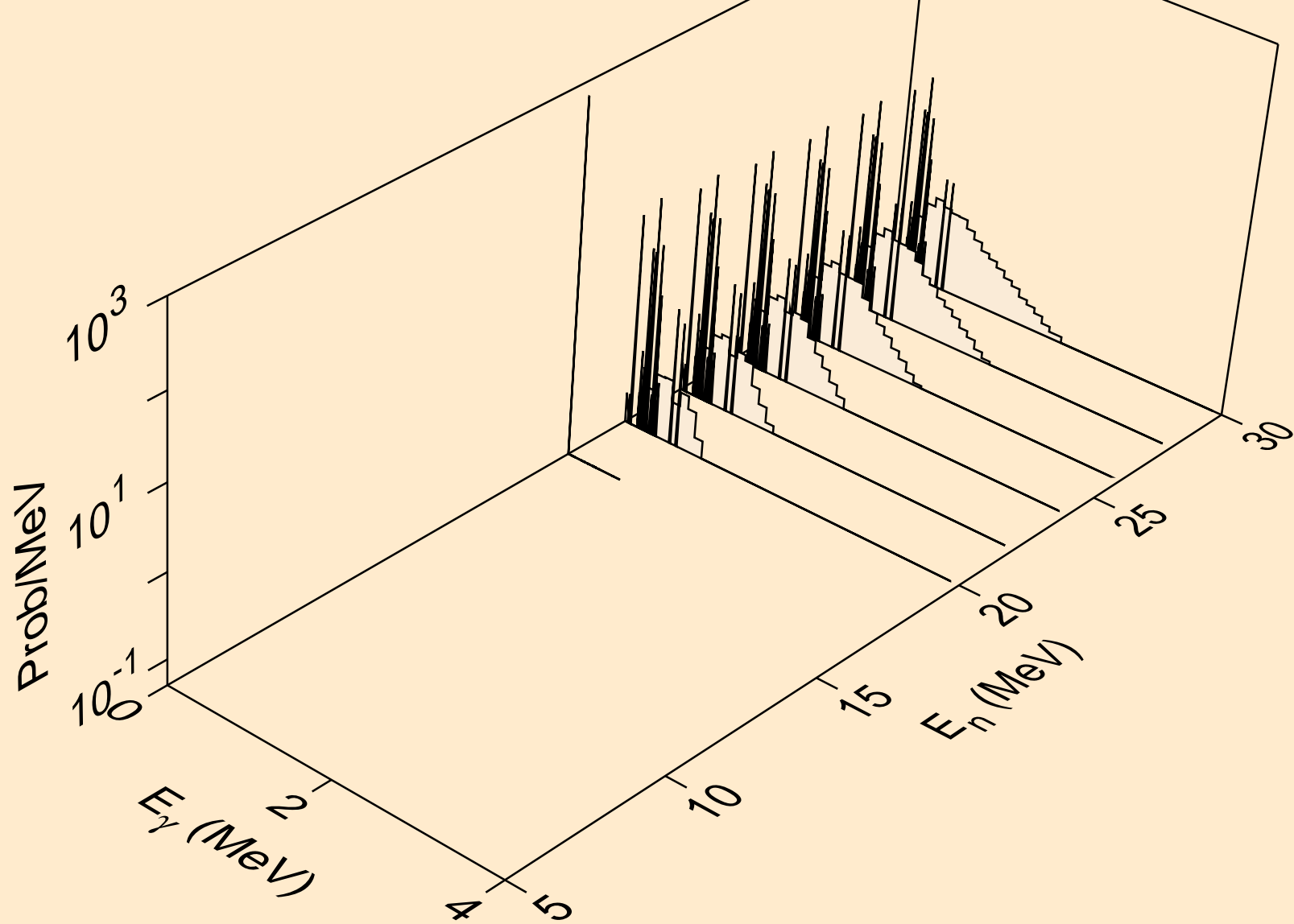

XE124 PROTON ACER TENDL-2023 LIBRARY; T=0.K
Particle heating contributions

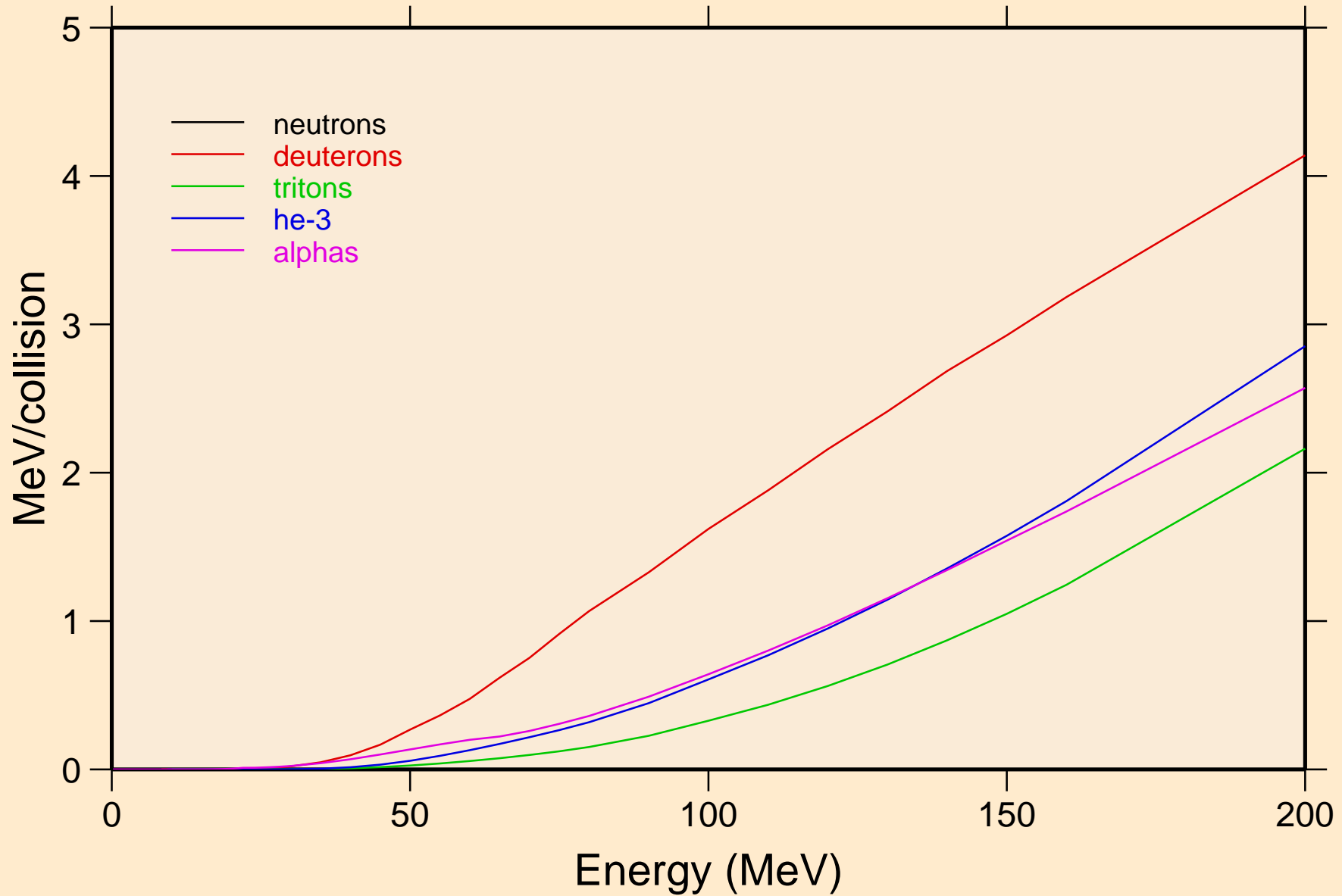

XE124 PROTON ACER TENDL-2023 LIBRARY; T=0.K

Recoil Heating

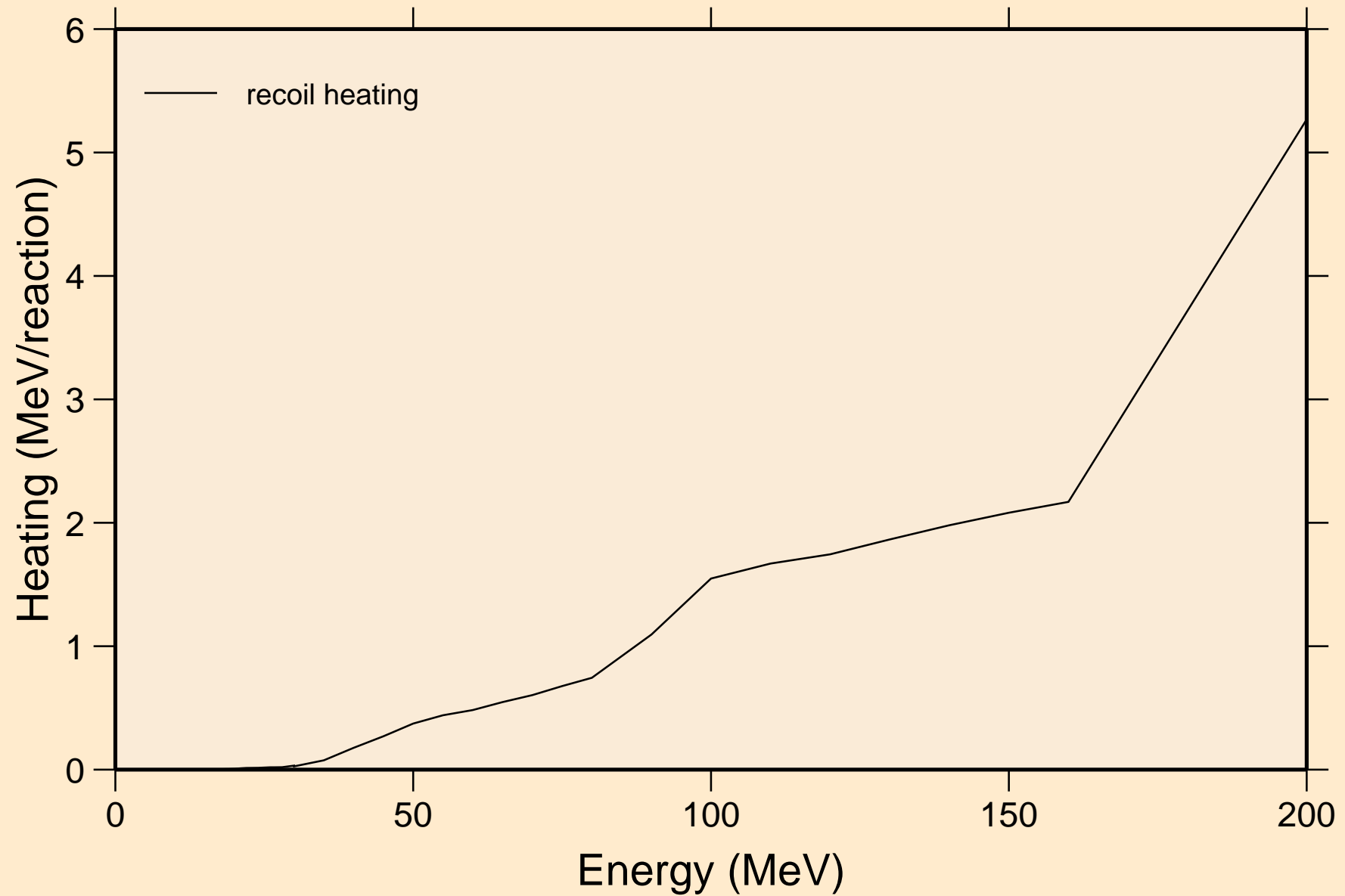

XE124 PROTON ACER TENDL-2023 LIBRARY; T=0.K
Particle production cross sections

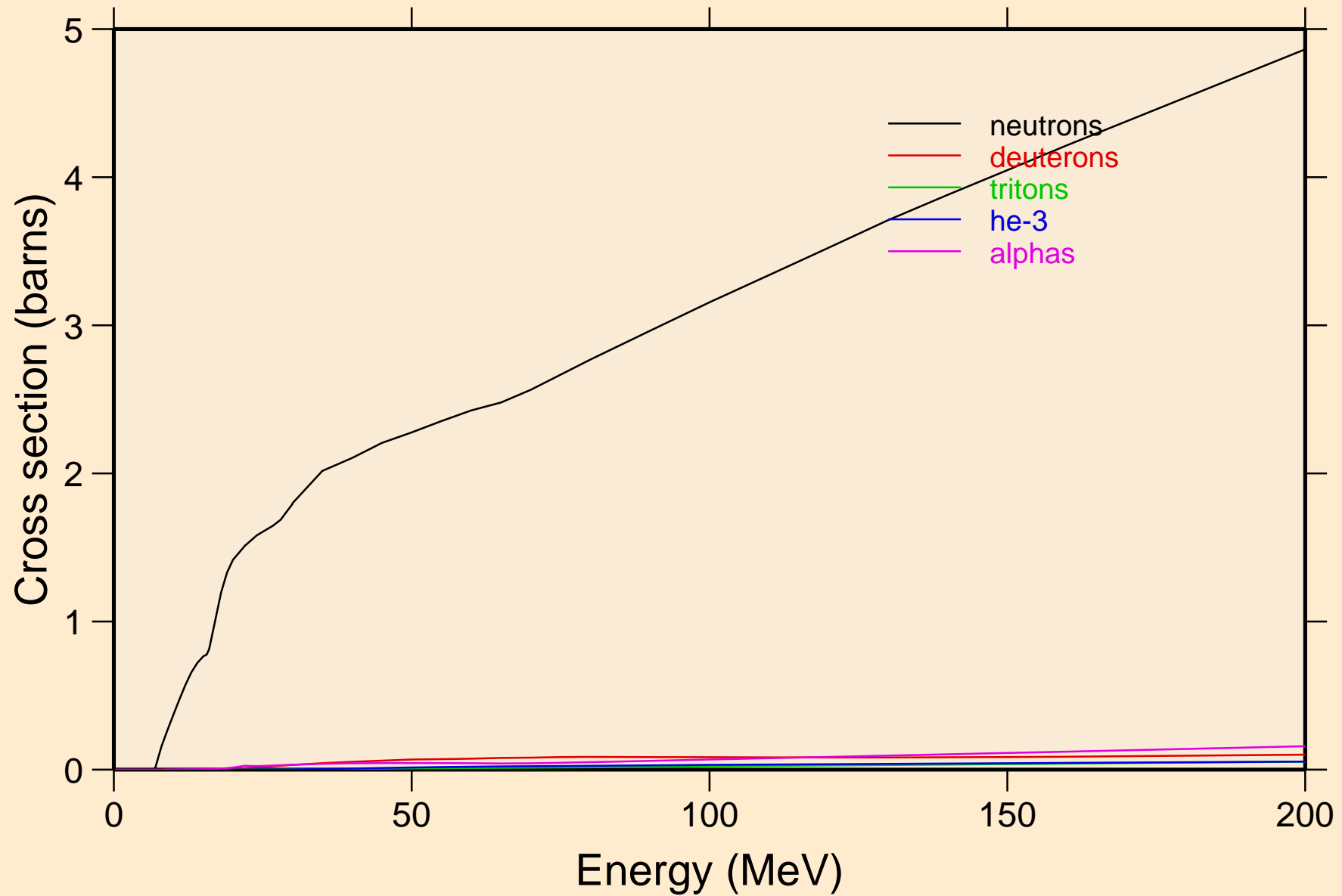

XE124 PROTON ACER TENDL-2023 LIBRARY; T=0.K
neutrons from (p,n)

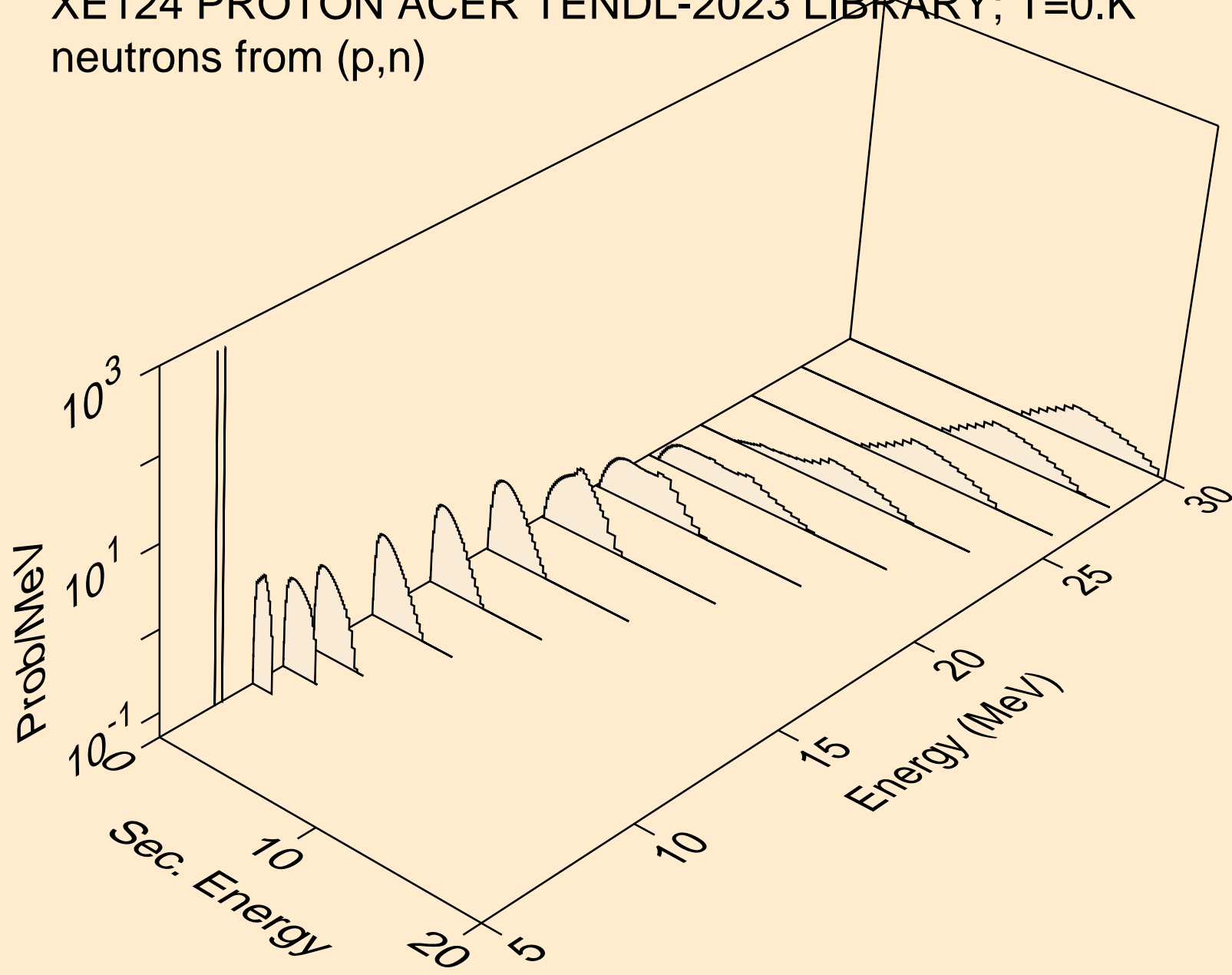

XE124 PROTON ACER TENDL-2023 LIBRARY; T=0.K
neutrons from (p,x)

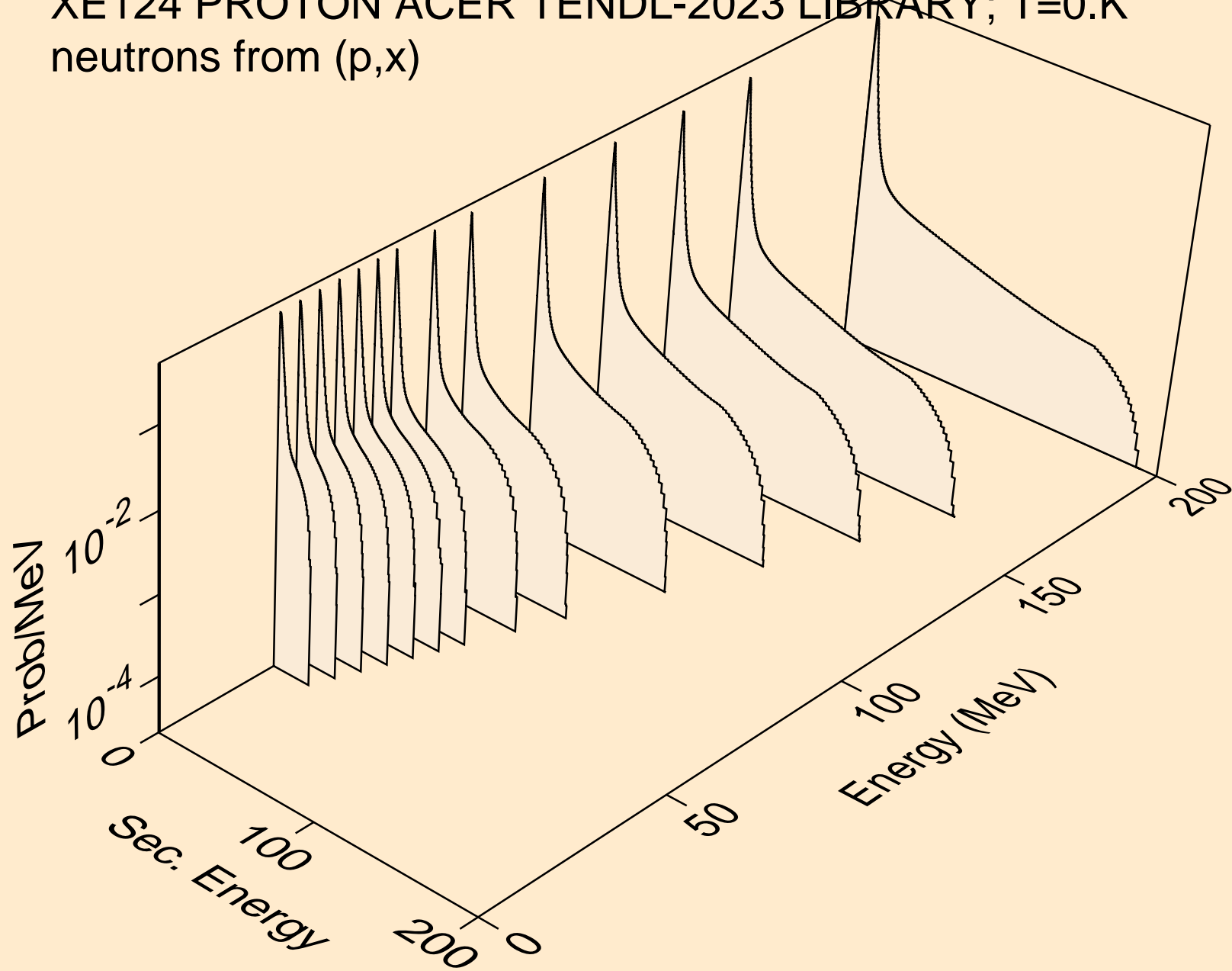

XE124 PROTON ACER TENDL-2023 LIBRARY; T=0.K
neutrons from (p,2n)

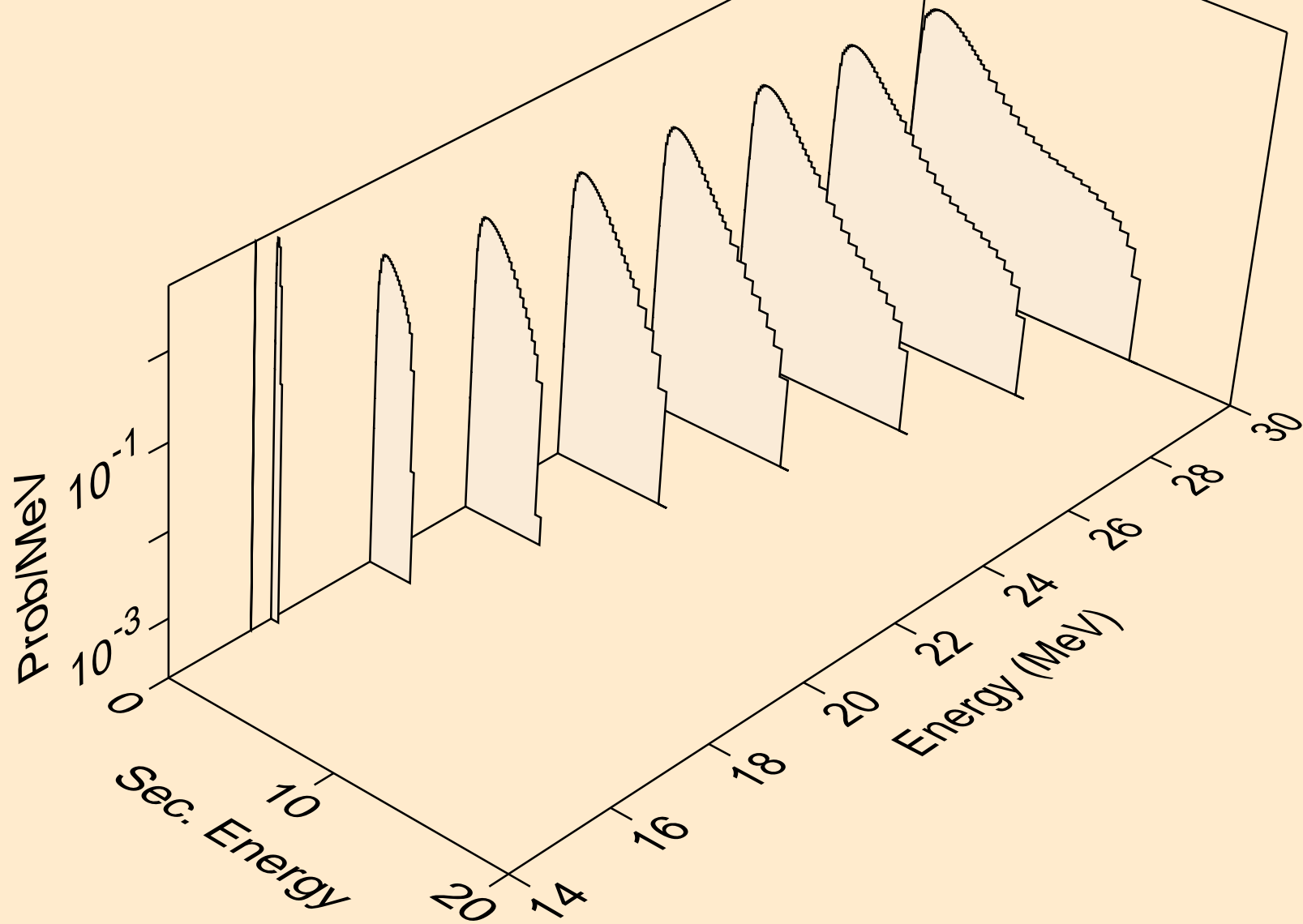

XE124 PROTON ACER TENDL-2023 LIBRARY; T=0.K
neutrons from (p,3n)

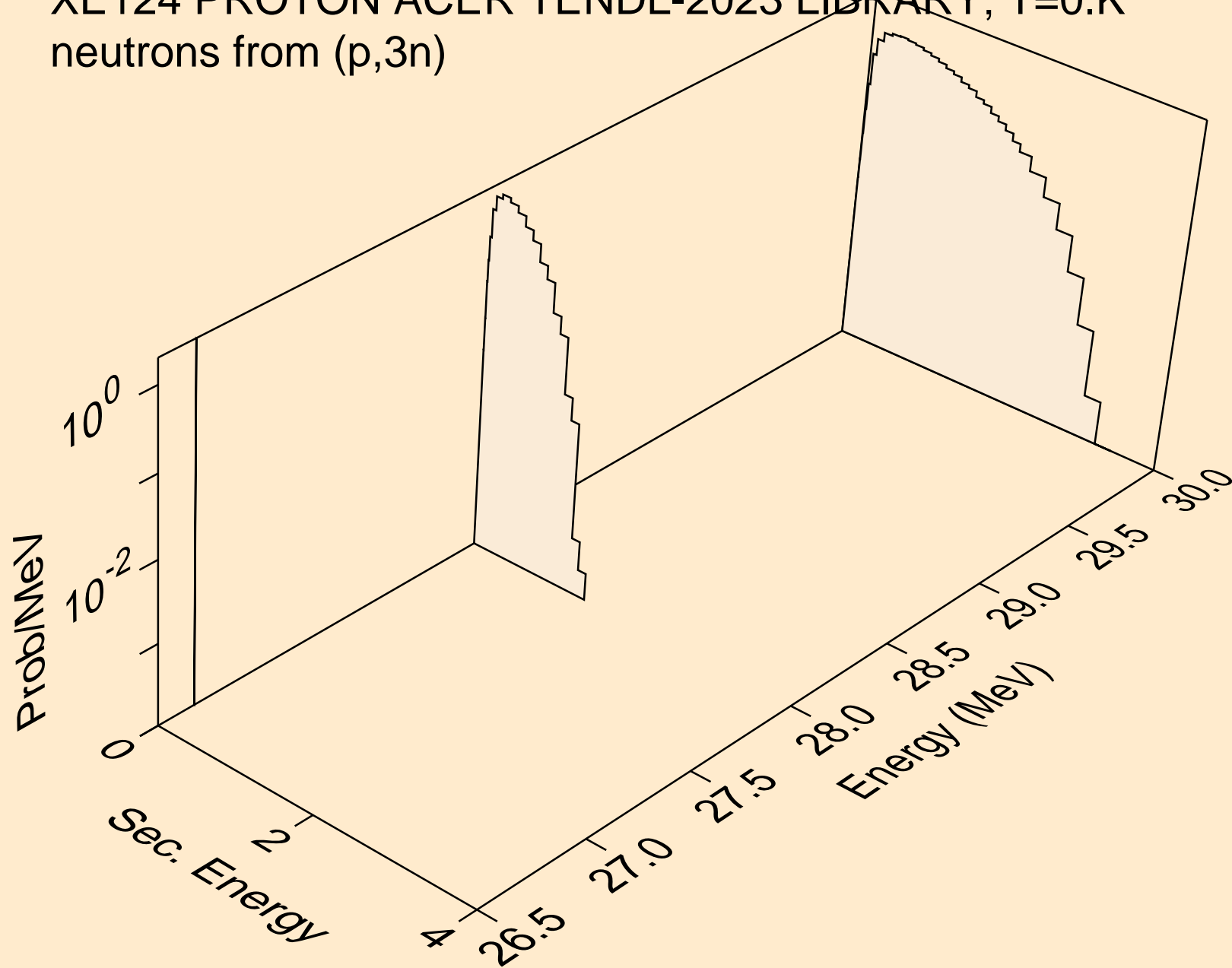

XE124 PROTON ACER TENDL-2023 LIBRARY; T=0.K
neutrons from (p,n*)a

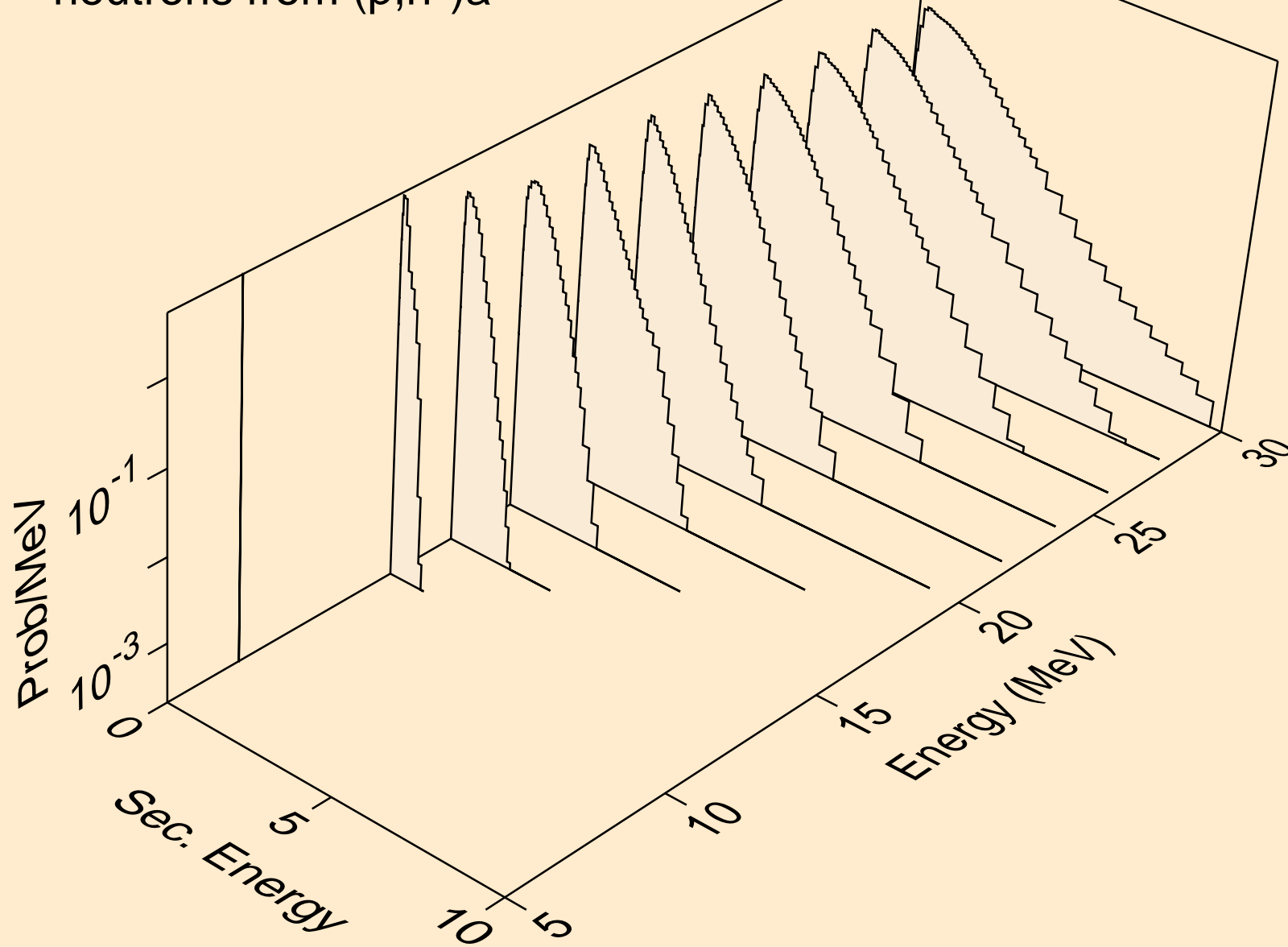

XE124 PROTON ACER TENDL-2023 LIBRARY; T=0.K
neutrons from (p,2n)a

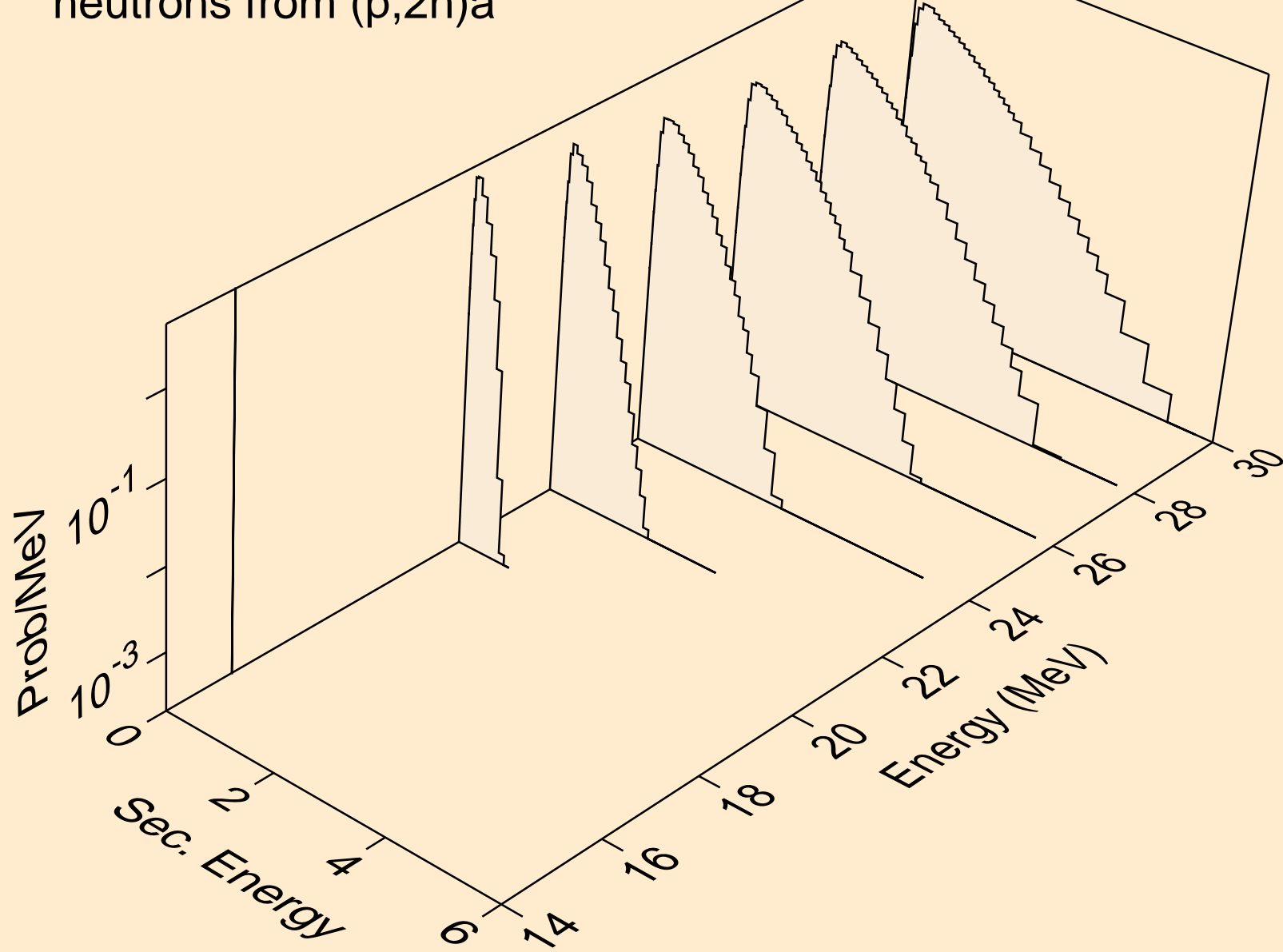

XE124 PROTON ACER TENDL-2023 LIBRARY; T=0.K
neutrons from (p,n*)p

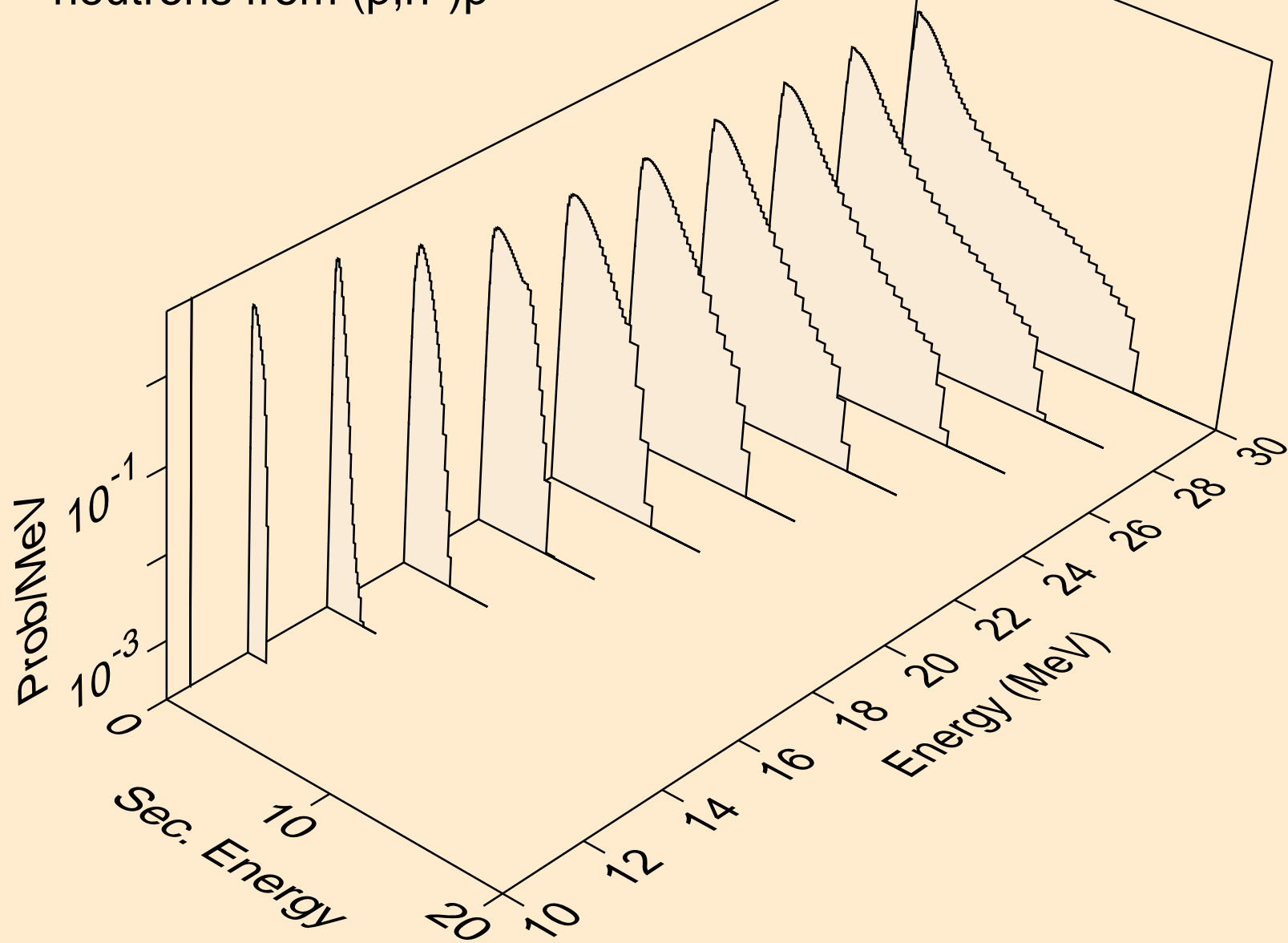

XE124 PROTON ACER TENDL-2023 LIBRARY; T=0.K
neutrons from (p,n*)2a

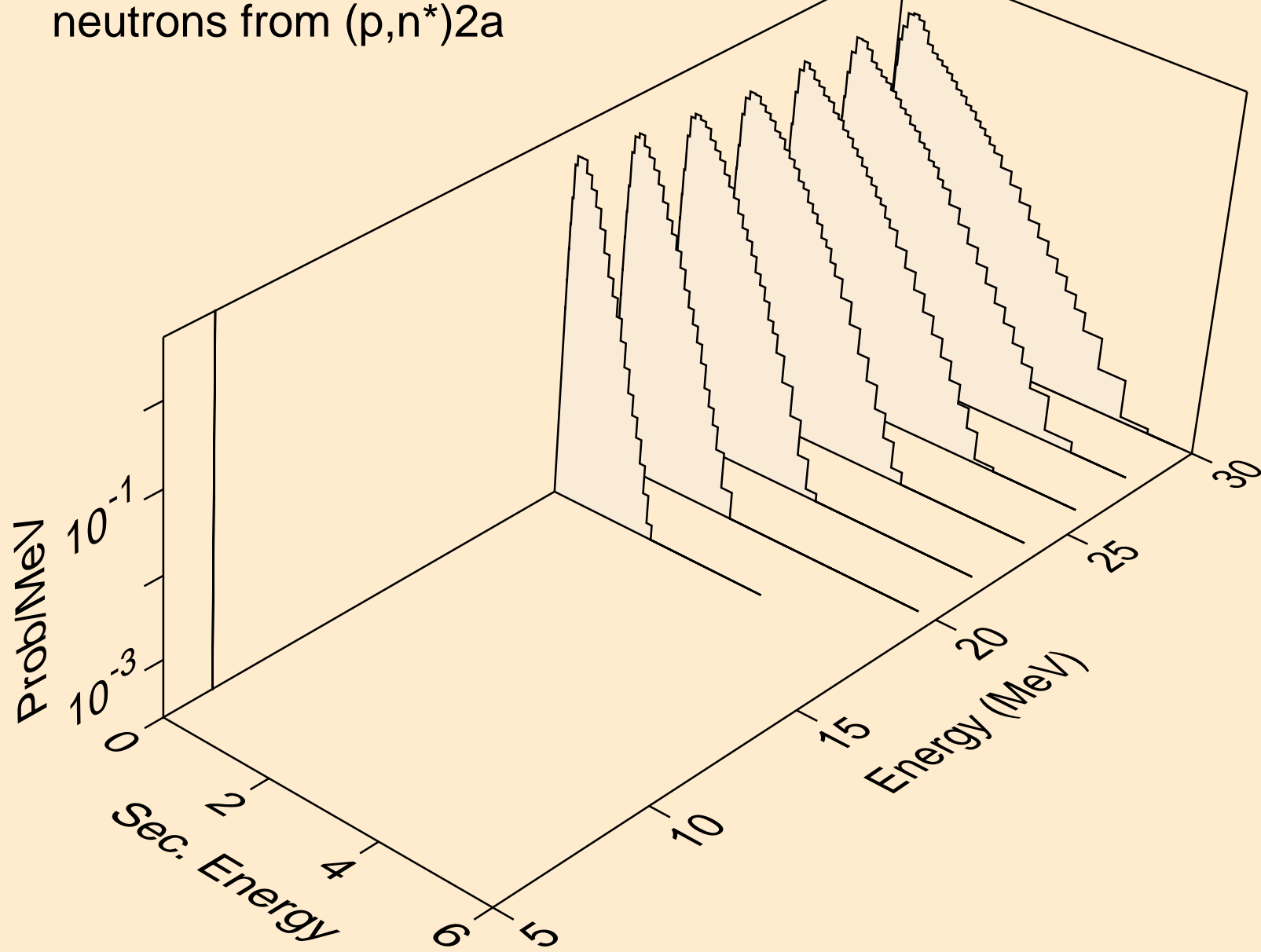

XE124 PROTON ACER TENDL-2023 LIBRARY; T=0.K
neutrons from (p,n*)d

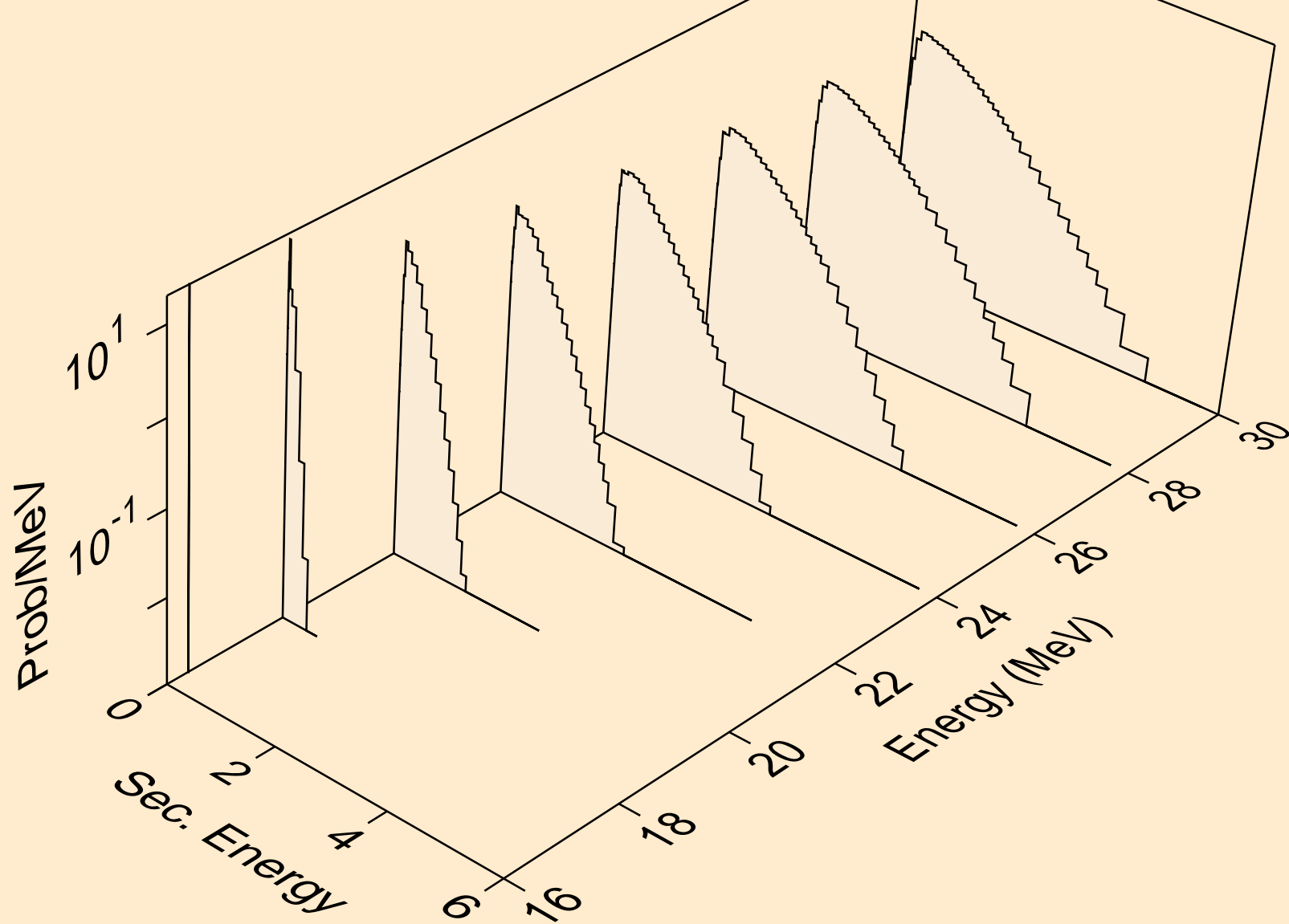

XE124 PROTON ACER TENDL-2023 LIBRARY; T=0.K
neutrons from (p,n*)t

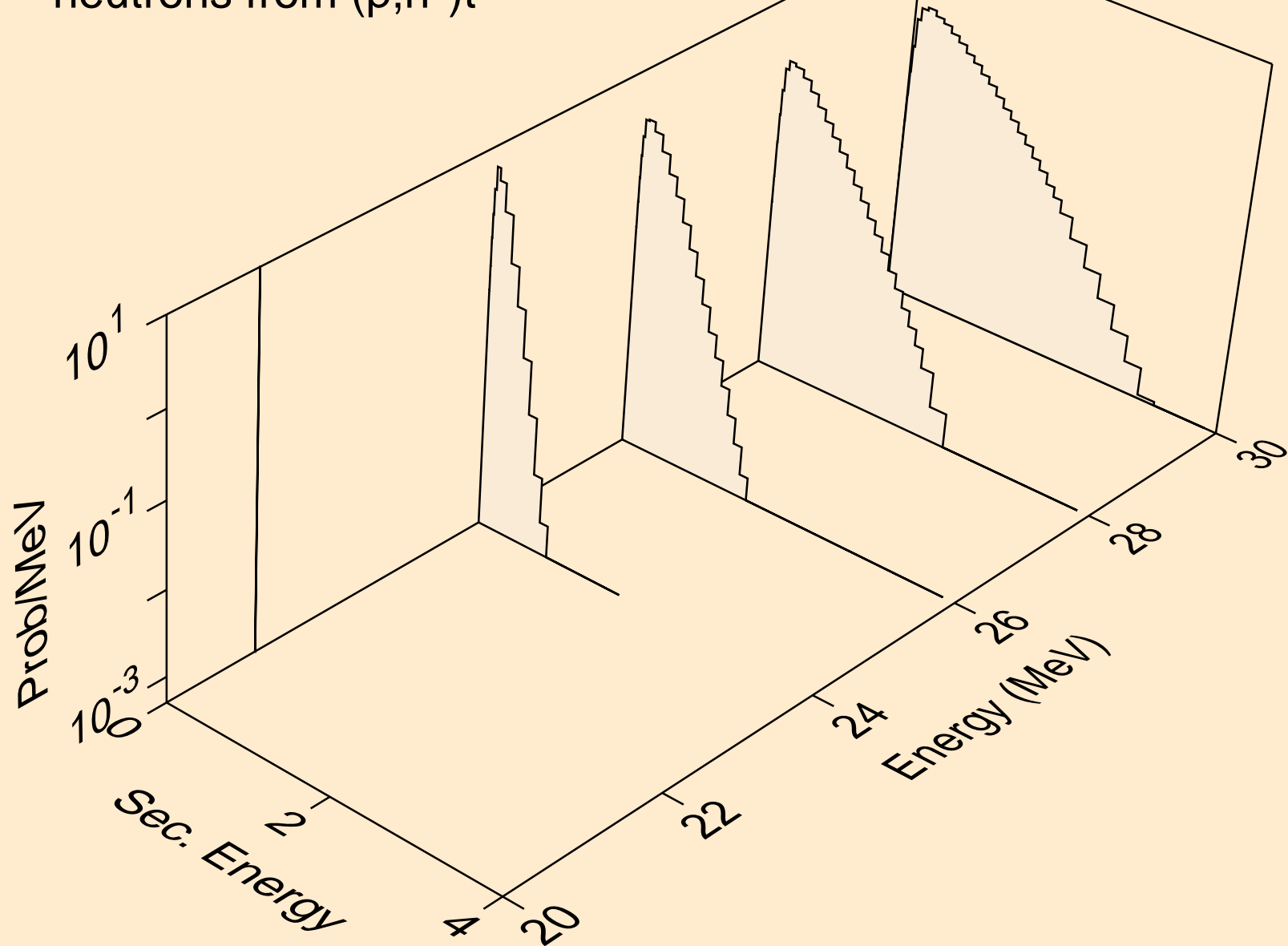

XE124 PROTON ACER TENDL-2023 LIBRARY; T=0.K
neutrons from (p,n*)he3

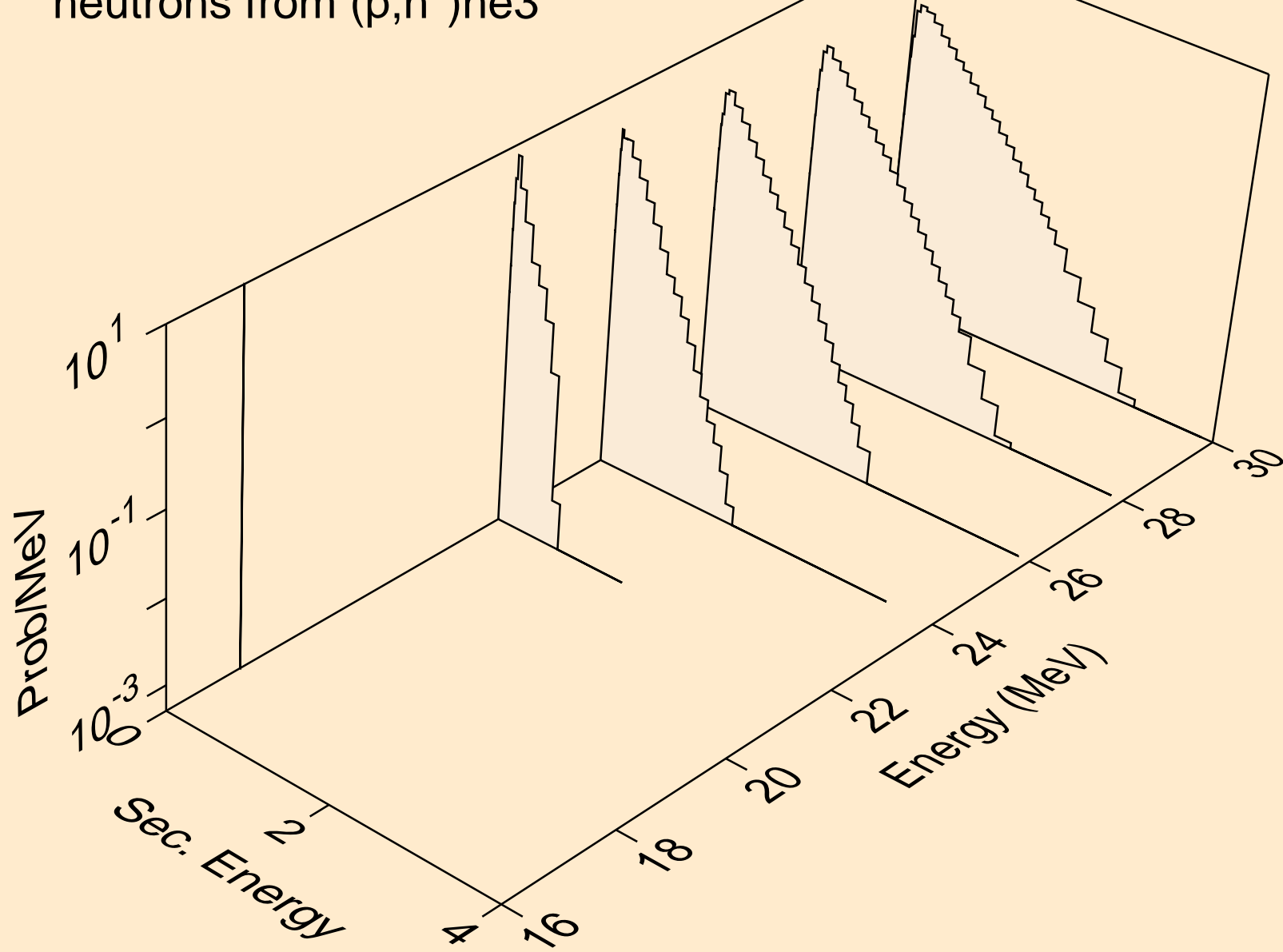

XE124 PROTON ACER TENDL-2023 LIBRARY; T=0.K
neutrons from (p,2np)

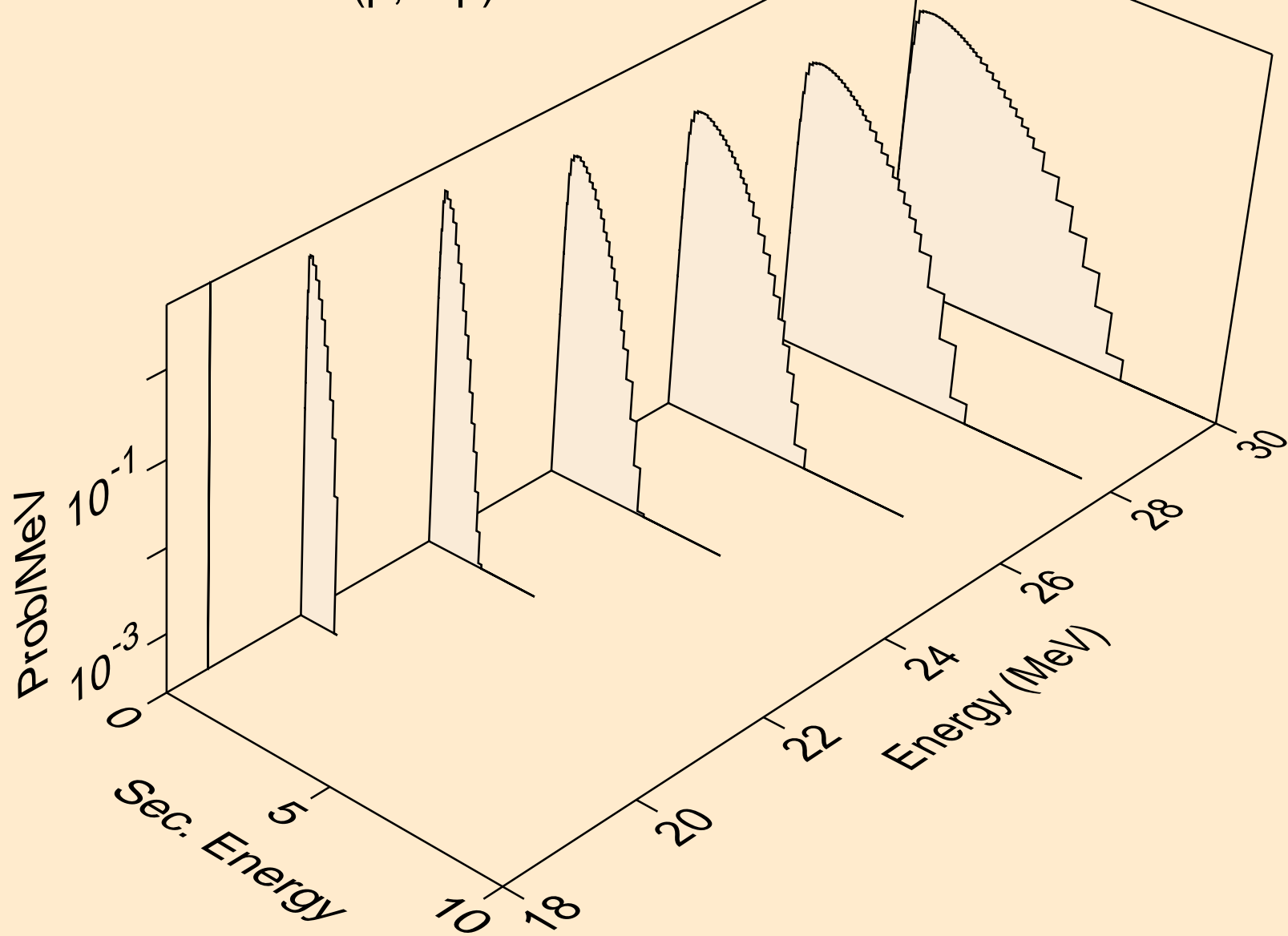

XE124 PROTON ACER TENDL-2023 LIBRARY; T=0.K
neutrons from (p,n2p)

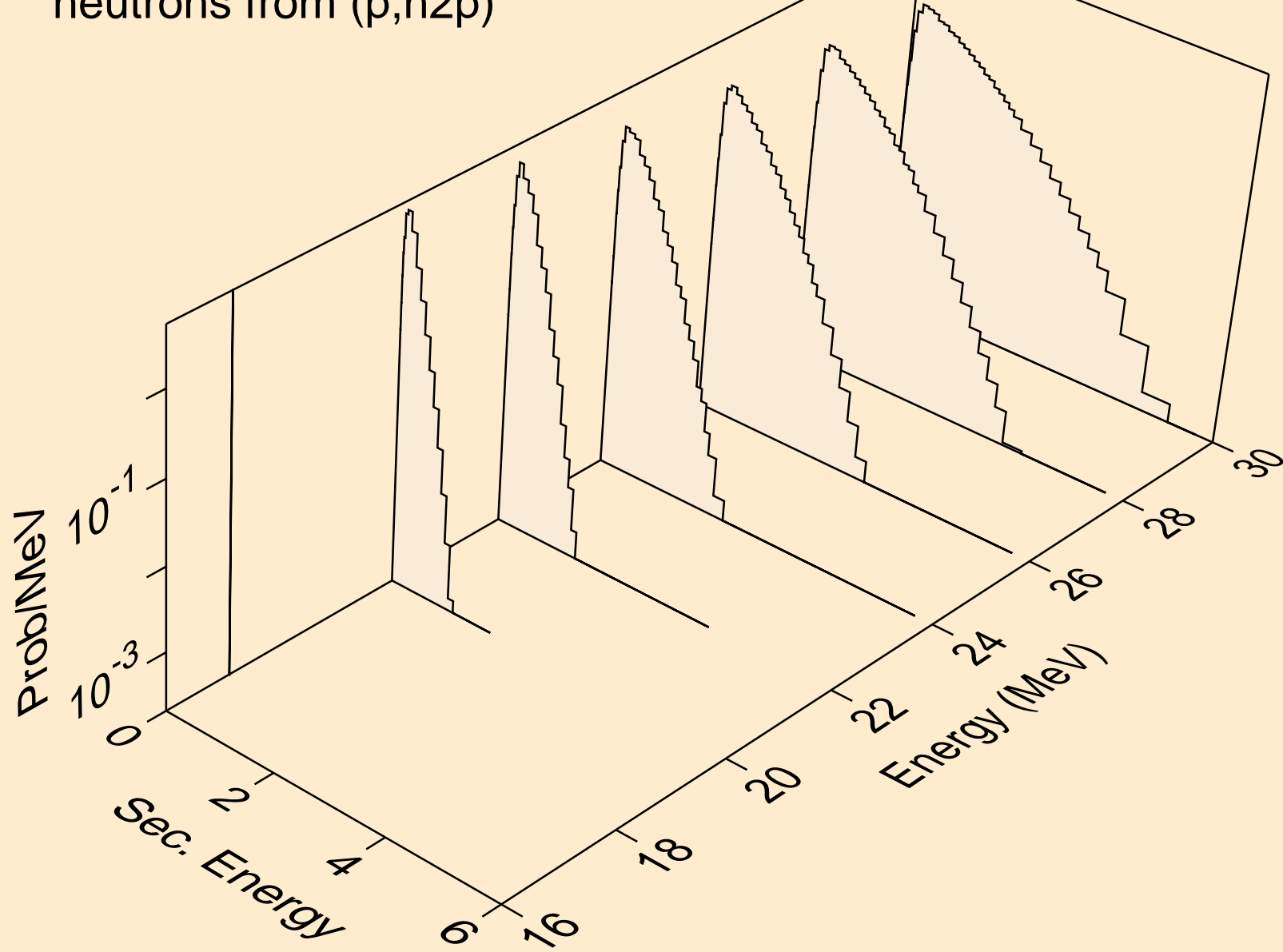

XE124 PROTON ACER TENDL-2023 LIBRARY; T=0.K
neutrons from (p,npa)

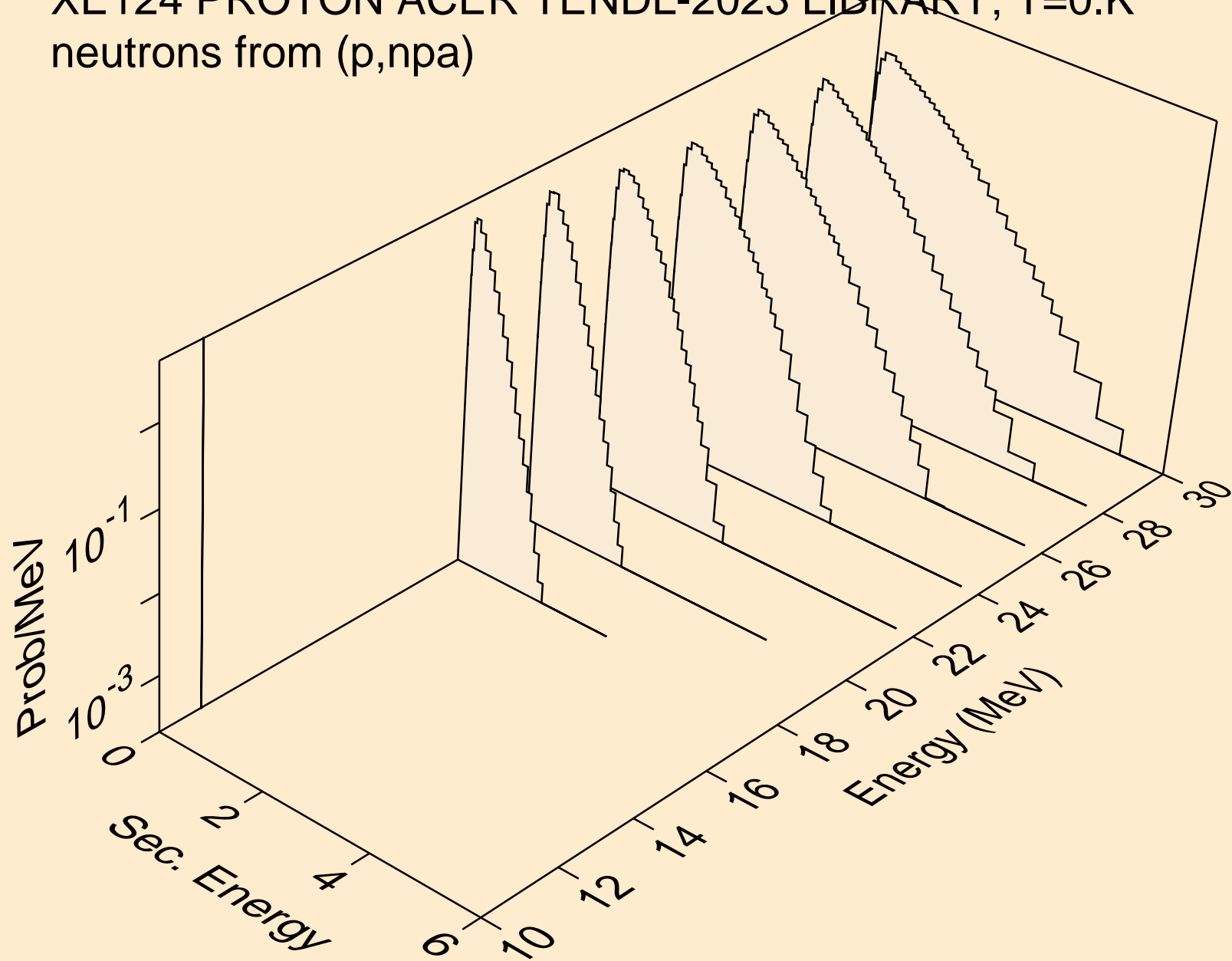

XE124 PROTON ACER TENDL-2023 LIBRARY; T=0.K
deuterons from (p,x)

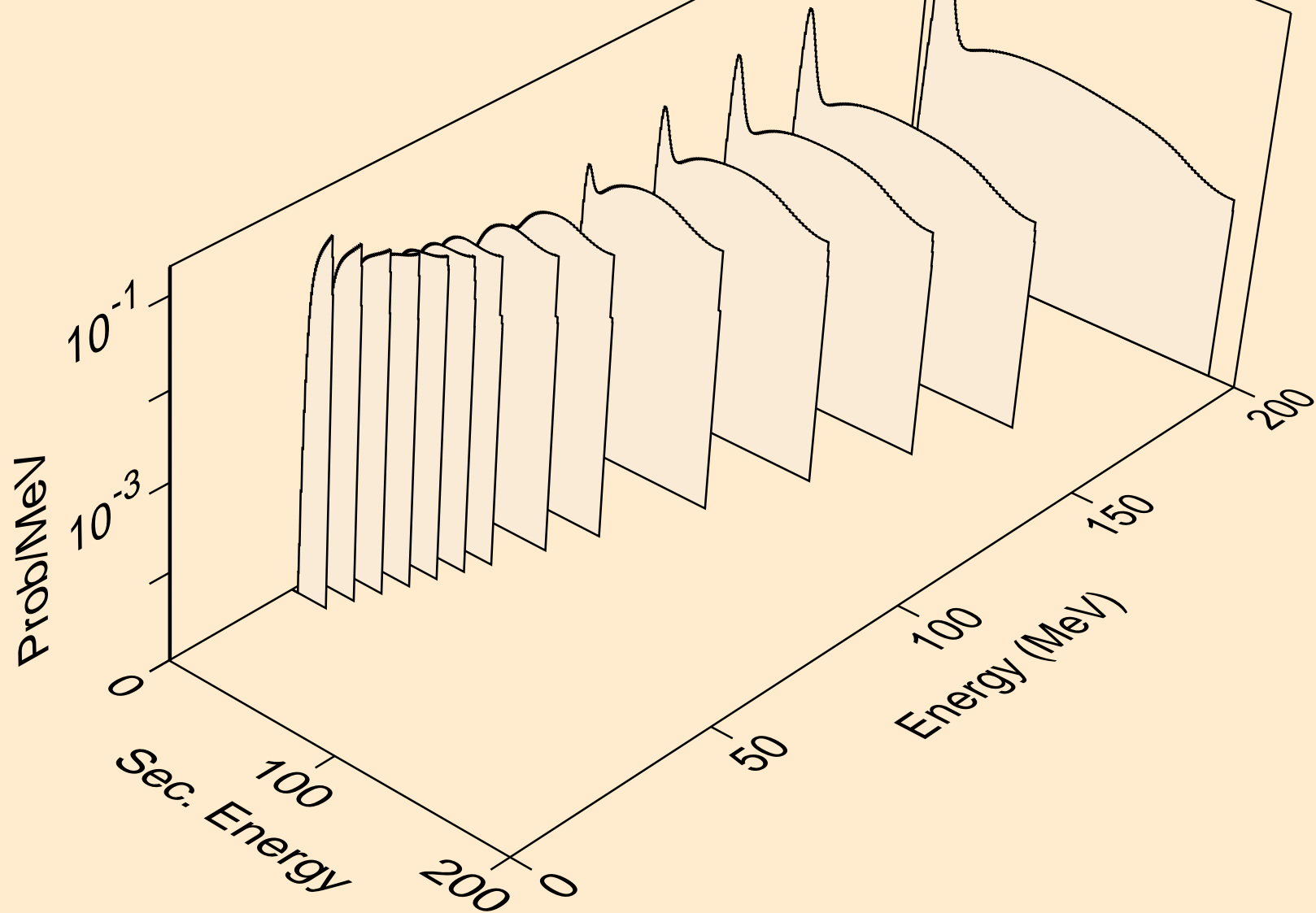

XE124 PROTON ACER TENDL-2023 LIBRARY; T=0.K
deuterons from (p,n*)d

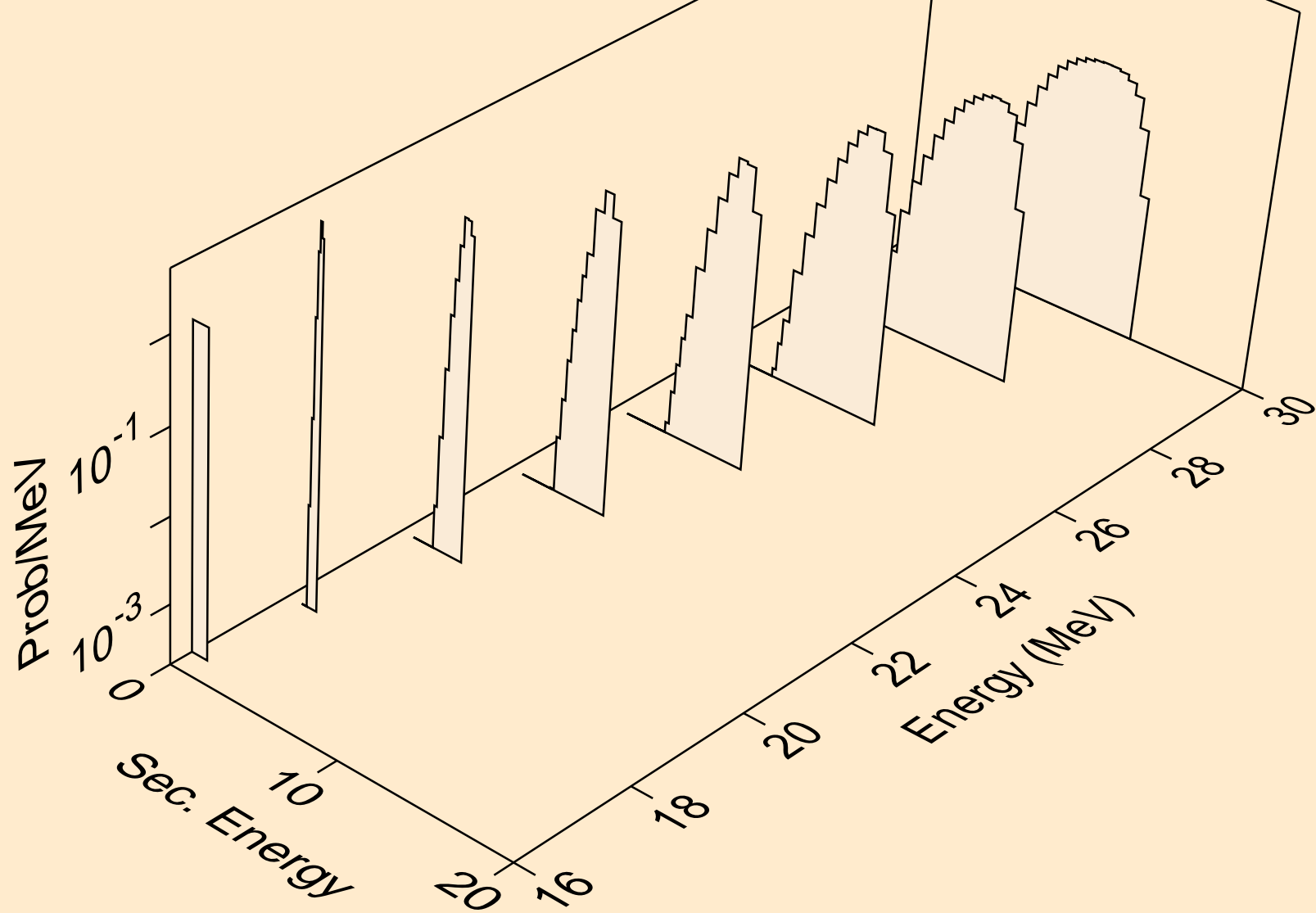

XE124 PROTON ACER TENDL-2023 LIBRARY; T=0.K
deuterons from (p,d)

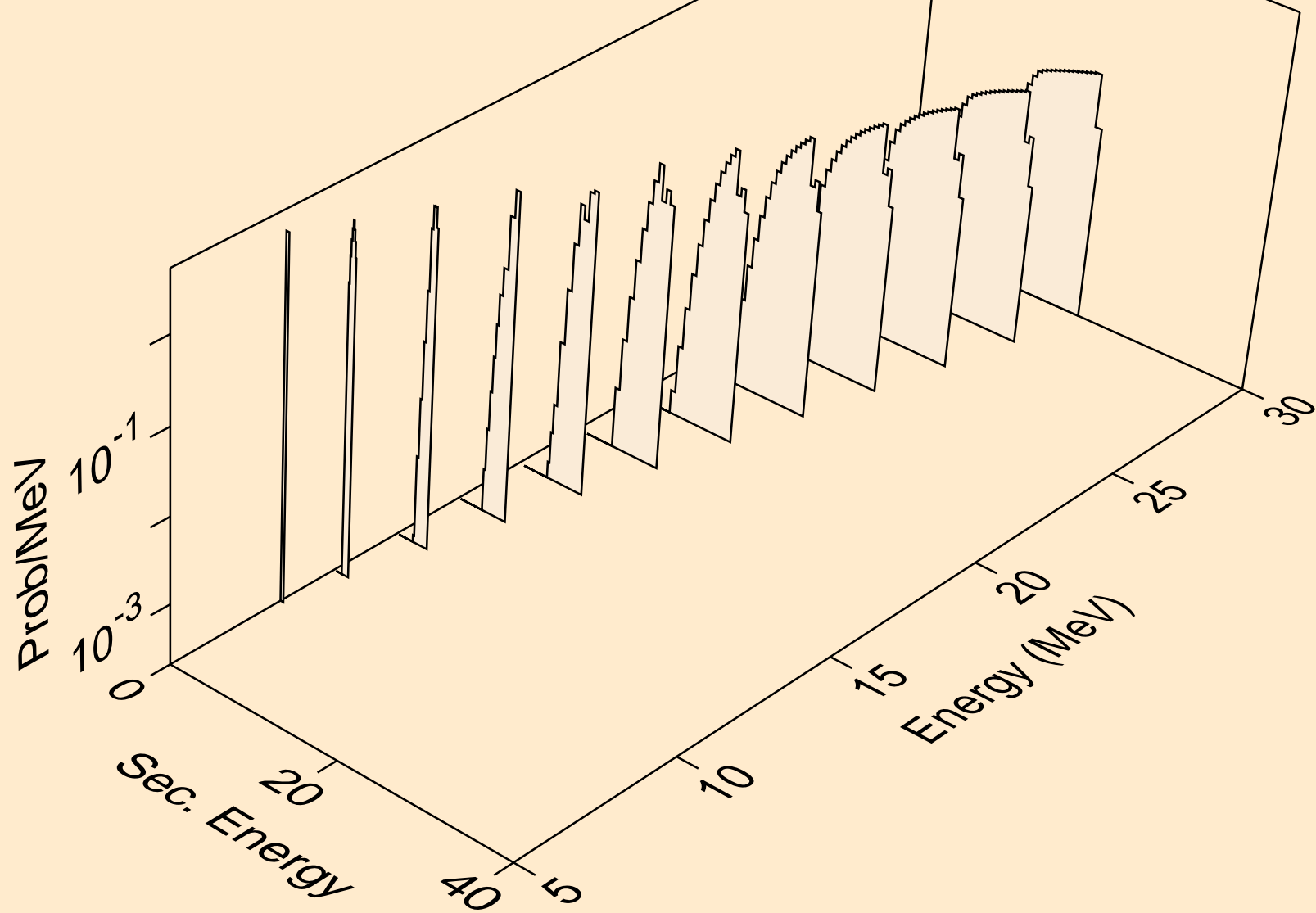

XE124 PROTON ACER TENDL-2023 LIBRARY; T=0.K
deuterons from (p,pd)

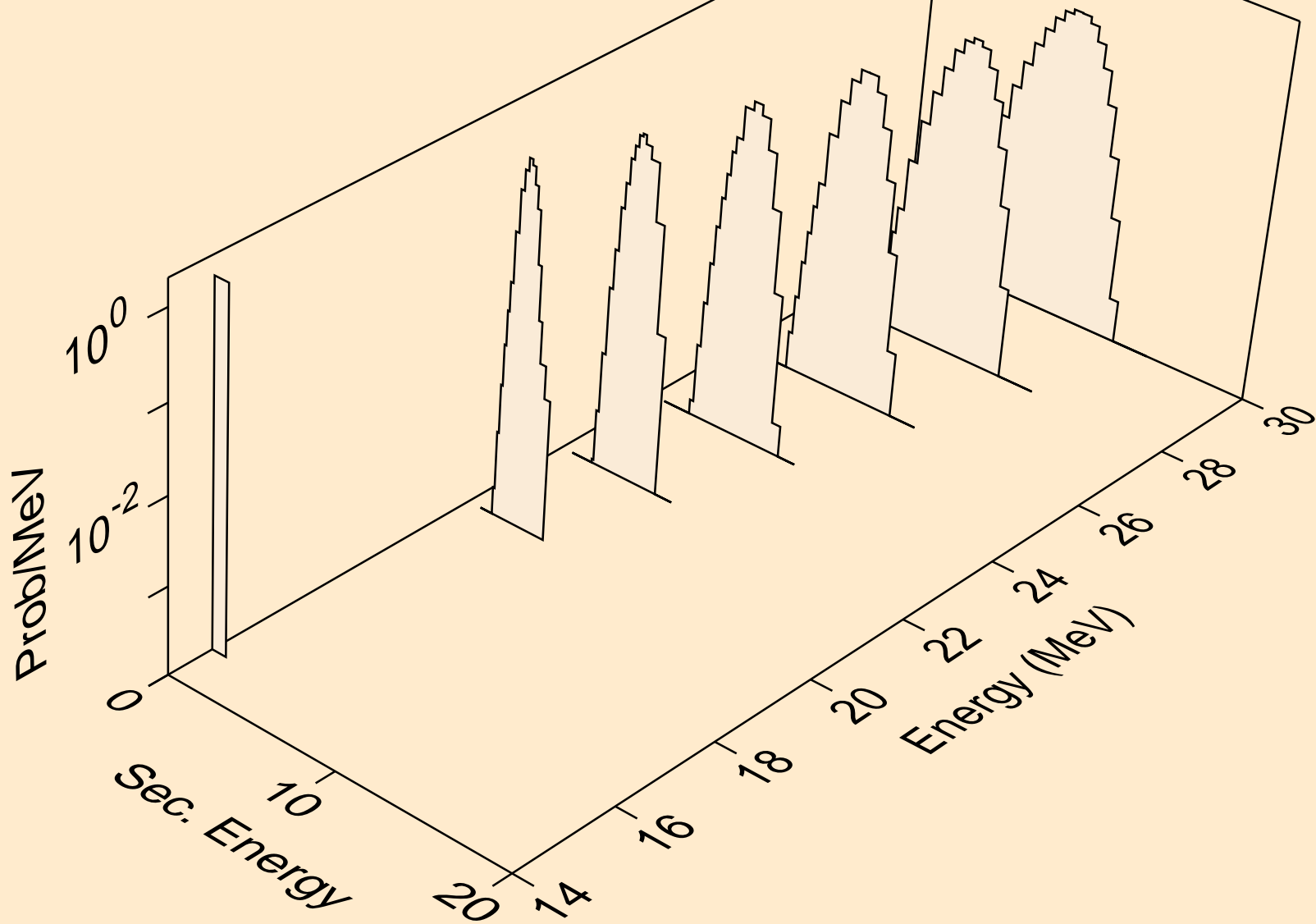

XE124 PROTON ACER TENDL-2023 LIBRARY; T=0.K
deuterons from (p,da)

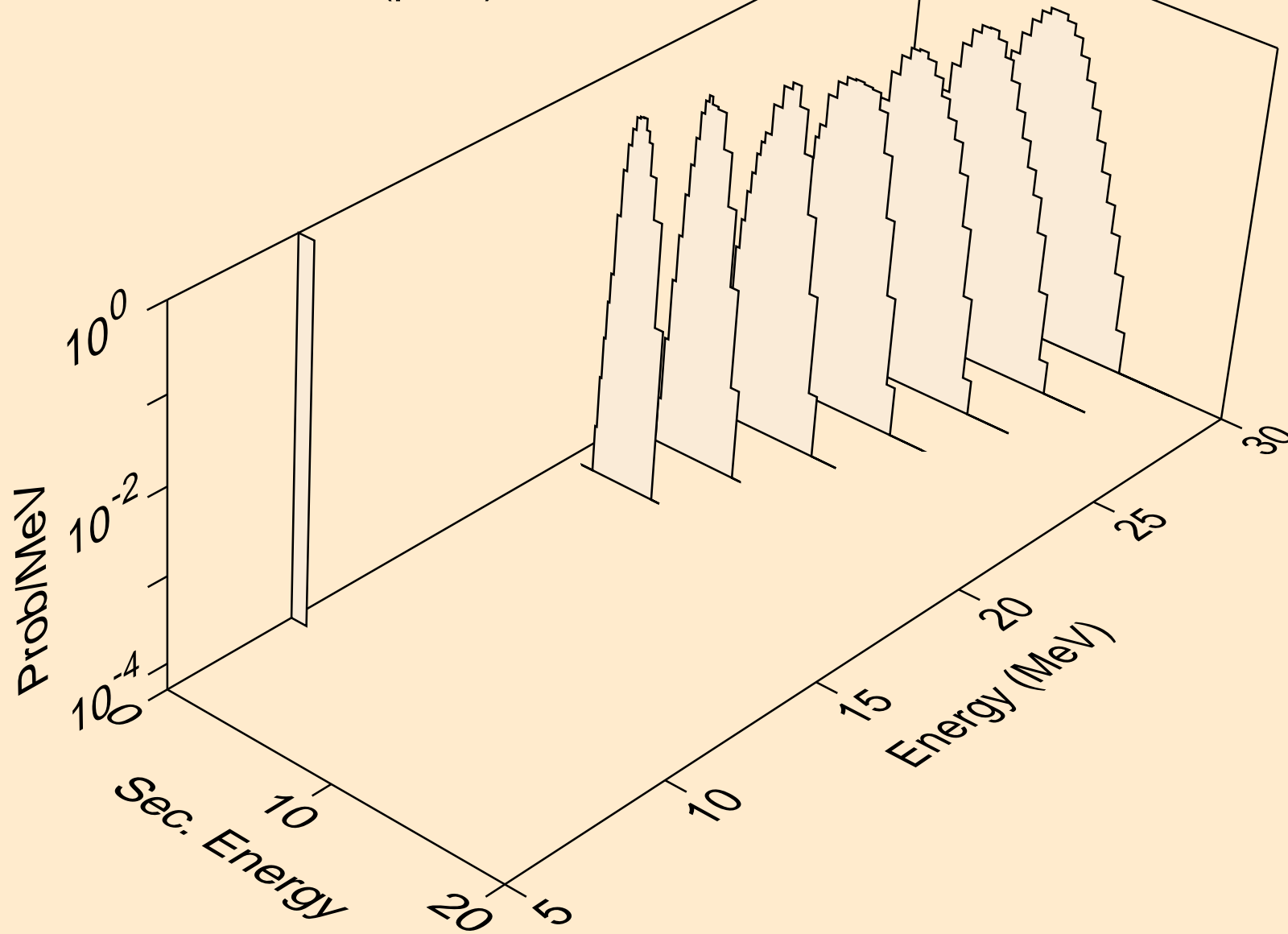

XE124 PROTON ACER TENDL-2023 LIBRARY; T=0.K
tritons from (p,x)

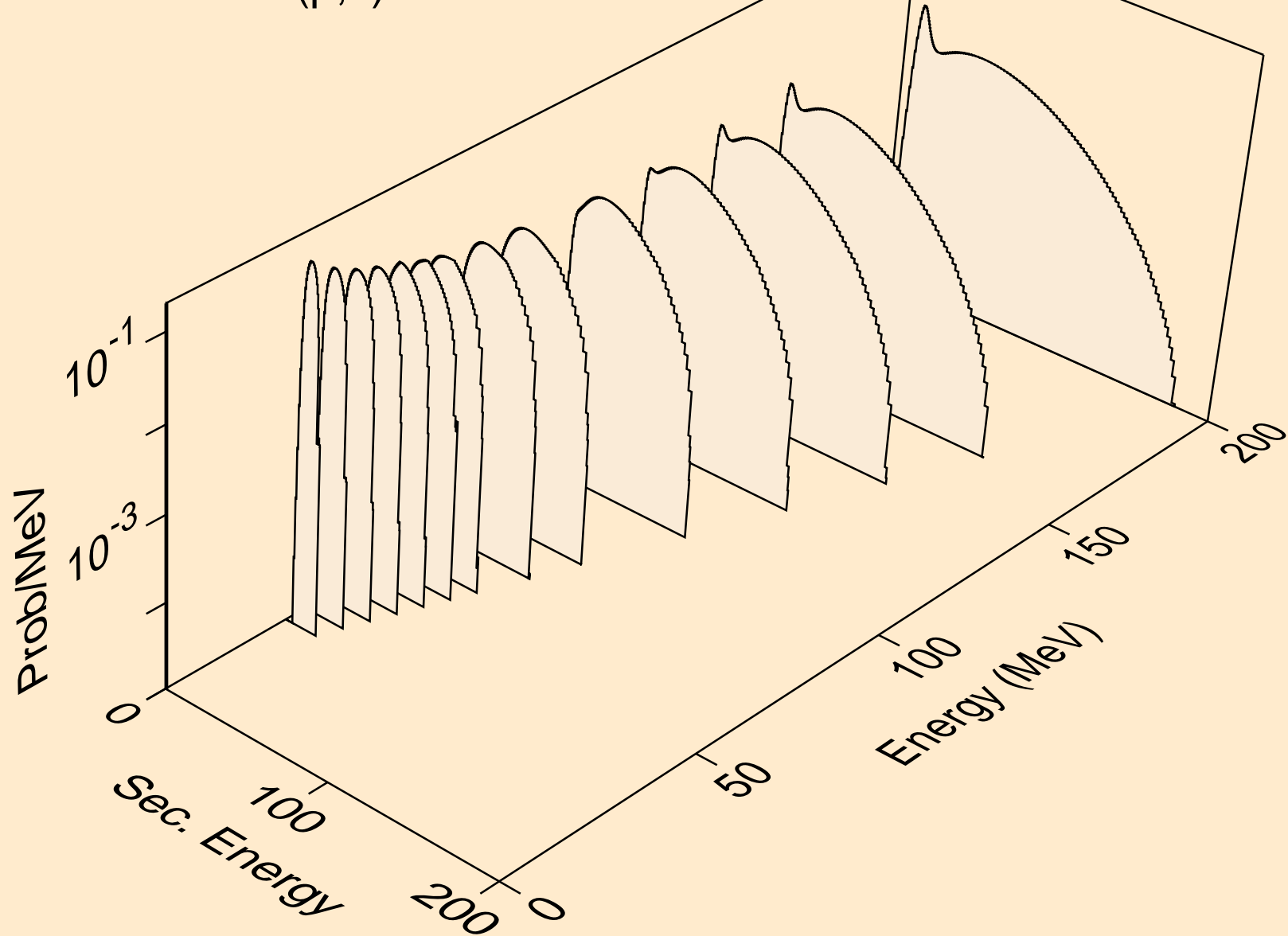

XE124 PROTON ACER TENDL-2023 LIBRARY; T=0.K
tritons from (p,n*)t

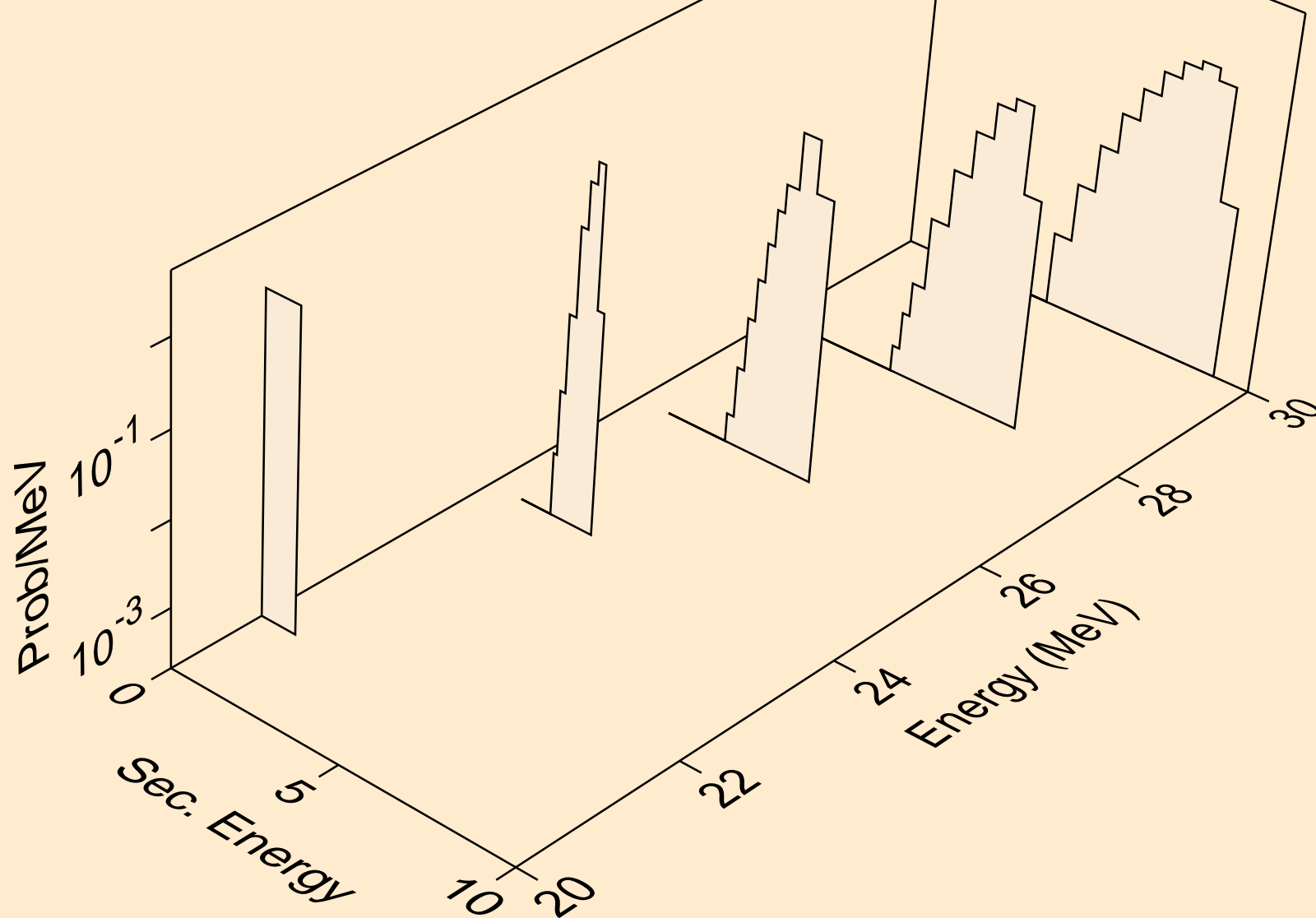

XE124 PROTON ACER TENDL-2023 LIBRARY; T=0.K
tritons from (p,t)

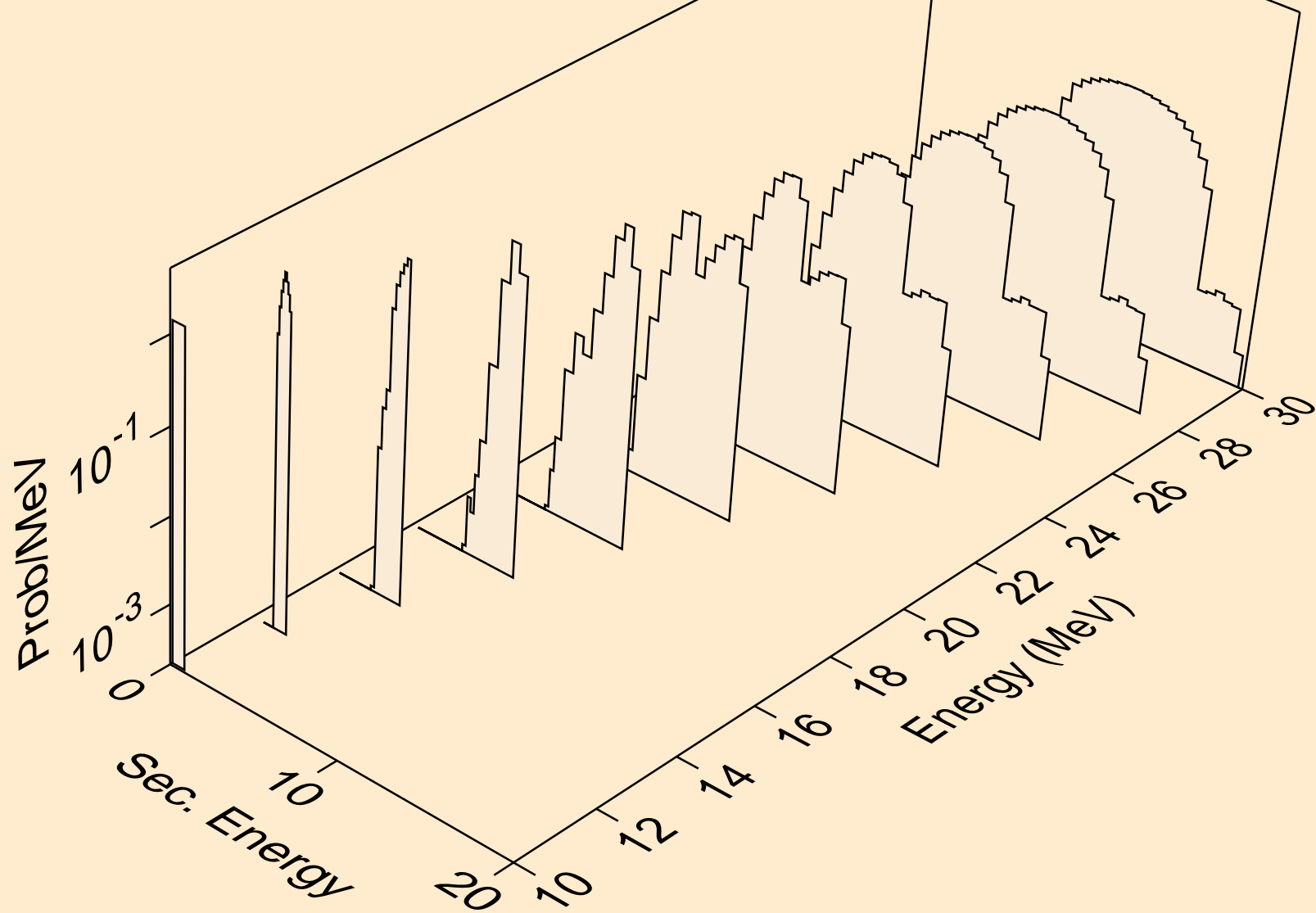

XE124 PROTON ACER TENDL-2023 LIBRARY; T=0.K
tritons from (p,pt)

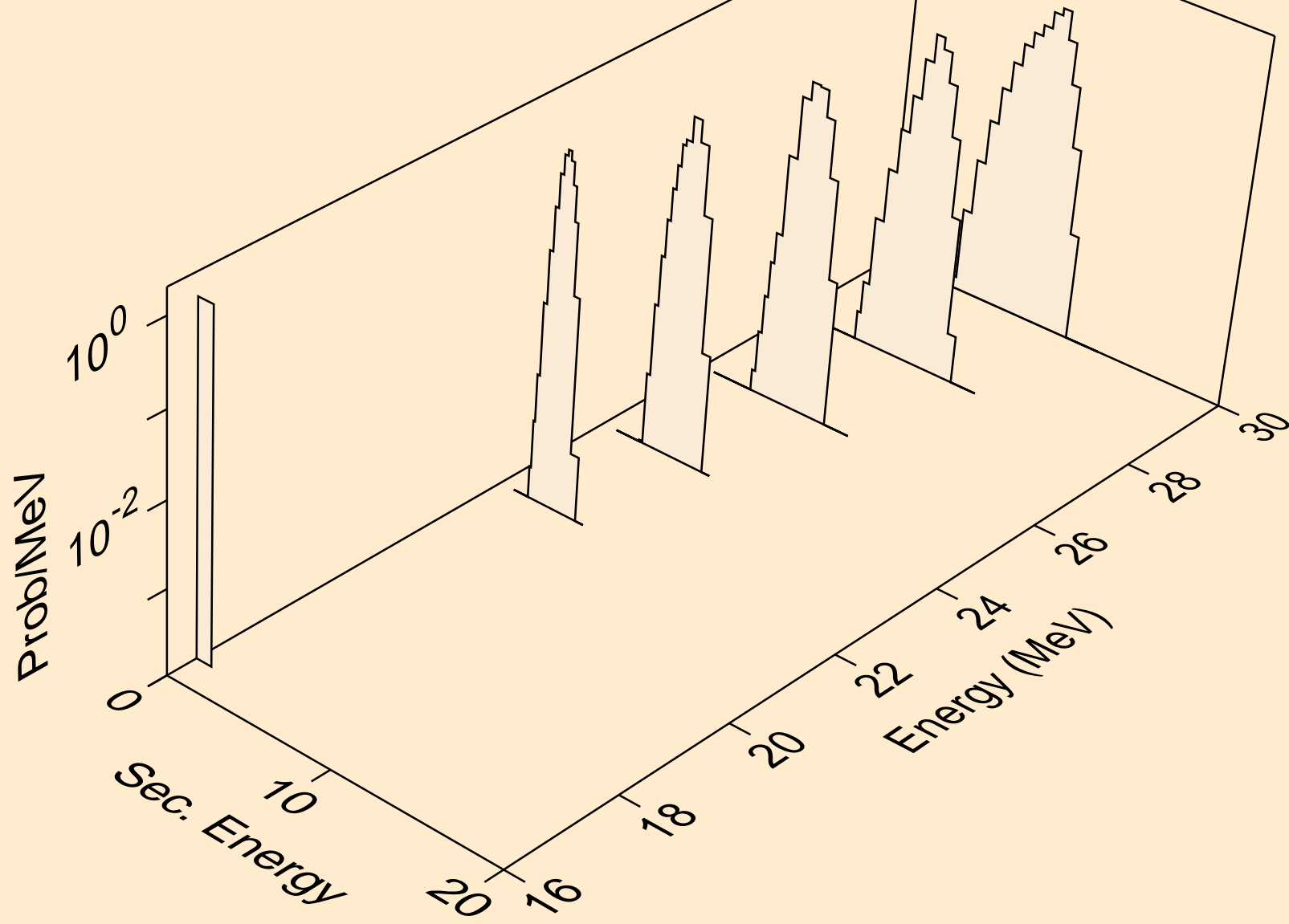

XE124 PROTON ACER TENDL-2023 LIBRARY; T=0.K
he3s from (p,x)

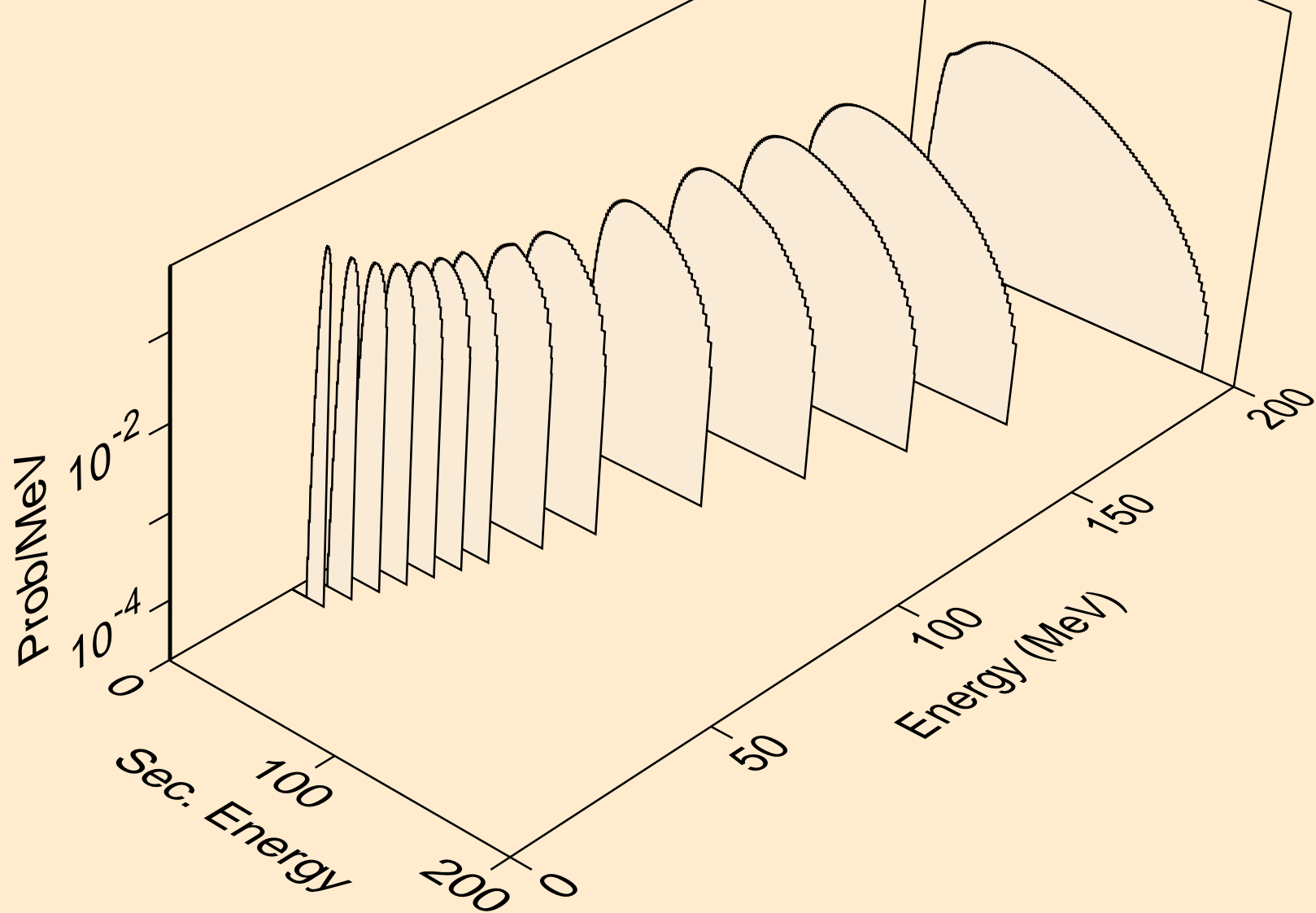

XE124 PROTON ACER TENDL-2023 LIBRARY; T=0.K
he3s from (p,n*)he3

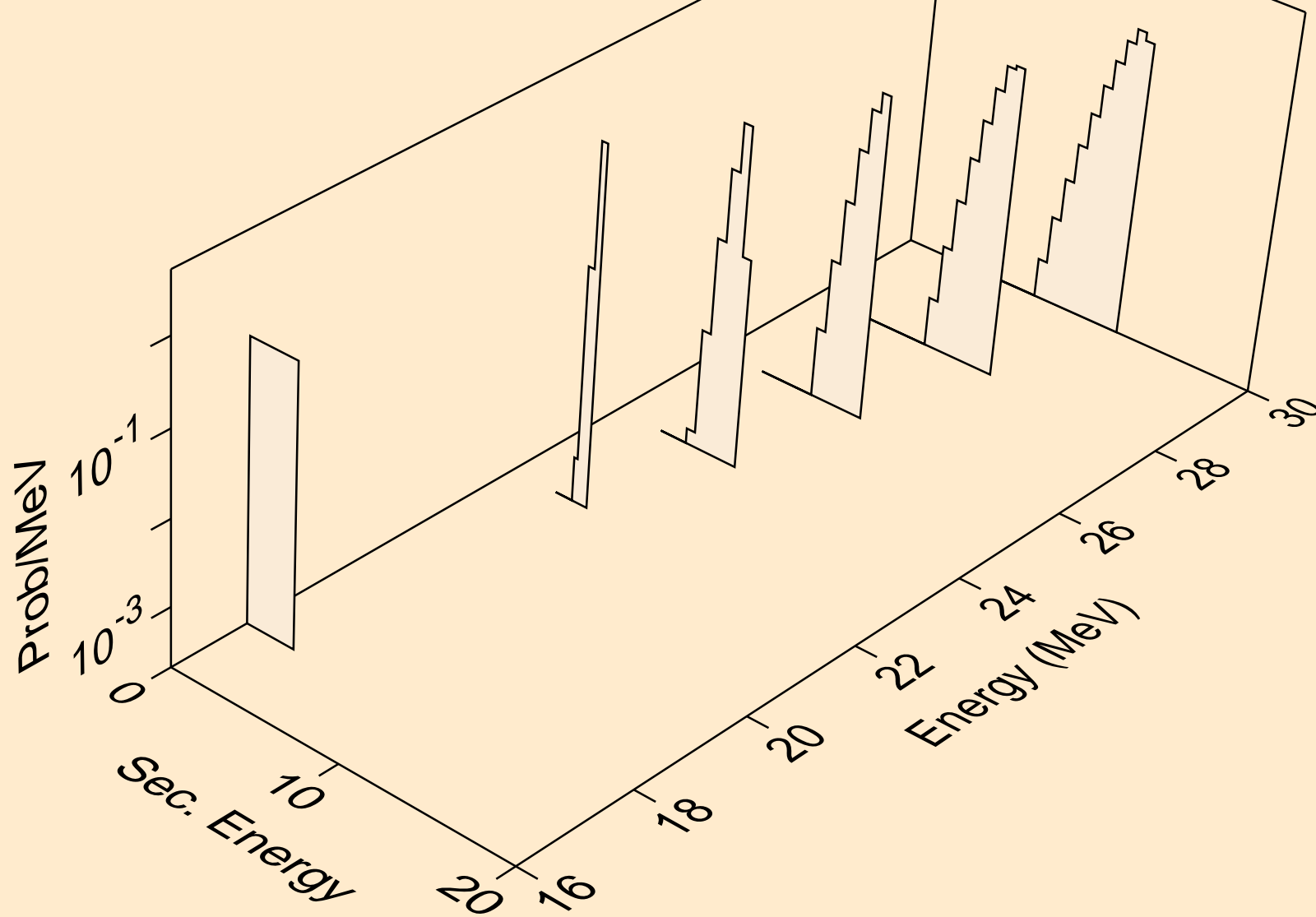

XE124 PROTON ACER TENDL-2023 LIBRARY; T=0.K
he3s from (p,he3)

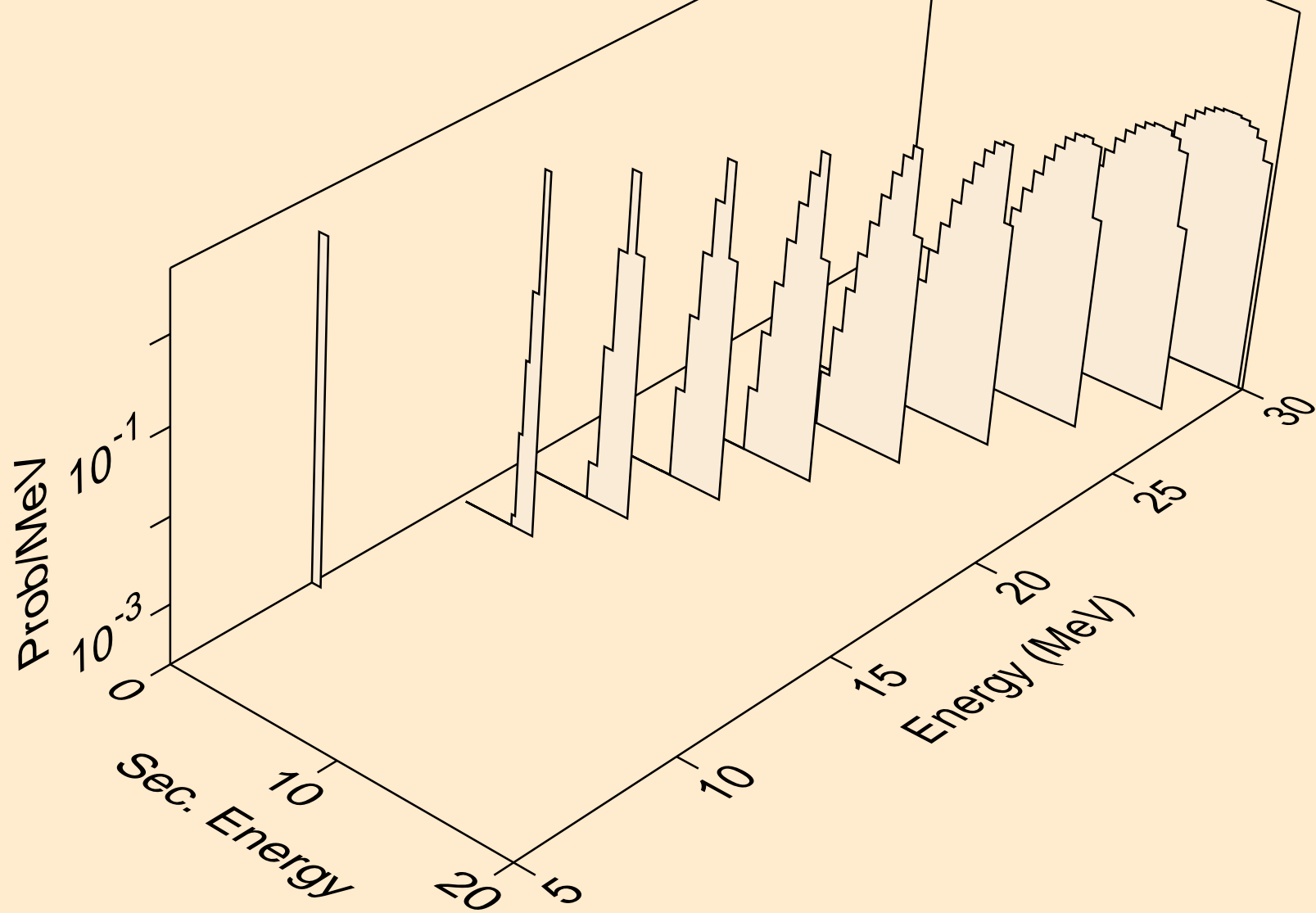

XE124 PROTON ACER TENDL-2023 LIBRARY; T=0.K
alphas from (p,x)

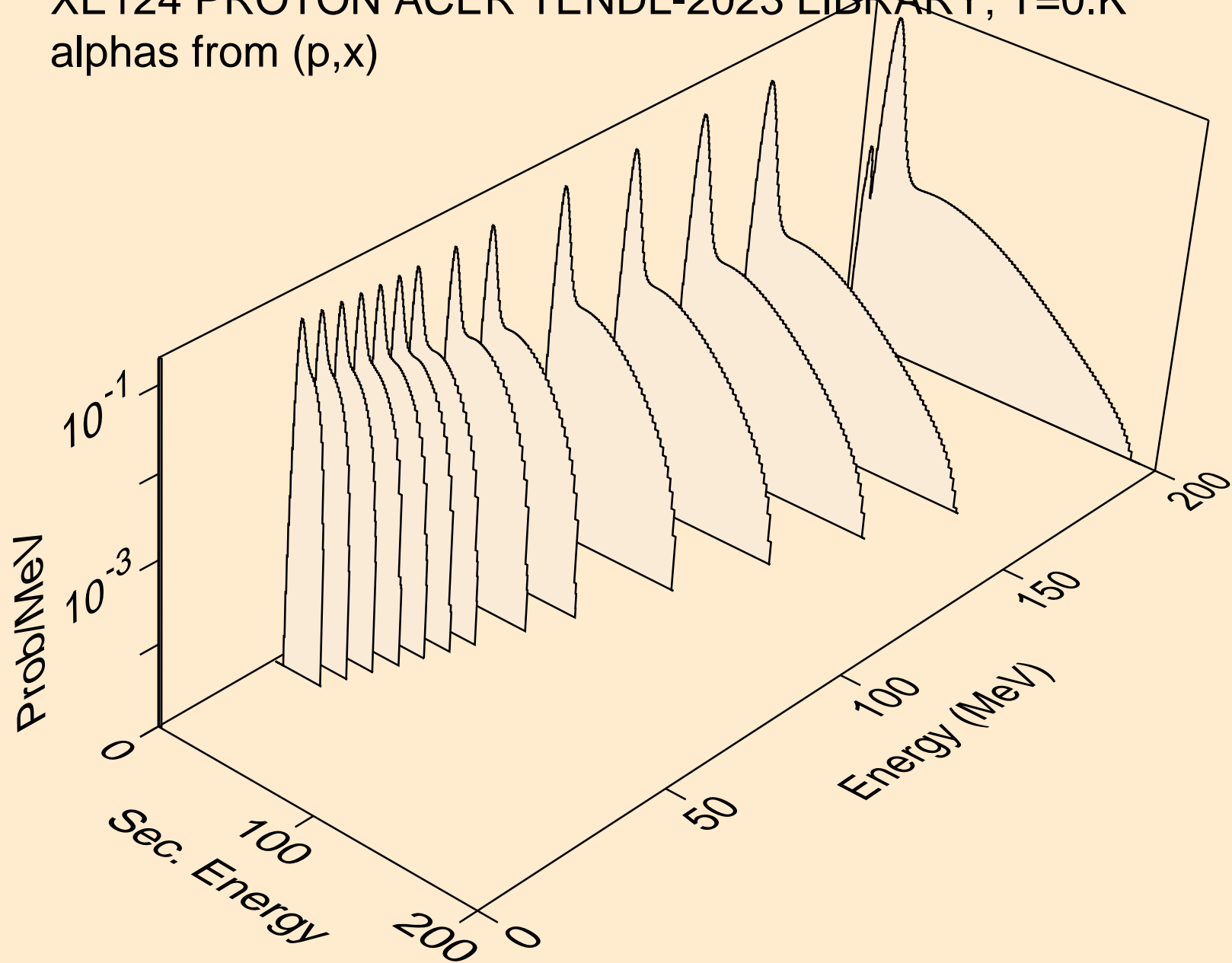

XE124 PROTON ACER TENDL-2023 LIBRARY; T=0.K
alphas from (p,n*)a

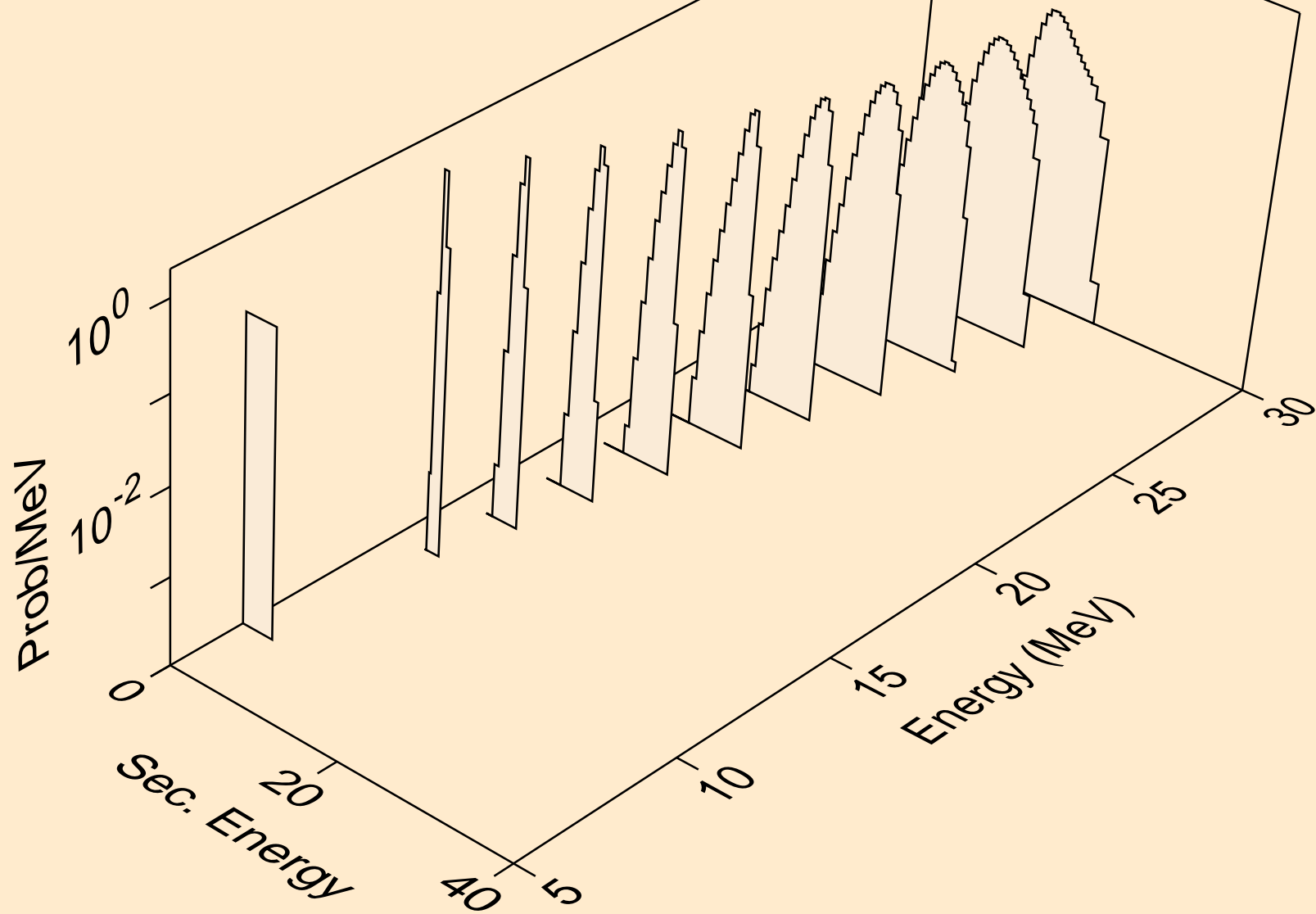

XE124 PROTON ACER TENDL-2023 LIBRARY; T=0.K
alphas from (p,2n)a

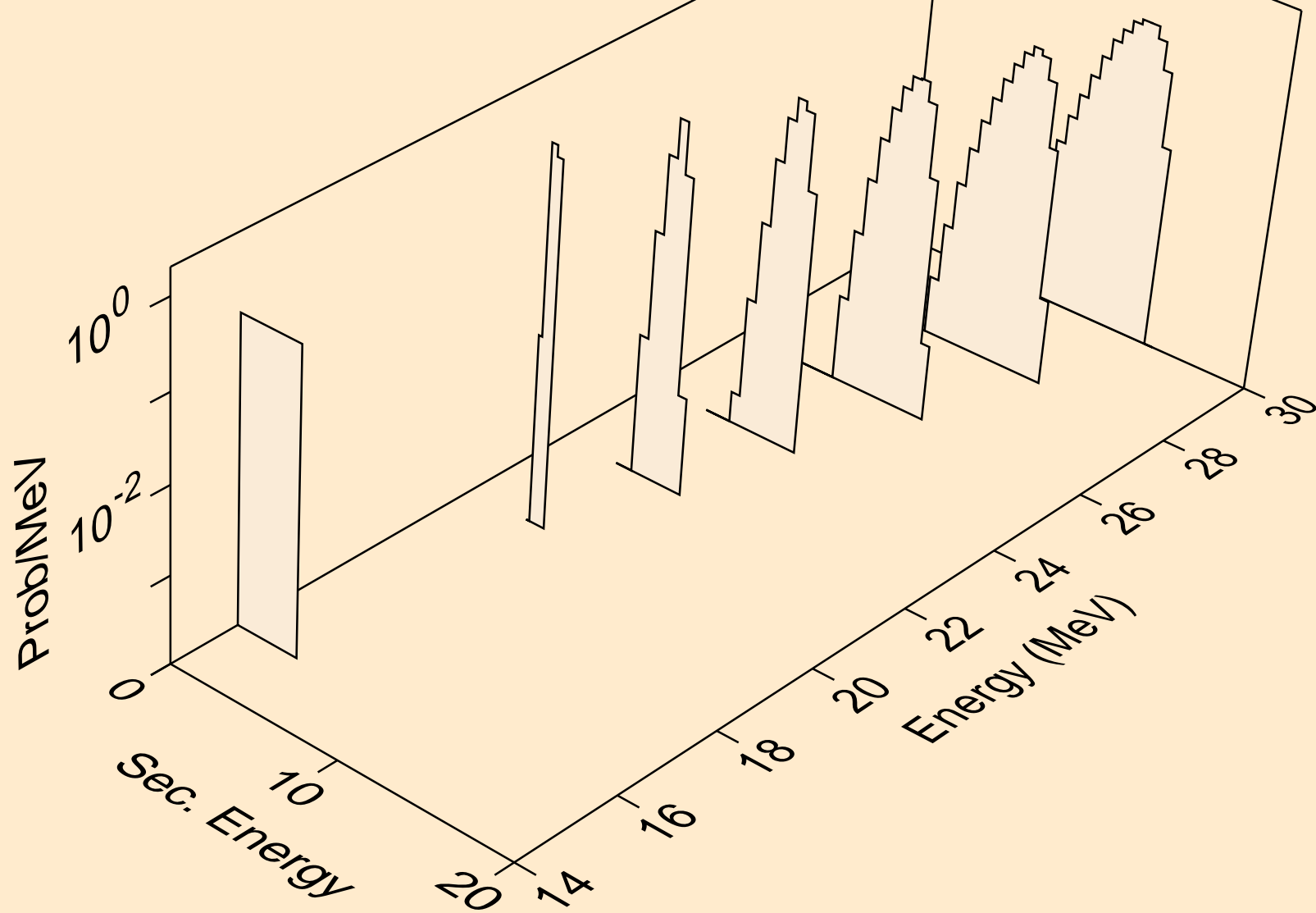

XE124 PROTON ACER TENDL-2023 LIBRARY; T=0.K
alphas from (p,n*)2a

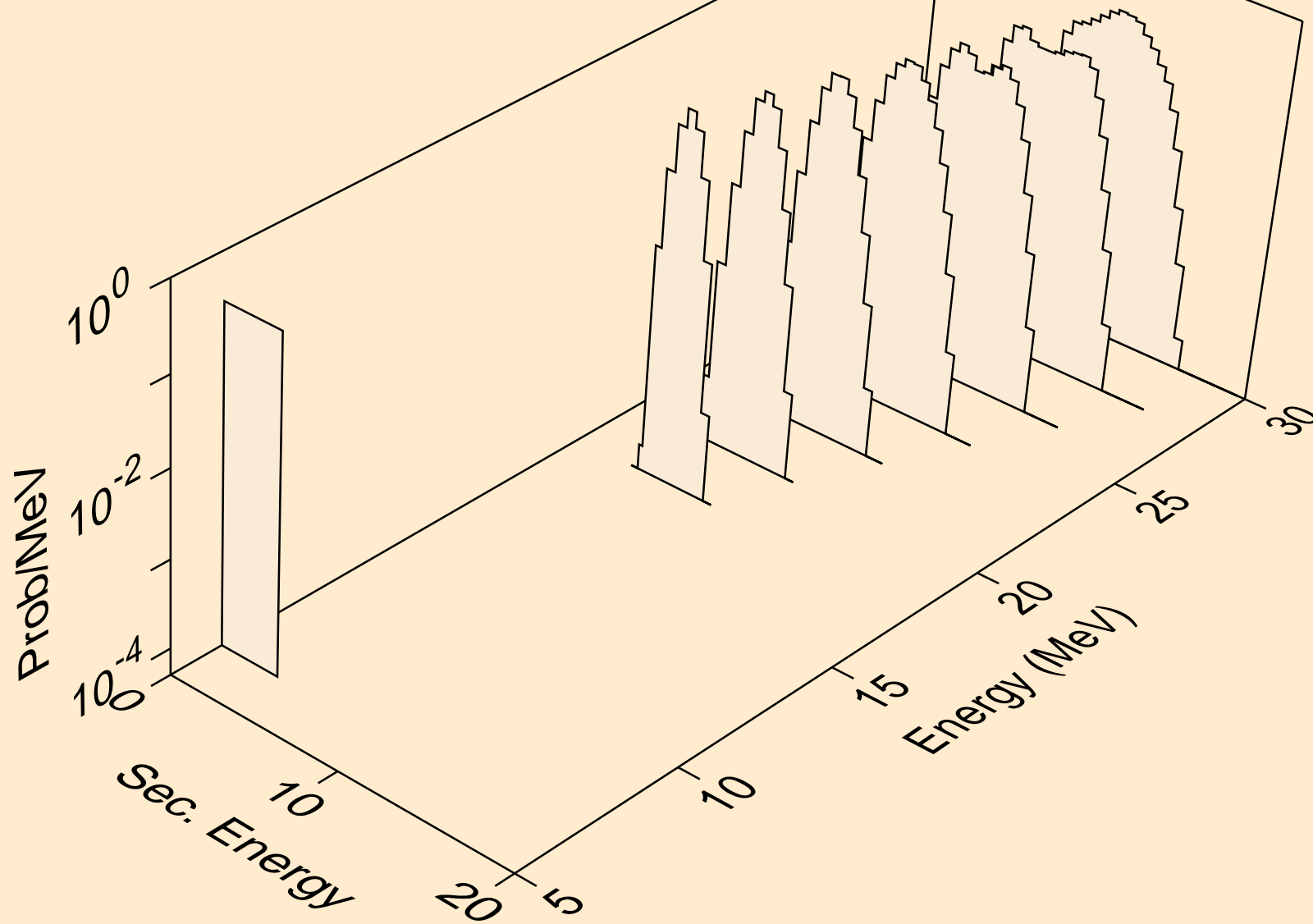

XE124 PROTON ACER TENDL-2023 LIBRARY; T=0.K
alphas from (p,npa)

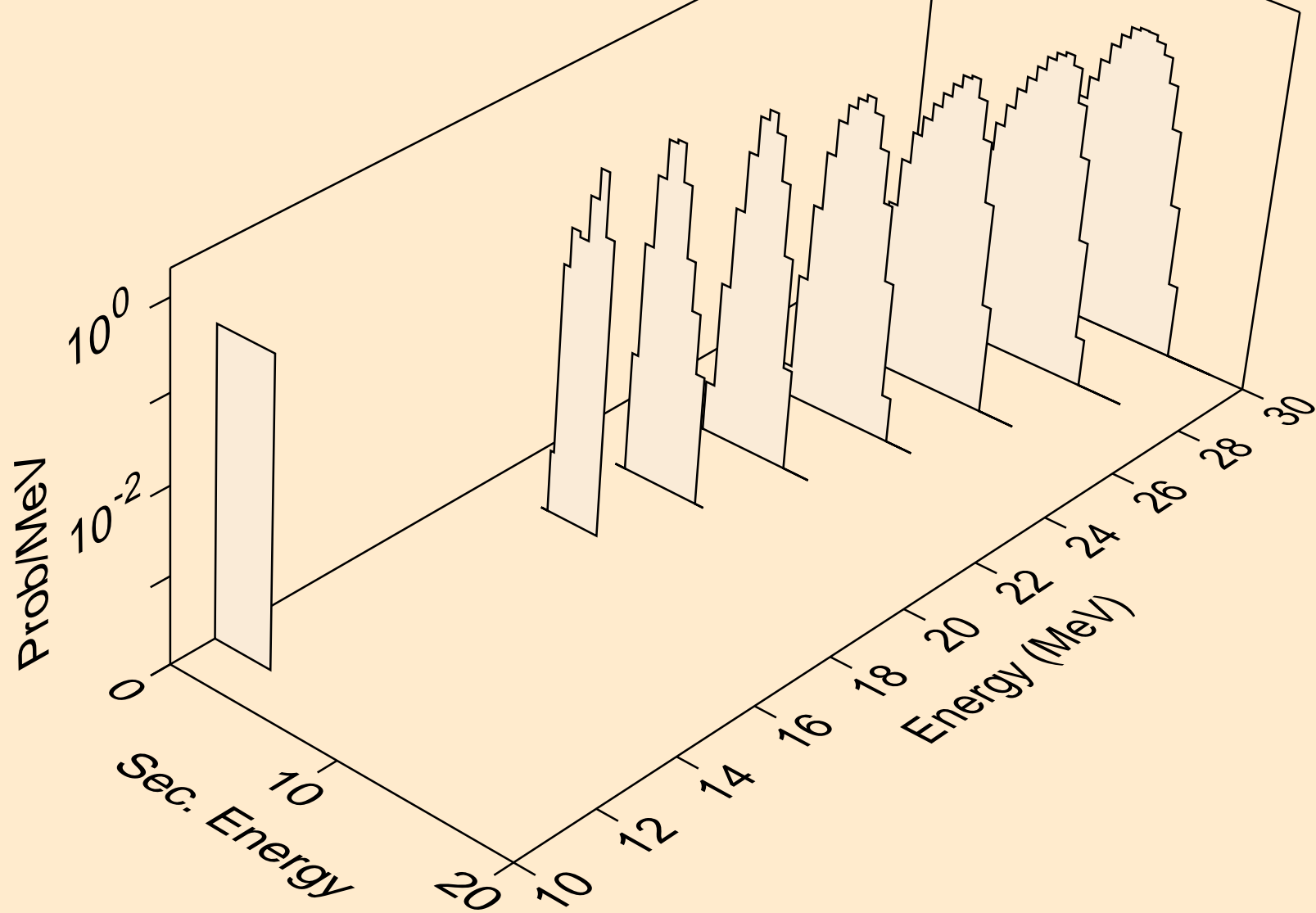

XE124 PROTON ACER TENDL-2023 LIBRARY; T=0.K
alphas from (p,a)

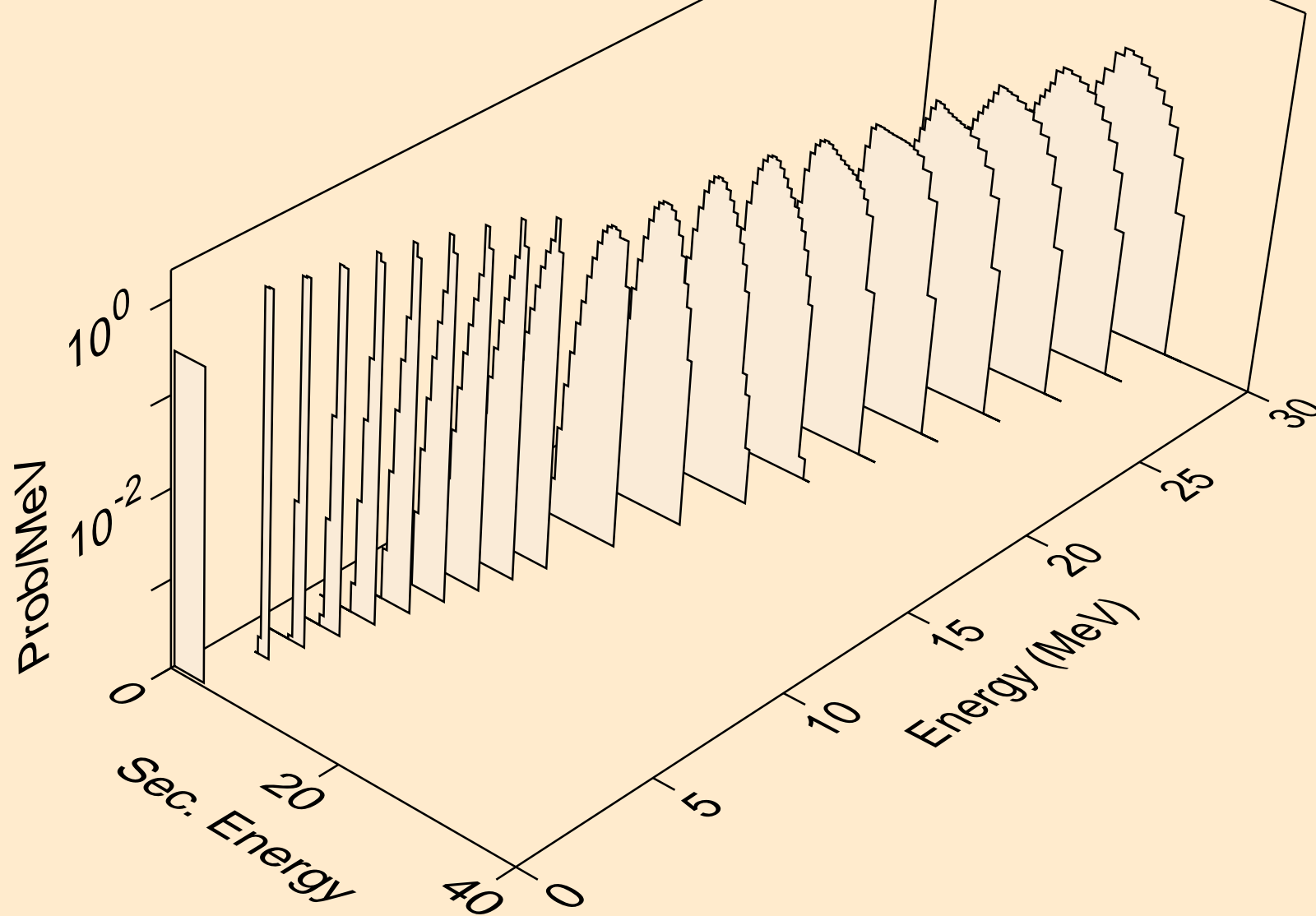

XE124 PROTON ACER TENDL-2023 LIBRARY; T=0.K
alphas from (p,2a)

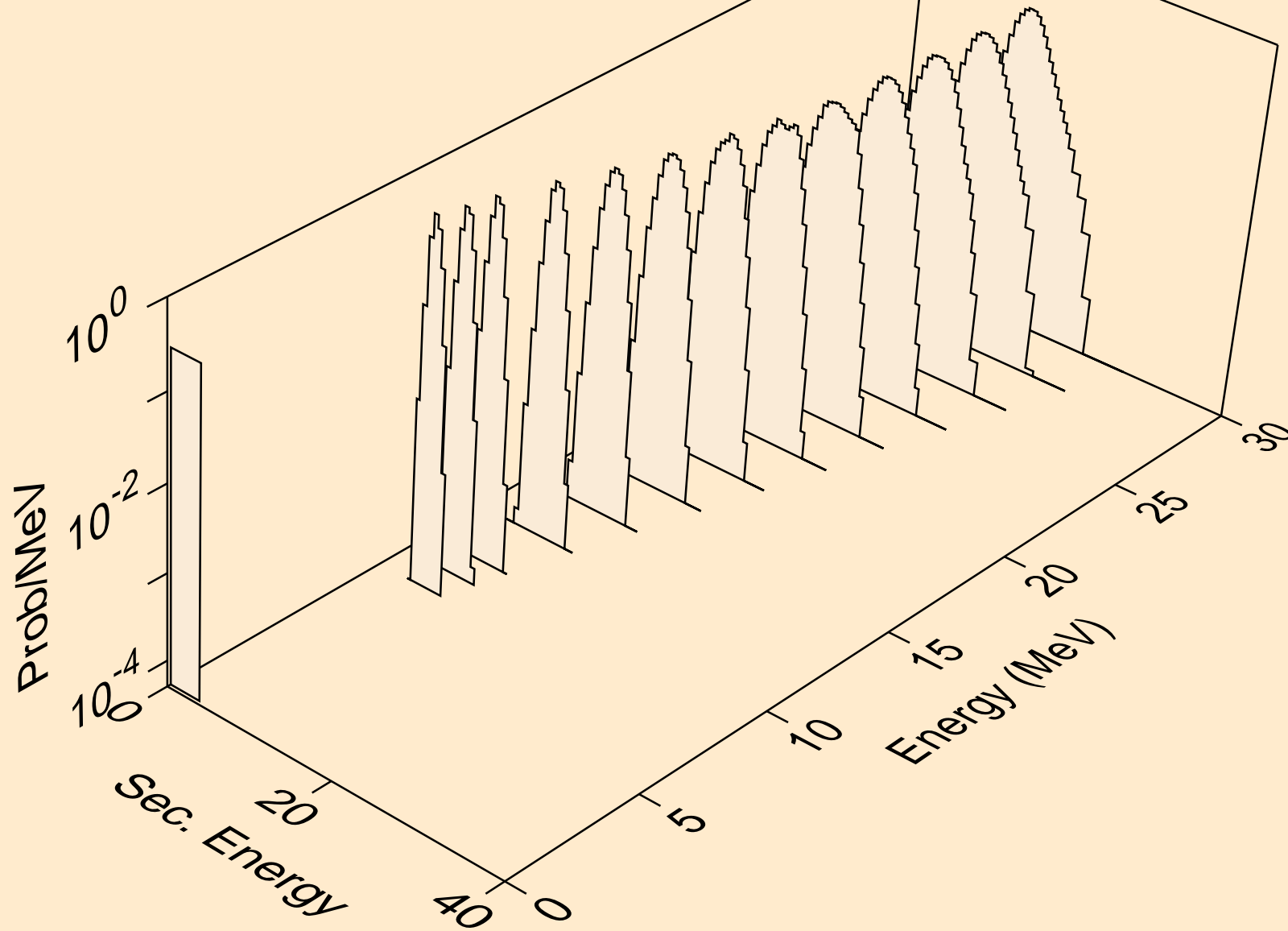

XE124 PROTON ACER TENDL-2023 LIBRARY; T=0.K
alphas from (p,pa)

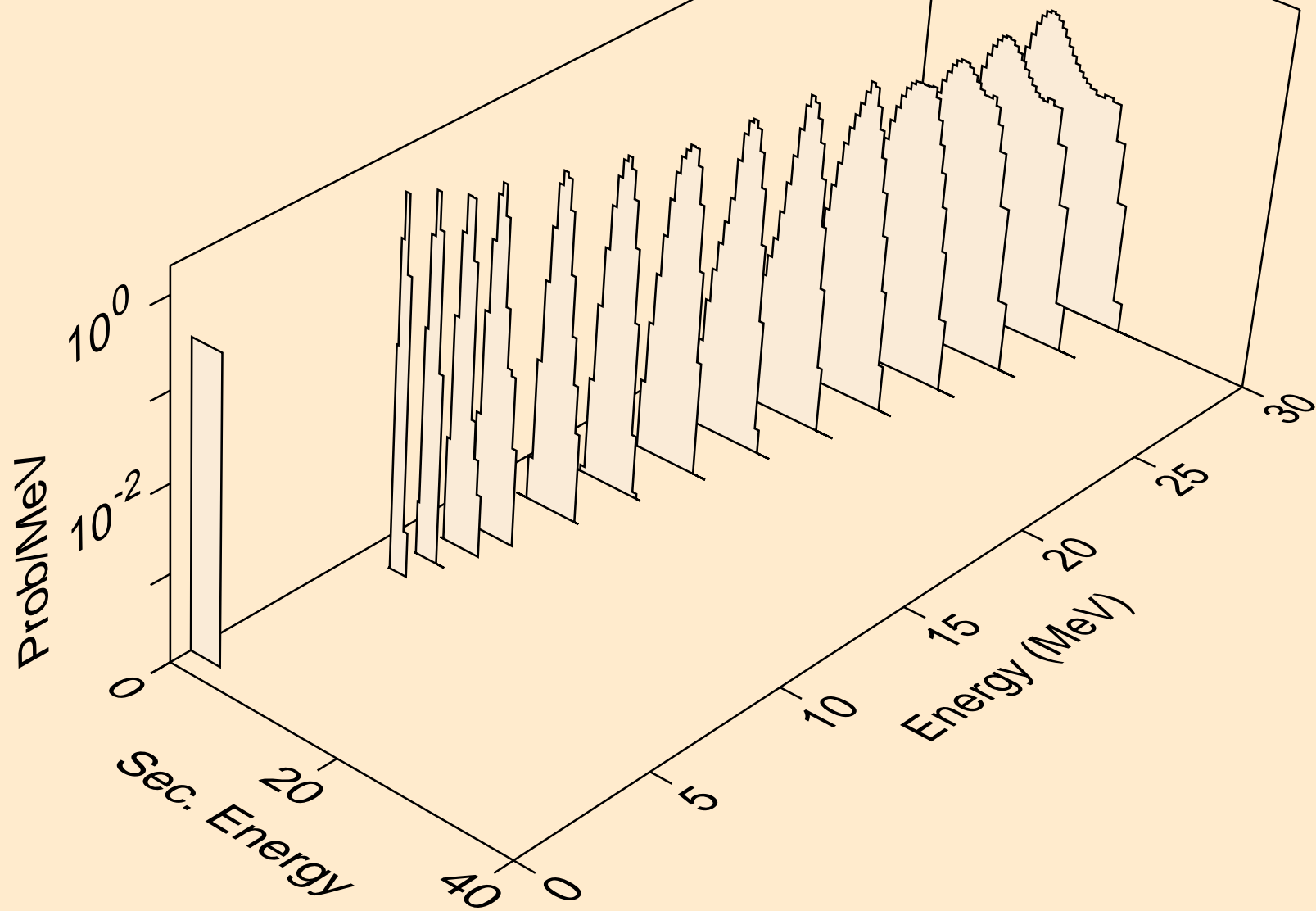

XE124 PROTON ACER TENDL-2023 LIBRARY; T=0.K
alphas from (p,da)

