

ZN061 PROTON ACER TENDL-2023 LIBRARY; T=0.K

Principal cross sections

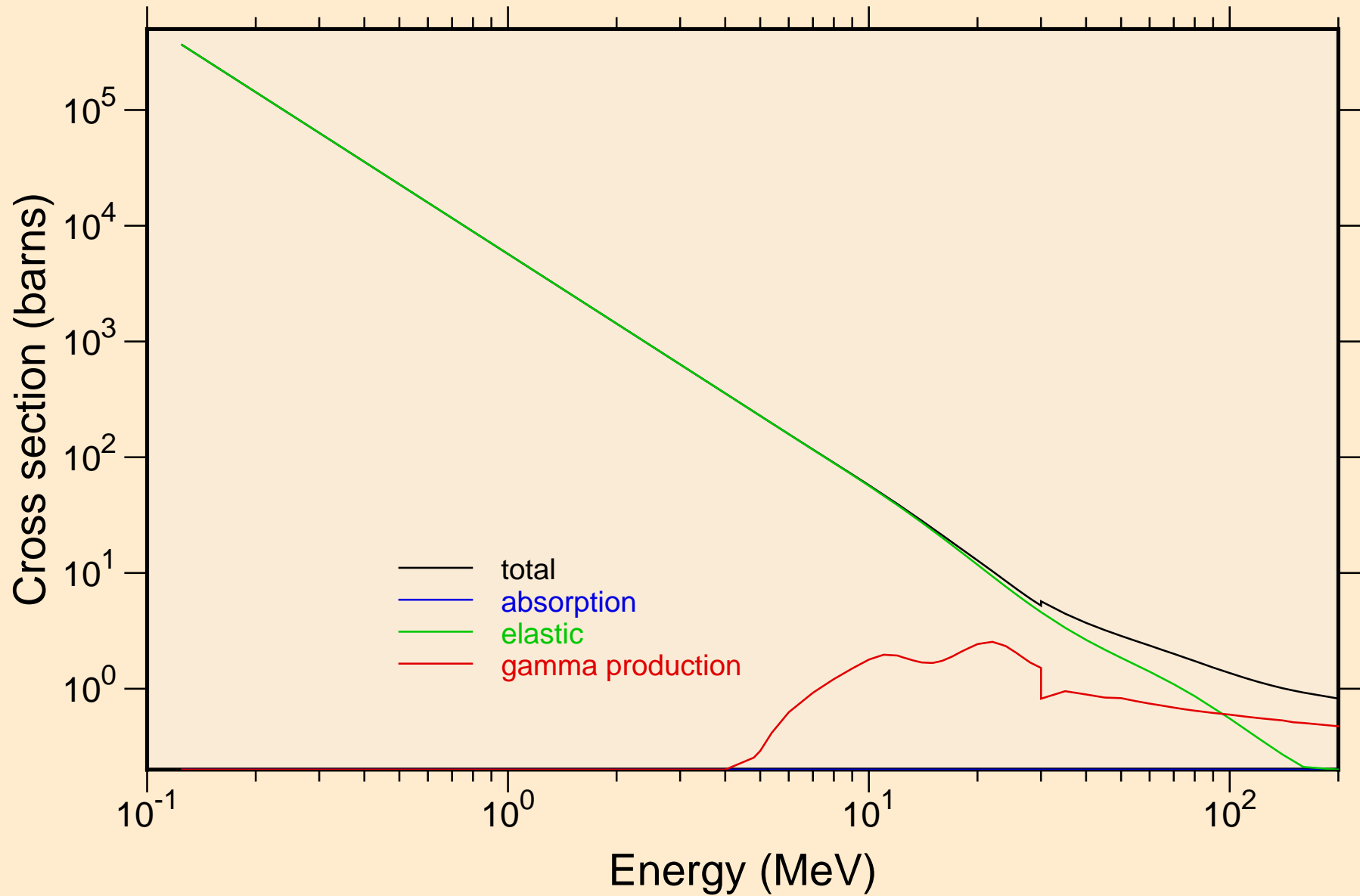

ZN061 PROTON ACER TENDL-2023 LIBRARY; T=0.K

Heating

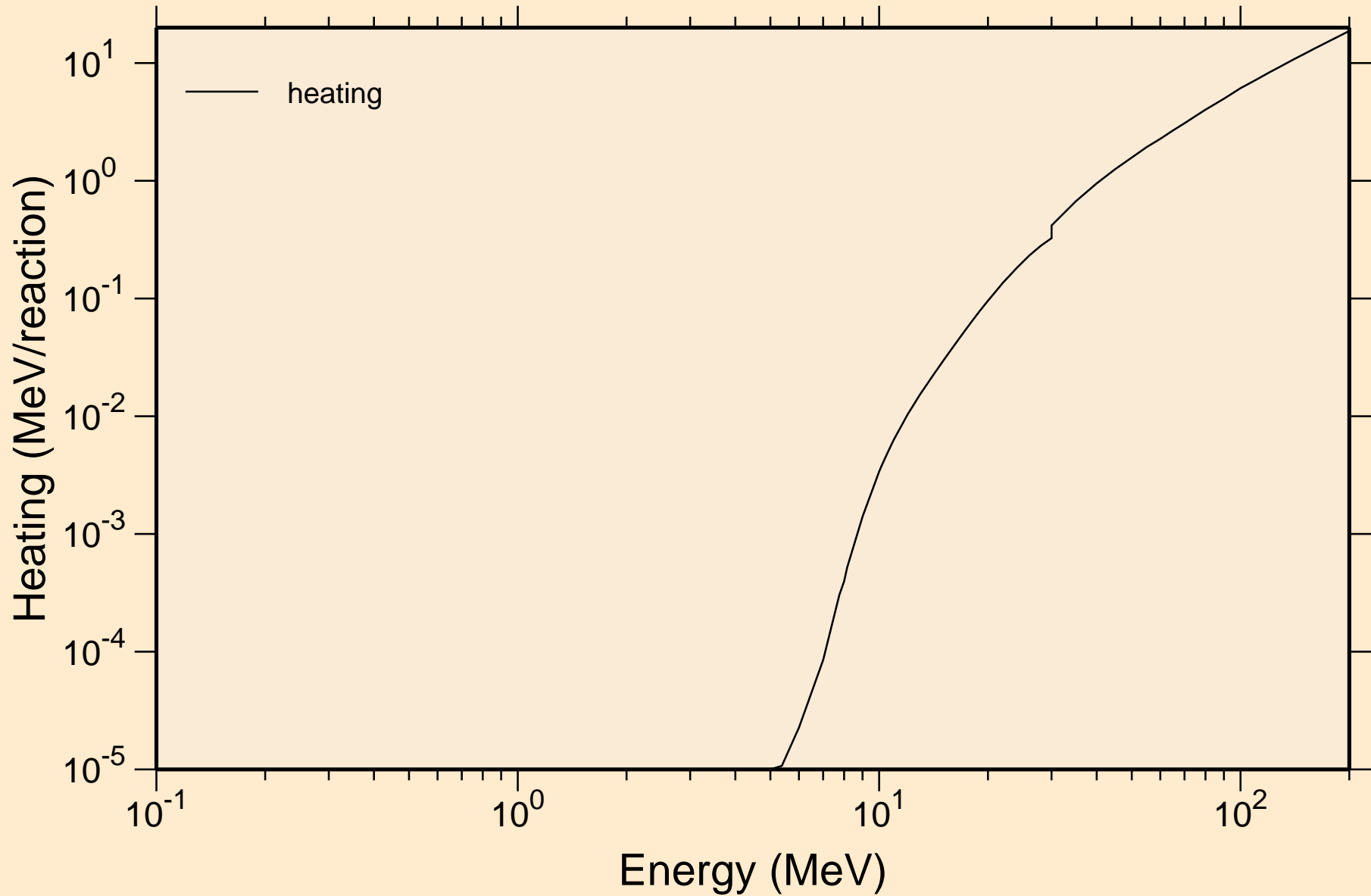

ZN061 PROTON ACER TENDL-2023 LIBRARY; T=0.K

Principal cross sections

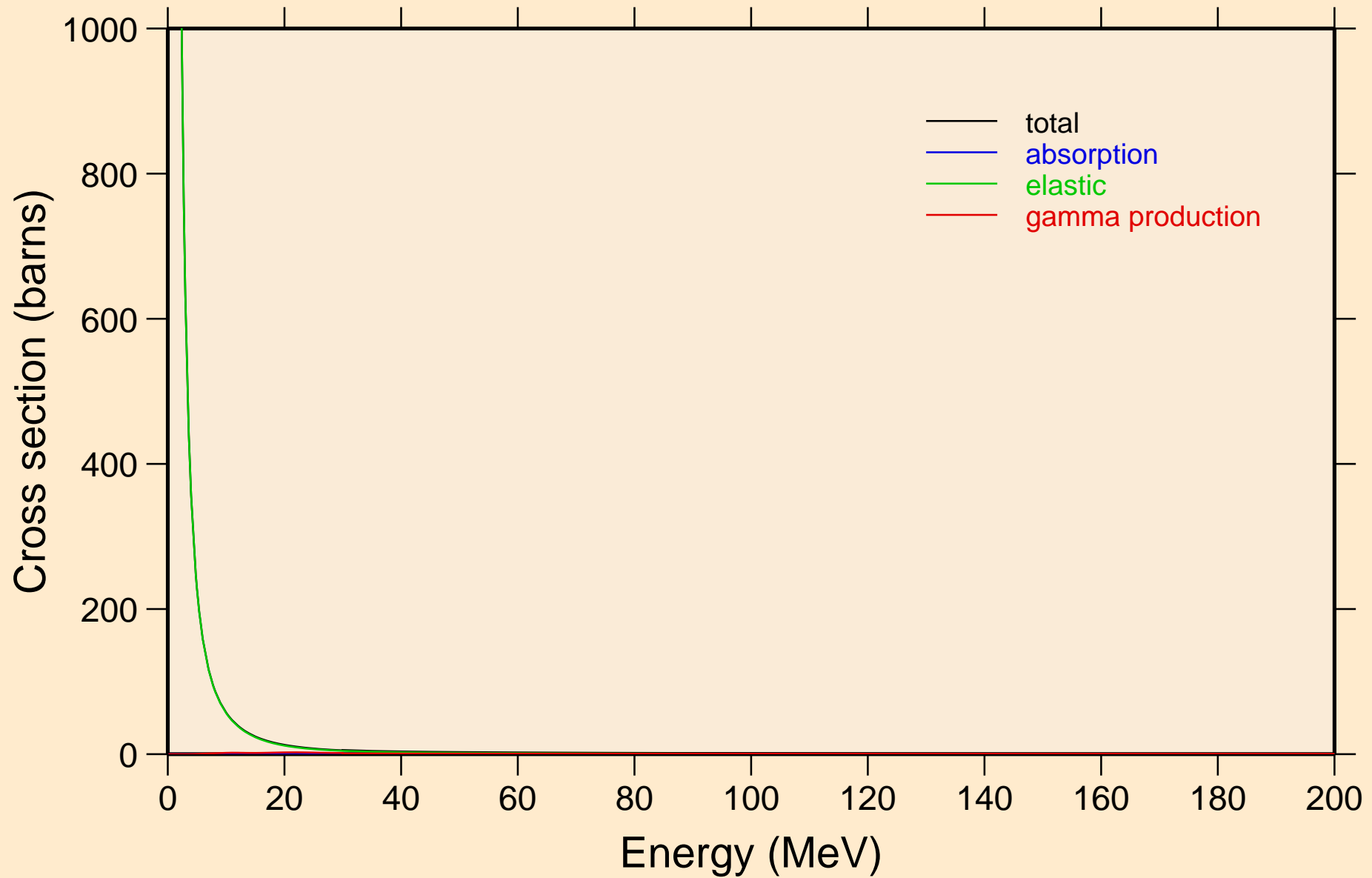

ZN061 PROTON ACER TENDL-2023 LIBRARY; T=0.K

Heating

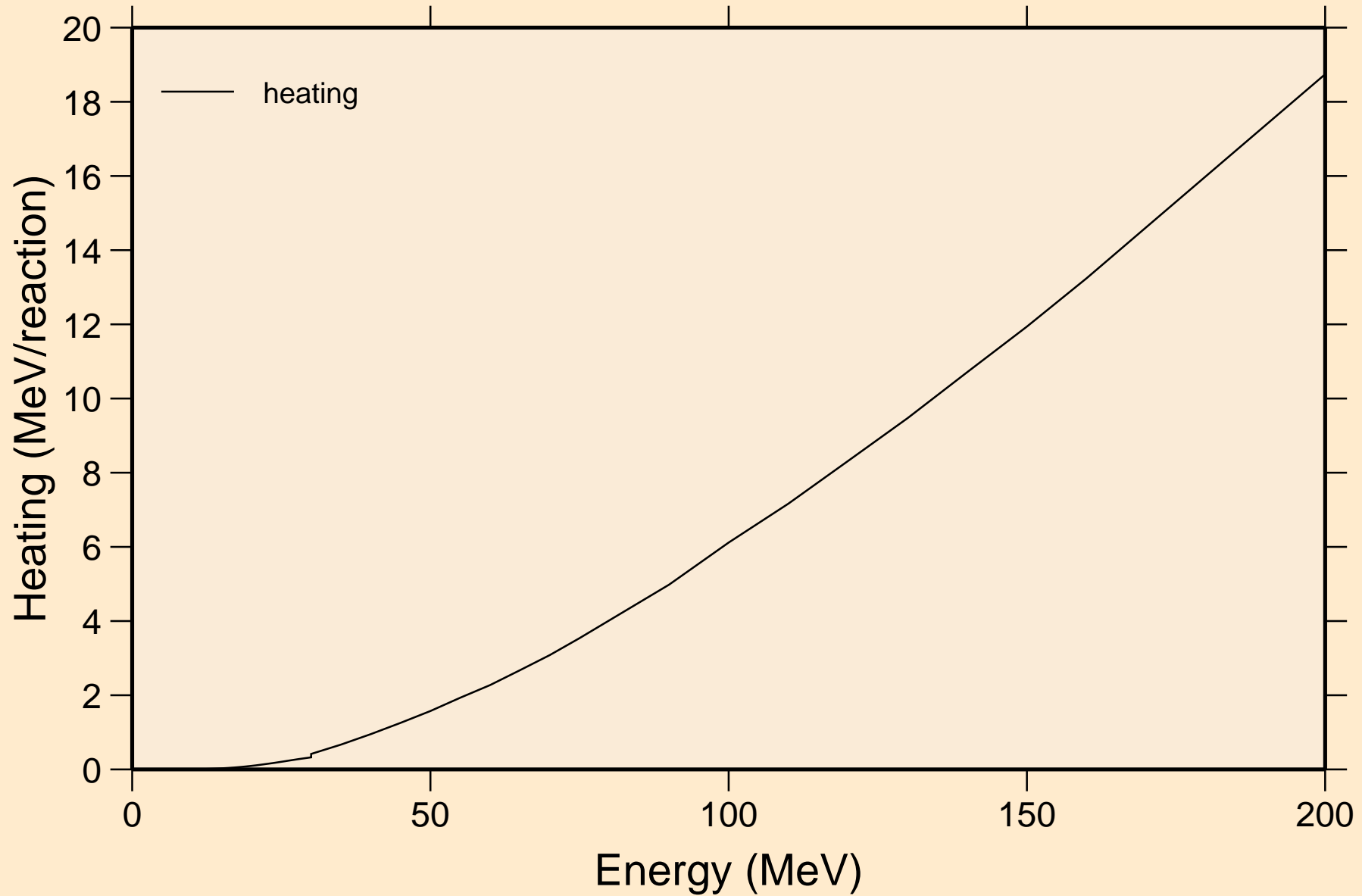

ZN061 PROTON ACER TENDL-2023 LIBRARY; T=0.K

Threshold reactions

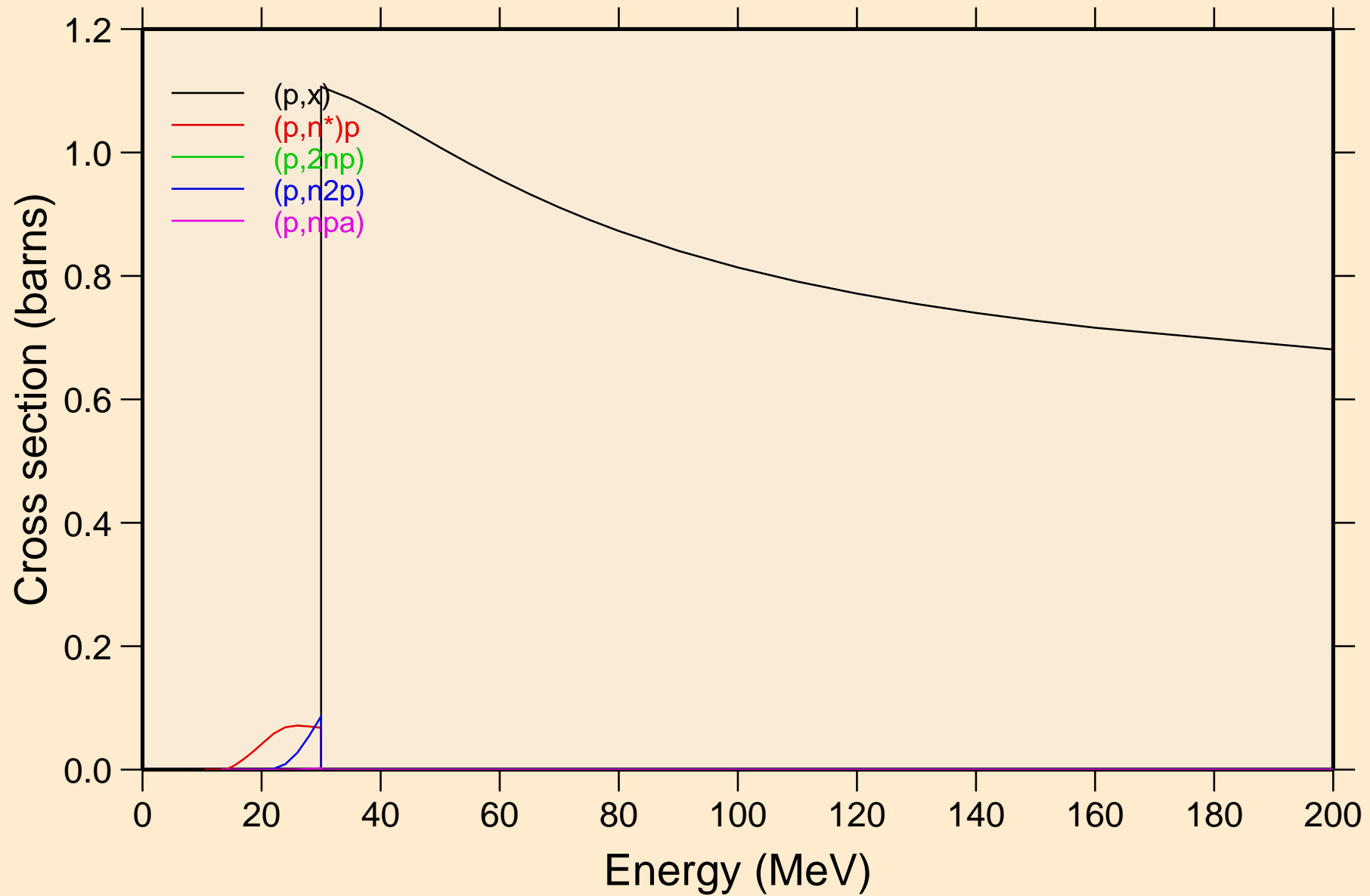

ZN061 PROTON ACER TENDL-2023 LIBRARY; T=0.K
Threshold reactions

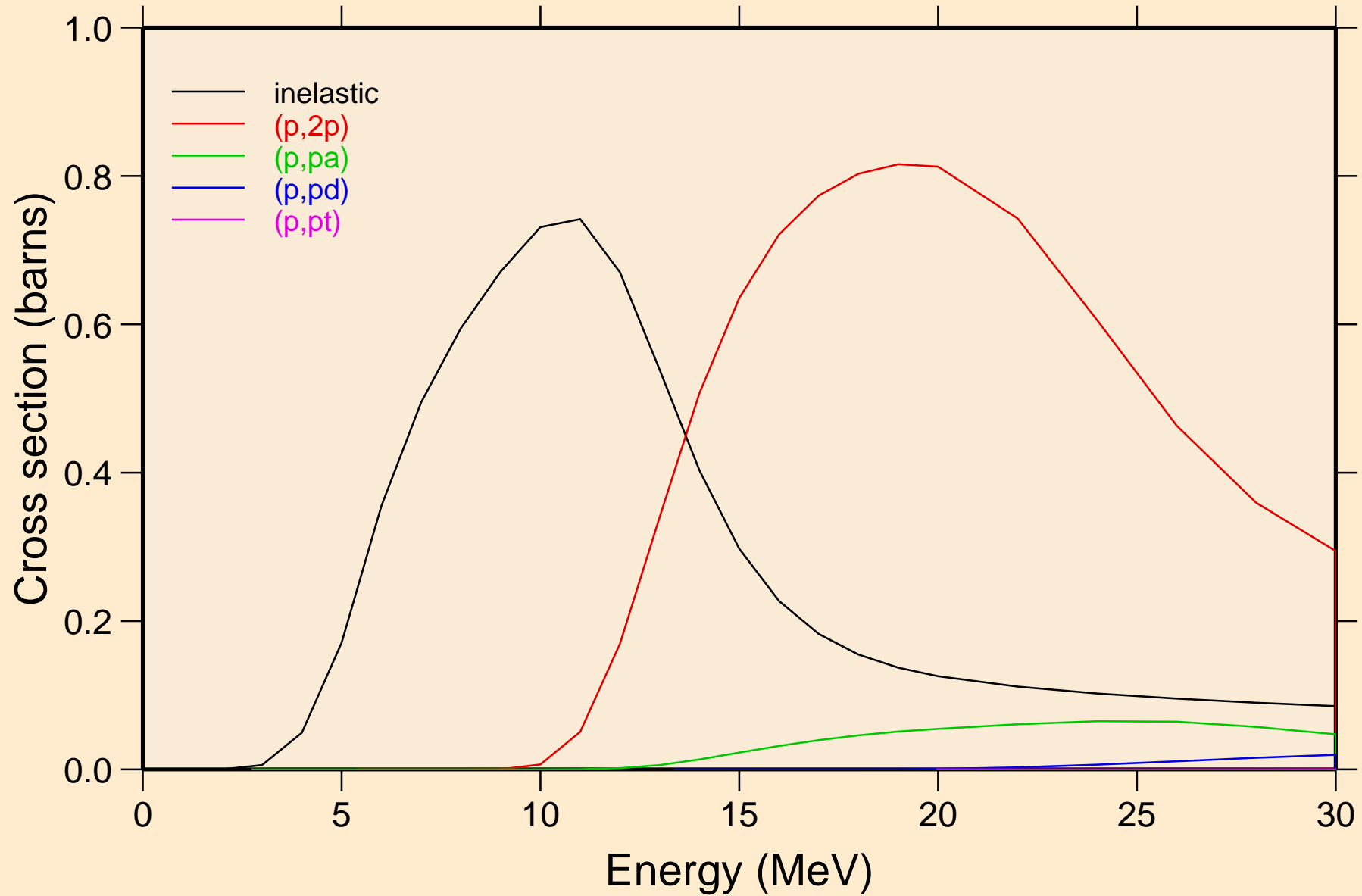

ZN061 PROTON ACER TENDL-2023 LIBRARY; T=0.K
Threshold reactions

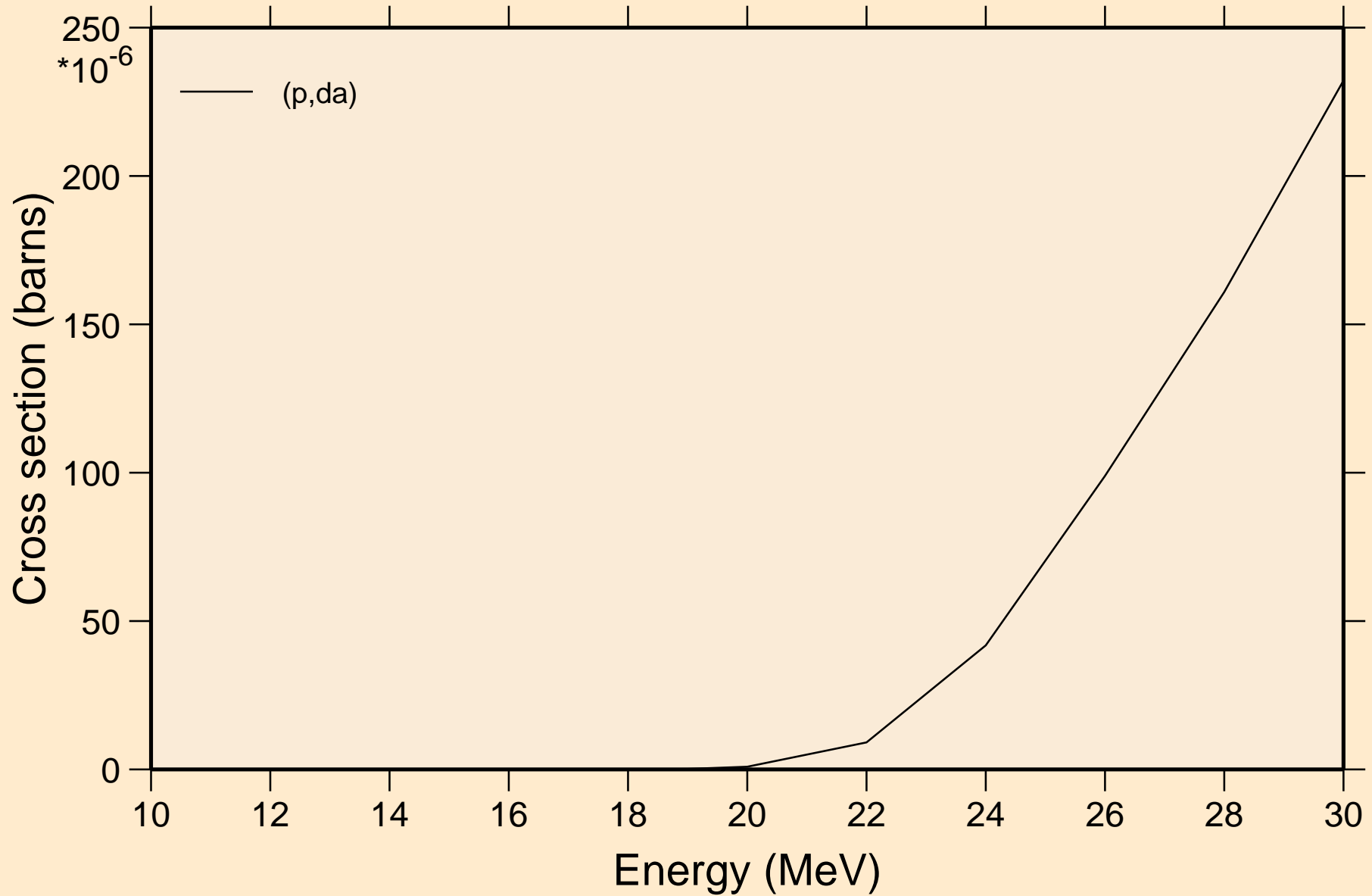

ZN061 PROTON ACER TENDL-2023 LIBRARY; T=0.K
angular distribution for elastic

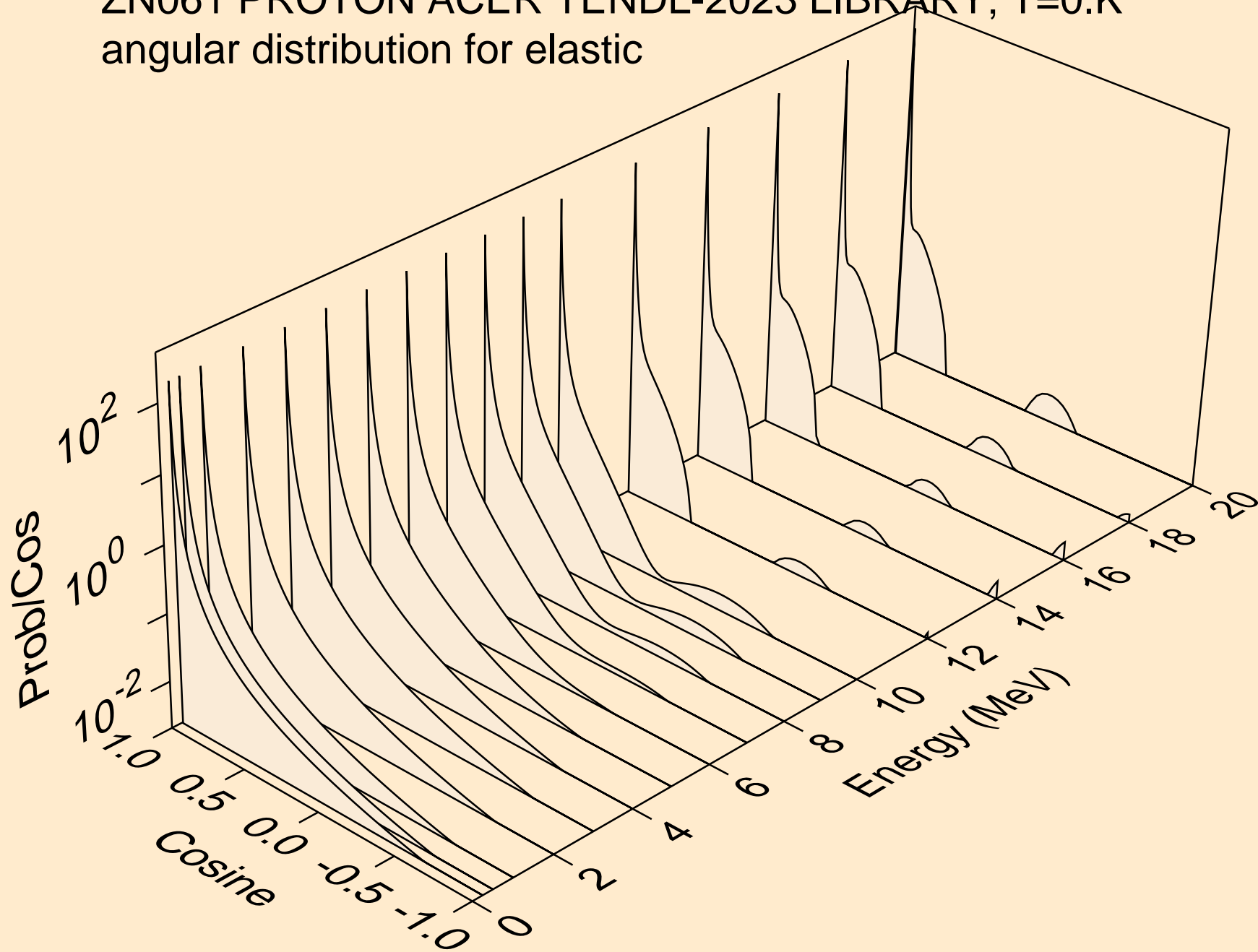

ZN061 PROTON ACER TENDL-2023 LIBRARY; T=0.K
angular distribution for elastic

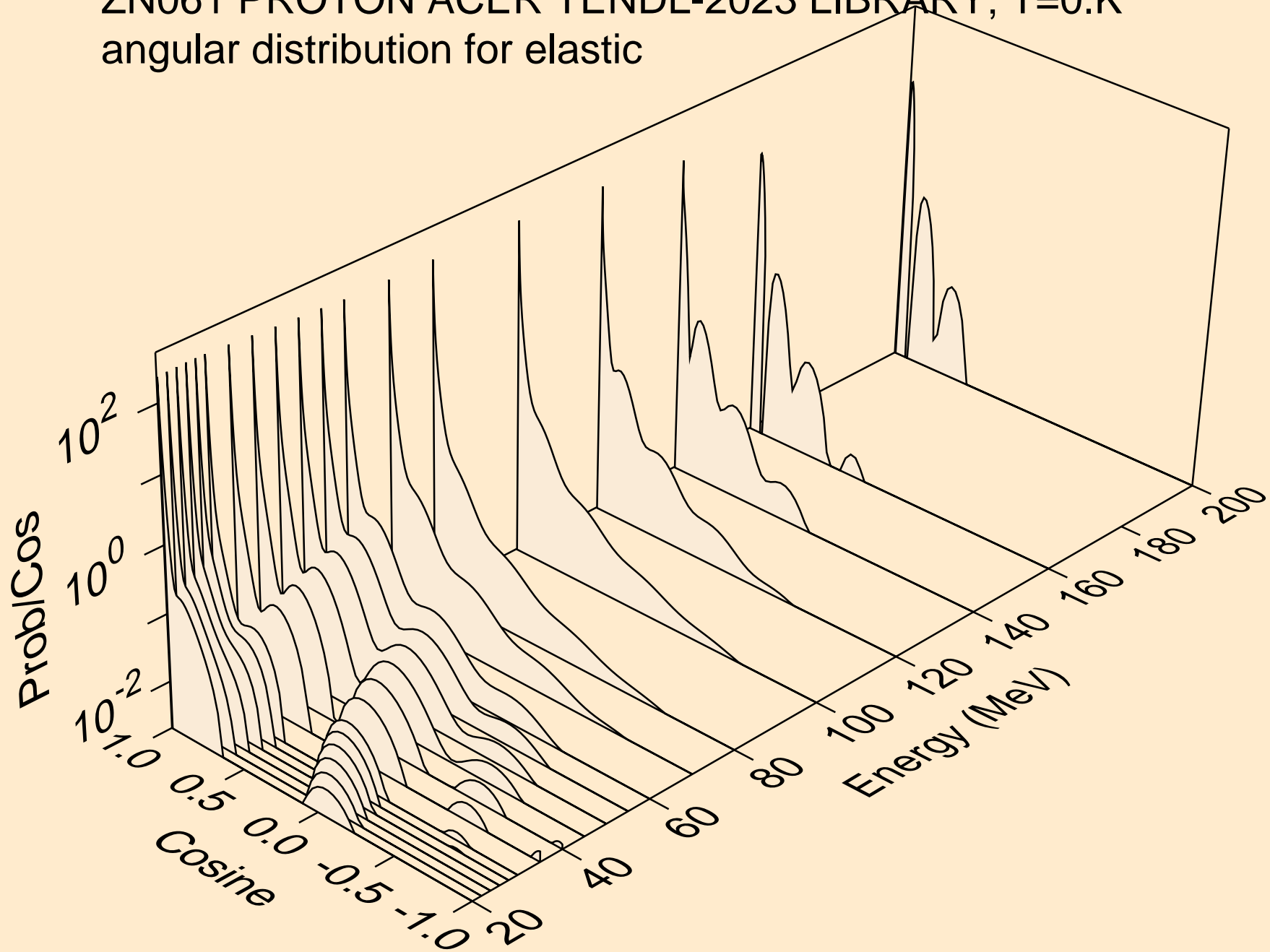

ZN061 PROTON ACER TENDL-2023 LIBRARY; T=0.K
Proton emission for (p,x)

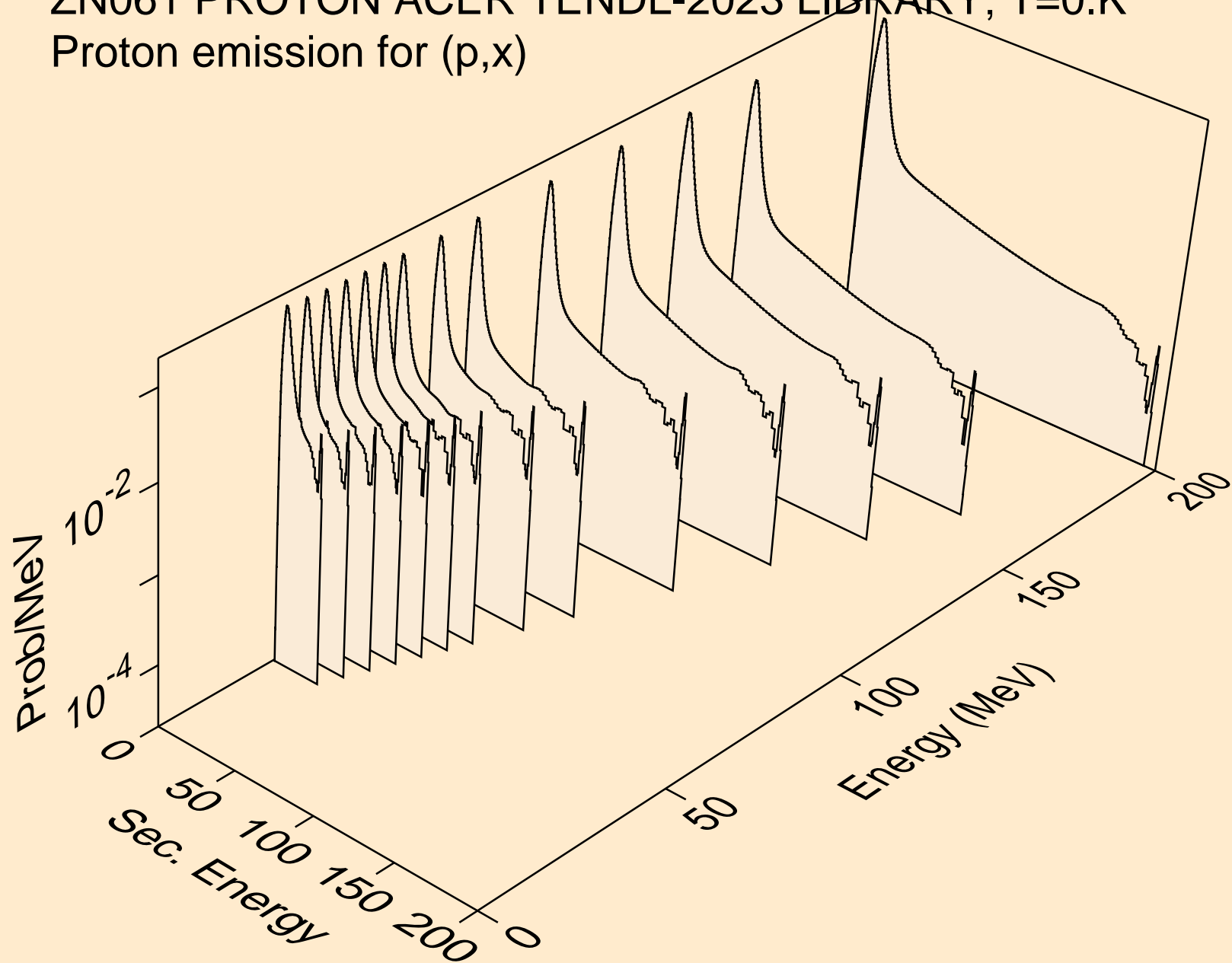

ZN061 PROTON ACER TENDL-2023 LIBRARY; T=0.K
Proton emission for (p,n*)p

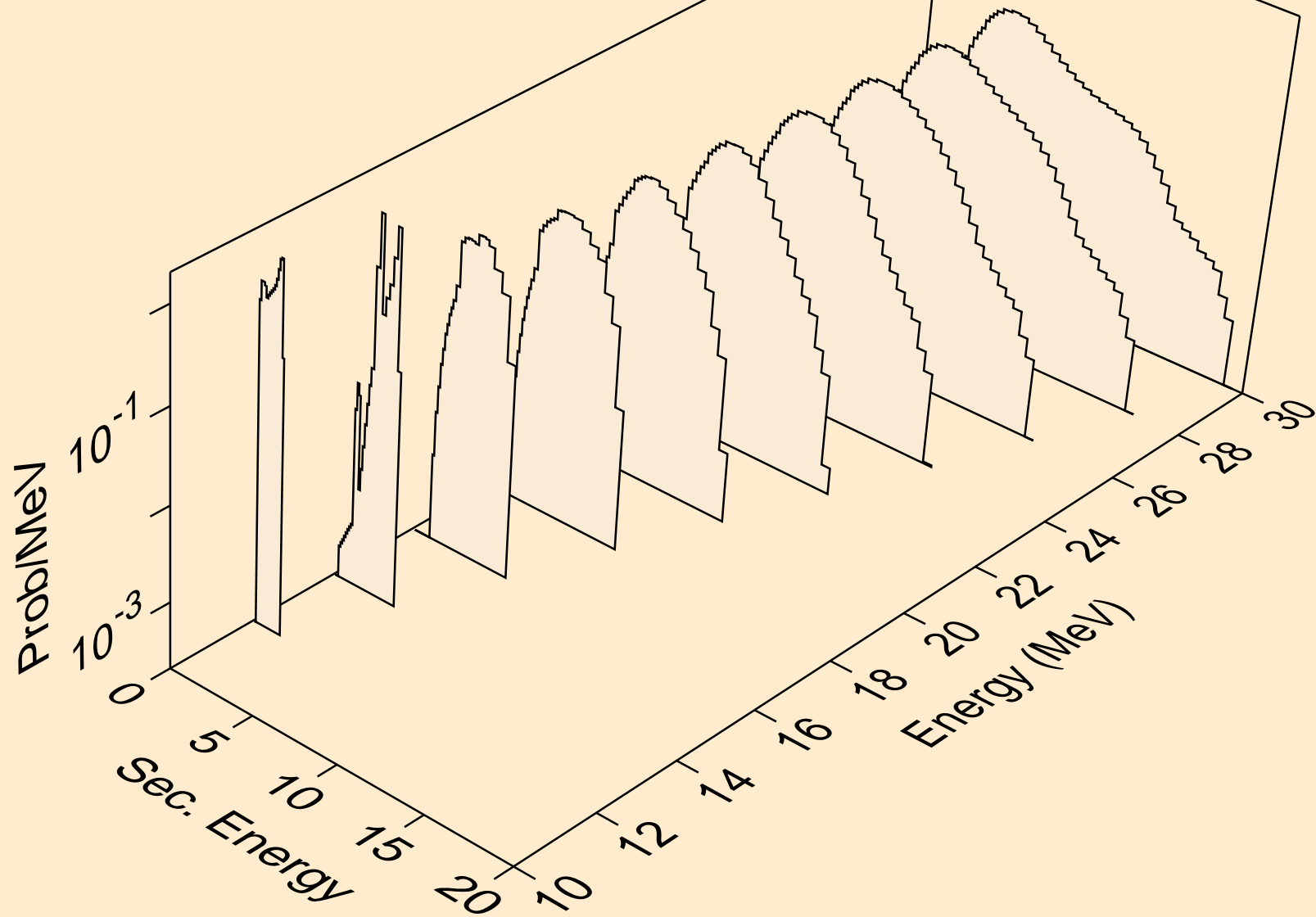

ZN061 PROTON ACER TENDL-2023 LIBRARY; T=0.K
Proton emission for (p,2np)

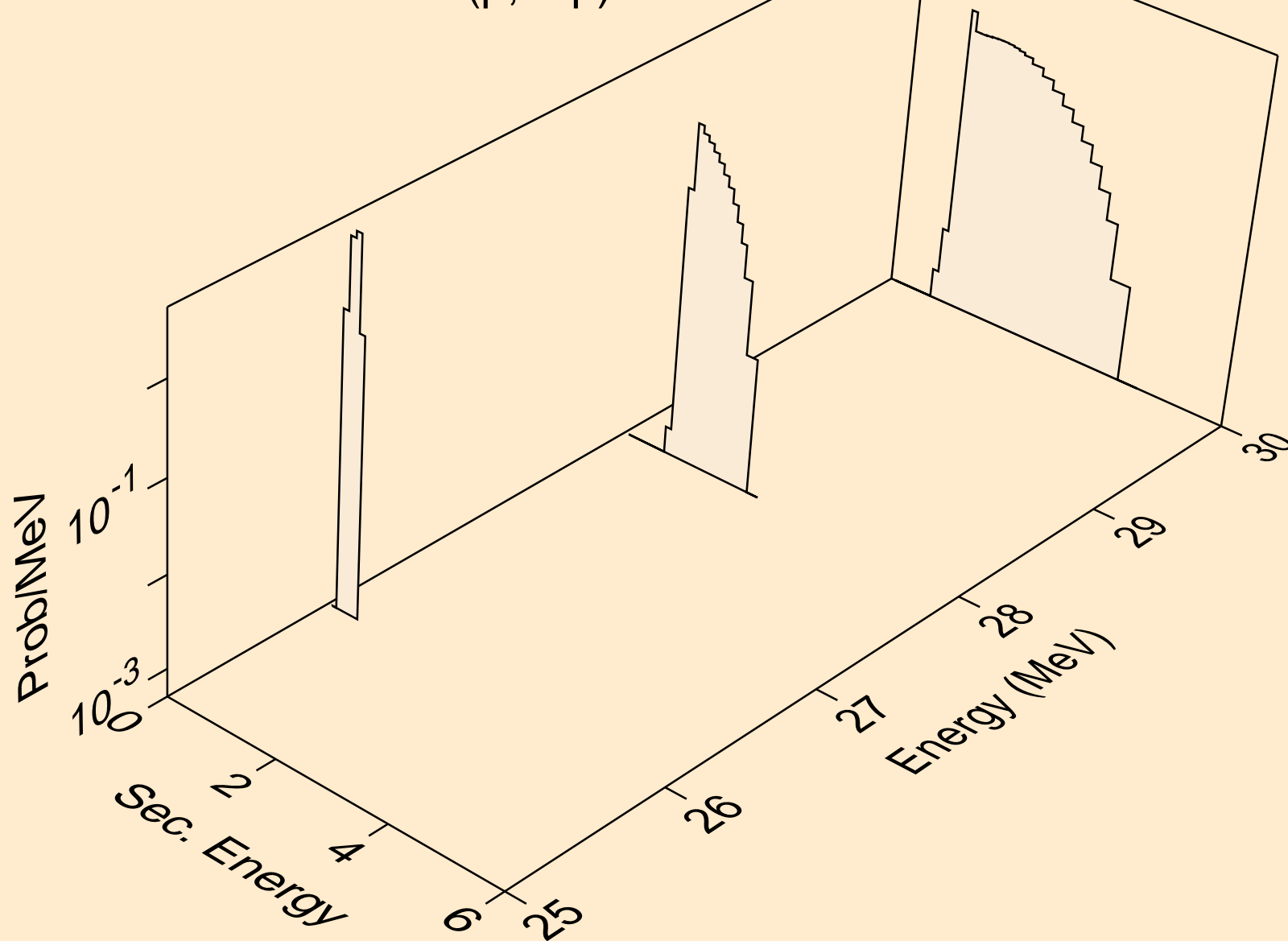

ZN061 PROTON ACER TENDL-2023 LIBRARY; T=0.K
Proton emission for (p,n2p)

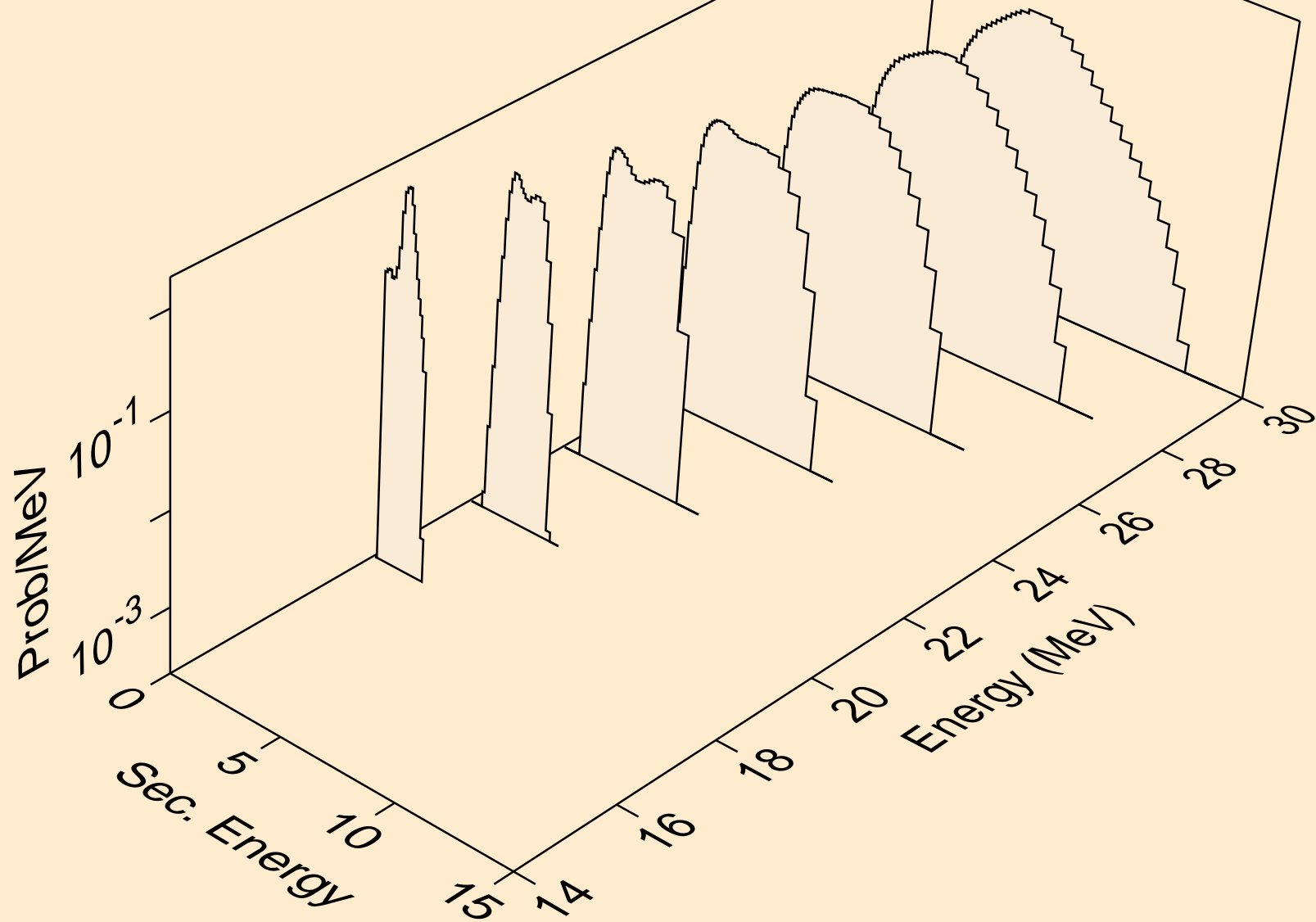

ZN061 PROTON ACER TENDL-2023 LIBRARY; T=0.K
Proton emission for (p,npa)

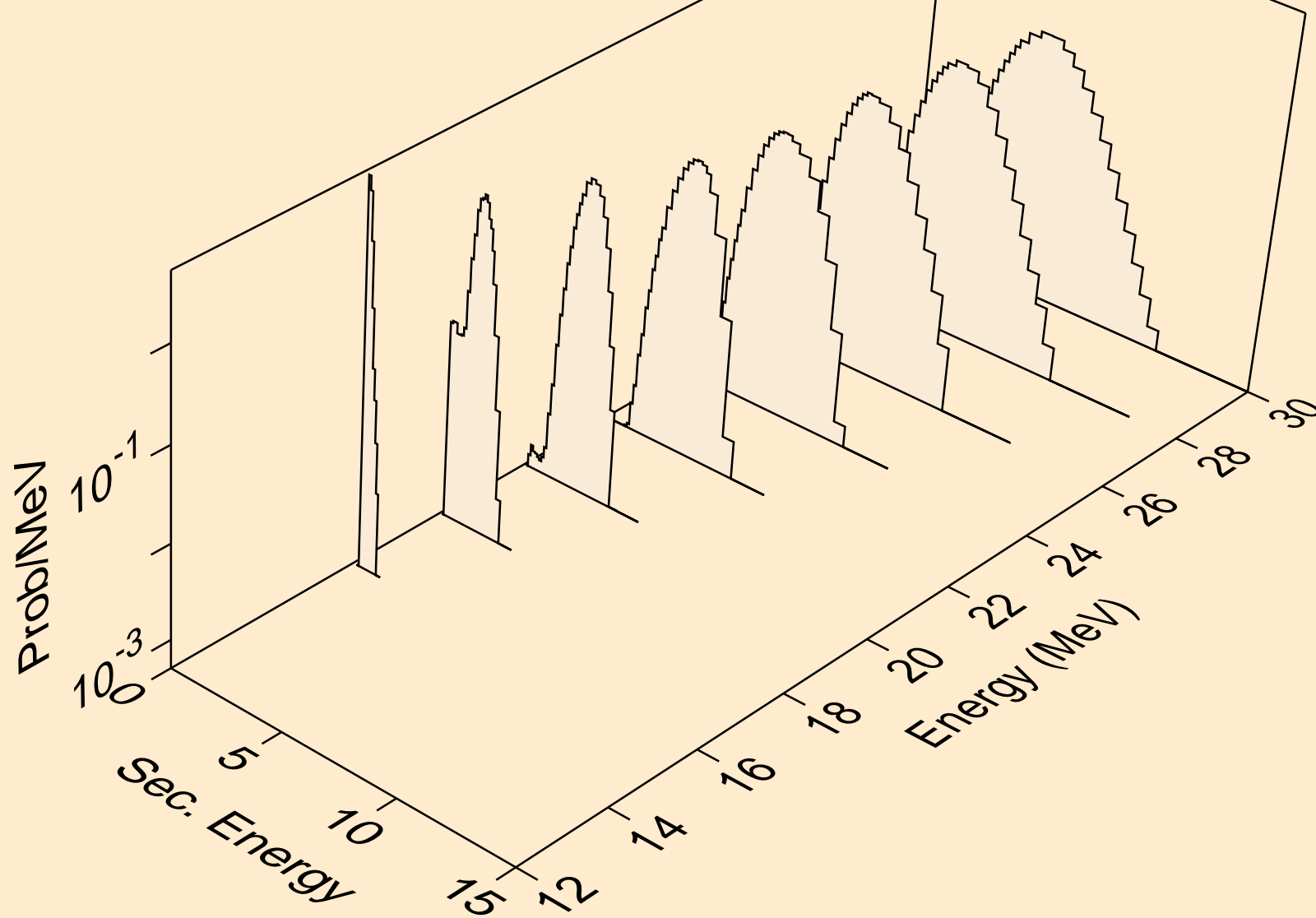

ZN061 PROTON ACER TENDL-2023 LIBRARY; T=0.K
Proton emission for inelastic

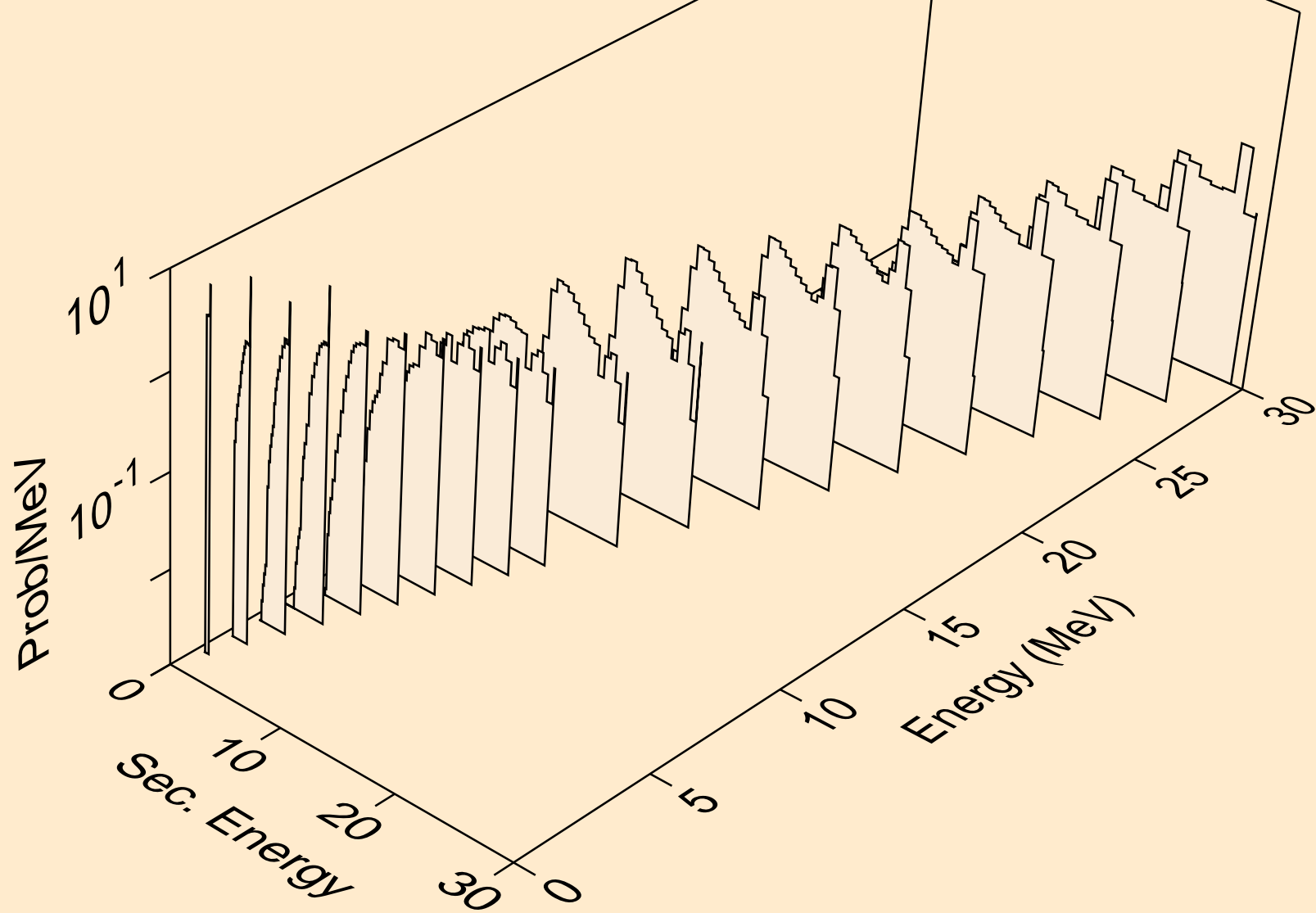

ZN061 PROTON ACER TENDL-2023 LIBRARY; T=0.K
Proton emission for (p,2p)

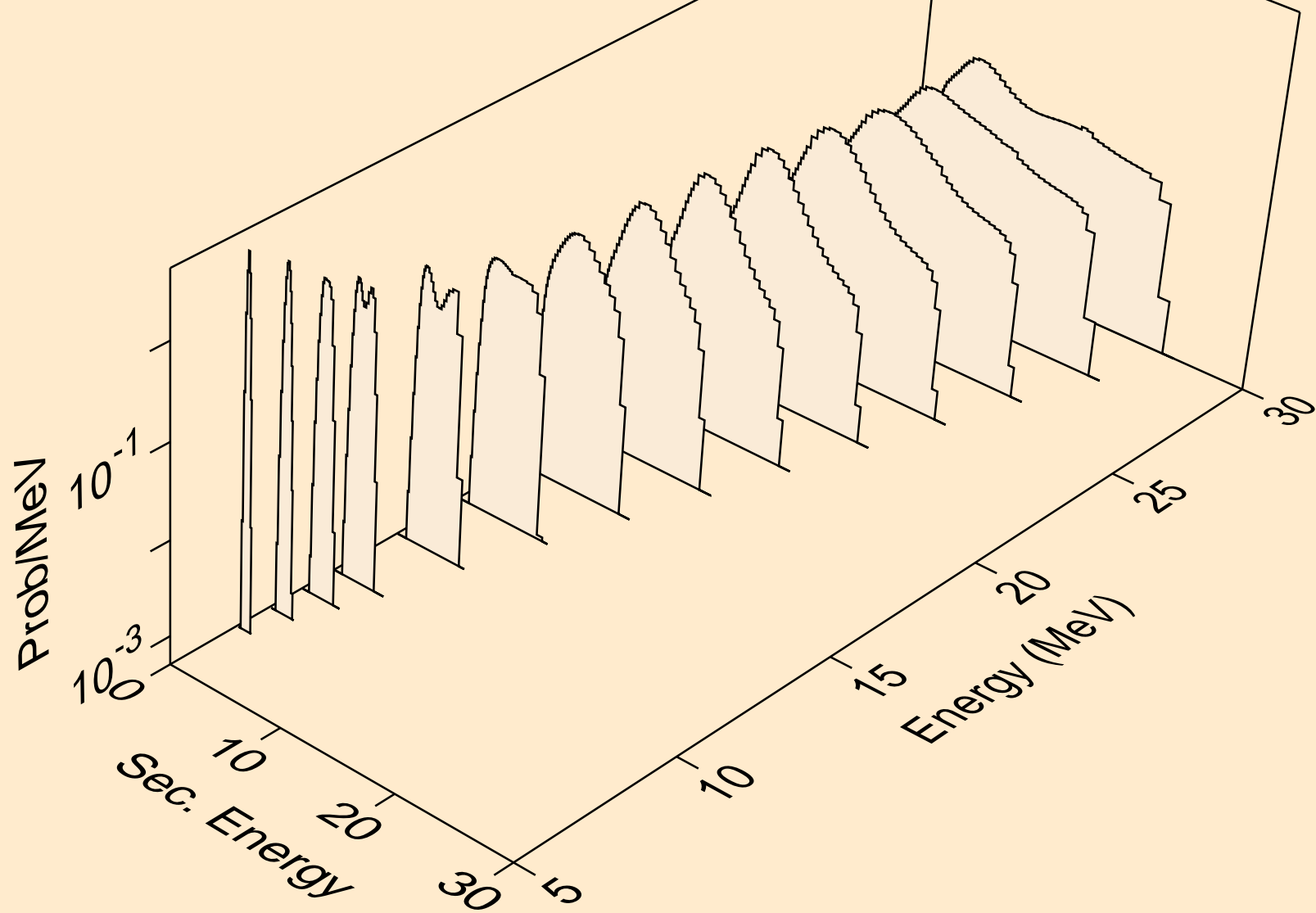

ZN061 PROTON ACER TENDL-2023 LIBRARY; T=0.K
Proton emission for (p,pa)

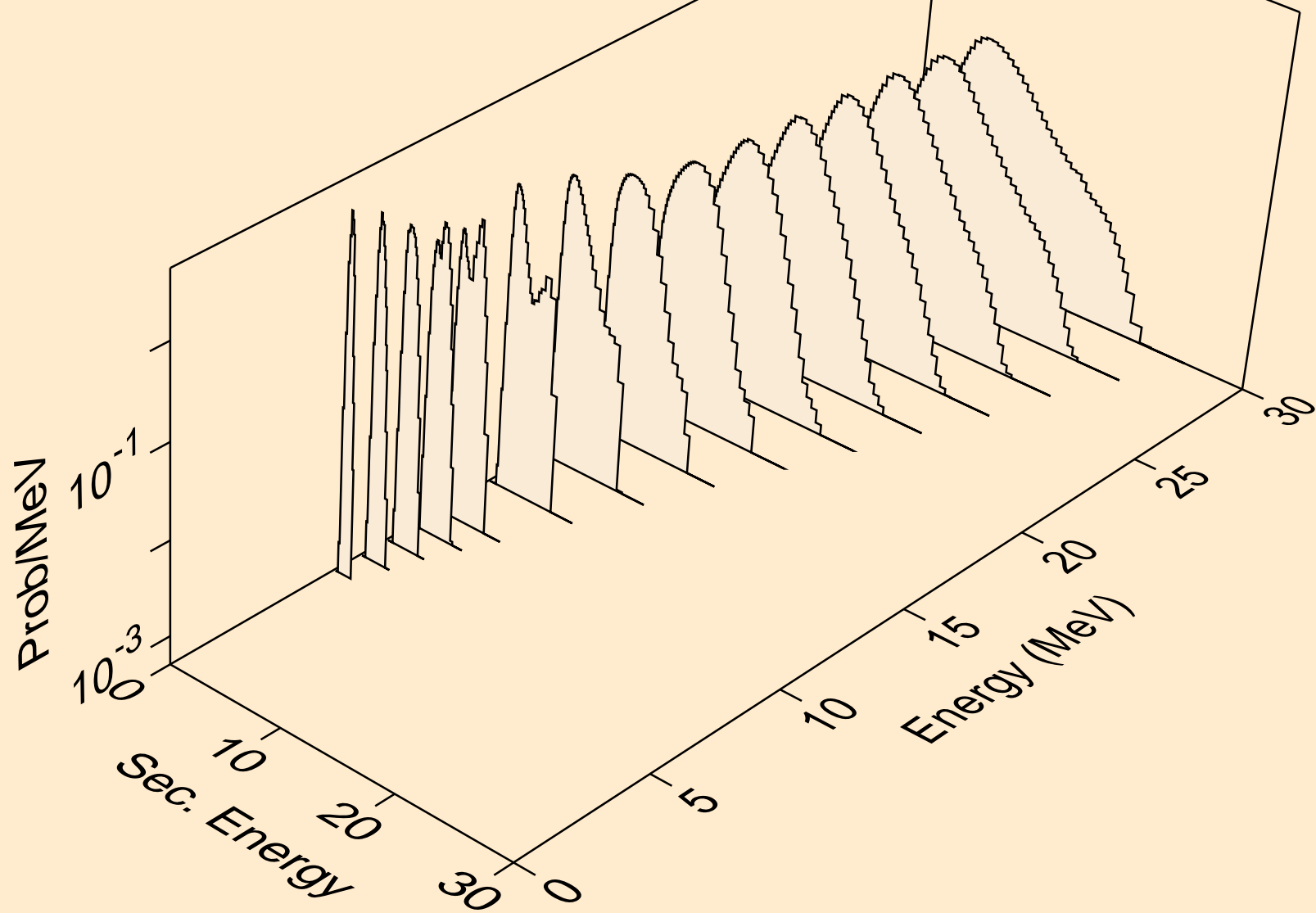

ZN061 PROTON ACER TENDL-2023 LIBRARY; T=0.K
Proton emission for (p,pd)

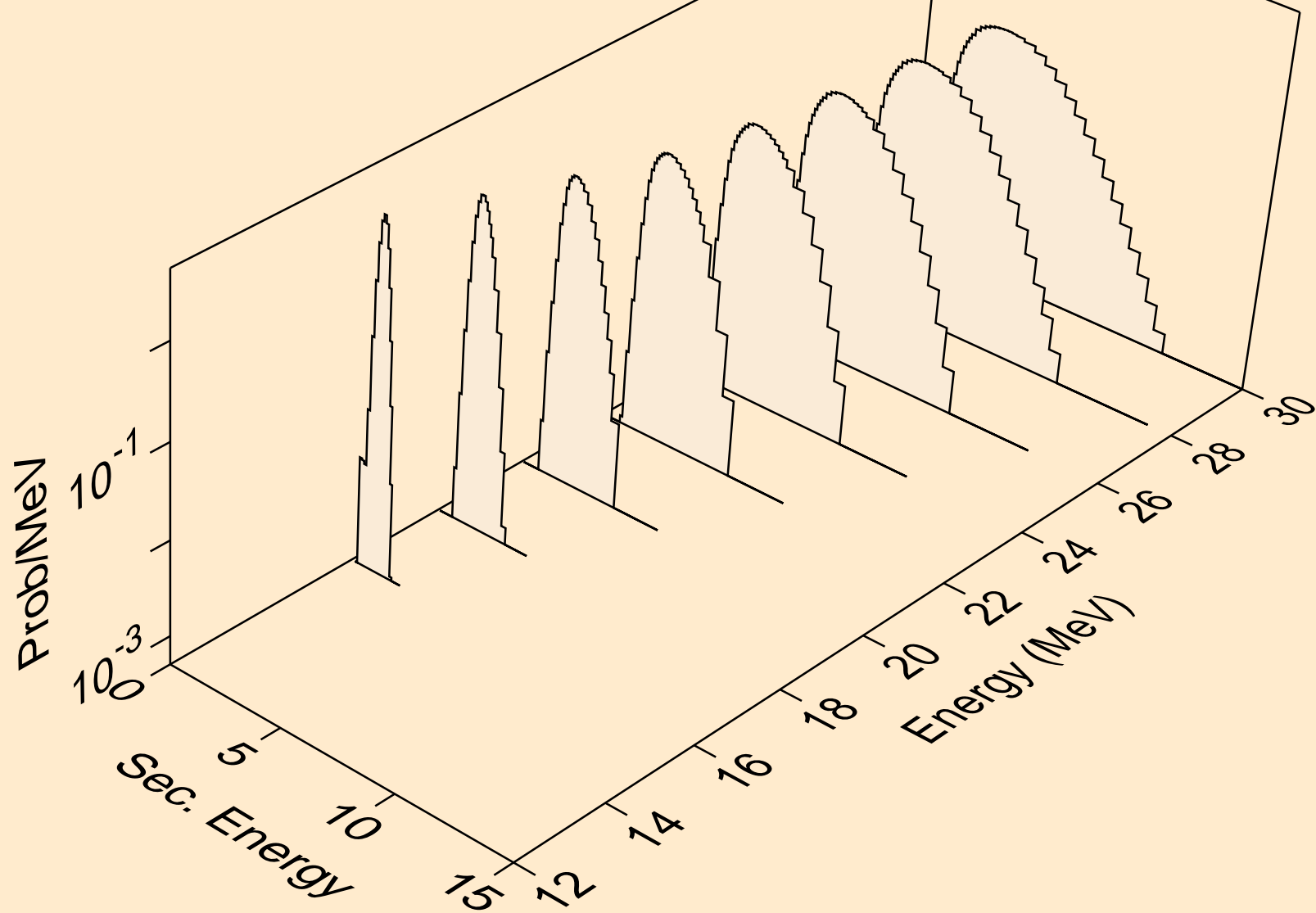

ZN061 PROTON ACER TENDL-2023 LIBRARY; T=0.K
Proton emission for (p,pt)

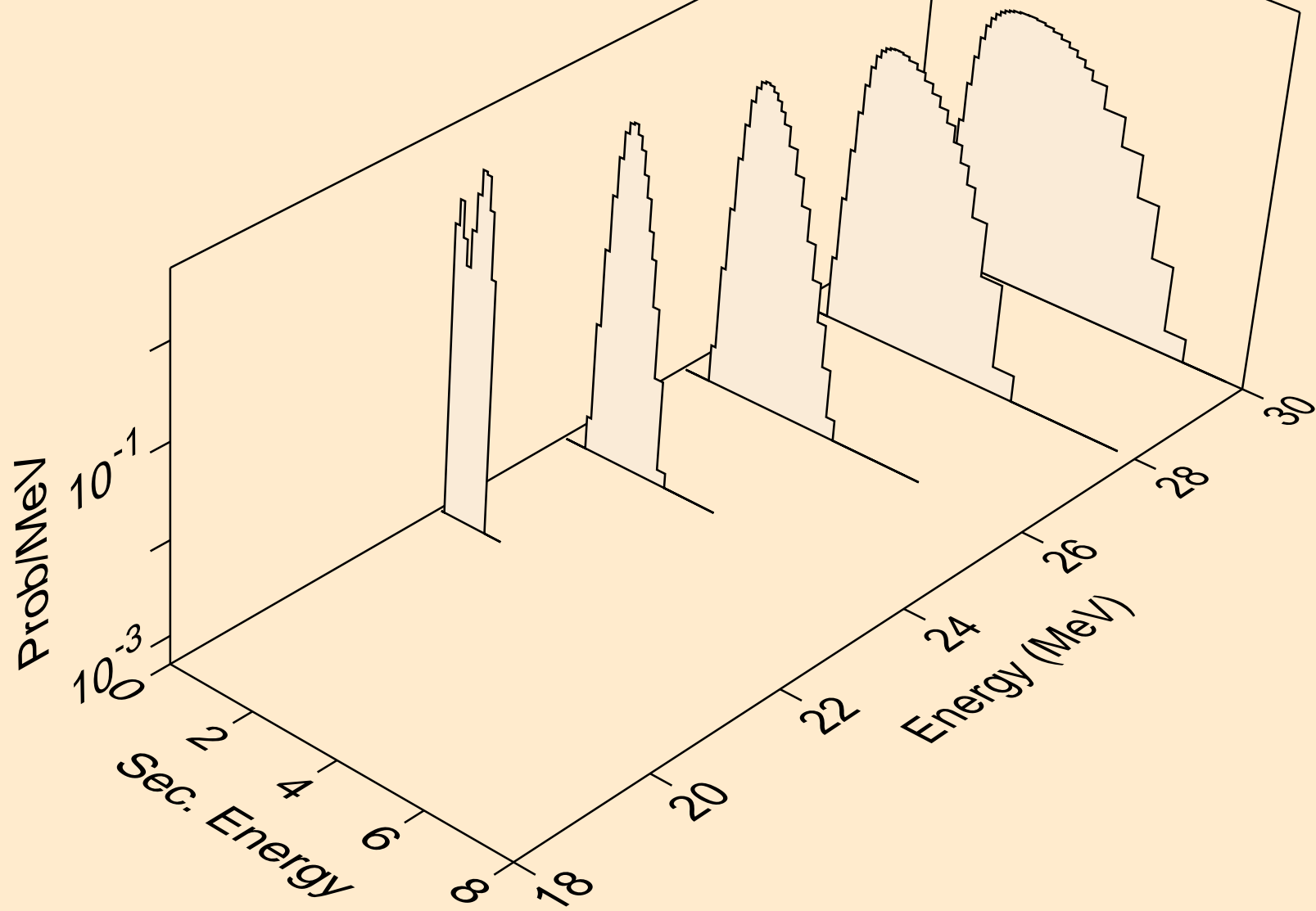

ZN061 PROTON ACER TENDL-2023 LIBRARY; T=0.K
Photon emission for (z,n)

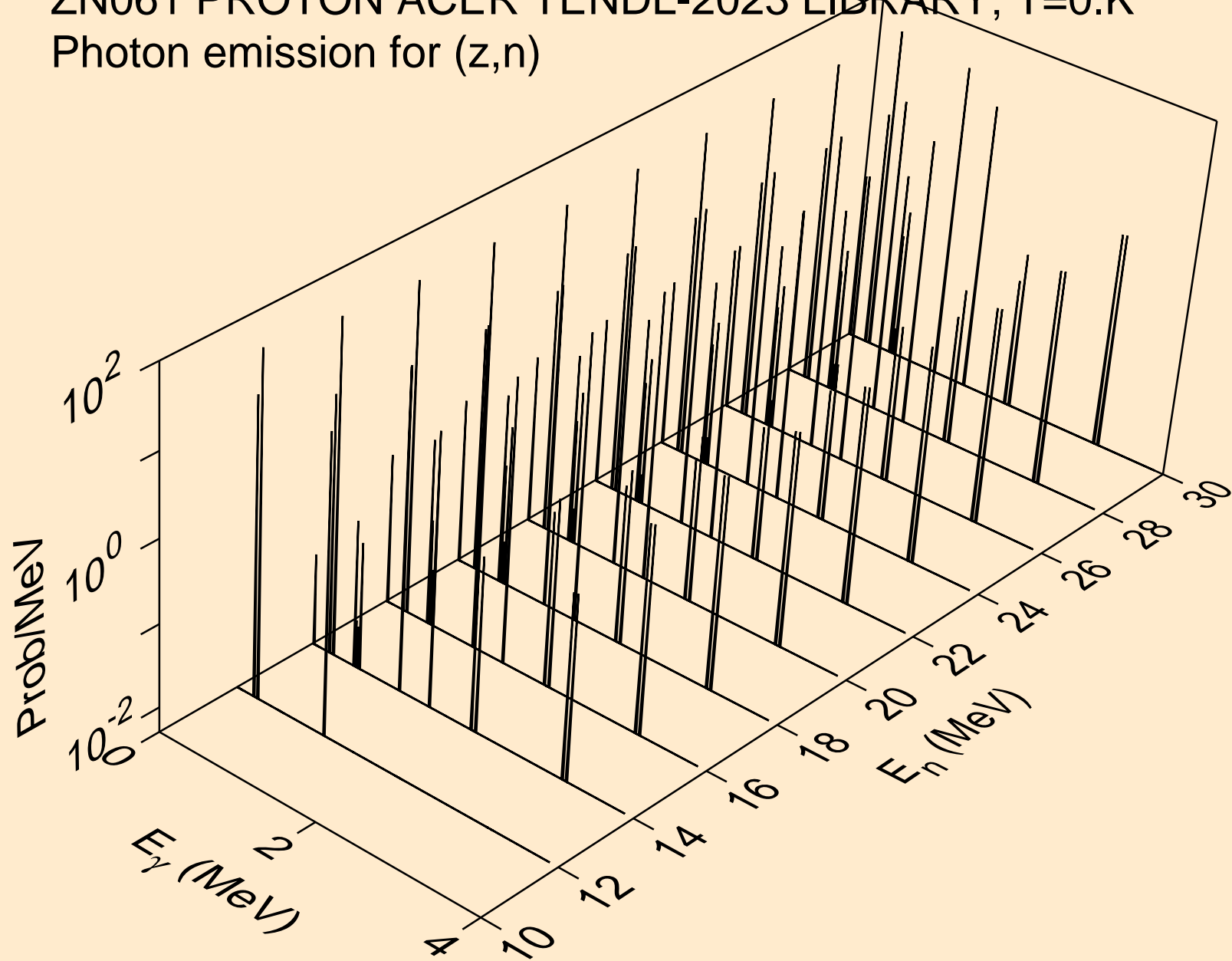

ZN061 PROTON ACER TENDL-2023 LIBRARY; T=0.K
Photon emission for (z,x)

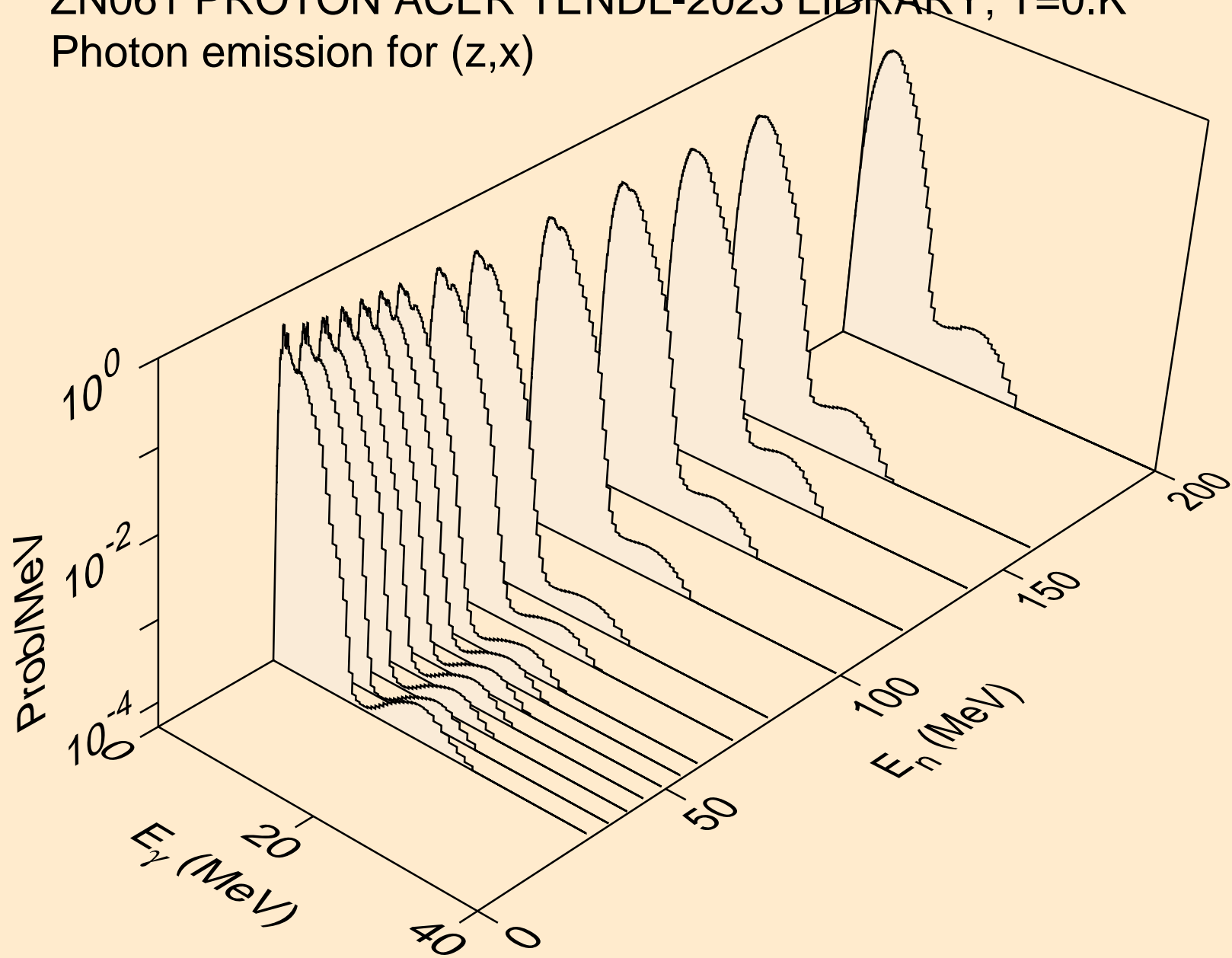

ZN061 PROTON ACER TENDL-2023 LIBRARY; T=0.K
Photon emission for (n,2n)

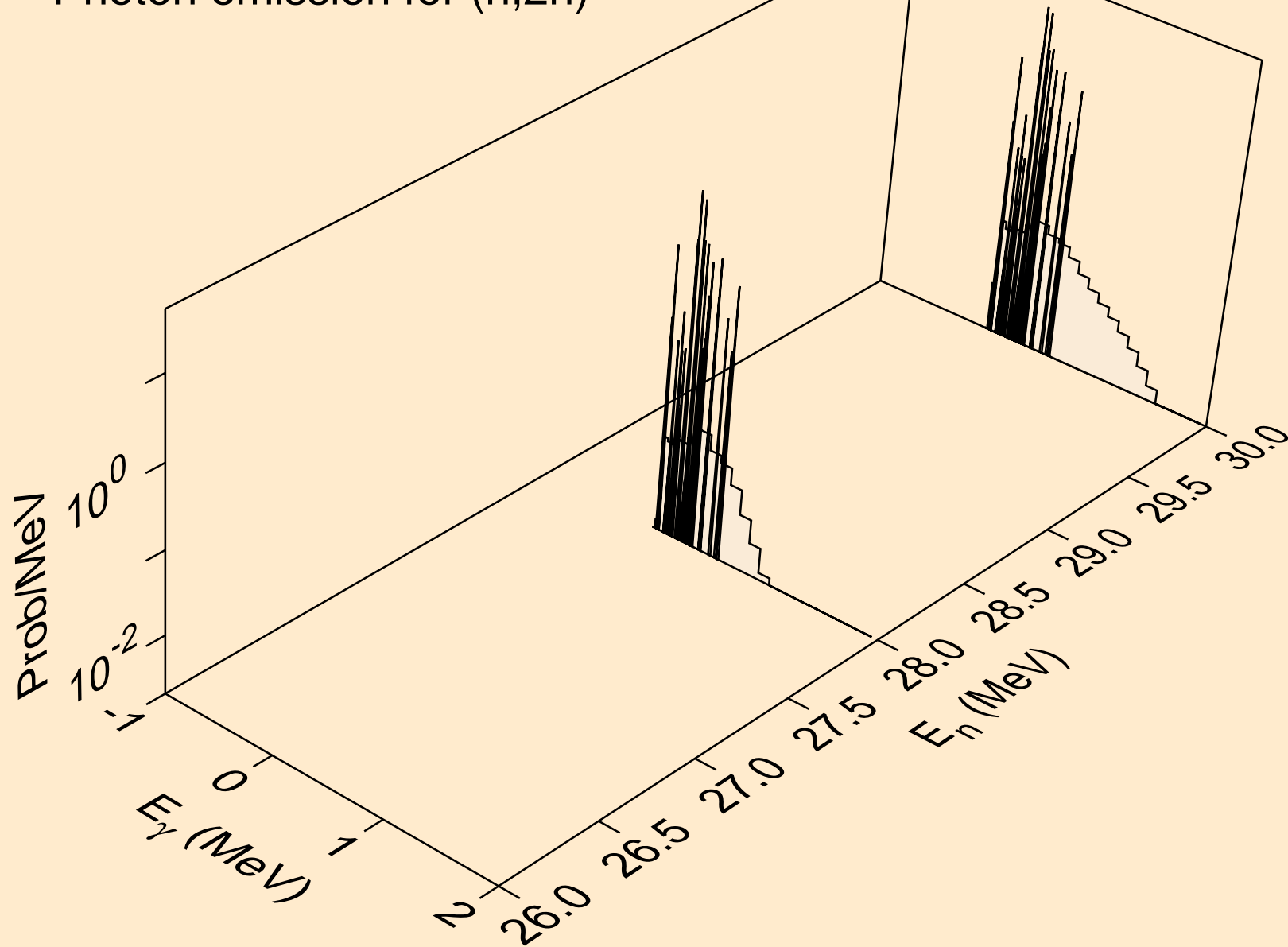

ZN061 PROTON ACER TENDL-2023 LIBRARY; T=0.K
Photon emission for (n,n*)a

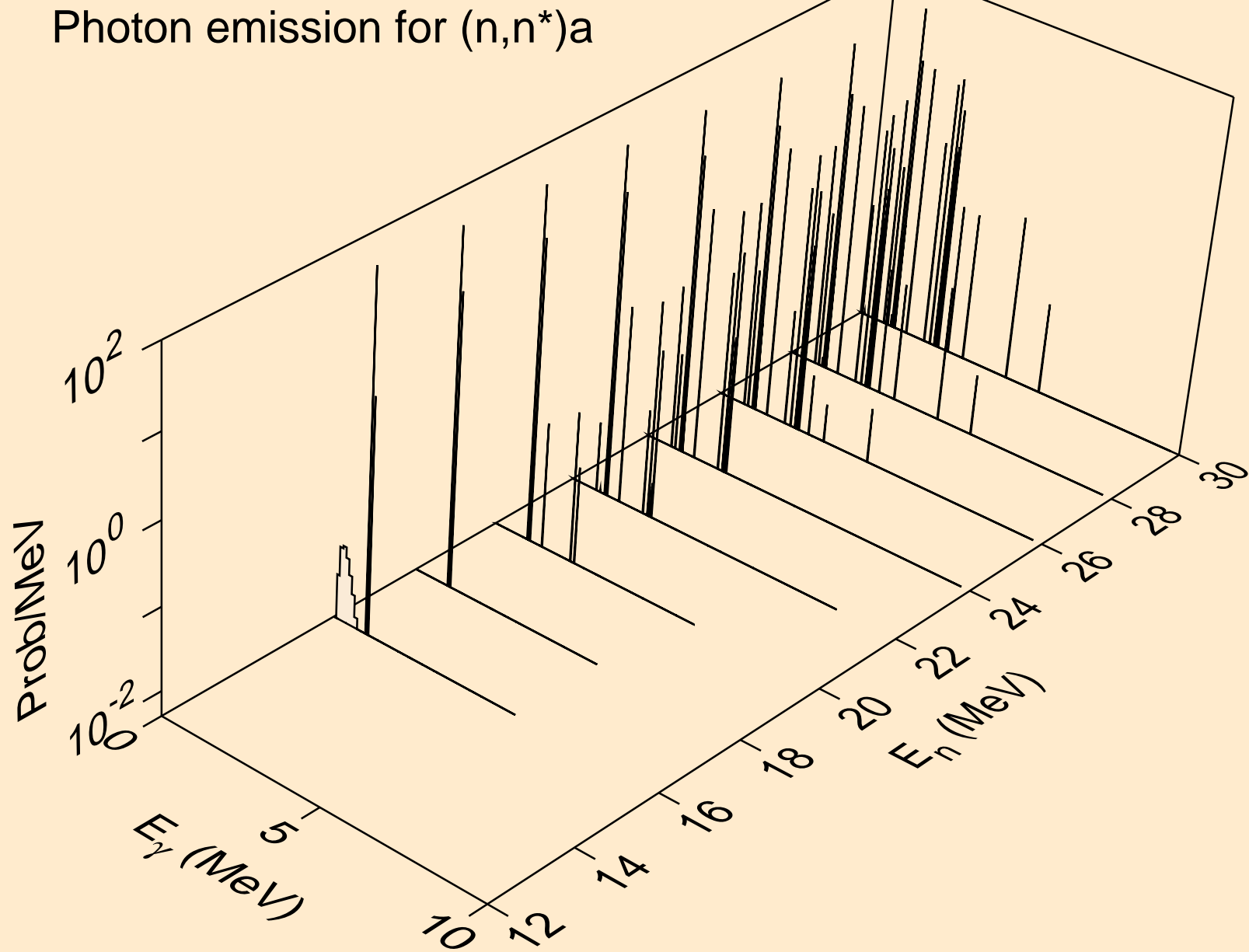

ZN061 PROTON ACER TENDL-2023 LIBRARY; T=0.K
Photon emission for (n,n*)p

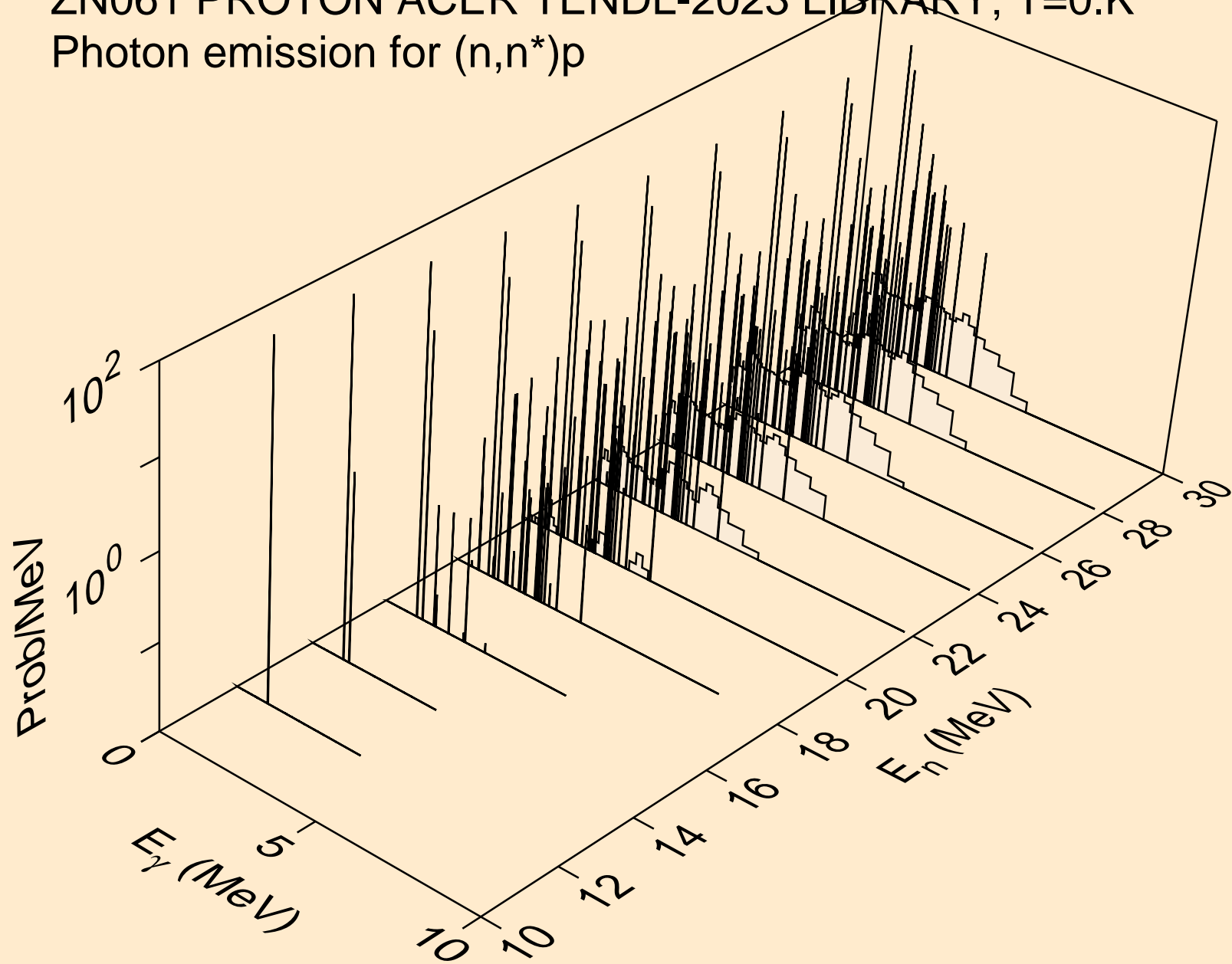

ZN061 PROTON ACER TENDL-2023 LIBRARY; T=0.K
Photon emission for (n,n*)d

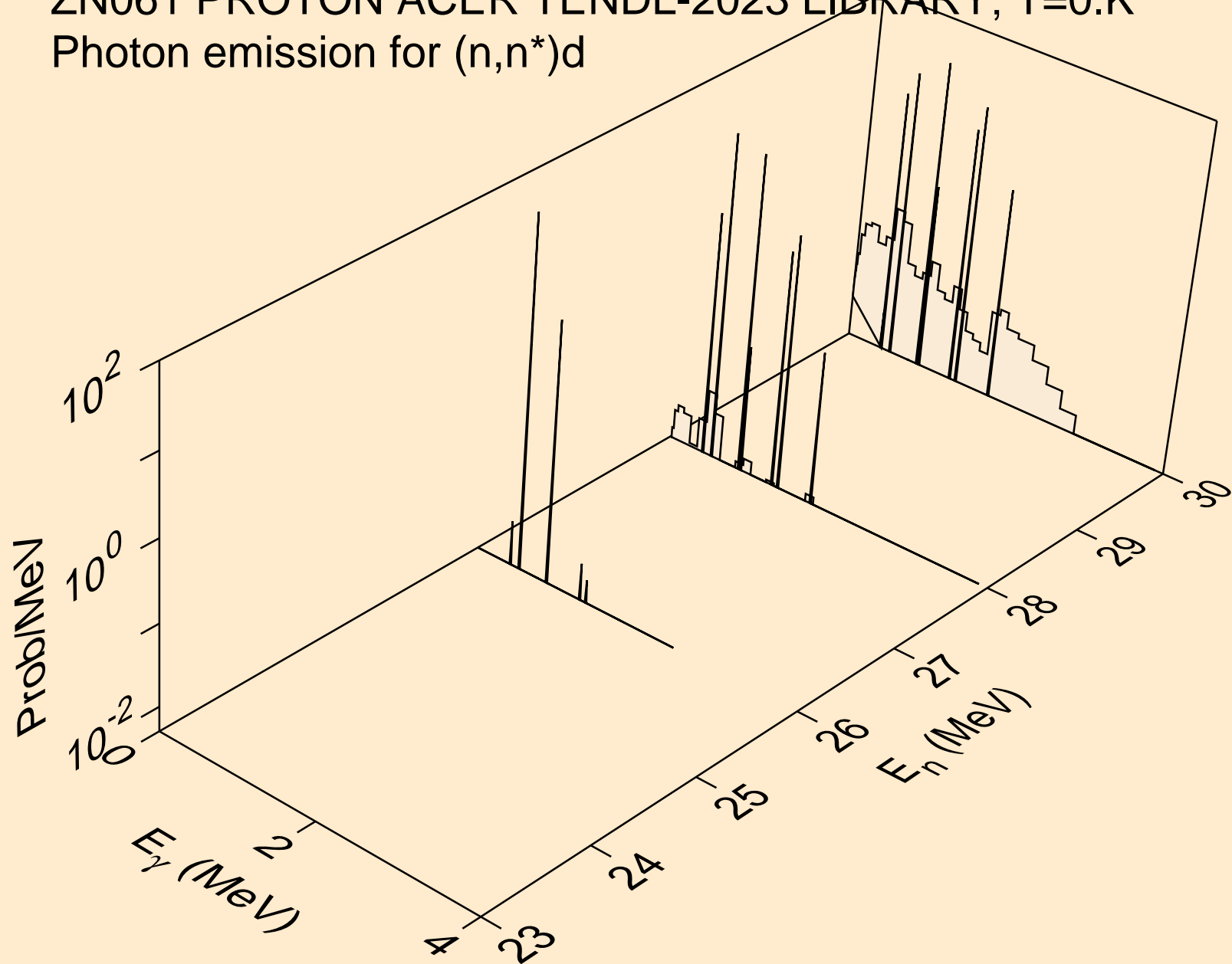

ZN061 PROTON ACER TENDL-2023 LIBRARY; T=0.K
Photon emission for (n,n*)he3

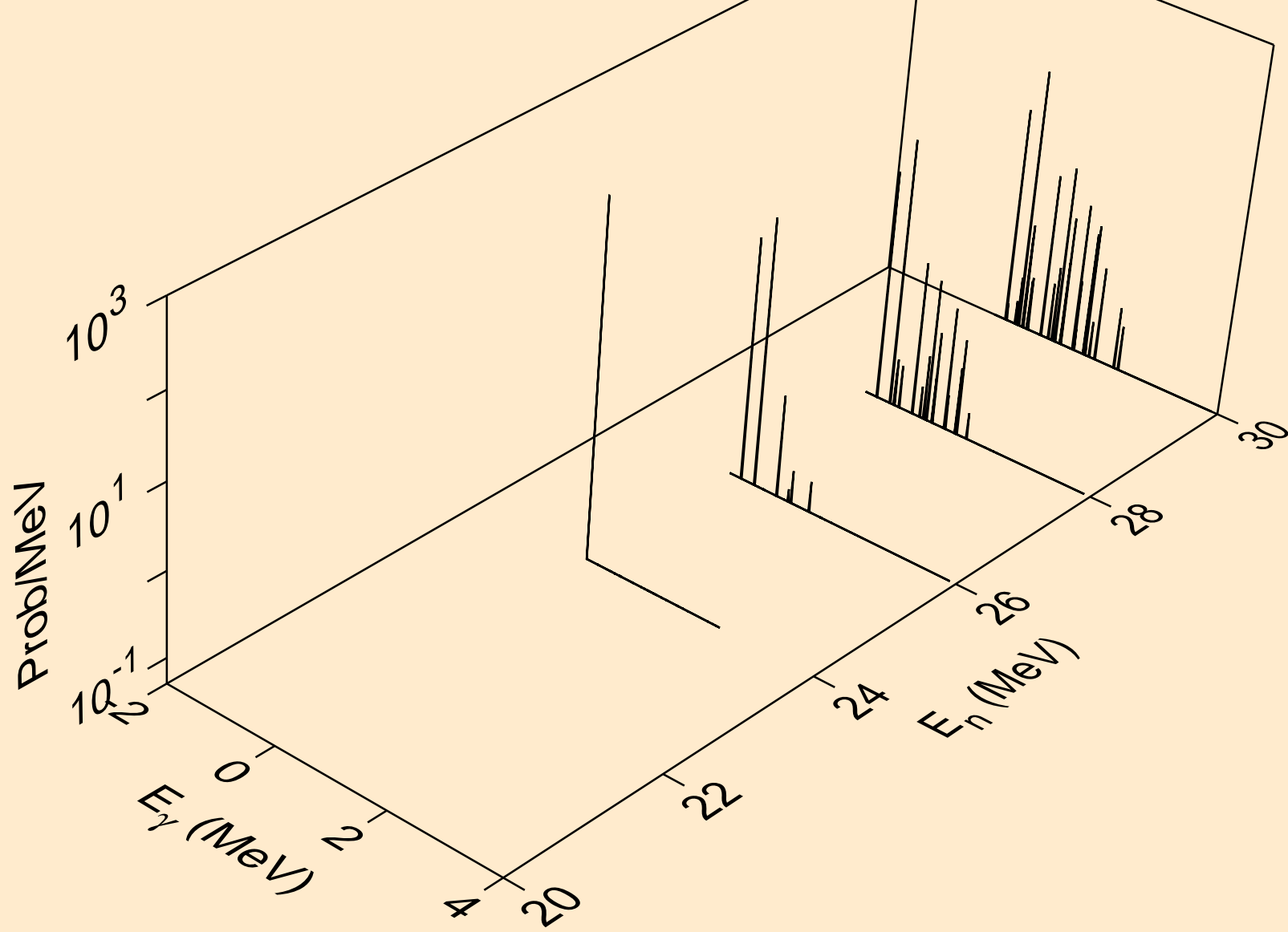

ZN061 PROTON ACER TENDL-2023 LIBRARY; T=0.K
Photon emission for (n,2np)

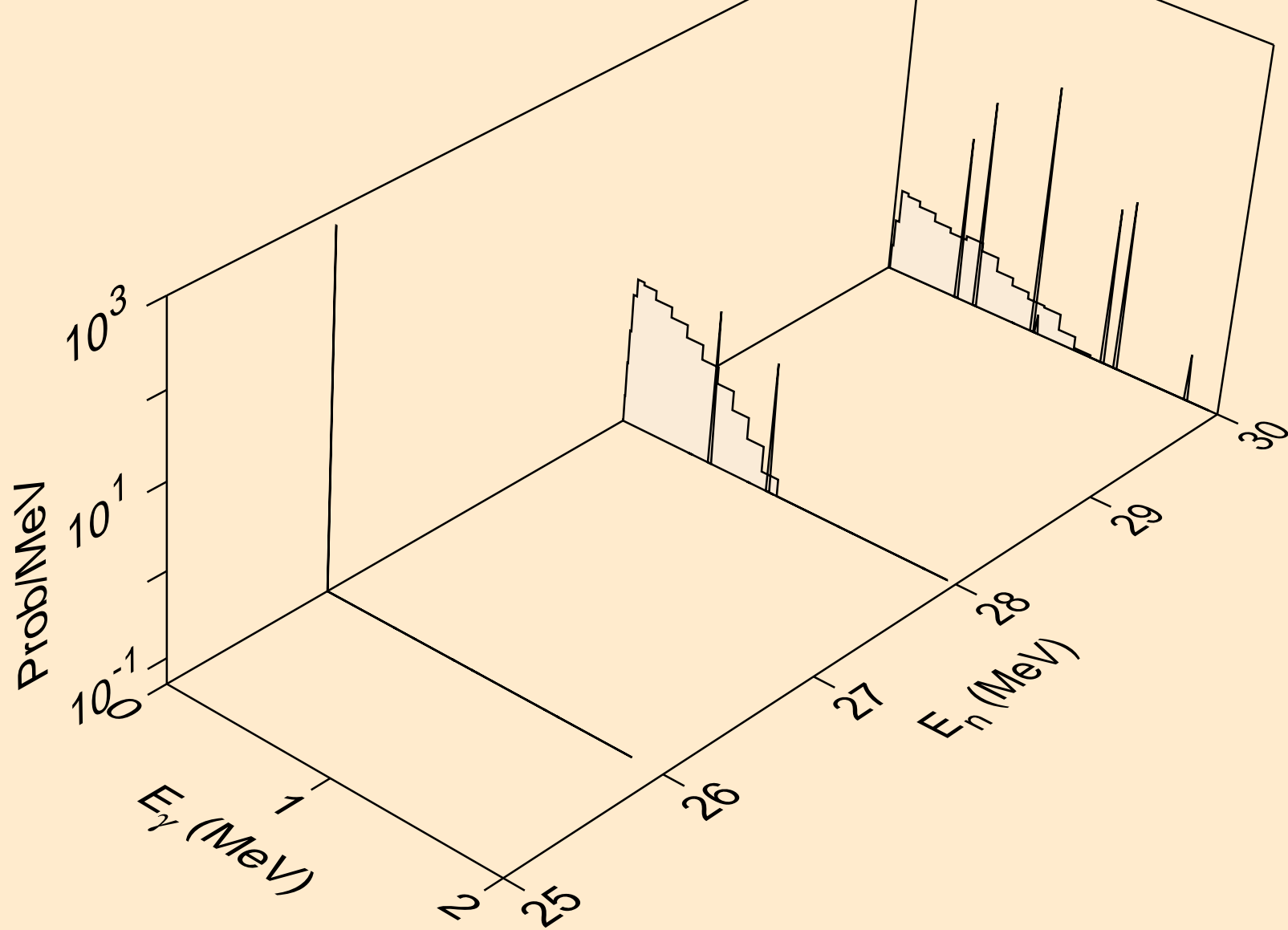

ZN061 PROTON ACER TENDL-2023 LIBRARY; T=0.K
Photon emission for (n,n2p)

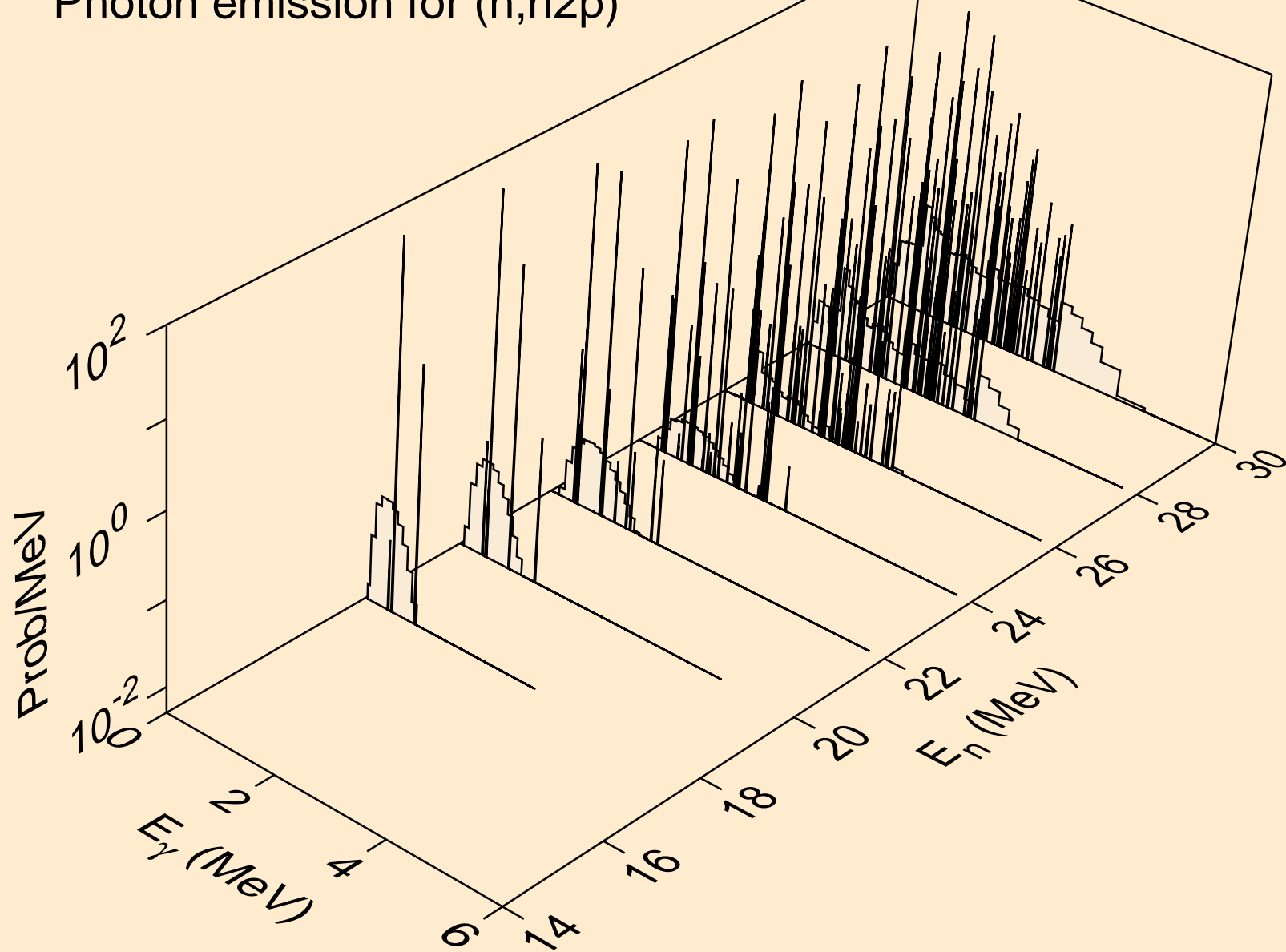

ZN061 PROTON ACER TENDL-2023 LIBRARY; T=0.K
Photon emission for (n,npa)

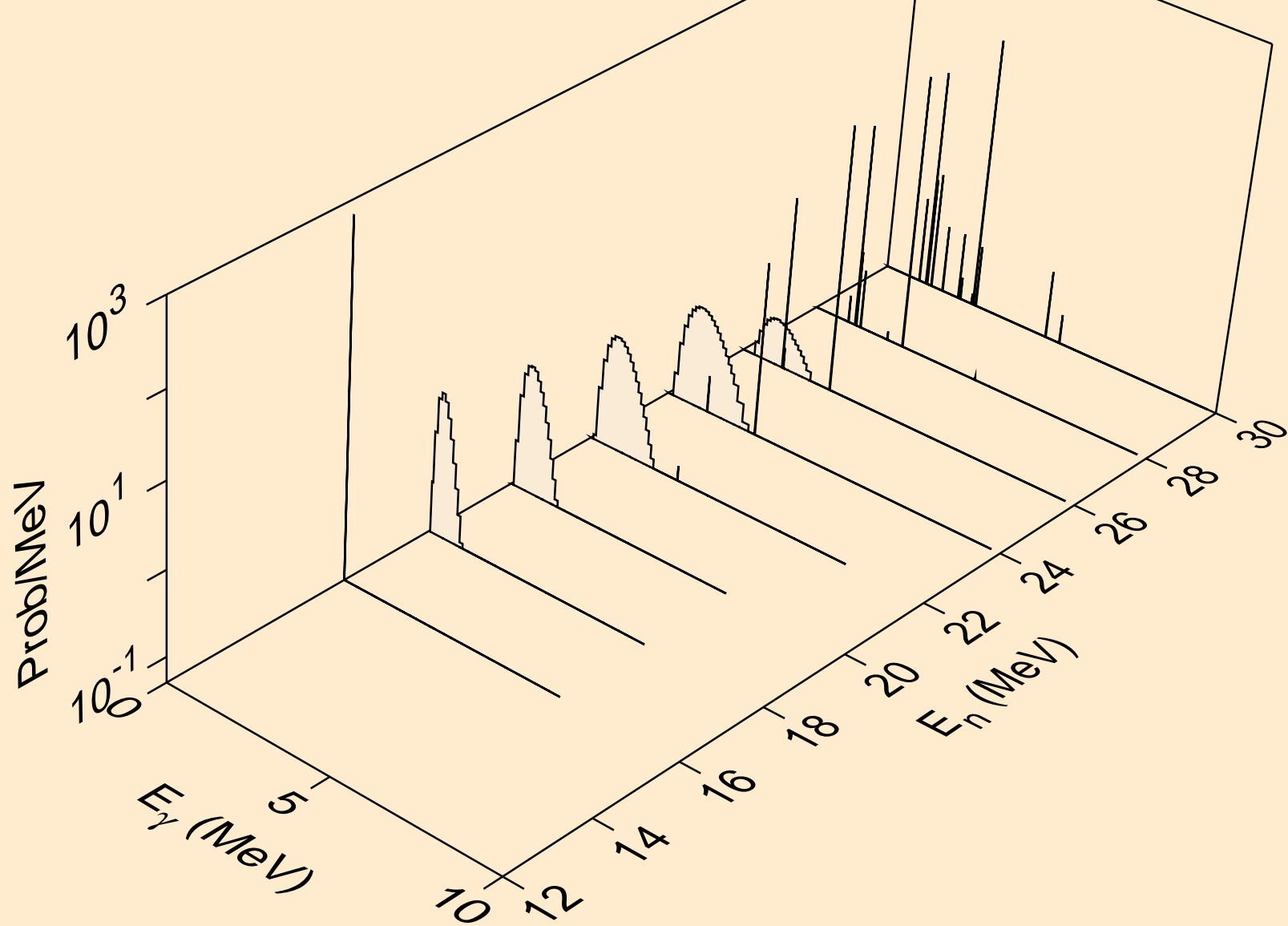

ZN061 PROTON ACER TENDL-2023 LIBRARY; T=0.K
Photon emission for (n,gma)

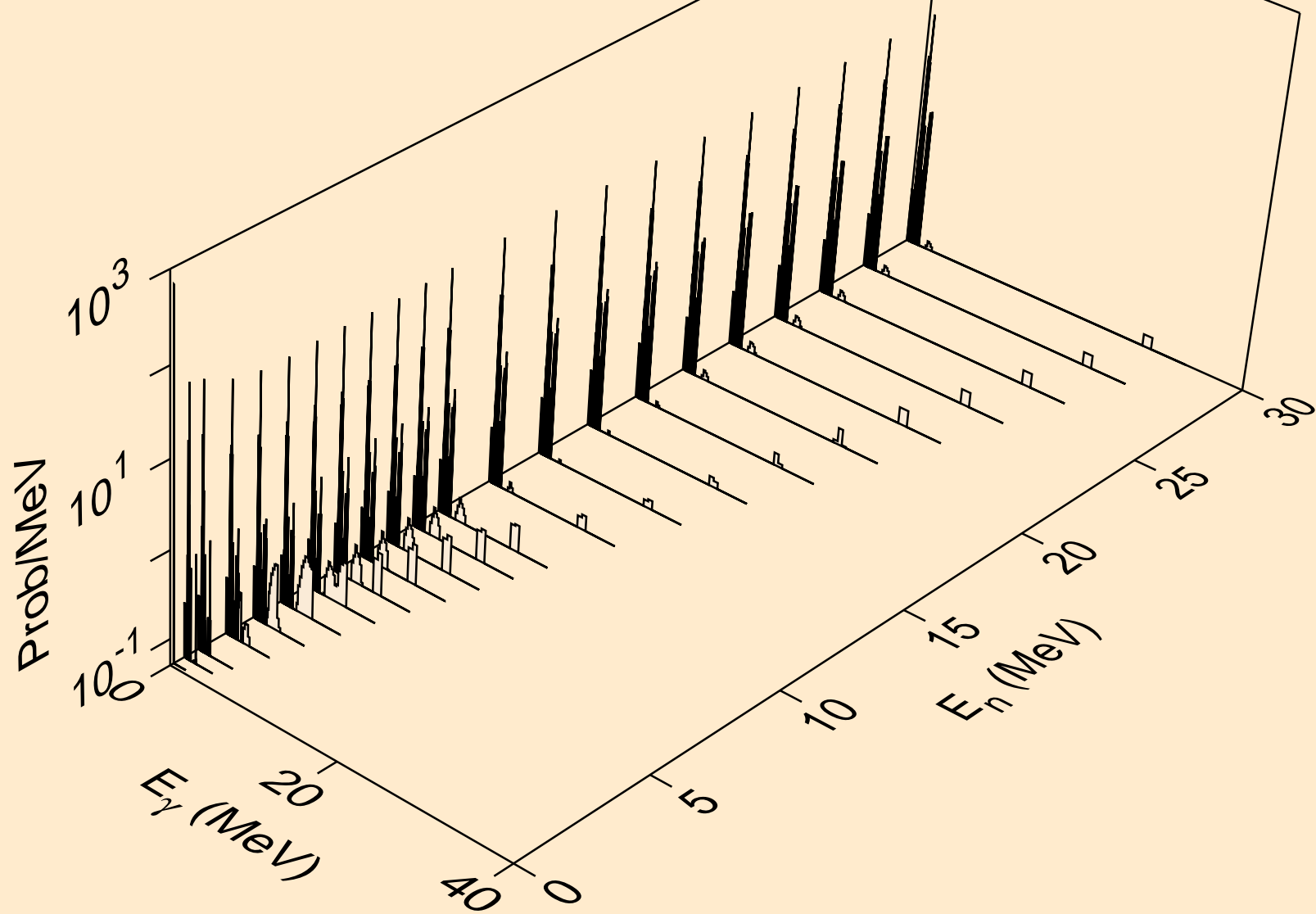

ZN061 PROTON ACER TENDL-2023 LIBRARY; T=0.K
Photon emission for inelastic

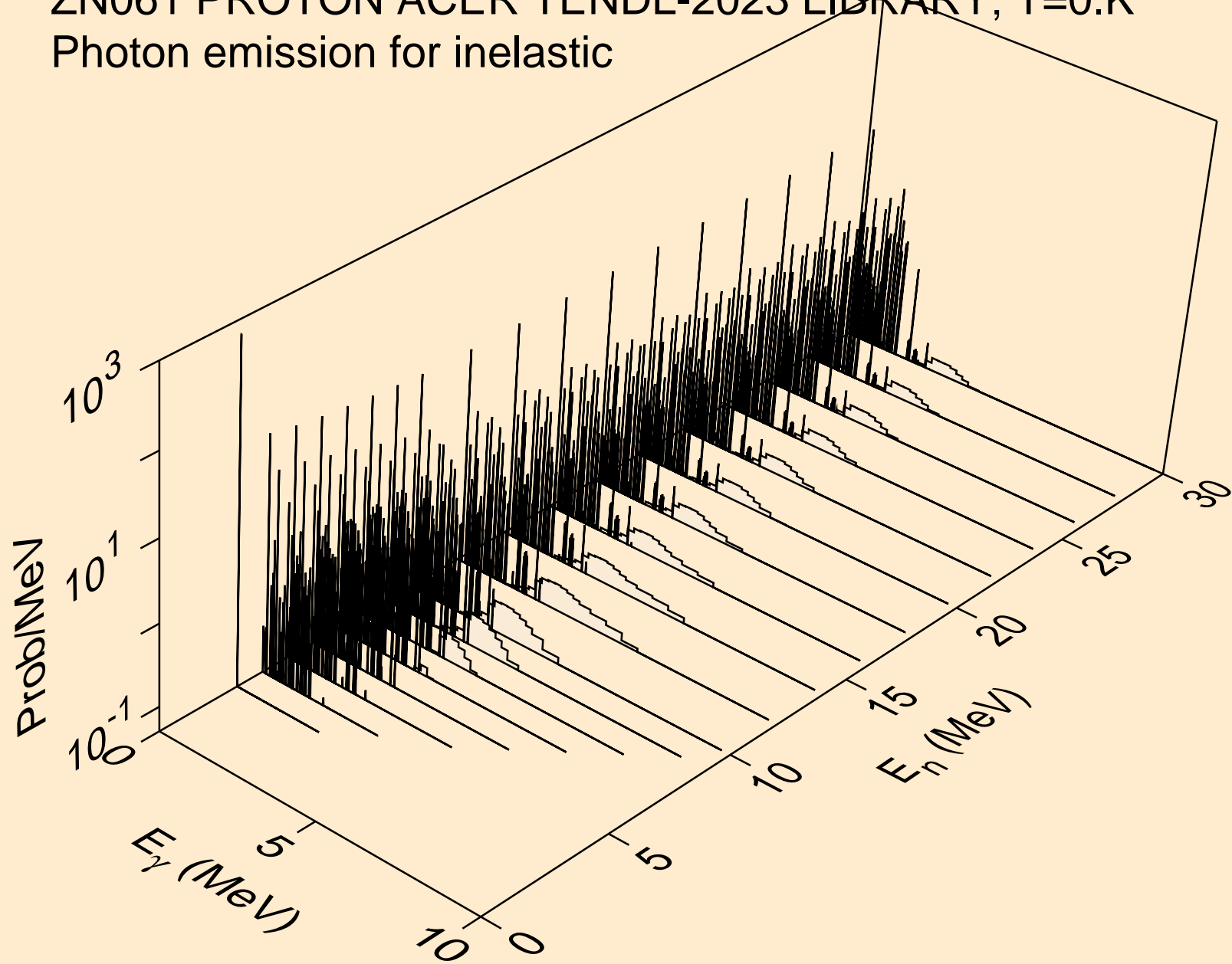

ZN061 PROTON ACER TENDL-2023 LIBRARY; T=0.K
Photon emission for (n,d)

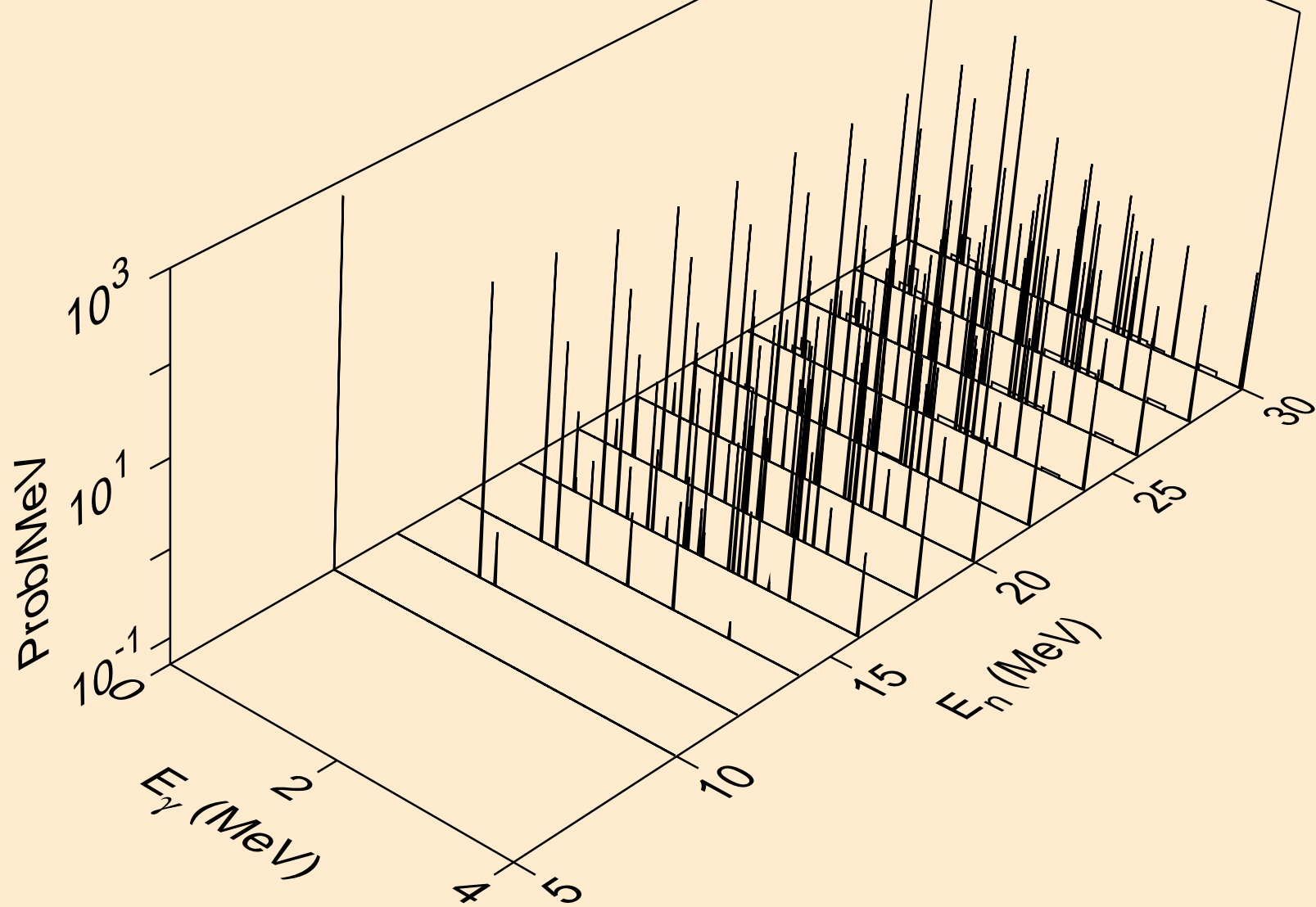

ZN061 PROTON ACER TENDL-2023 LIBRARY; T=0.K
Photon emission for (n,t)

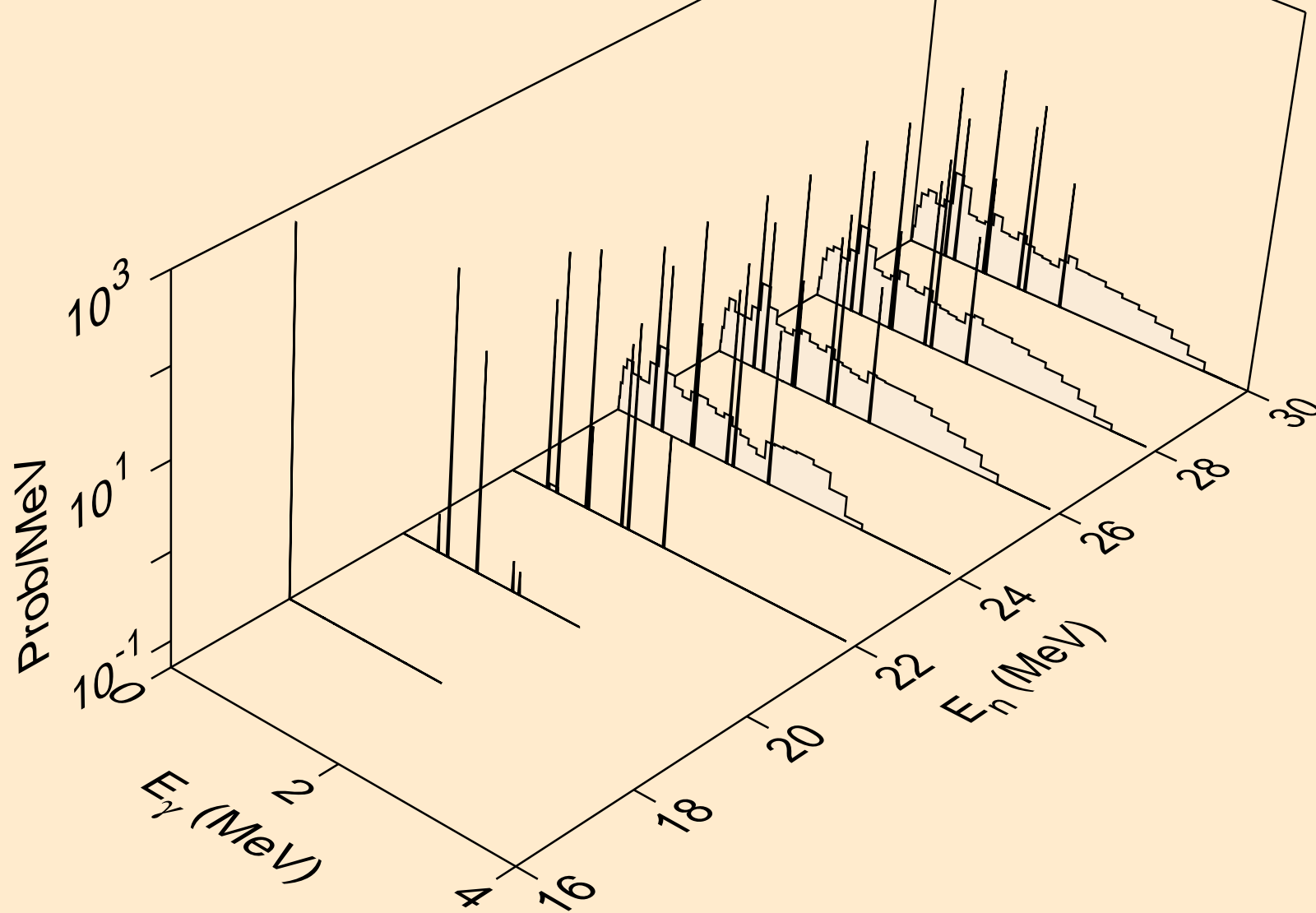

ZN061 PROTON ACER TENDL-2023 LIBRARY; T=0.K
Photon emission for (n,he3)

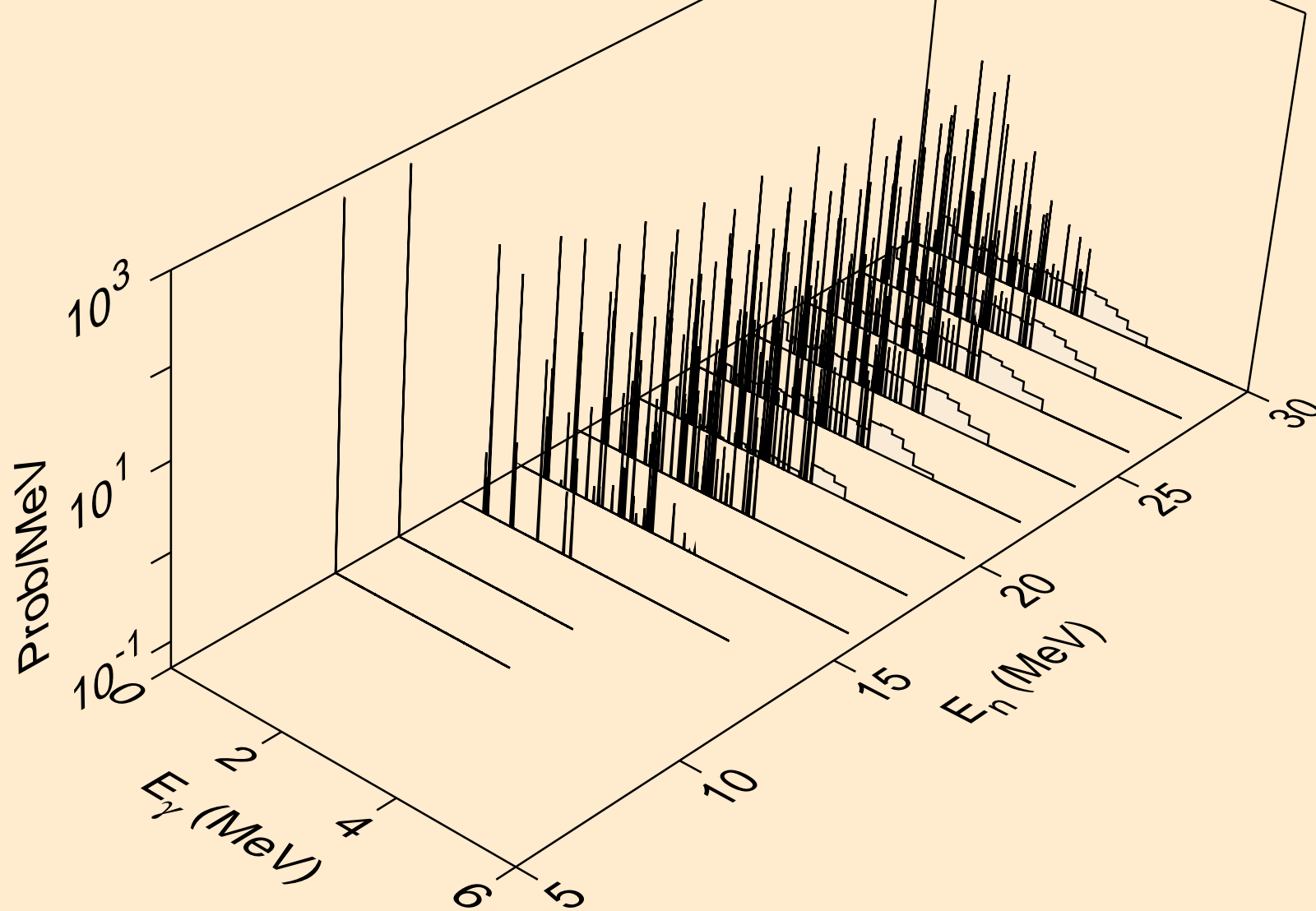

ZN061 PROTON ACER TENDL-2023 LIBRARY; T=0.K
Photon emission for (n,a)

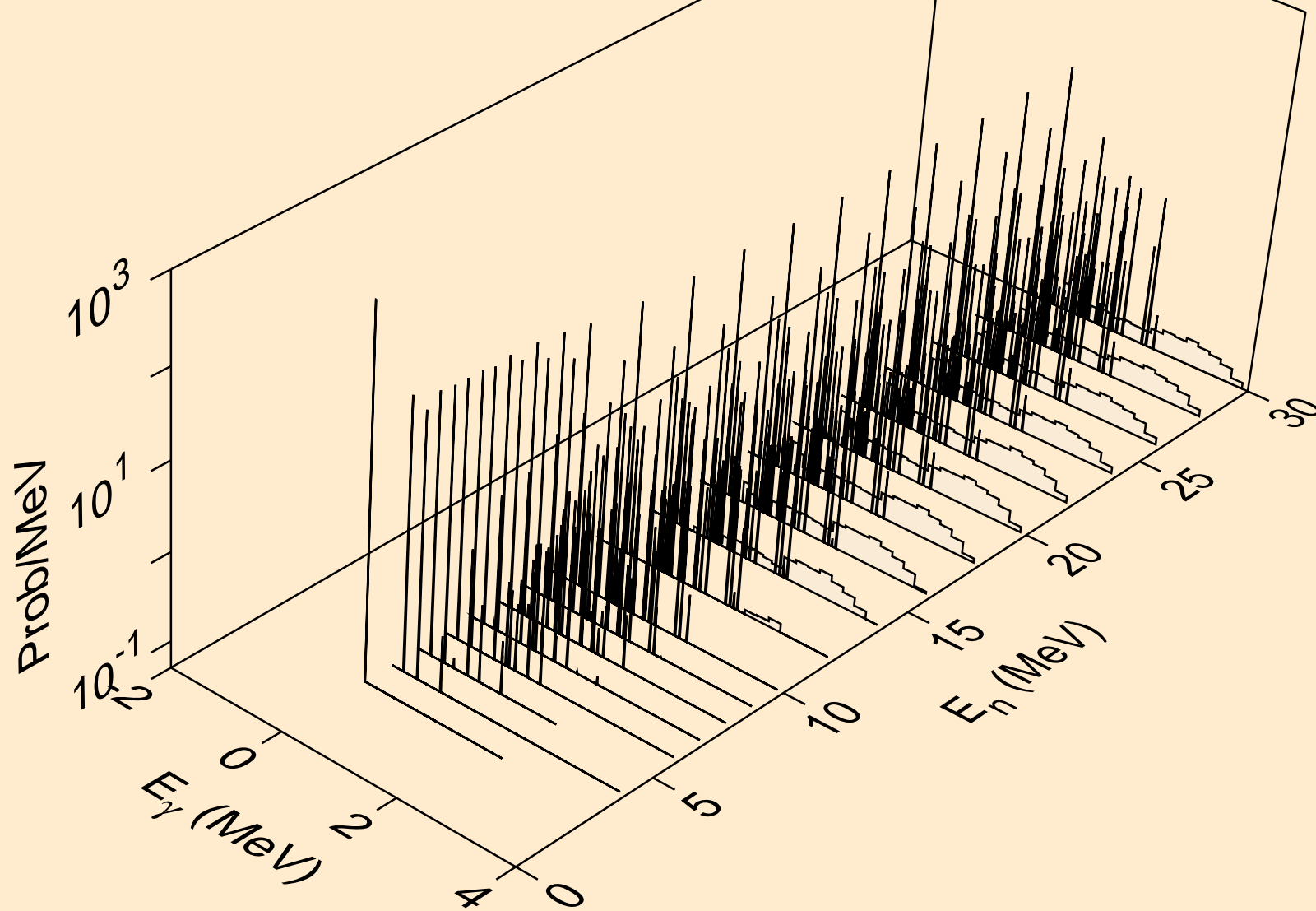

ZN061 PROTON ACER TENDL-2023 LIBRARY; T=0.K
Photon emission for (n,2a)

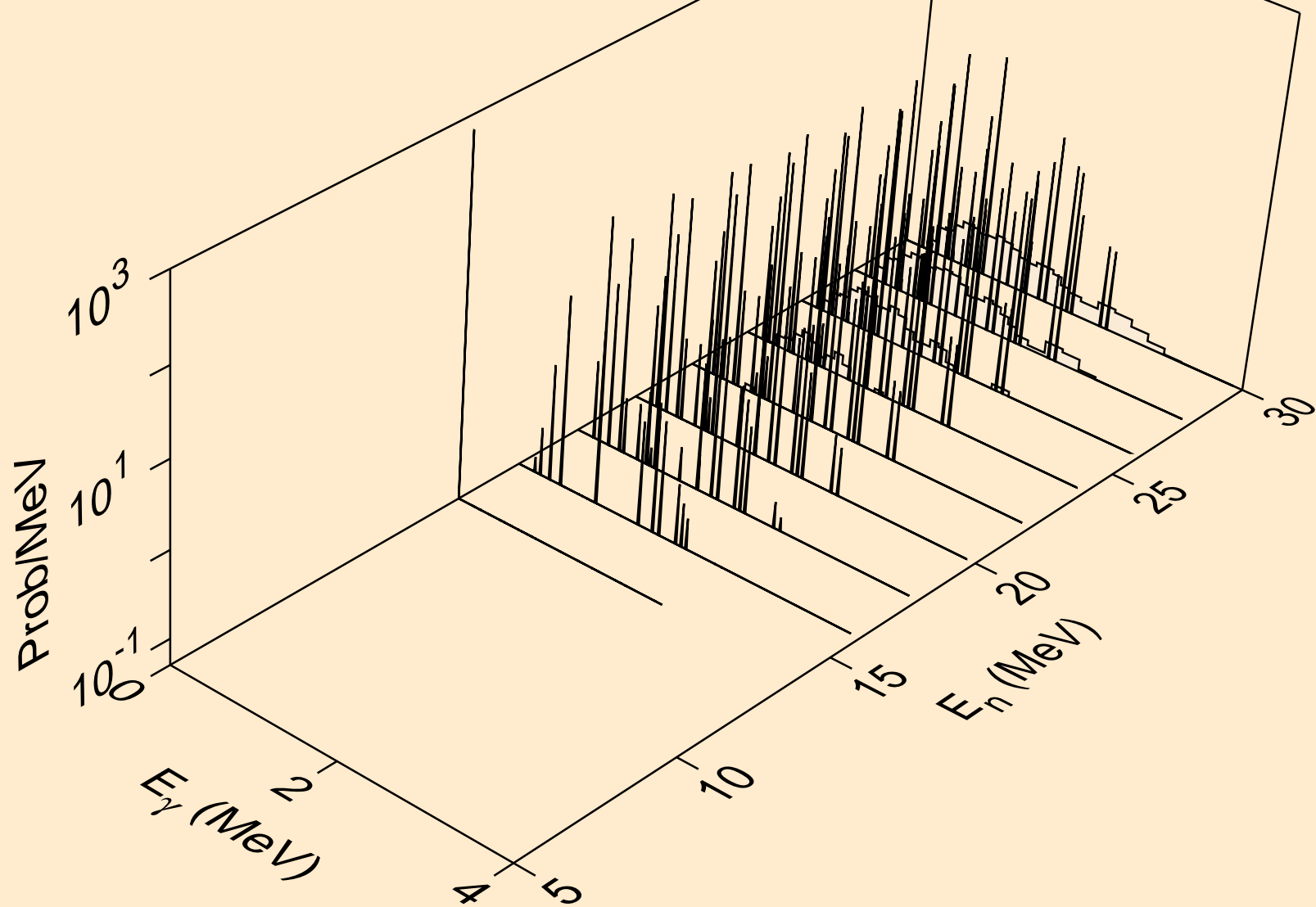

ZN061 PROTON ACER TENDL-2023 LIBRARY; T=0.K
Photon emission for (n,2p)

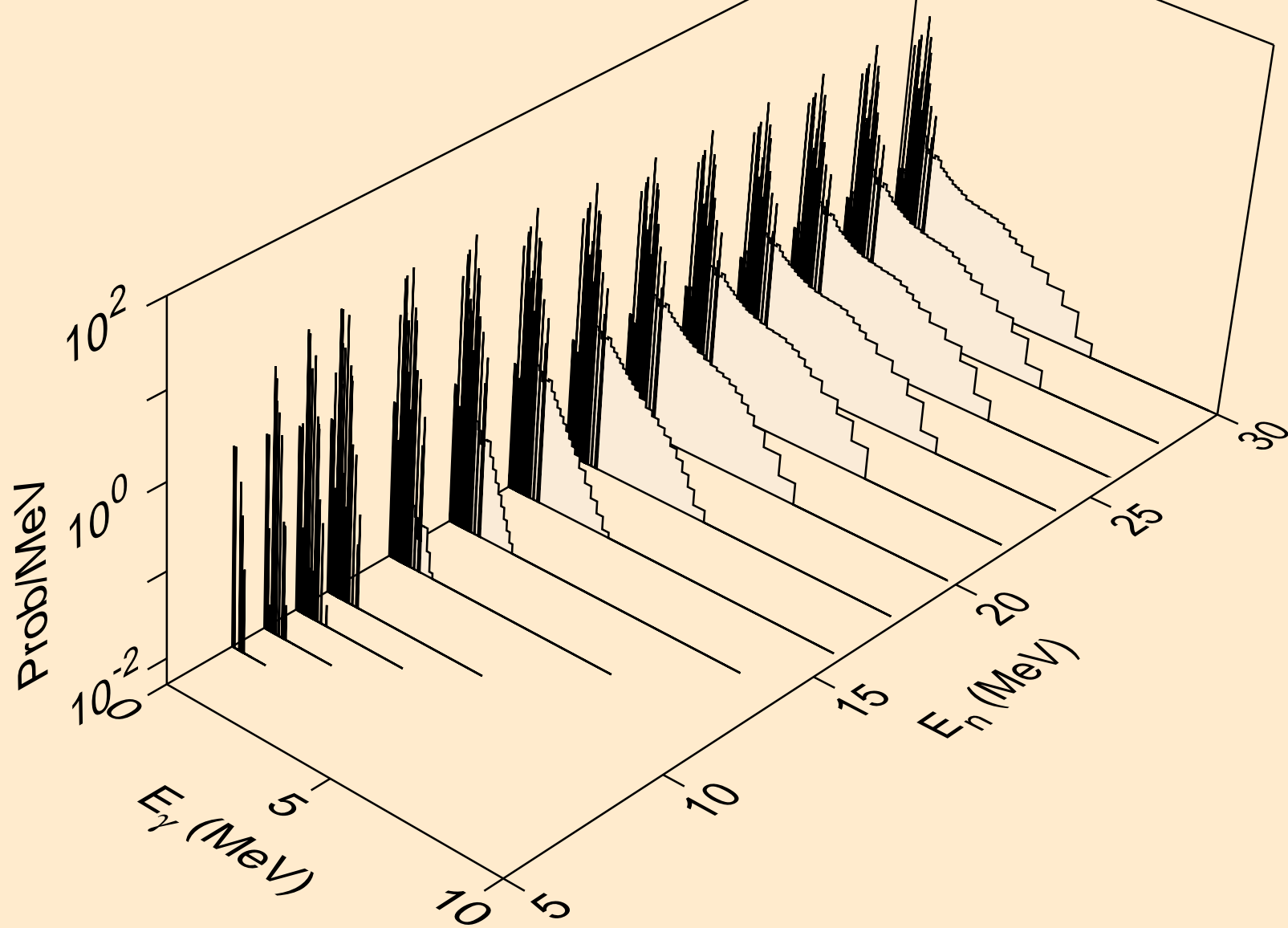

ZN061 PROTON ACER TENDL-2023 LIBRARY; T=0.K
Photon emission for (n,pa)

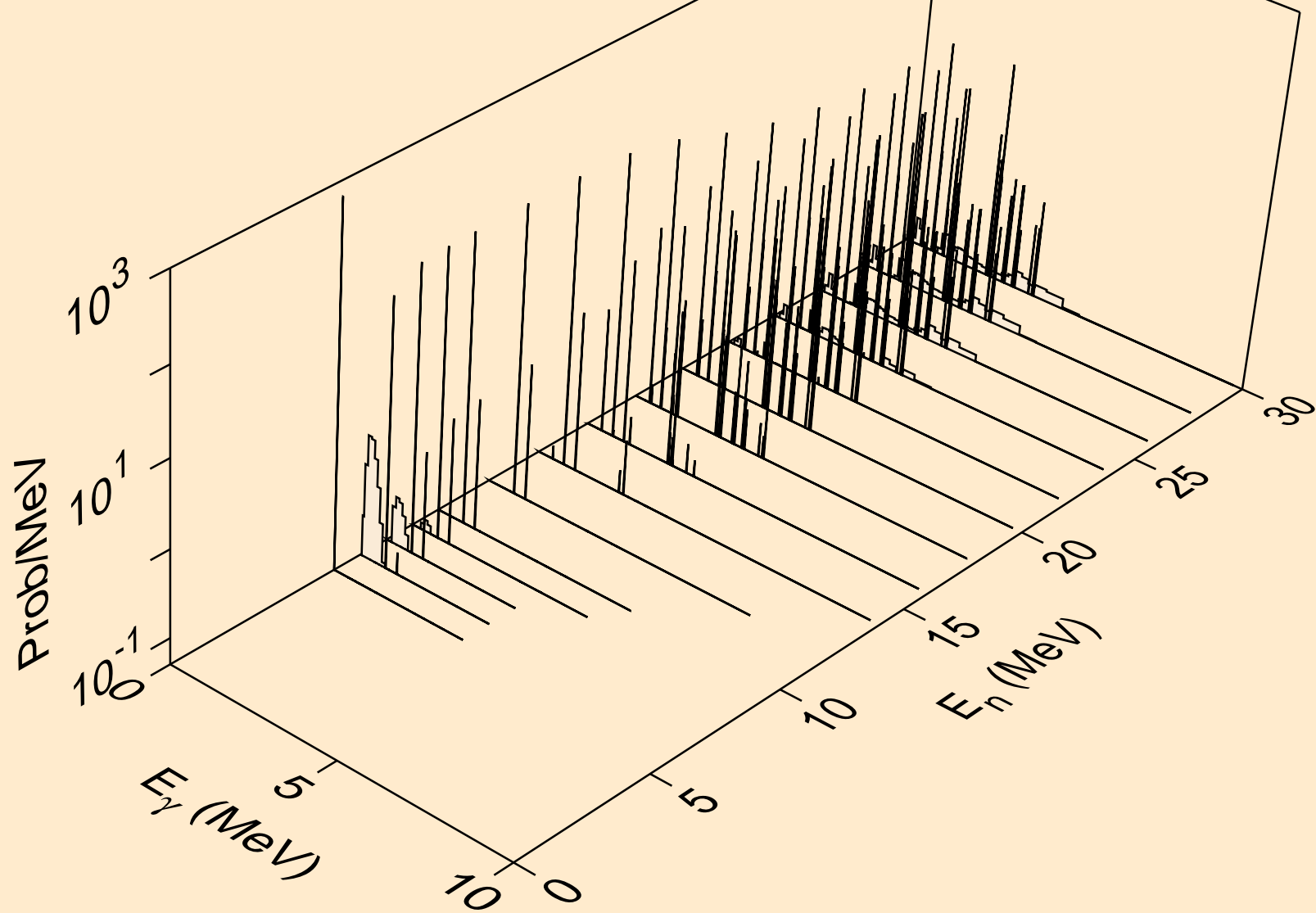

ZN061 PROTON ACER TENDL-2023 LIBRARY; T=0.K
Photon emission for (n,pd)

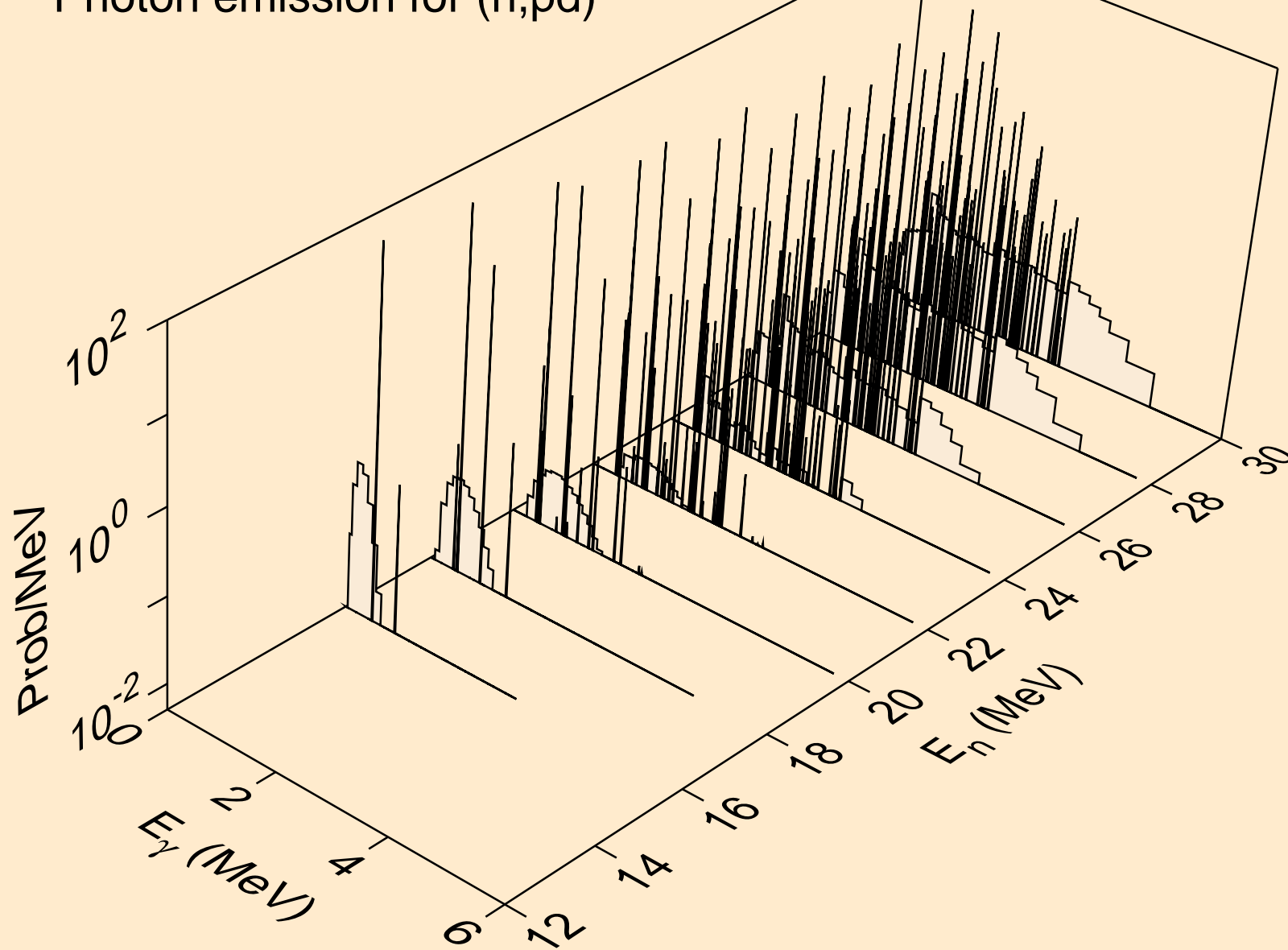

ZN061 PROTON ACER TENDL-2023 LIBRARY; T=0.K
Photon emission for (n,pt)

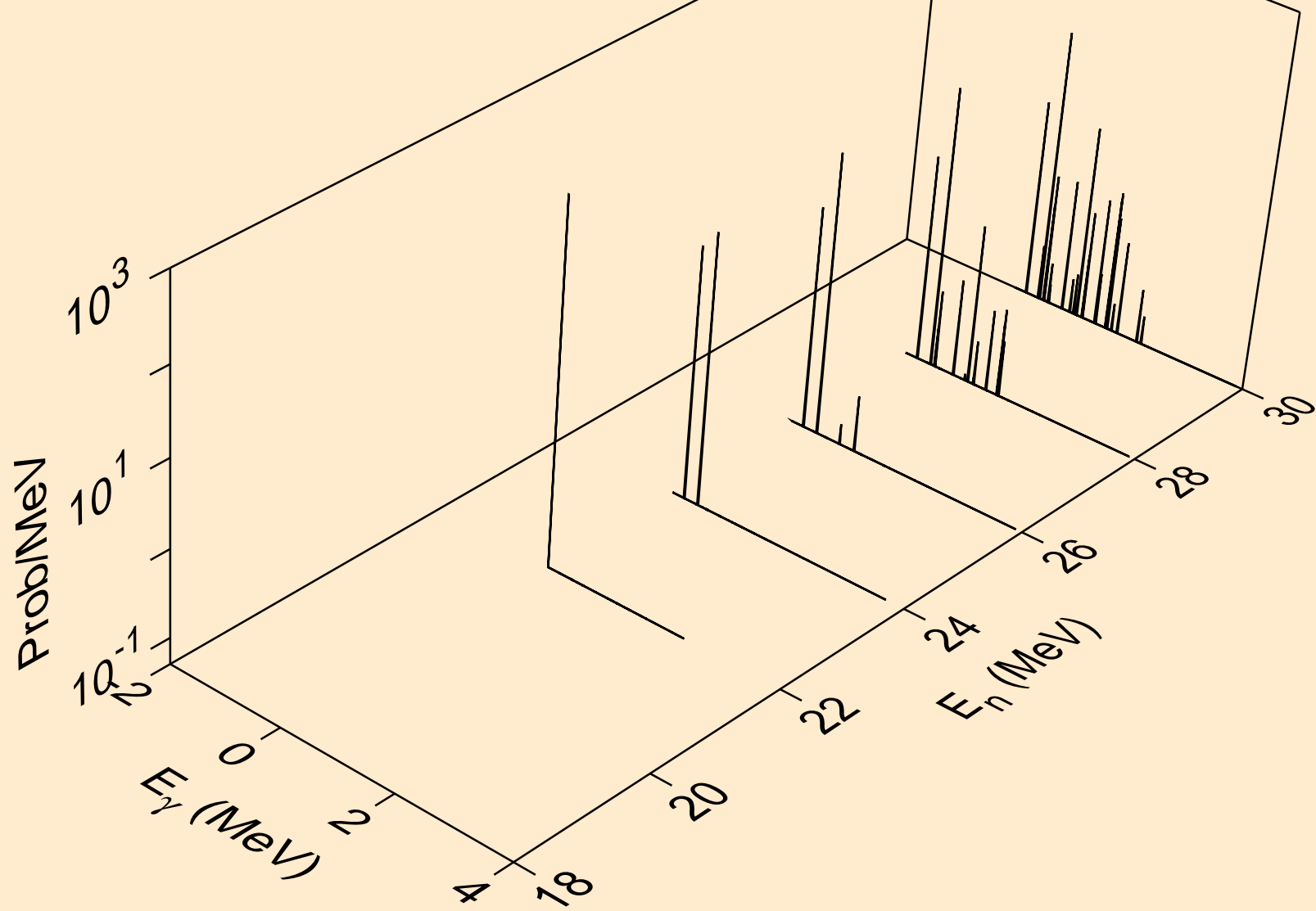

ZN061 PROTON ACER TENDL-2023 LIBRARY; T=0.K
Photon emission for (n,da)

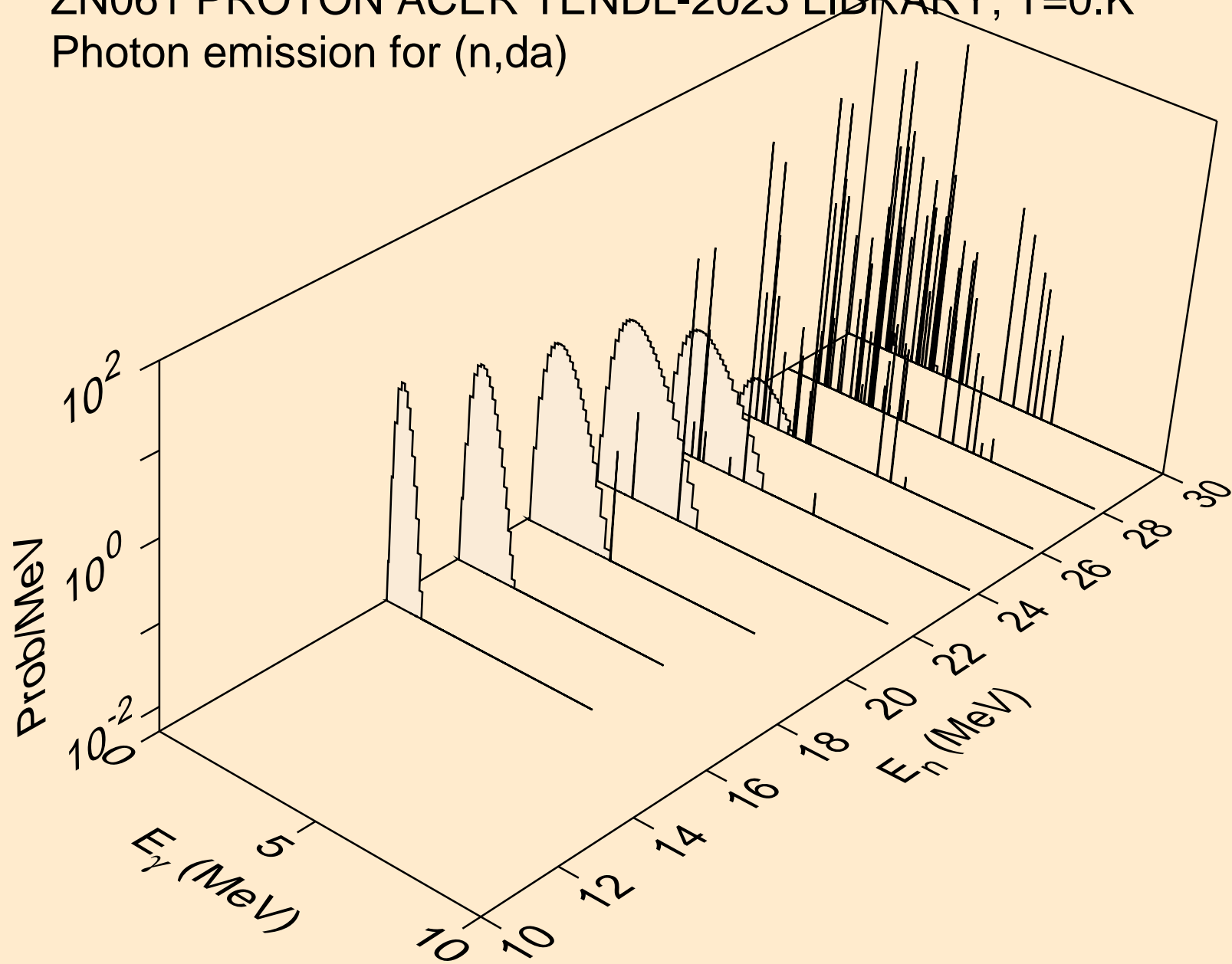

ZN061 PROTON ACER TENDL-2023 LIBRARY; T=0.K
Particle heating contributions

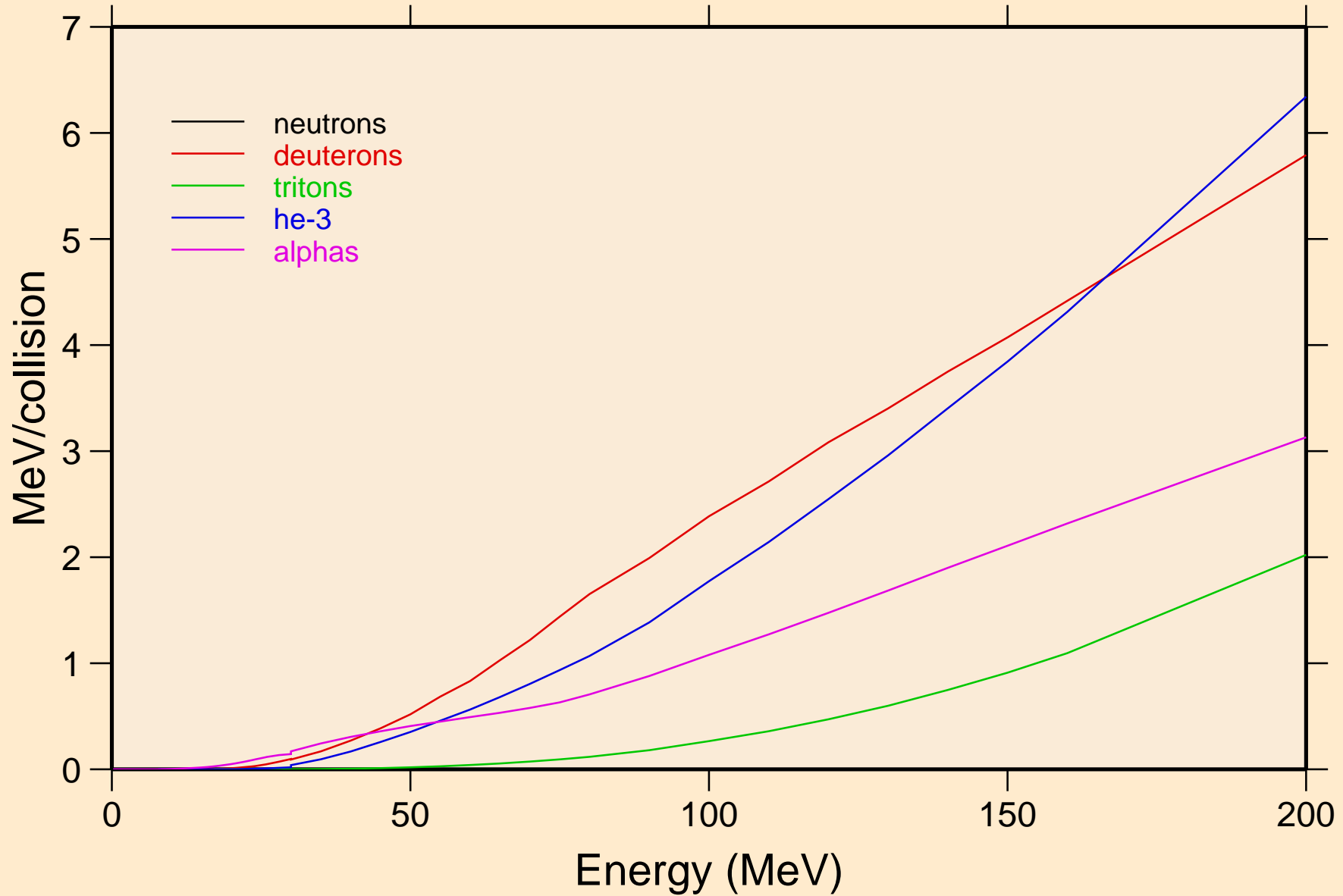

ZN061 PROTON ACER TENDL-2023 LIBRARY; T=0.K

Recoil Heating

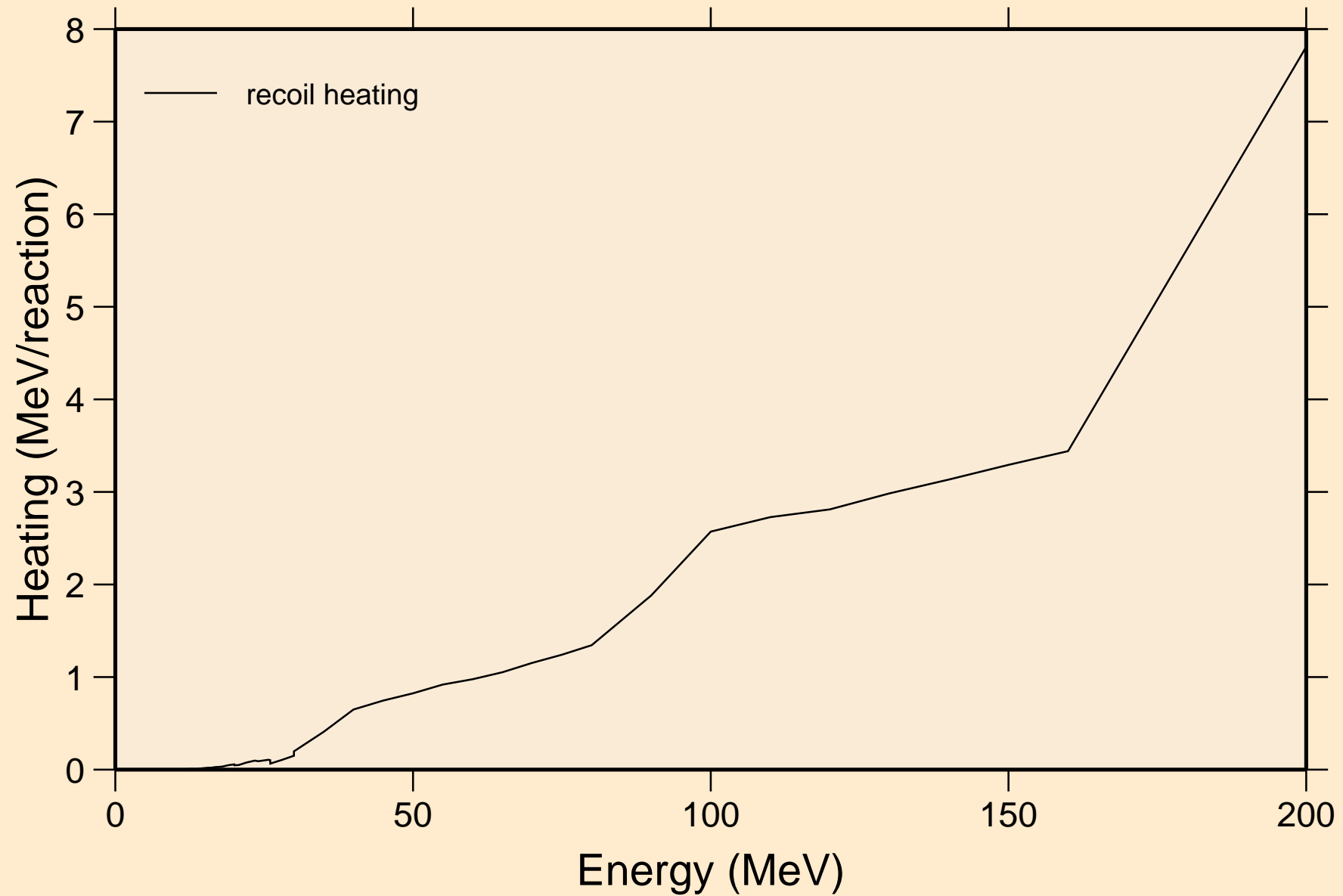

ZN061 PROTON ACER TENDL-2023 LIBRARY; T=0.K
Particle production cross sections

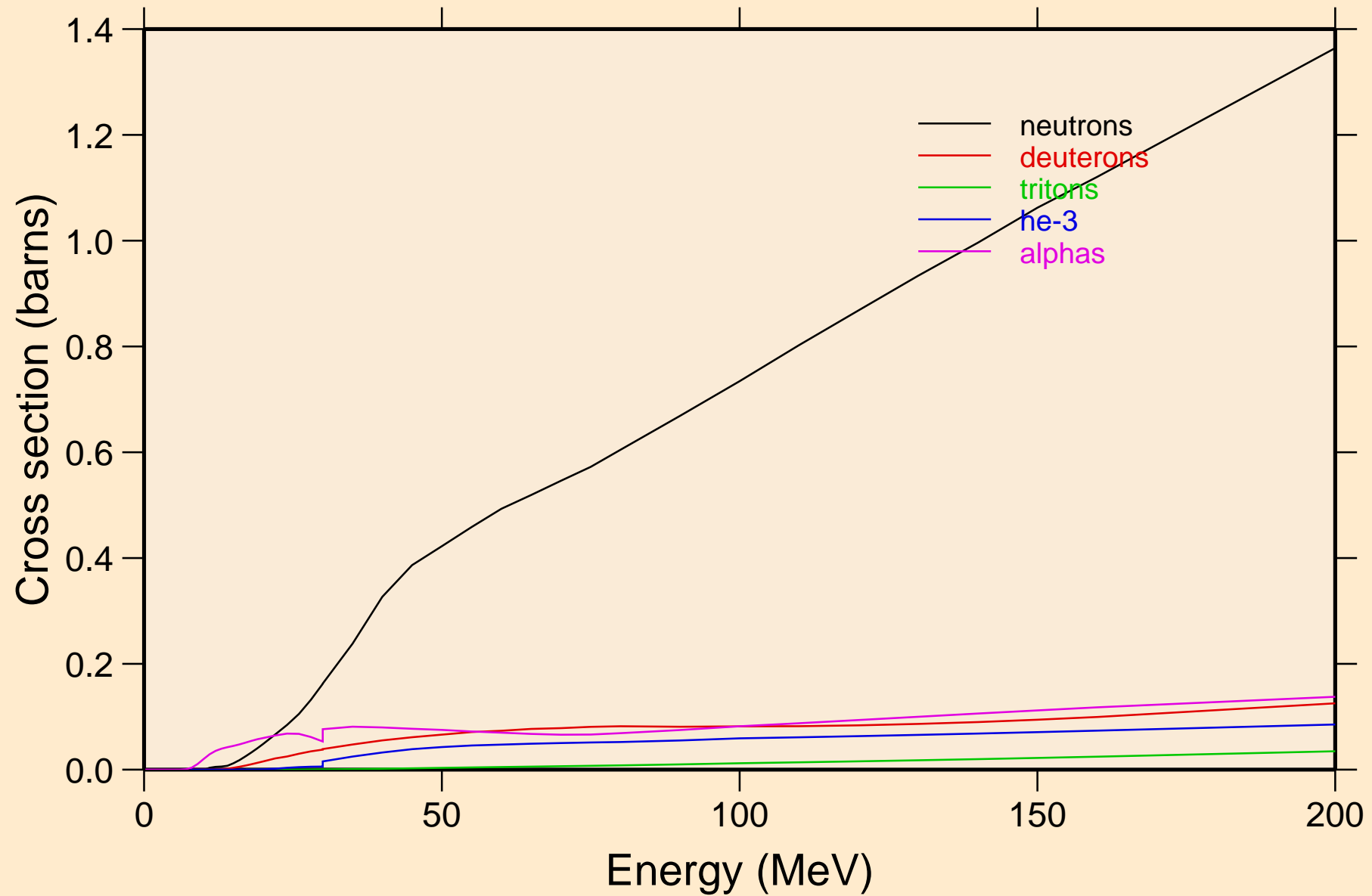

ZN061 PROTON ACER TENDL-2023 LIBRARY; T=0.K
neutrons from (p,n)

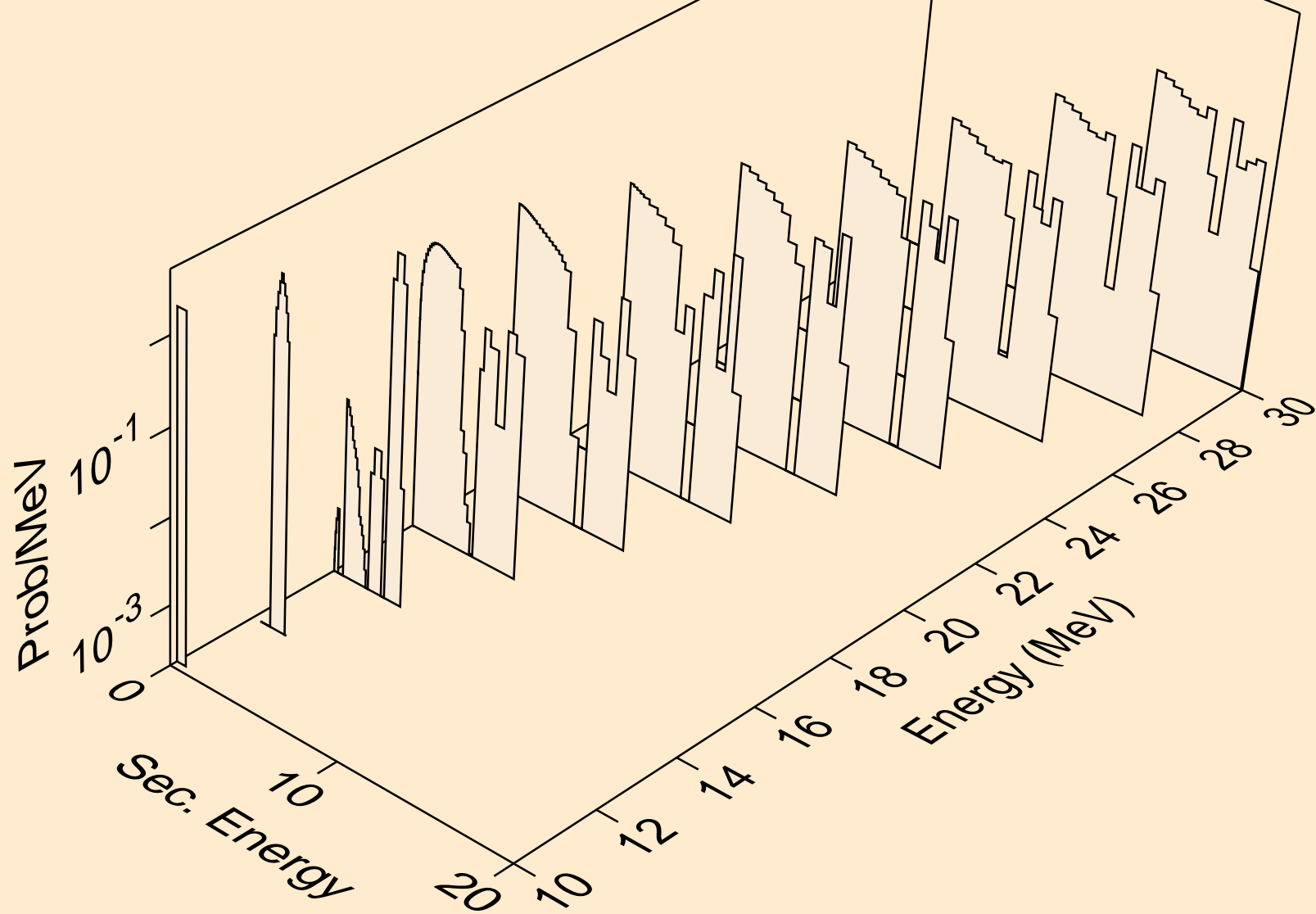

ZN061 PROTON ACER TENDL-2023 LIBRARY; T=0.K
neutrons from (p,x)

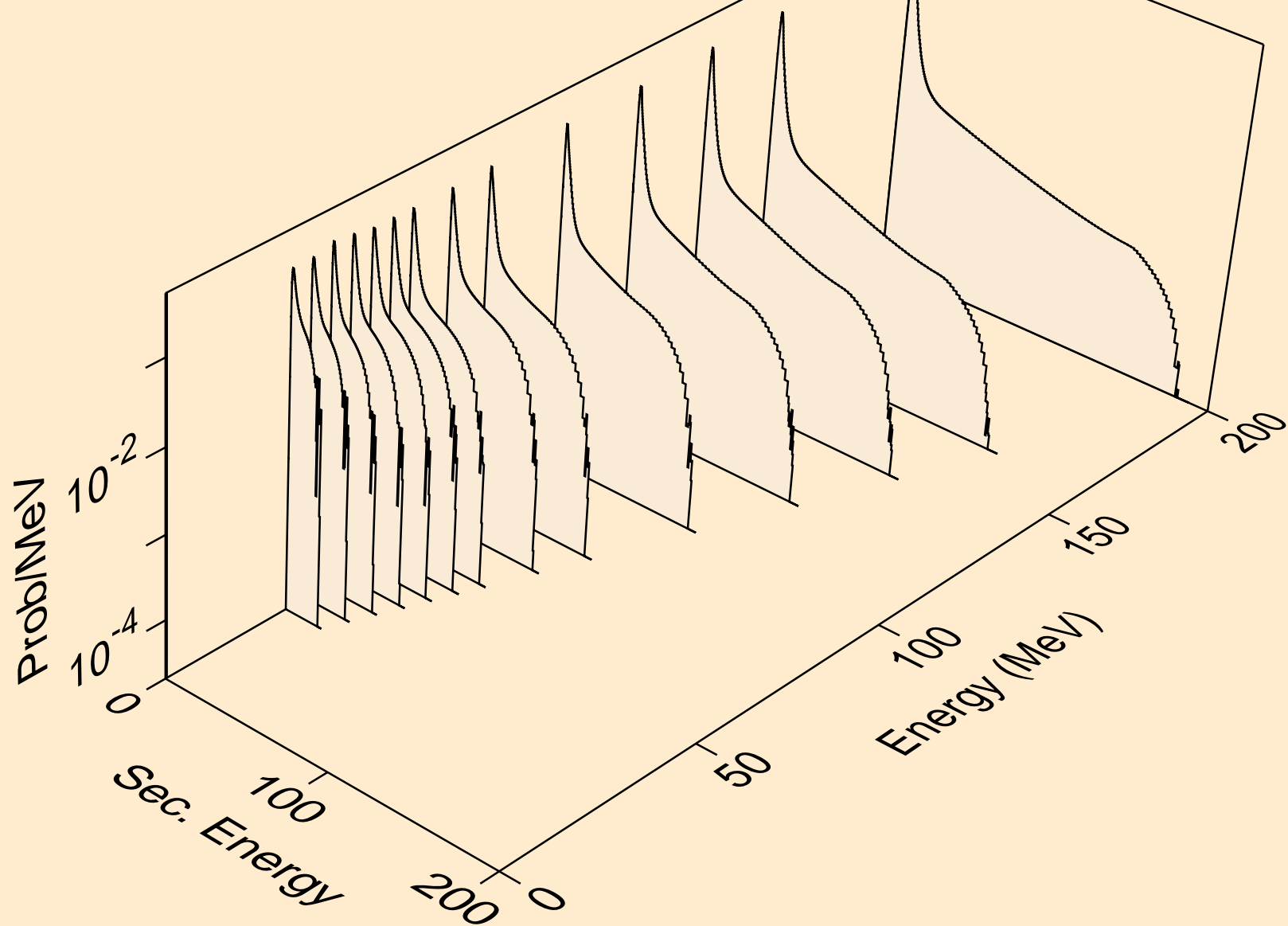

ZN061 PROTON ACER TENDL-2023 LIBRARY; T=0.K
neutrons from (p,2n)

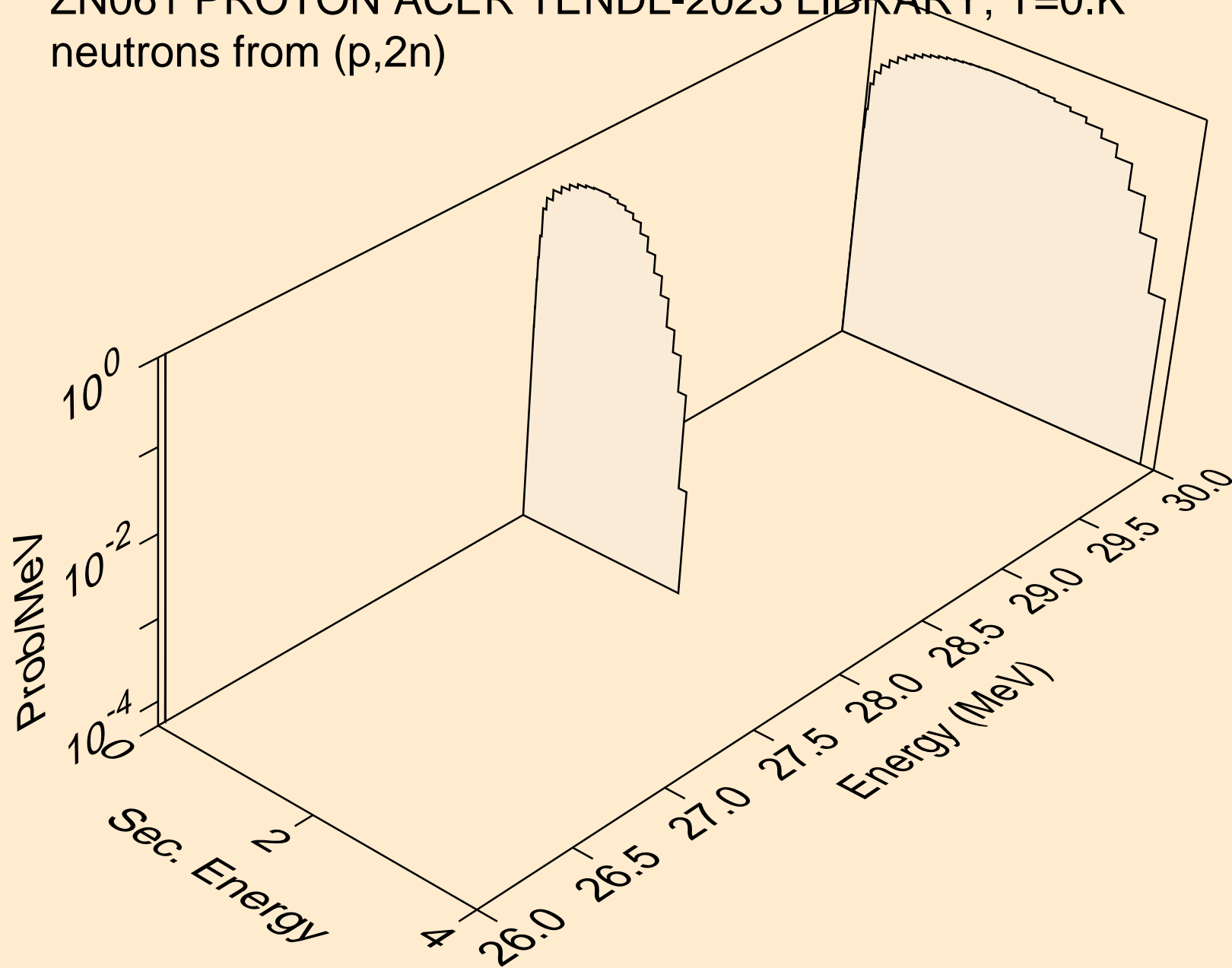

ZN061 PROTON ACER TENDL-2023 LIBRARY; T=0.K
neutrons from (p,n*)a

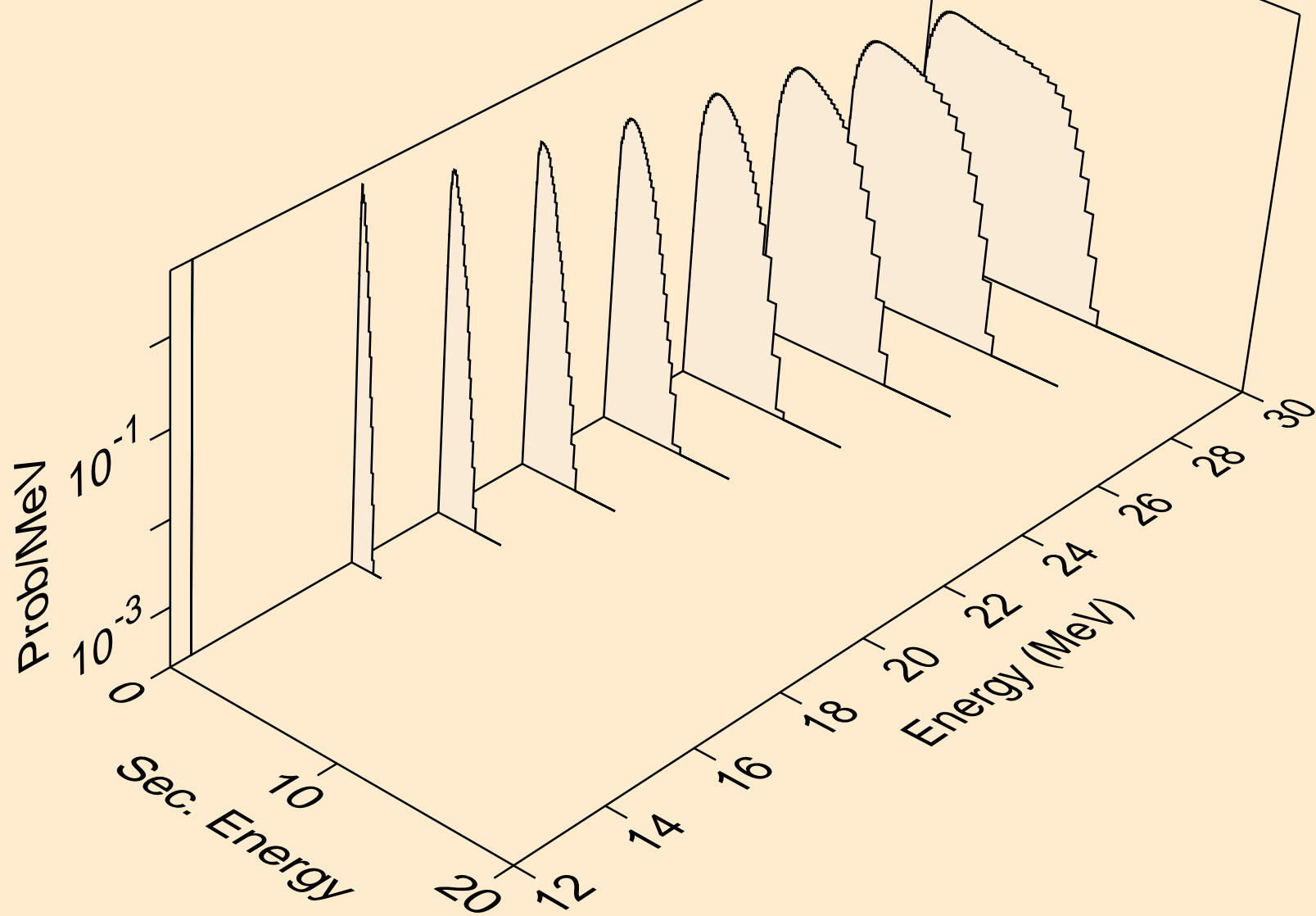

ZN061 PROTON ACER TENDL-2023 LIBRARY; T=0.K
neutrons from (p,n*)p

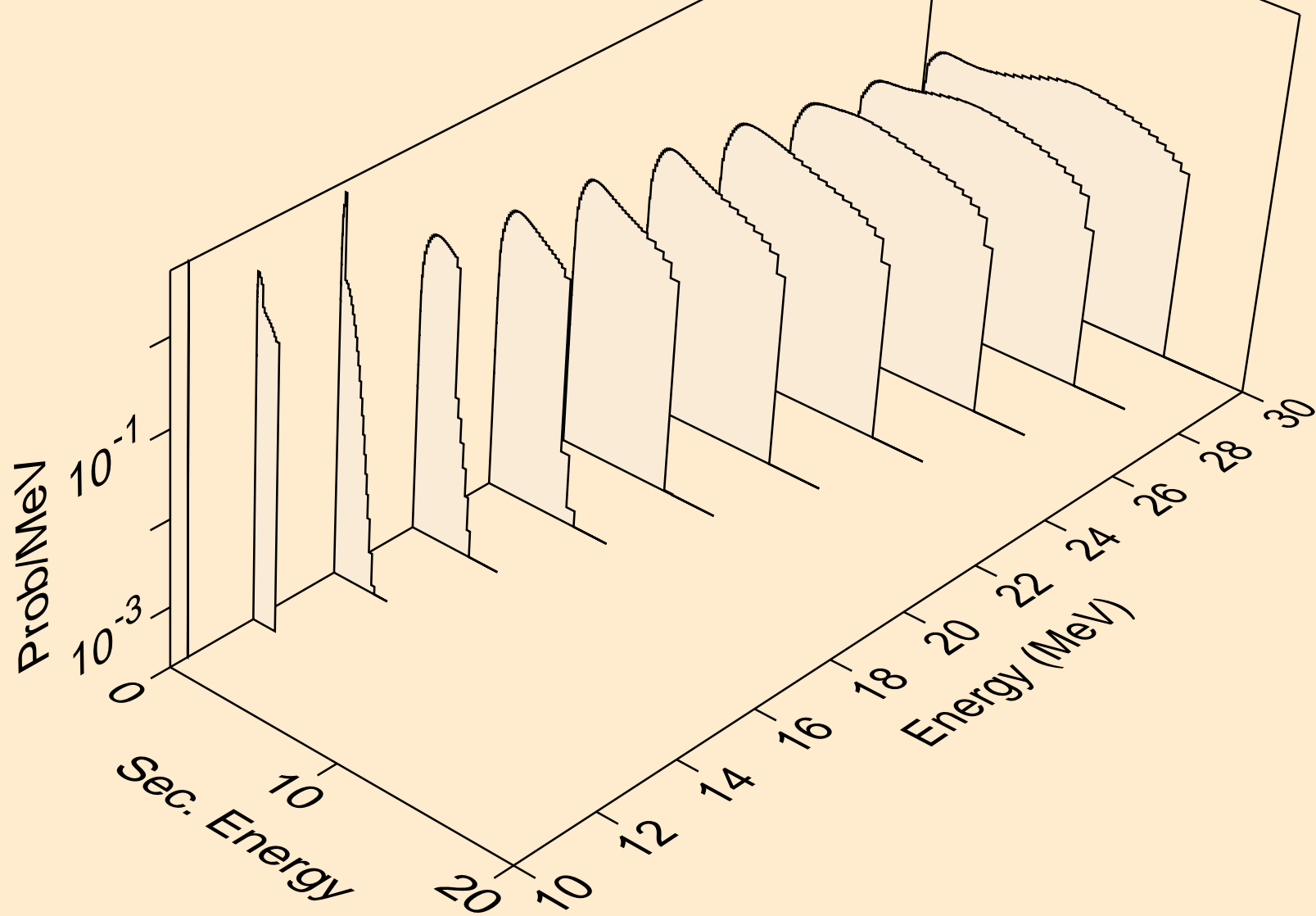

ZN061 PROTON ACER TENDL-2023 LIBRARY; T=0.K
neutrons from (p,n*)d

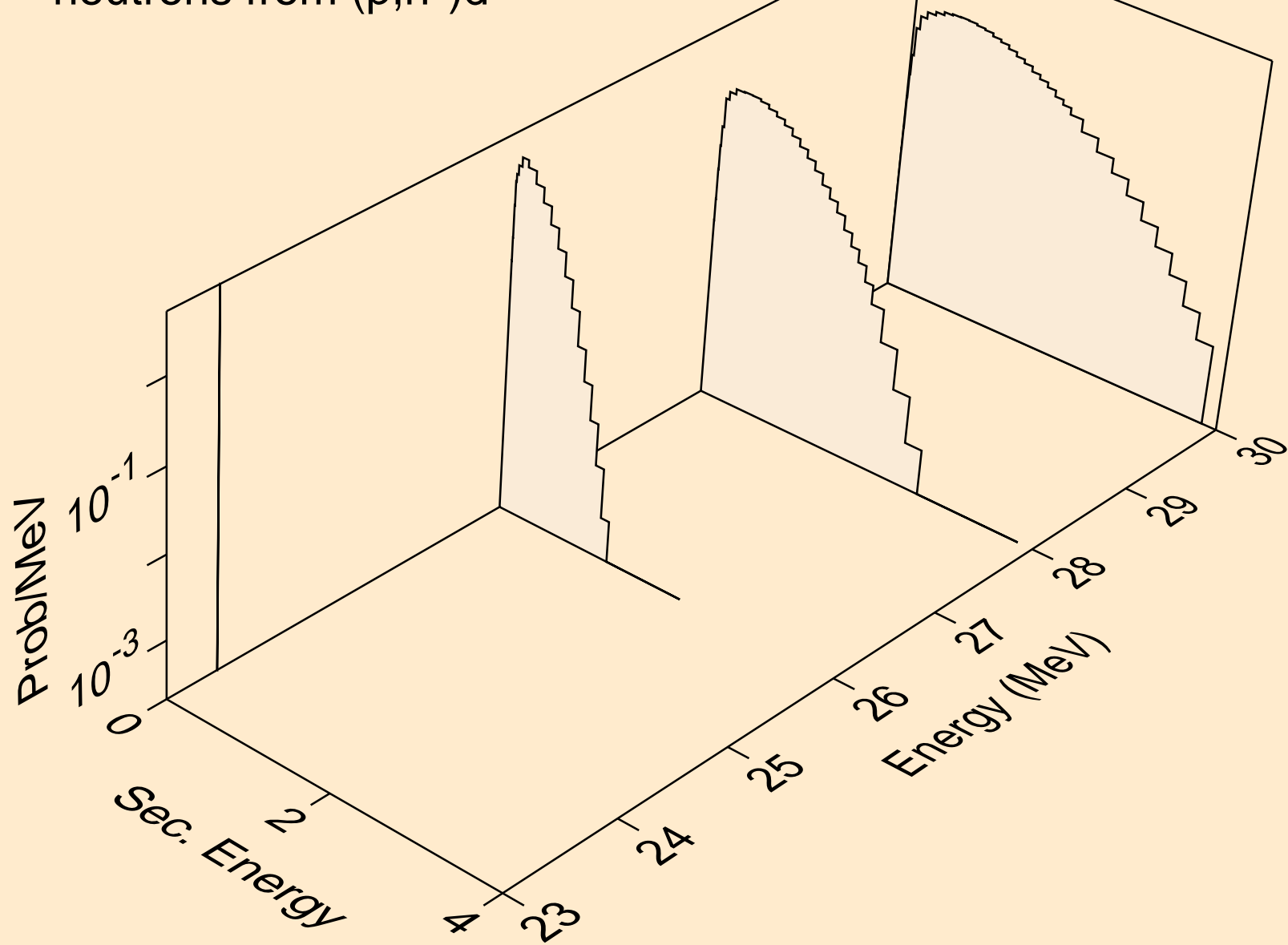

ZN061 PROTON ACER TENDL-2023 LIBRARY; T=0.K
neutrons from (p,n*)he3

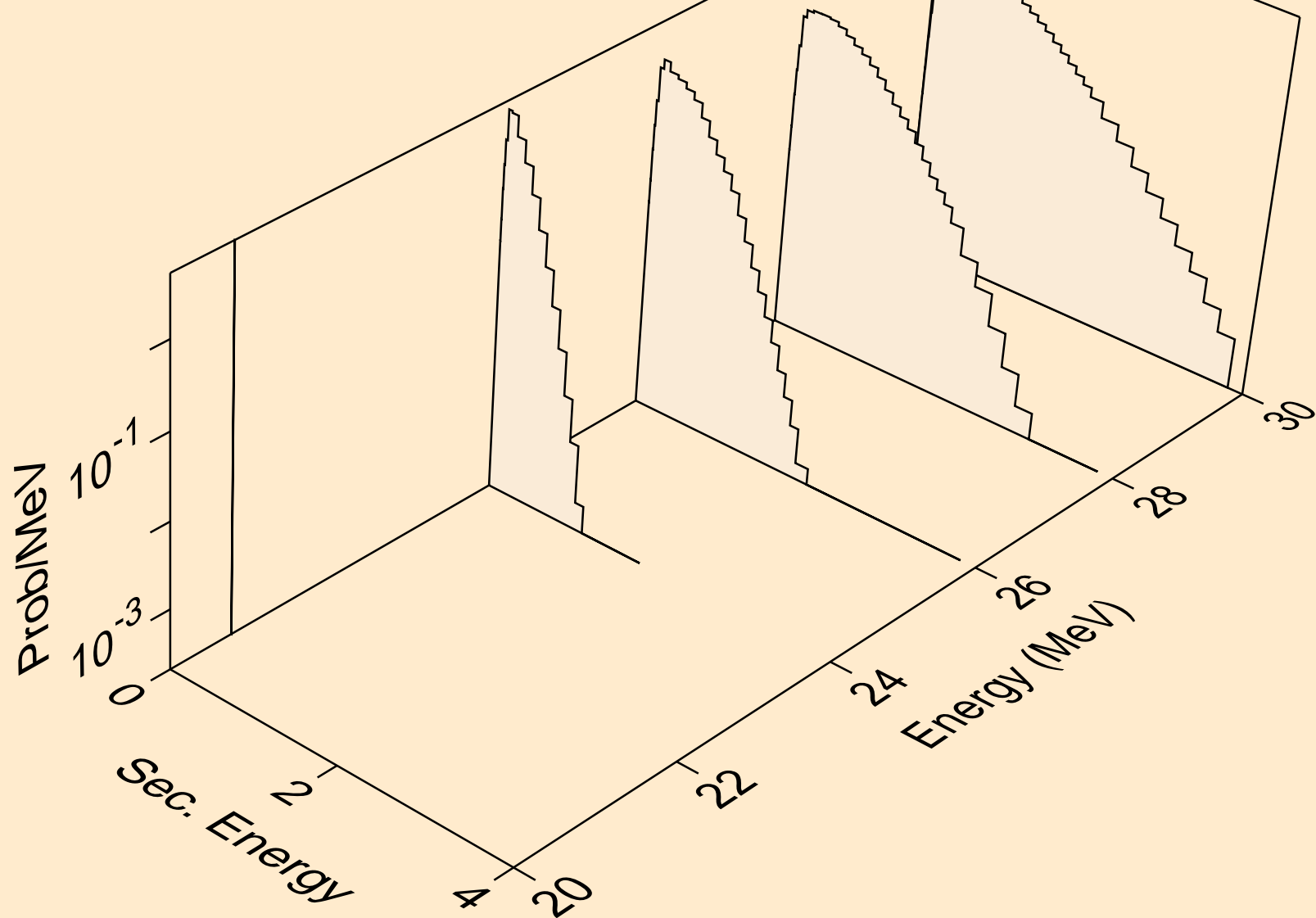

ZN061 PROTON ACER TENDL-2023 LIBRARY; T=0.K
neutrons from (p,2np)

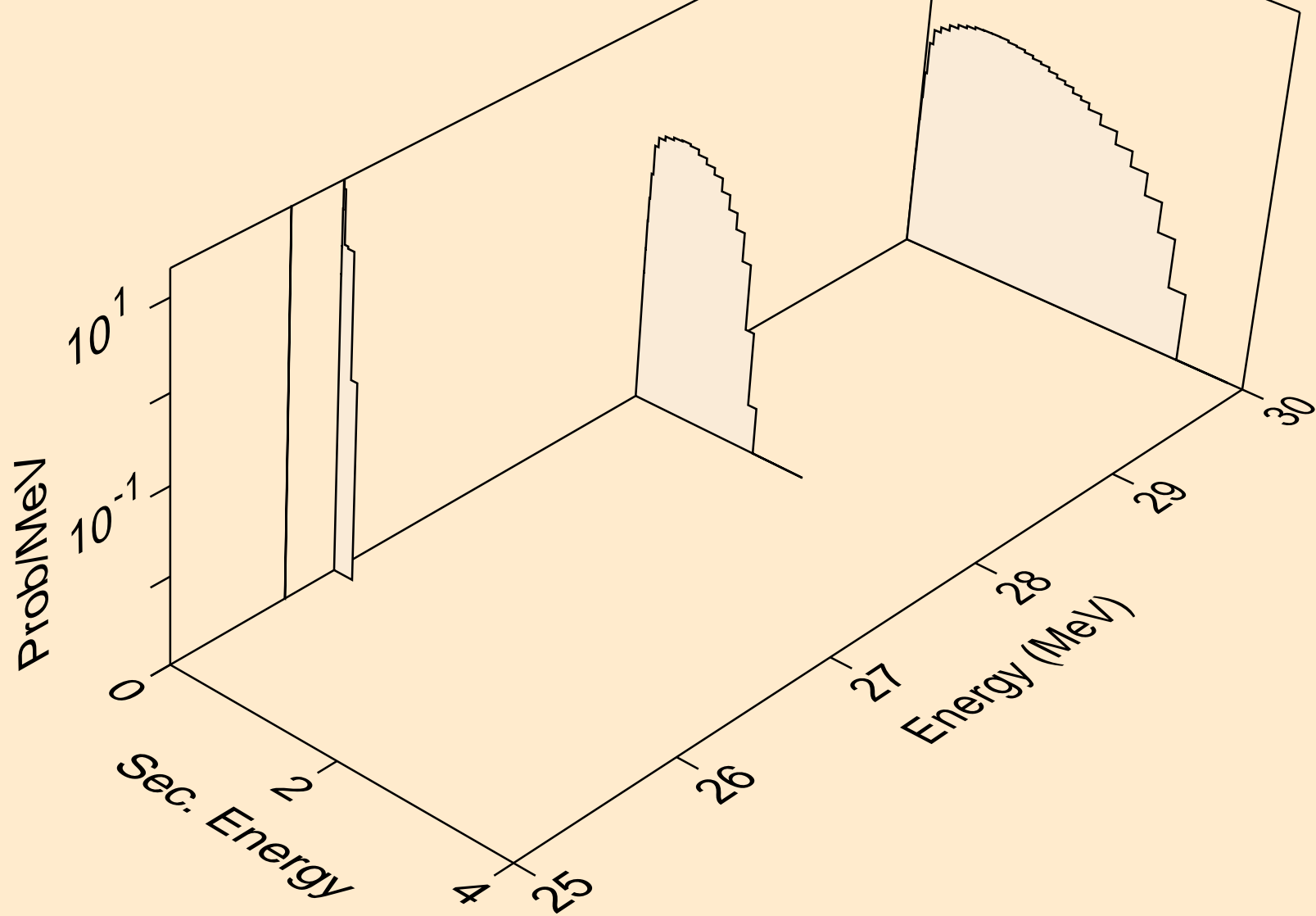

ZN061 PROTON ACER TENDL-2023 LIBRARY; T=0.K
neutrons from (p,n2p)

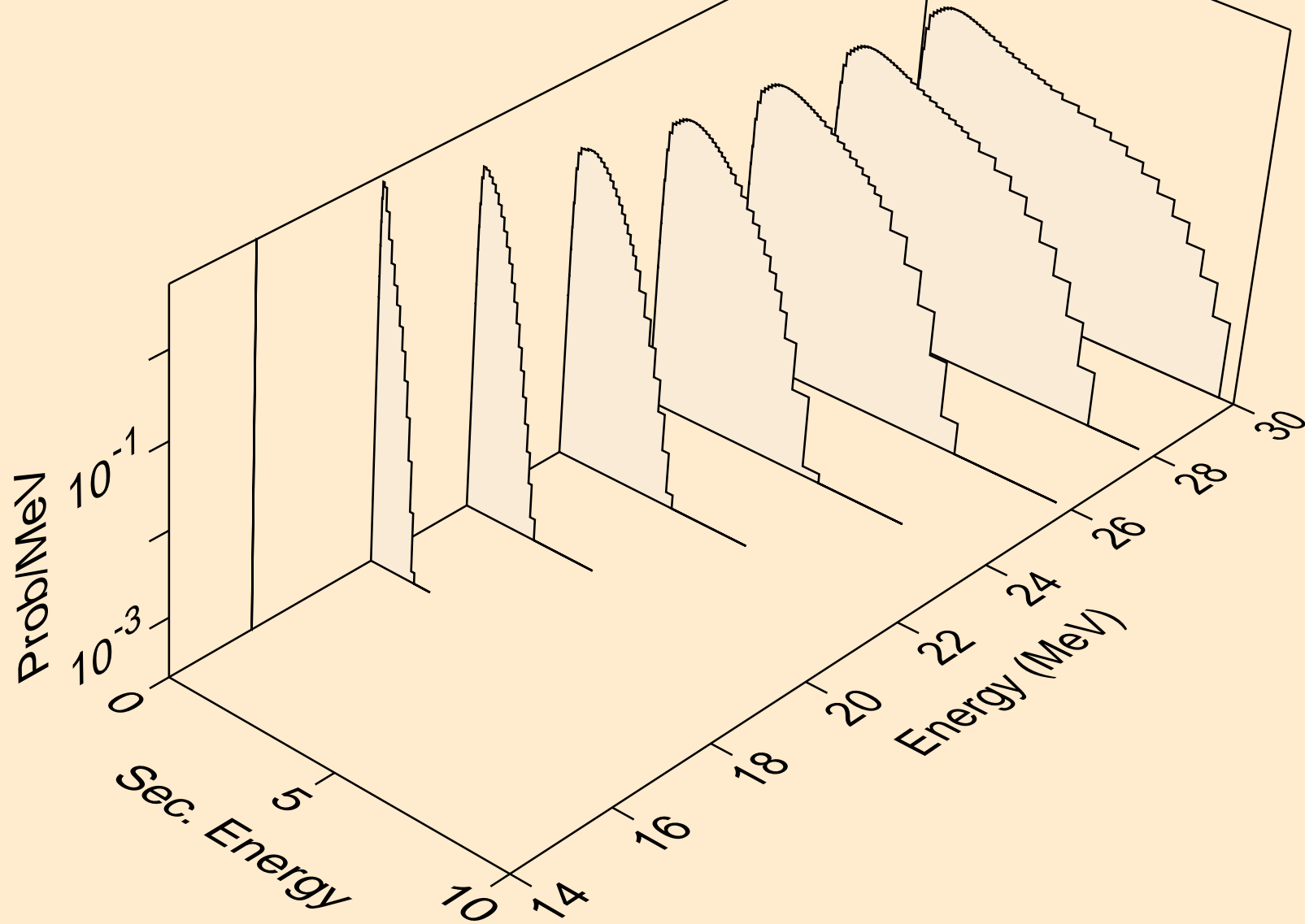

ZN061 PROTON ACER TENDL-2023 LIBRARY; T=0.K
neutrons from (p,npa)

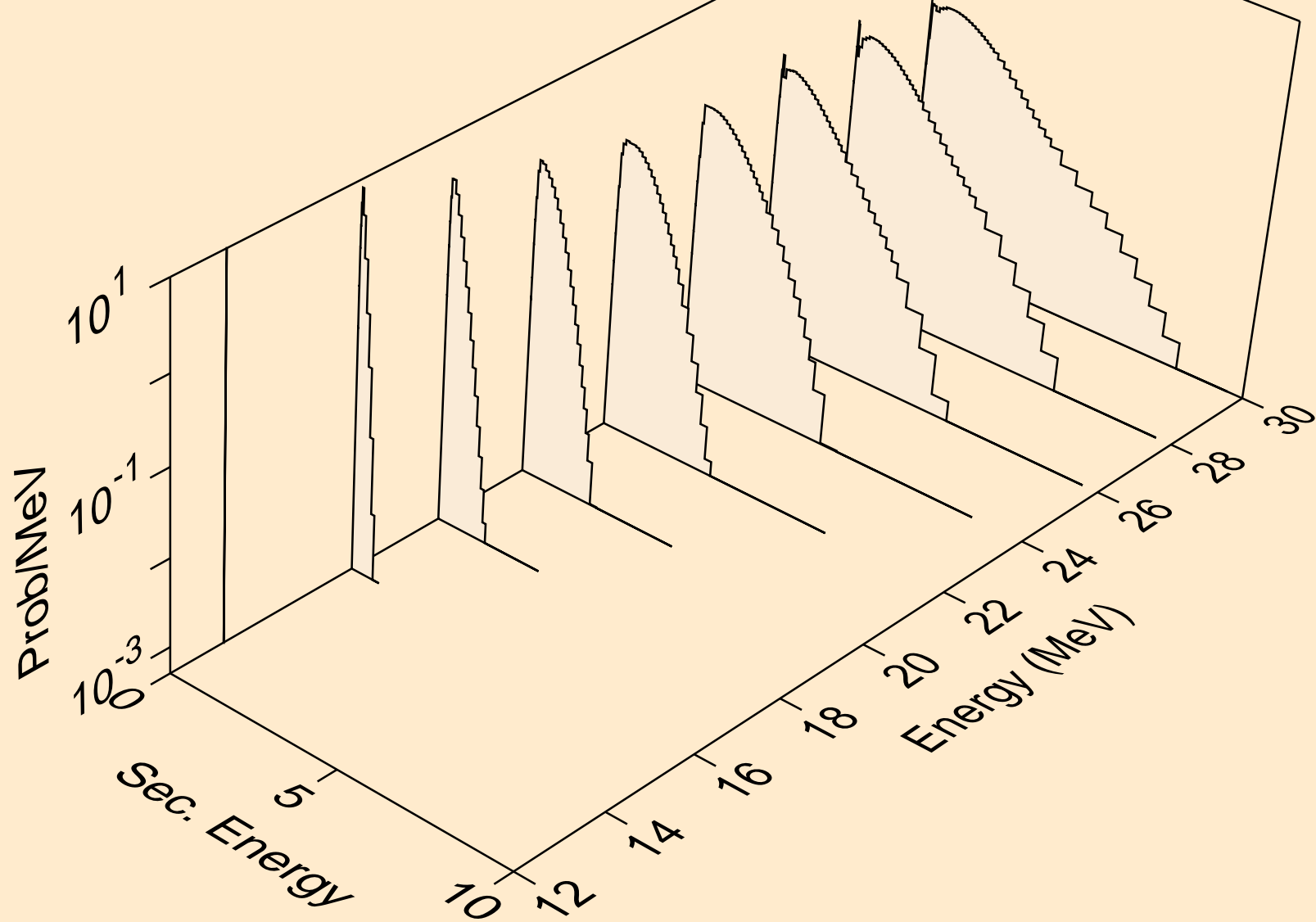

ZN061 PROTON ACER TENDL-2023 LIBRARY; T=0.K
deuterons from (p,x)

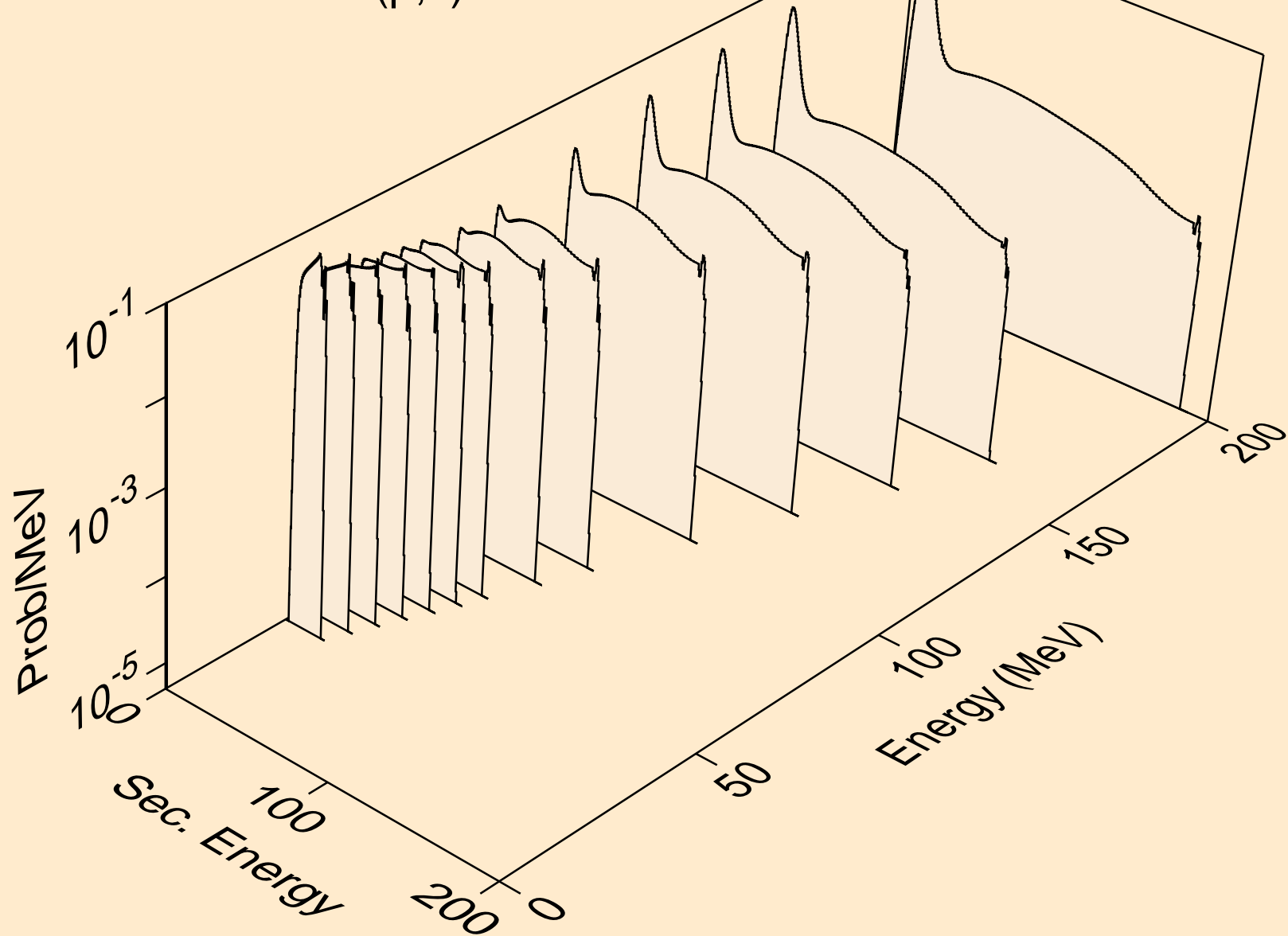

ZN061 PROTON ACER TENDL-2023 LIBRARY; T=0.K
deuterons from (p,n*)d

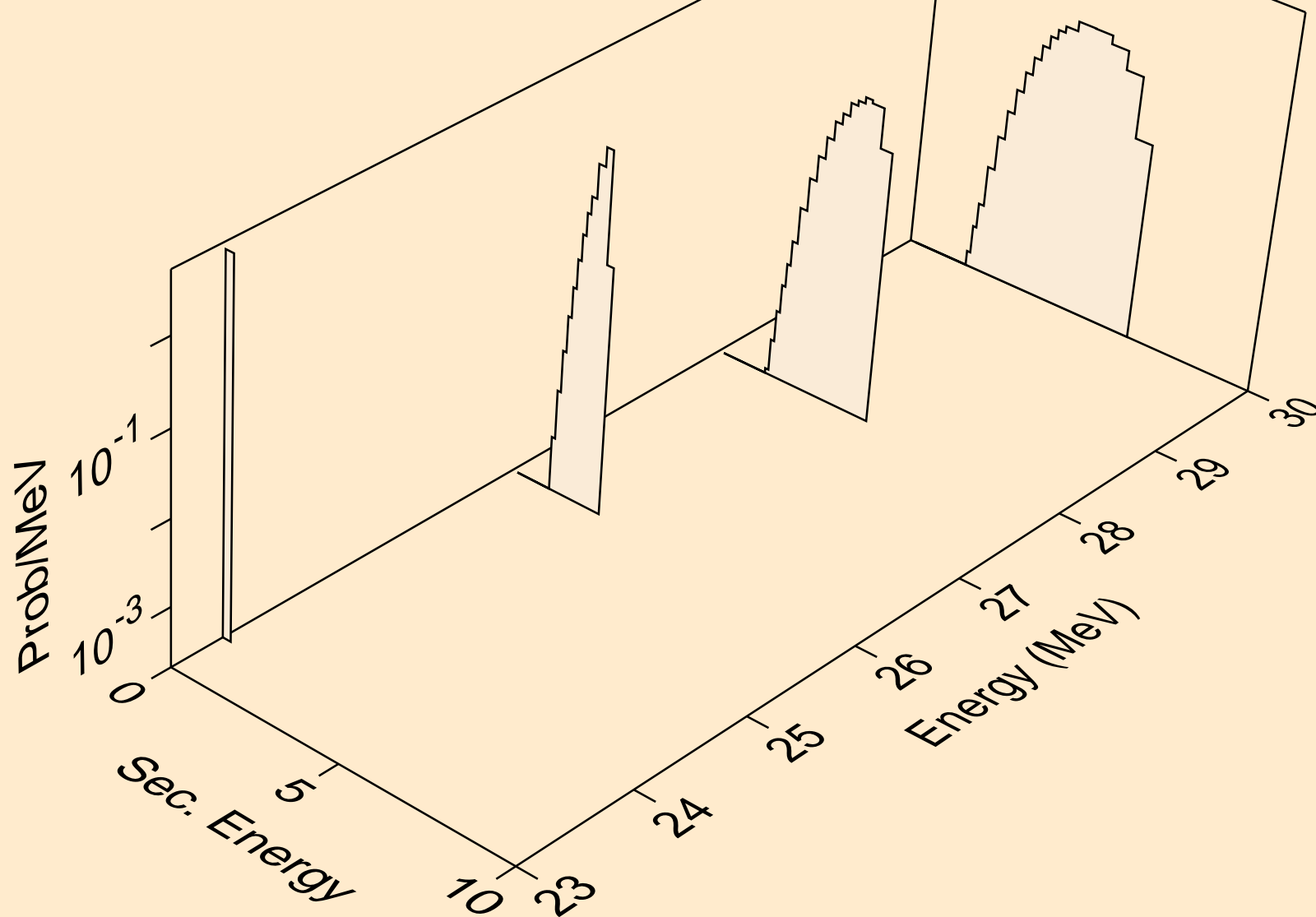

ZN061 PROTON ACER TENDL-2023 LIBRARY; T=0.K
deuterons from (p,d)

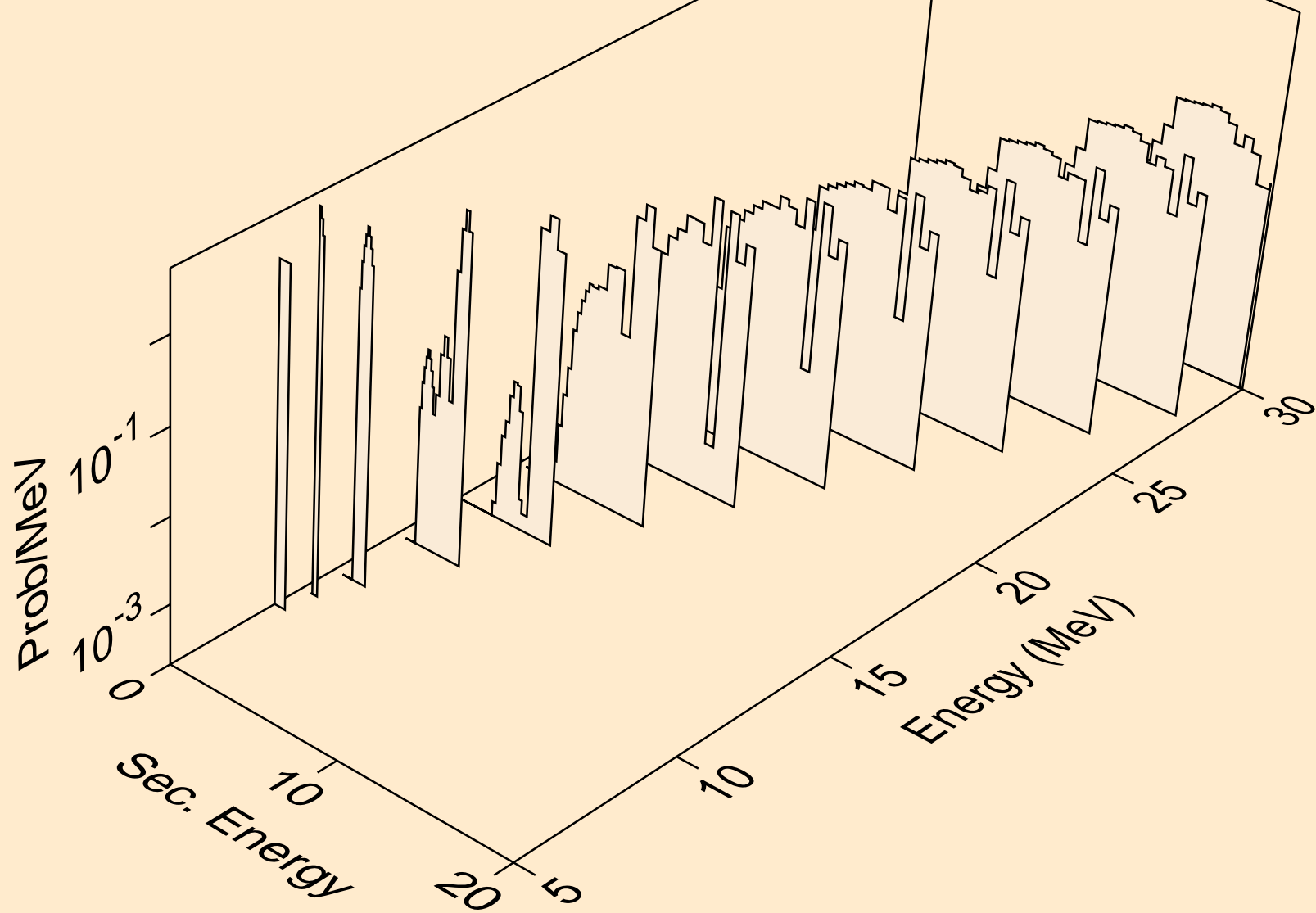

ZN061 PROTON ACER TENDL-2023 LIBRARY; T=0.K
deuterons from (p,pd)

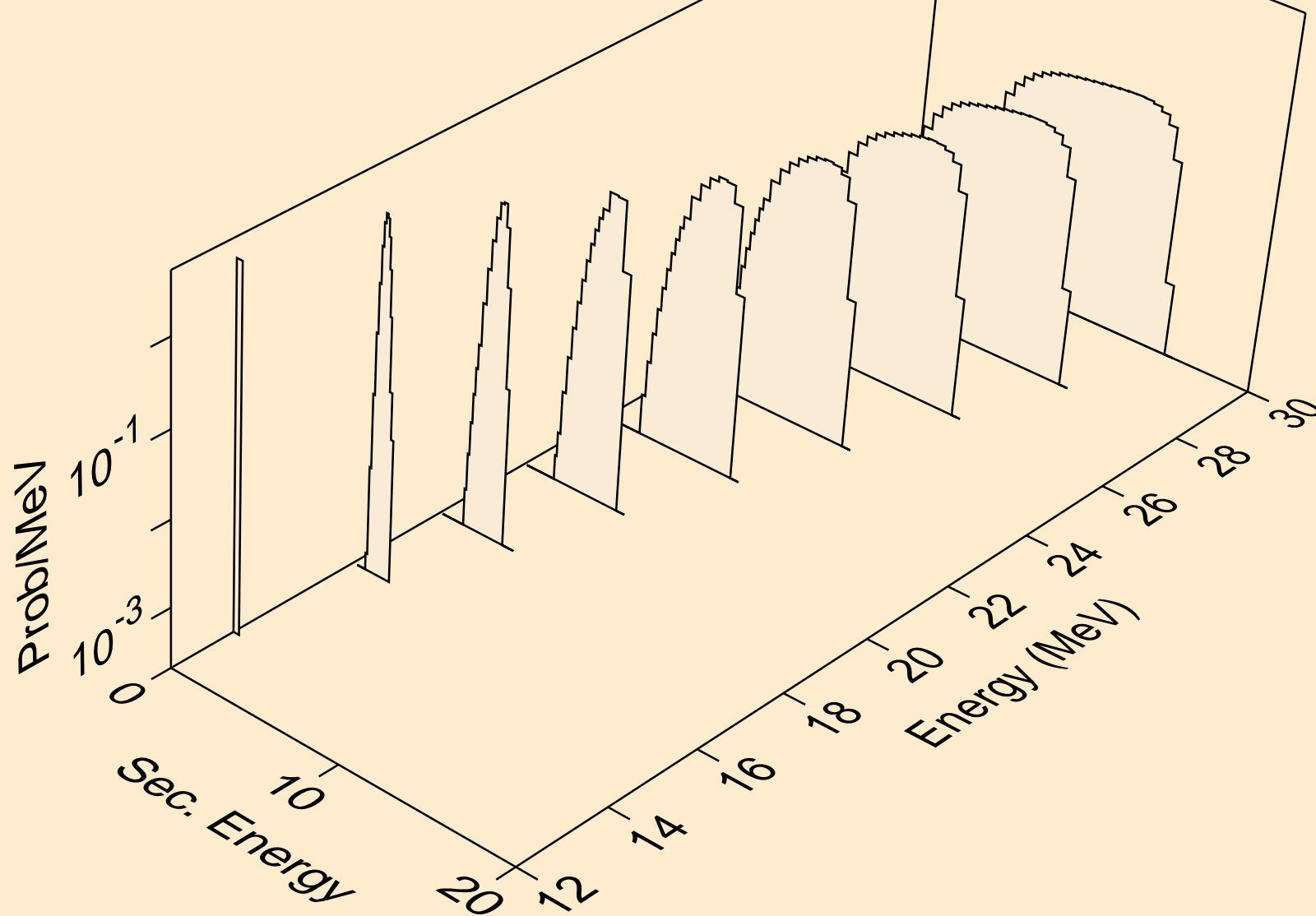

ZN061 PROTON ACER TENDL-2023 LIBRARY; T=0.K
deuterons from (p,da)

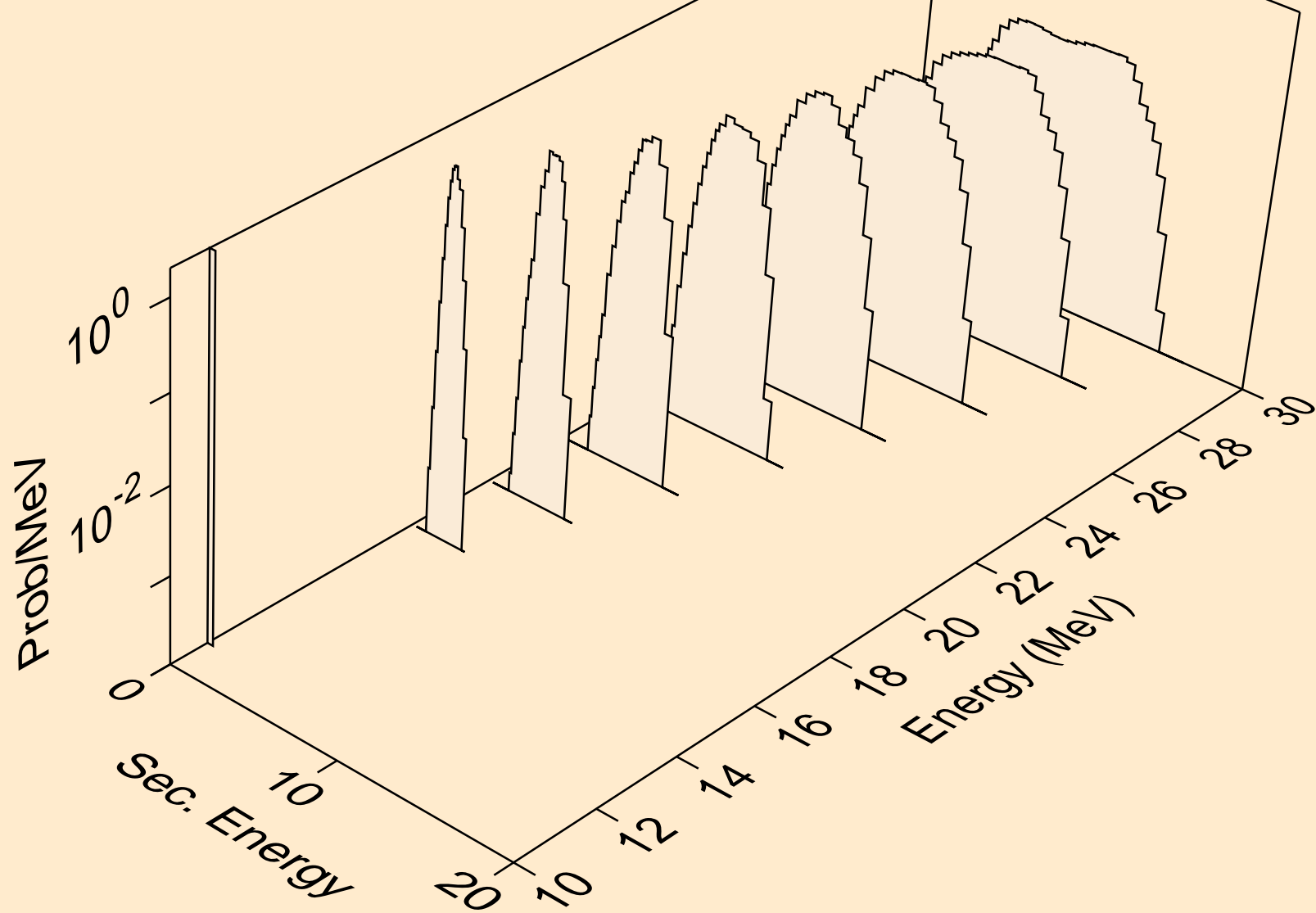

ZN061 PROTON ACER TENDL-2023 LIBRARY; T=0.K
tritons from (p,x)

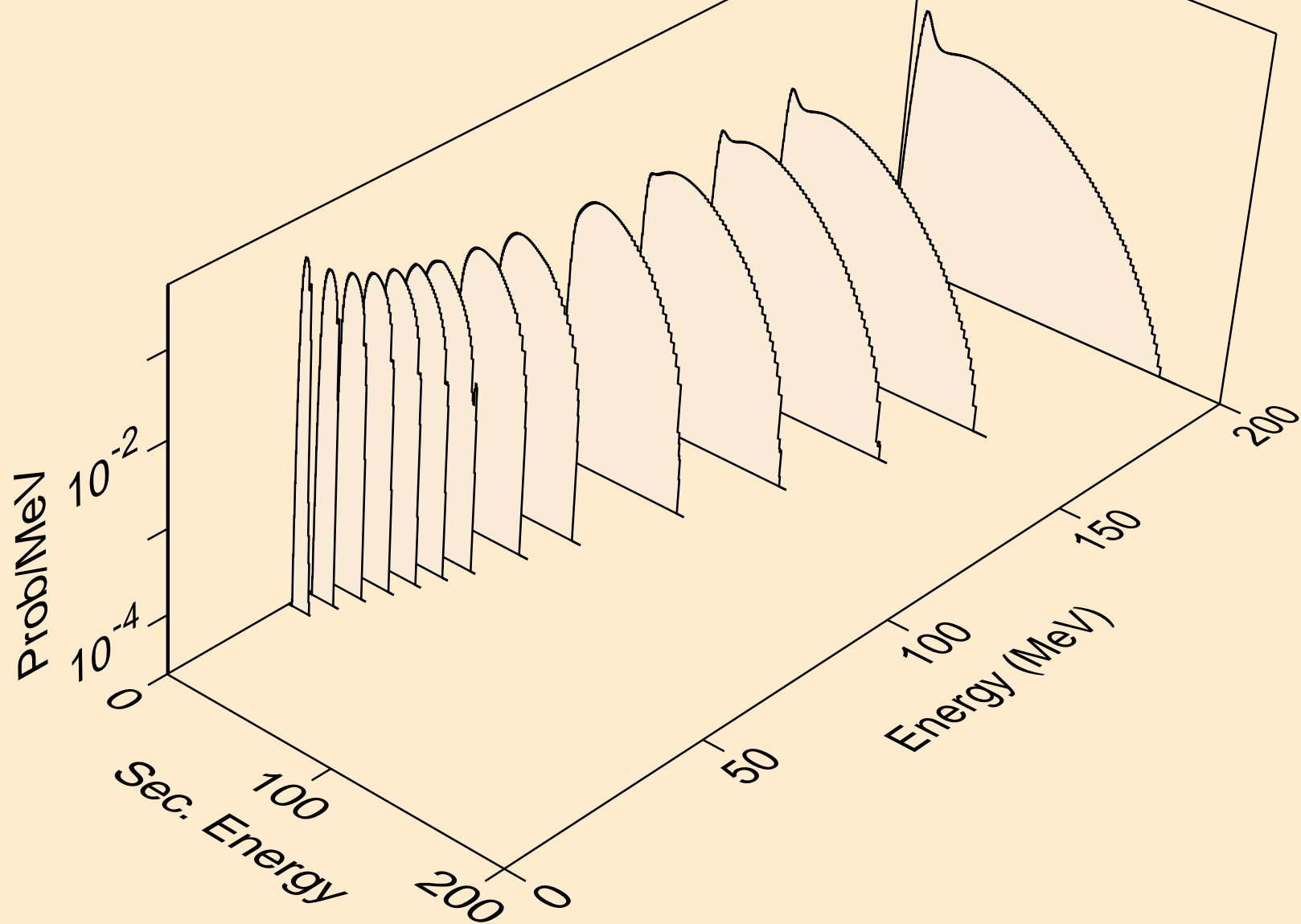

ZN061 PROTON ACER TENDL-2023 LIBRARY; T=0.K
tritons from (p,t)

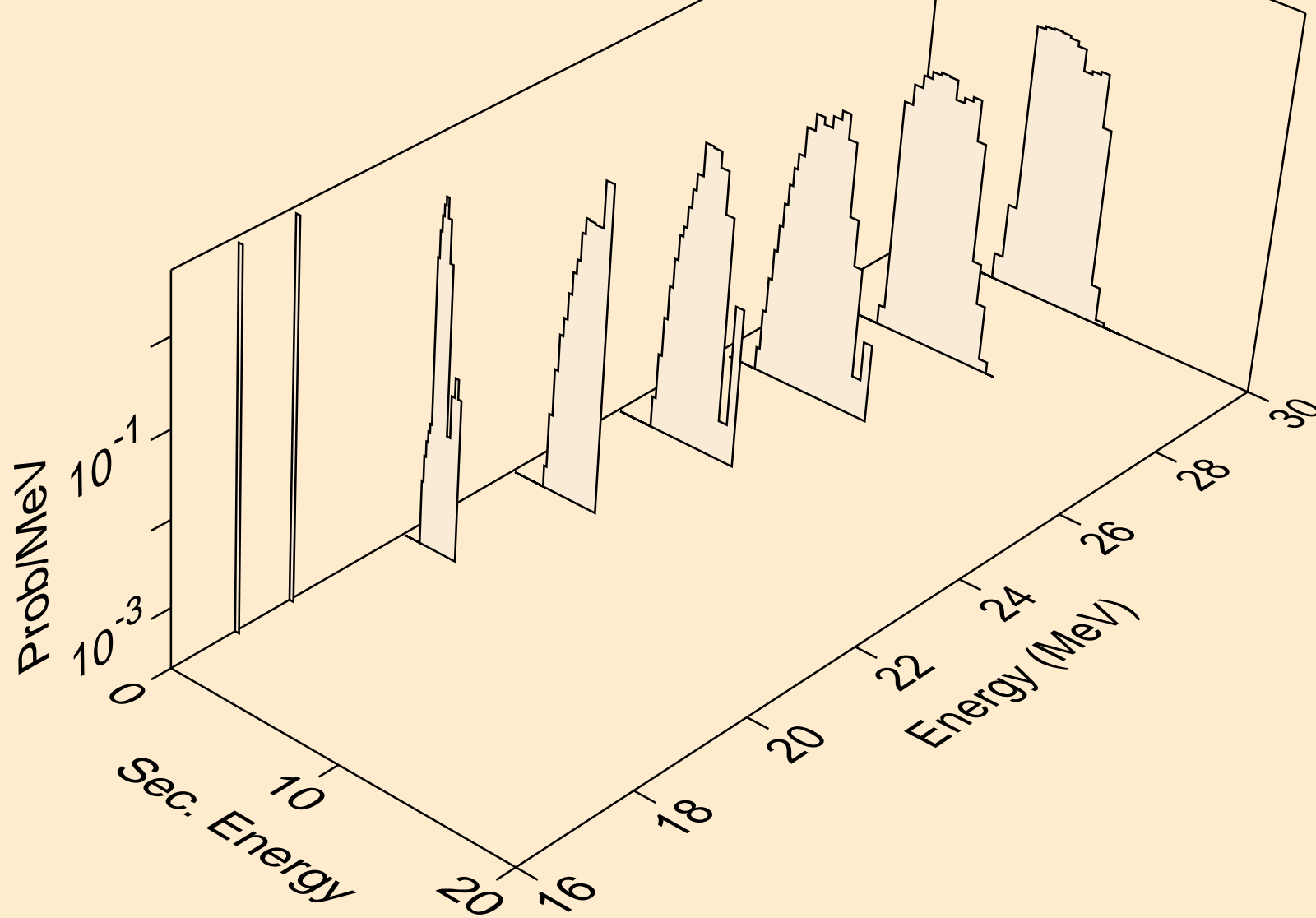

ZN061 PROTON ACER TENDL-2023 LIBRARY; T=0.K
tritons from (p,pt)

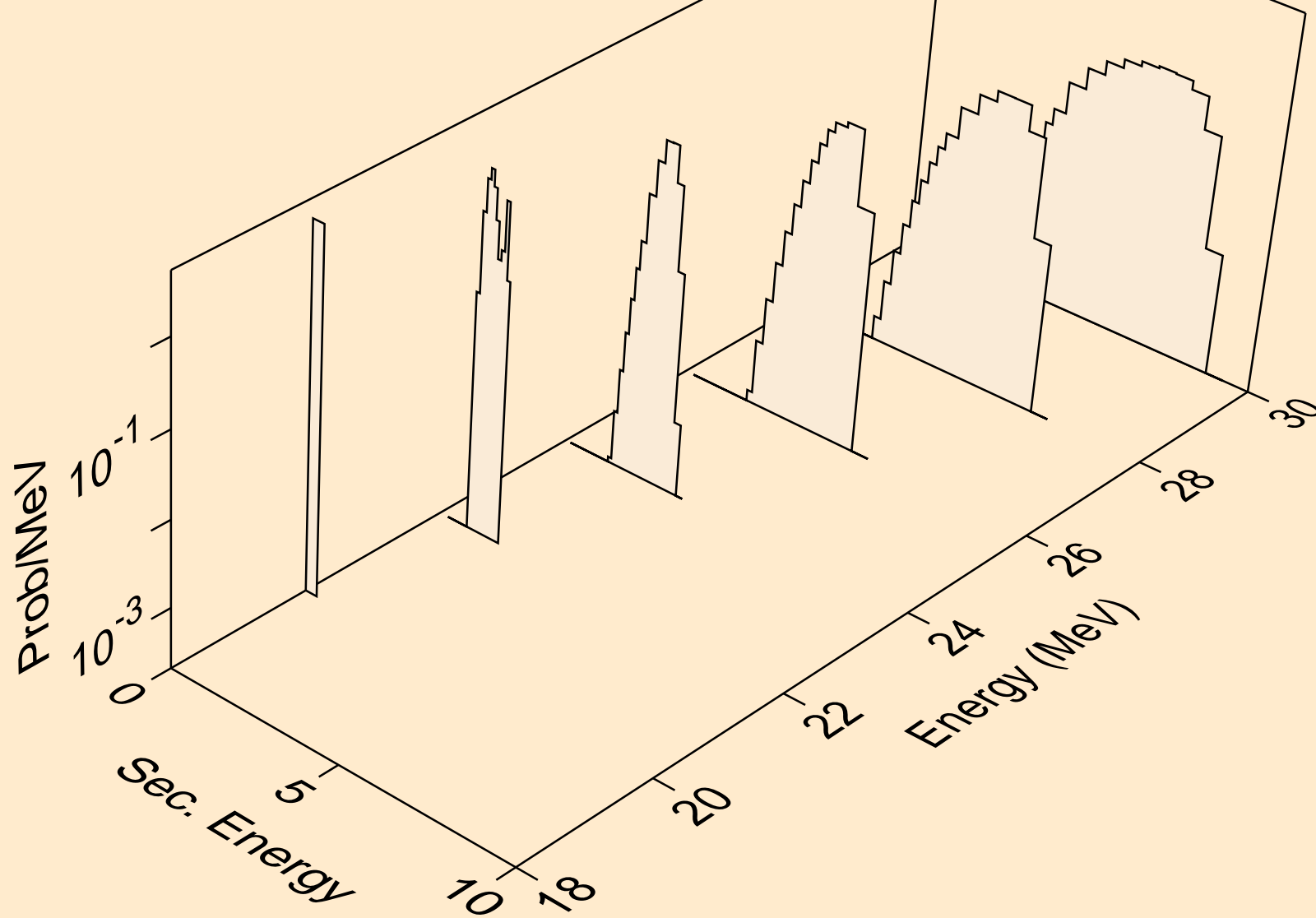

ZN061 PROTON ACER TENDL-2023 LIBRARY; T=0.K
he3s from (p,x)

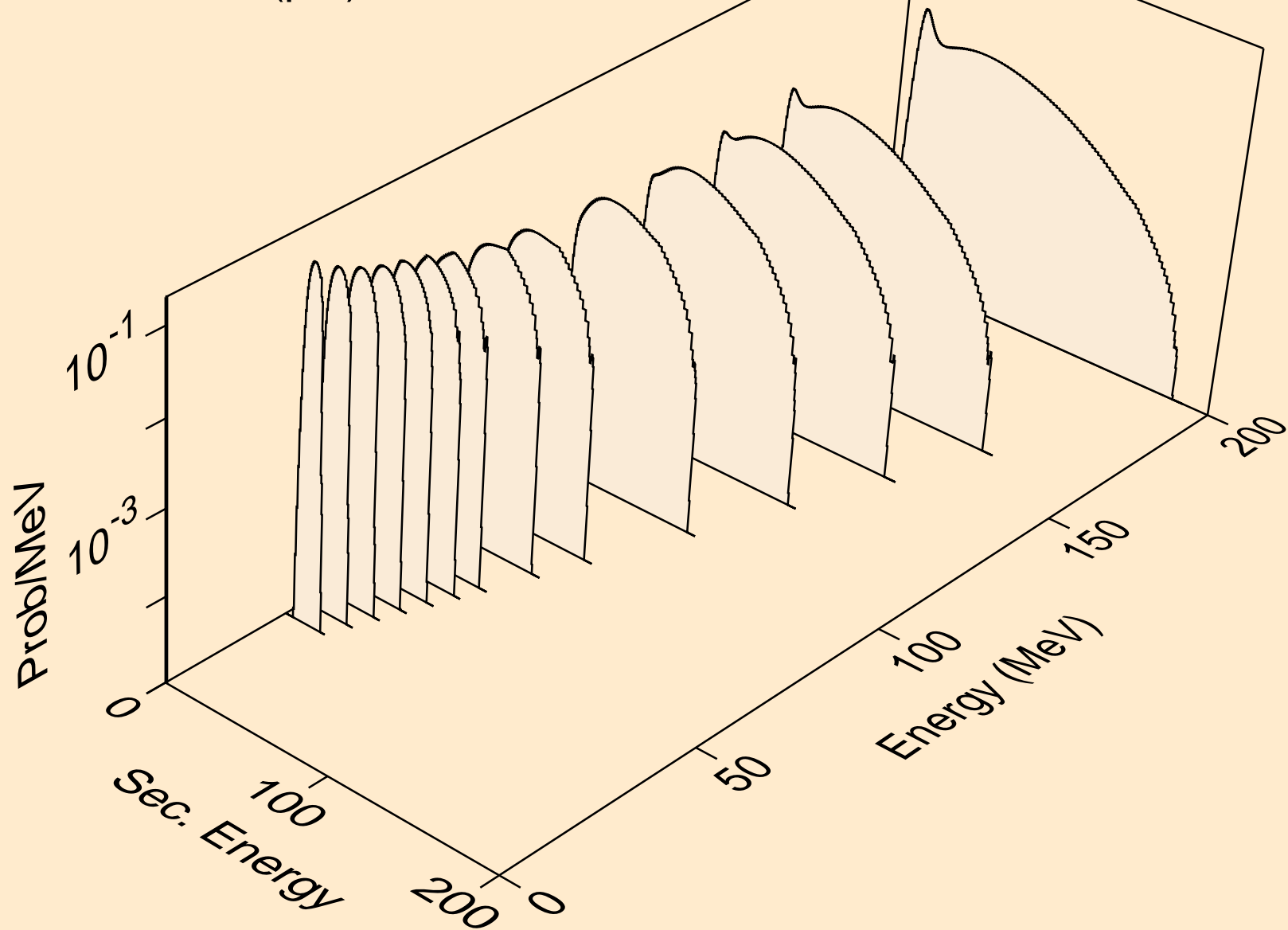

ZN061 PROTON ACER TENDL-2023 LIBRARY; T=0.K
he3s from (p,n*)he3

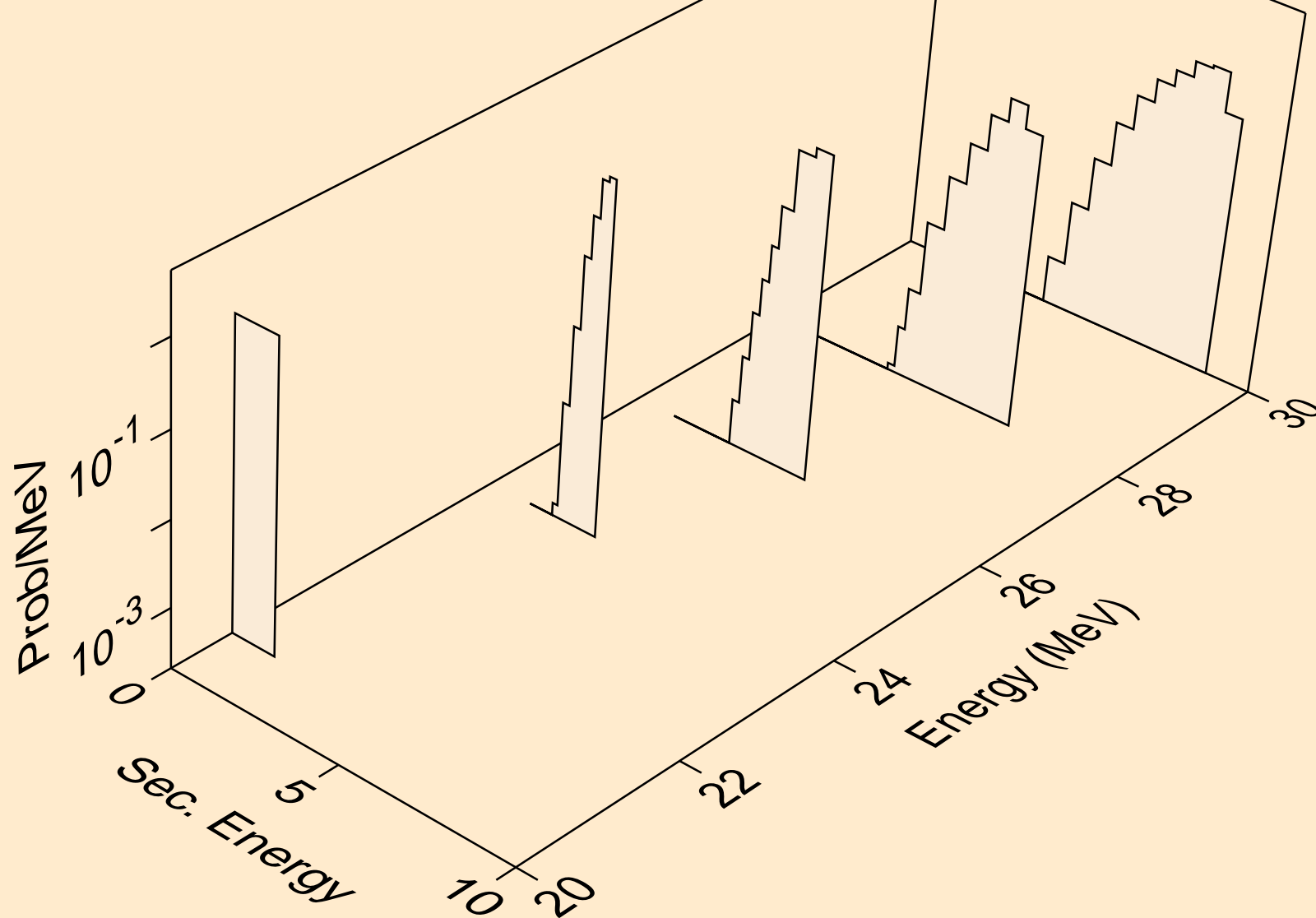

ZN061 PROTON ACER TENDL-2023 LIBRARY; T=0.K
he3s from (p,he3)

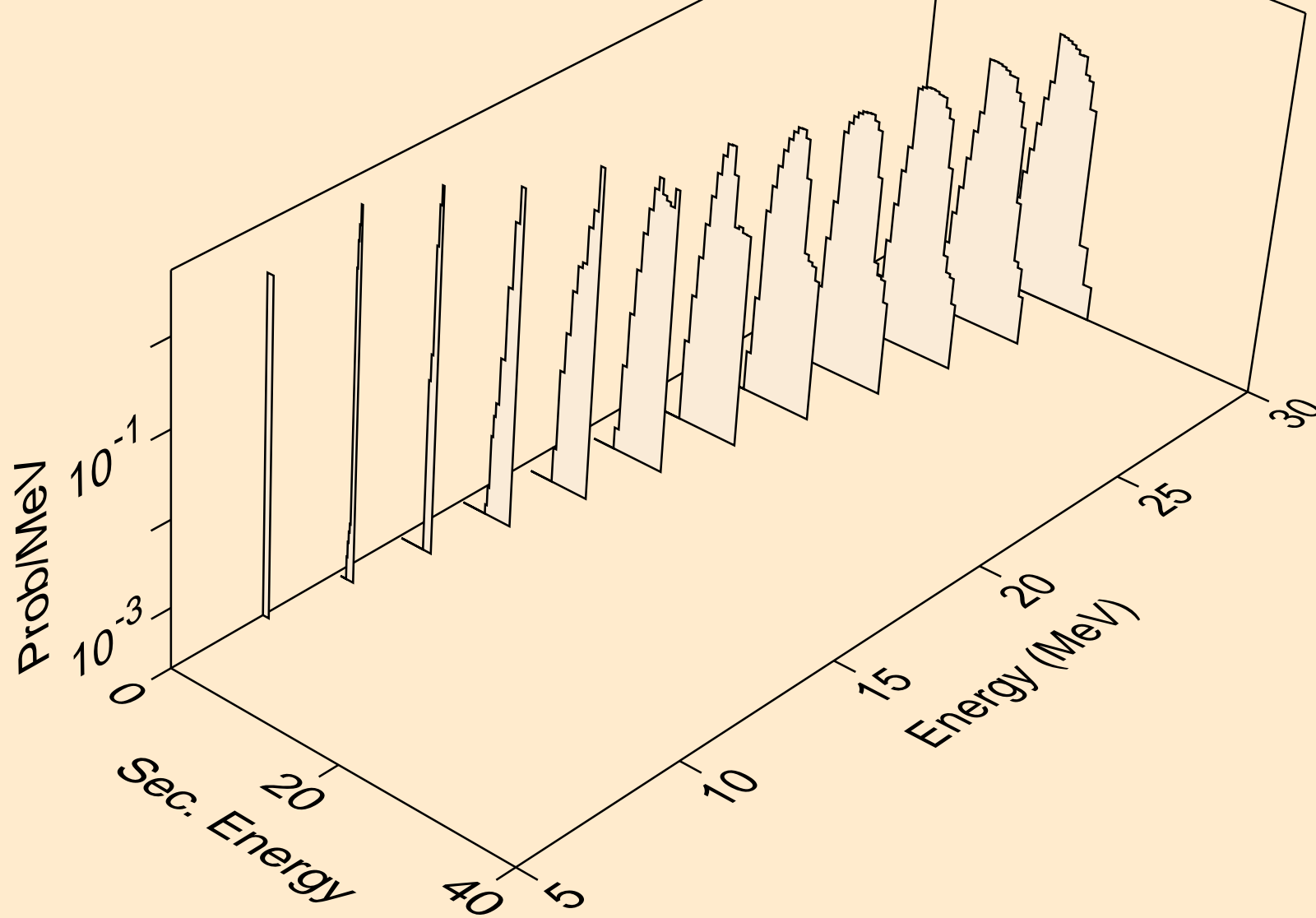

ZN061 PROTON ACER TENDL-2023 LIBRARY; T=0.K
alphas from (p,x)

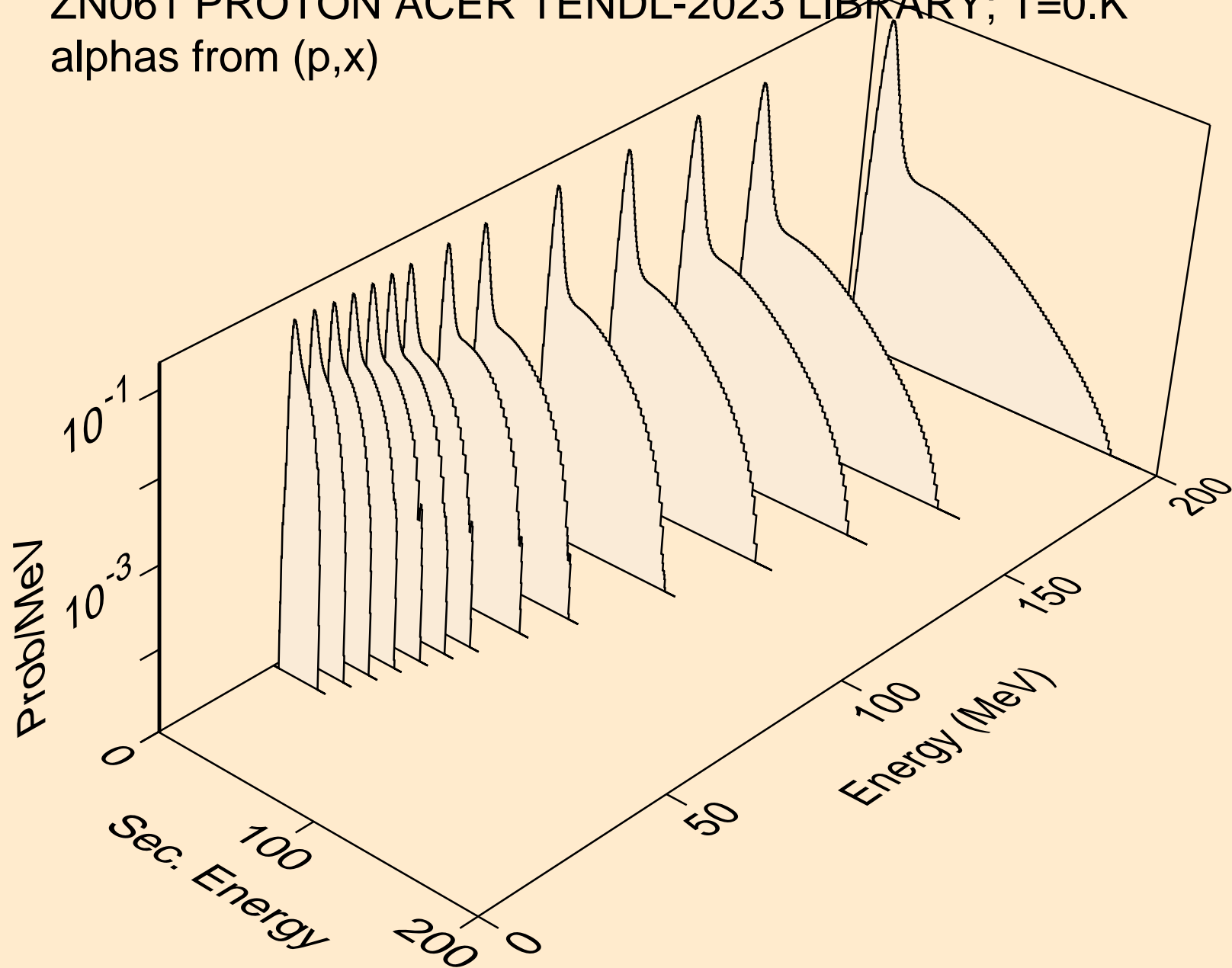

ZN061 PROTON ACER TENDL-2023 LIBRARY; T=0.K
alphas from (p,n*)a

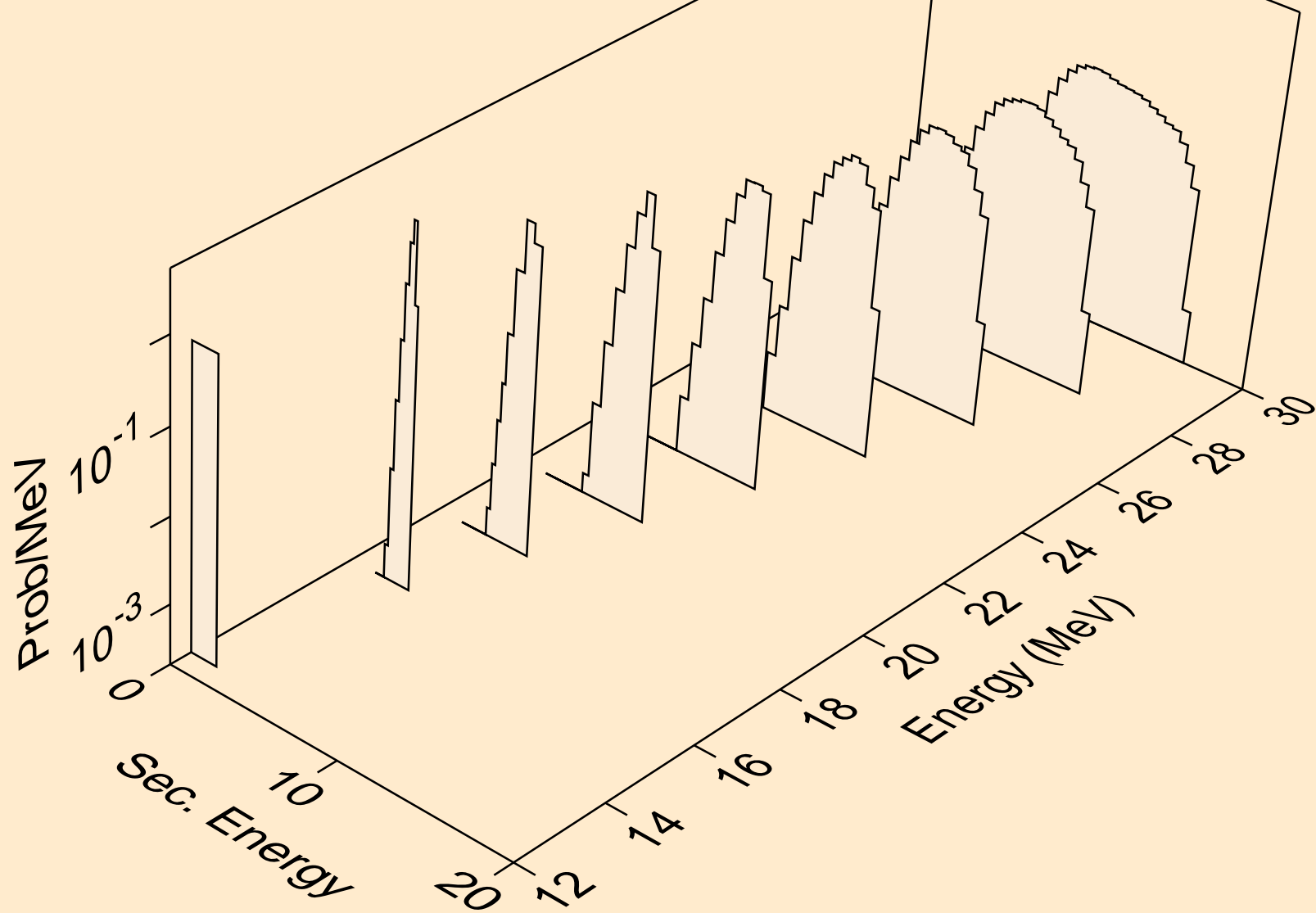

ZN061 PROTON ACER TENDL-2023 LIBRARY; T=0.K
alphas from (p,npa)

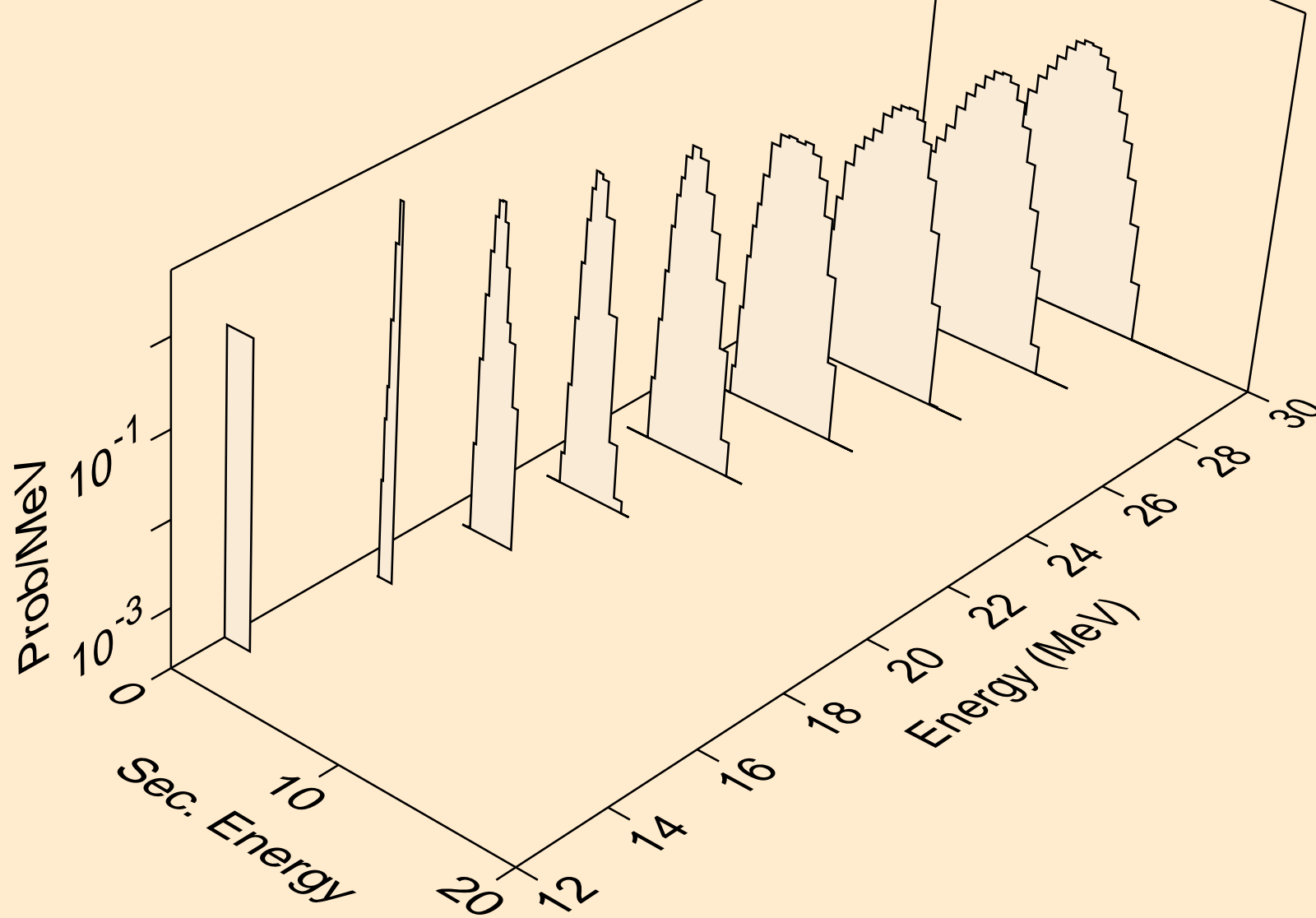

ZN061 PROTON ACER TENDL-2023 LIBRARY; T=0.K
alphas from (p,a)

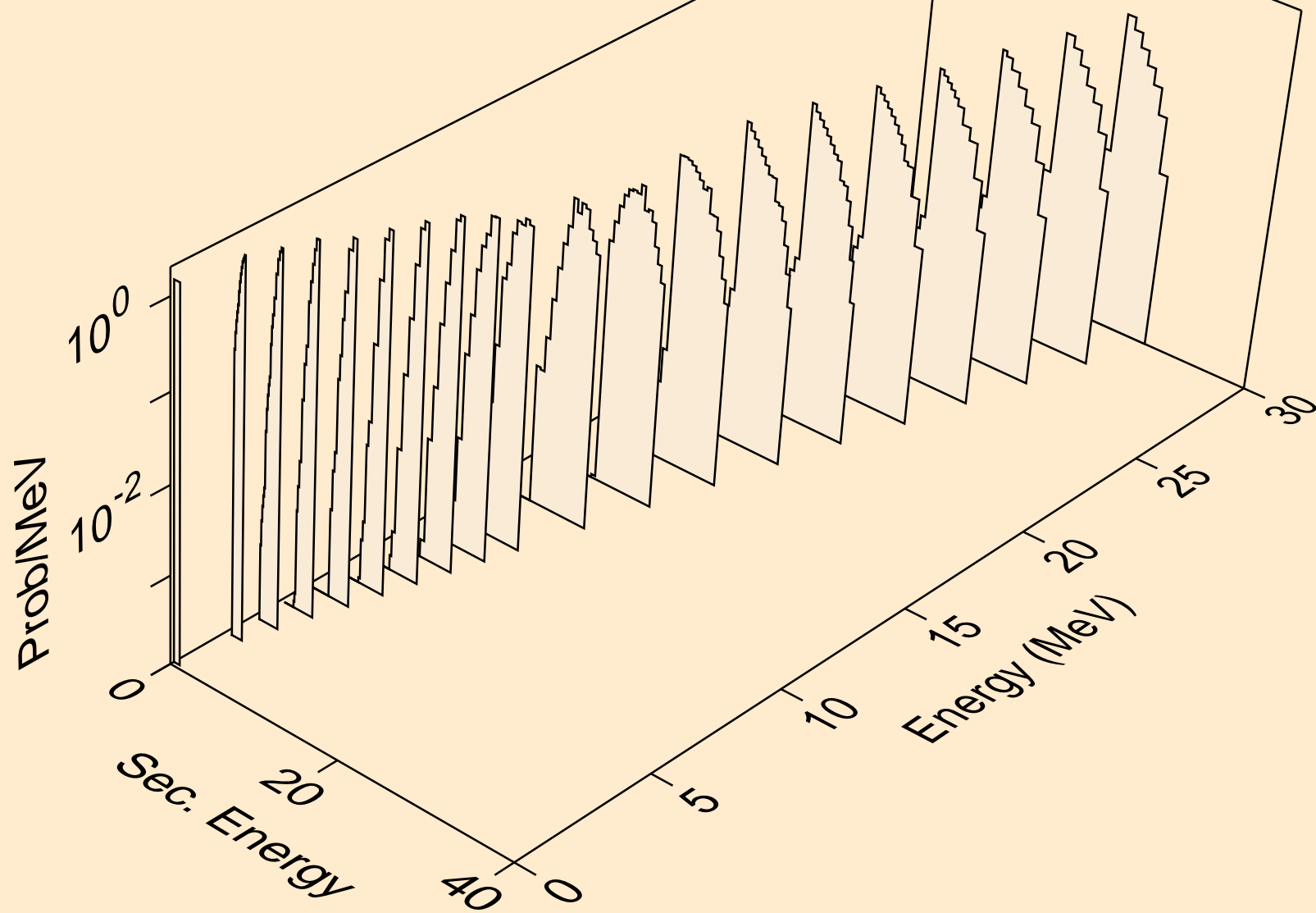

ZN061 PROTON ACER TENDL-2023 LIBRARY; T=0.K
alphas from (p,2a)

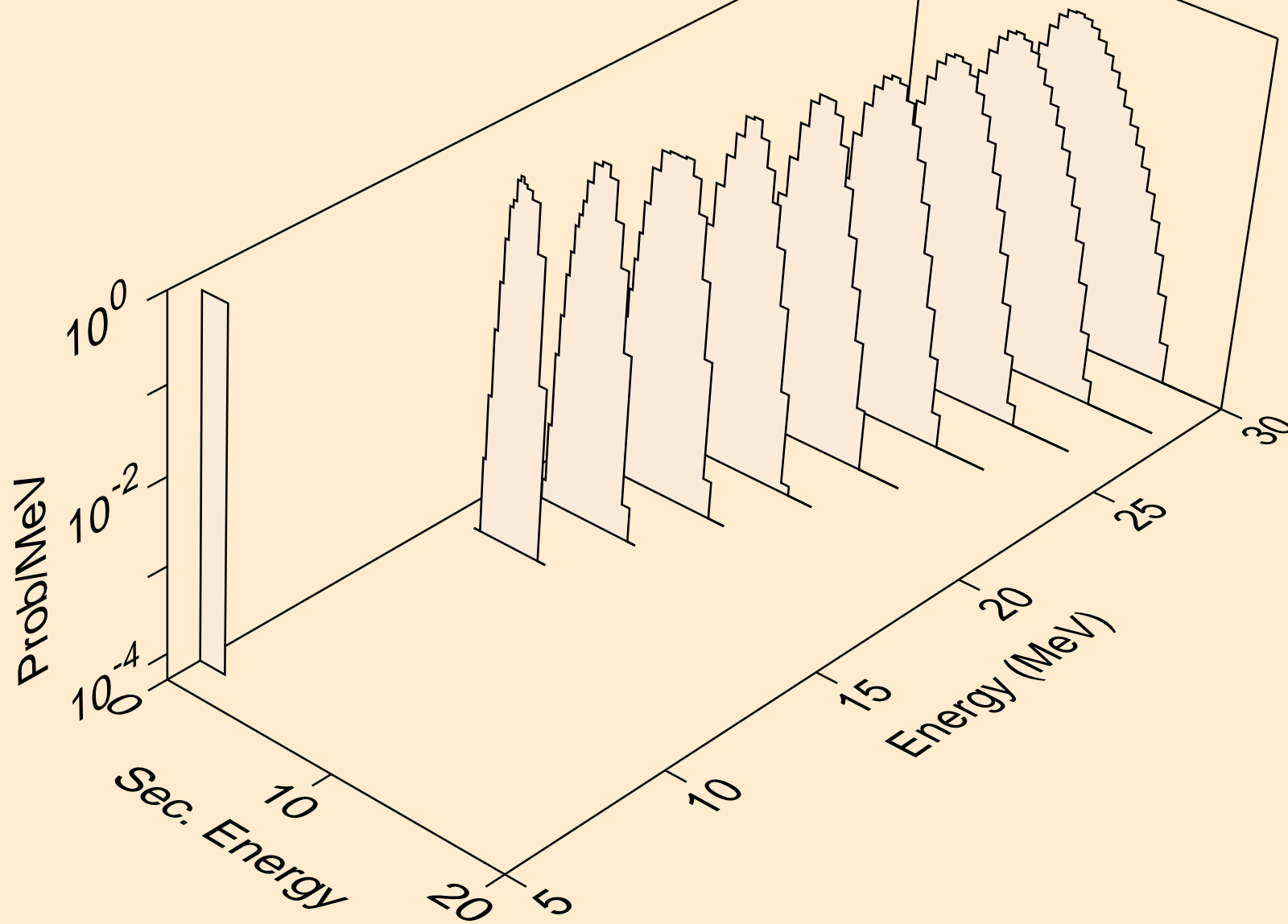

ZN061 PROTON ACER TENDL-2023 LIBRARY; T=0.K
alphas from (p,pa)

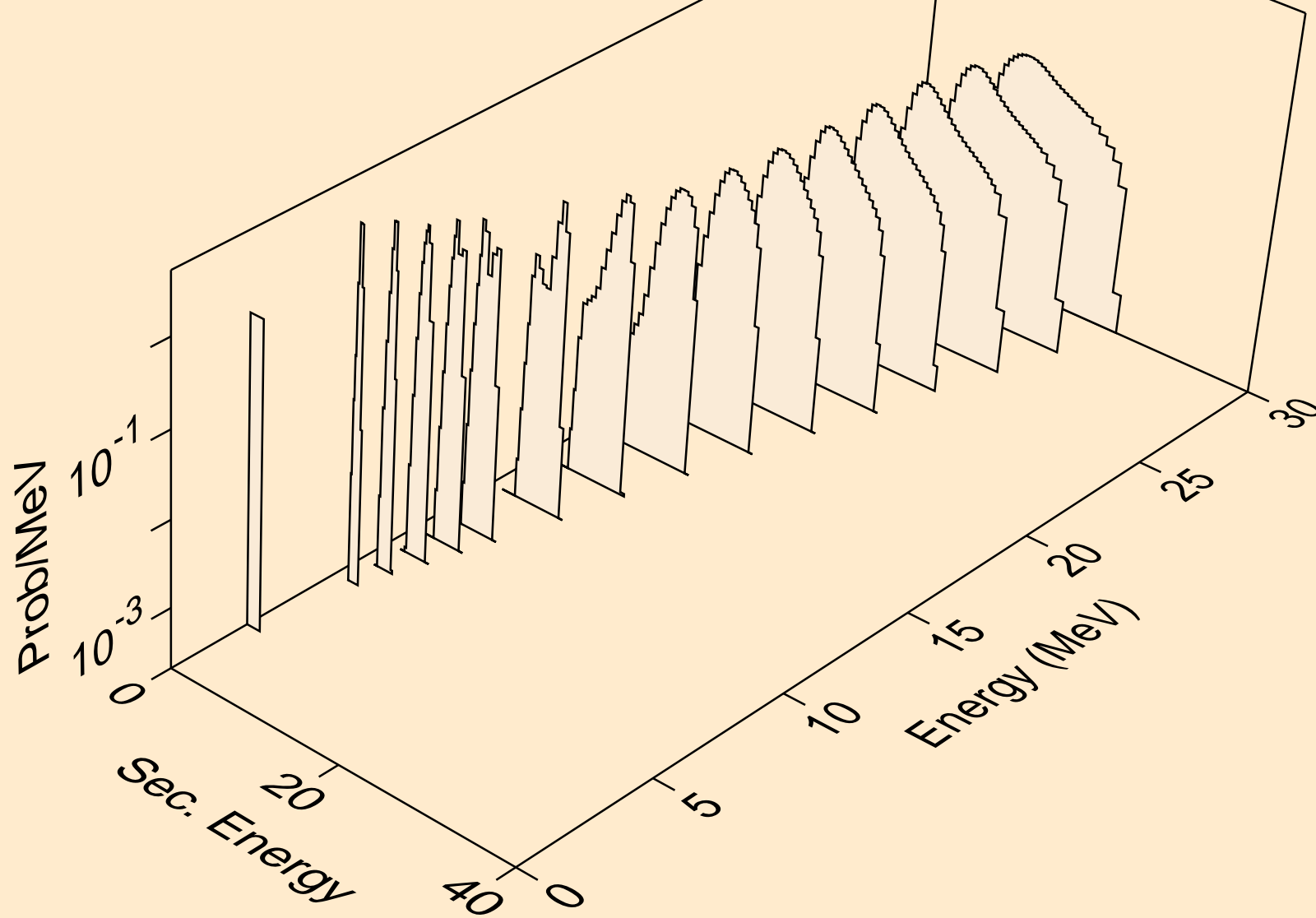

ZN061 PROTON ACER TENDL-2023 LIBRARY; T=0.K
alphas from (p,da)

