

# AG118M TRITON ACER TENDL-2021 LIBRARY; T=0.K

## Principal cross sections

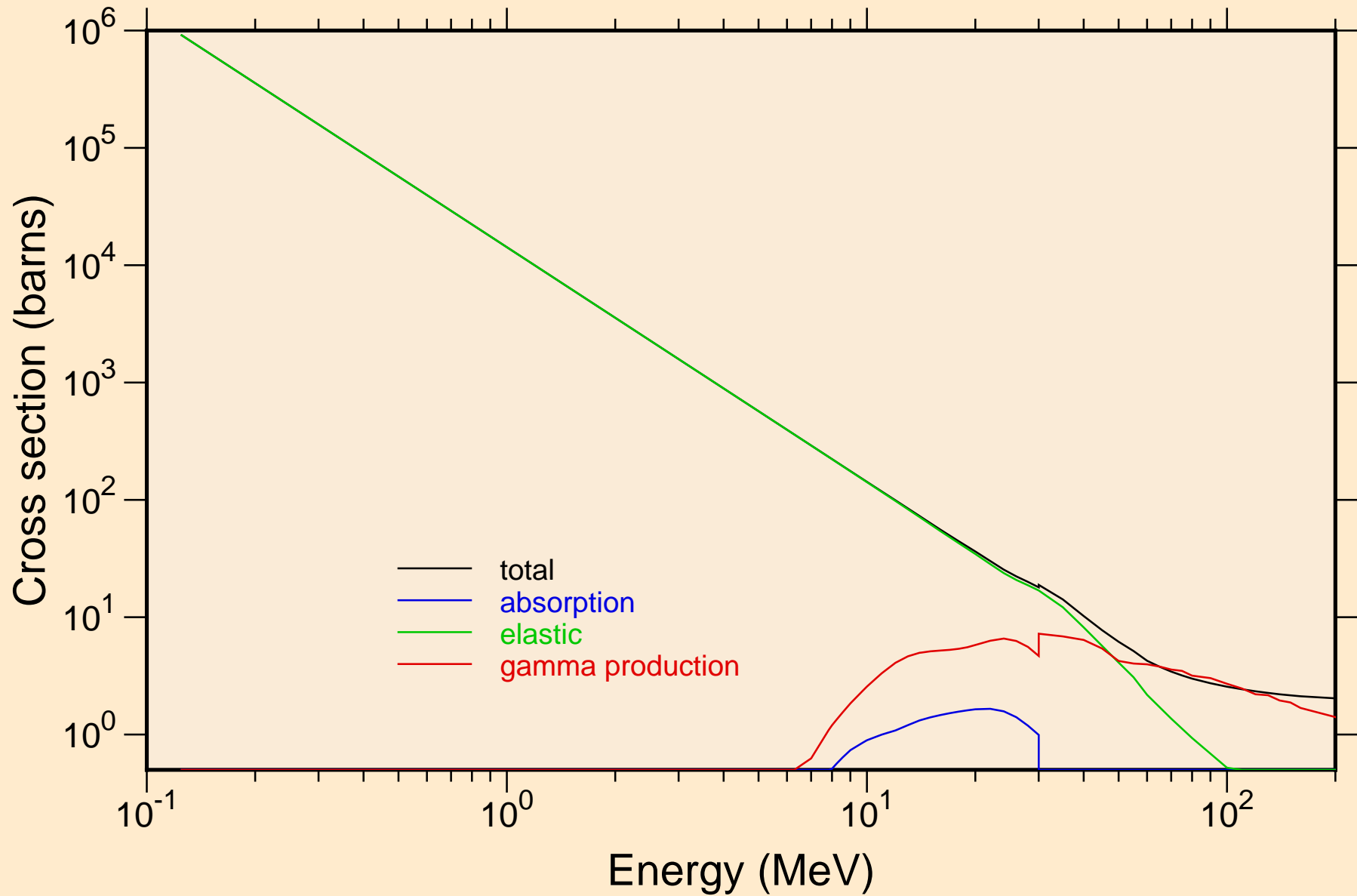

# AG118M TRITON ACER TENDL-2021 LIBRARY; T=0.K

## Heating

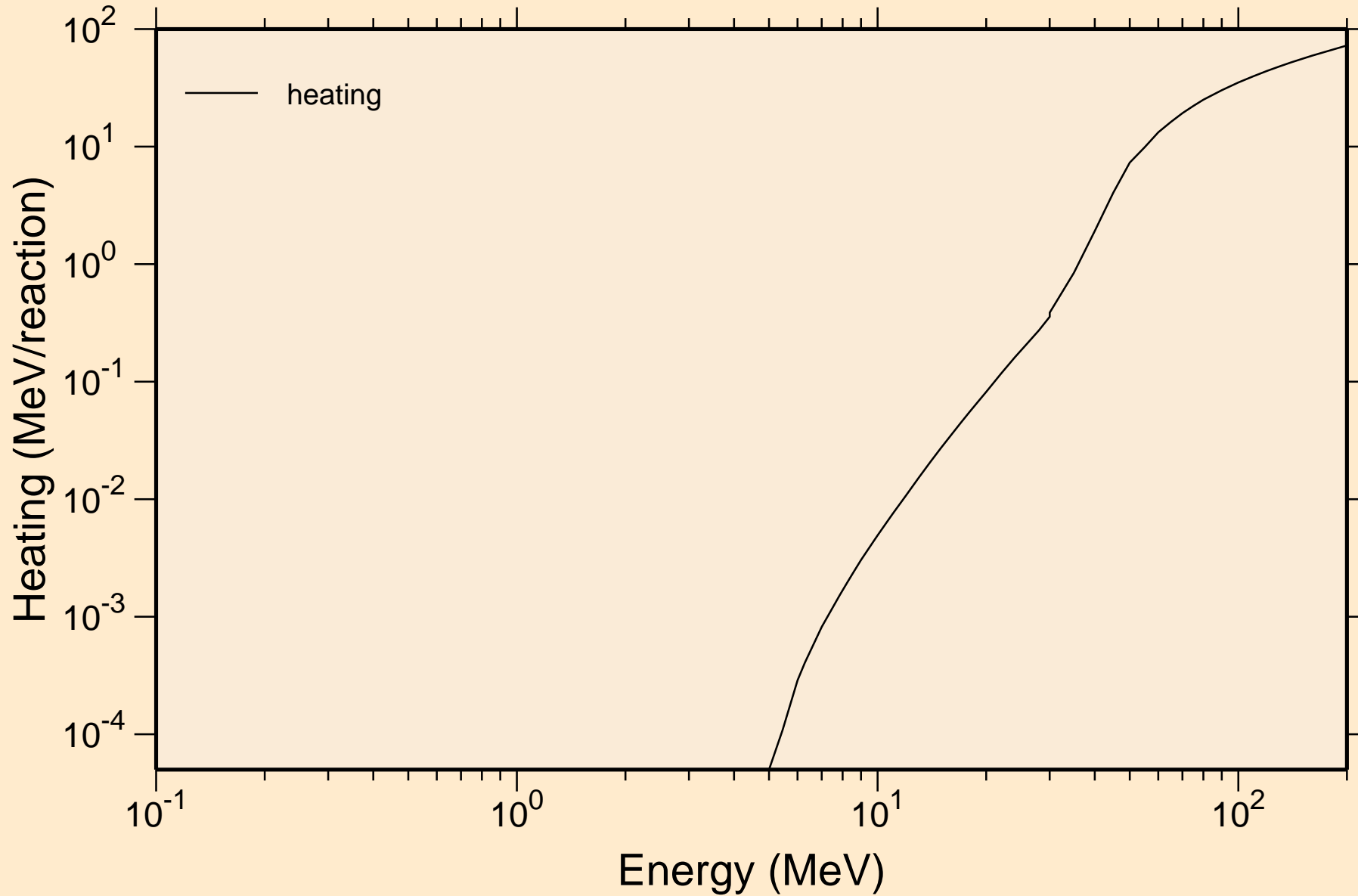

# AG118M TRITON ACER TENDL-2021 LIBRARY; T=0.K

## Principal cross sections

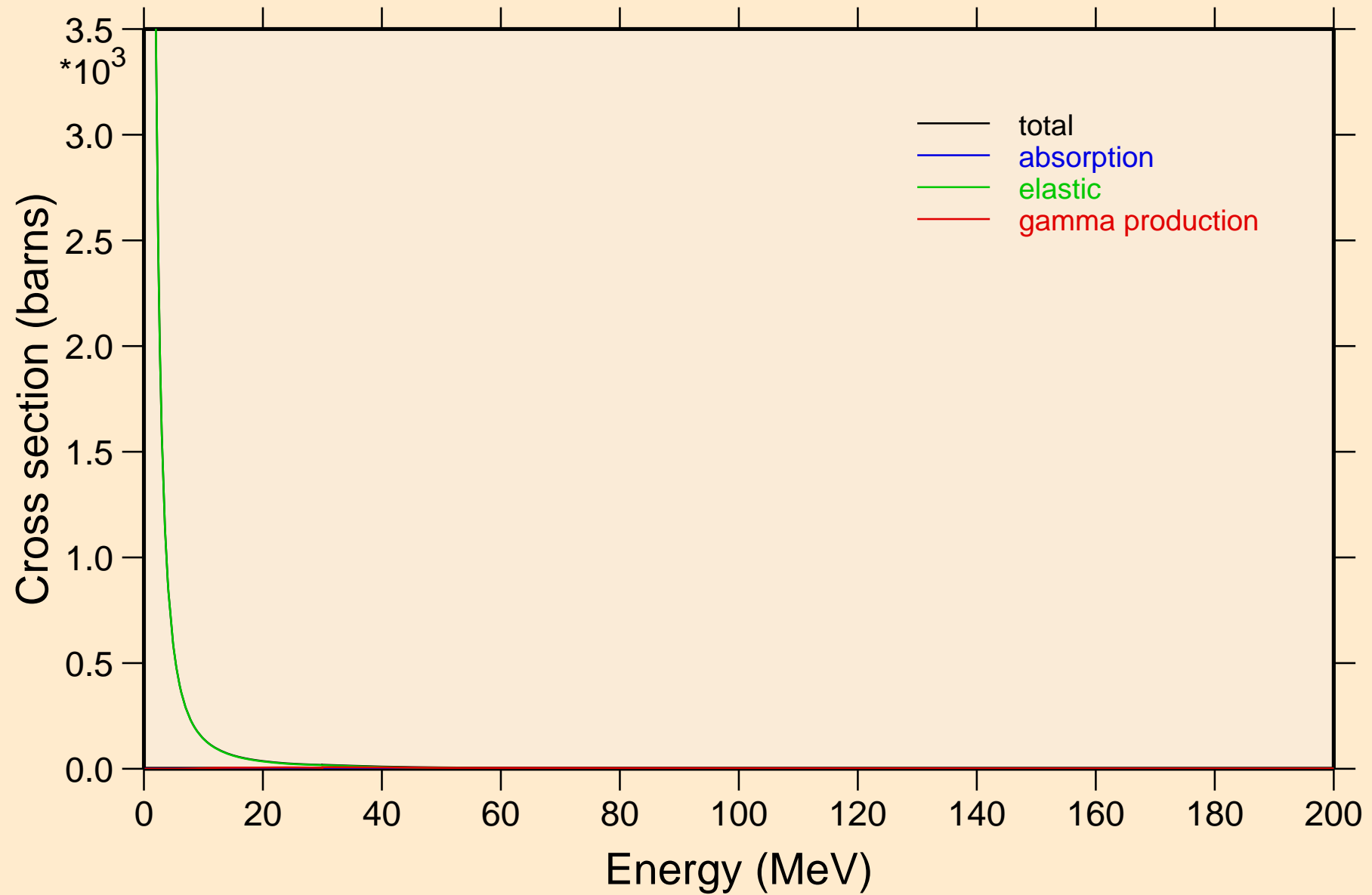

AG118M TRITON ACER TENDL-2021 LIBRARY; T=0.K

Heating

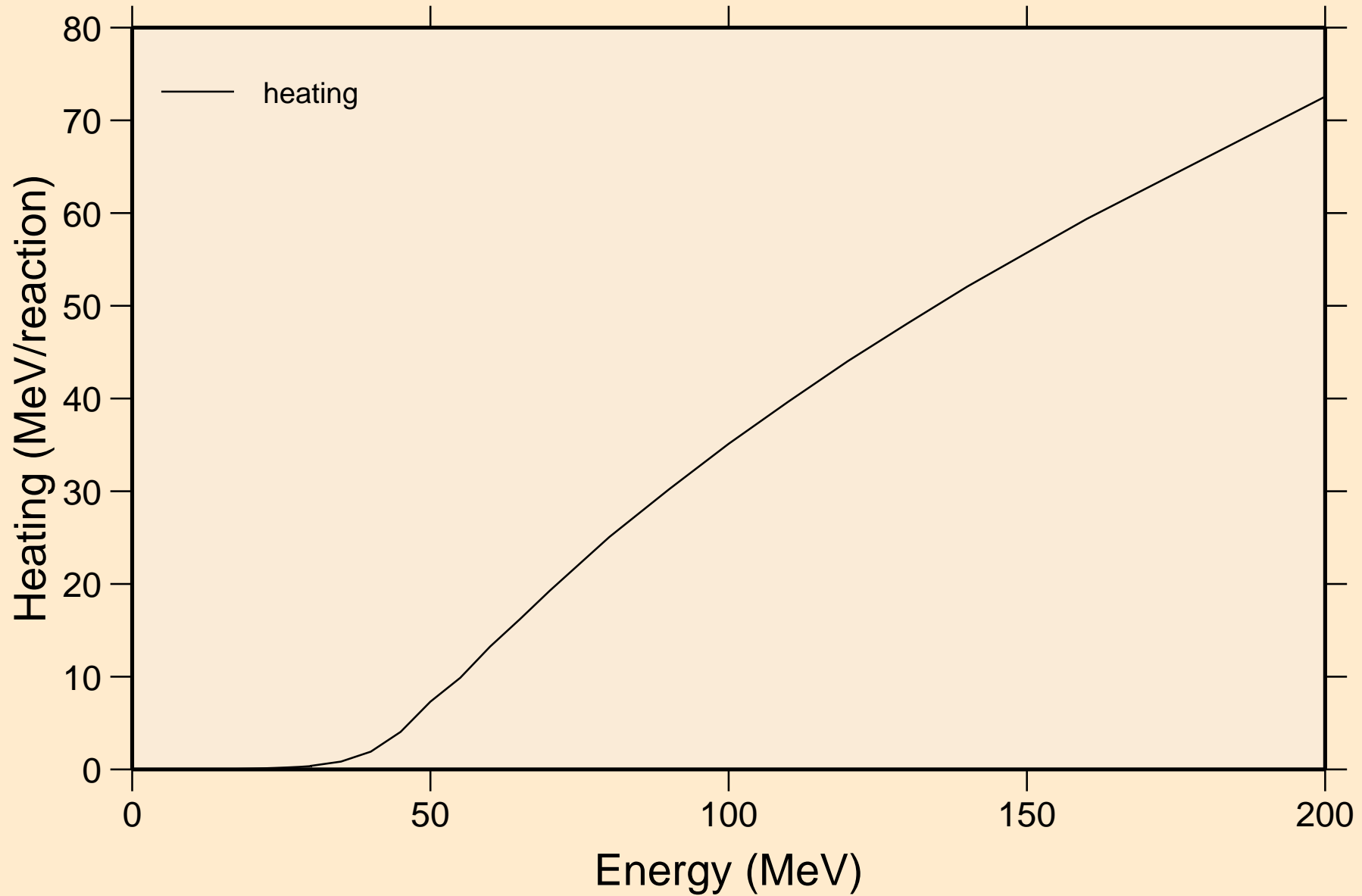

AG118M TRITON ACER TENDL-2021 LIBRARY; T=0.K  
Threshold reactions

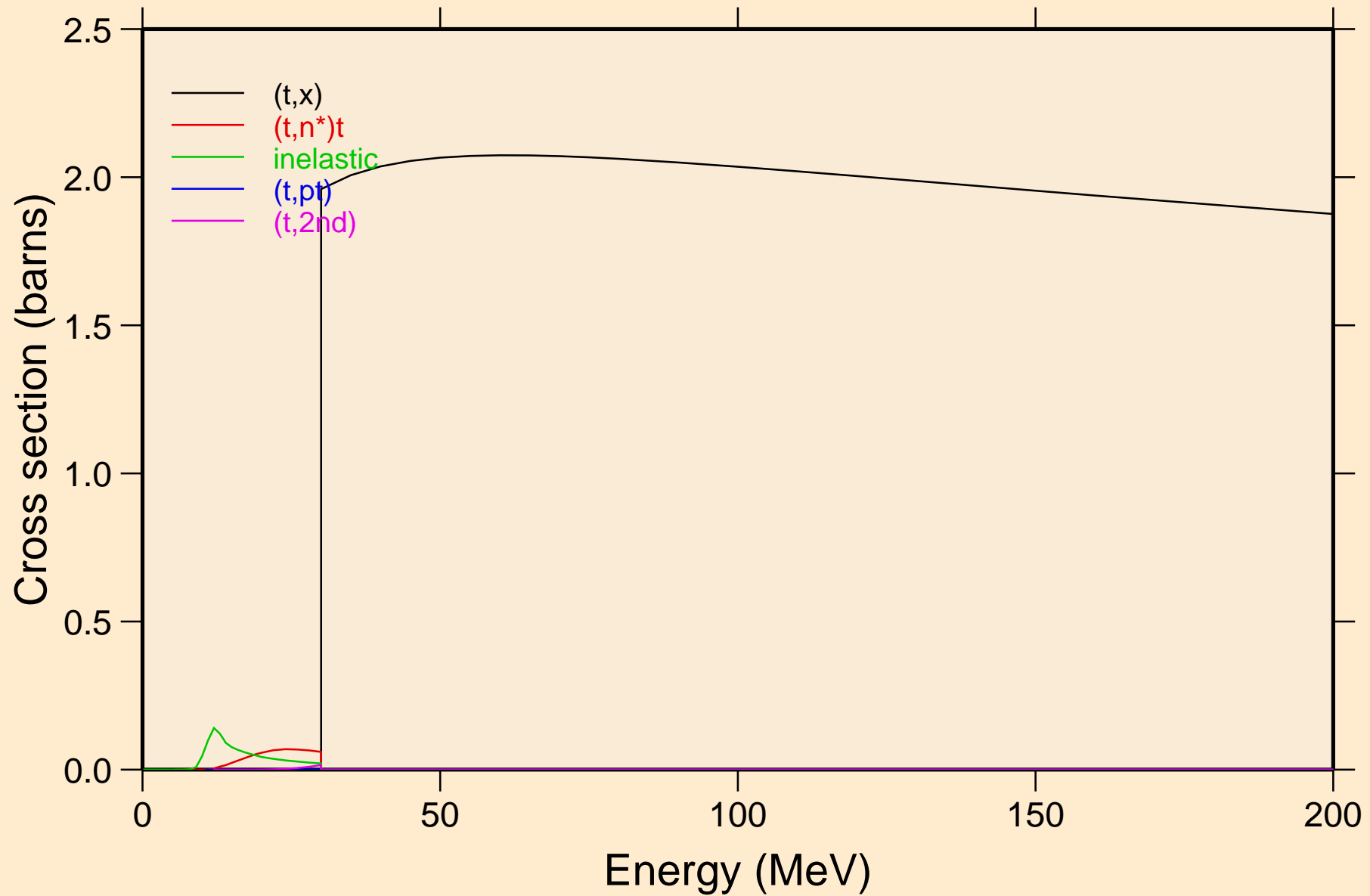

AG118M TRITON ACER TENDL-2021 LIBRARY; T=0.K  
Threshold reactions

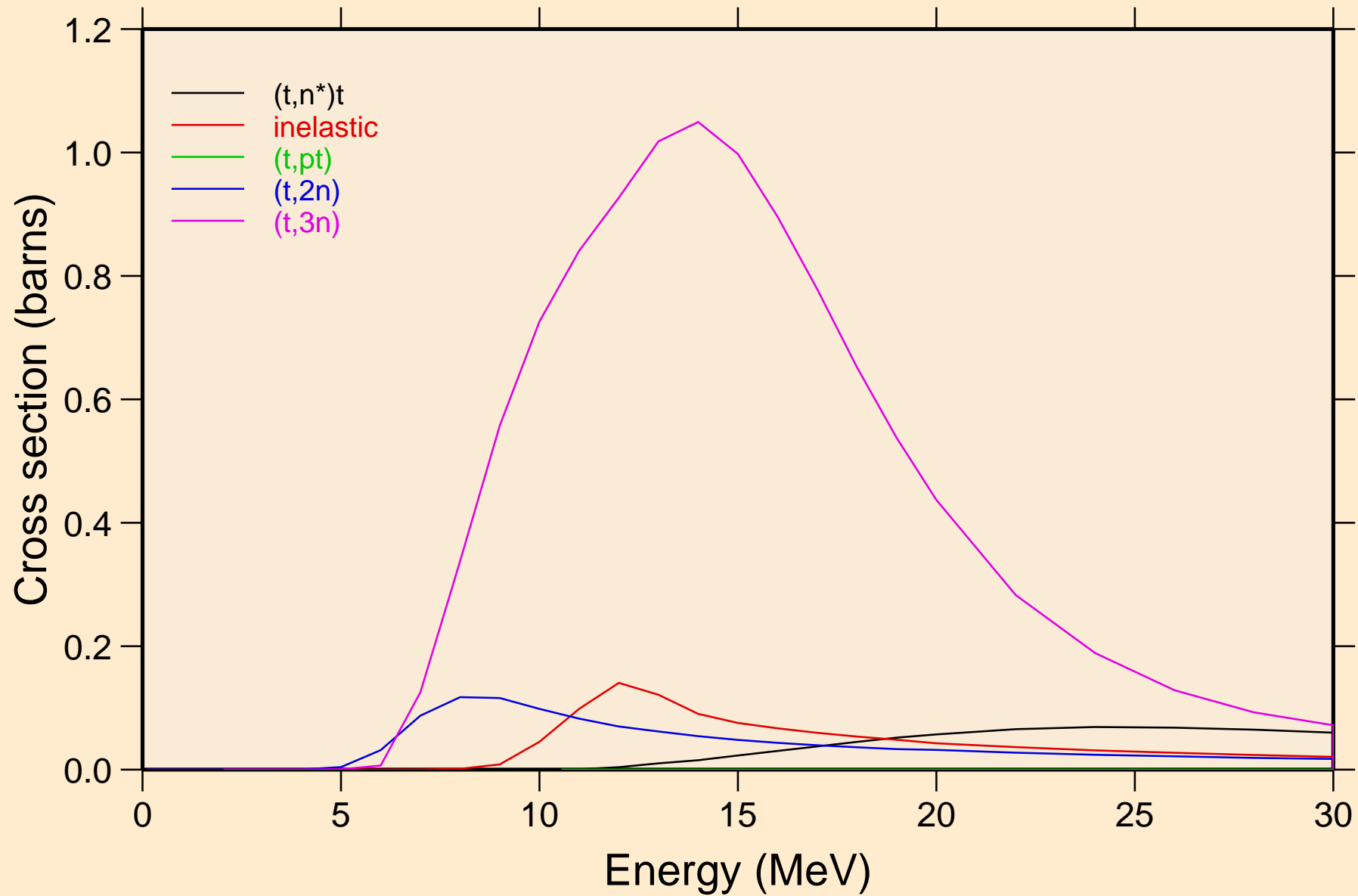

AG118M TRITON ACER TENDL-2021 LIBRARY; T=0.K  
Threshold reactions

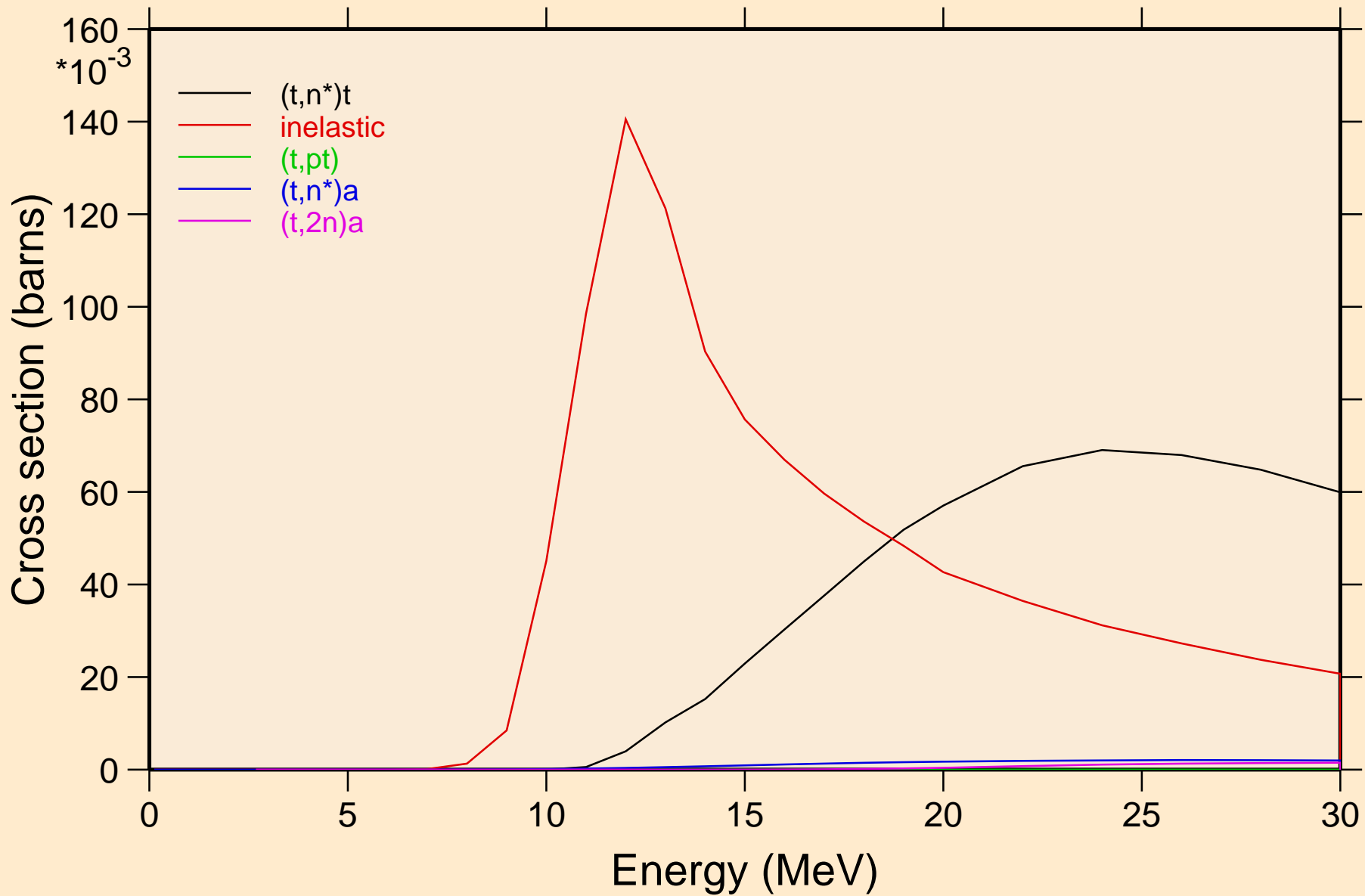

AG118M TRITON ACER TENDL-2021 LIBRARY; T=0.K  
Threshold reactions

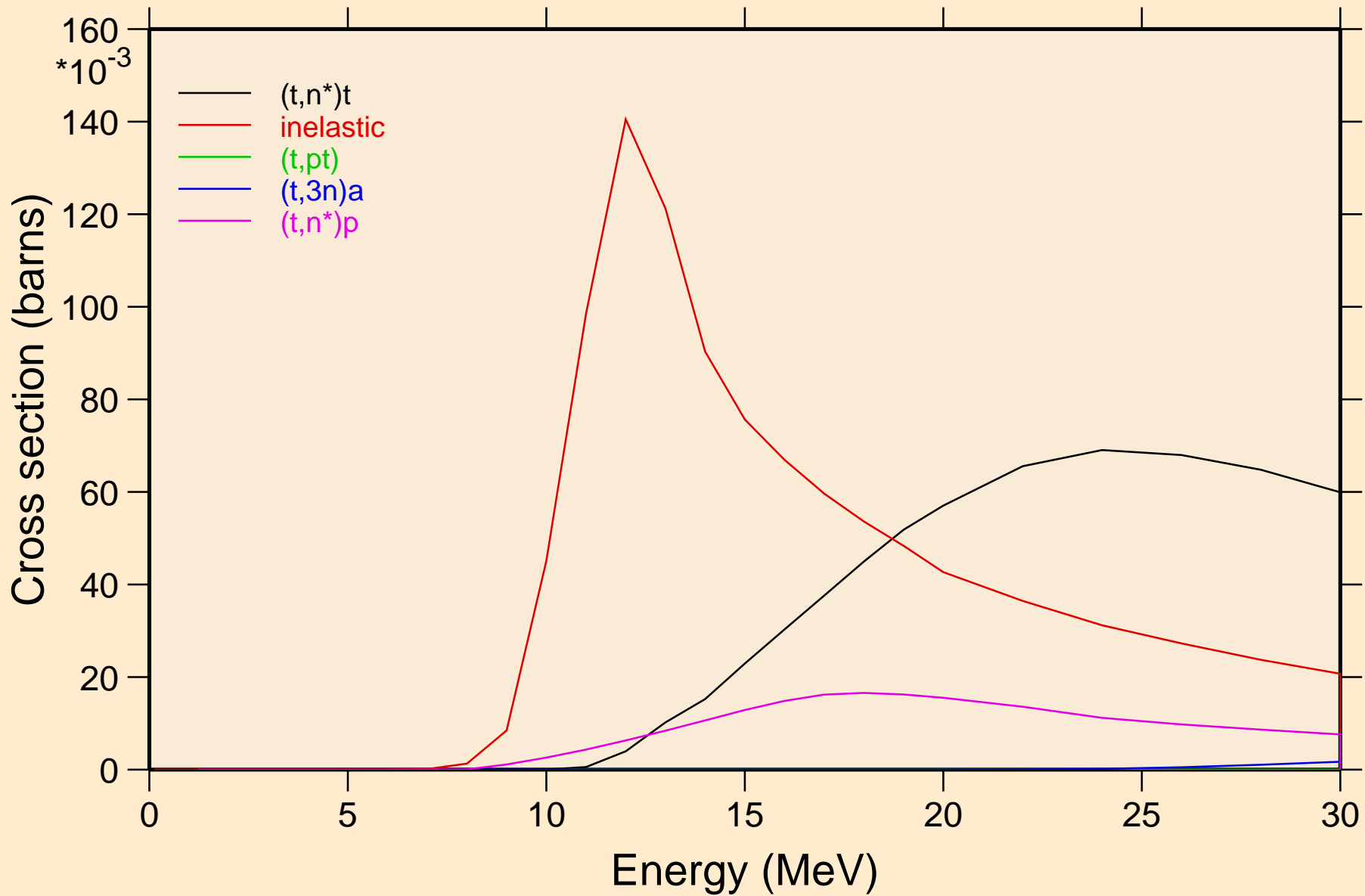



AG118M TRITON ACER TENDL-2021 LIBRARY; T=0.K  
Threshold reactions

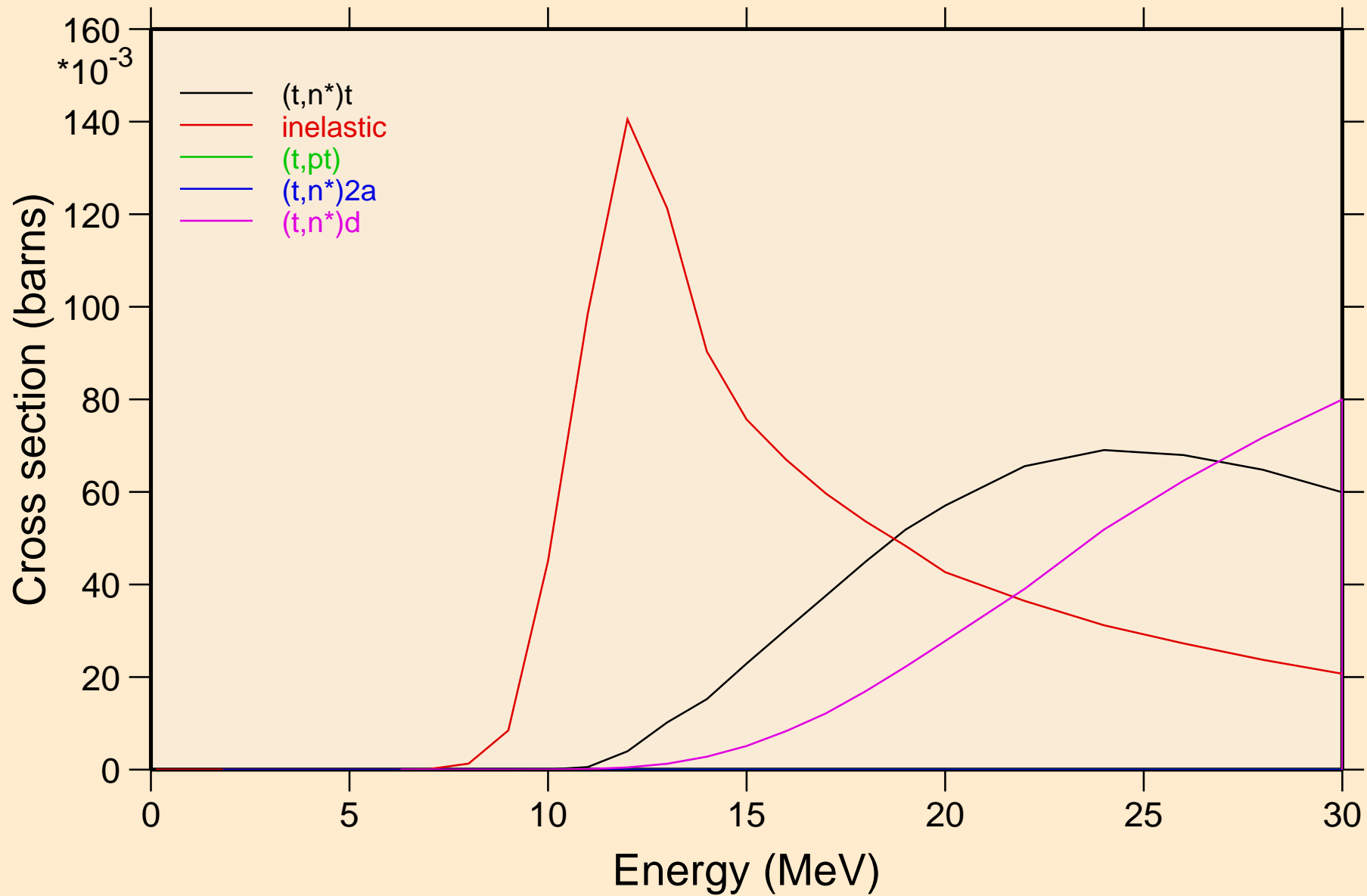

AG118M TRITON ACER TENDL-2021 LIBRARY; T=0.K  
Threshold reactions

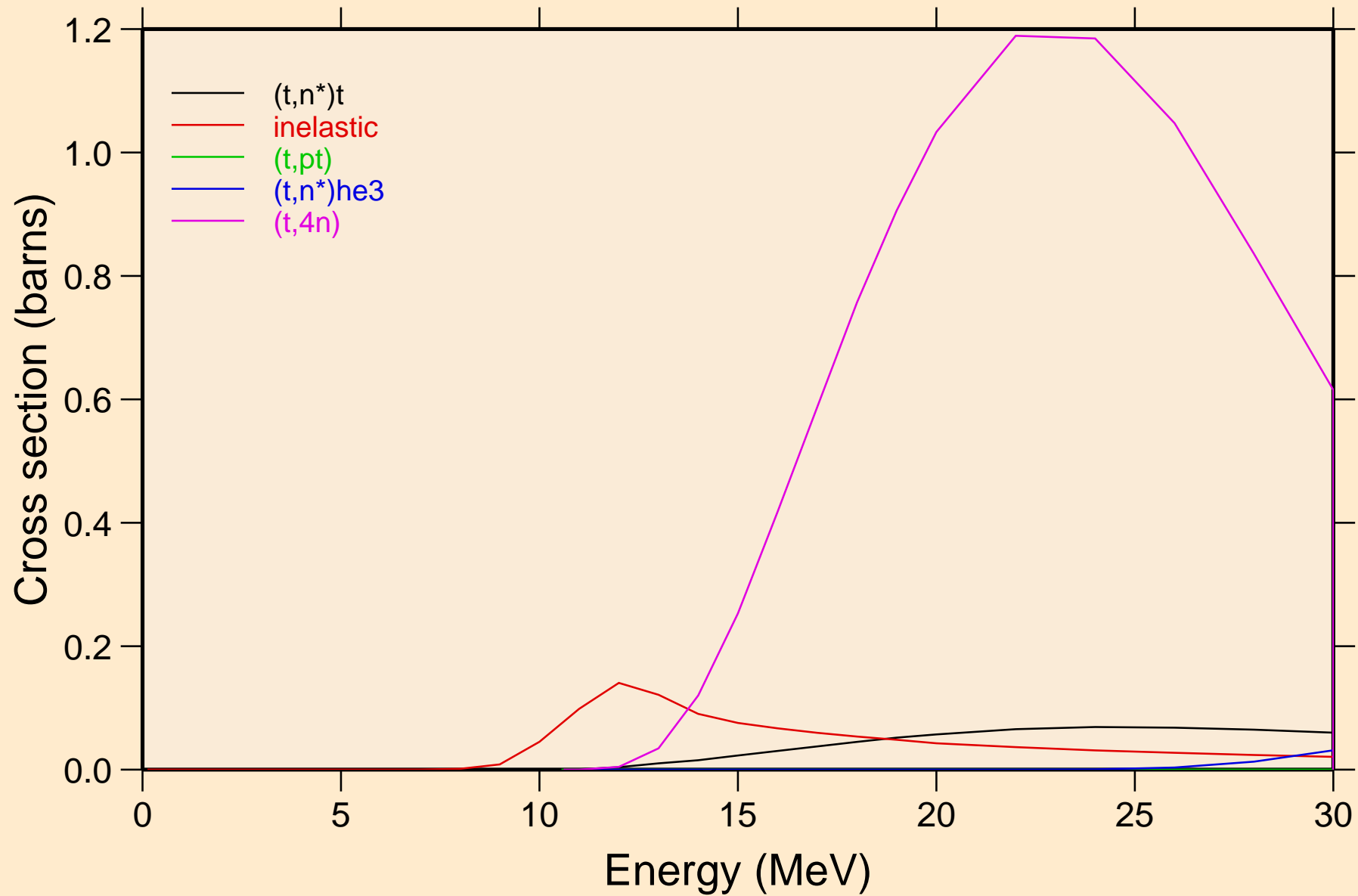

# AG118M TRITON ACER TENDL-2021 LIBRARY; T=0.K

## Threshold reactions

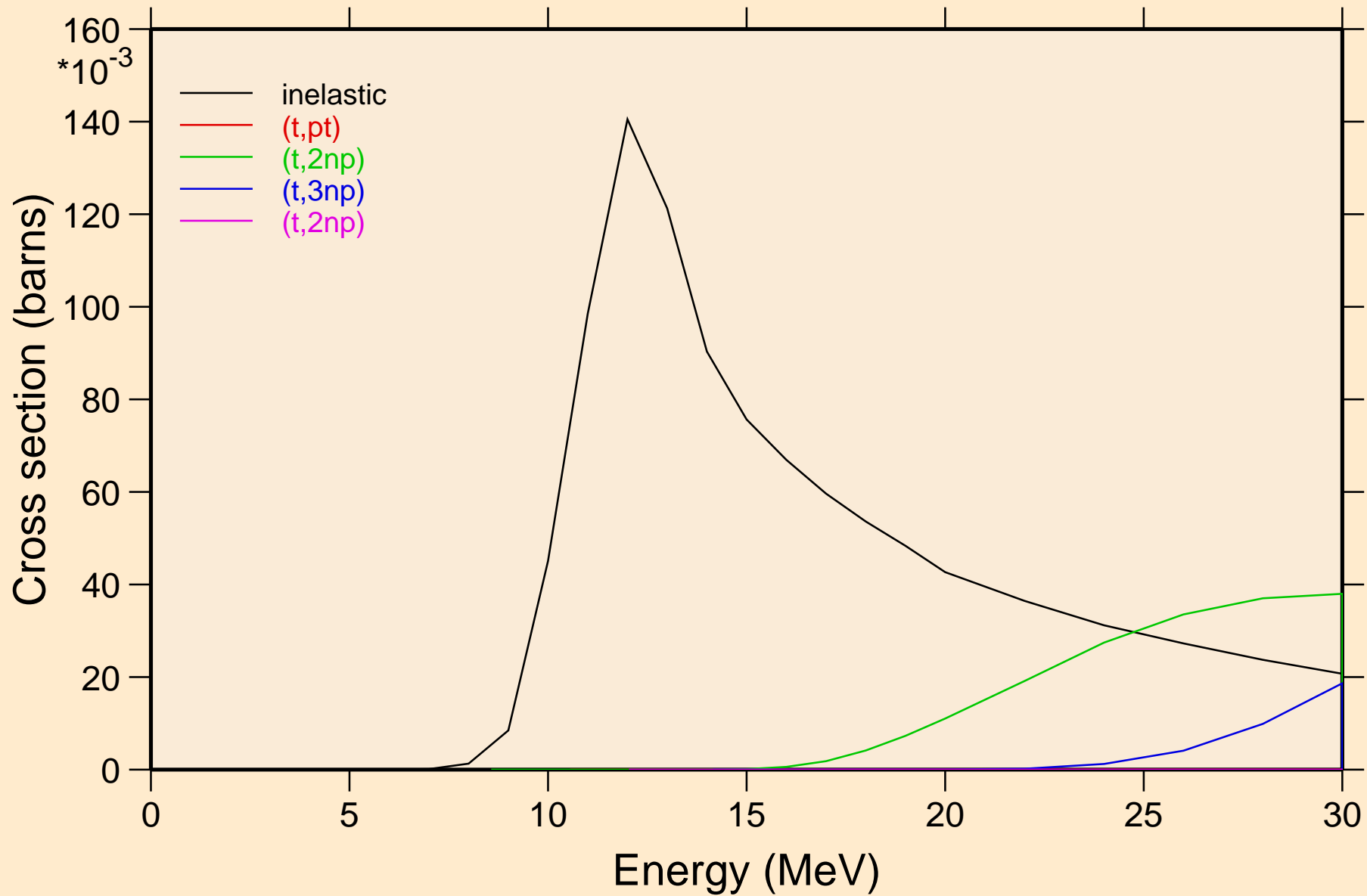

AG118M TRITON ACER TENDL-2021 LIBRARY; T=0.K  
Threshold reactions

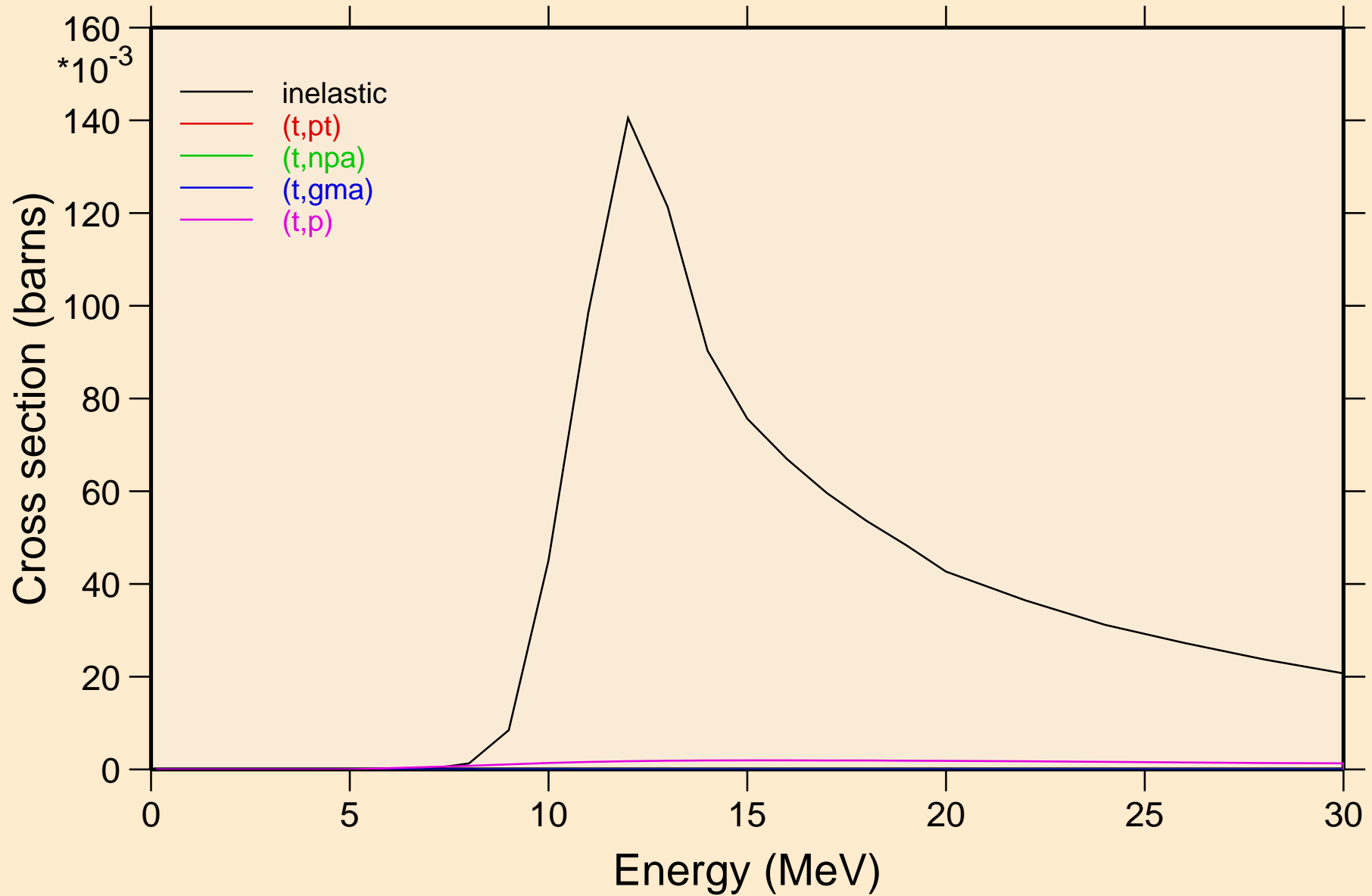

# AG118M TRITON ACER TENDL-2021 LIBRARY; T=0.K

## Threshold reactions

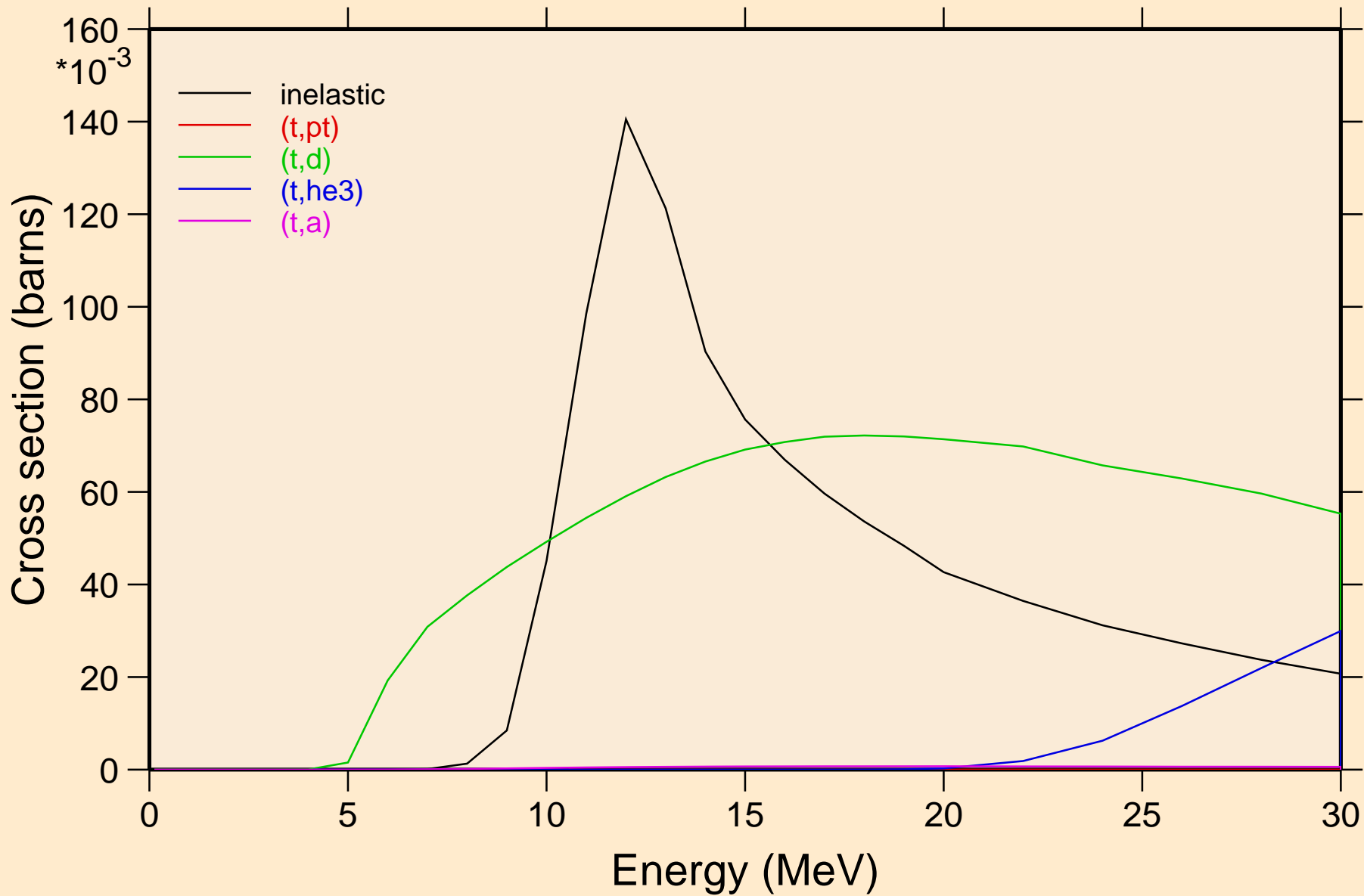

AG118M TRITON ACER TENDL-2021 LIBRARY; T=0.K  
Threshold reactions

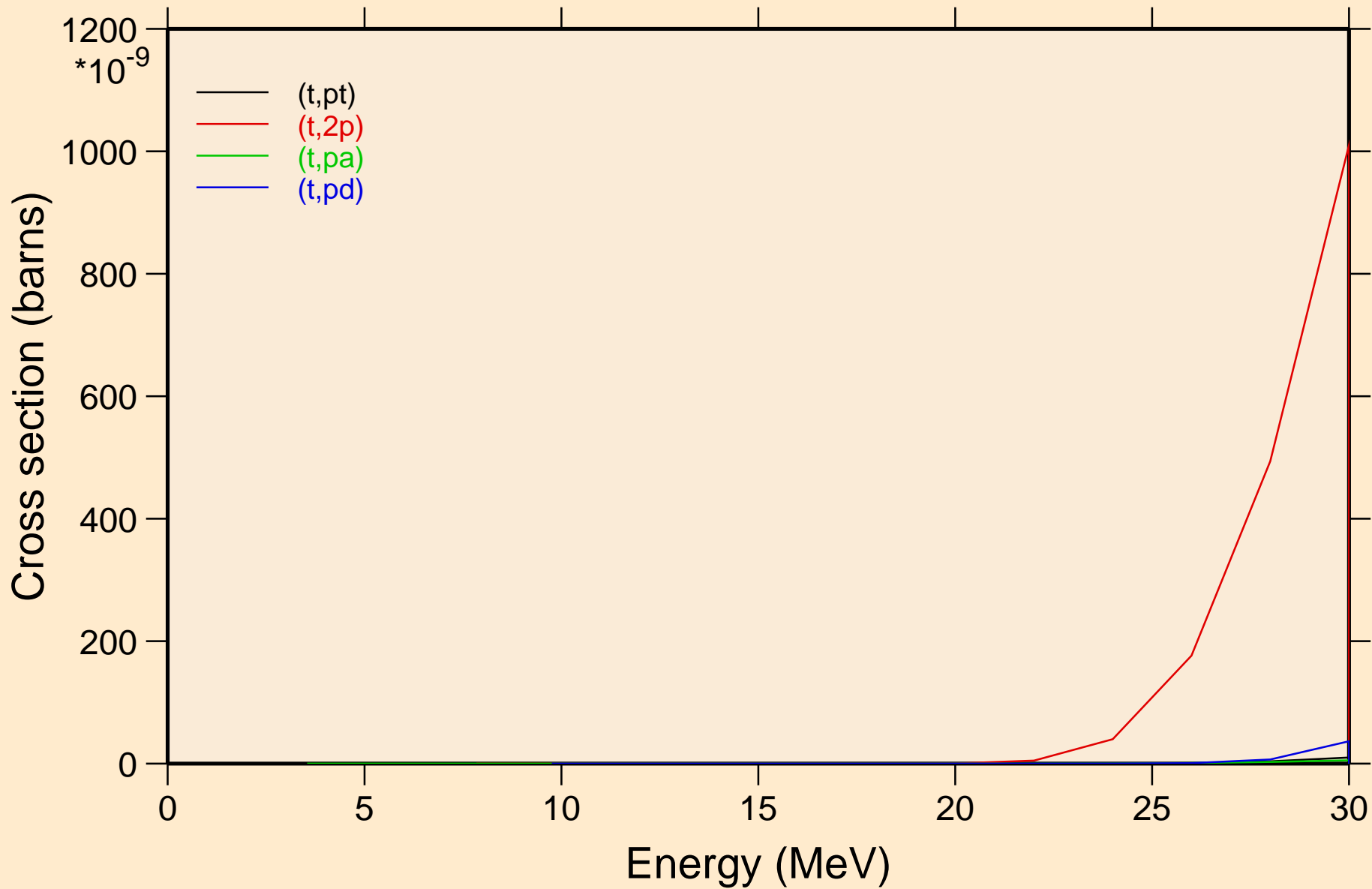

AG118M TRITON ACER TENDL-2021 LIBRARY; T=0.K  
Threshold reactions

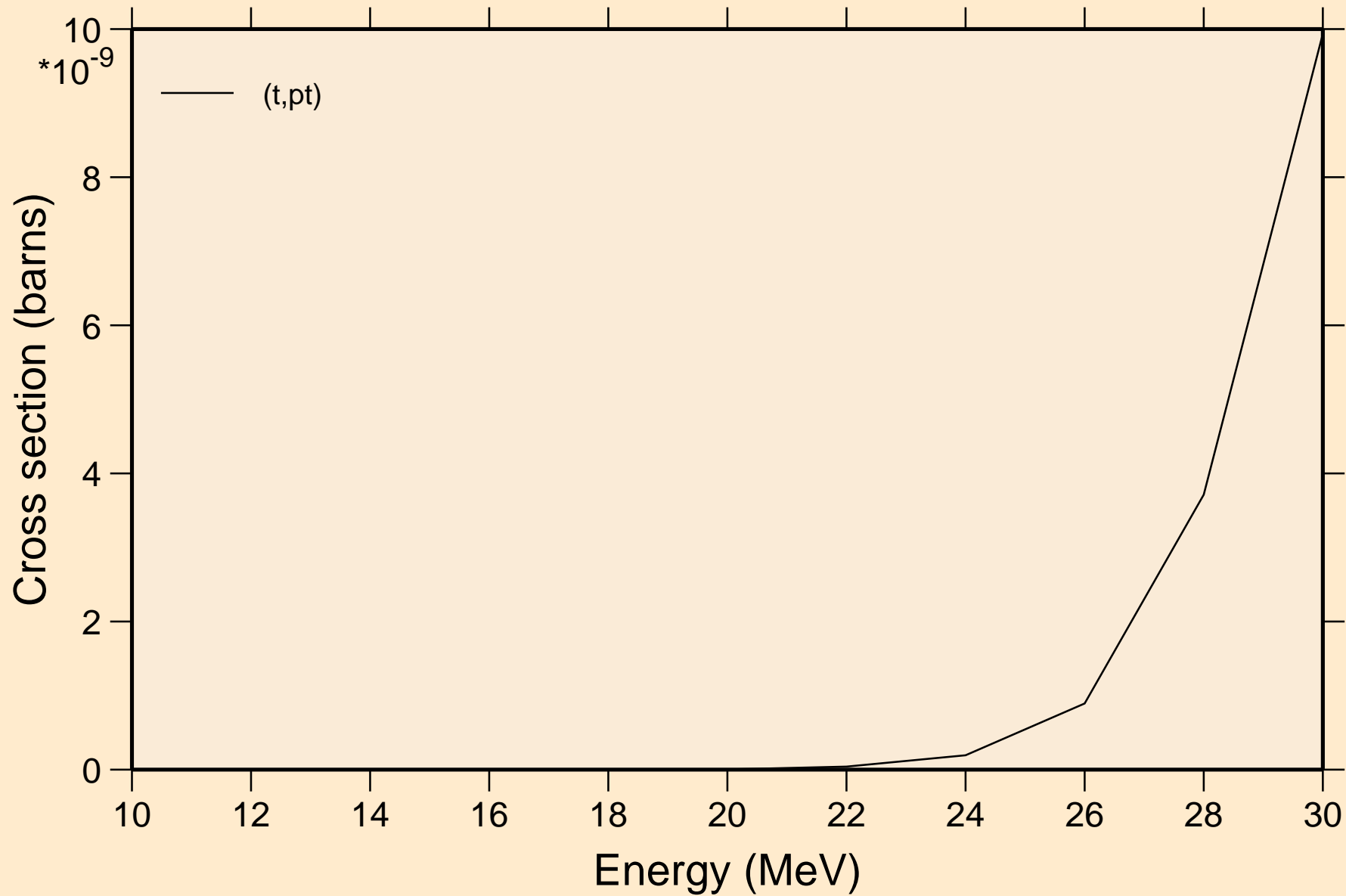

AG118M TRITON ACER TENDL-2021 LIBRARY; T=0.K  
angular distribution for elastic

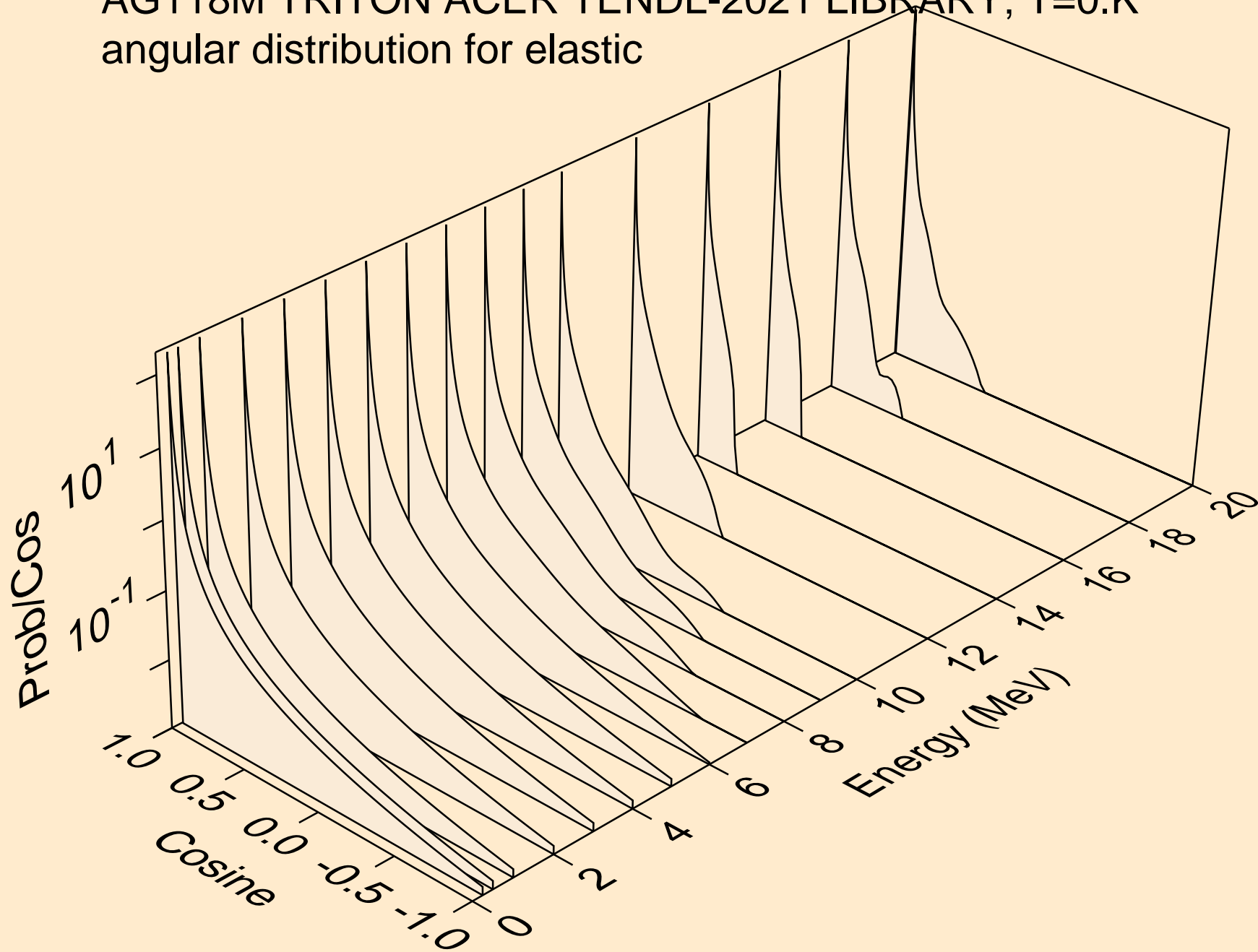



AG118M TRITON ACER TENDL-2021 LIBRARY; T=0.K  
angular distribution for elastic

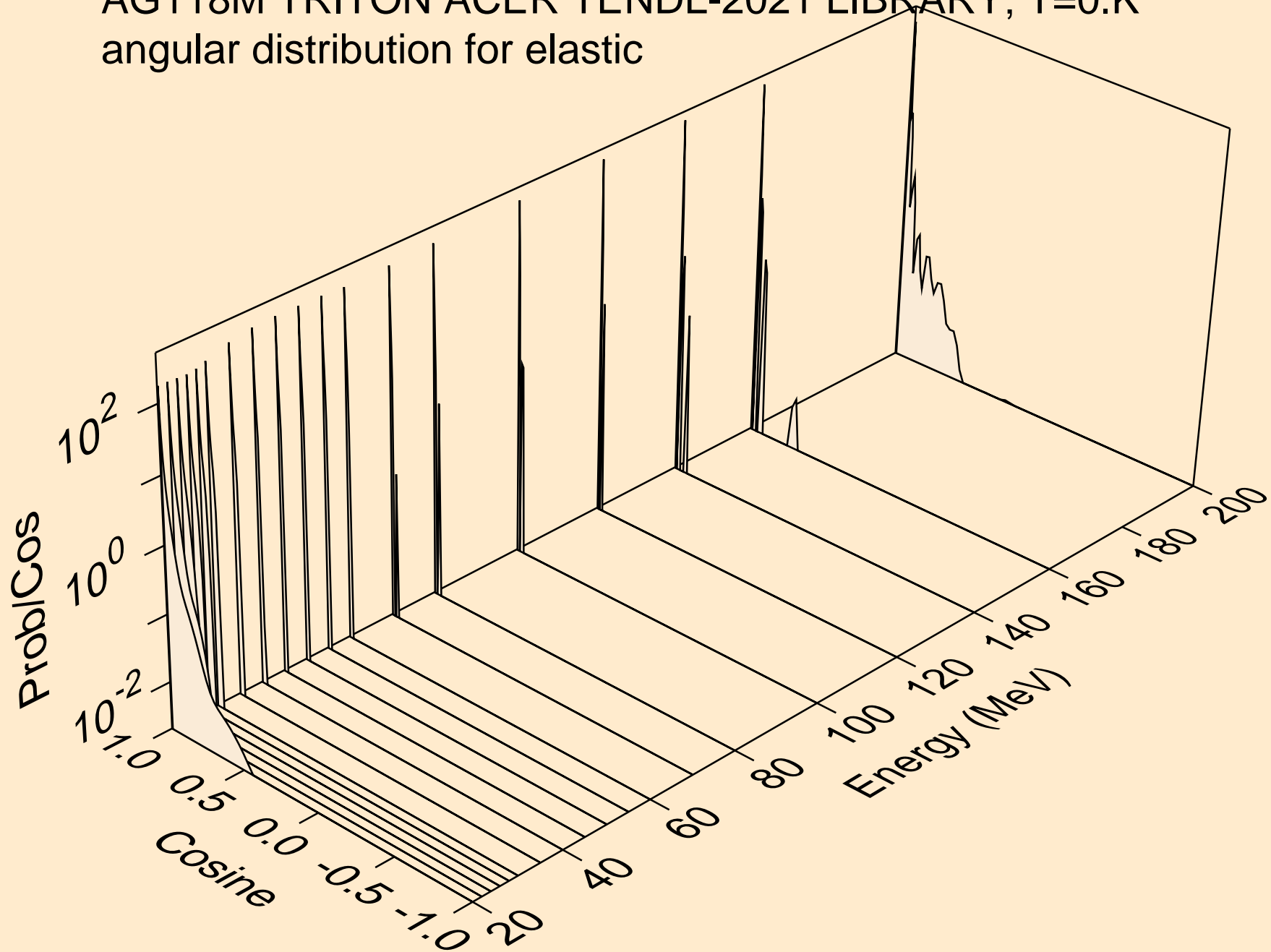

AG118M TRITON ACER TENDL-2021 LIBRARY; T=0.K  
Triton emission for (t,x)

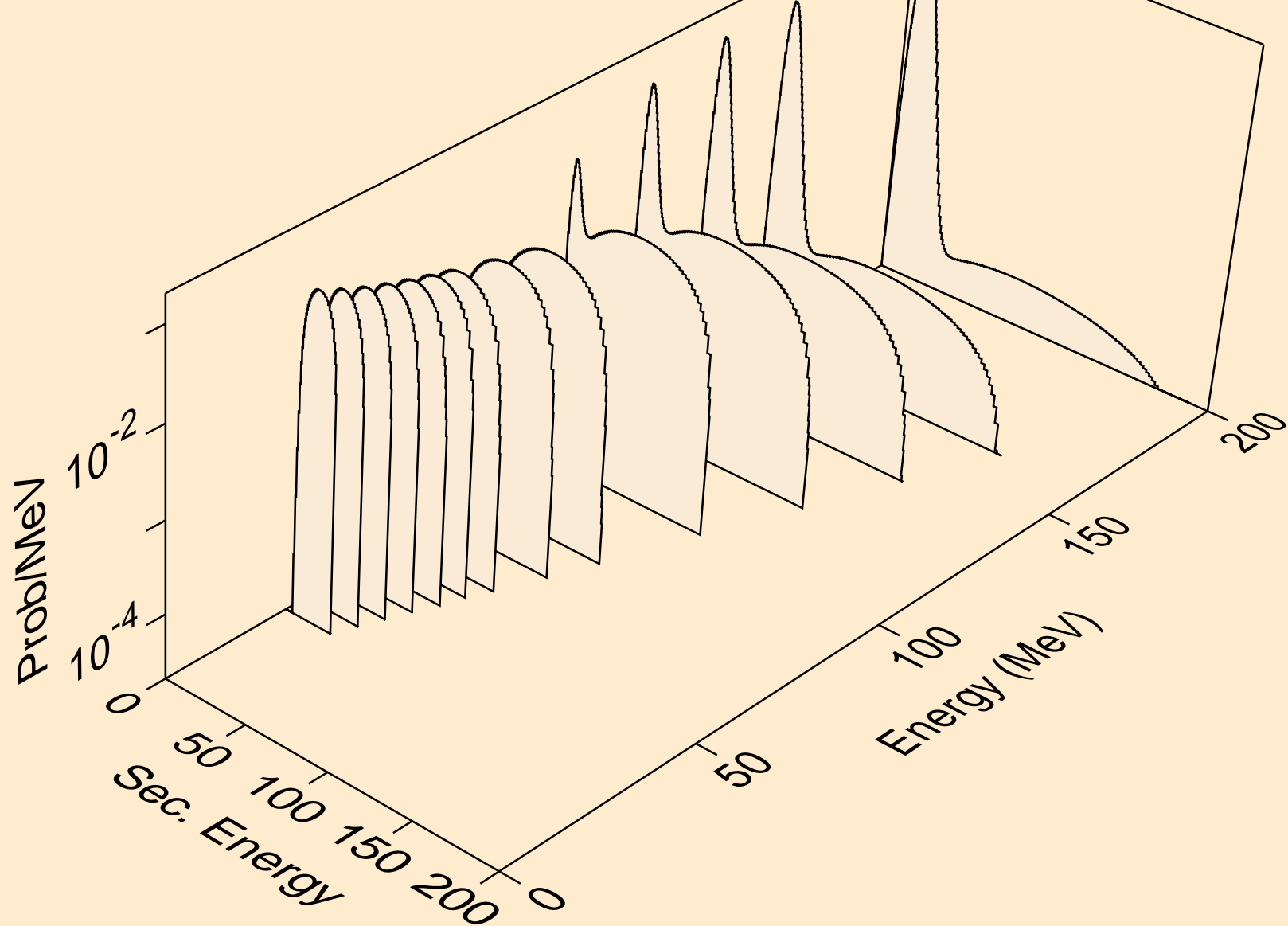

AG118M TRITON ACER TENDL-2021 LIBRARY; T=0.K  
Triton emission for (t,n\*)t

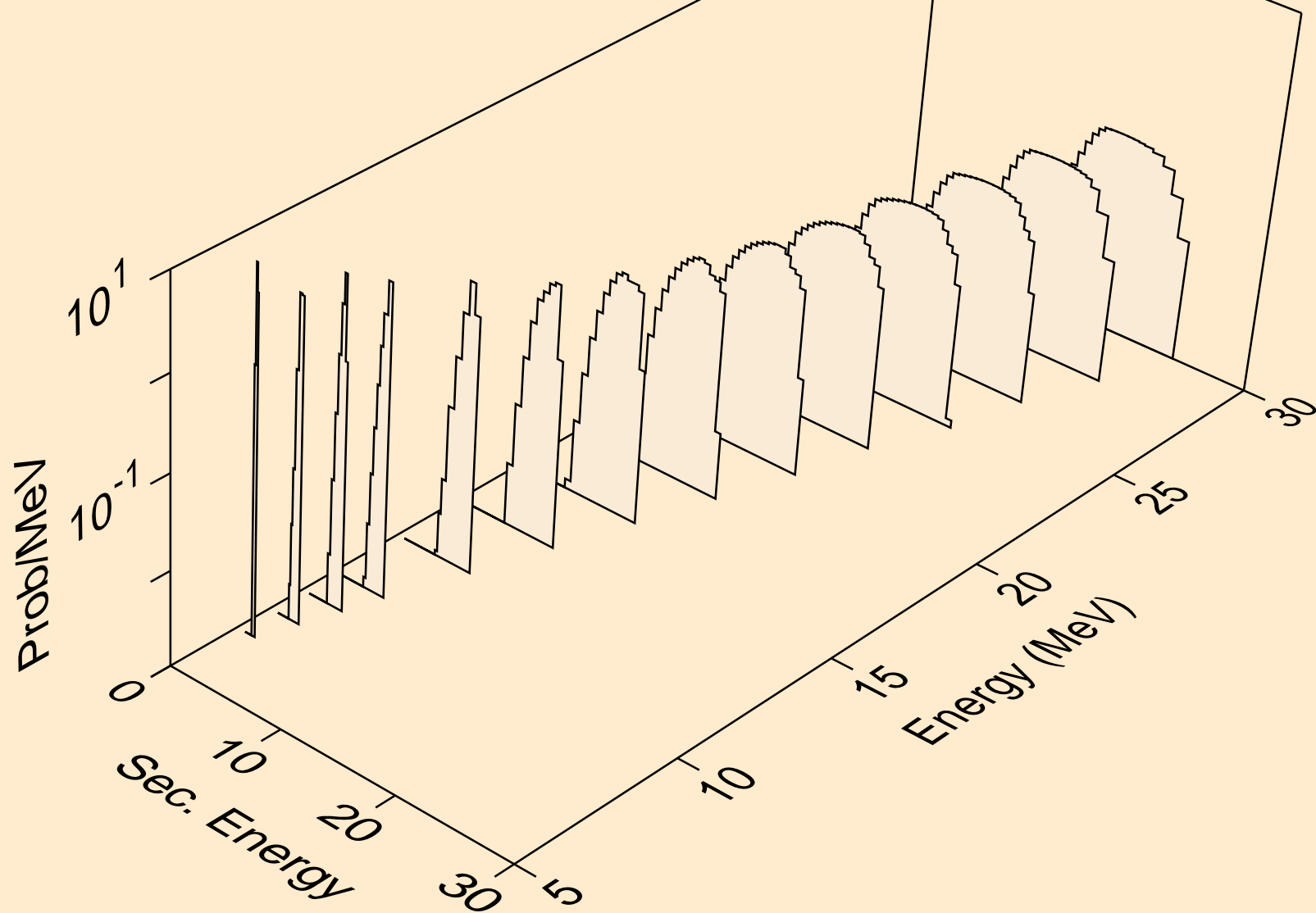

AG118M TRITON ACER TENDL-2021 LIBRARY; T=0.K  
Triton emission for inelastic

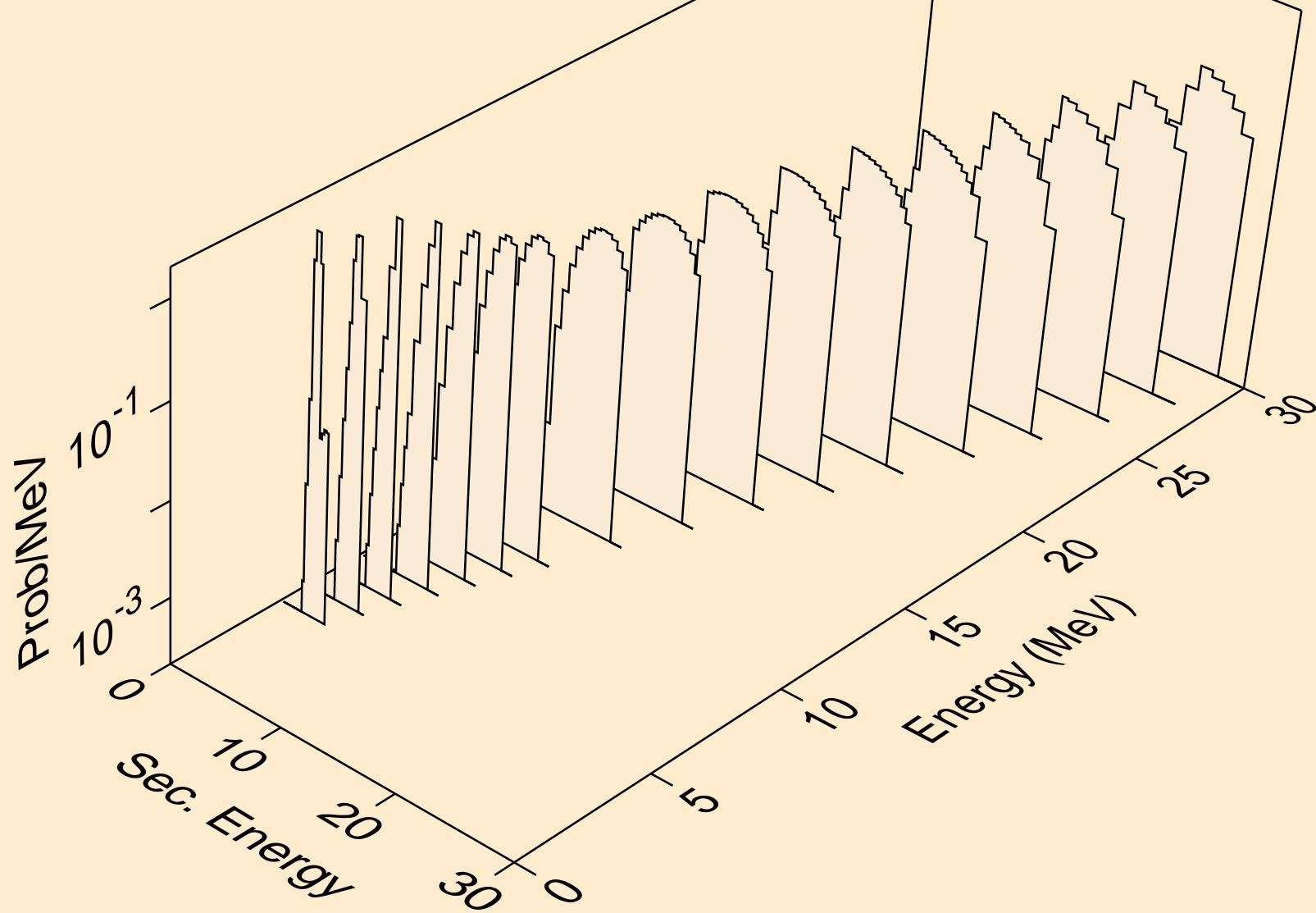

AG118M TRITON ACER TENDL-2021 LIBRARY; T=0.K  
Triton emission for (t,pt)

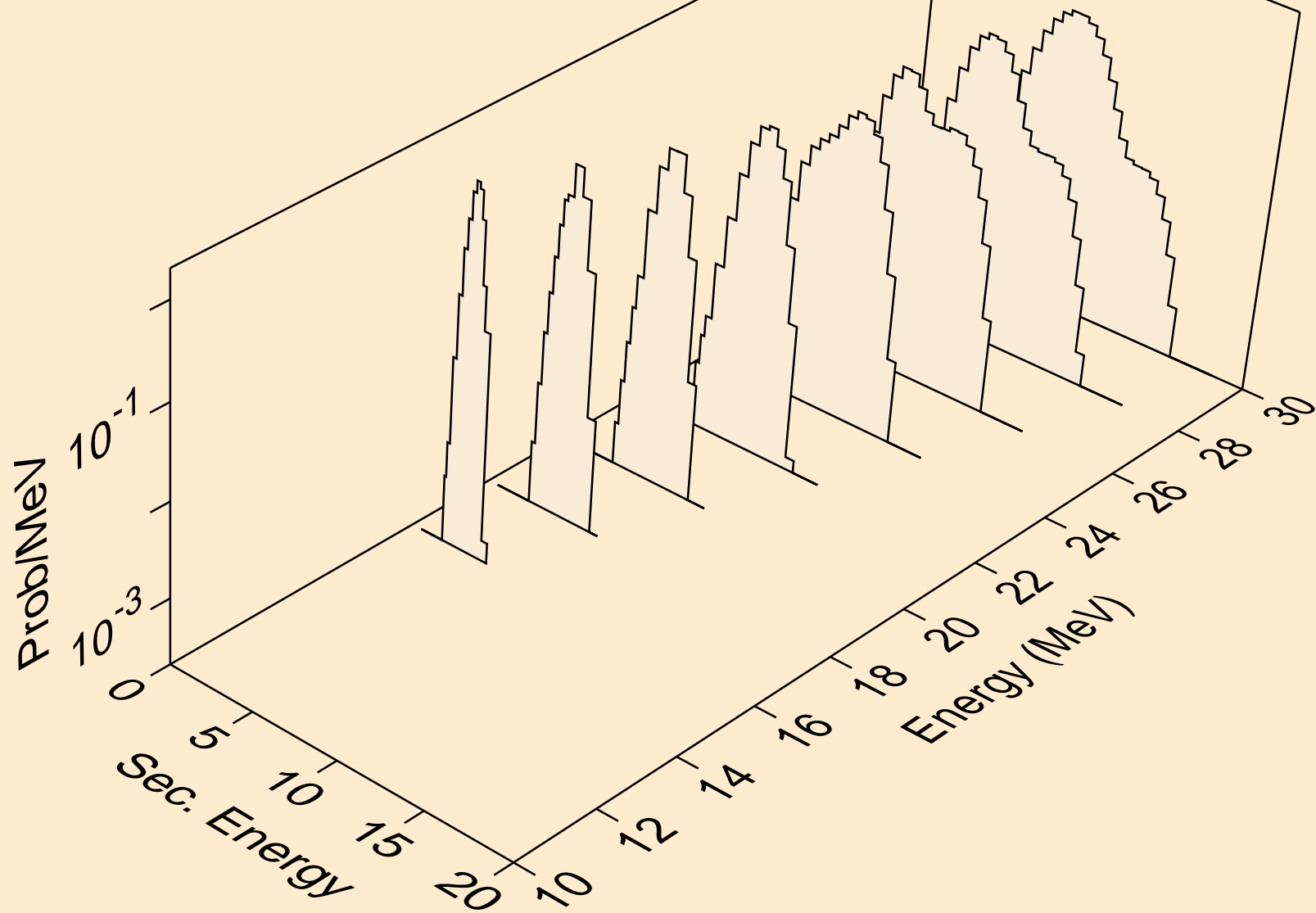

AG118M TRITON ACER TENDL-2021 LIBRARY; T=0.K  
Photon emission for (z,n)

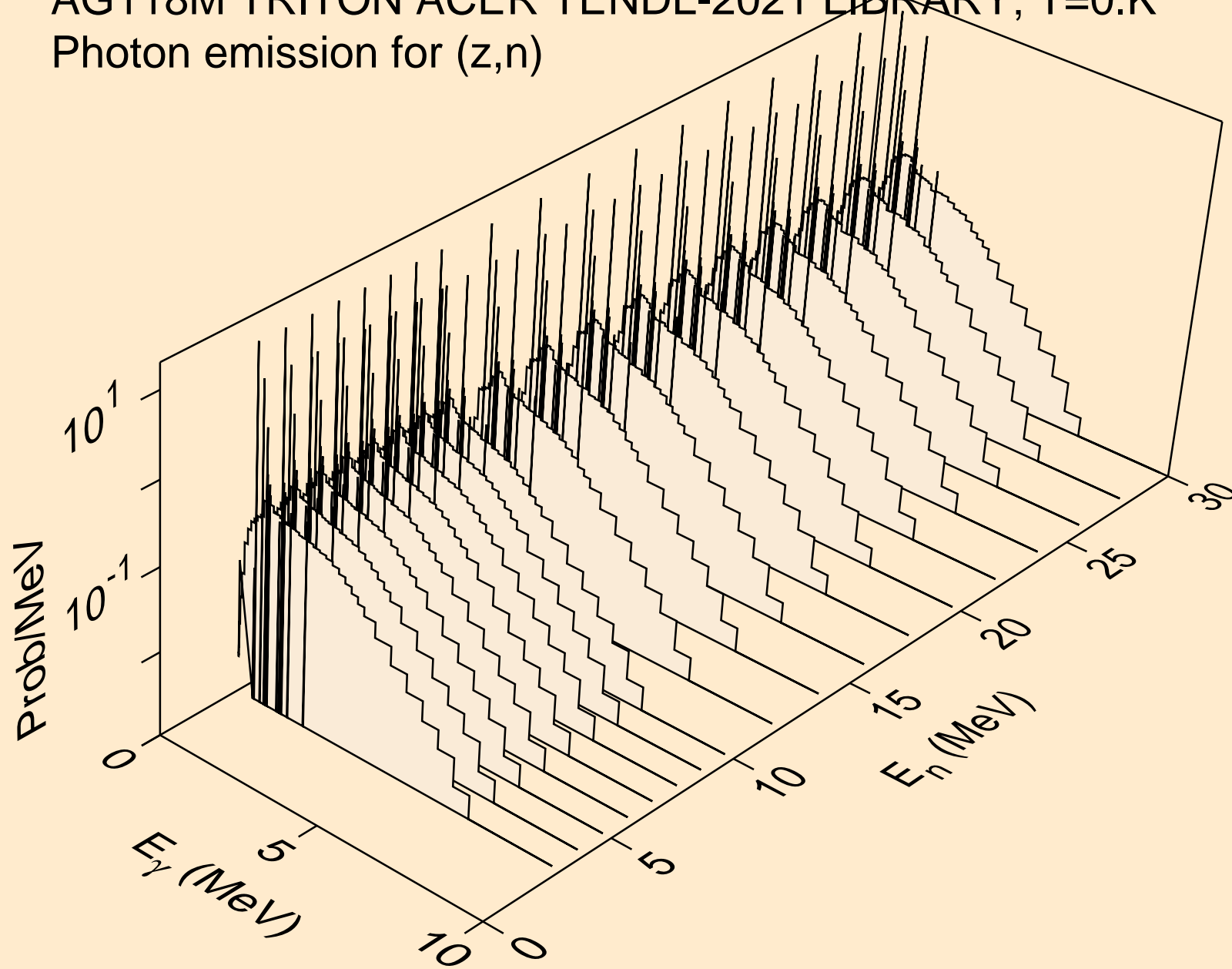

AG118M TRITON ACER TENDL-2021 LIBRARY; T=0.K  
Photon emission for (n,x)

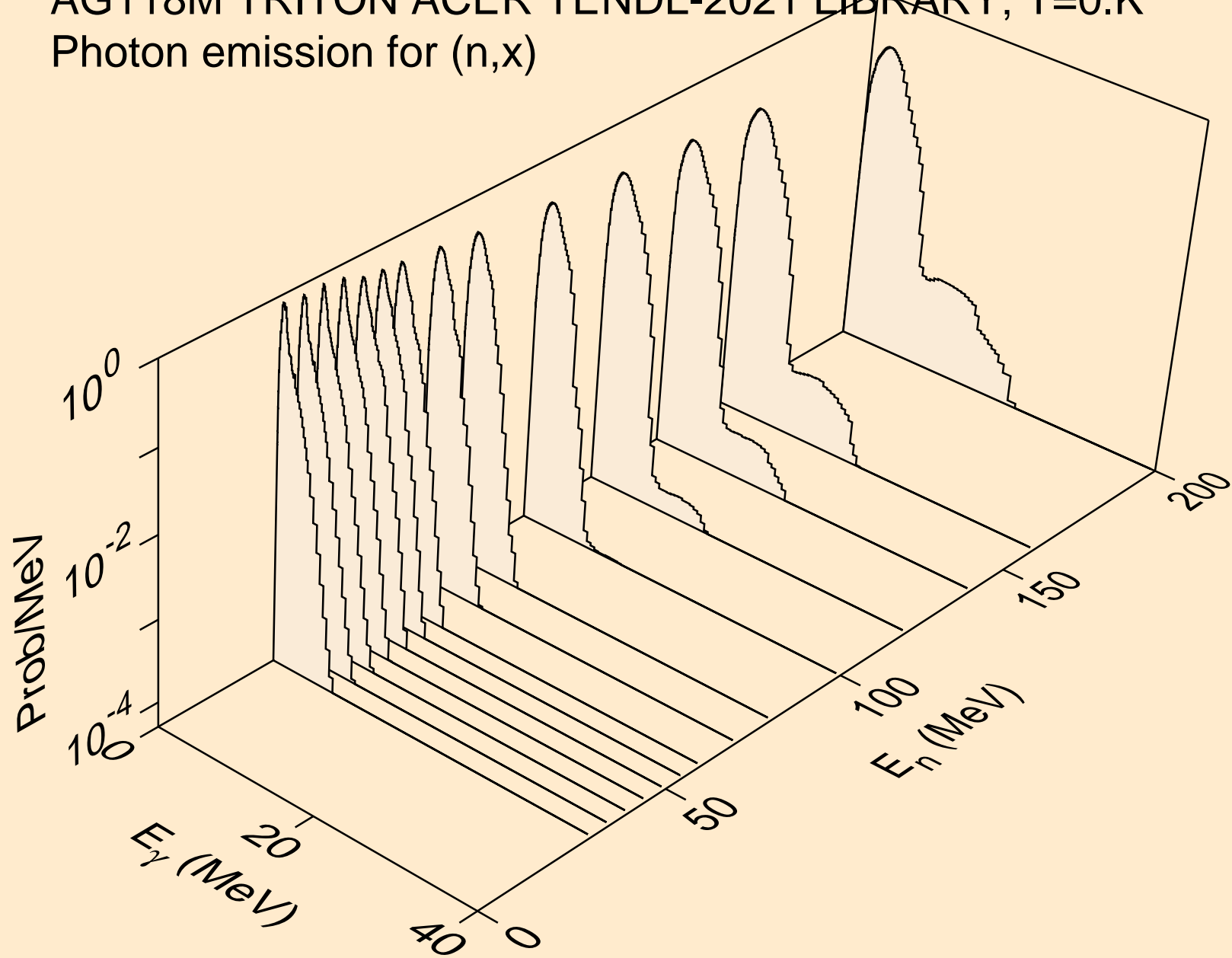

AG118M TRITON ACER TENDL-2021 LIBRARY; T=0.K  
Photon emission for (n,2nd)

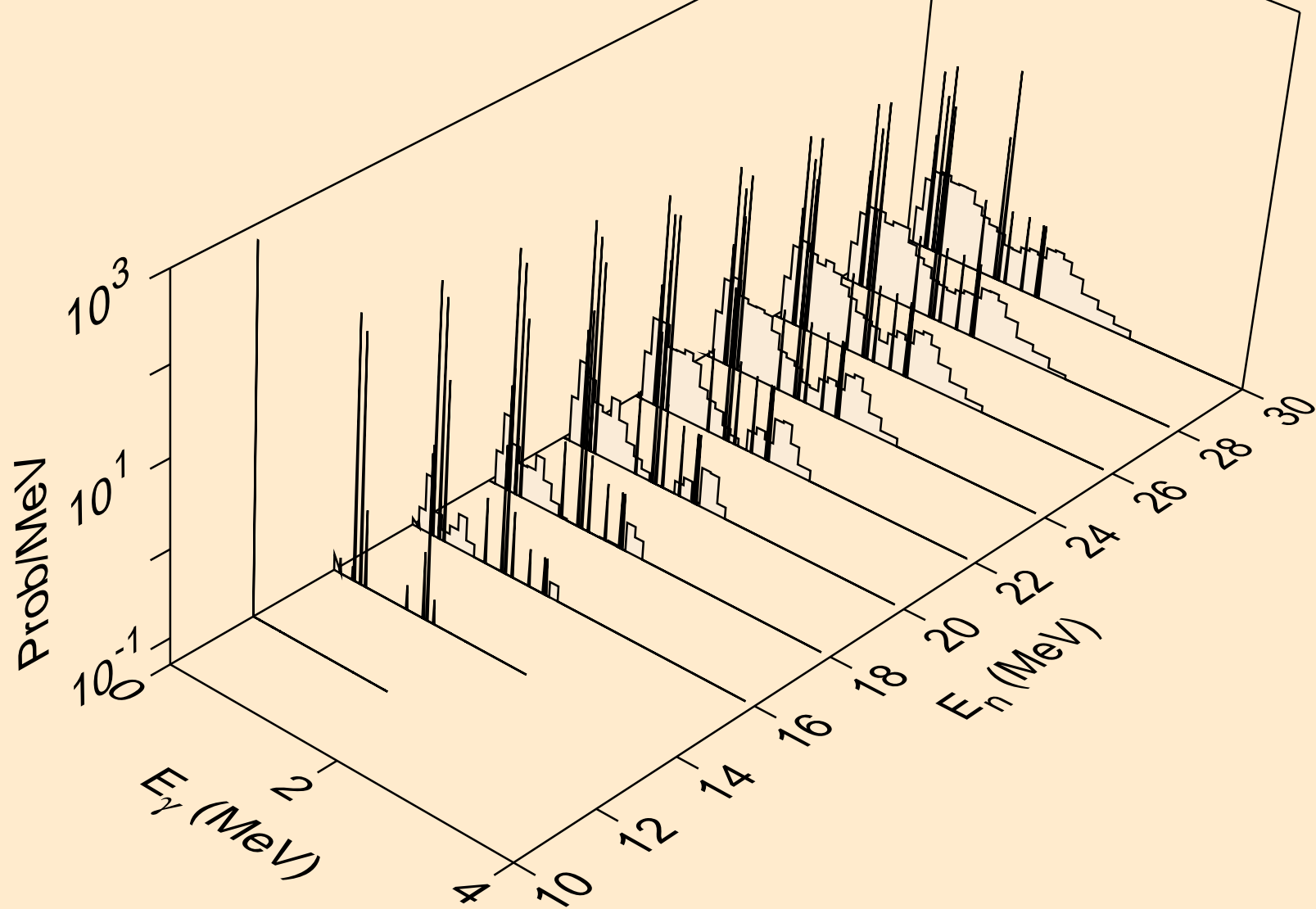



AG118M TRITON ACER TENDL-2021 LIBRARY; T=0.K  
Photon emission for (n,2n)

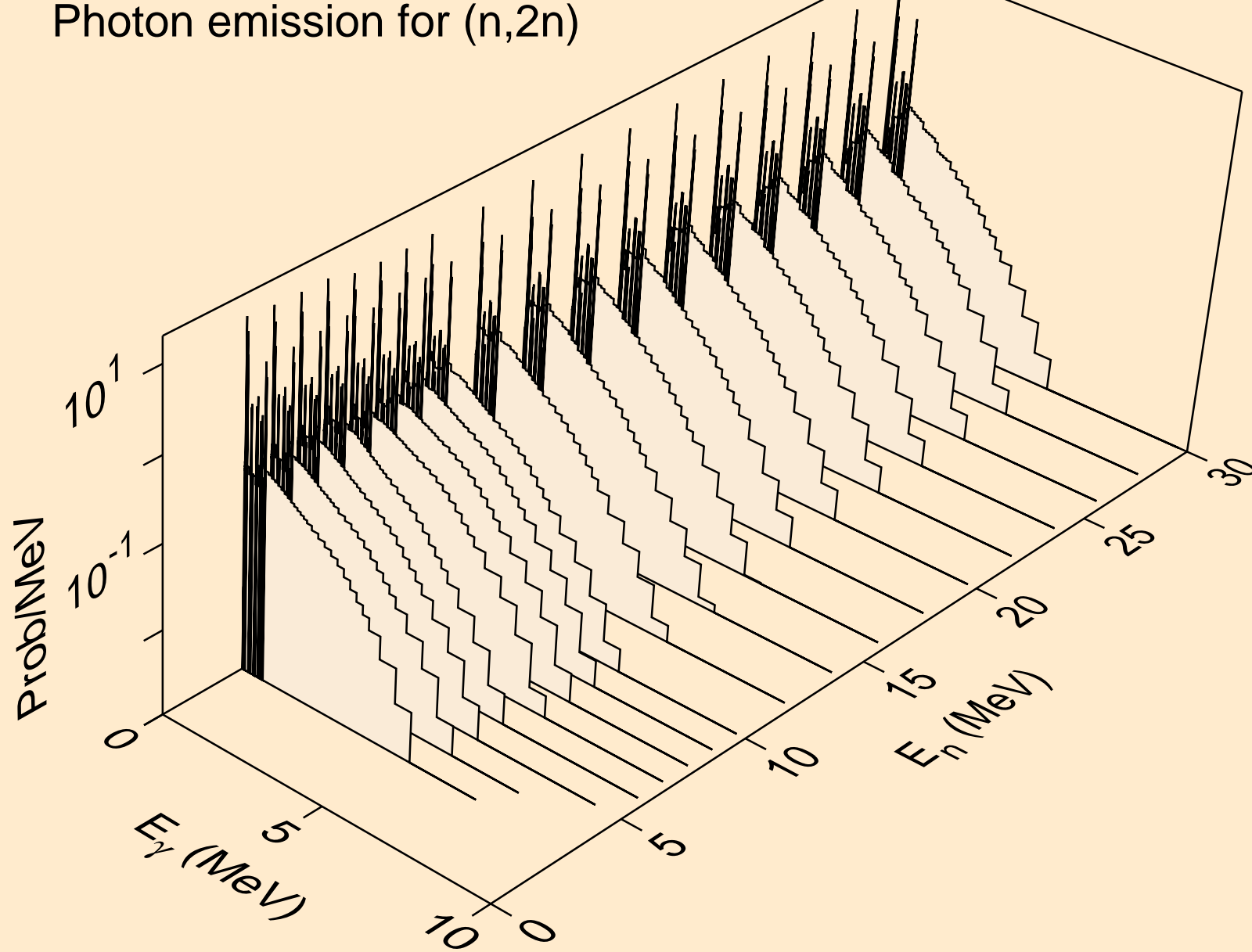

AG118M TRITON ACER TENDL-2021 LIBRARY; T=0.K  
Photon emission for (n,3n)

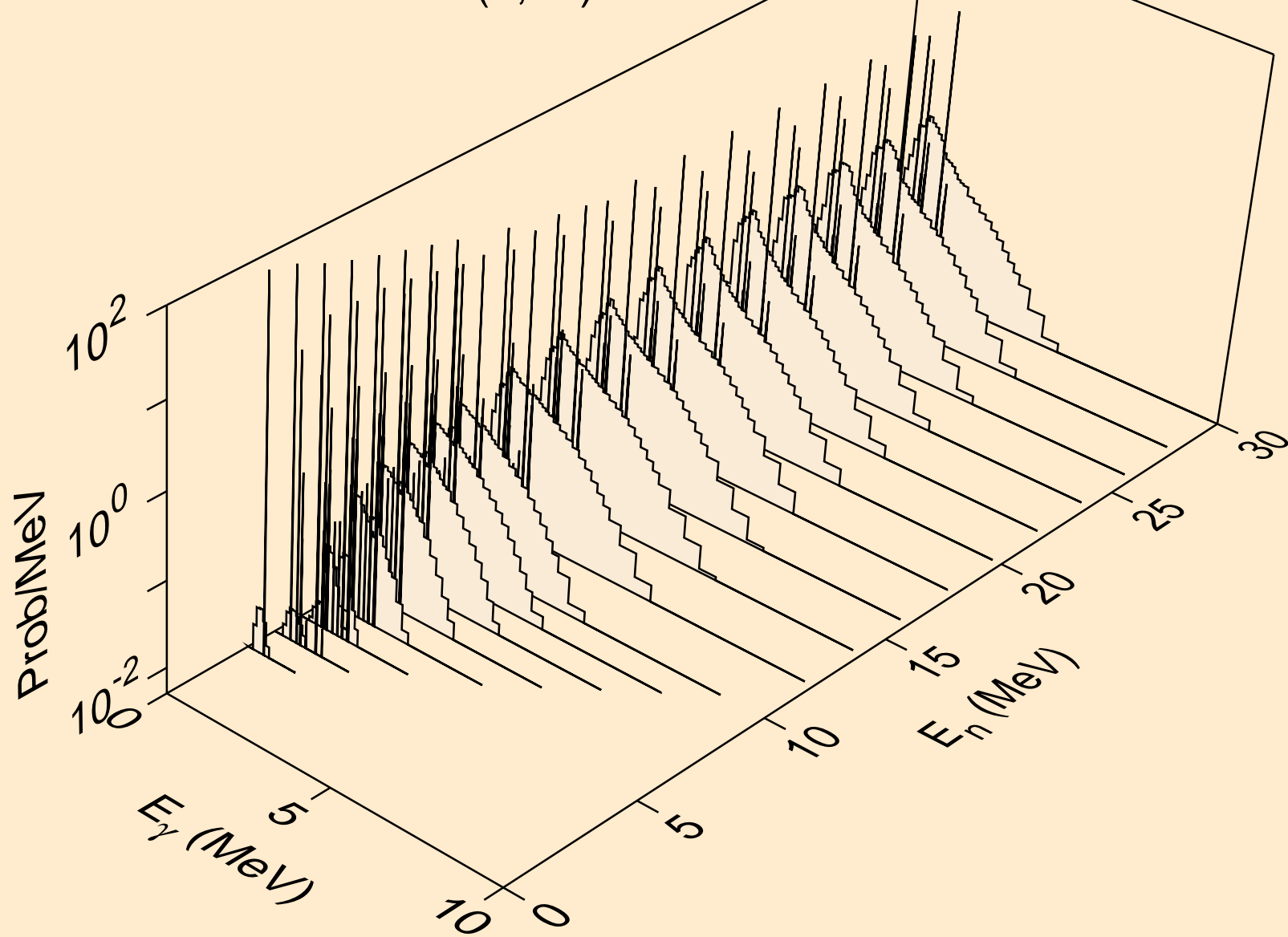

AG118M TRITON ACER TENDL-2021 LIBRARY; T=0.K  
Photon emission for (n,n\*)a

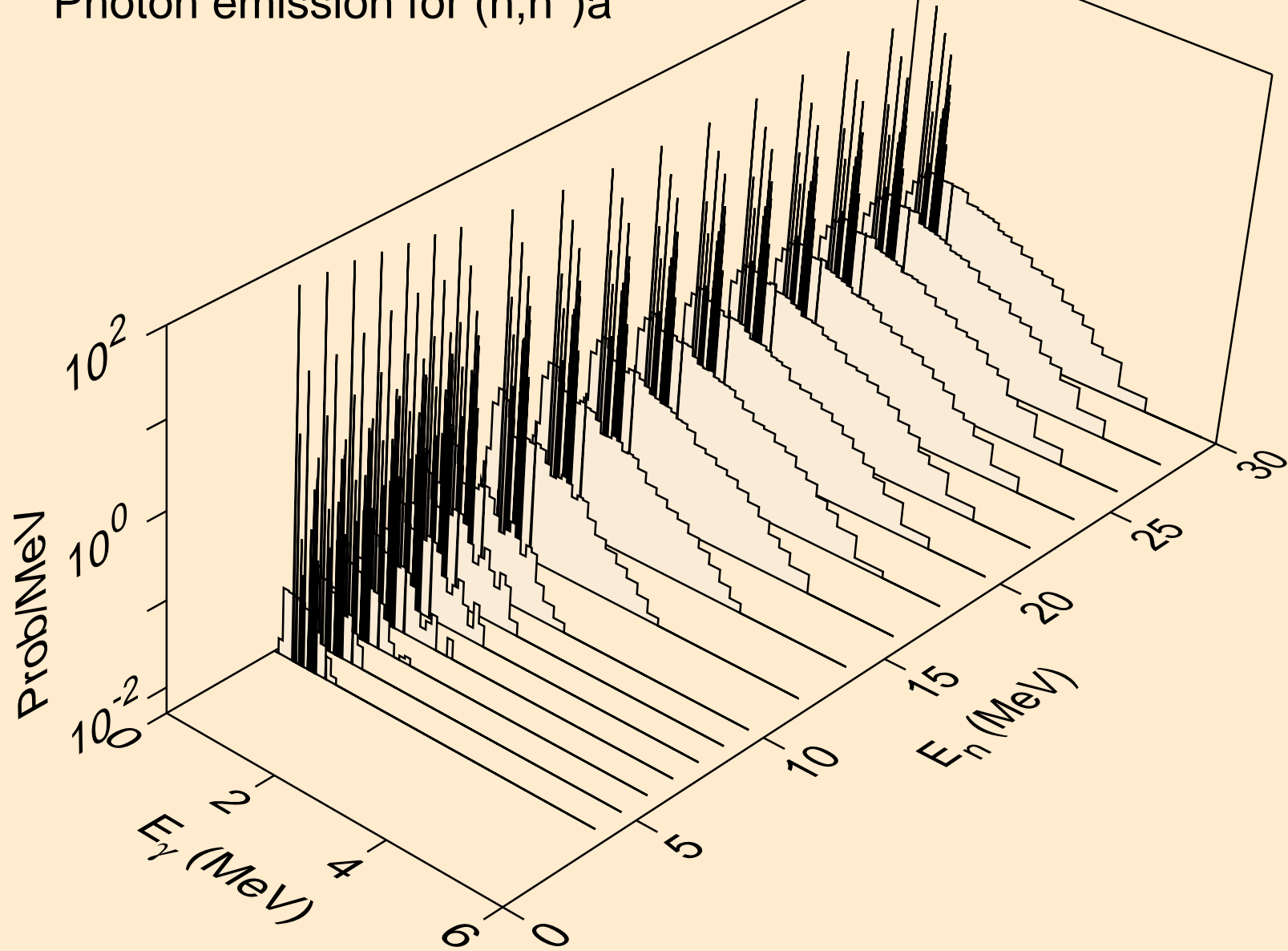

AG118M TRITON ACER TENDL-2021 LIBRARY; T=0.K  
Photon emission for (n,2n)a

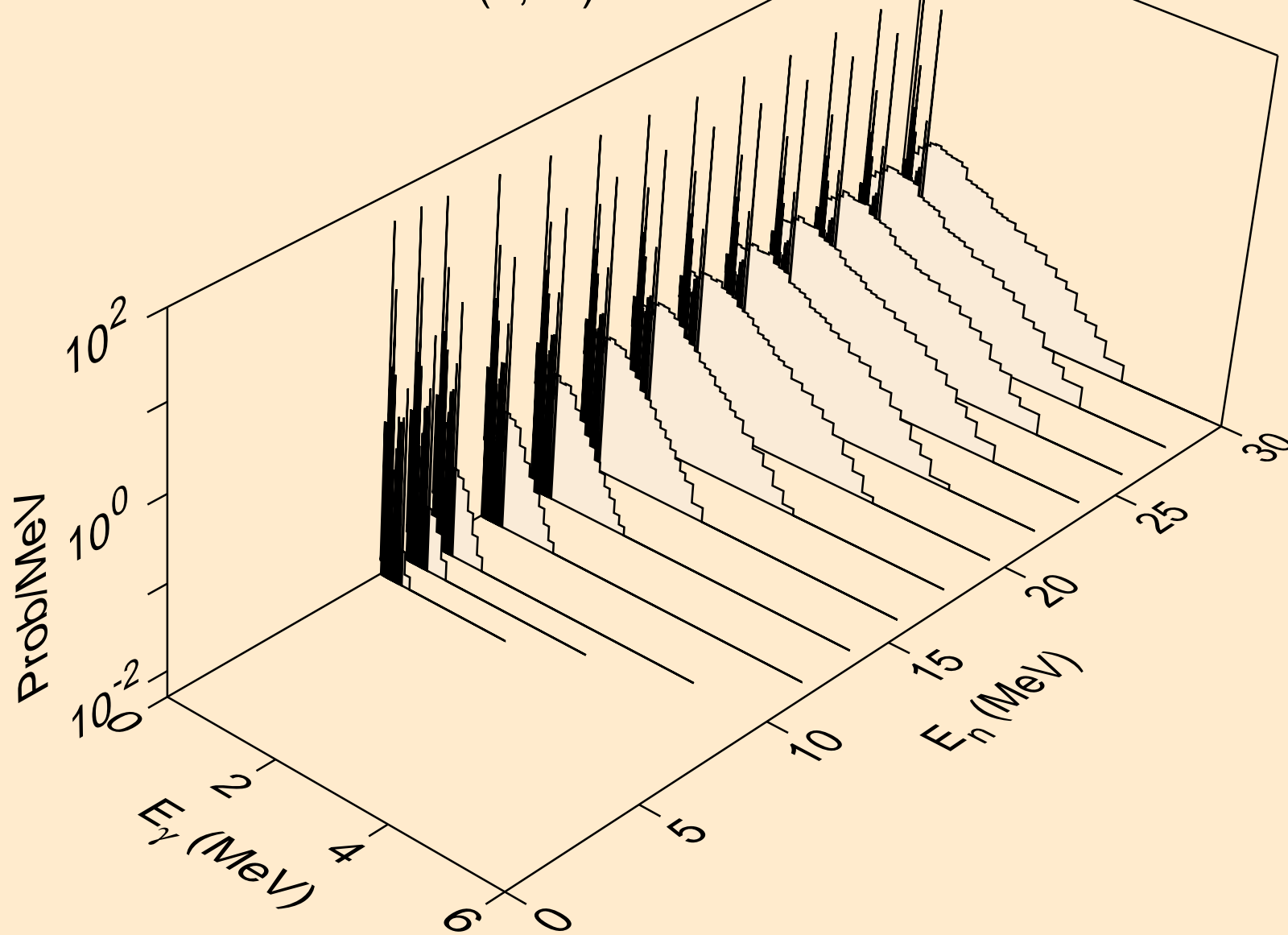

AG118M TRITON ACER TENDL-2021 LIBRARY; T=0.K  
Photon emission for (n,3n)a

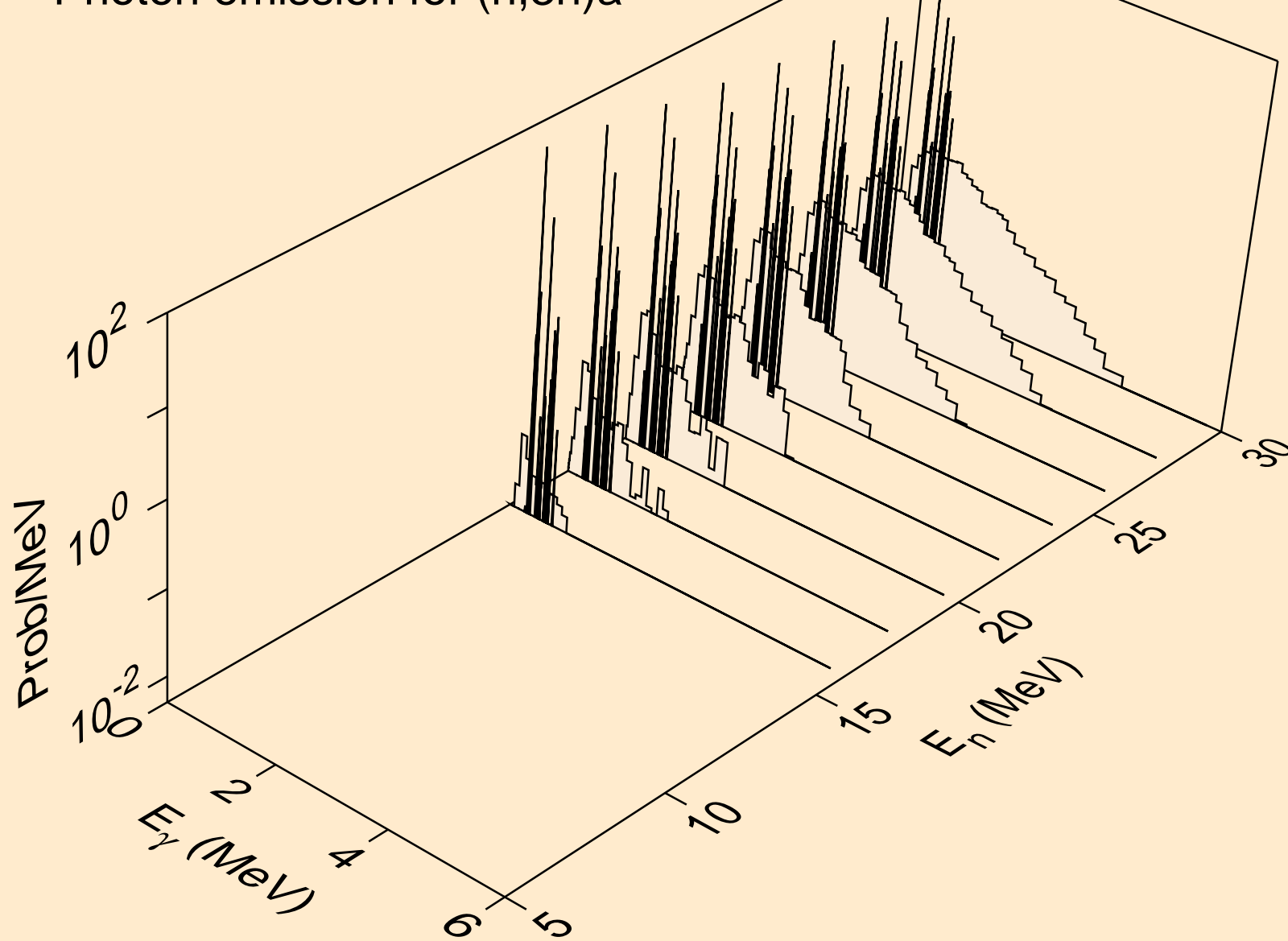

AG118M TRITON ACER TENDL-2021 LIBRARY; T=0.K  
Photon emission for (n,n\*)p

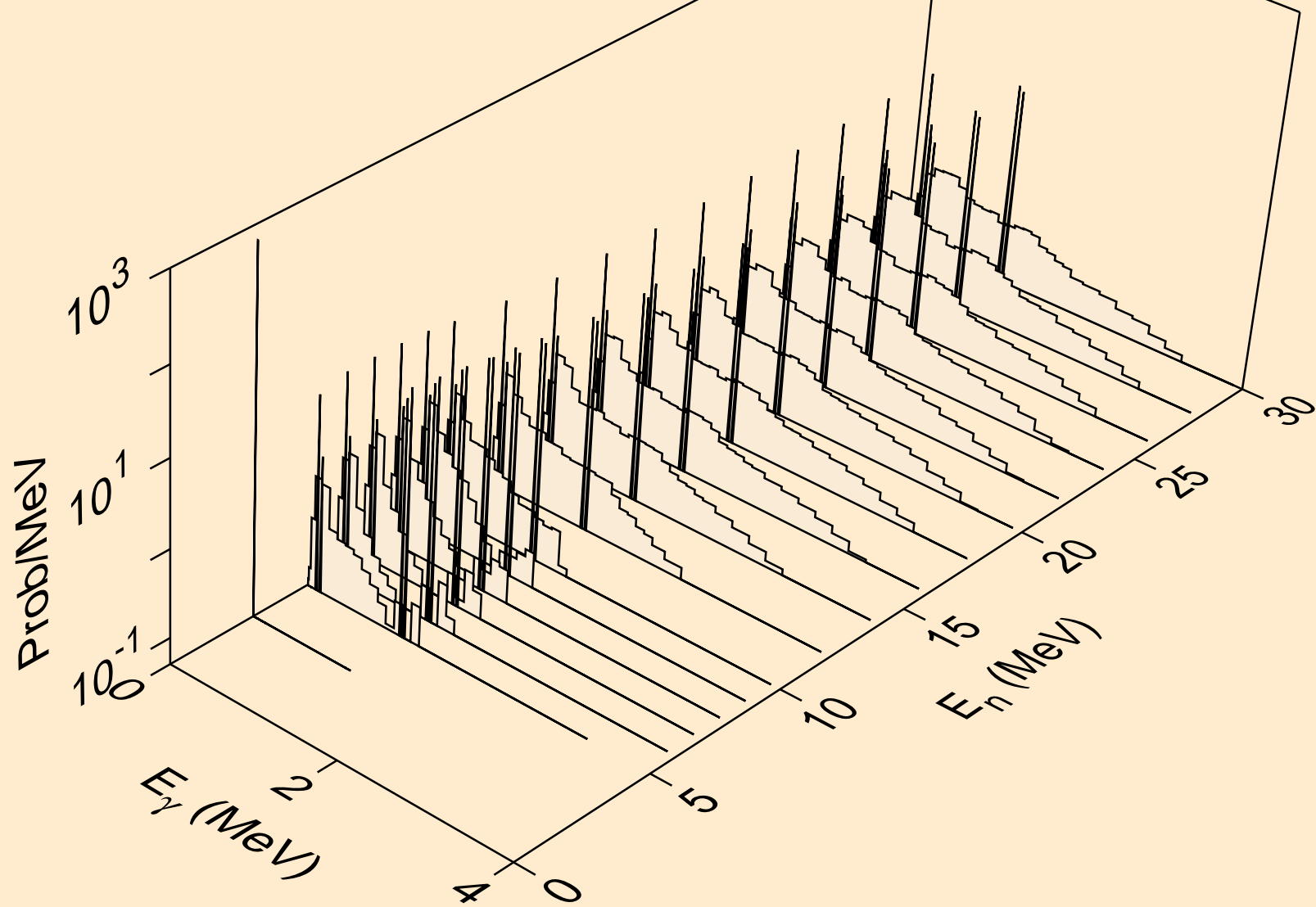

AG118M TRITON ACER TENDL-2021 LIBRARY; T=0.K  
Photon emission for (n,n\*)2a

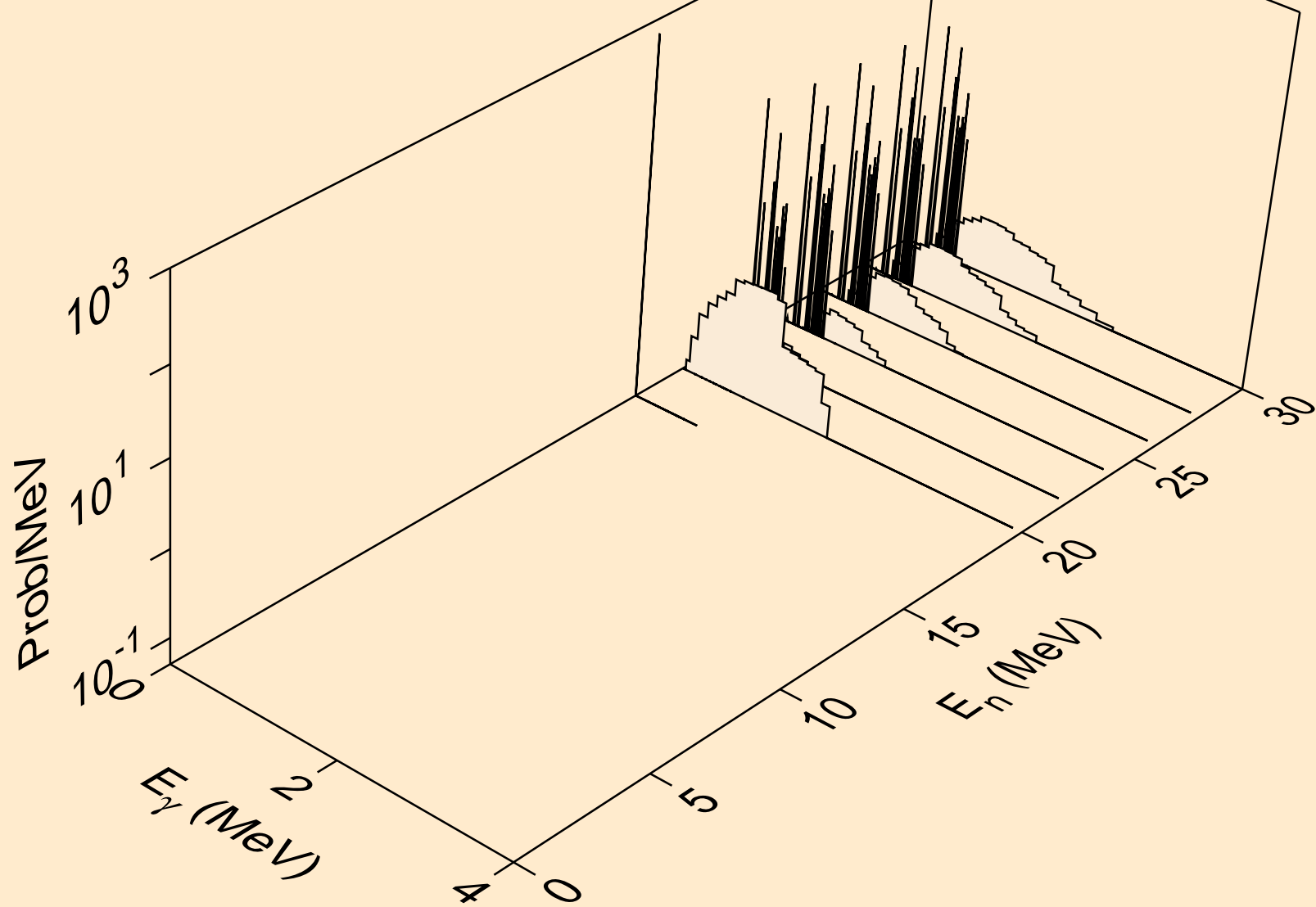

AG118M TRITON ACER TENDL-2021 LIBRARY; T=0.K  
Photon emission for (n,n\*)d

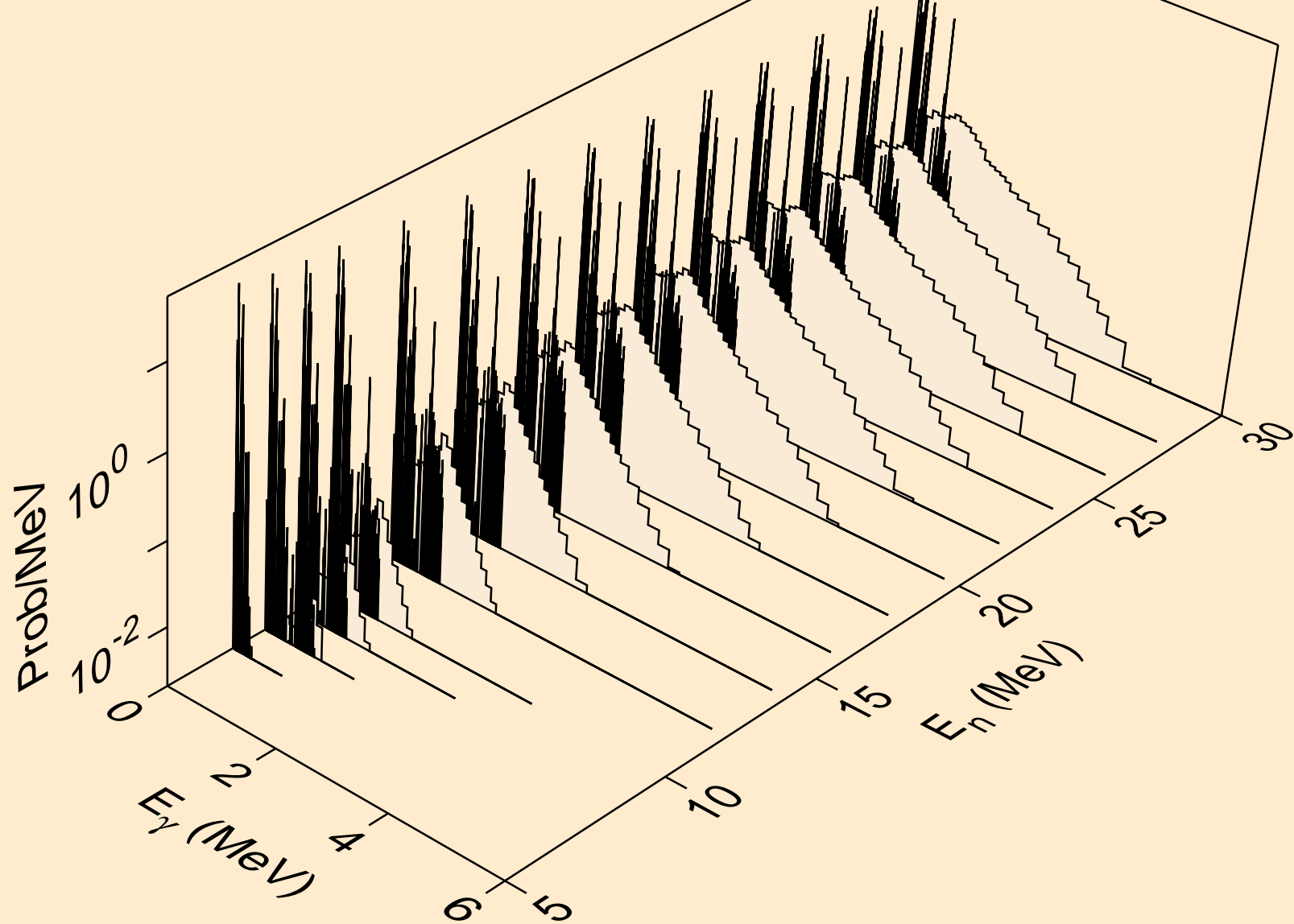



AG118M TRITON ACER TENDL-2021 LIBRARY; T=0.K  
Photon emission for (n,n\*)t

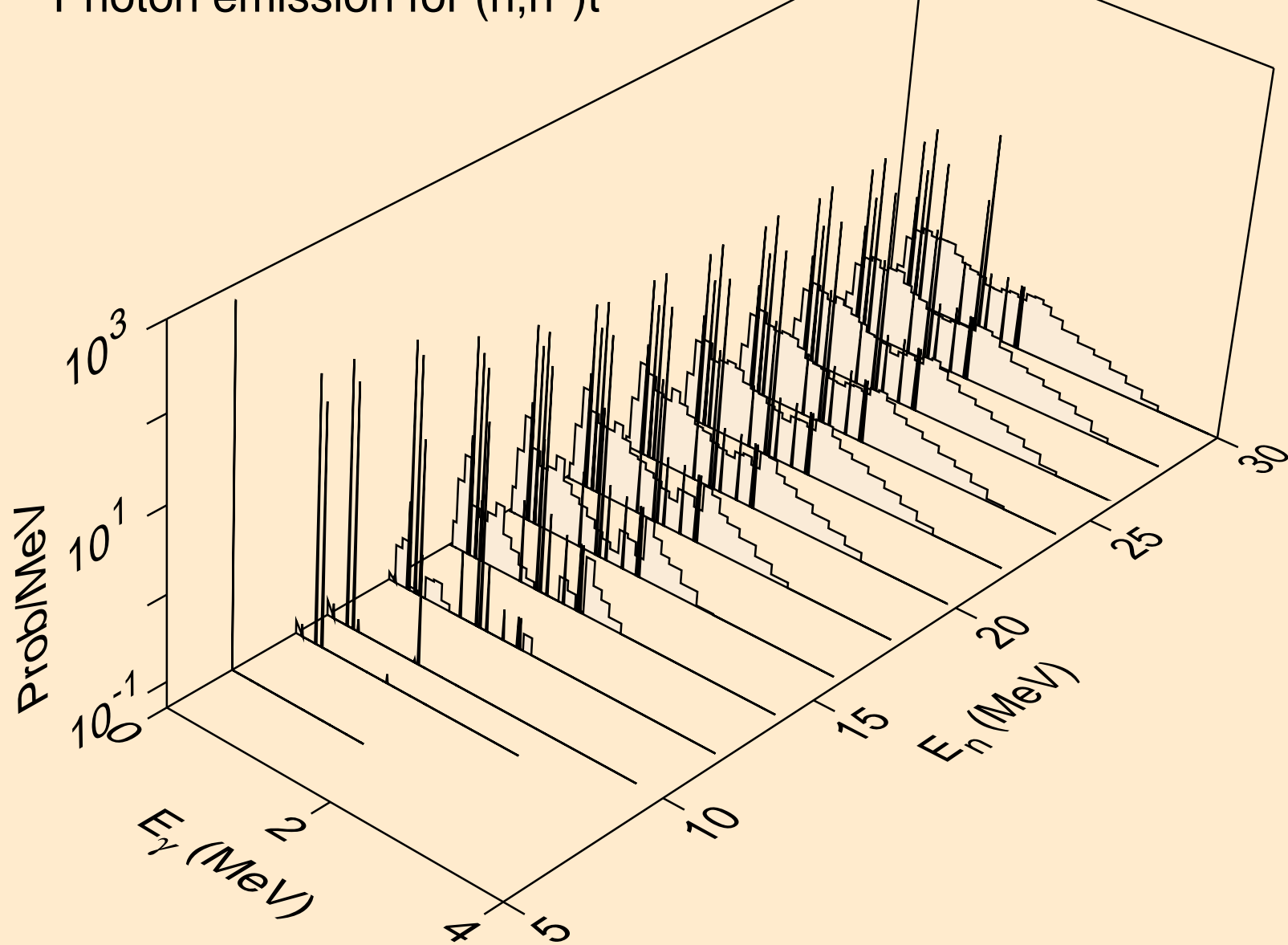

AG118M TRITON ACER TENDL-2021 LIBRARY; T=0.K  
Photon emission for (n,n\*)he3

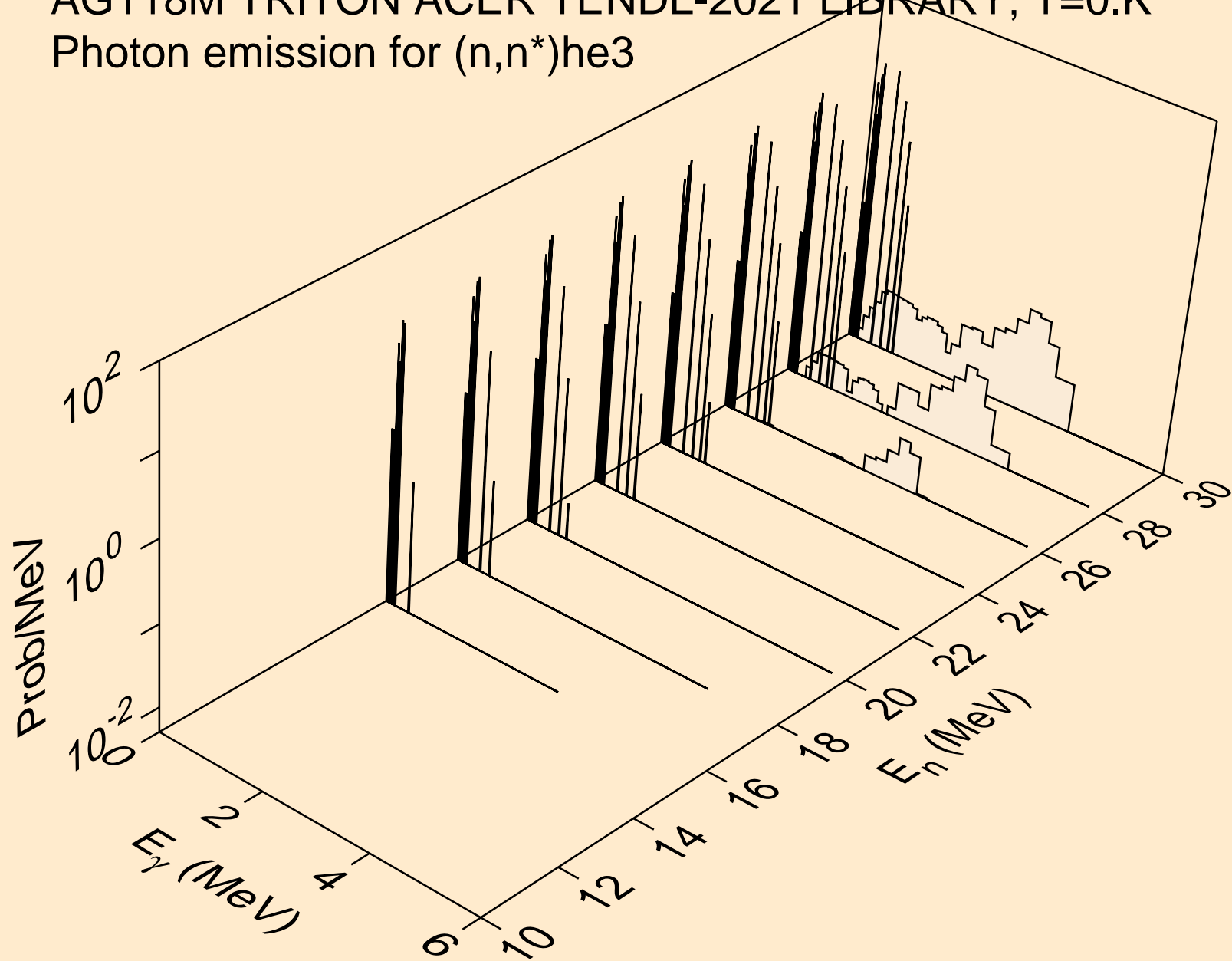

AG118M TRITON ACER TENDL-2021 LIBRARY; T=0.K  
Photon emission for (n,4n)

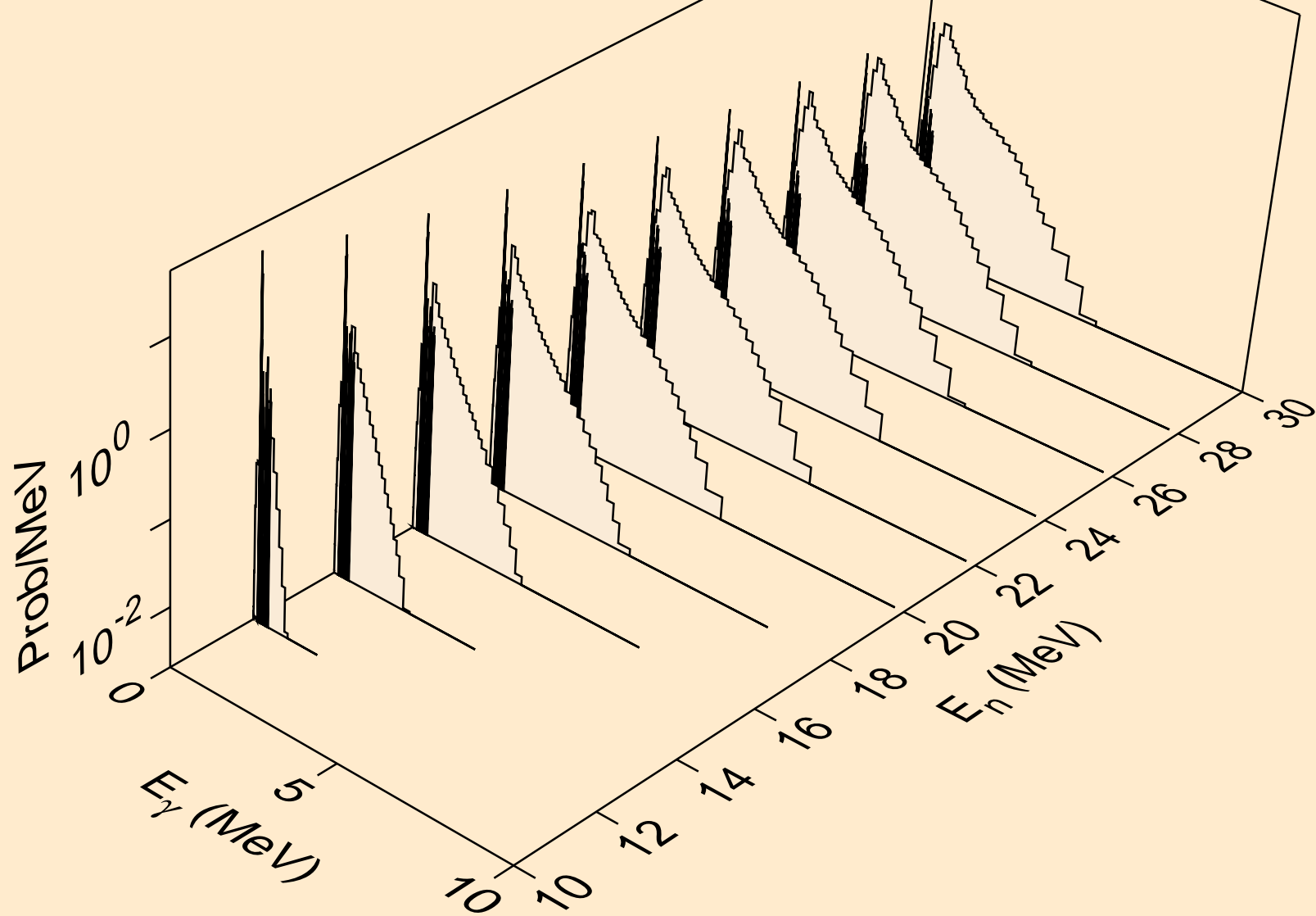

AG118M TRITON ACER TENDL-2021 LIBRARY; T=0.K  
Photon emission for (n,2np)

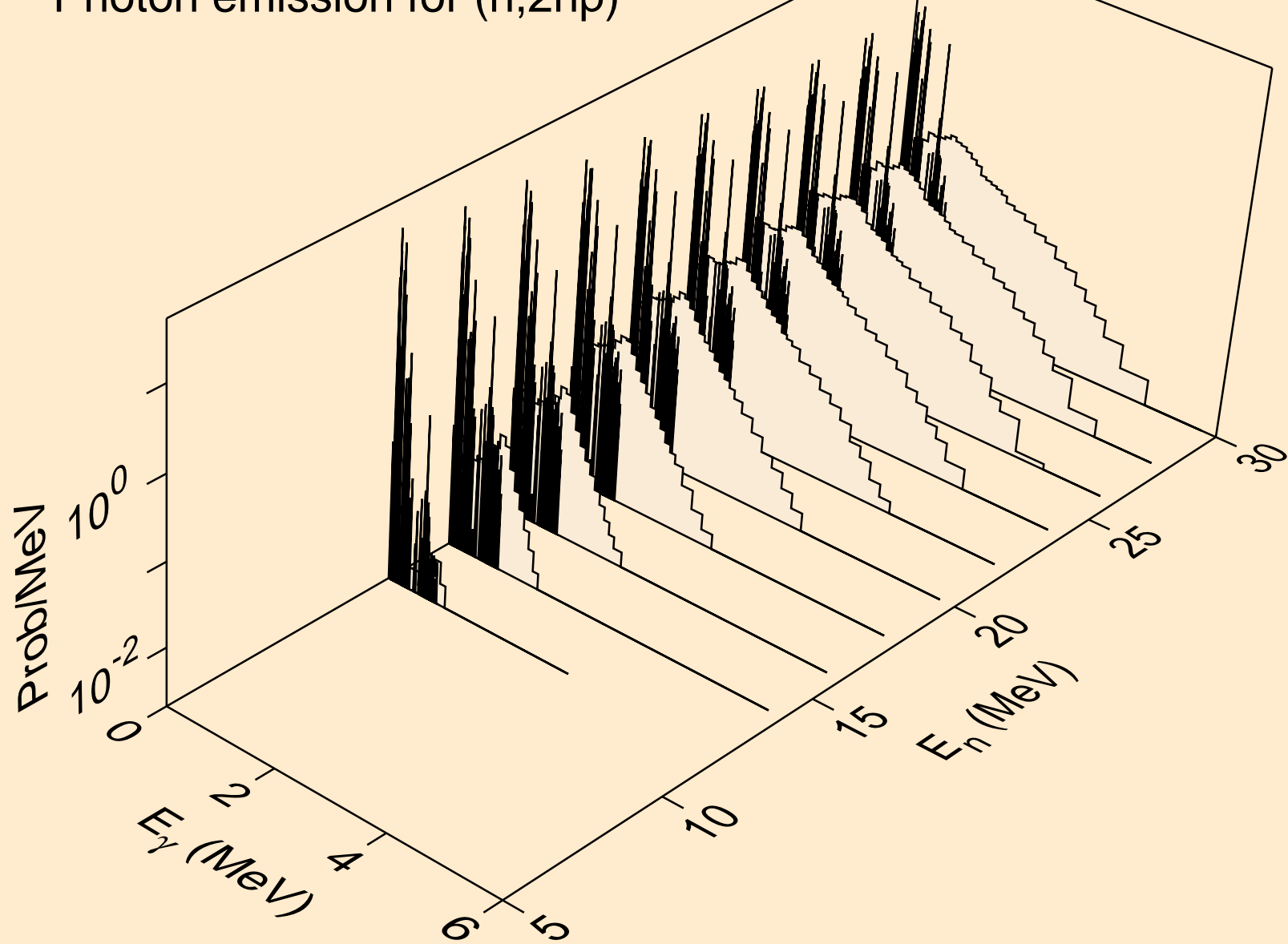

AG118M TRITON ACER TENDL-2021 LIBRARY; T=0.K  
Photon emission for (n,3np)

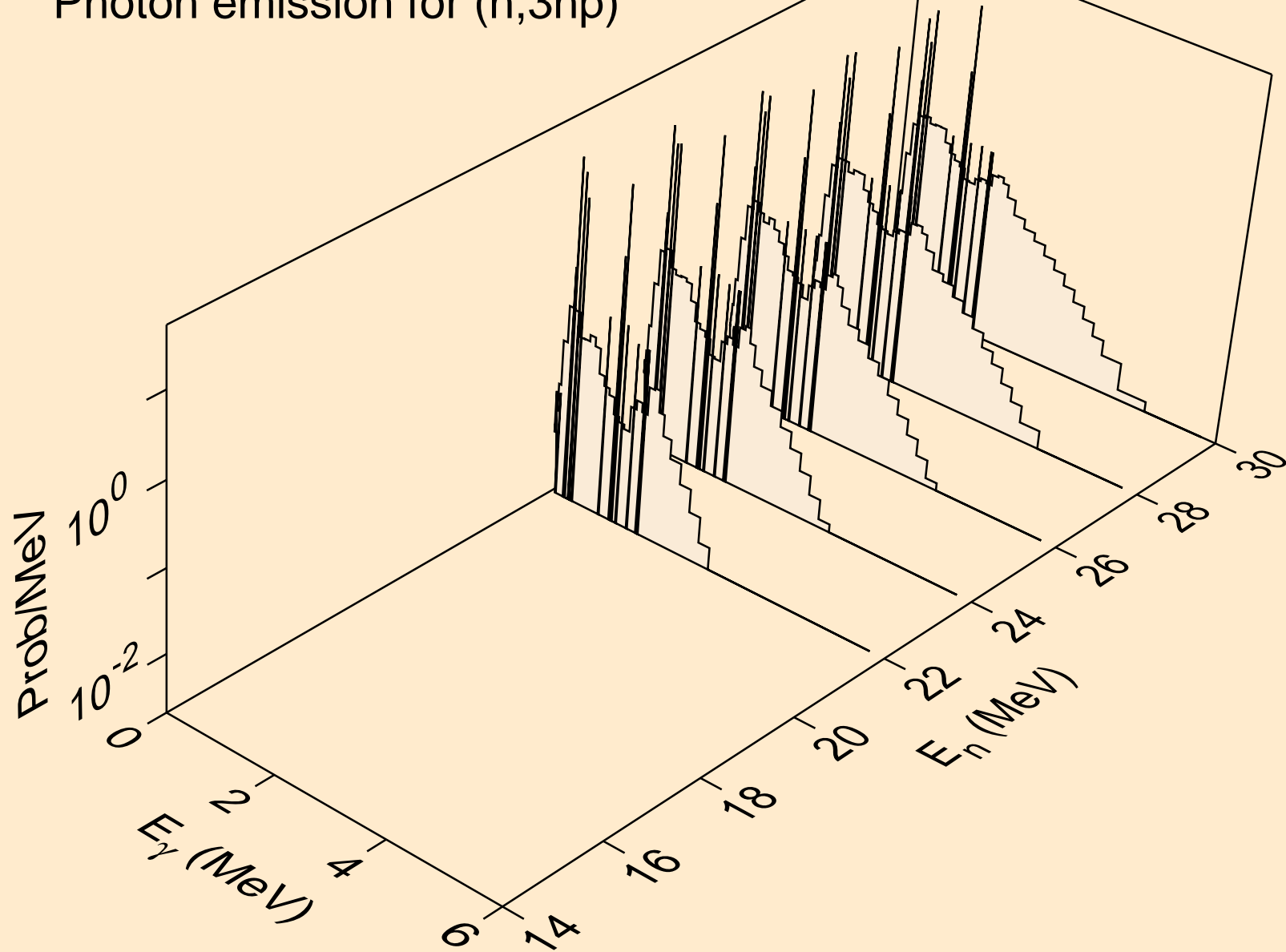

AG118M TRITON ACER TENDL-2021 LIBRARY; T=0.K  
Photon emission for (n,2np)

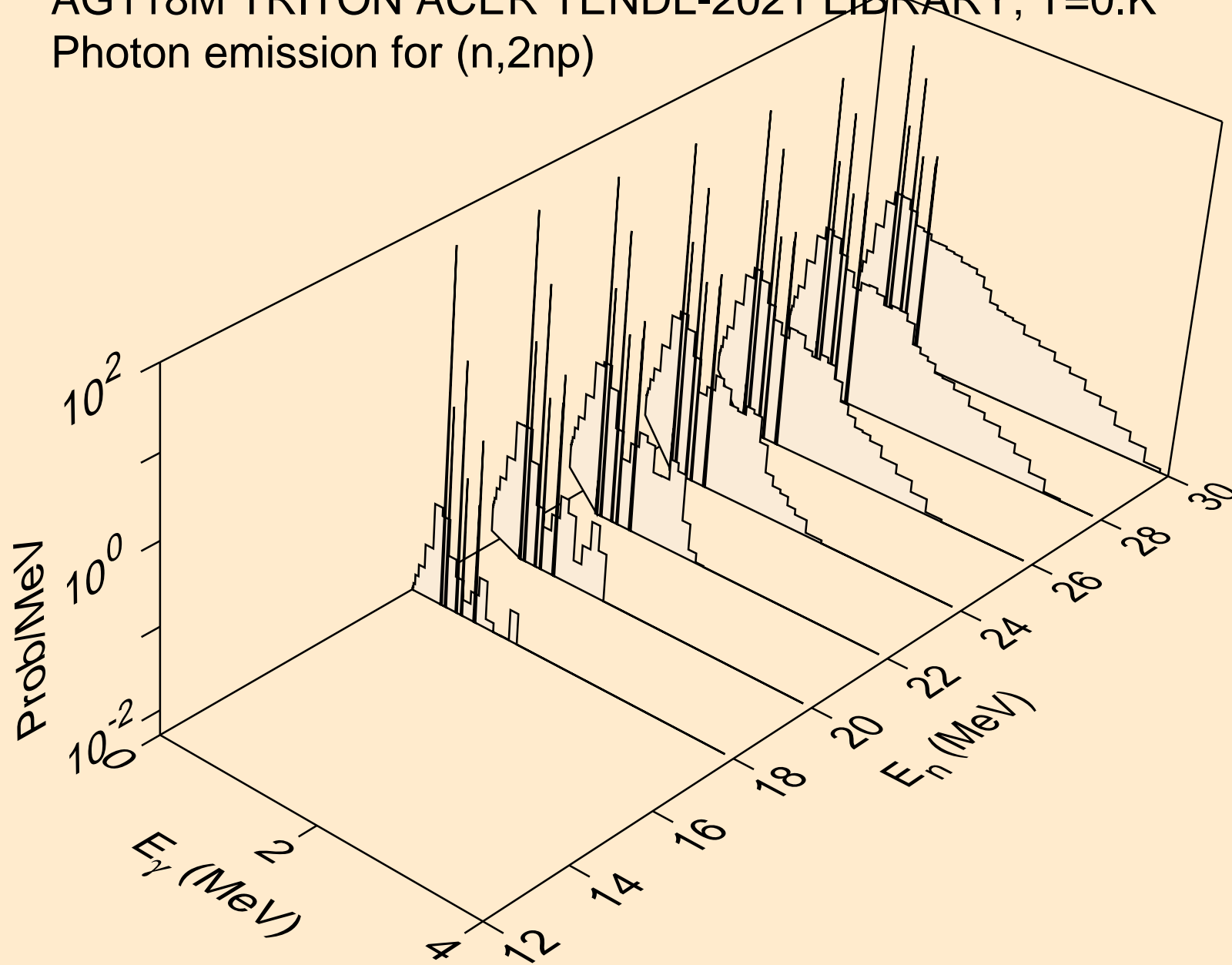

AG118M TRITON ACER TENDL-2021 LIBRARY; T=0.K  
Photon emission for (n,npa)

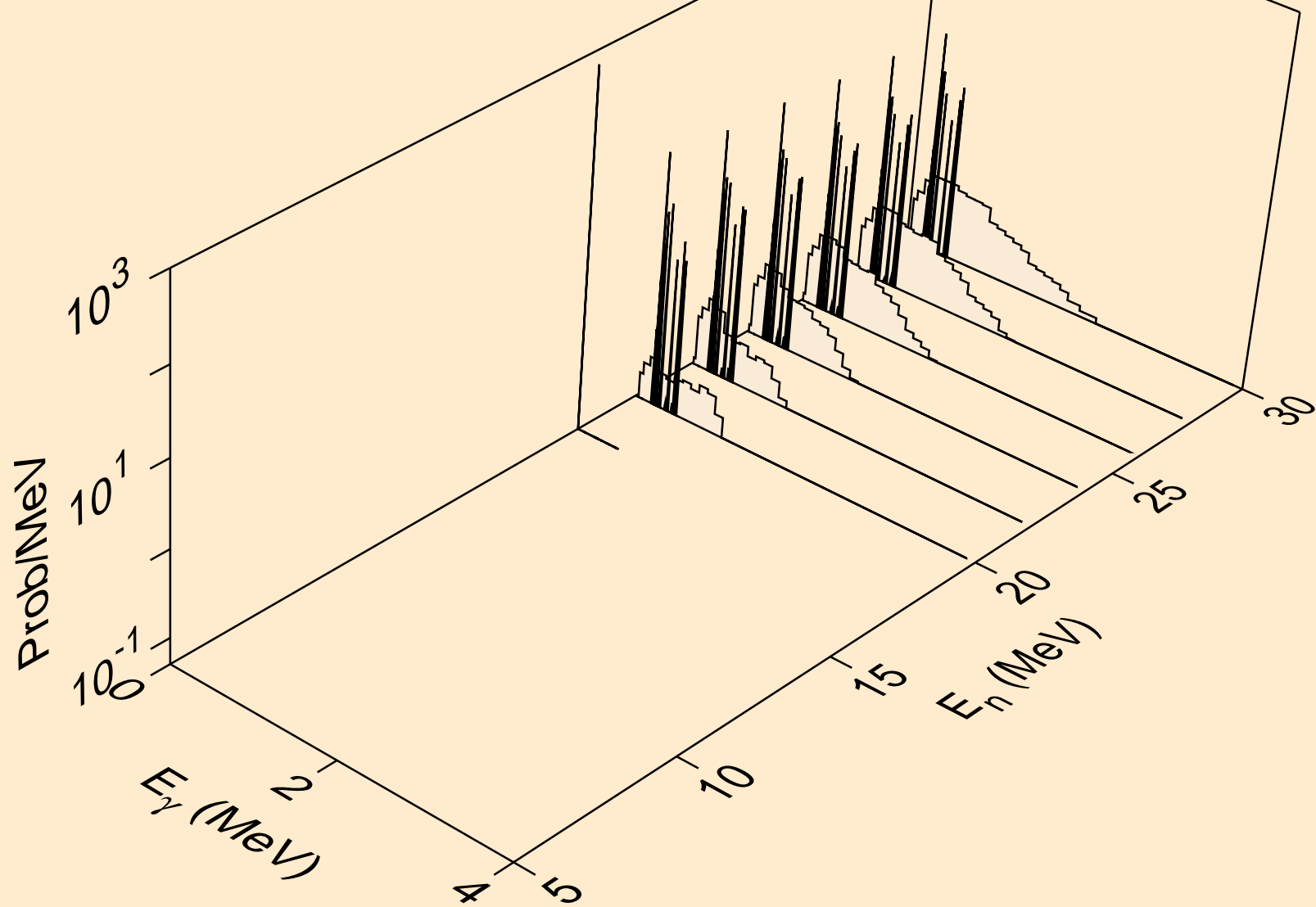

AG118M TRITON ACER TENDL-2021 LIBRARY; T=0.K  
Photon emission for (n,gma)

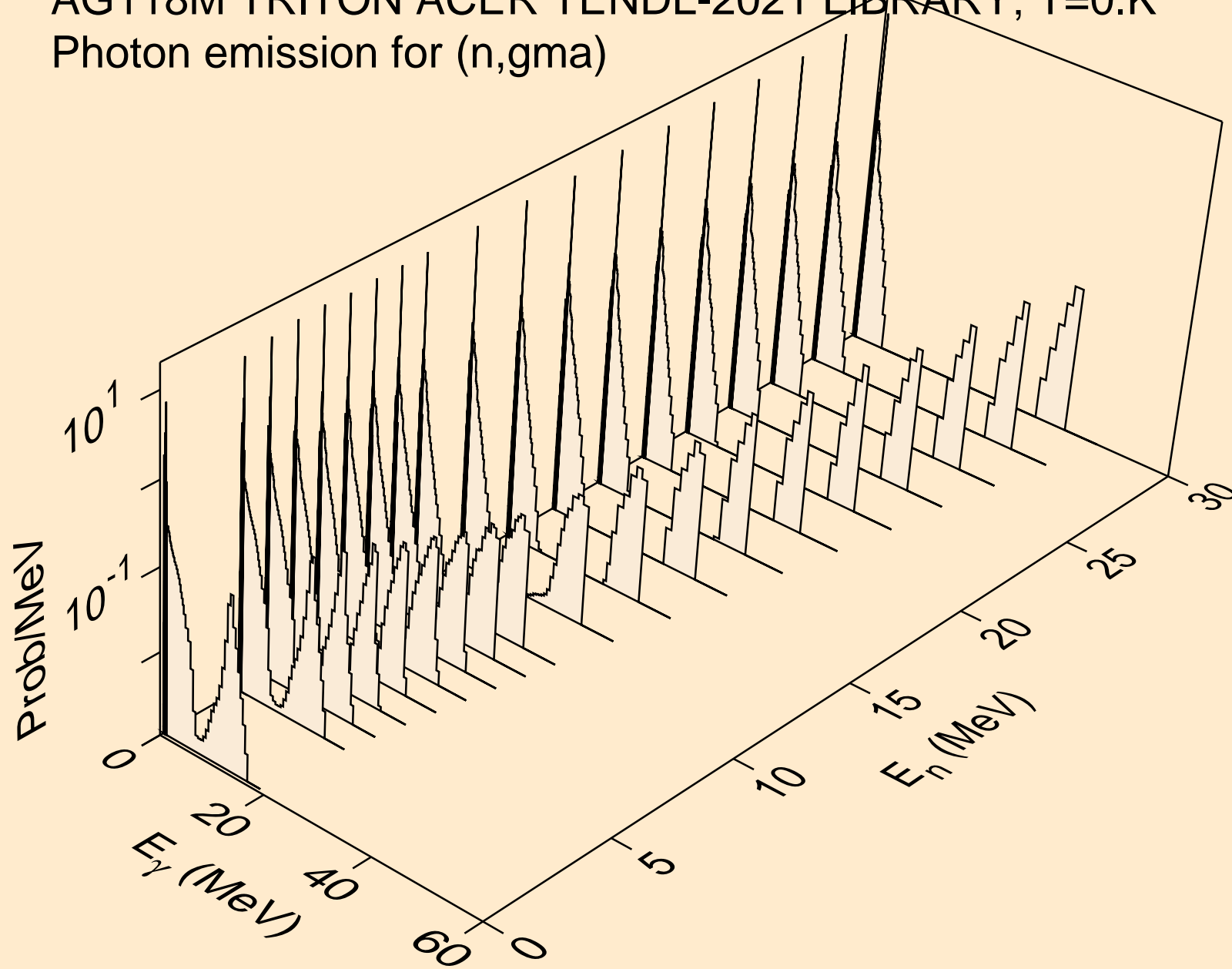



AG118M TRITON ACER TENDL-2021 LIBRARY; T=0.K  
Photon emission for (n,p)

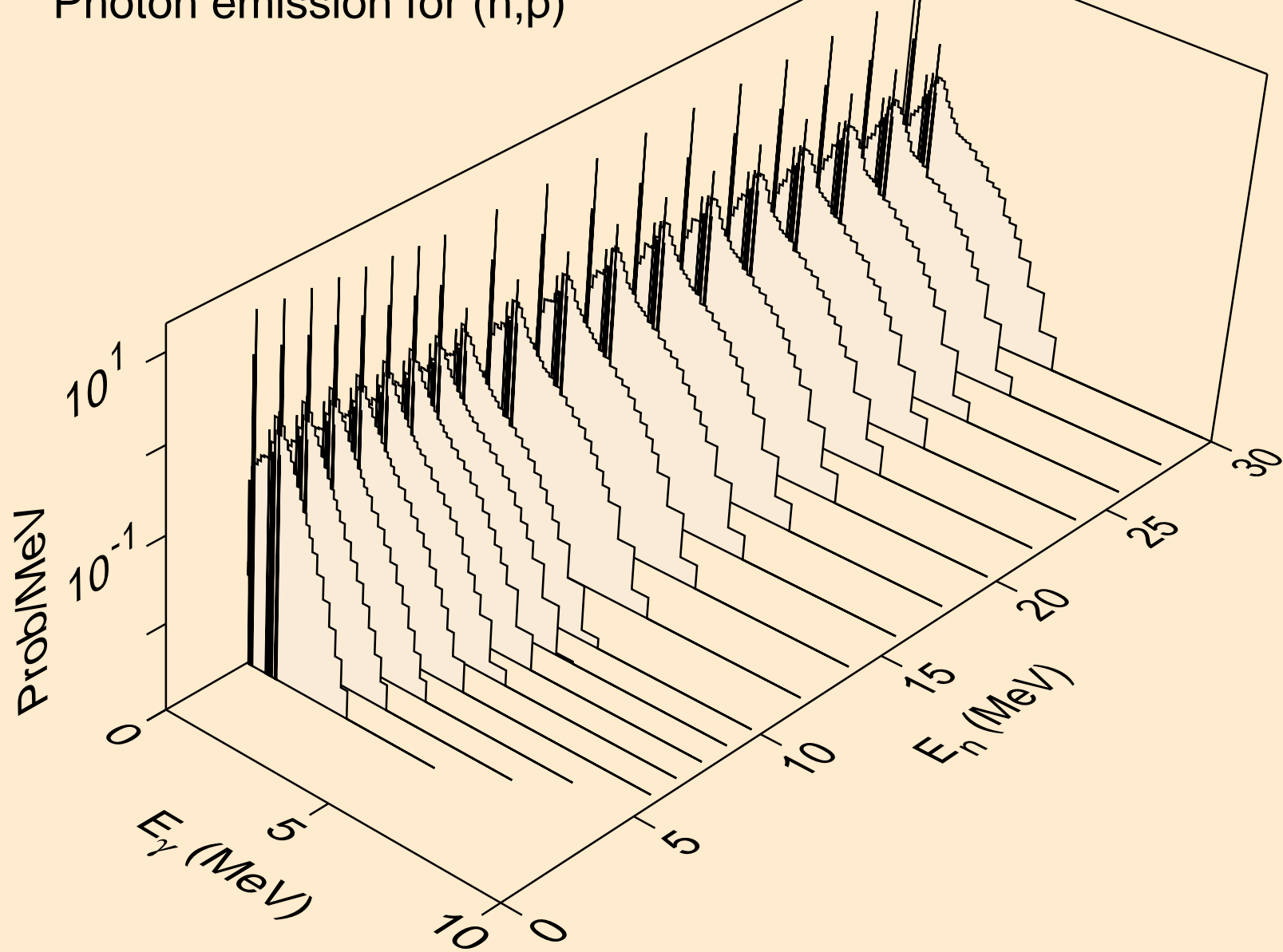

AG118M TRITON ACER TENDL-2021 LIBRARY; T=0.K  
Photon emission for (n,d)

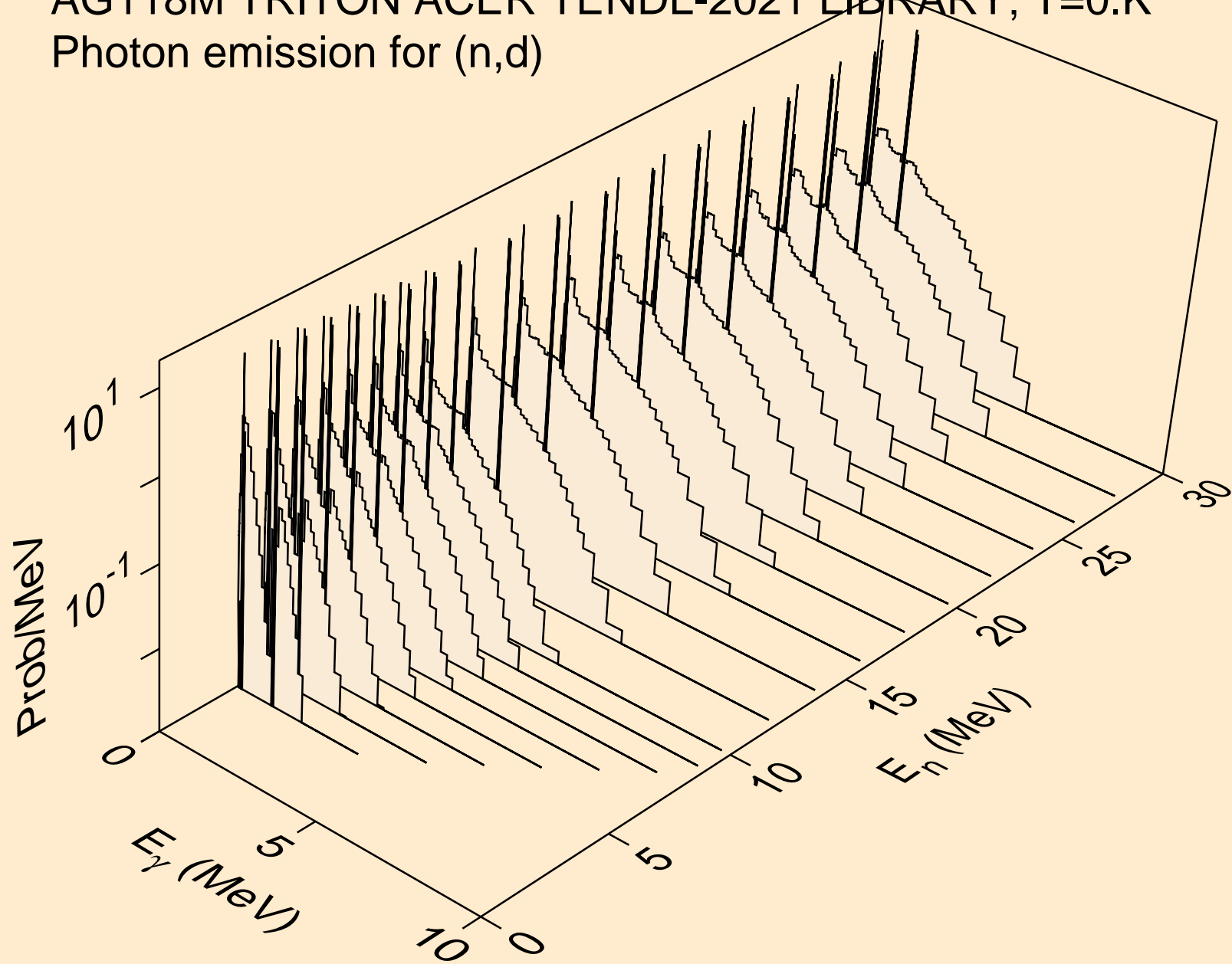

AG118M TRITON ACER TENDL-2021 LIBRARY; T=0.K  
Photon emission for inelastic

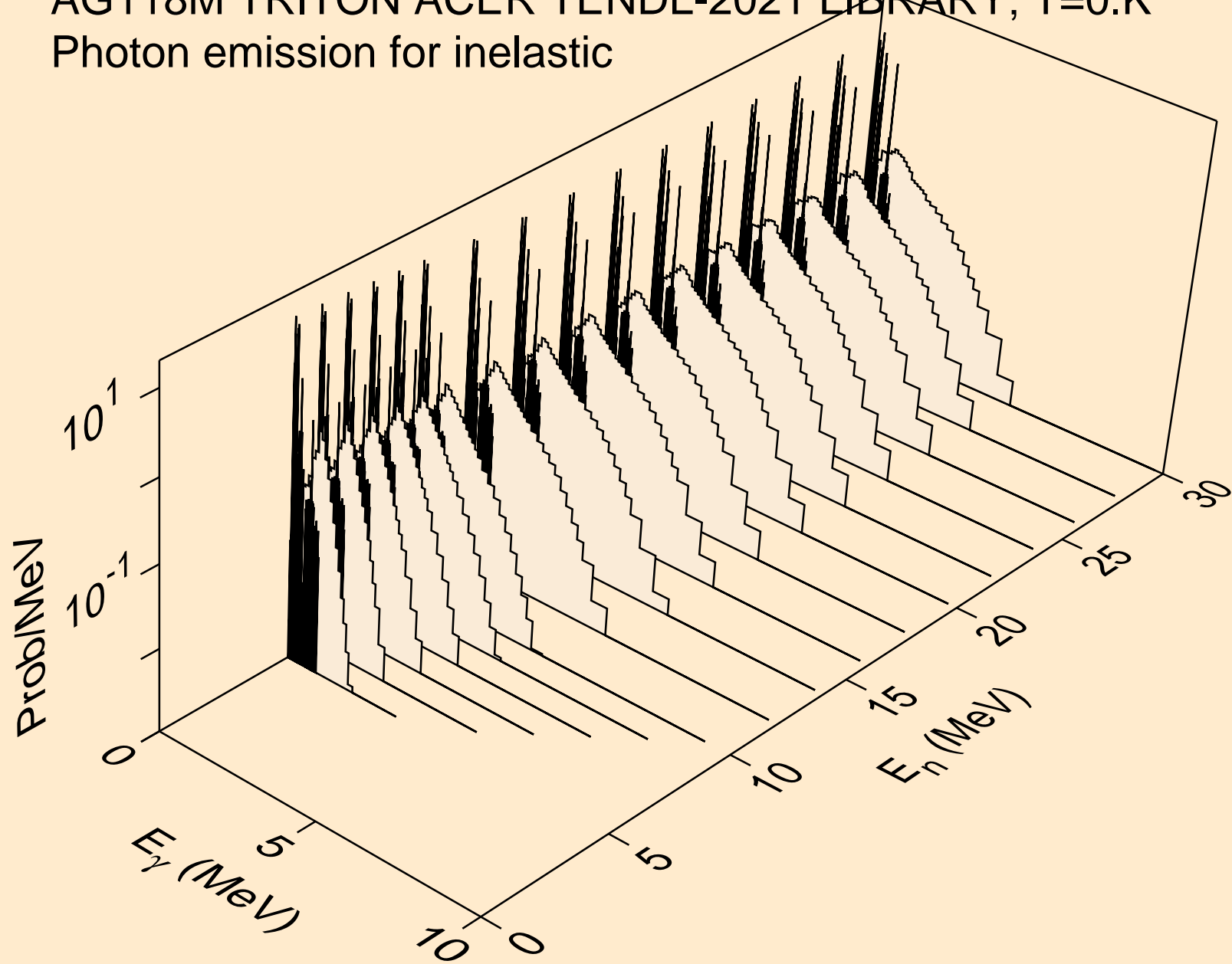

AG118M TRITON ACER TENDL-2021 LIBRARY; T=0.K  
Photon emission for (n,he3)

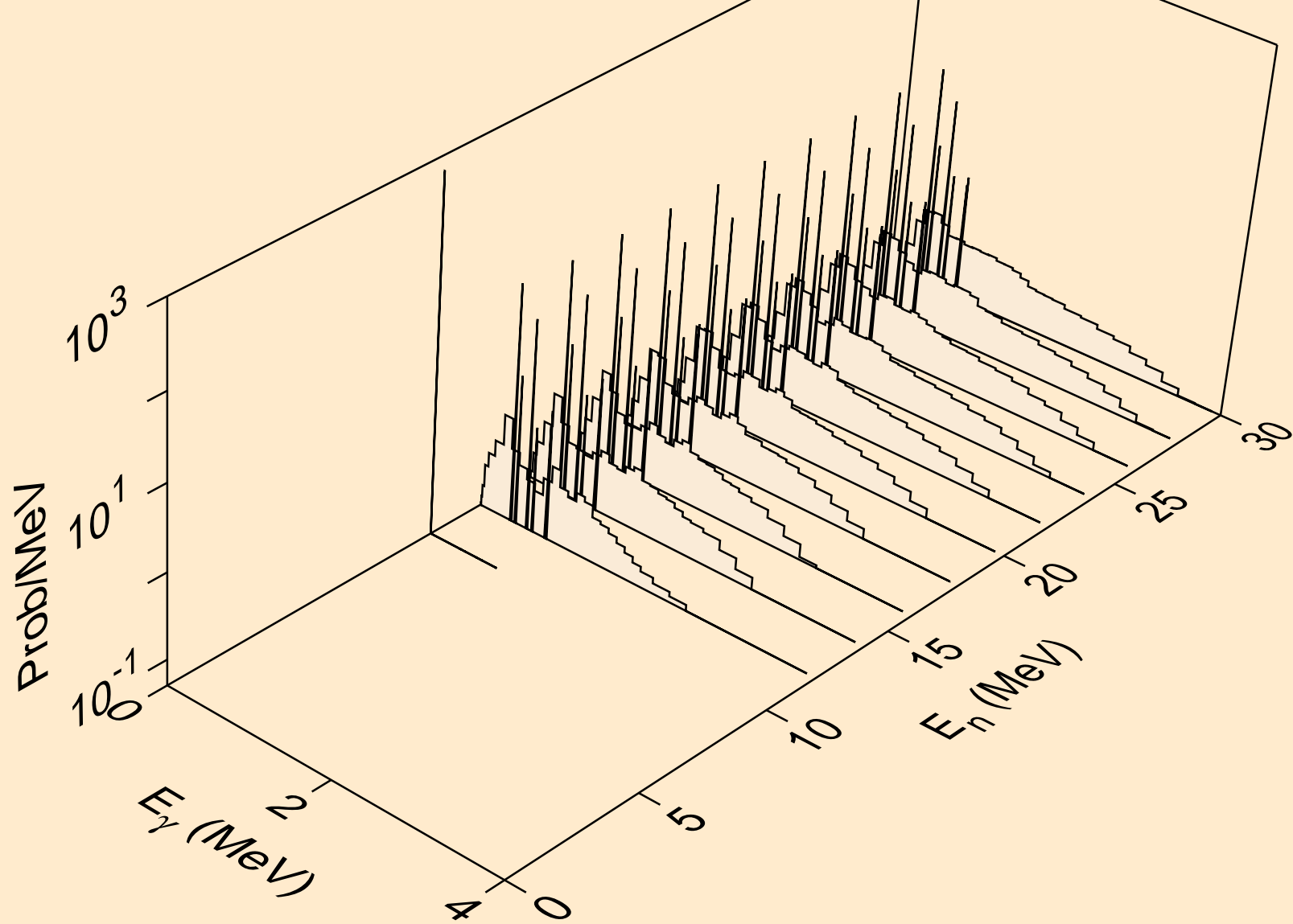

AG118M TRITON ACER TENDL-2021 LIBRARY; T=0.K  
Photon emission for (n,a)

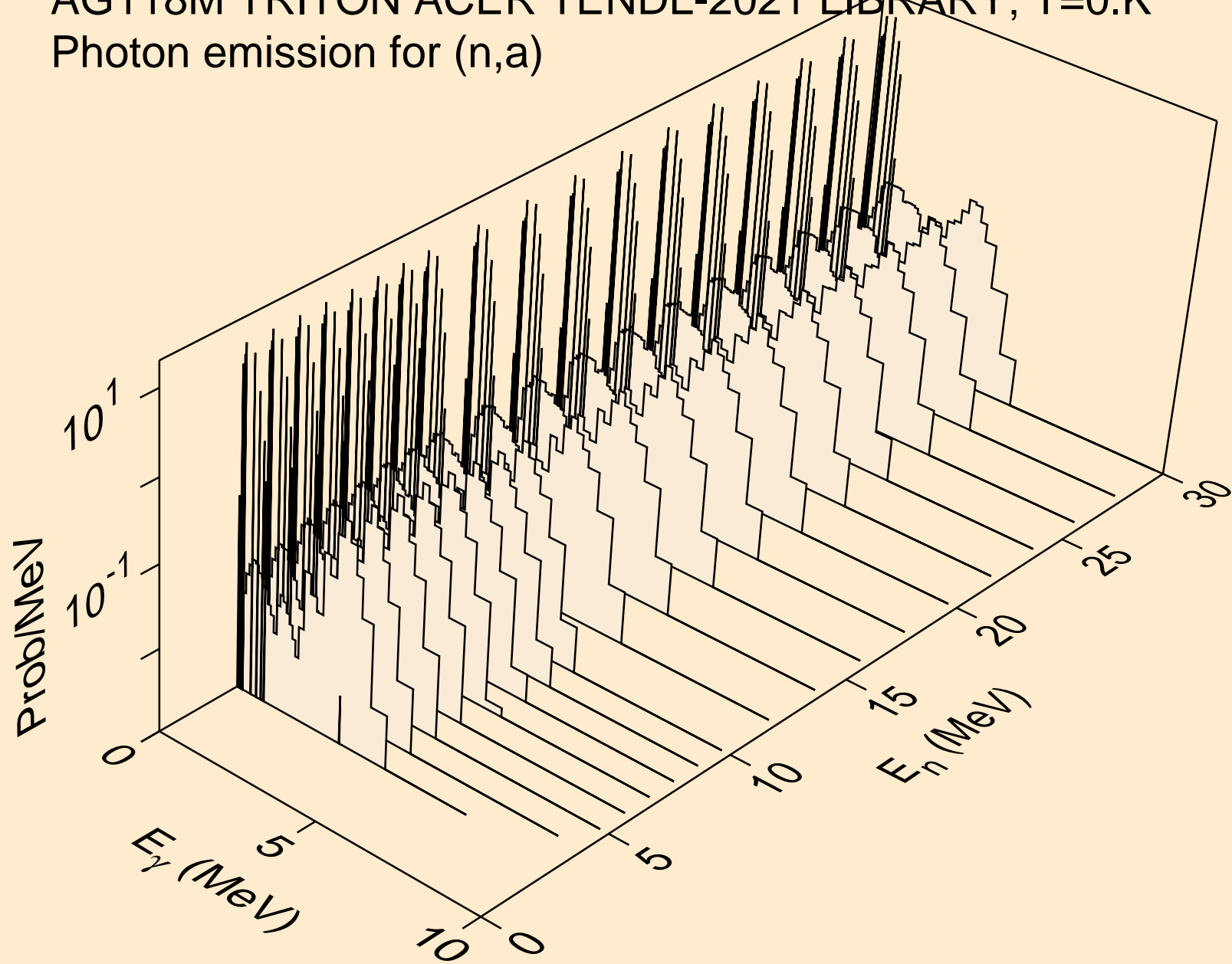

AG118M TRITON ACER TENDL-2021 LIBRARY; T=0.K  
Photon emission for (n,2p)

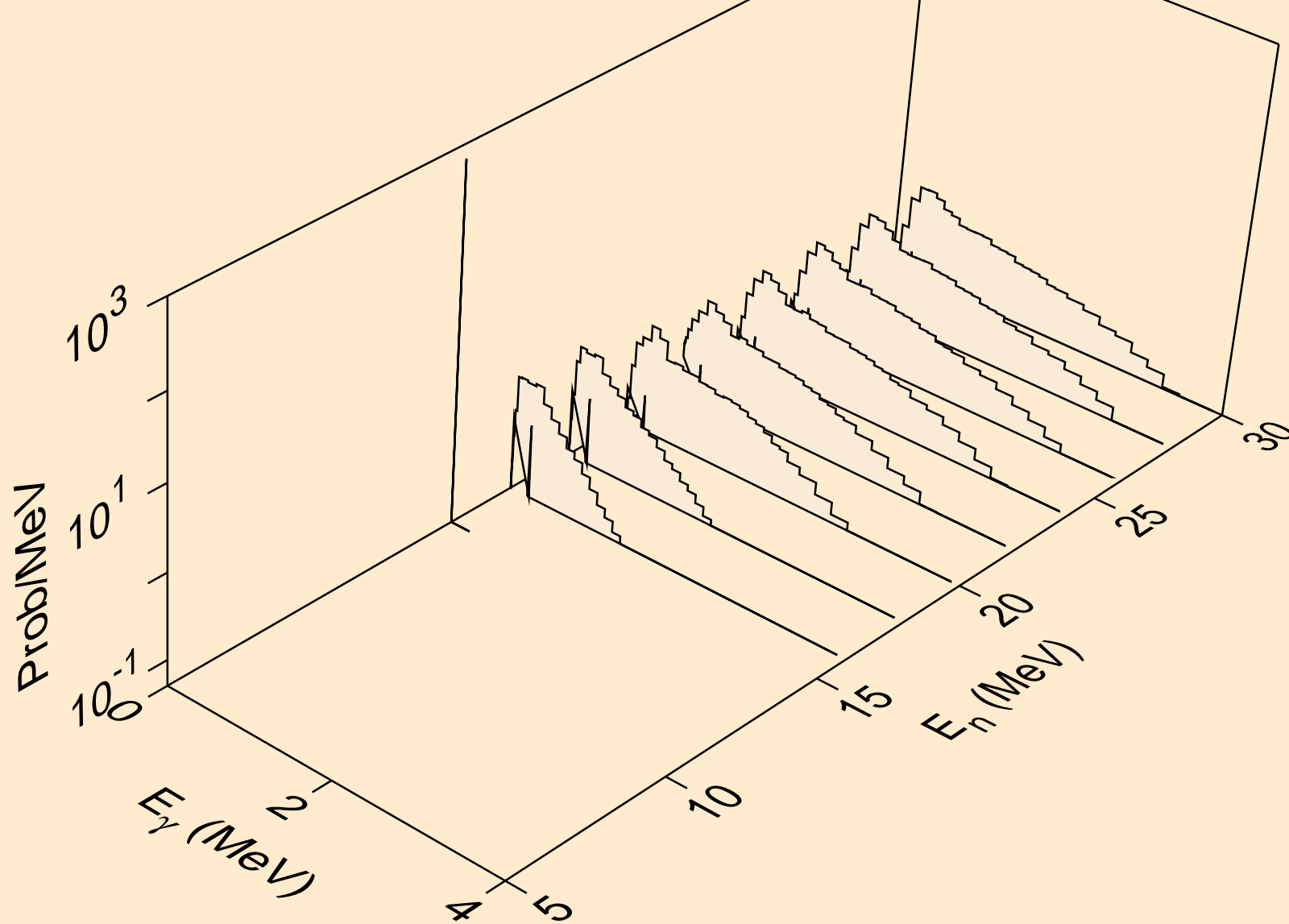

AG118M TRITON ACER TENDL-2021 LIBRARY; T=0.K  
Photon emission for (n,pa)

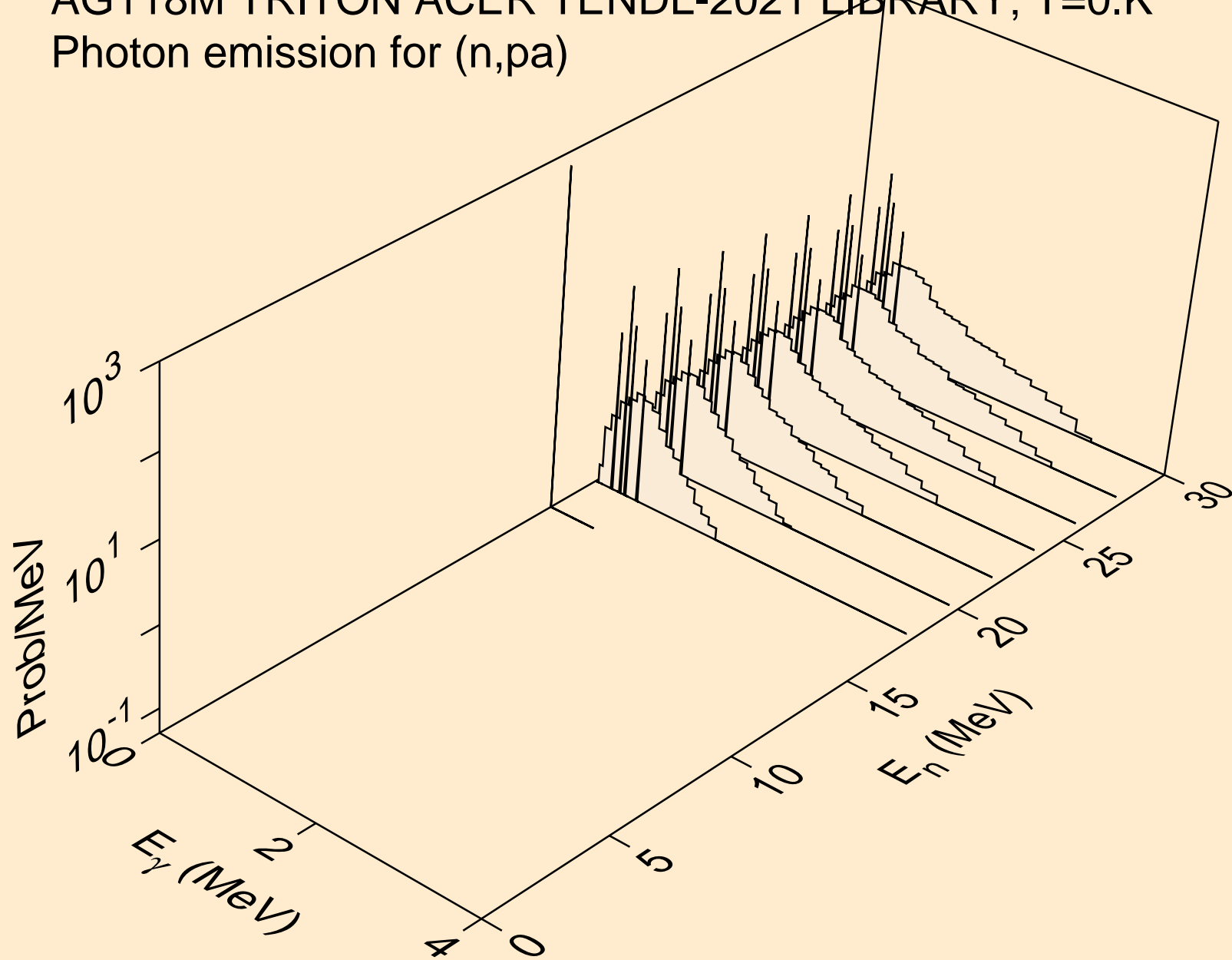

AG118M TRITON ACER TENDL-2021 LIBRARY; T=0.K  
Photon emission for (n,pd)

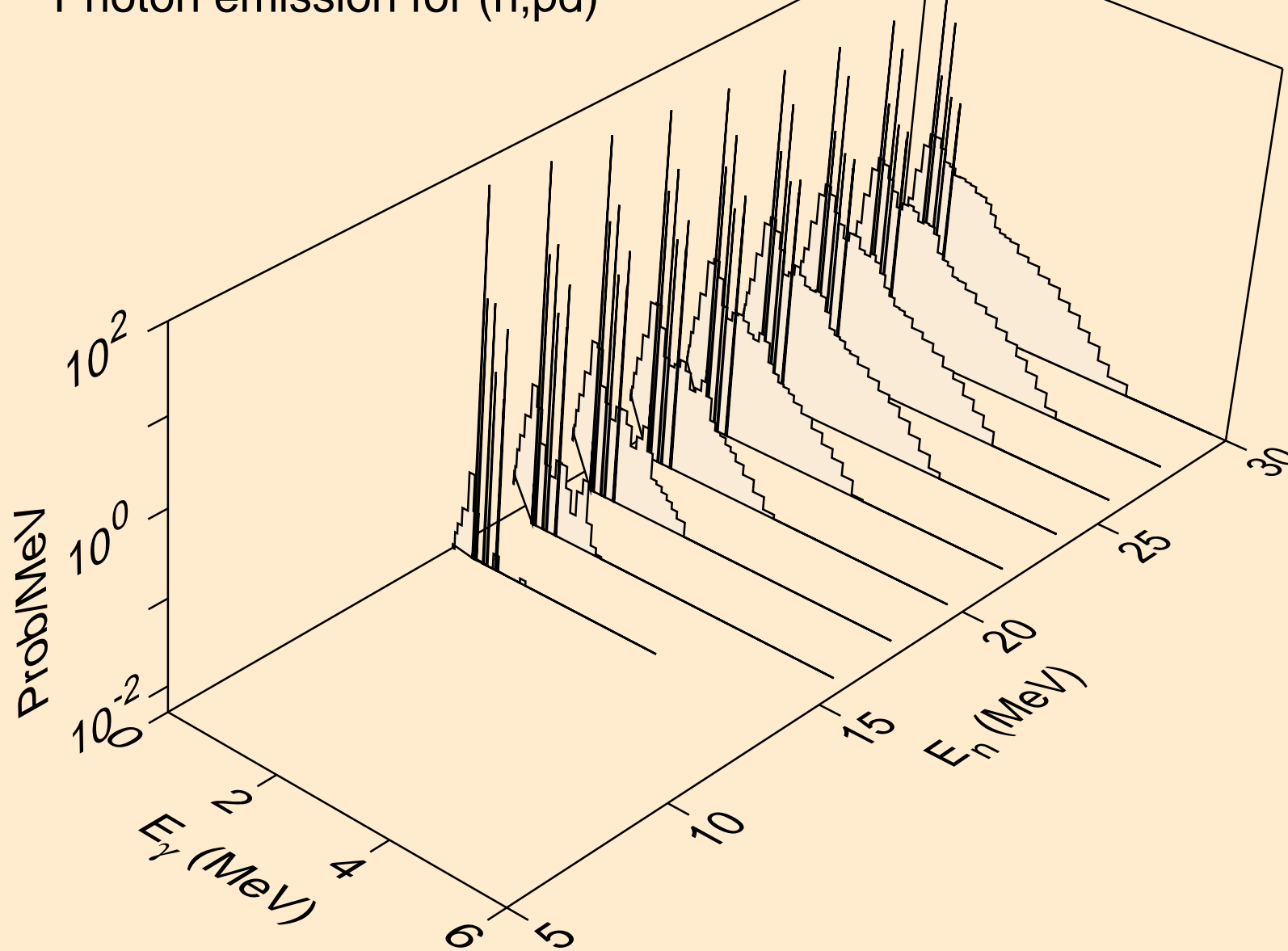



AG118M TRITON ACER TENDL-2021 LIBRARY; T=0.K  
Photon emission for (n,pt)

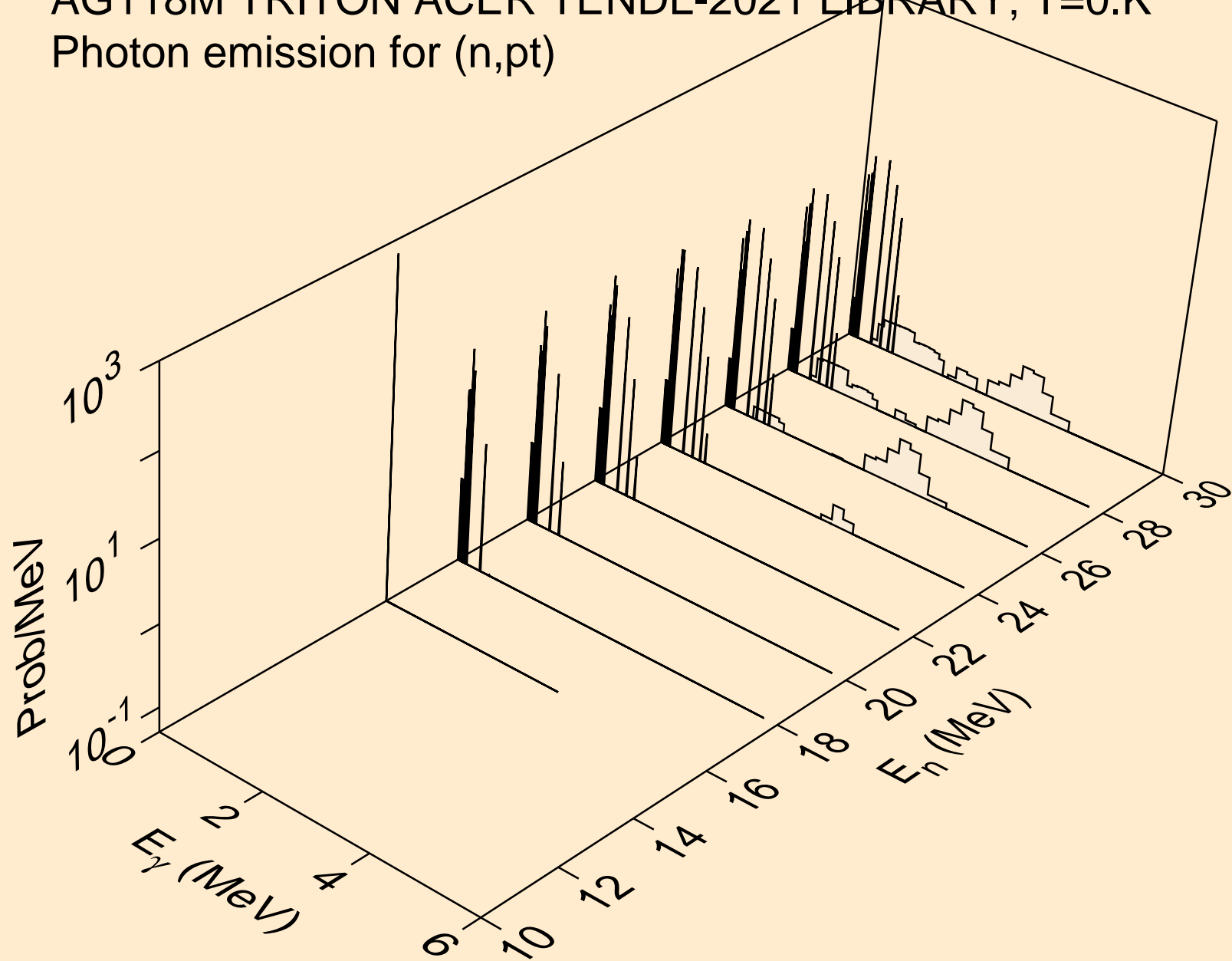

# AG118M TRITON ACER TENDL-2021 LIBRARY; T=0.K

## Particle heating contributions

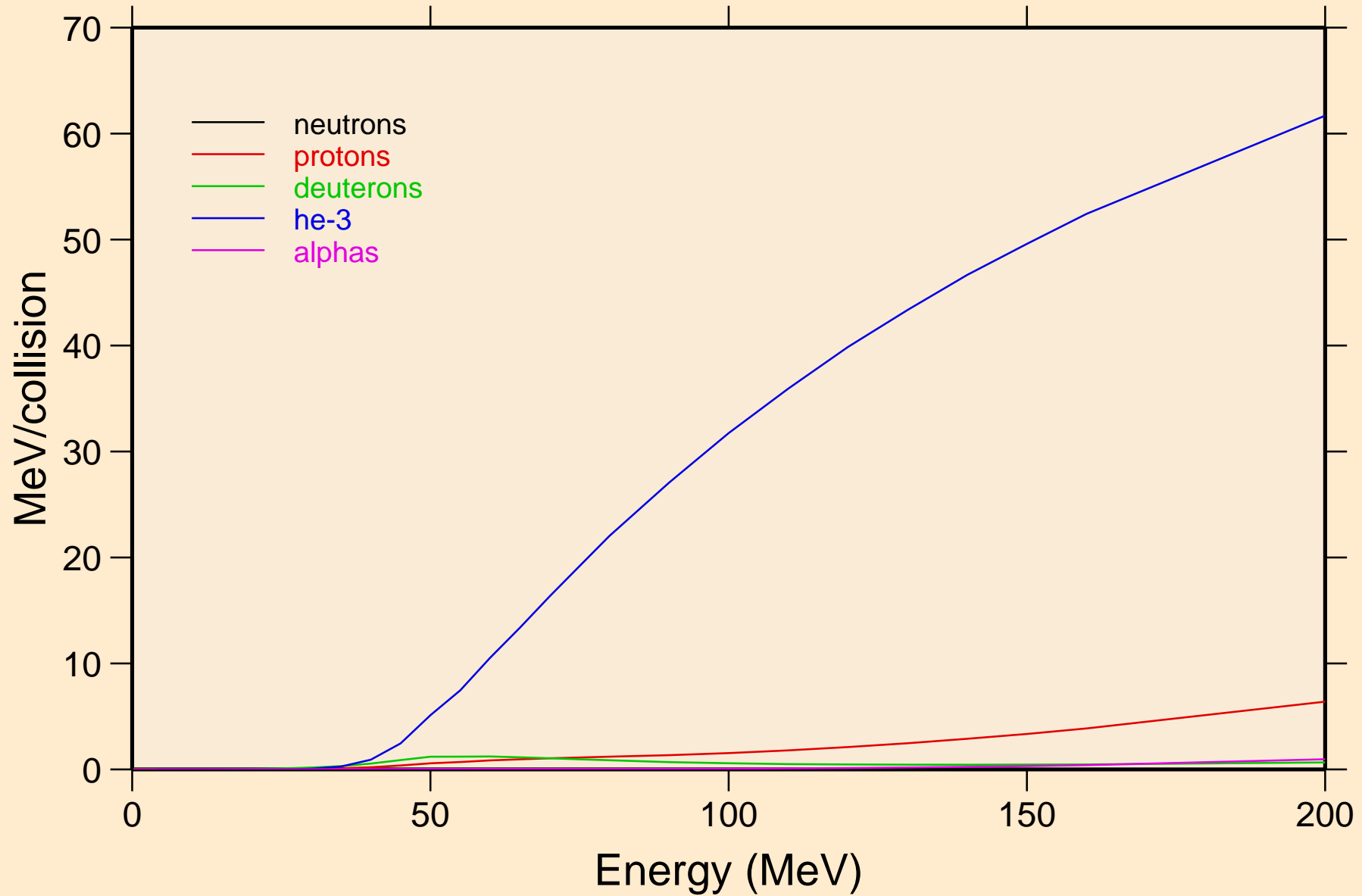

AG118M TRITON ACER TENDL-2021 LIBRARY; T=0.K  
Recoil Heating

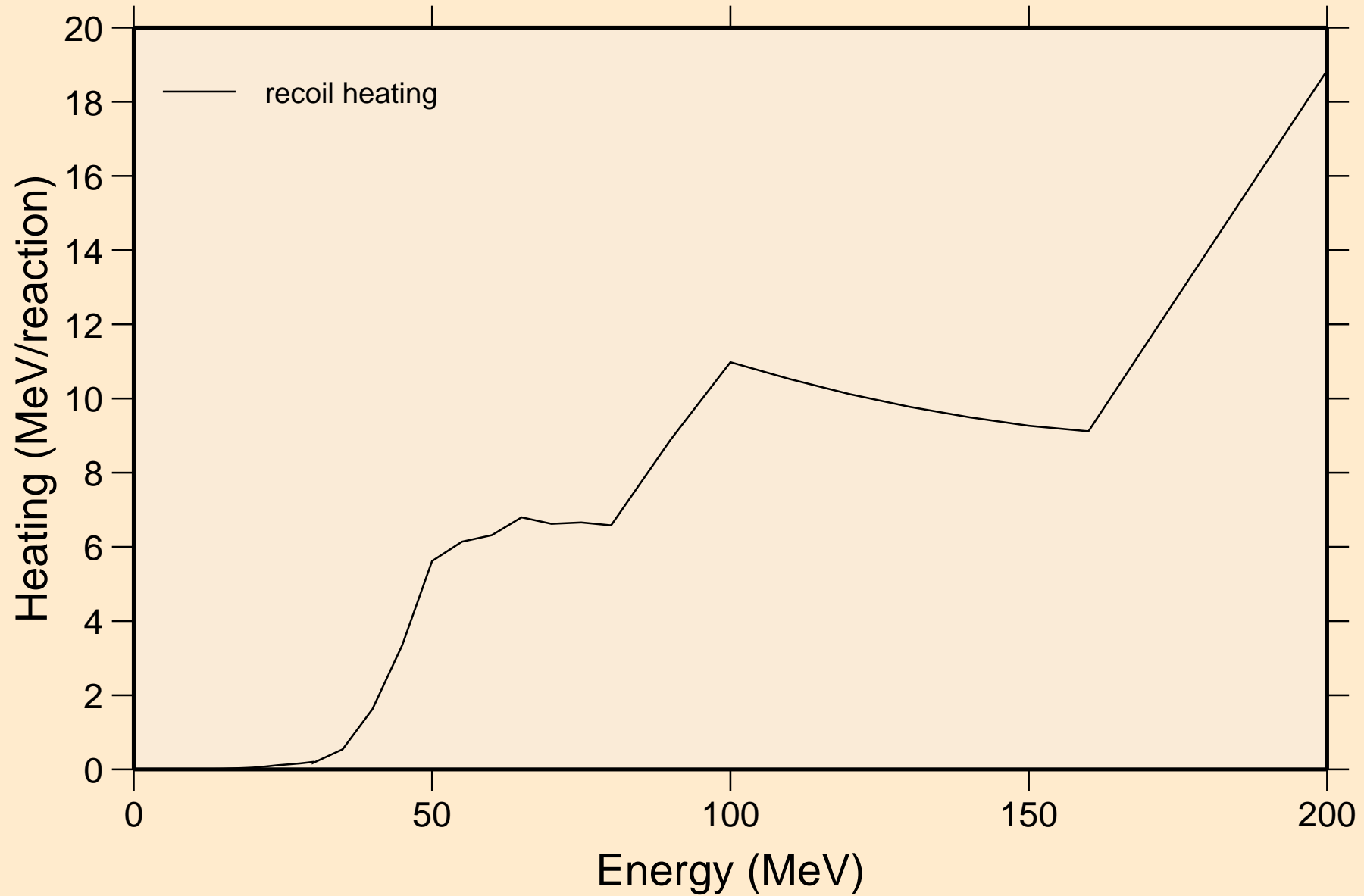

AG118M TRITON ACER TENDL-2021 LIBRARY; T=0.K  
Particle production cross sections

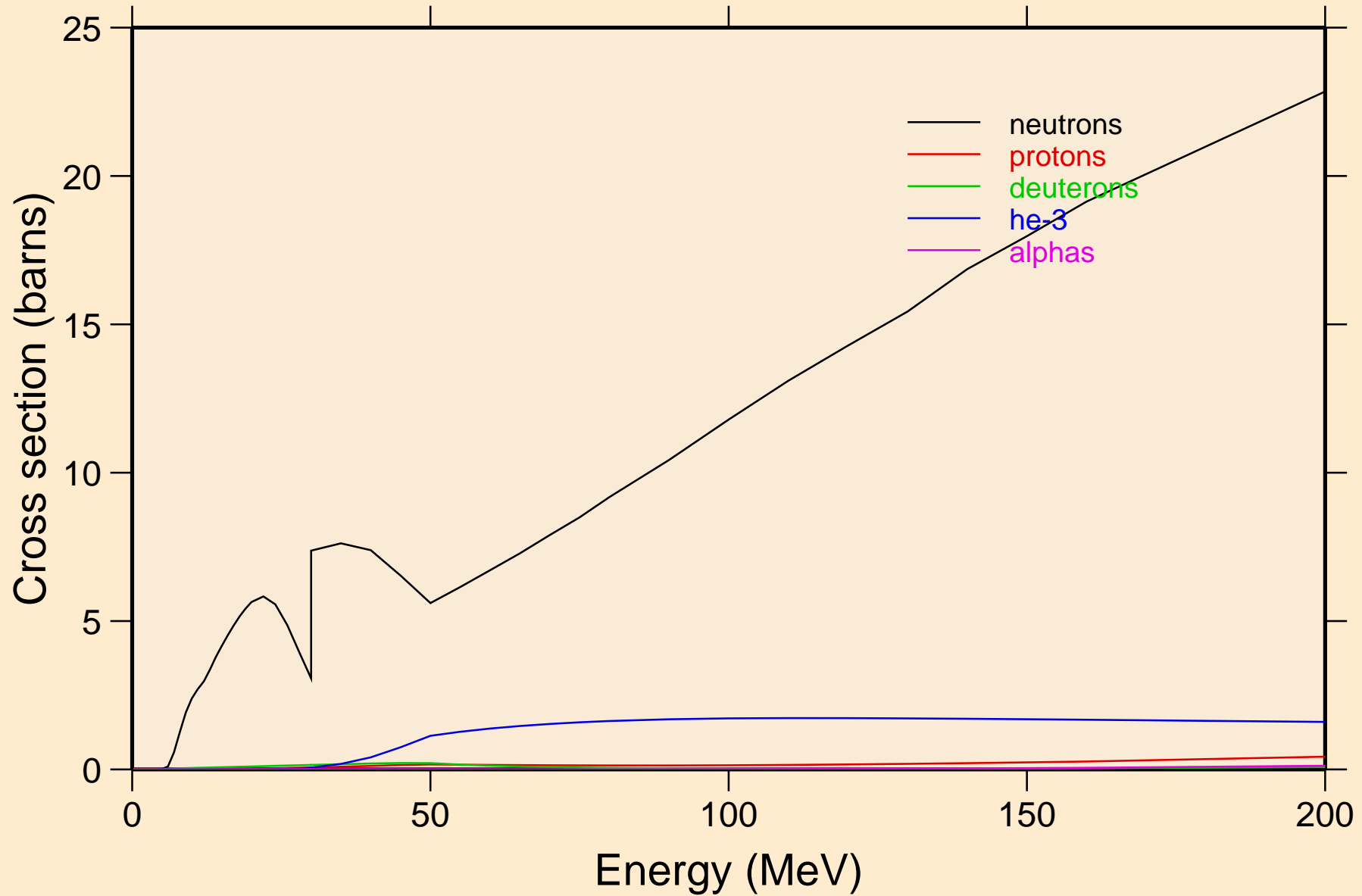

AG118M TRITON ACER TENDL-2021 LIBRARY; T=0.K  
neutrons from (t,n)

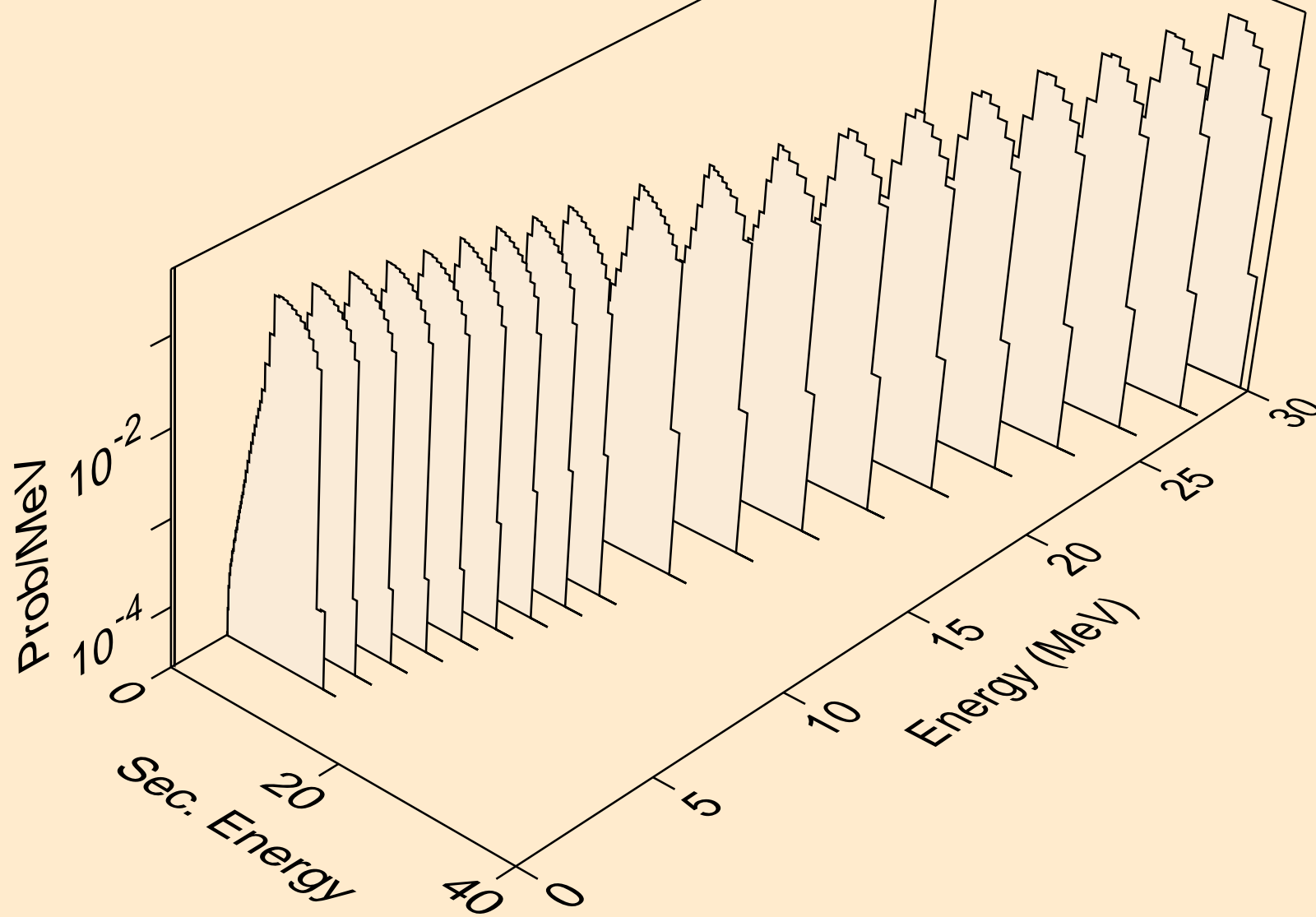

AG118M TRITON ACER TENDL-2021 LIBRARY; T=0.K  
neutrons from (t,x)

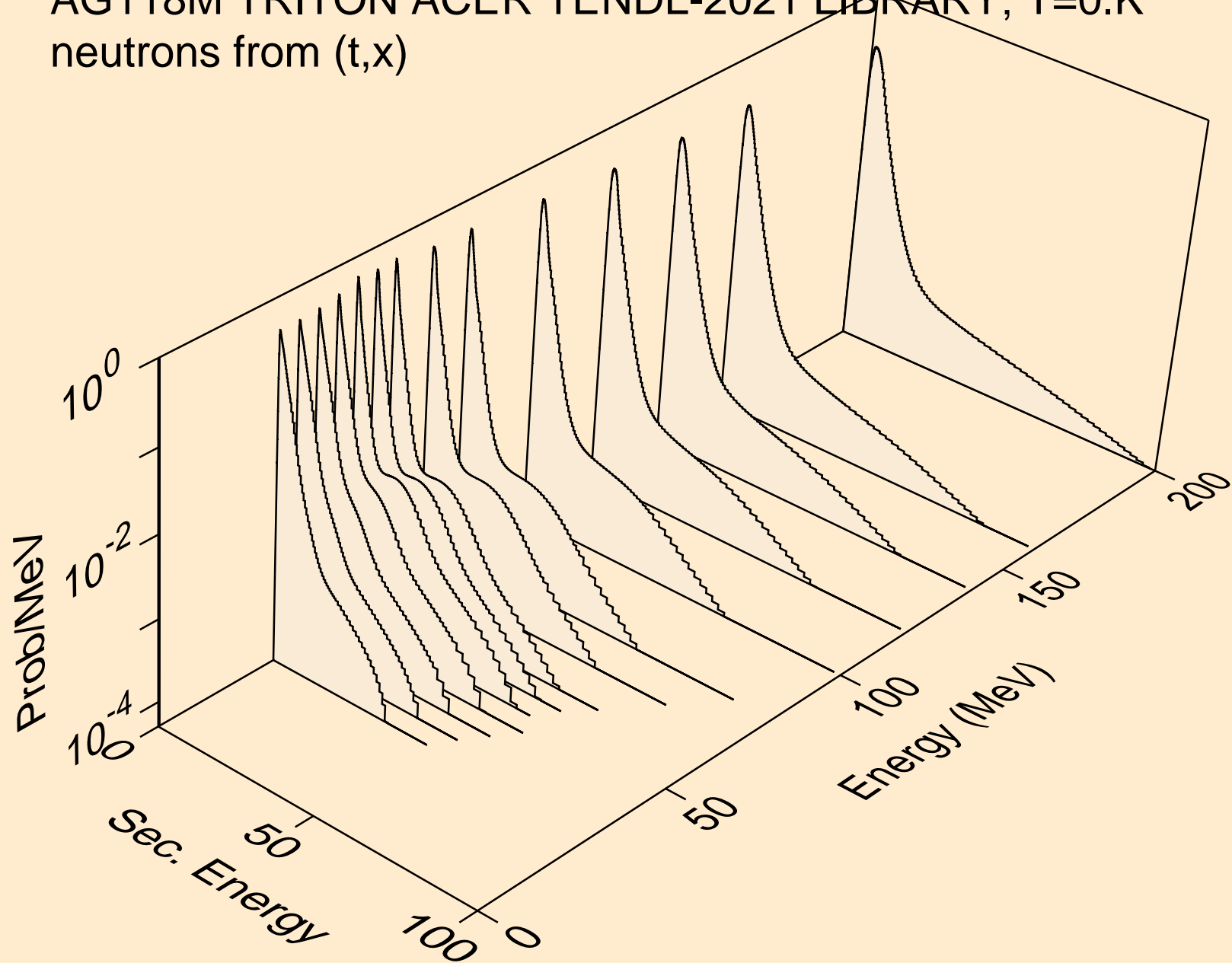

AG118M TRITON ACER TENDL-2021 LIBRARY; T=0.K  
neutrons from (t,2nd)

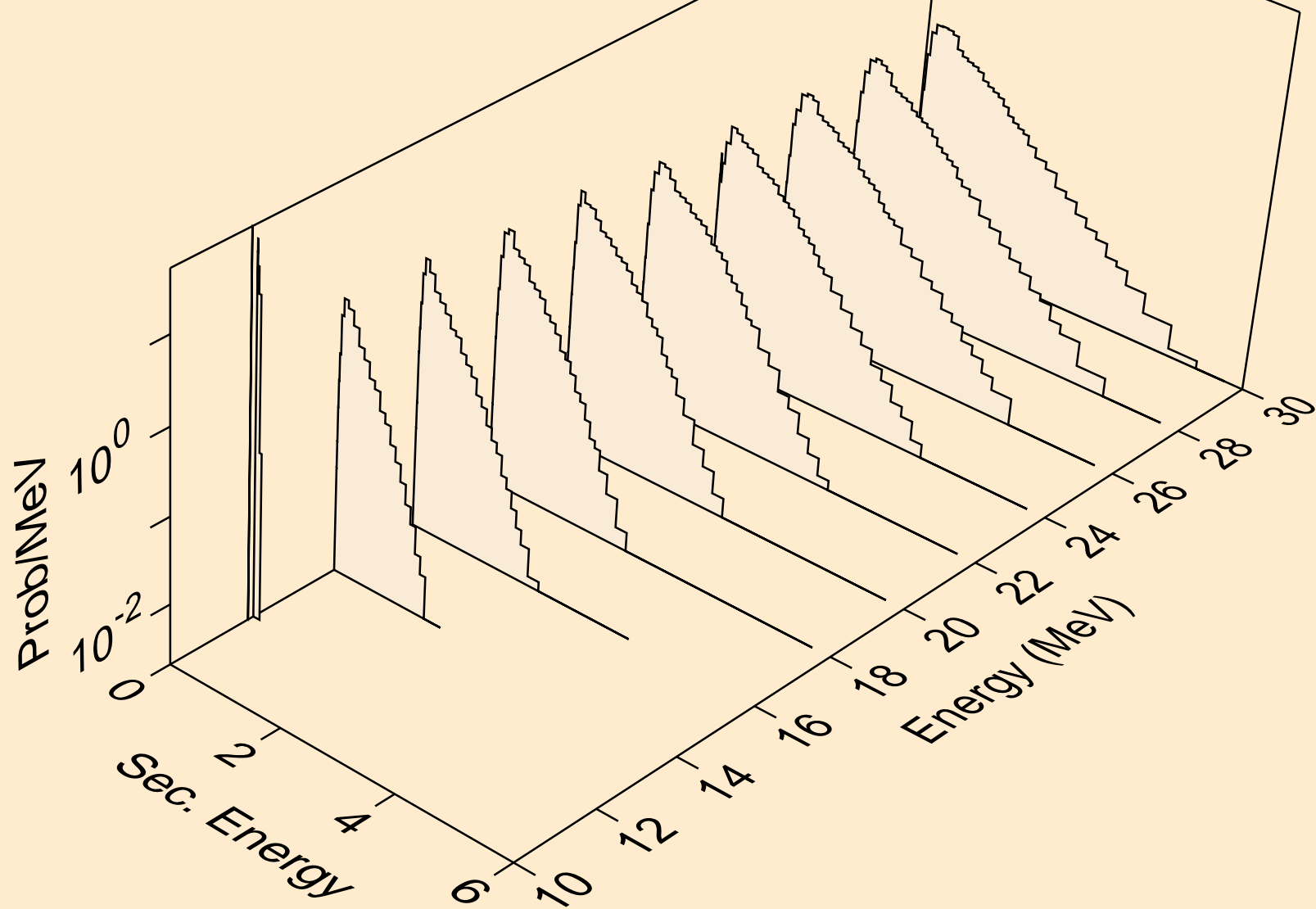

AG118M TRITON ACER TENDL-2021 LIBRARY; T=0.K  
neutrons from (t,2n)

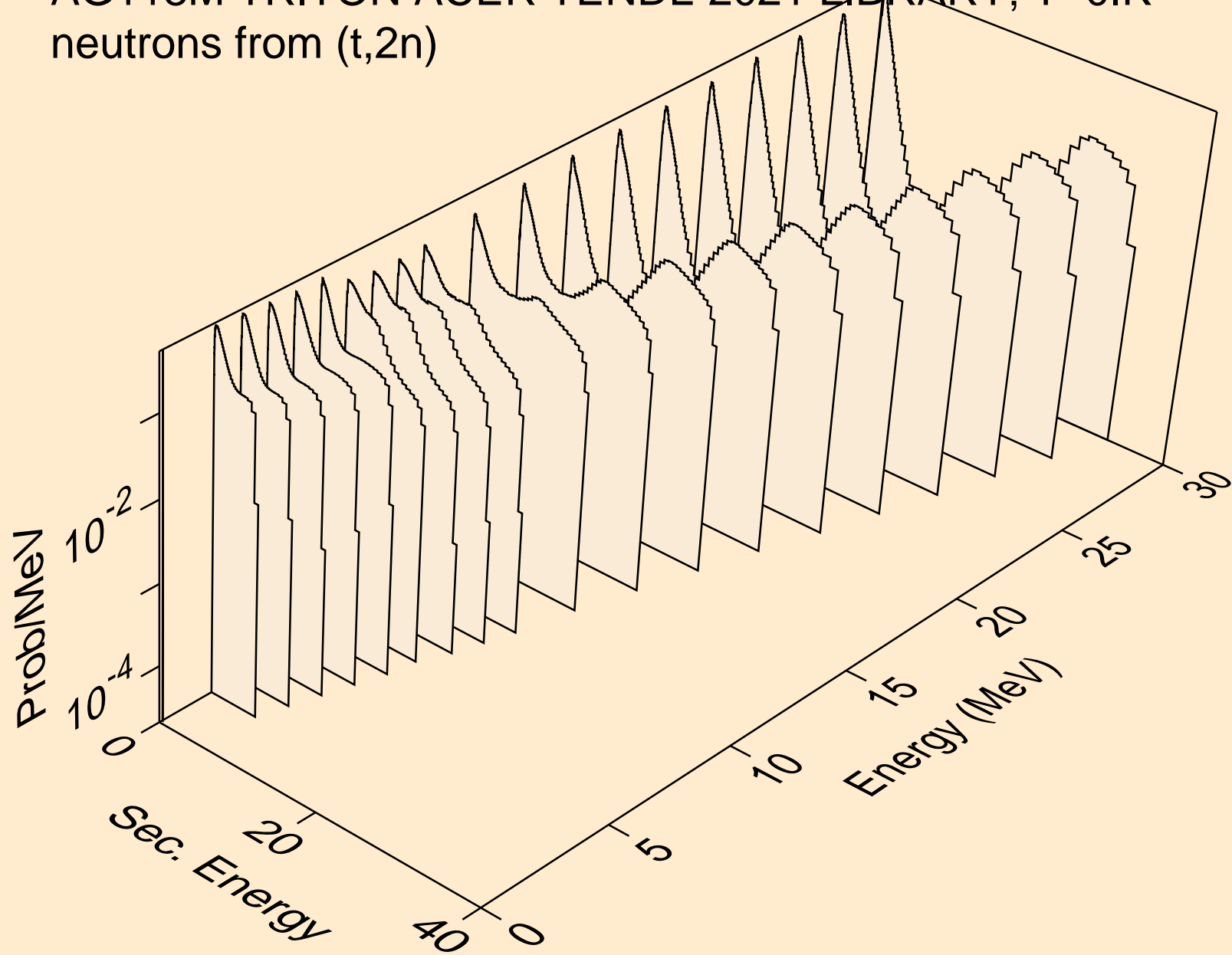



AG118M TRITON ACER TENDL-2021 LIBRARY; T=0.K  
neutrons from (t,3n)

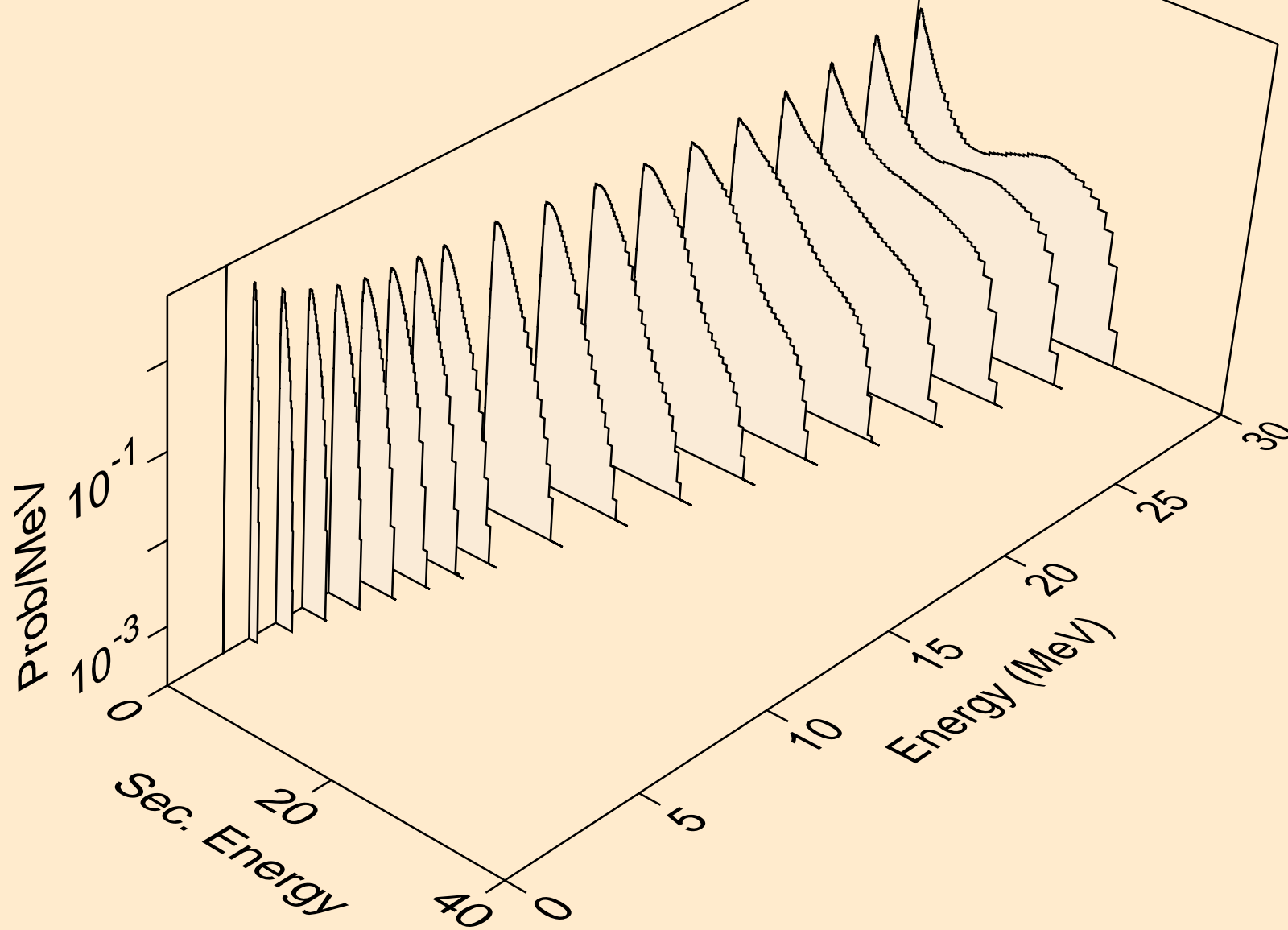

AG118M TRITON ACER TENDL-2021 LIBRARY; T=0.K  
neutrons from (t,n\*)a

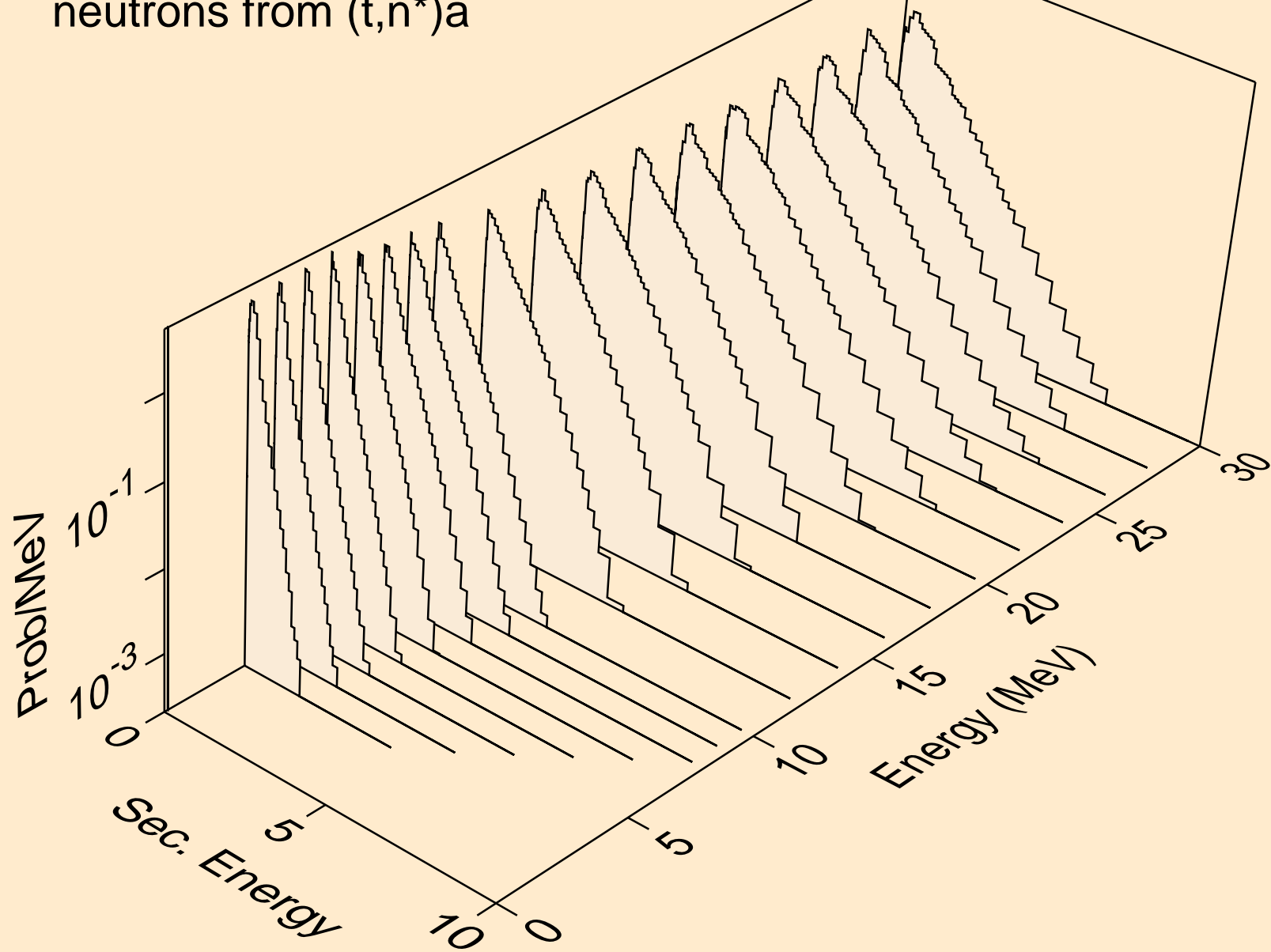

AG118M TRITON ACER TENDL-2021 LIBRARY; T=0.K  
neutrons from (t,2n)a

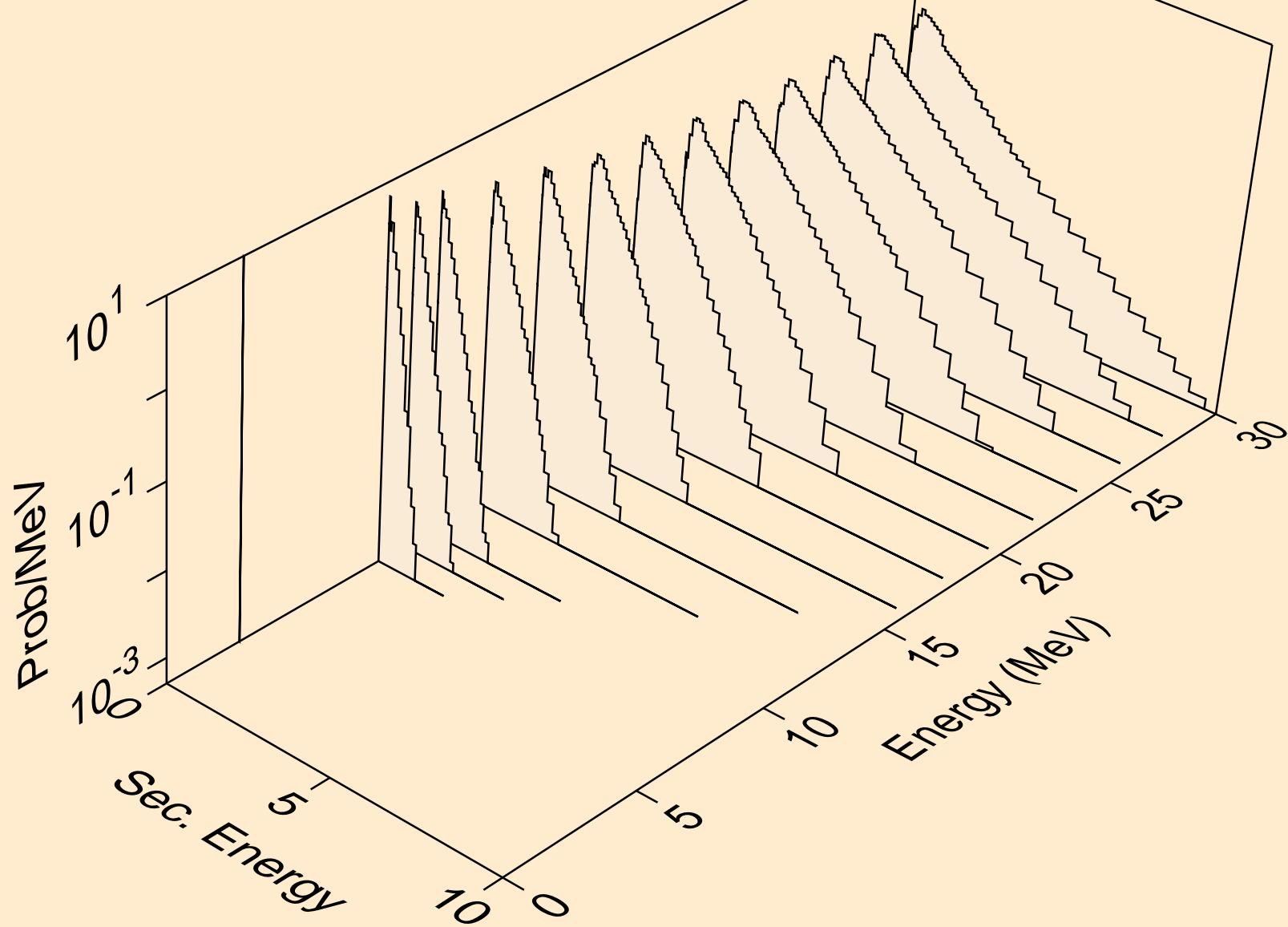

AG118M TRITON ACER TENDL-2021 LIBRARY; T=0.K  
neutrons from (t,3n)a

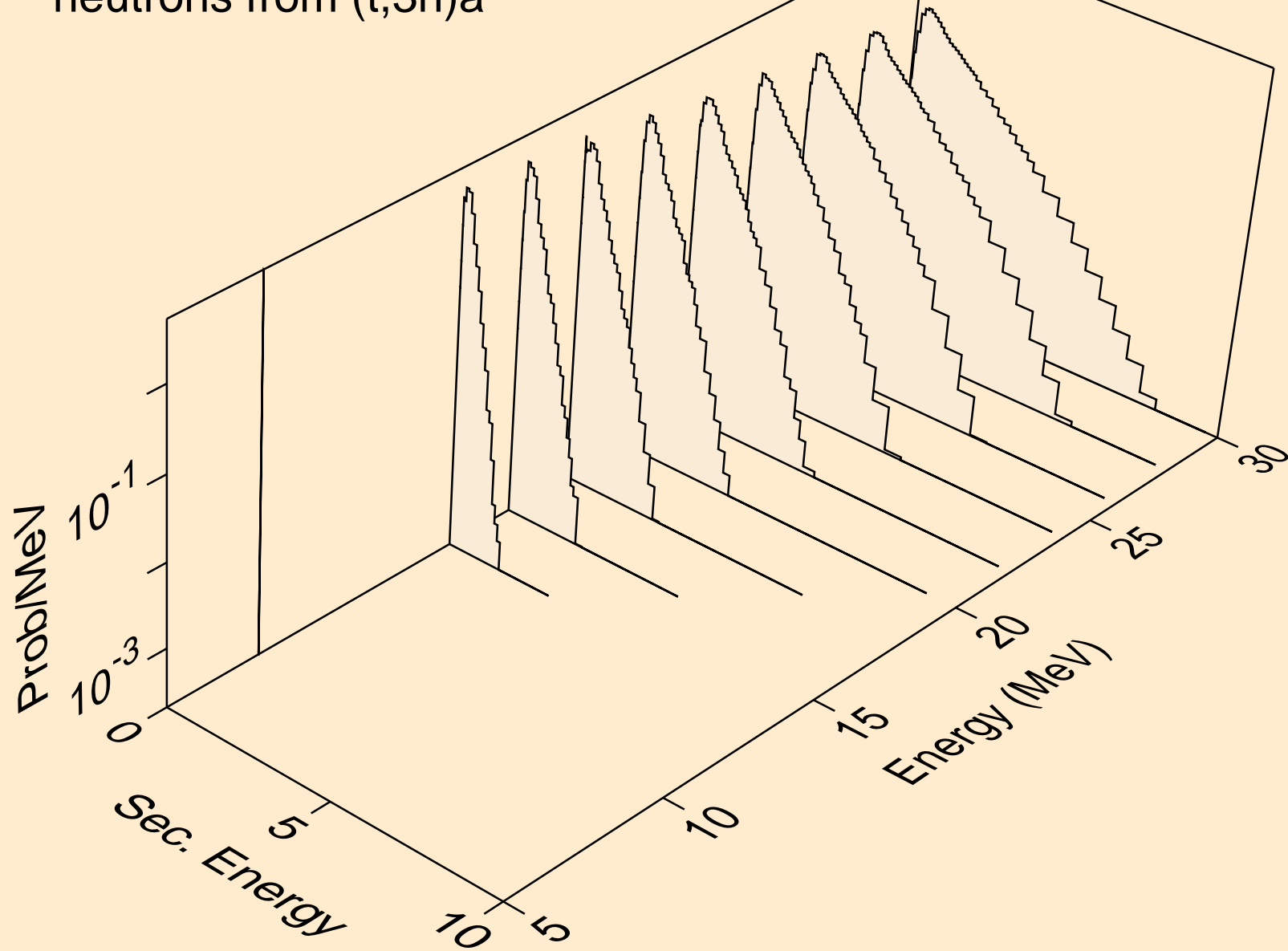

AG118M TRITON ACER TENDL-2021 LIBRARY; T=0.K  
neutrons from (t,n\*)p

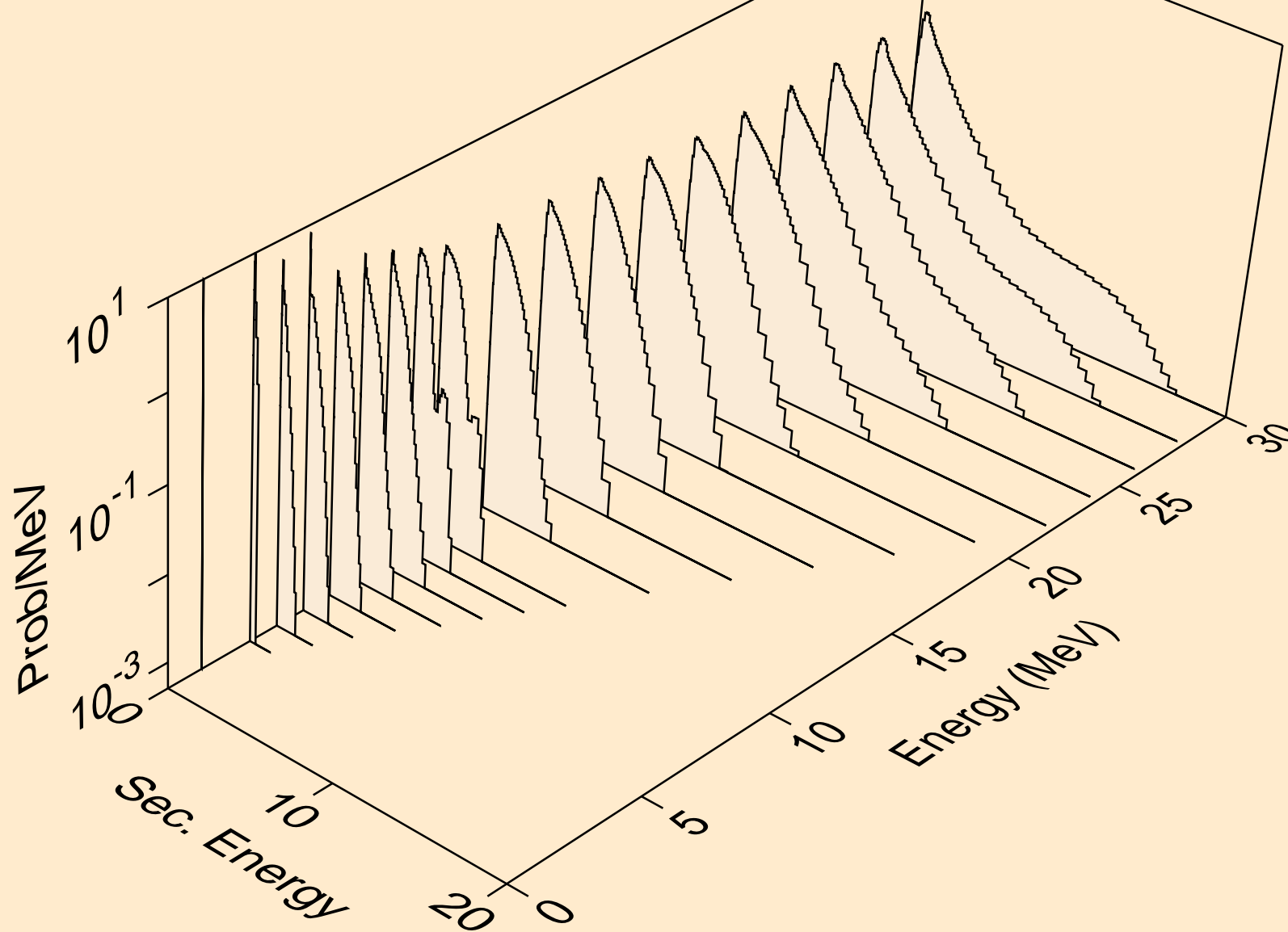

AG118M TRITON ACER TENDL-2021 LIBRARY; T=0.K  
neutrons from (t,n\*)2a

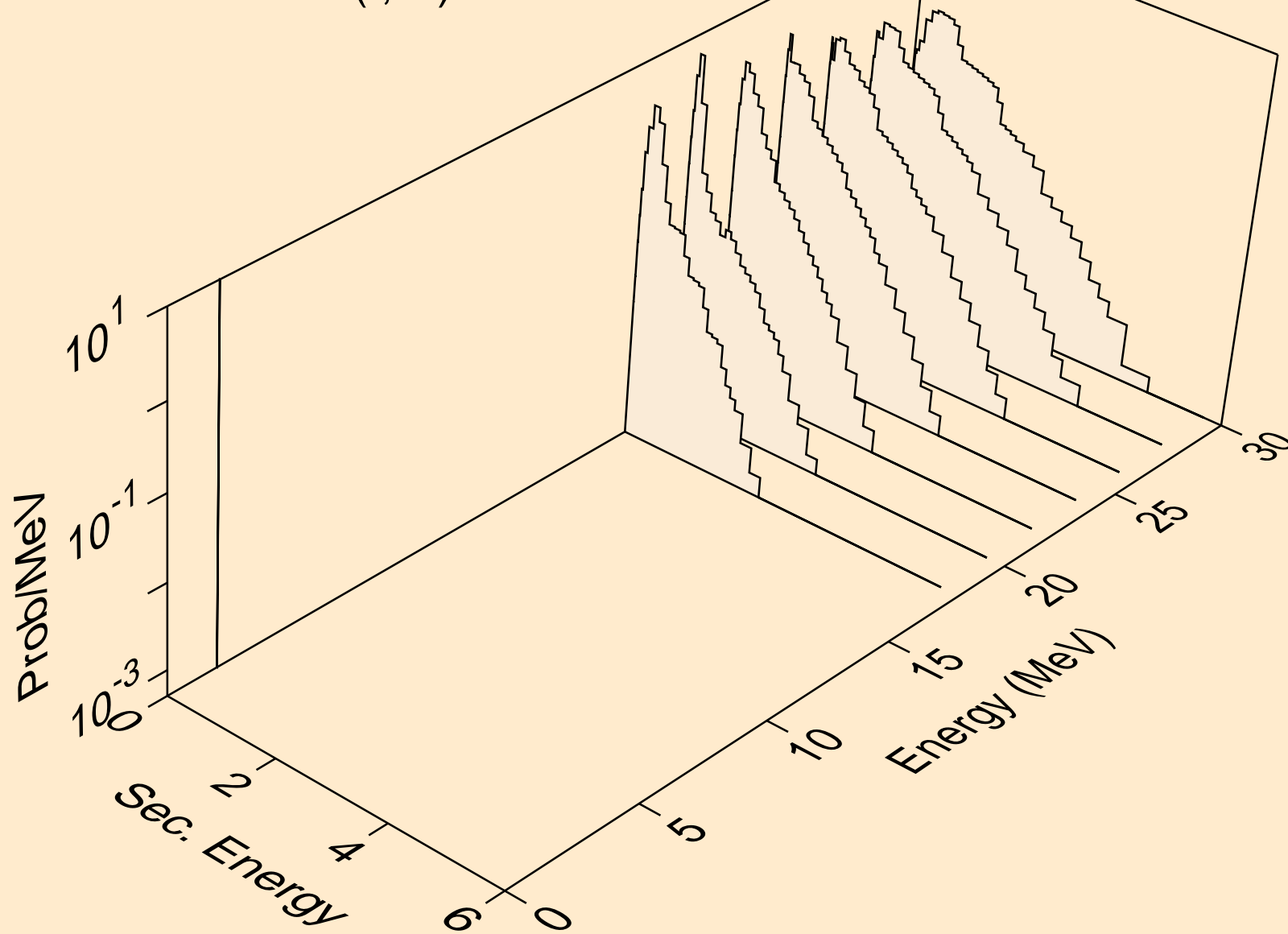

AG118M TRITON ACER TENDL-2021 LIBRARY; T=0.K  
neutrons from (t,n\*)d

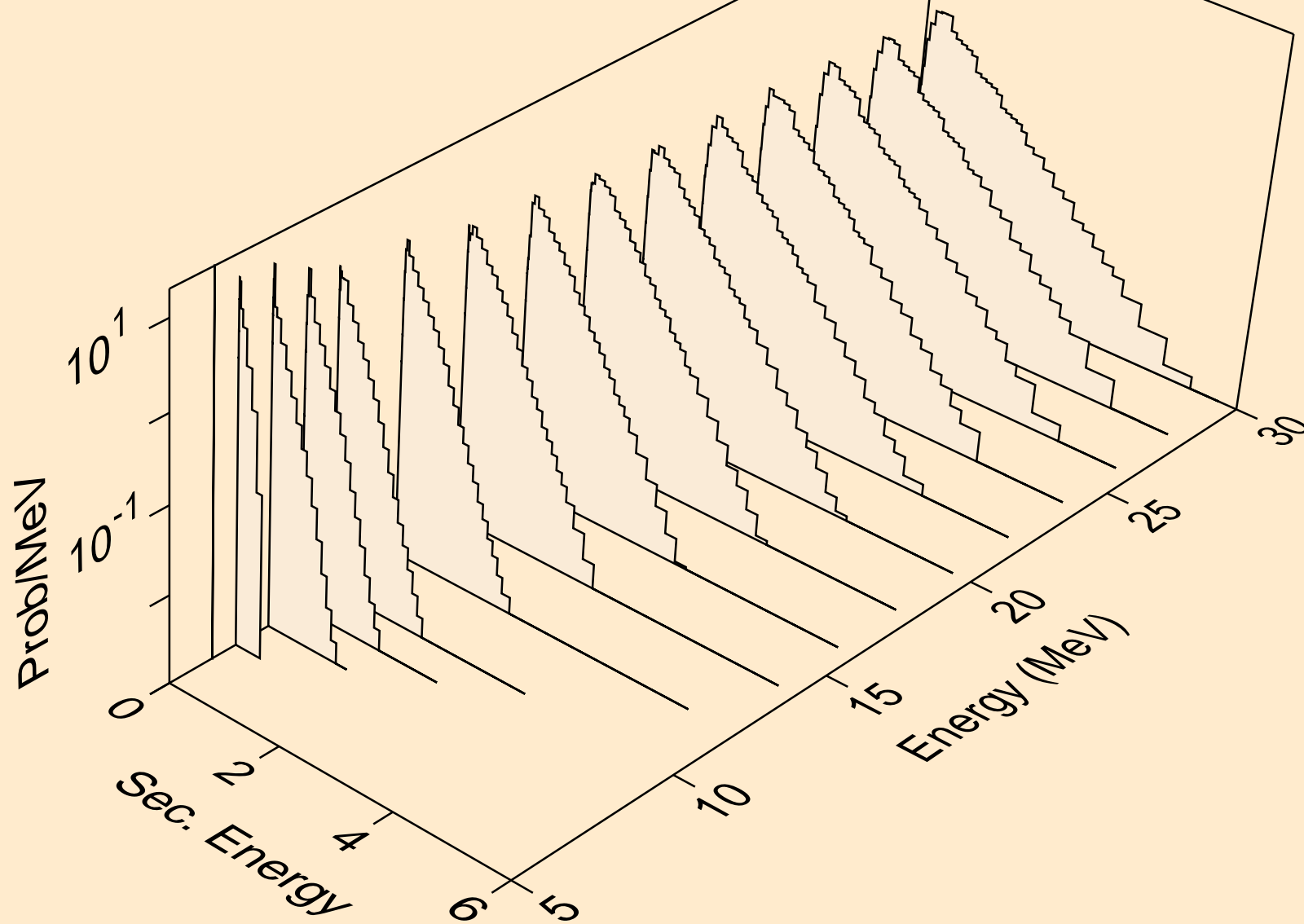

AG118M TRITON ACER TENDL-2021 LIBRARY; T=0.K  
neutrons from (t,n\*)t

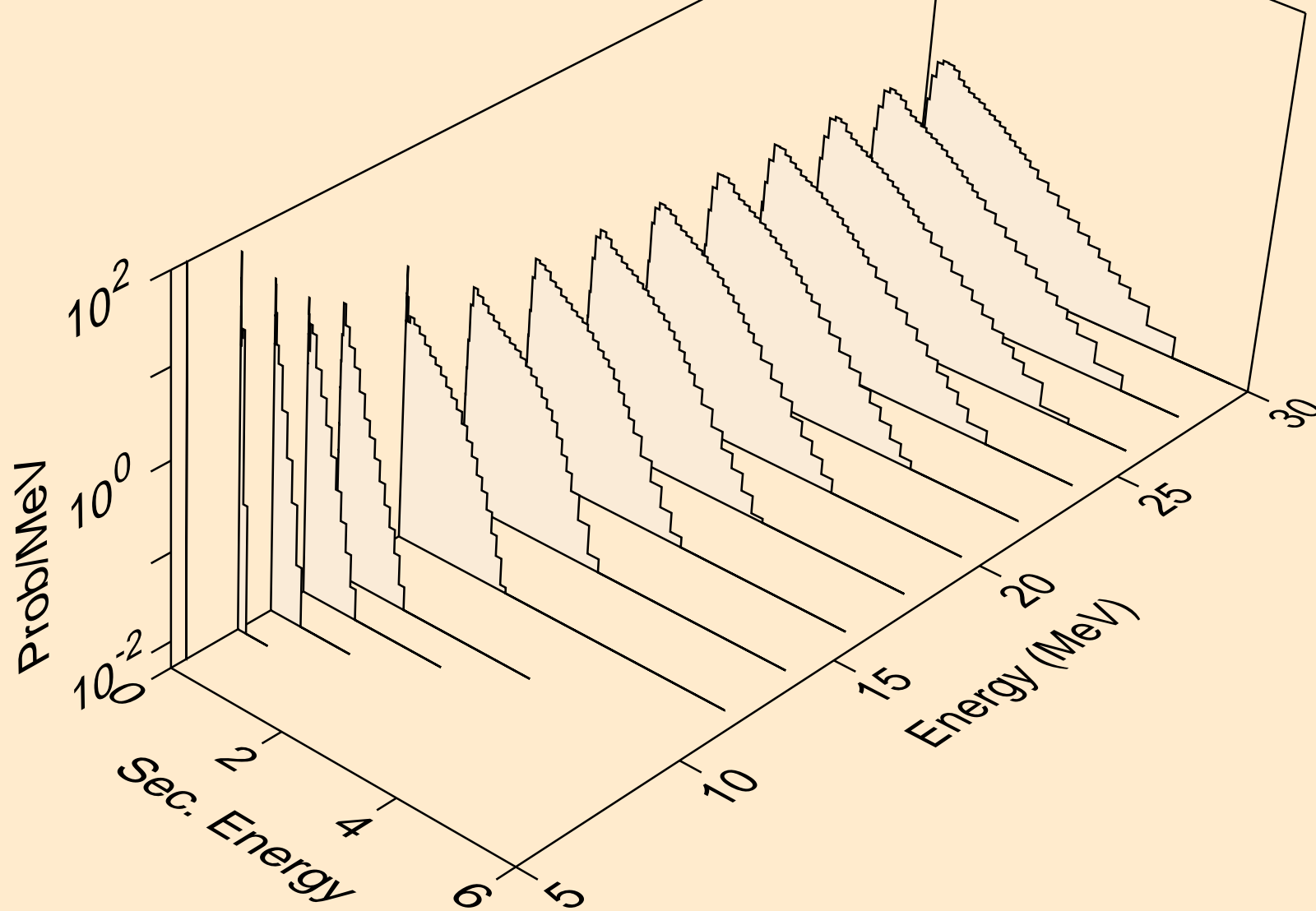



AG118M TRITON ACER TENDL-2021 LIBRARY; T=0.K  
neutrons from (t,n\*)he3

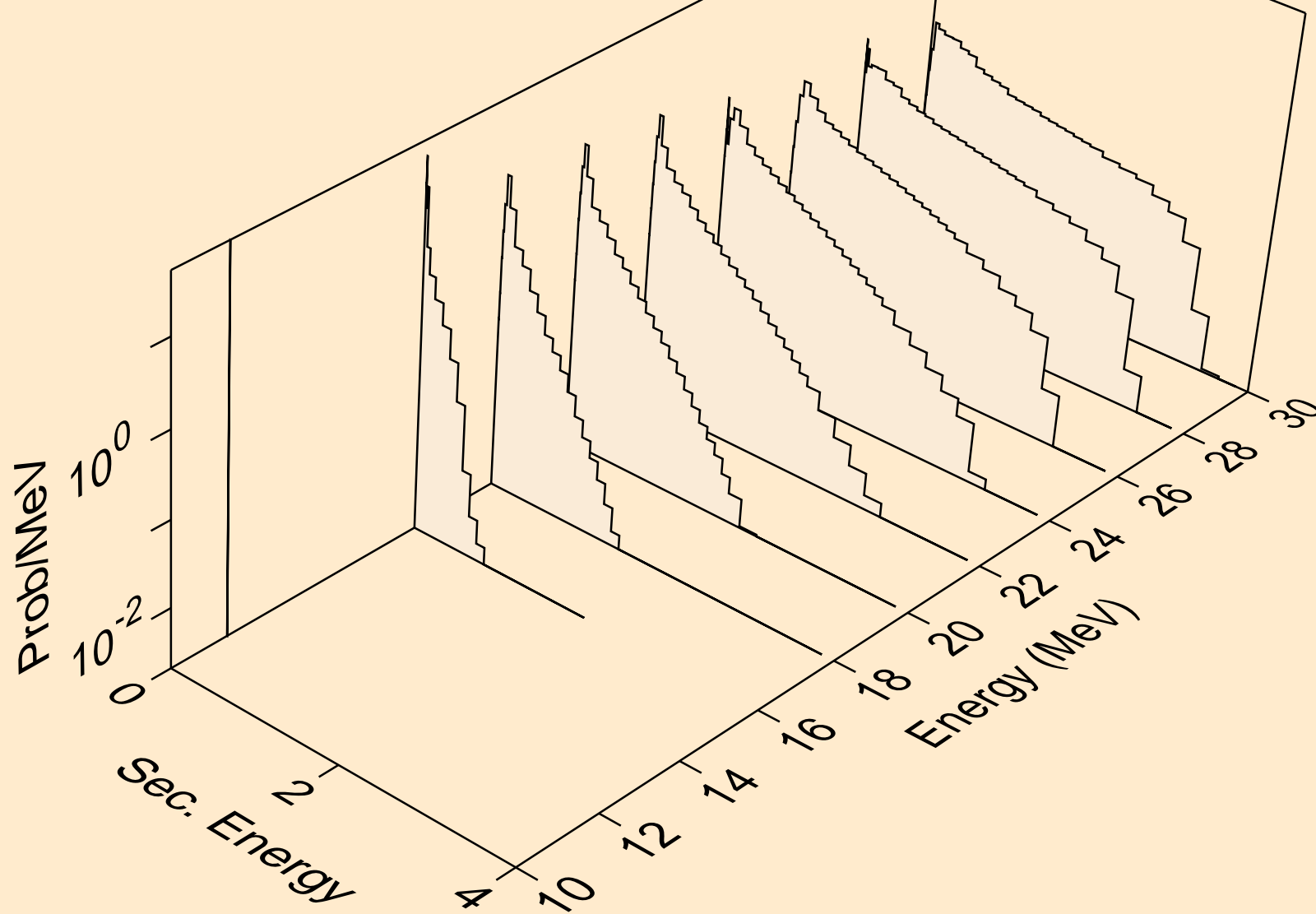

AG118M TRITON ACER TENDL-2021 LIBRARY; T=0.K  
neutrons from (t,4n)

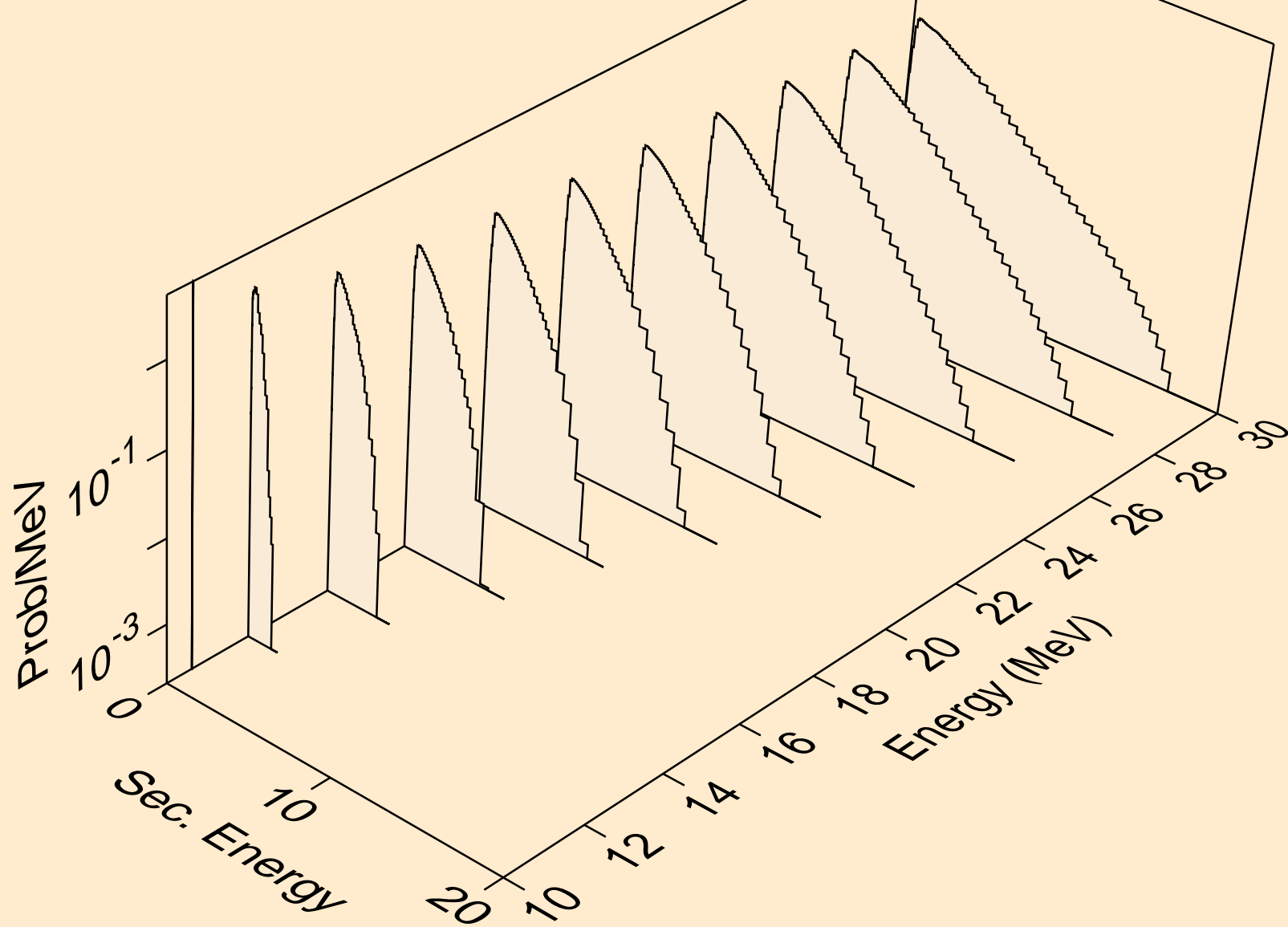

AG118M TRITON ACER TENDL-2021 LIBRARY; T=0.K  
neutrons from (t,2np)

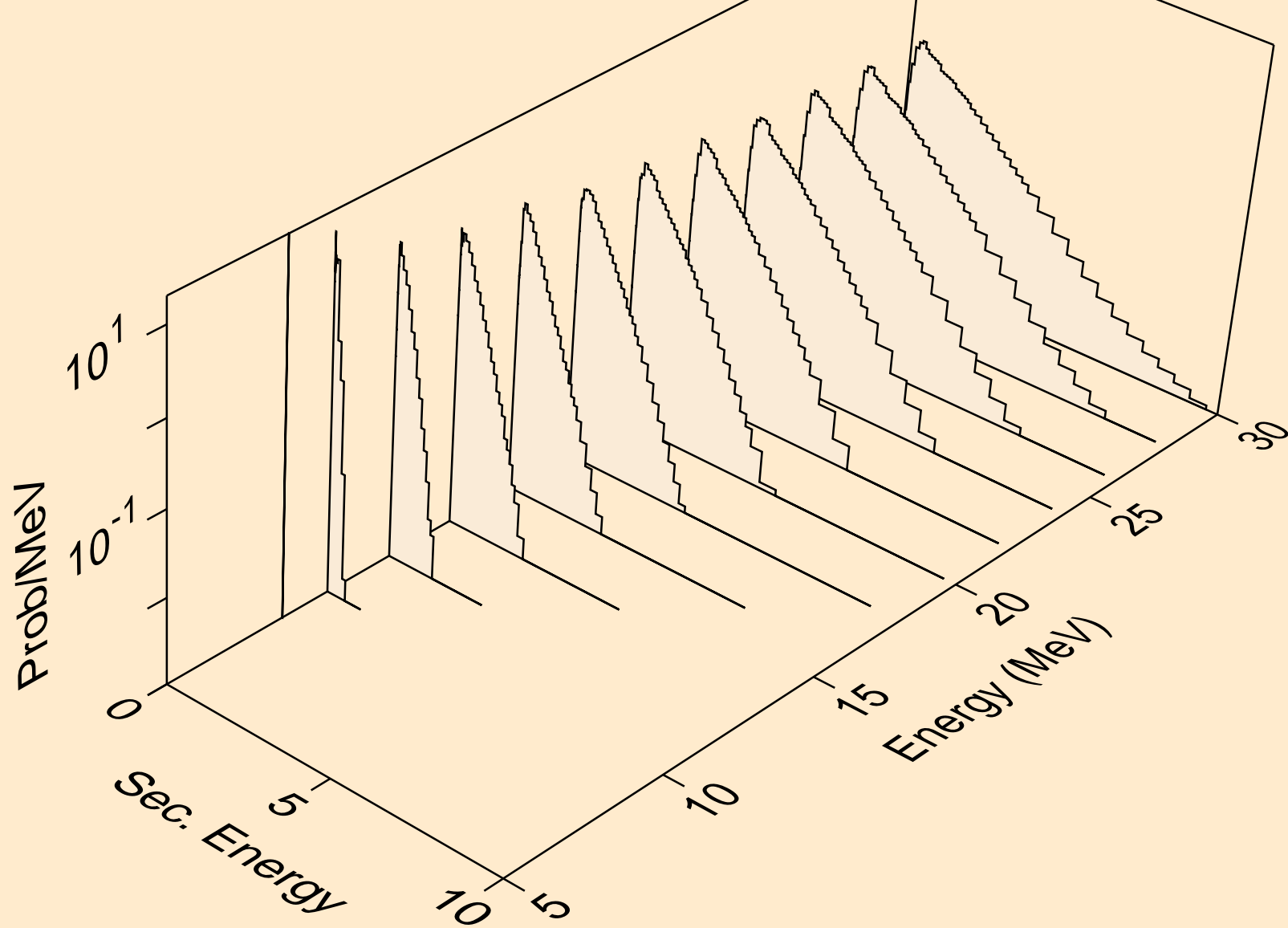

AG118M TRITON ACER TENDL-2021 LIBRARY; T=0.K  
neutrons from (t,3np)

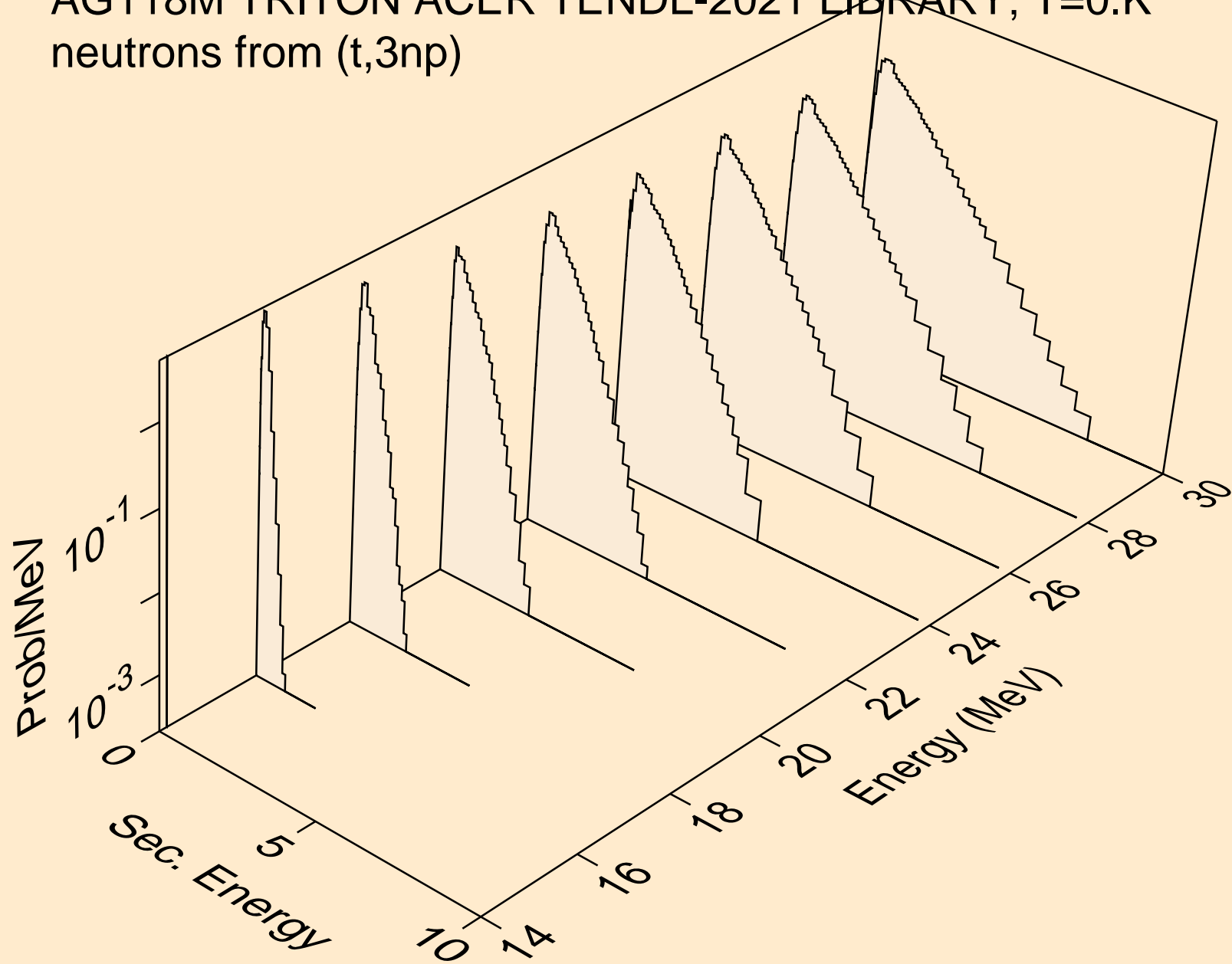

AG118M TRITON ACER TENDL-2021 LIBRARY; T=0.K  
neutrons from (t,2np)

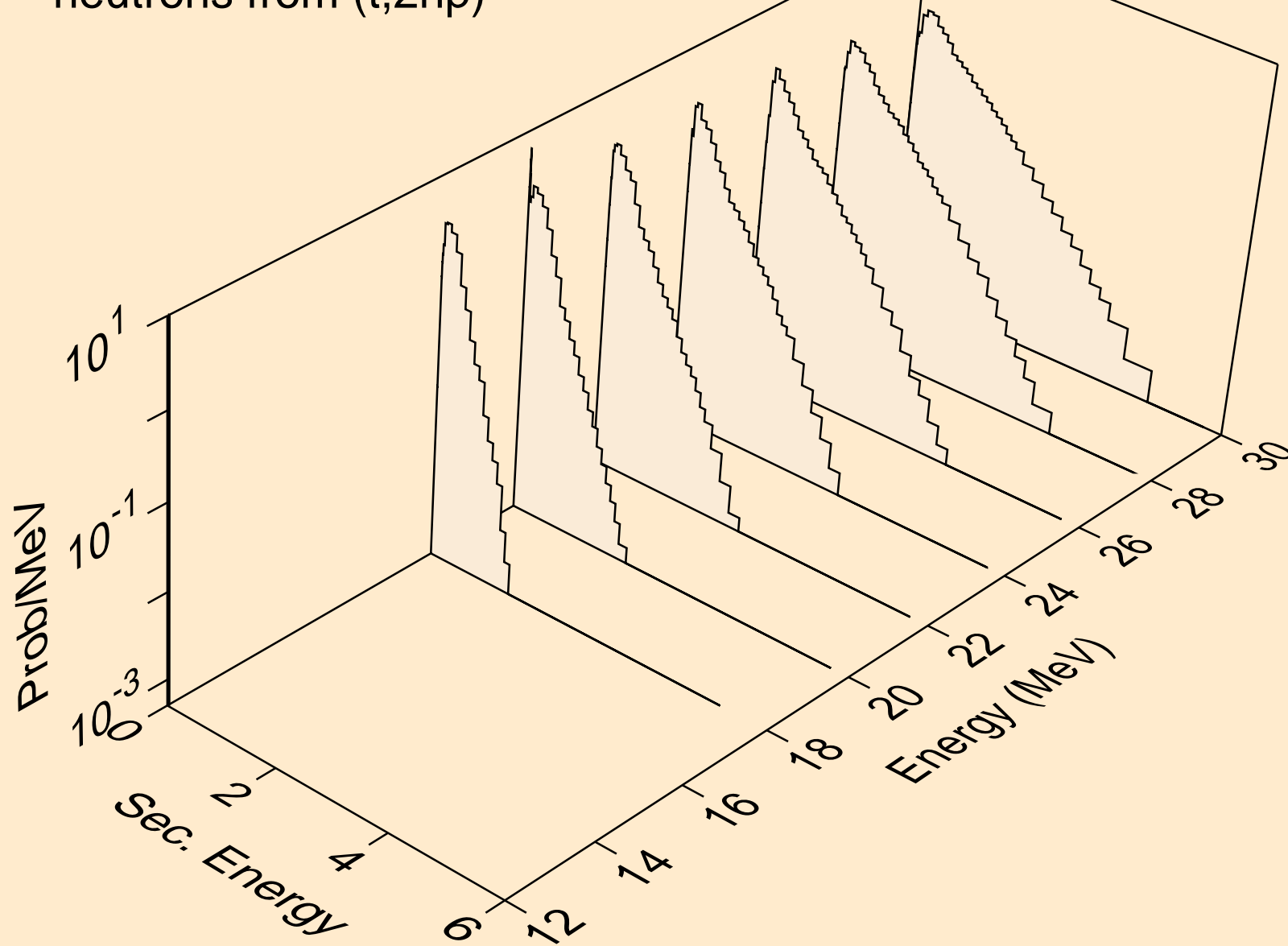

AG118M TRITON ACER TENDL-2021 LIBRARY; T=0.K  
neutrons from (t,npa)

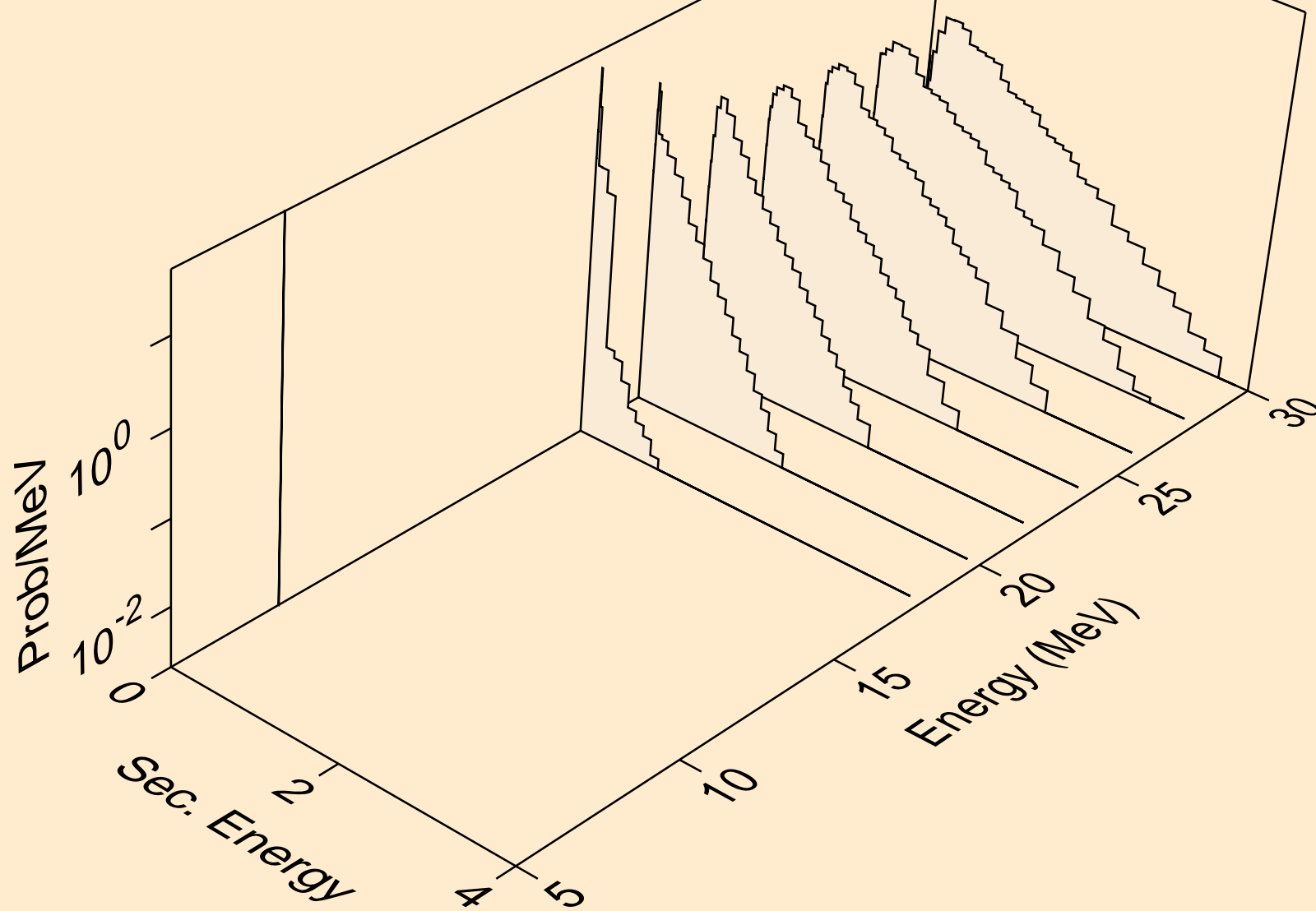

AG118M TRITON ACER TENDL-2021 LIBRARY; T=0.K  
protons from (t,x)

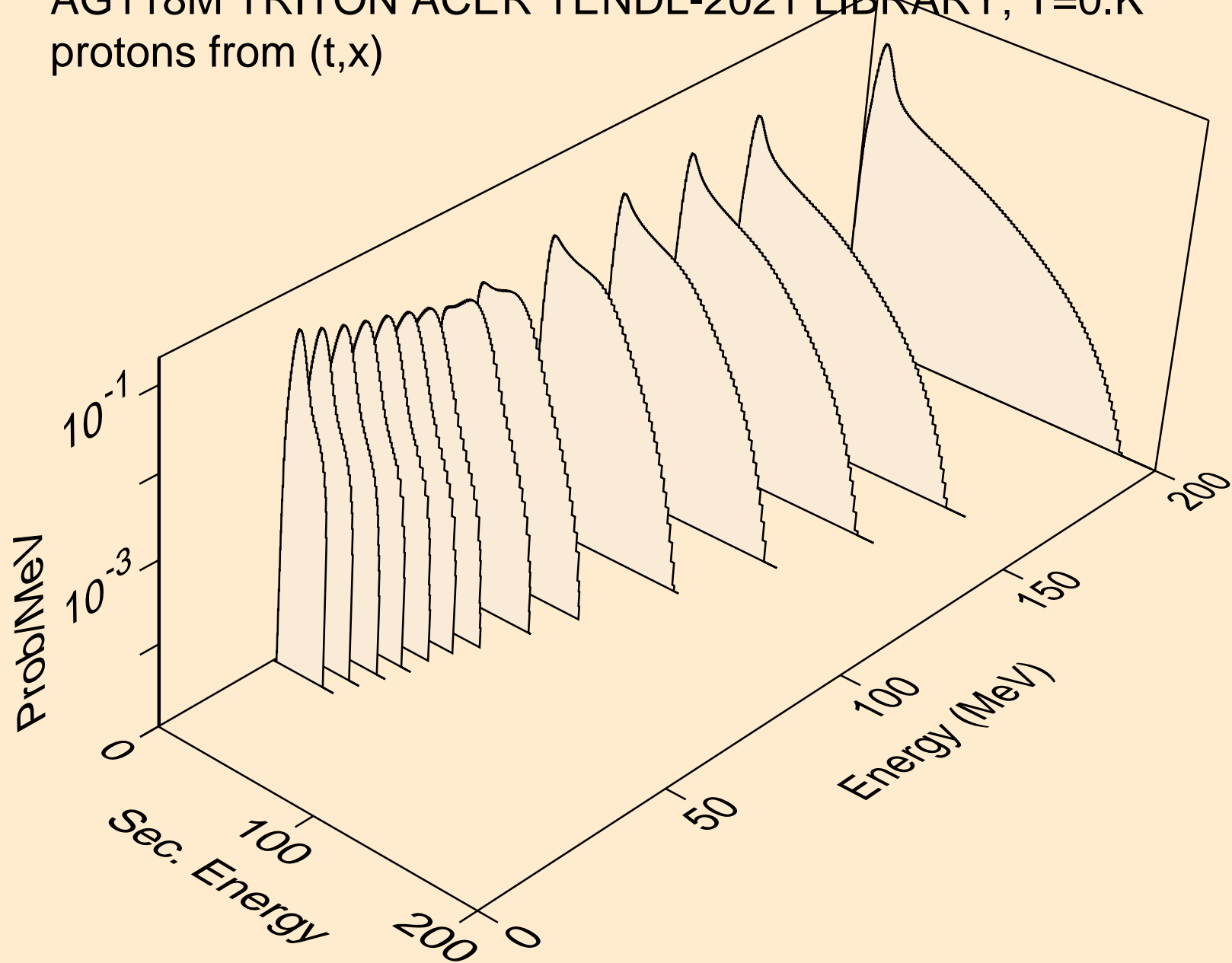

AG118M TRITON ACER TENDL-2021 LIBRARY; T=0.K  
protons from (t,n\*)p

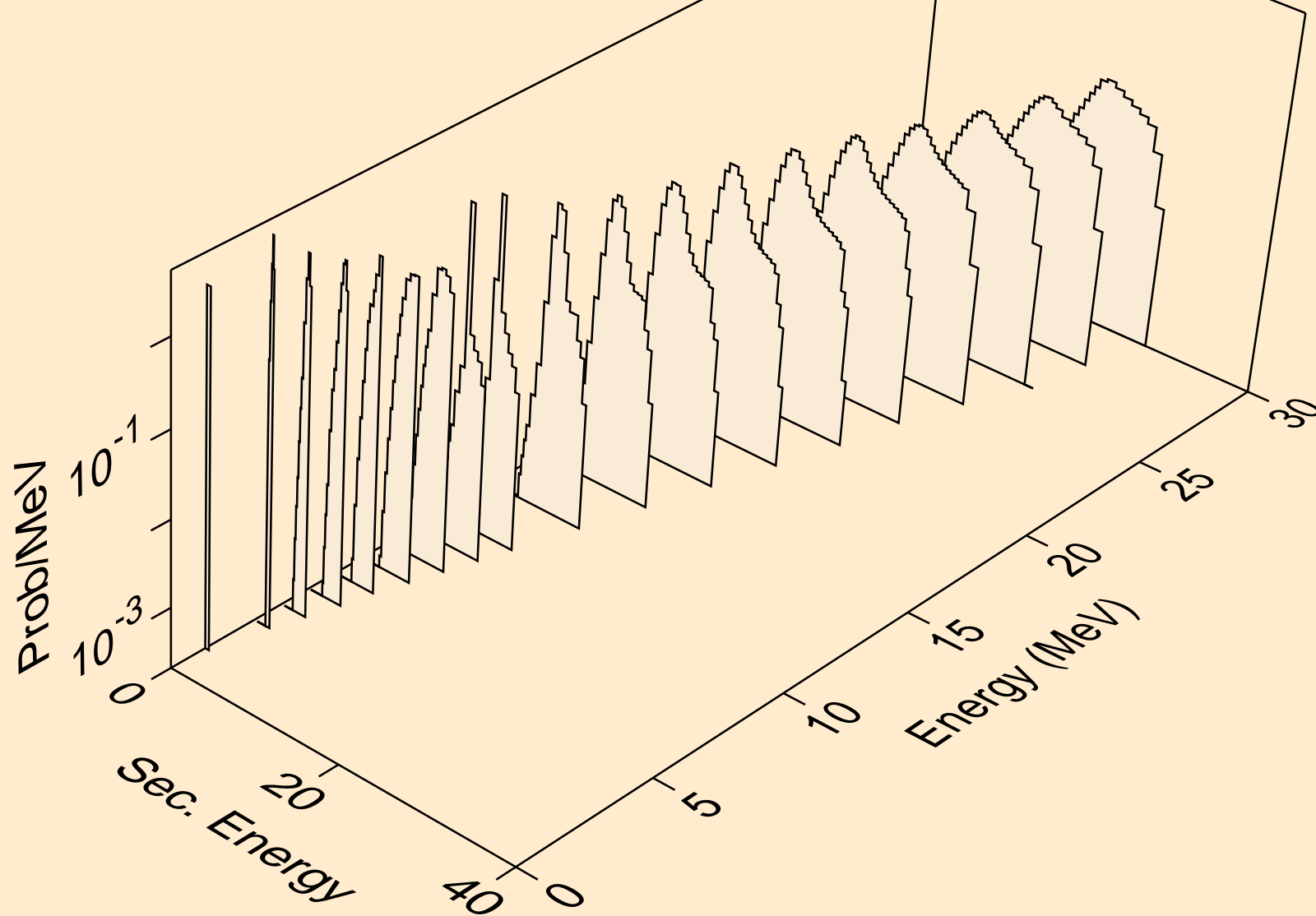



AG118M TRITON ACER TENDL-2021 LIBRARY; T=0.K  
protons from (t,2np)

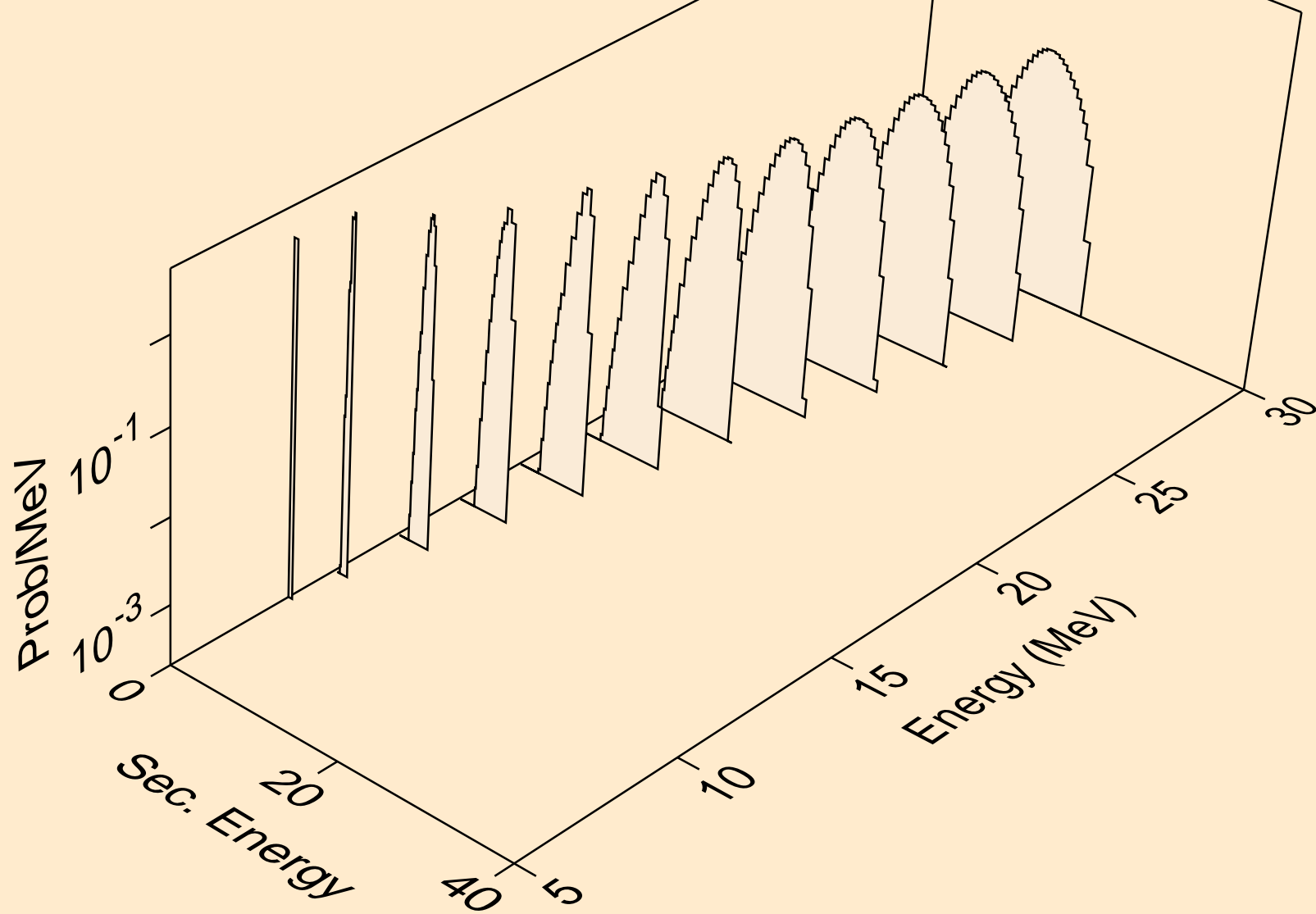

AG118M TRITON ACER TENDL-2021 LIBRARY; T=0.K  
protons from (t,3np)

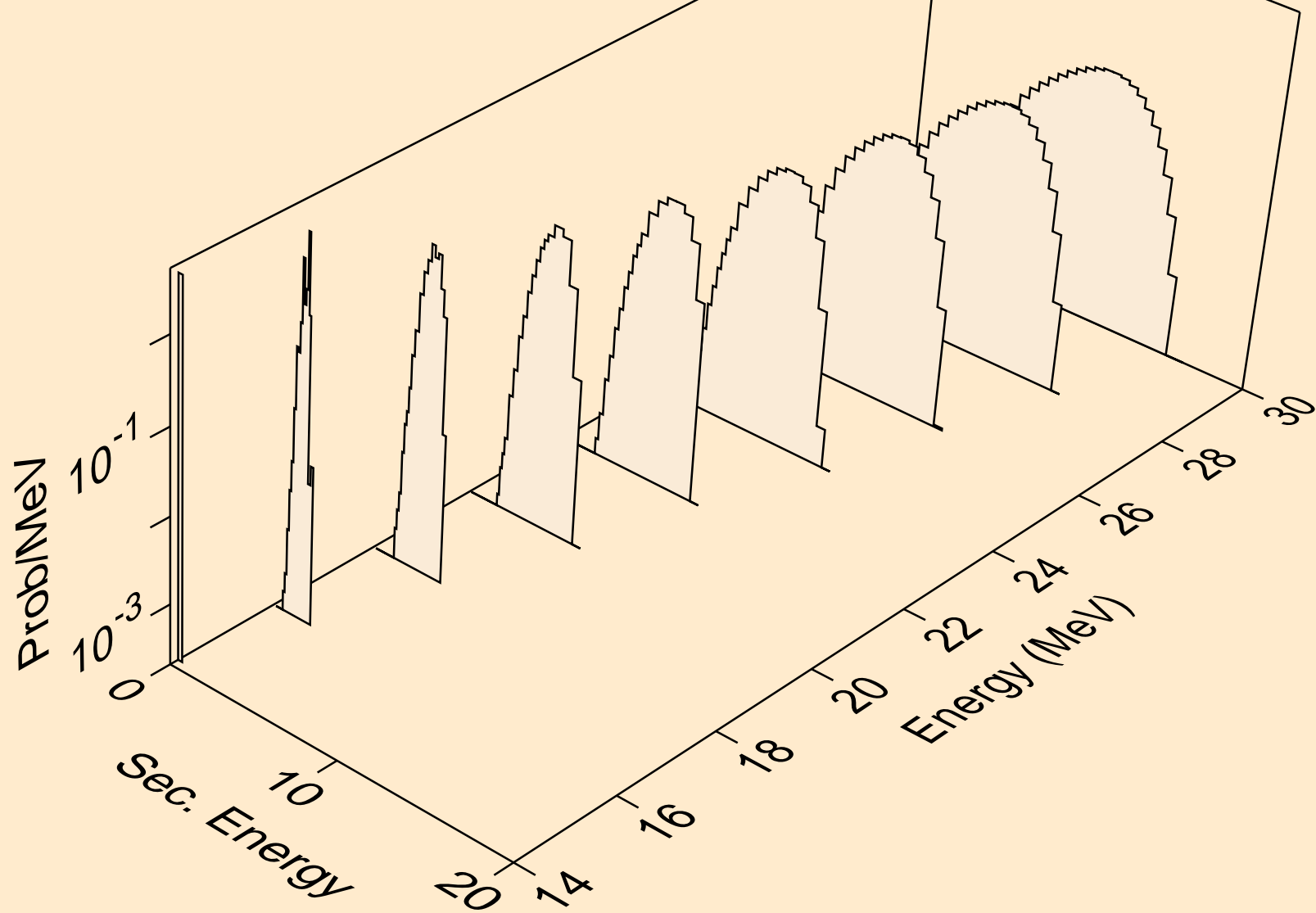

AG118M TRITON ACER TENDL-2021 LIBRARY; T=0.K  
protons from (t,2np)

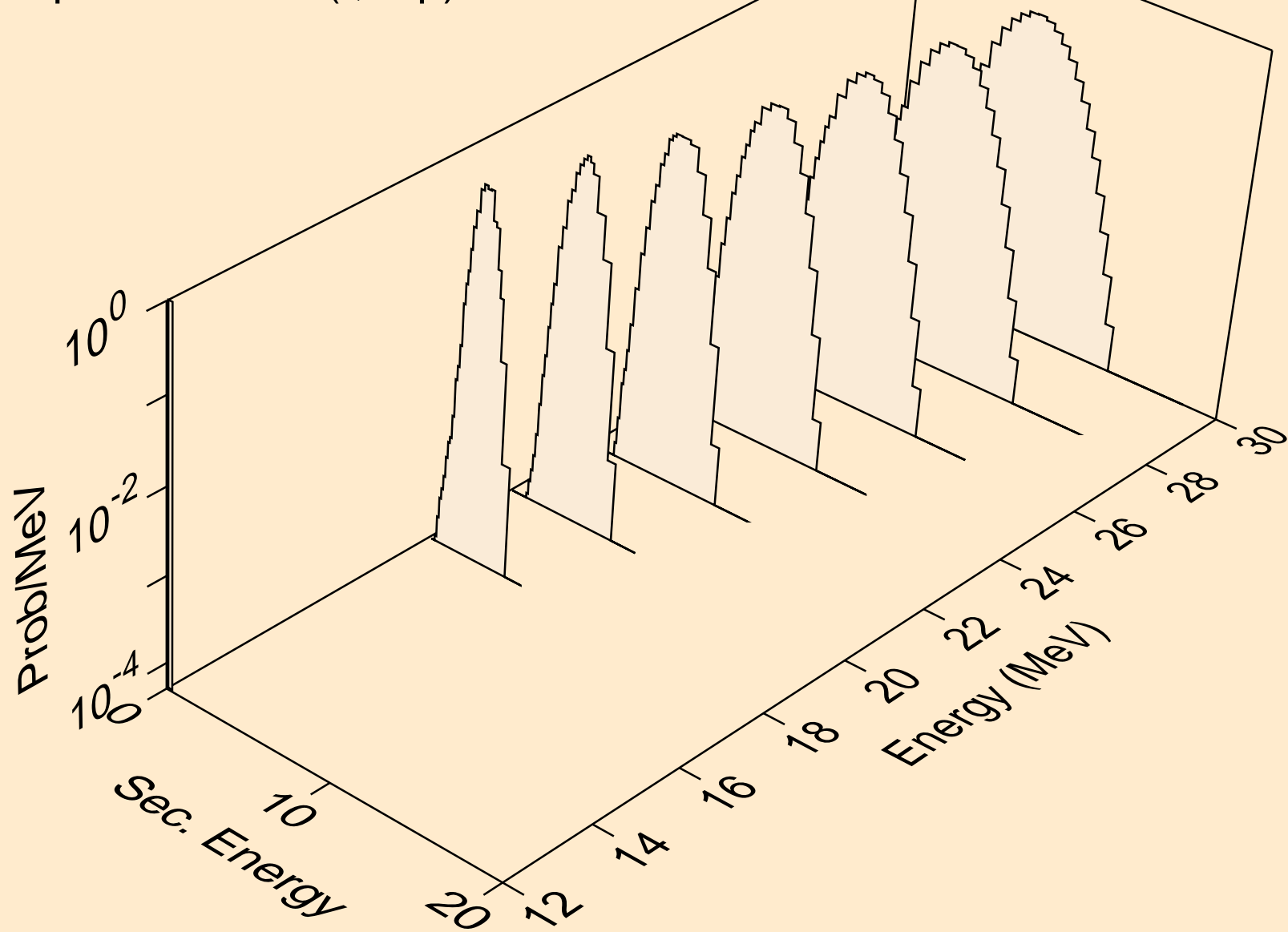

AG118M TRITON ACER TENDL-2021 LIBRARY; T=0.K  
protons from (t,npa)

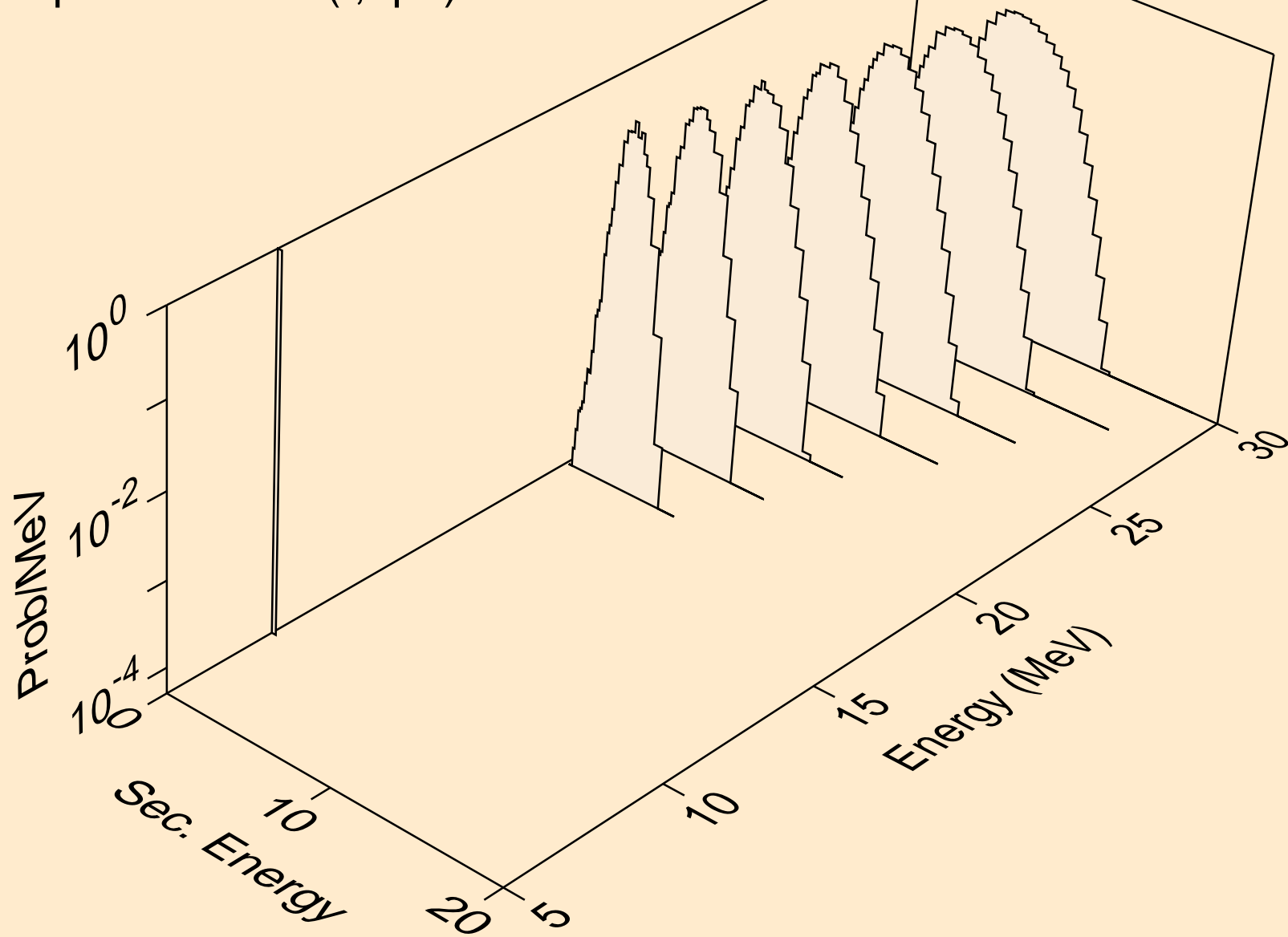

AG118M TRITON ACER TENDL-2021 LIBRARY; T=0.K  
protons from (t,p)

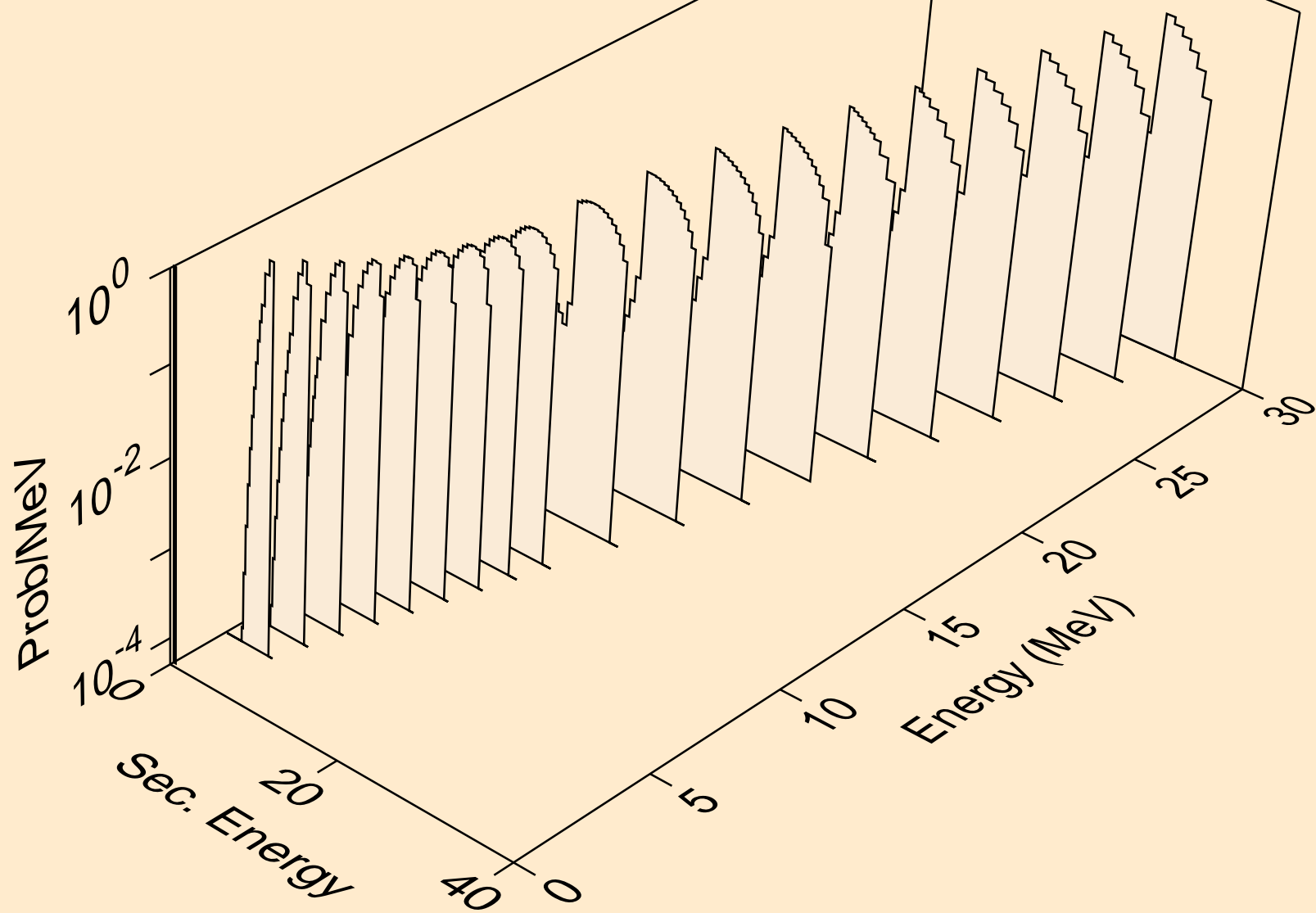

AG118M TRITON ACER TENDL-2021 LIBRARY; T=0.K  
protons from (t,2p)

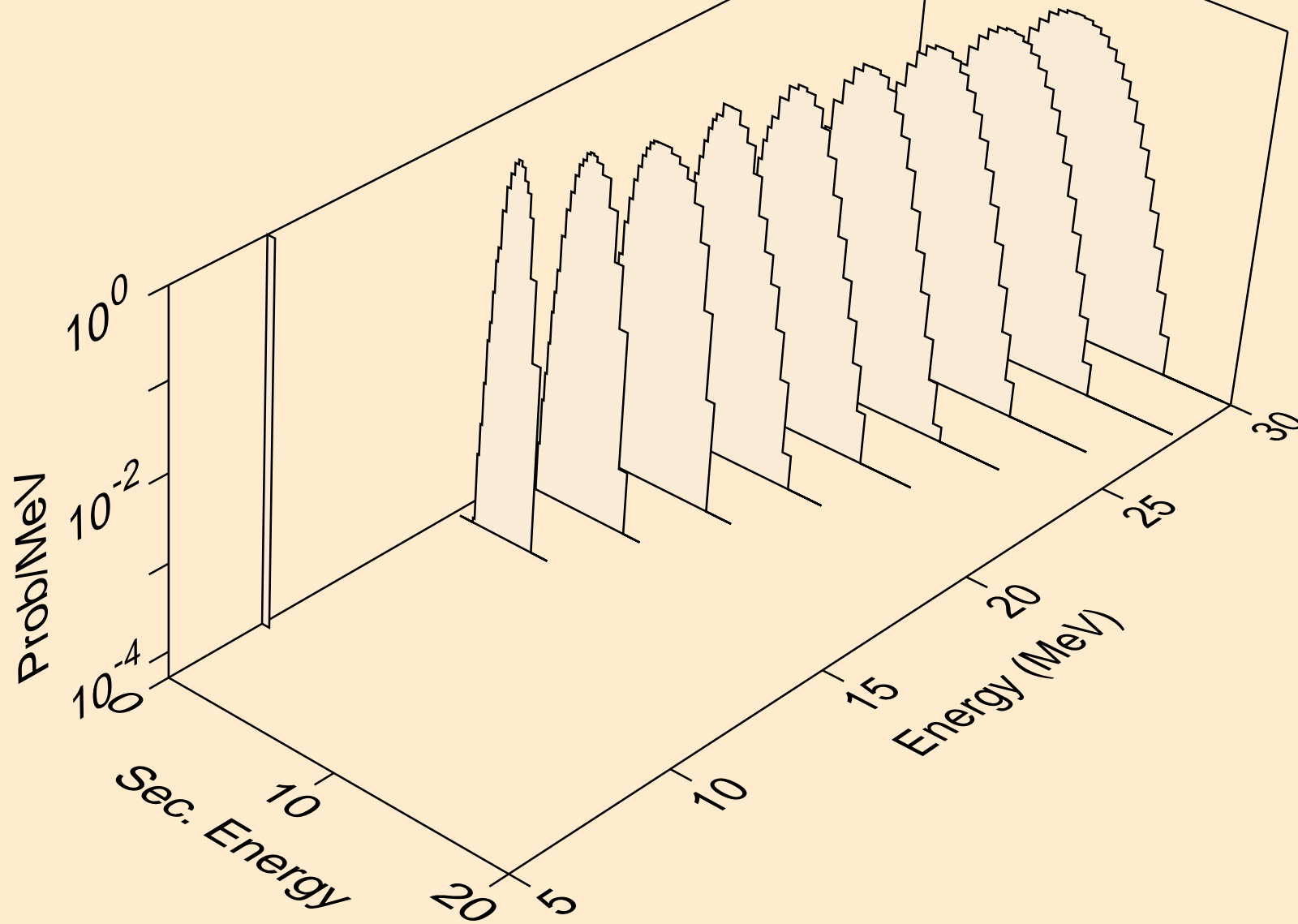

AG118M TRITON ACER TENDL-2021 LIBRARY; T=0.K  
protons from (t,pa)

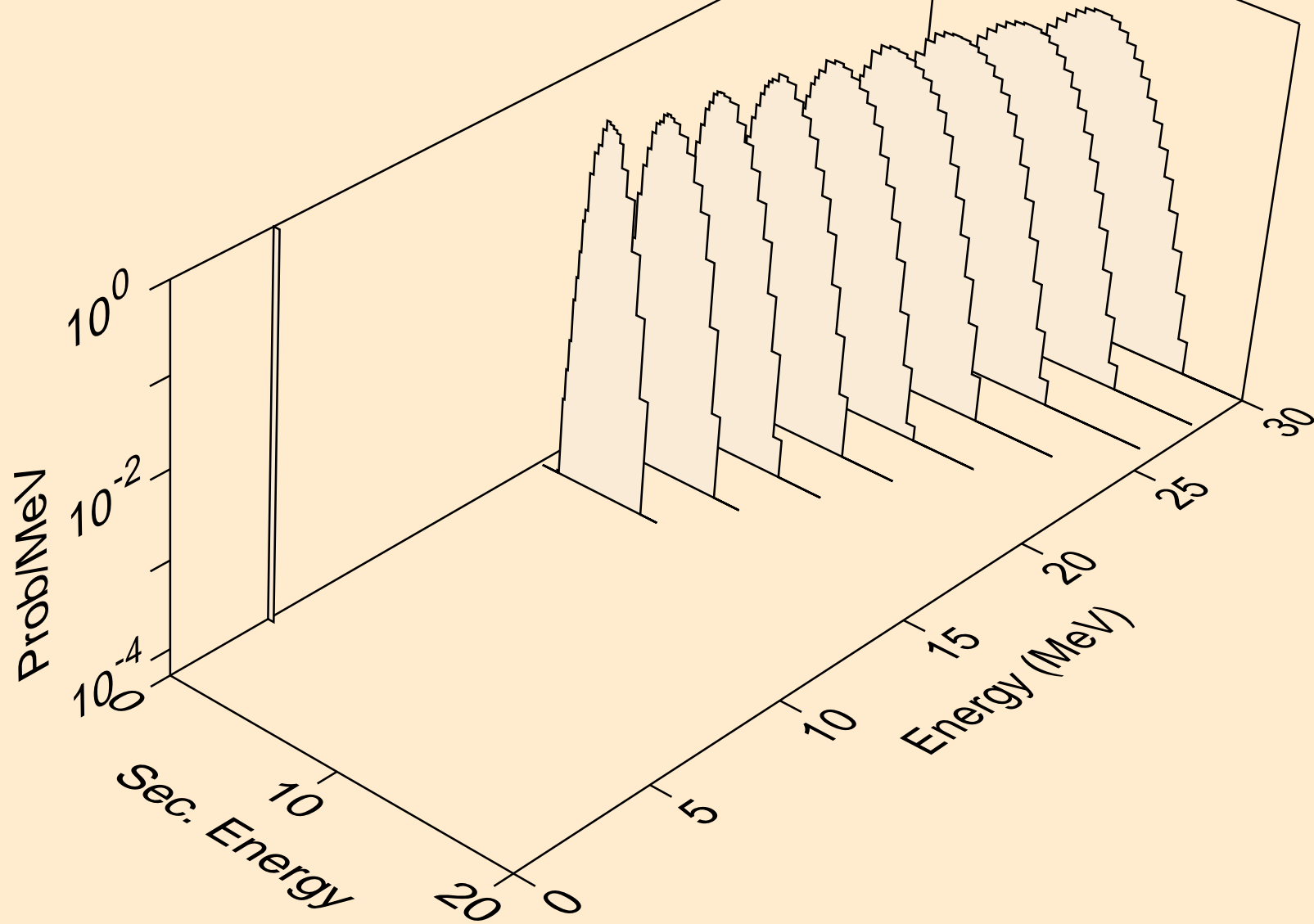

AG118M TRITON ACER TENDL-2021 LIBRARY; T=0.K  
protons from (t,pd)

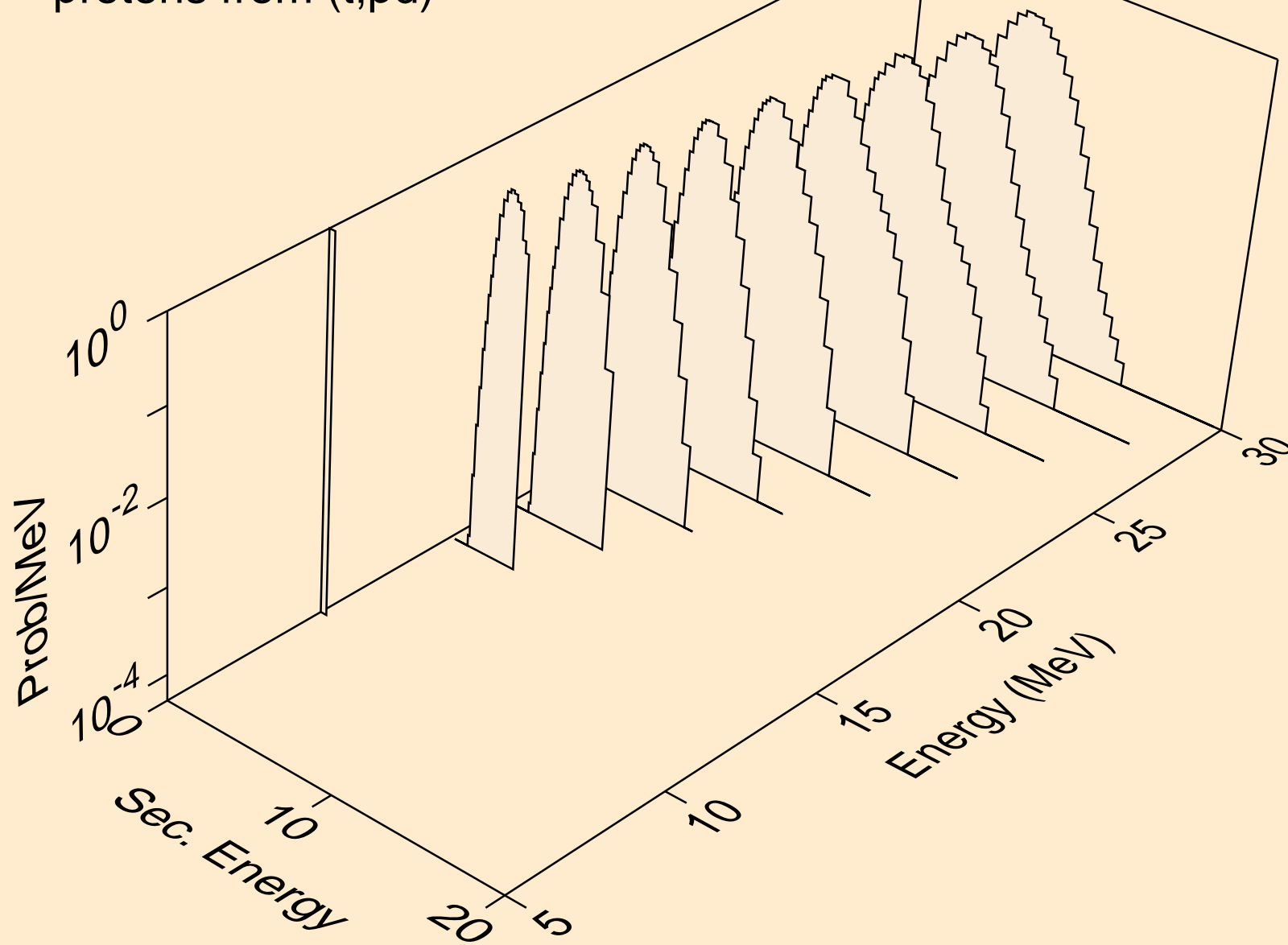



AG118M TRITON ACER TENDL-2021 LIBRARY; T=0.K  
protons from (t,pt)

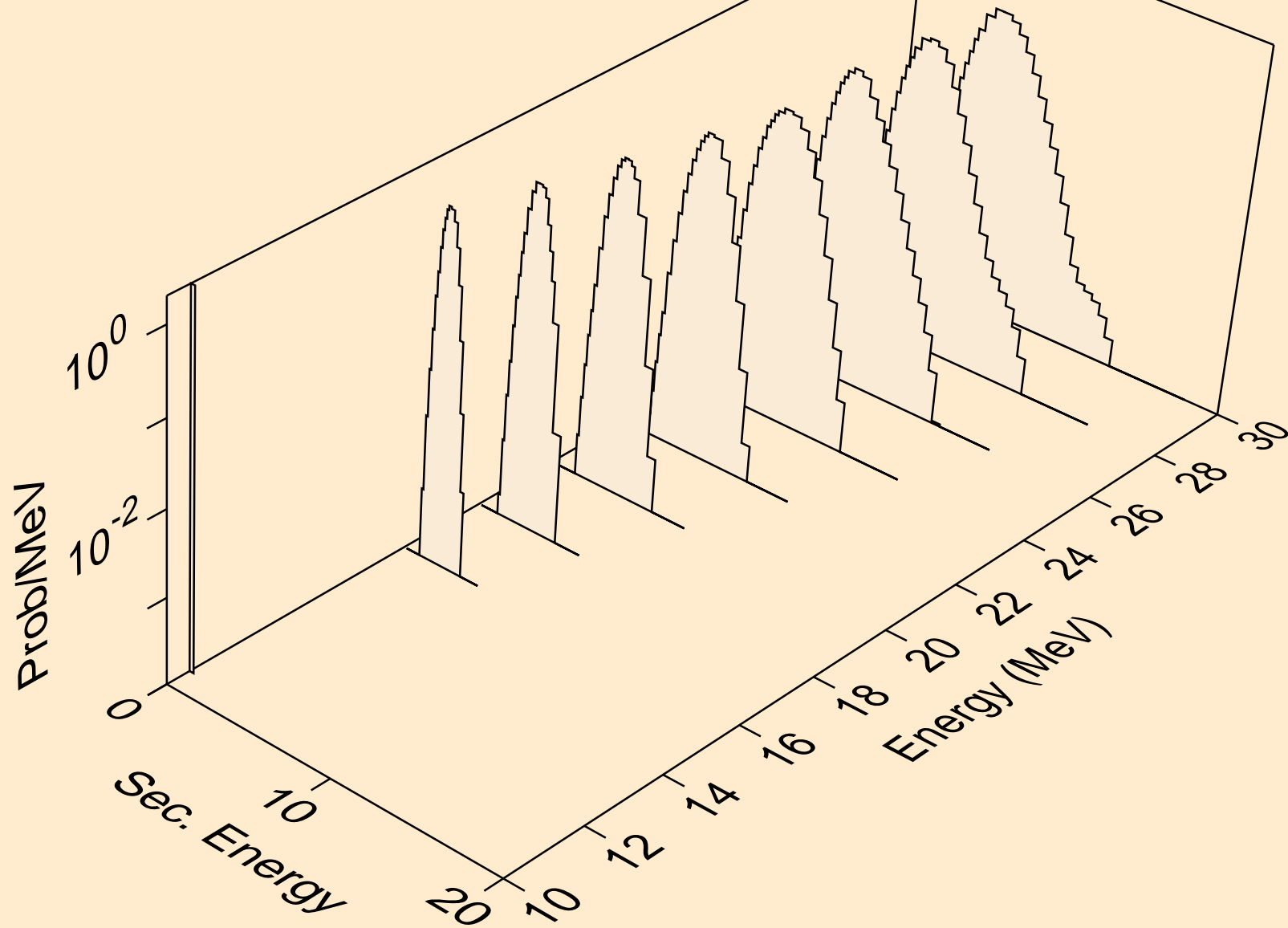

AG118M TRITON ACER TENDL-2021 LIBRARY; T=0.K  
deuterons from (t,x)

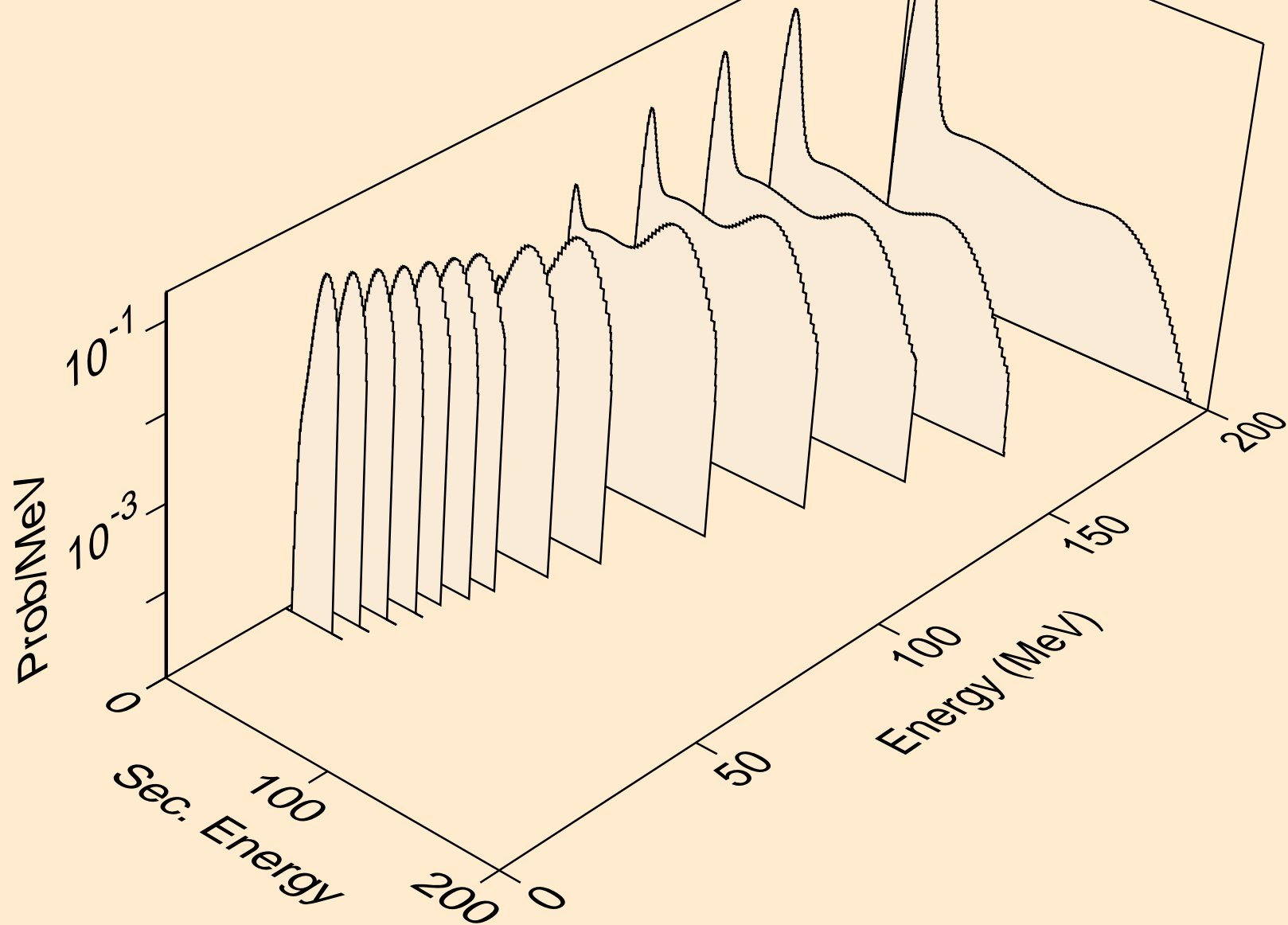

AG118M TRITON ACER TENDL-2021 LIBRARY; T=0.K  
deuterons from (t,2nd)

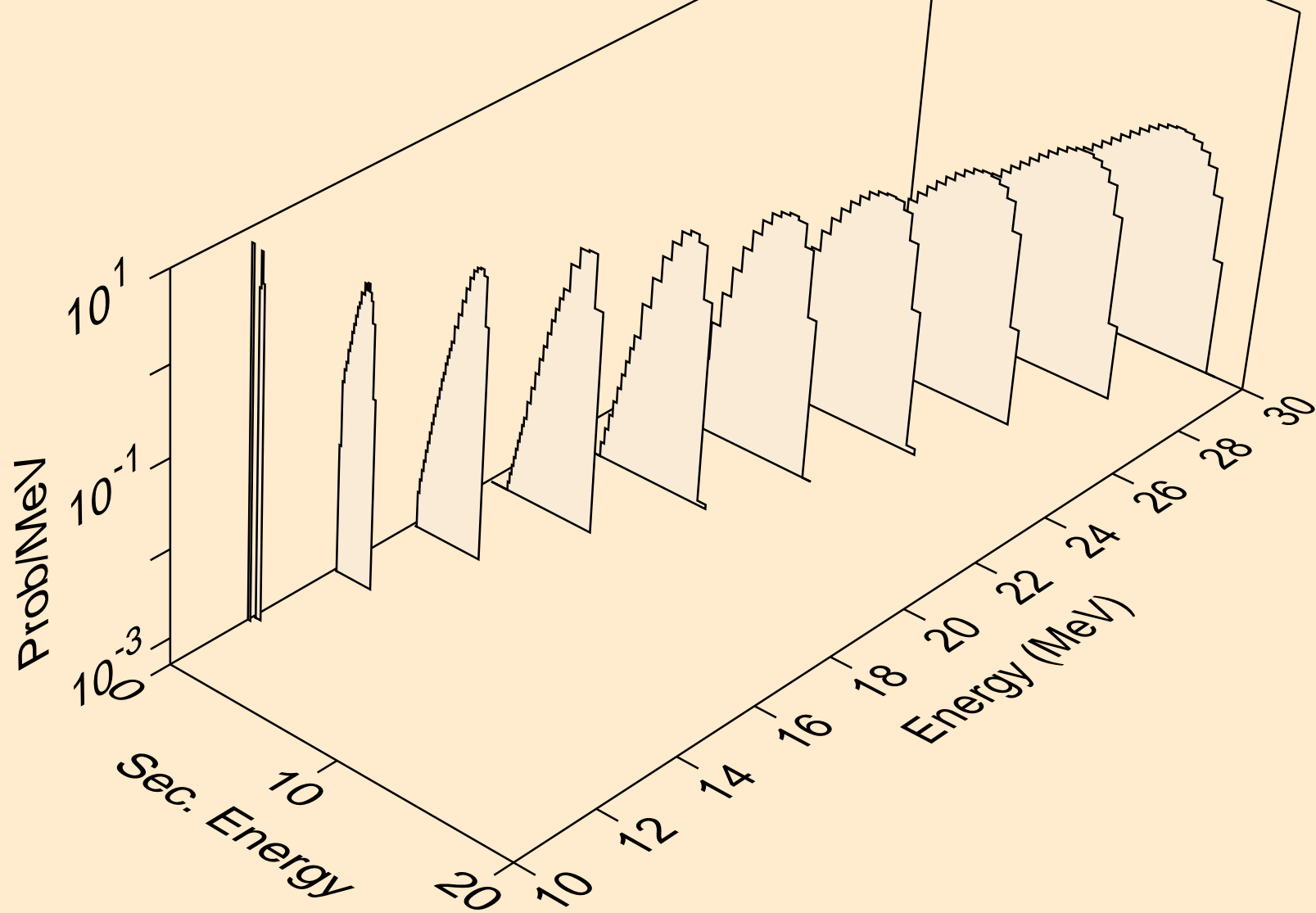

AG118M TRITON ACER TENDL-2021 LIBRARY; T=0.K  
deuterons from (t,n\*)d

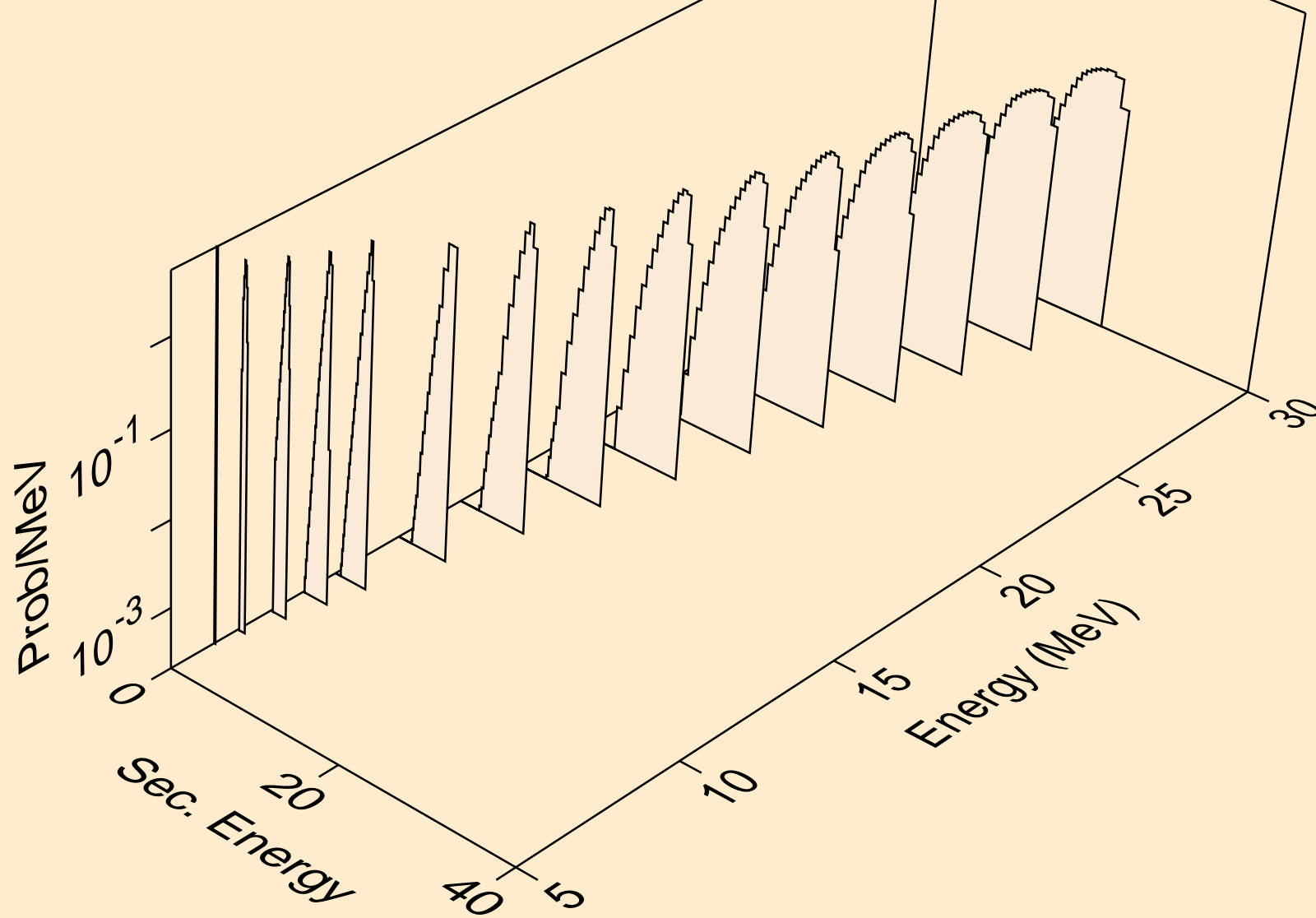

AG118M TRITON ACER TENDL-2021 LIBRARY; T=0.K  
deuterons from (t,d)

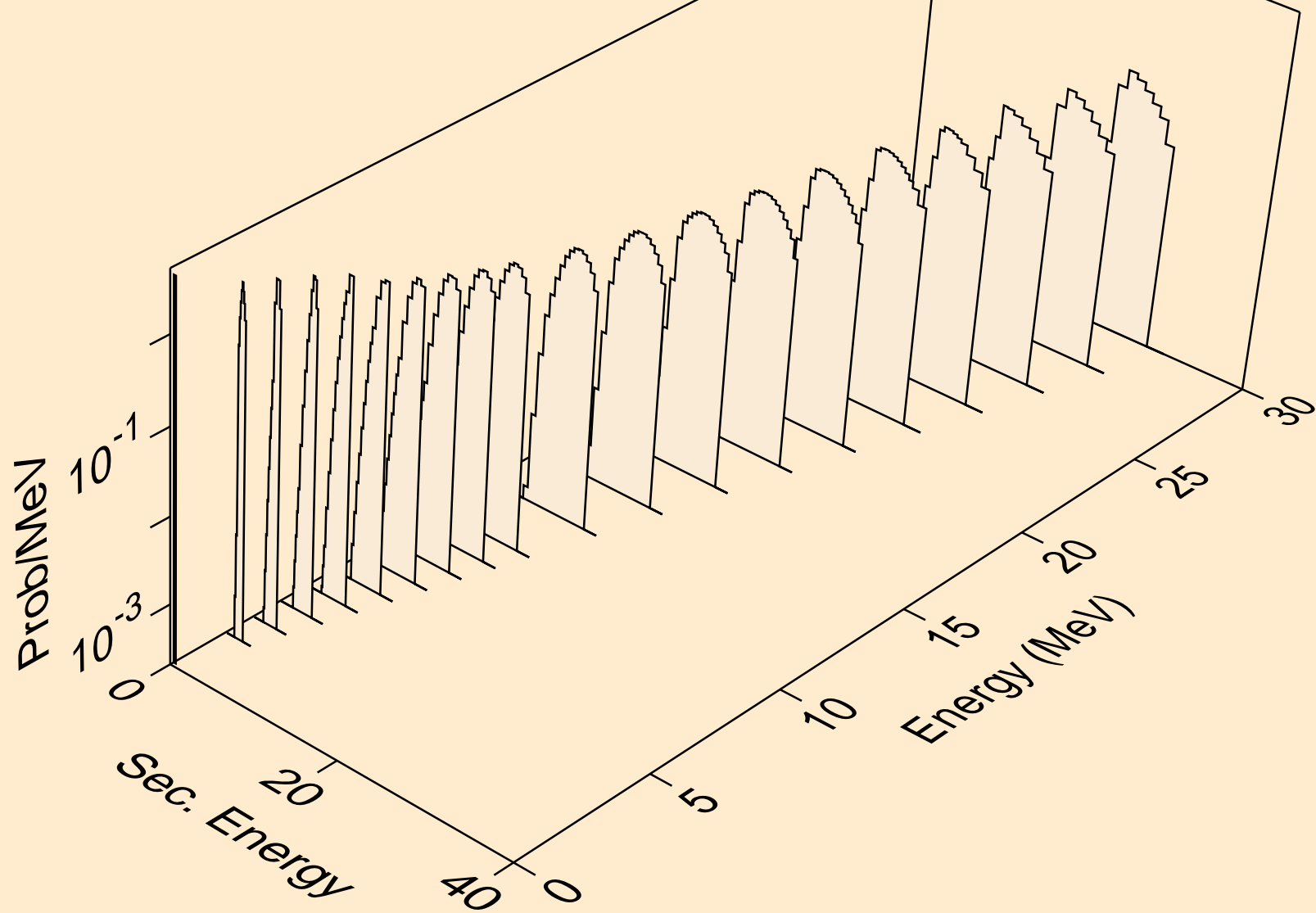

AG118M TRITON ACER TENDL-2021 LIBRARY; T=0.K  
deuterons from (t,pd)

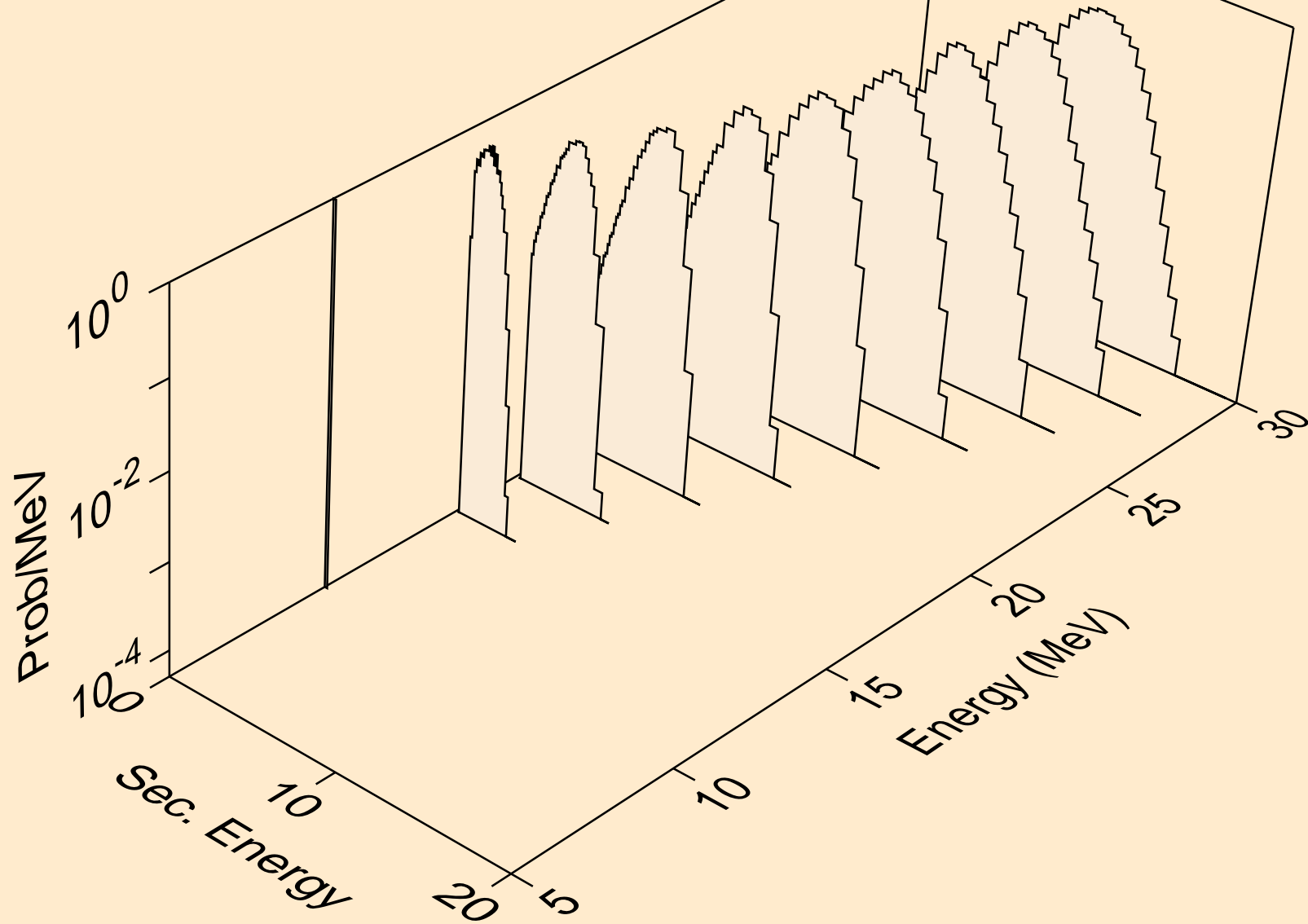

AG118M TRITON ACER TENDL-2021 LIBRARY; T=0.K  
he3s from (t,x)

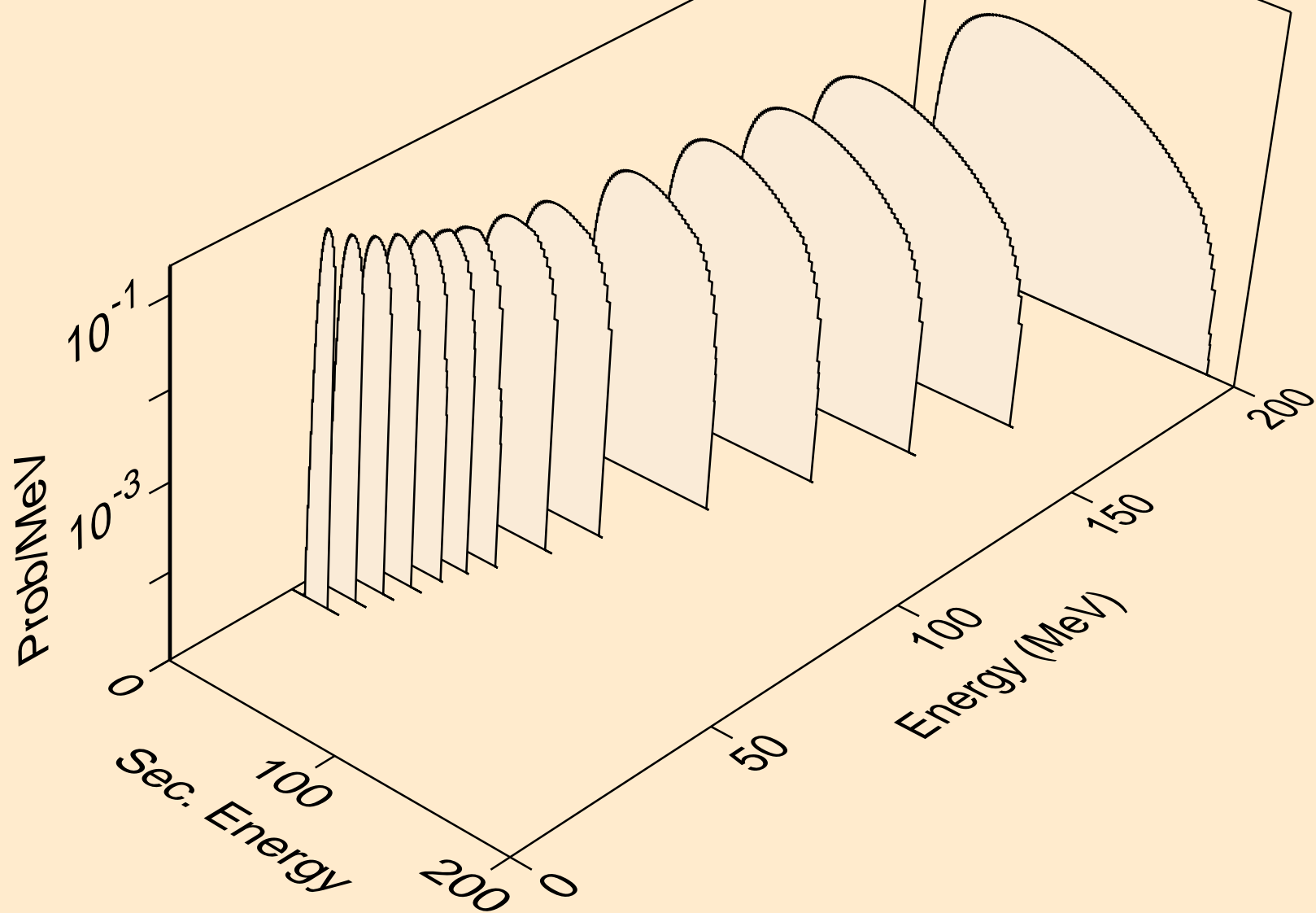

AG118M TRITON ACER TENDL-2021 LIBRARY; T=0.K  
he3s from (t,n\*)he3

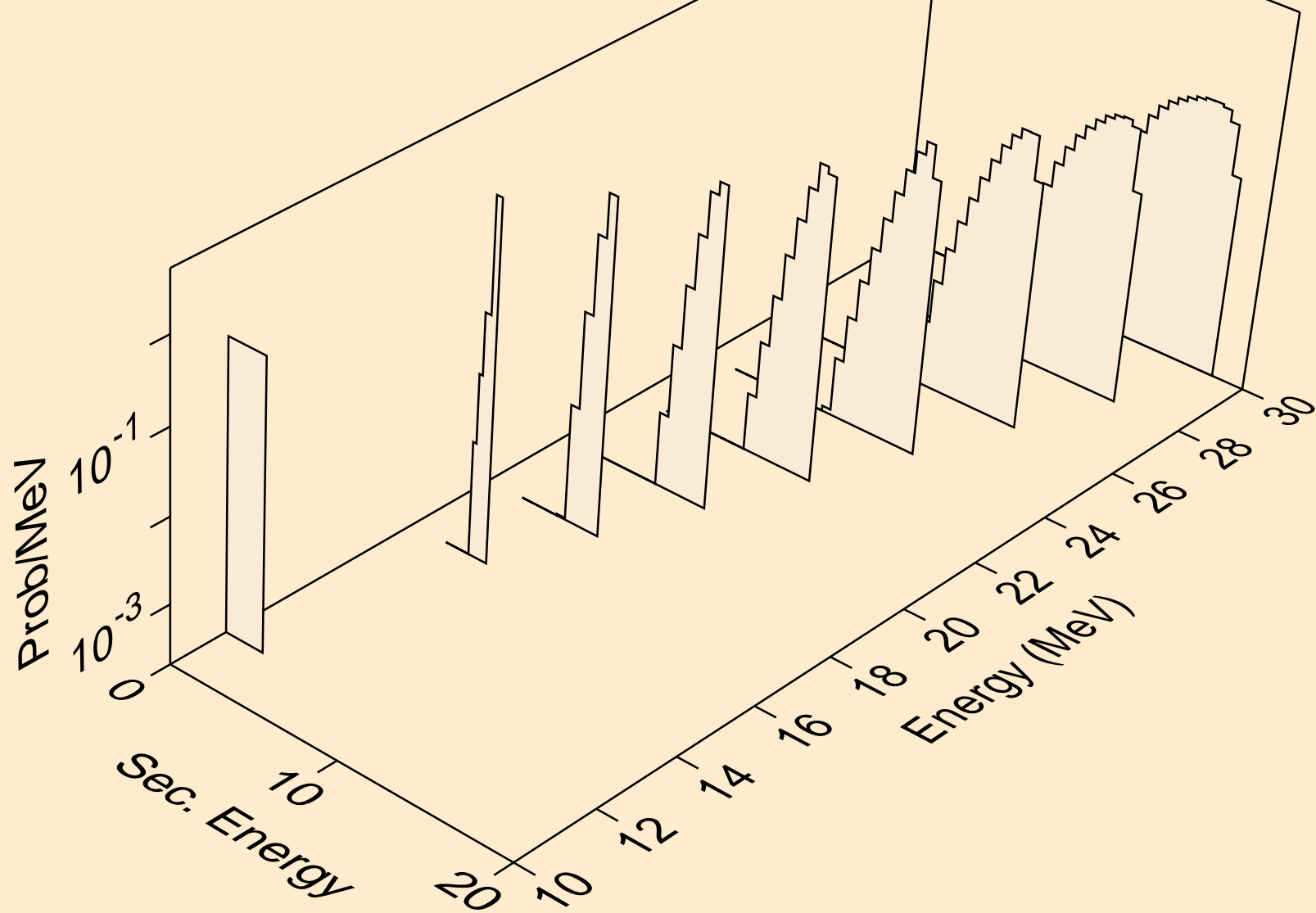



AG118M TRITON ACER TENDL-2021 LIBRARY; T=0.K  
he3s from (t,he3)

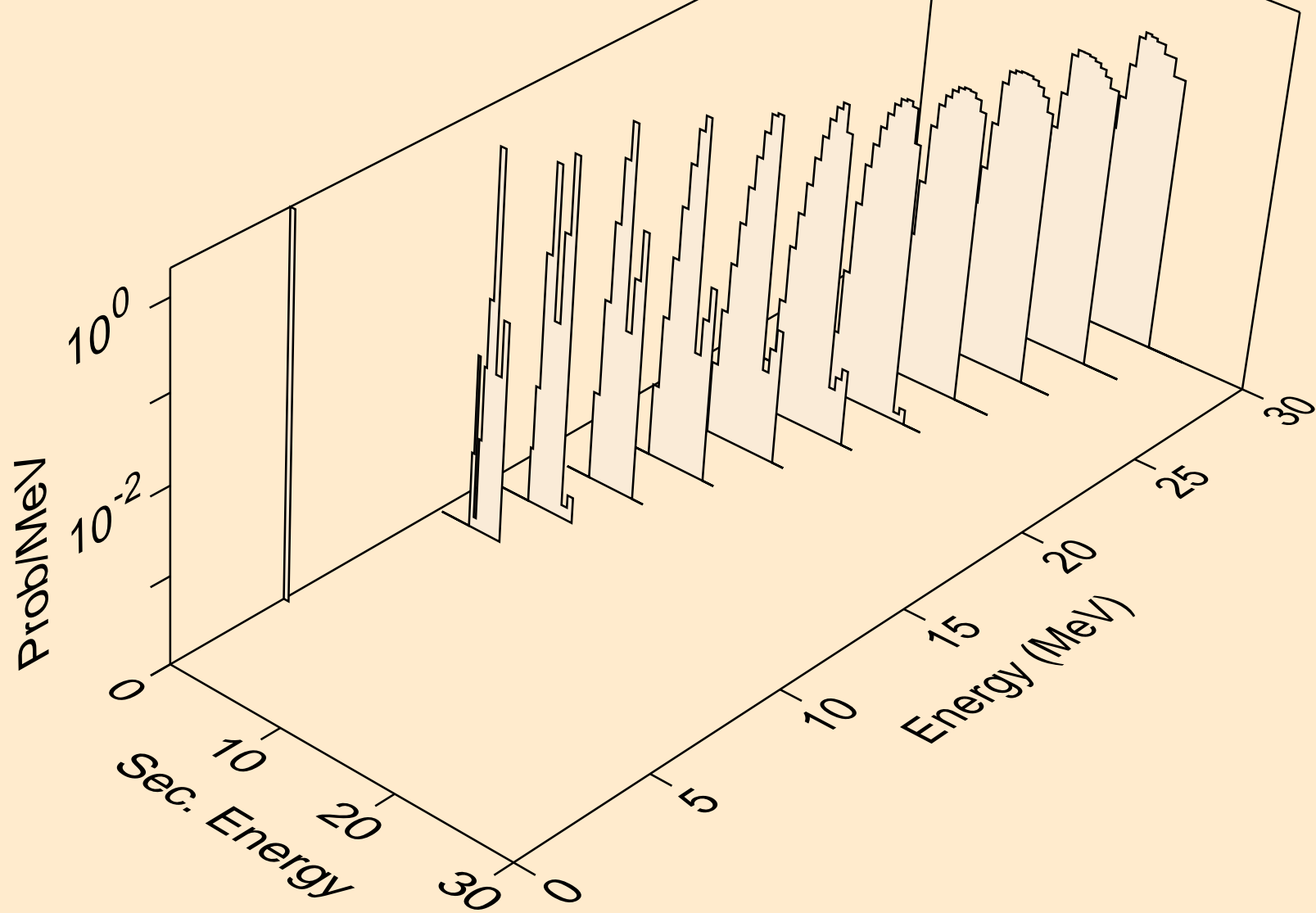

AG118M TRITON ACER TENDL-2021 LIBRARY; T=0.K  
alphas from (t,x)

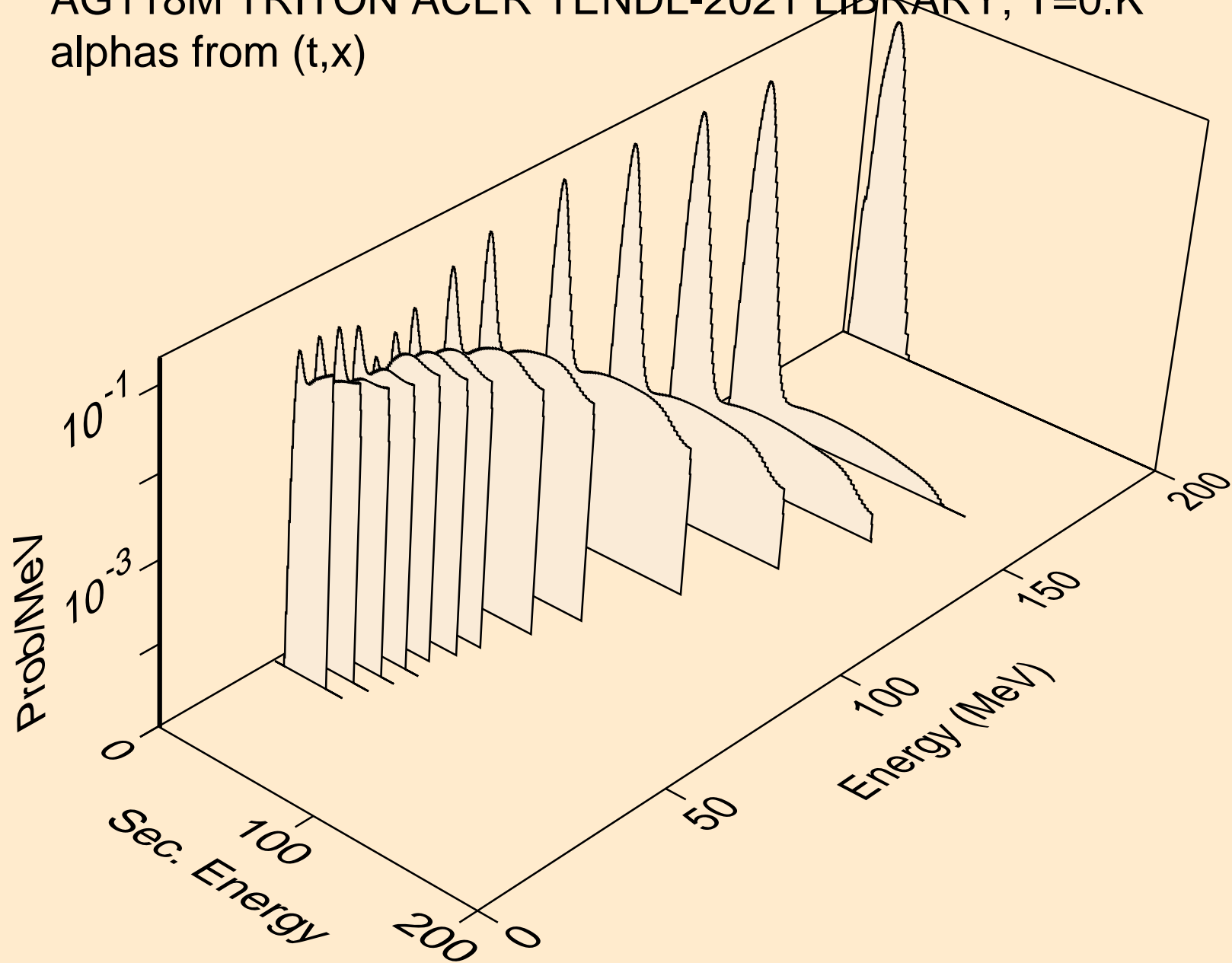

AG118M TRITON ACER TENDL-2021 LIBRARY; T=0.K  
alphas from (t,n\*)a

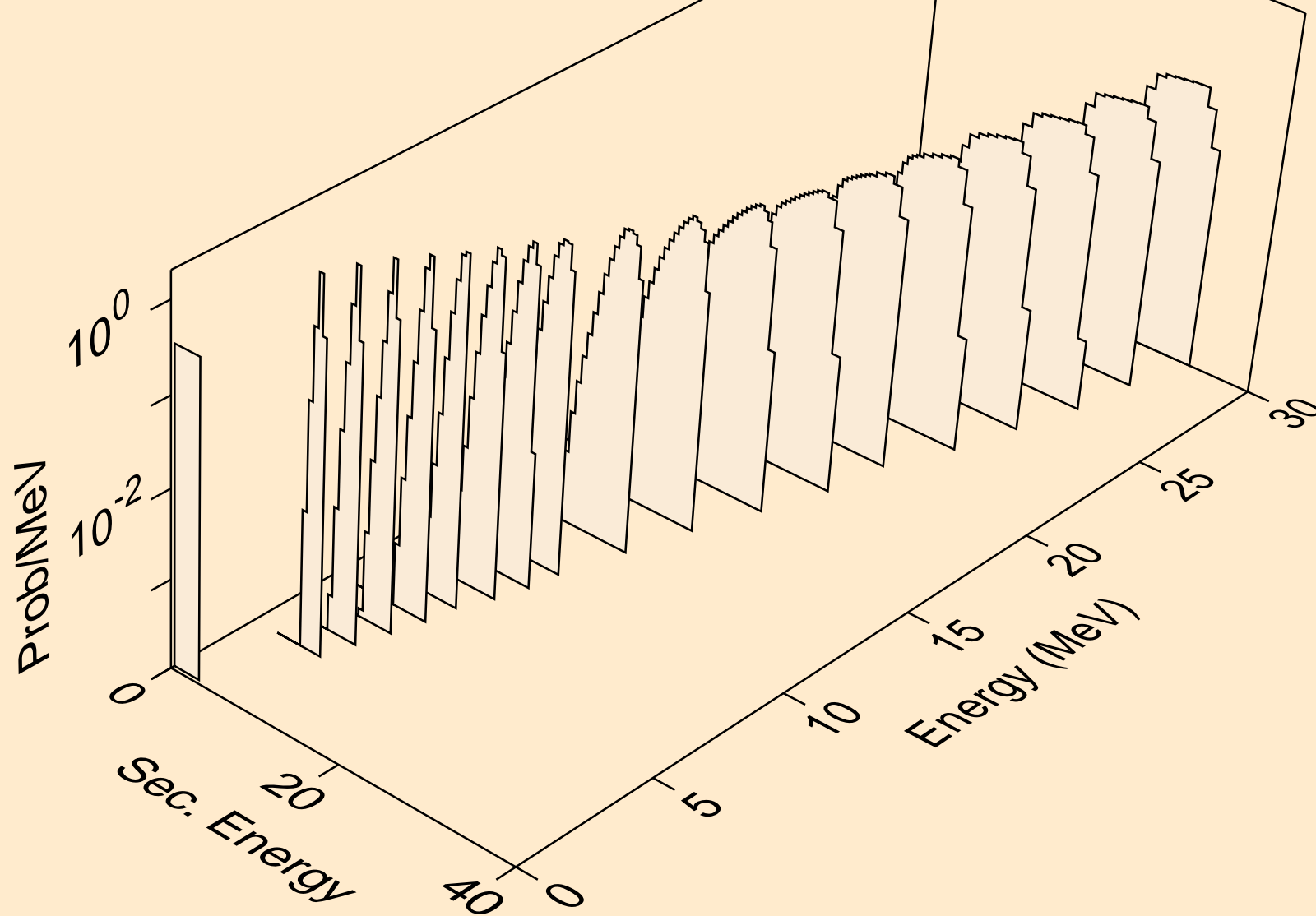

AG118M TRITON ACER TENDL-2021 LIBRARY; T=0.K  
alphas from (t,2n)a

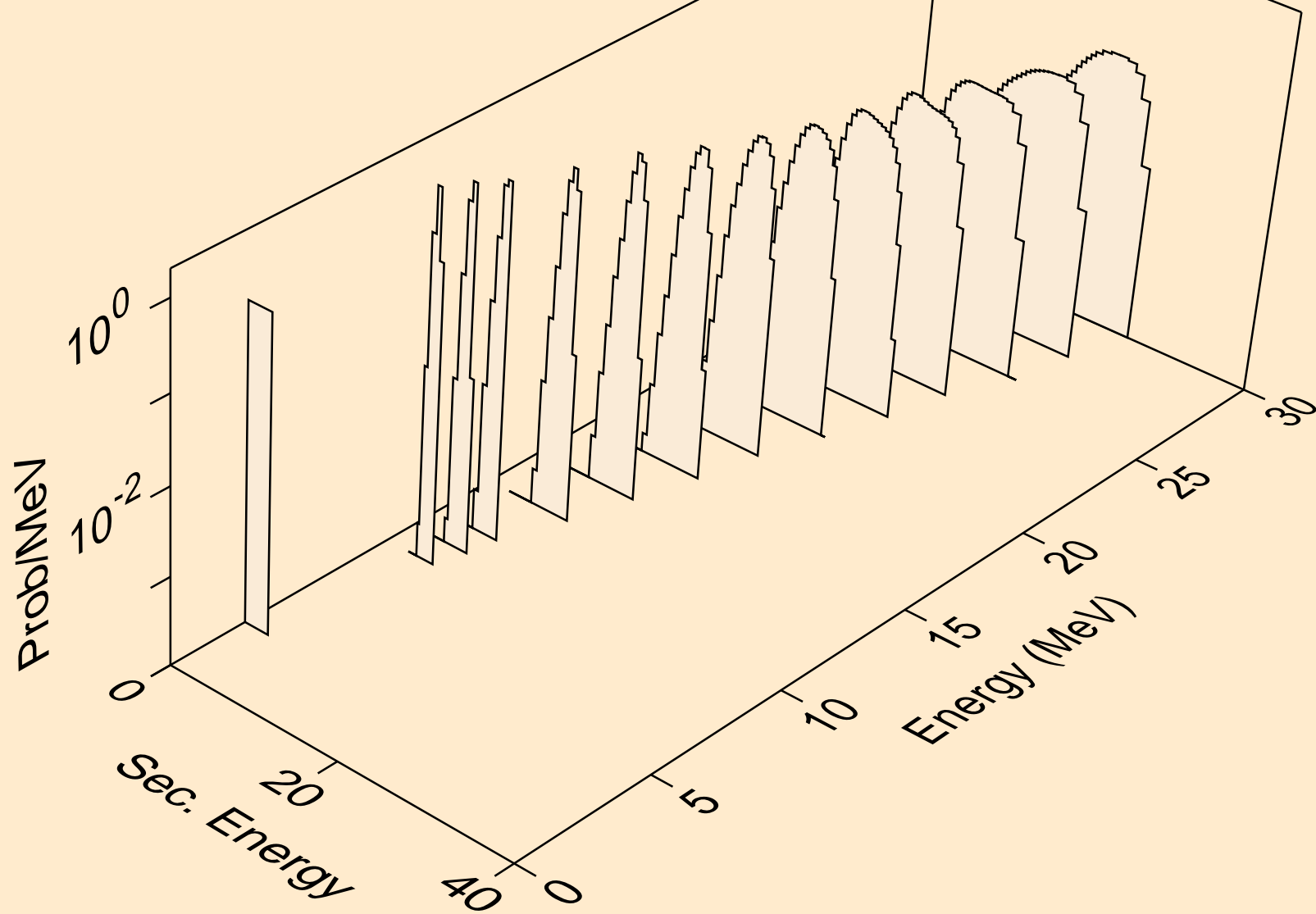

AG118M TRITON ACER TENDL-2021 LIBRARY; T=0.K  
alphas from (t,3n)a

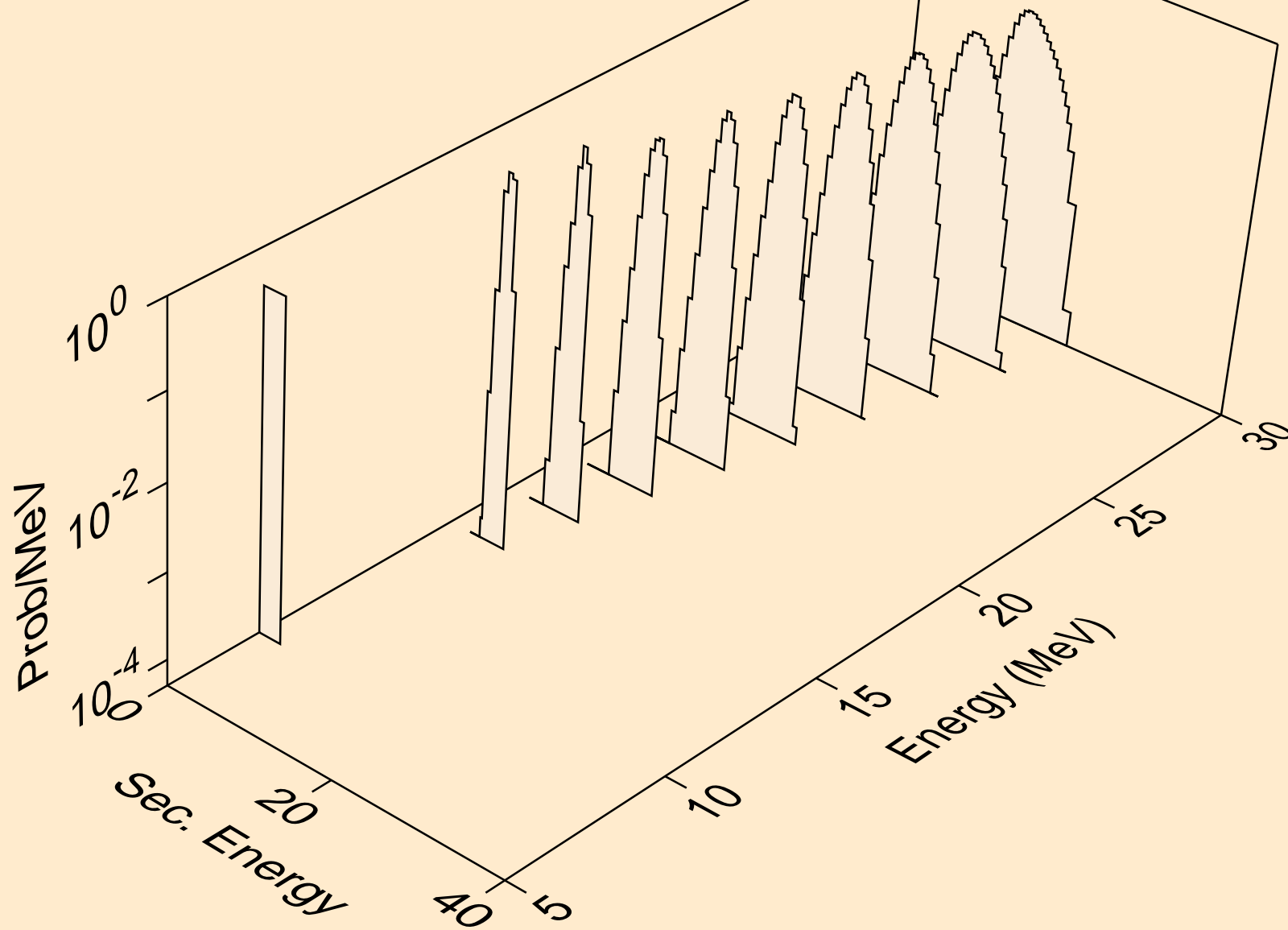

AG118M TRITON ACER TENDL-2021 LIBRARY; T=0.K  
alphas from (t,n\*)2a

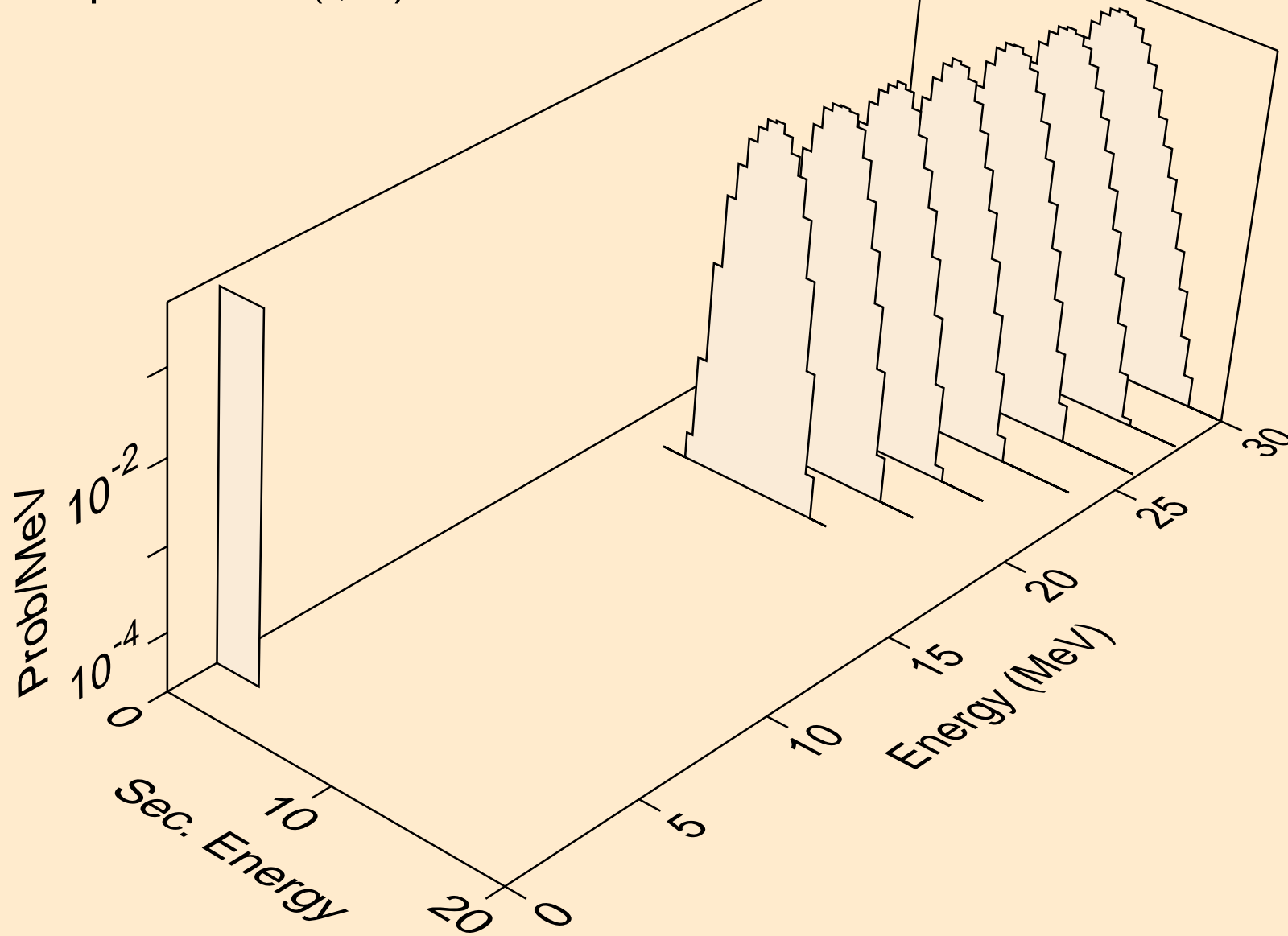

AG118M TRITON ACER TENDL-2021 LIBRARY; T=0.K  
alphas from (t,npa)

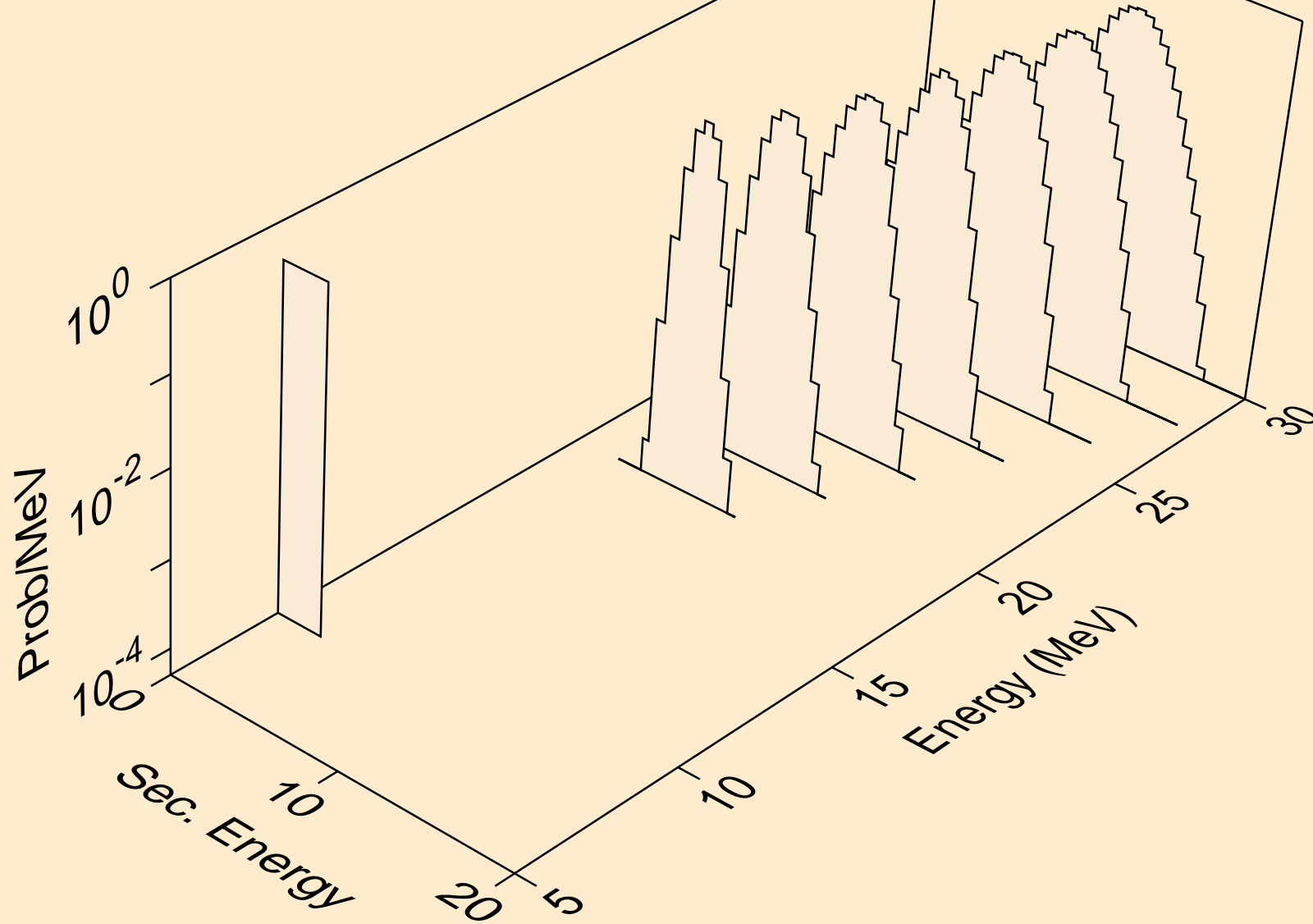

AG118M TRITON ACER TENDL-2021 LIBRARY; T=0.K  
alphas from (t,a)

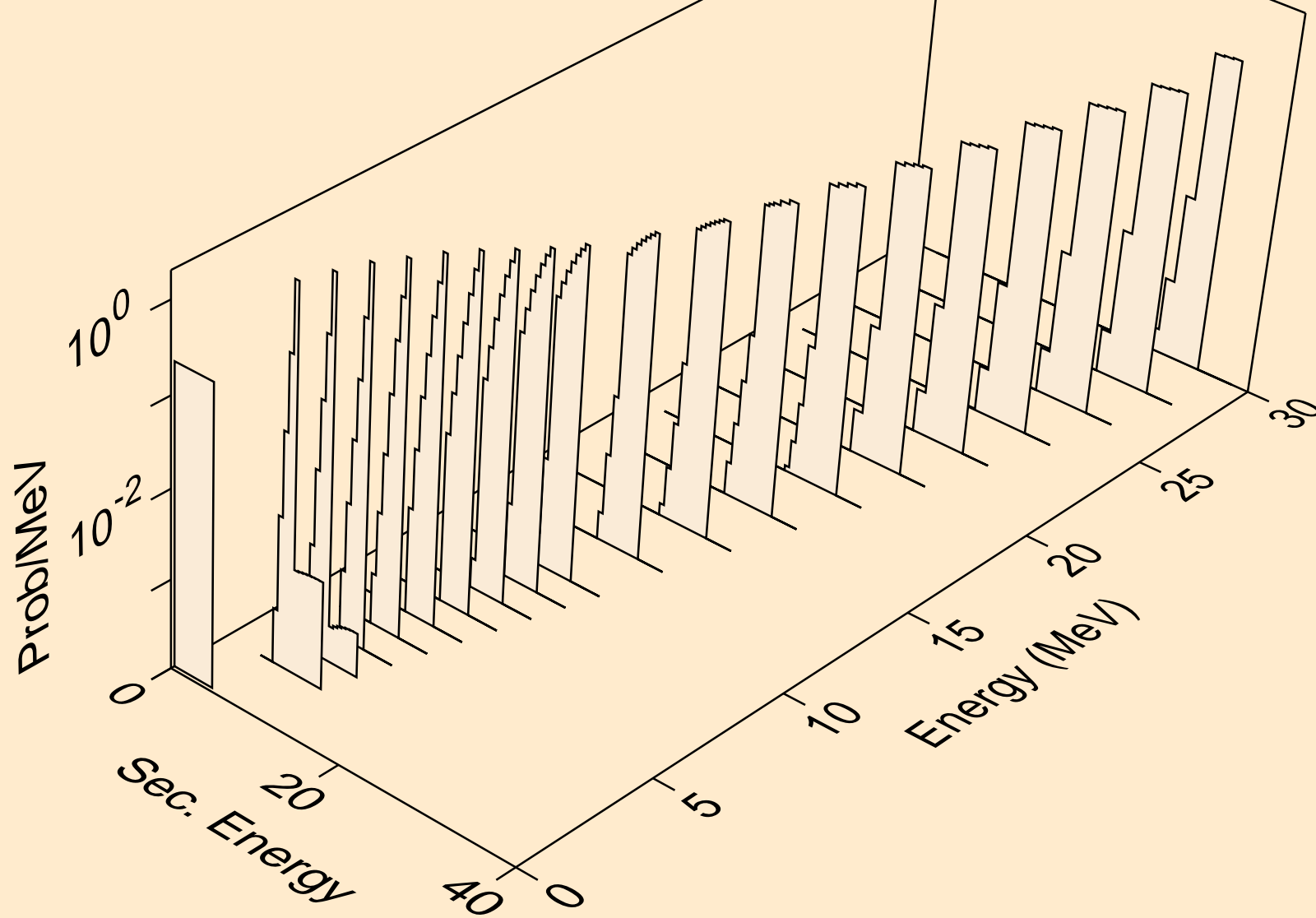



AG118M TRITON ACER TENDL-2021 LIBRARY; T=0.K  
alphas from (t,pa)

