

AU196M TRITON ACER TENDL-2021 LIBRARY; T=0.K  
Principal cross sections

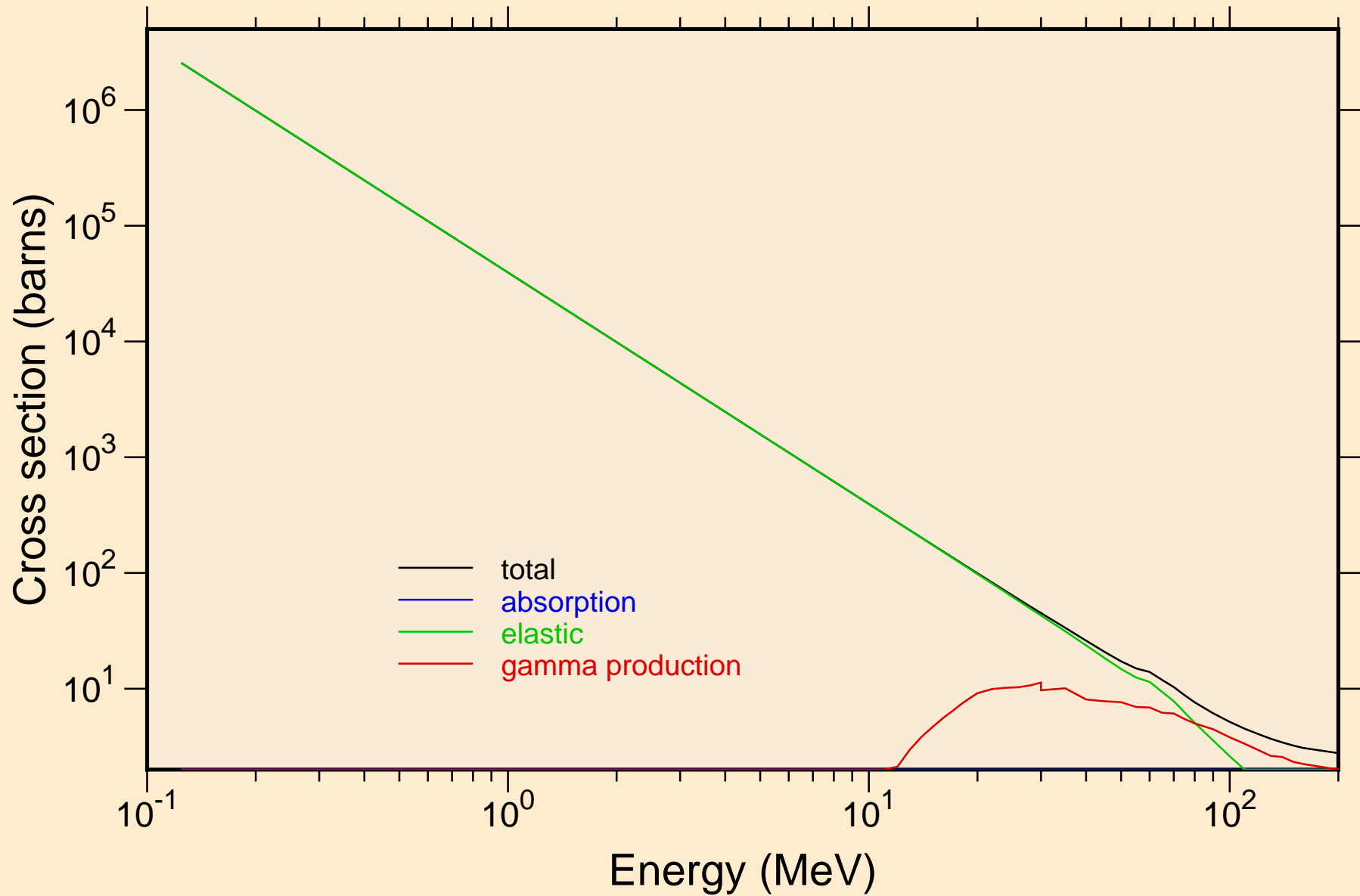

AU196M TRITON ACER TENDL-2021 LIBRARY; T=0.K

Heating

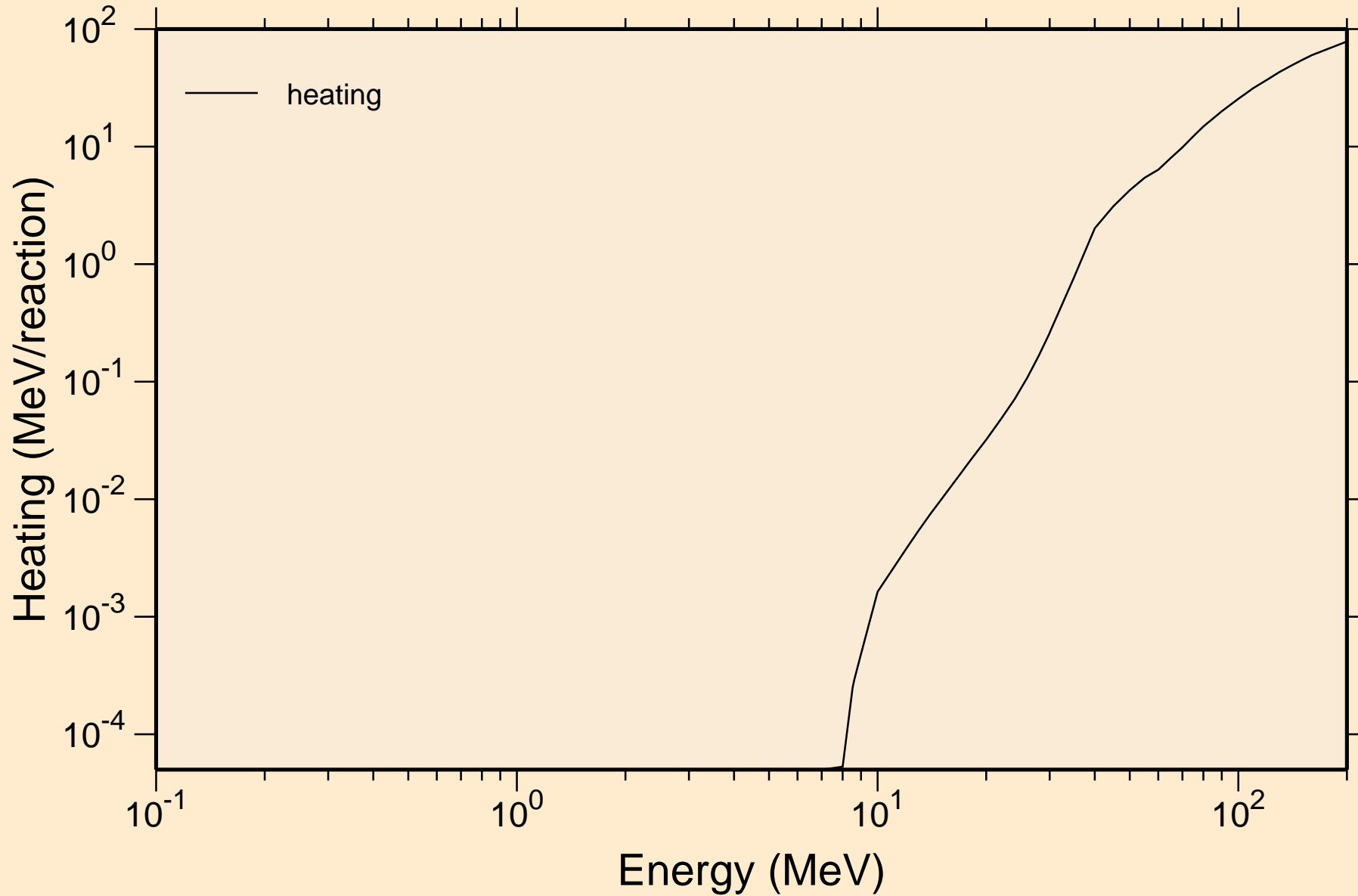

# AU196M TRITON ACER TENDL-2021 LIBRARY; T=0.K

## Principal cross sections

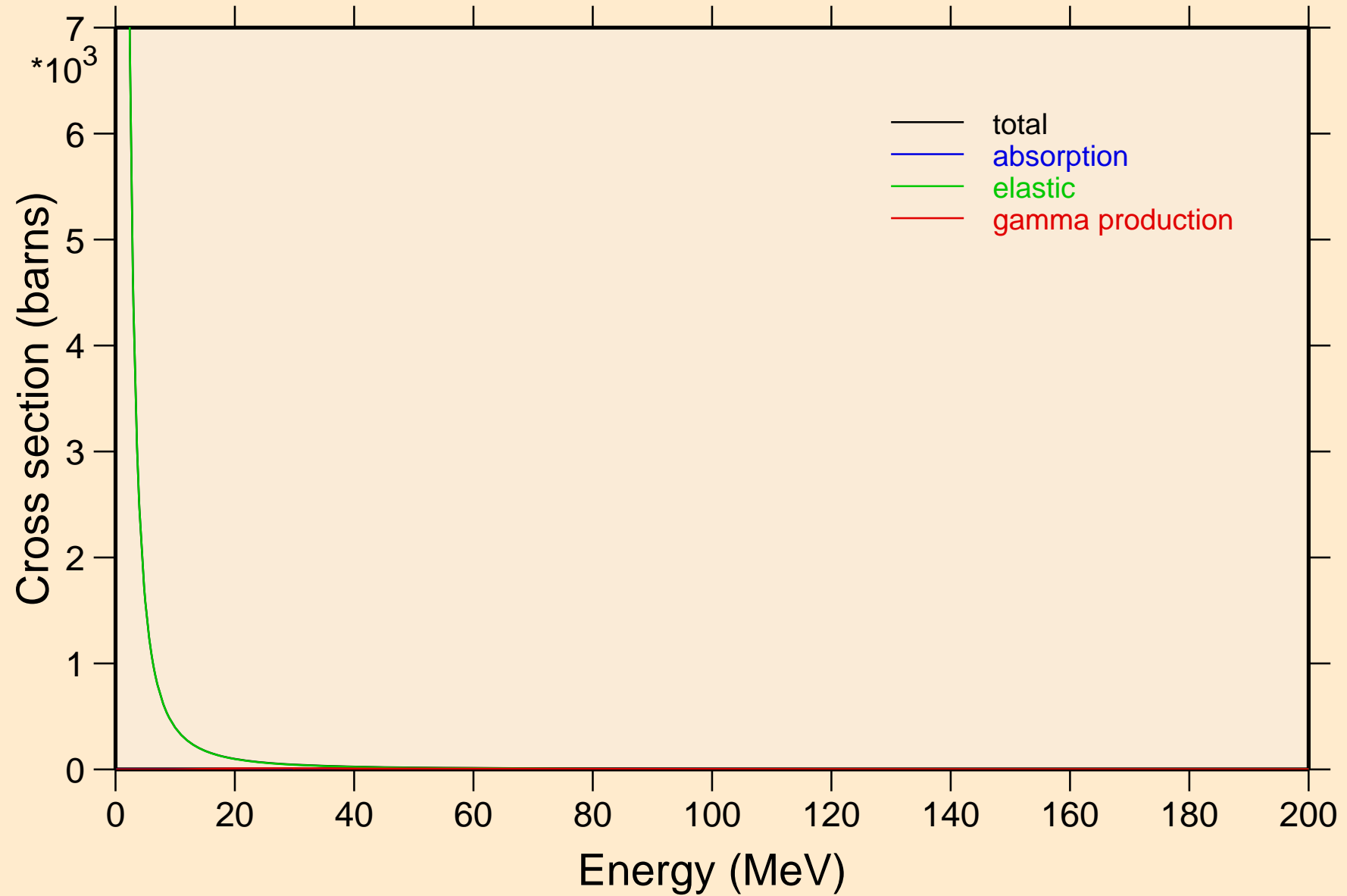

AU196M TRITON ACER TENDL-2021 LIBRARY; T=0.K

Heating

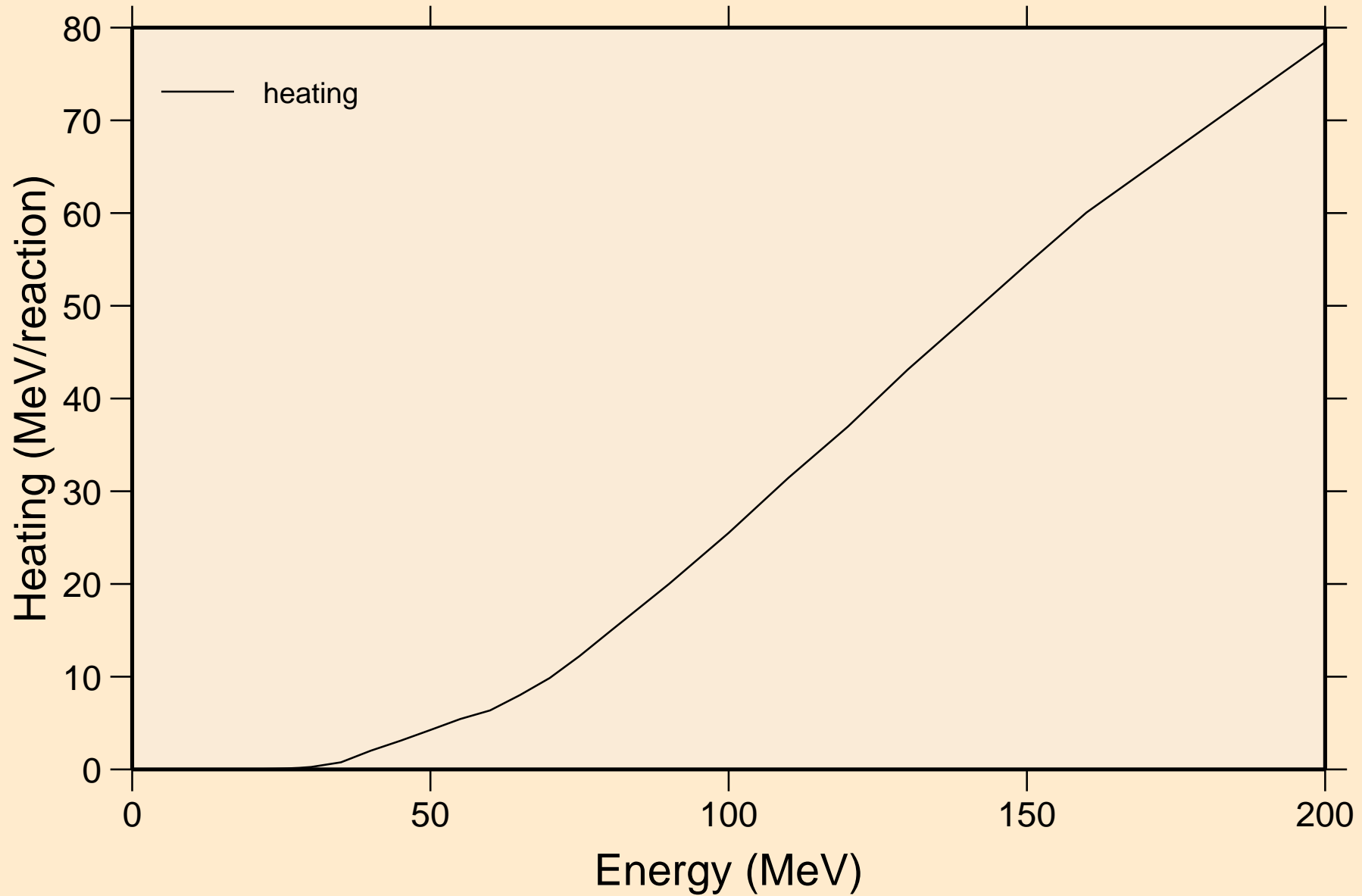

AU196M TRITON ACER TENDL-2021 LIBRARY; T=0.K  
Threshold reactions

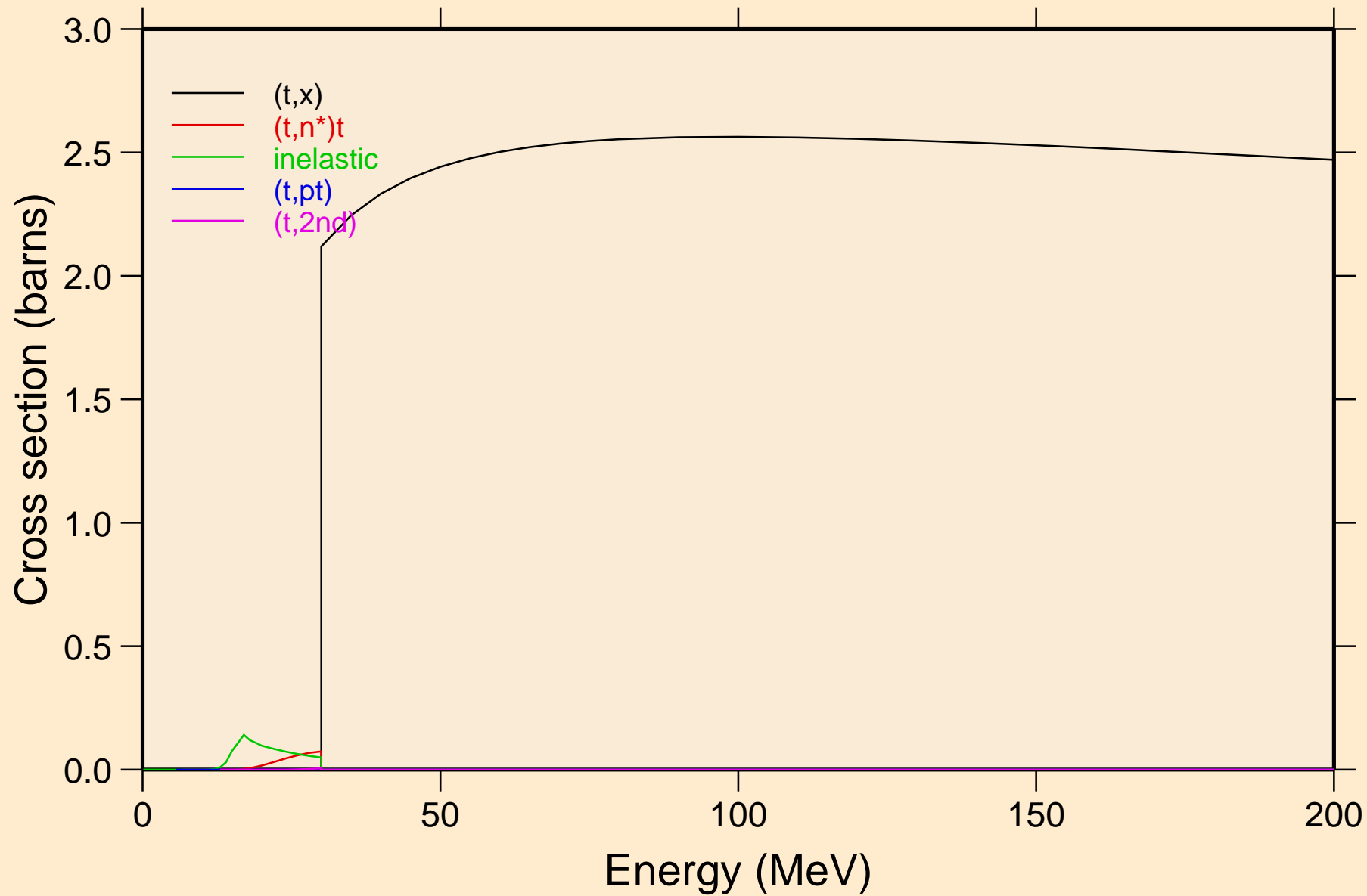

AU196M TRITON ACER TENDL-2021 LIBRARY; T=0.K  
Threshold reactions

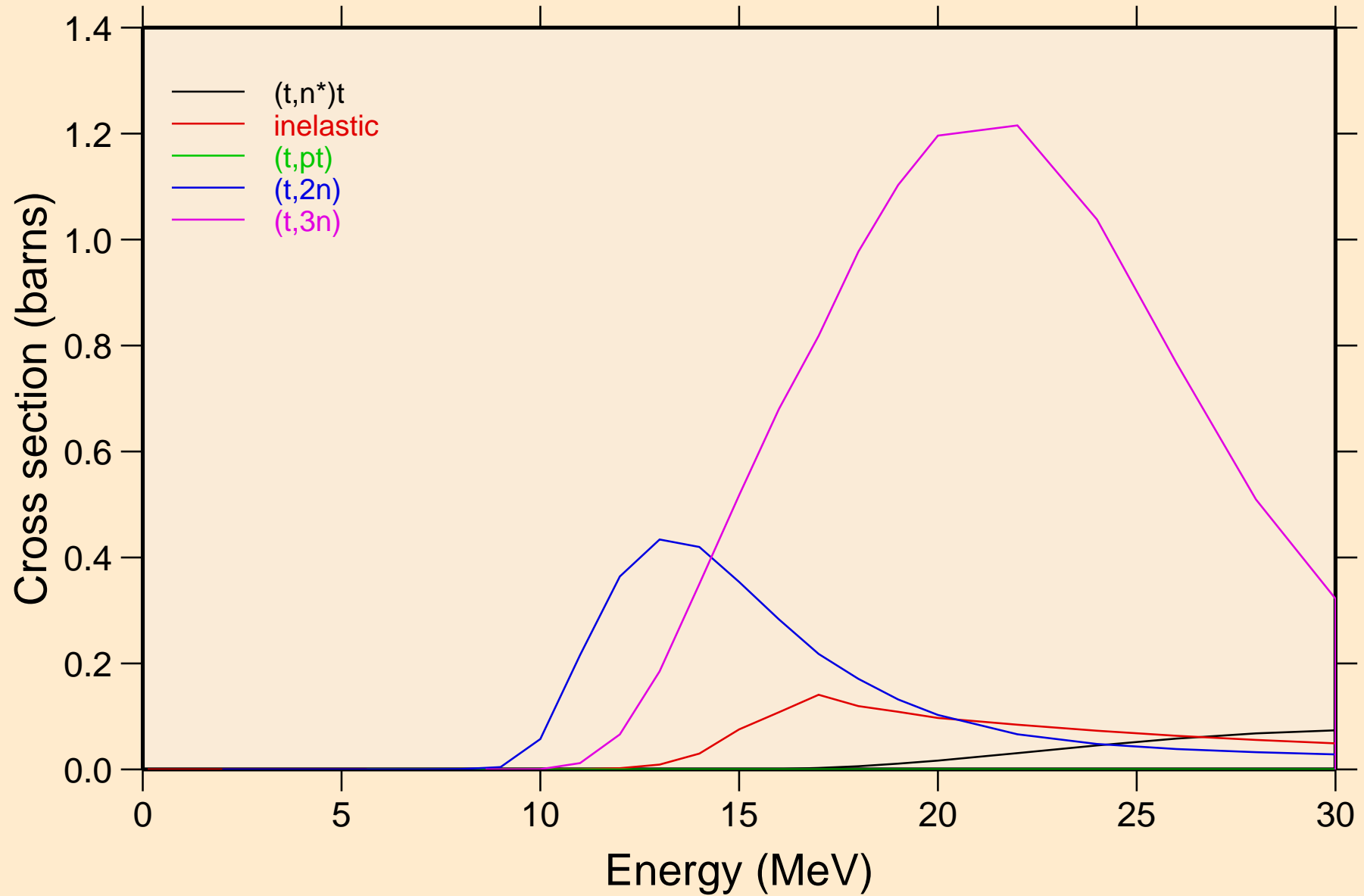

AU196M TRITON ACER TENDL-2021 LIBRARY; T=0.K  
Threshold reactions

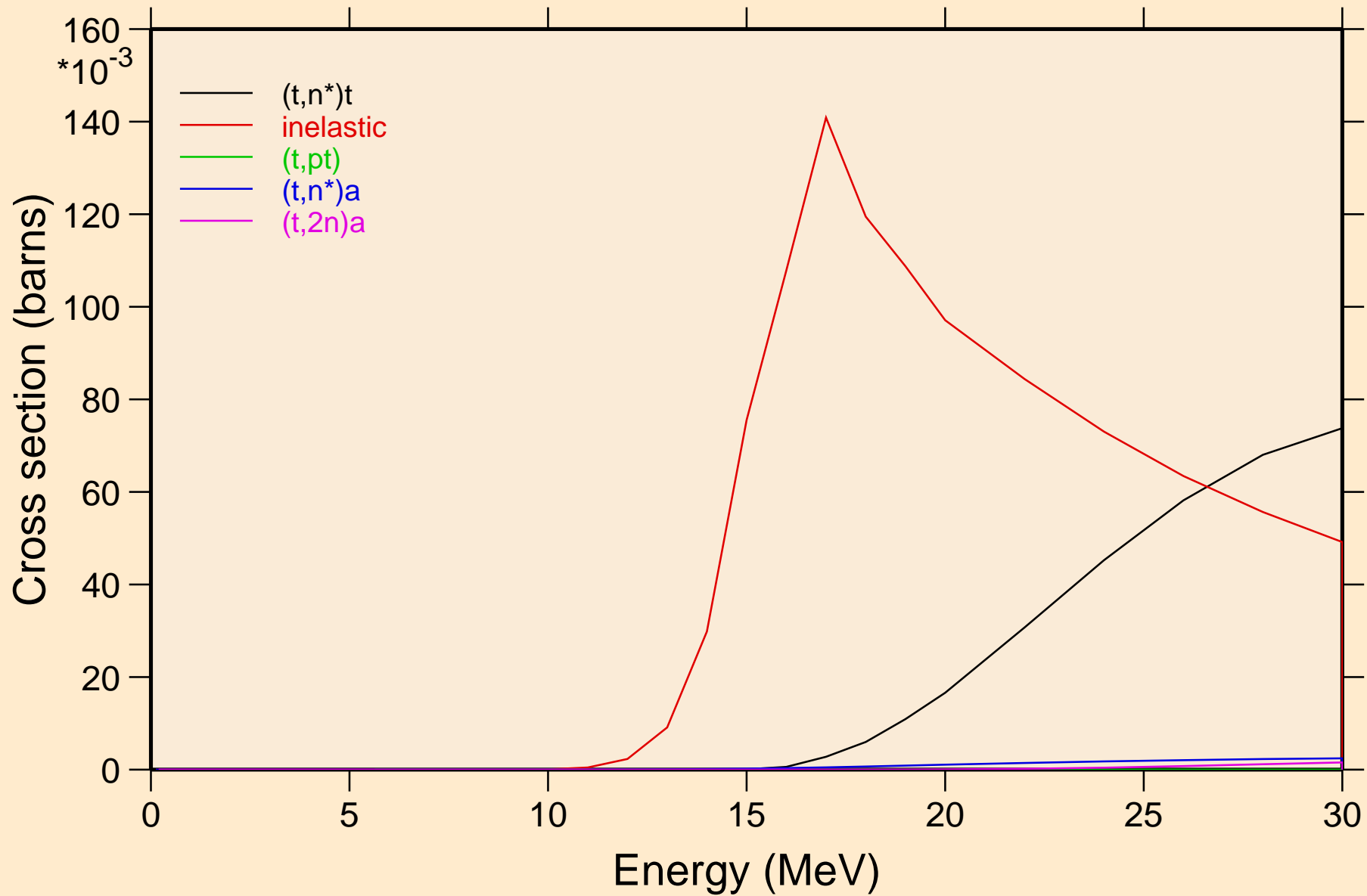

AU196M TRITON ACER TENDL-2021 LIBRARY; T=0.K  
Threshold reactions

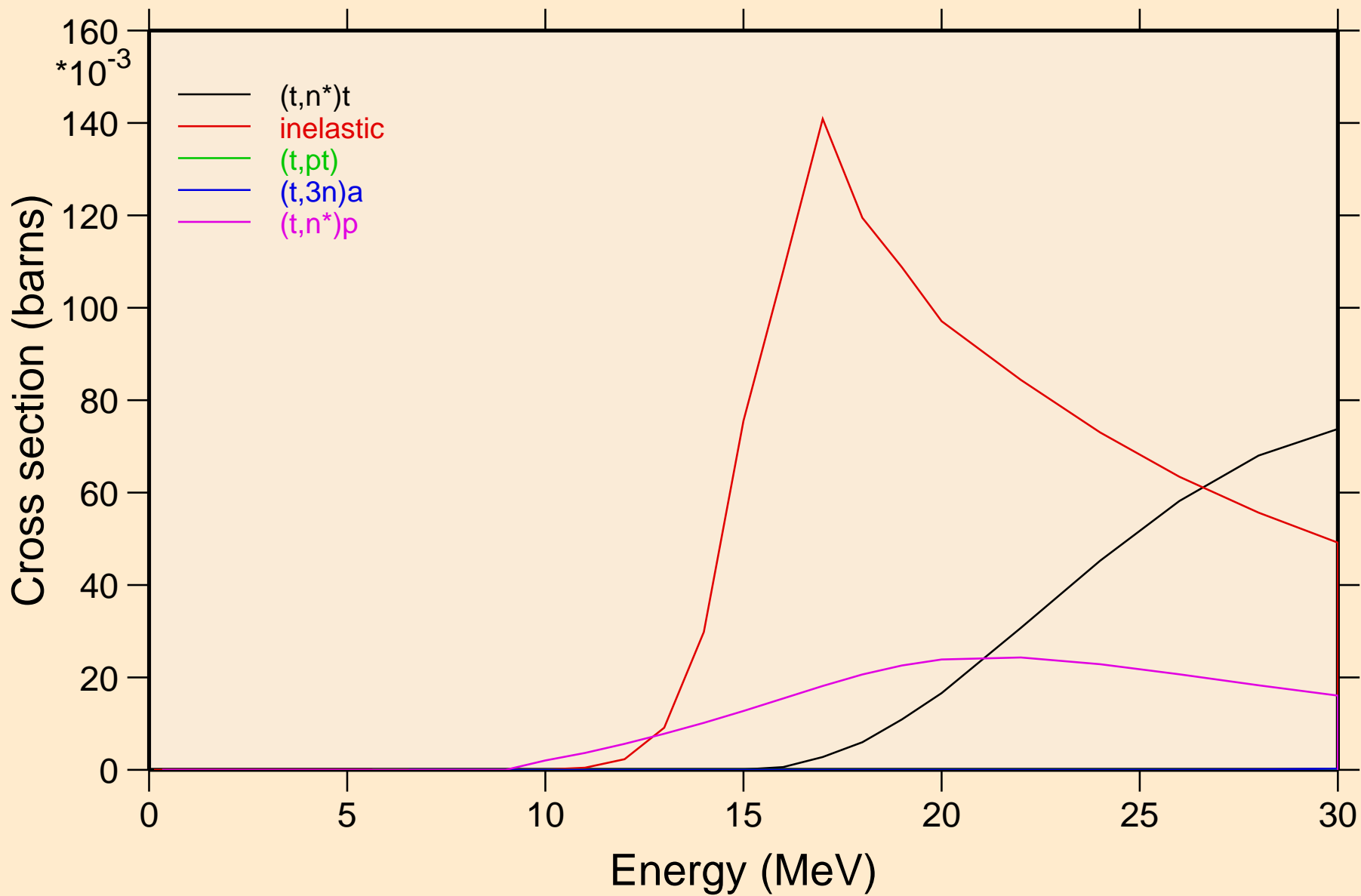



AU196M TRITON ACER TENDL-2021 LIBRARY; T=0.K  
Threshold reactions

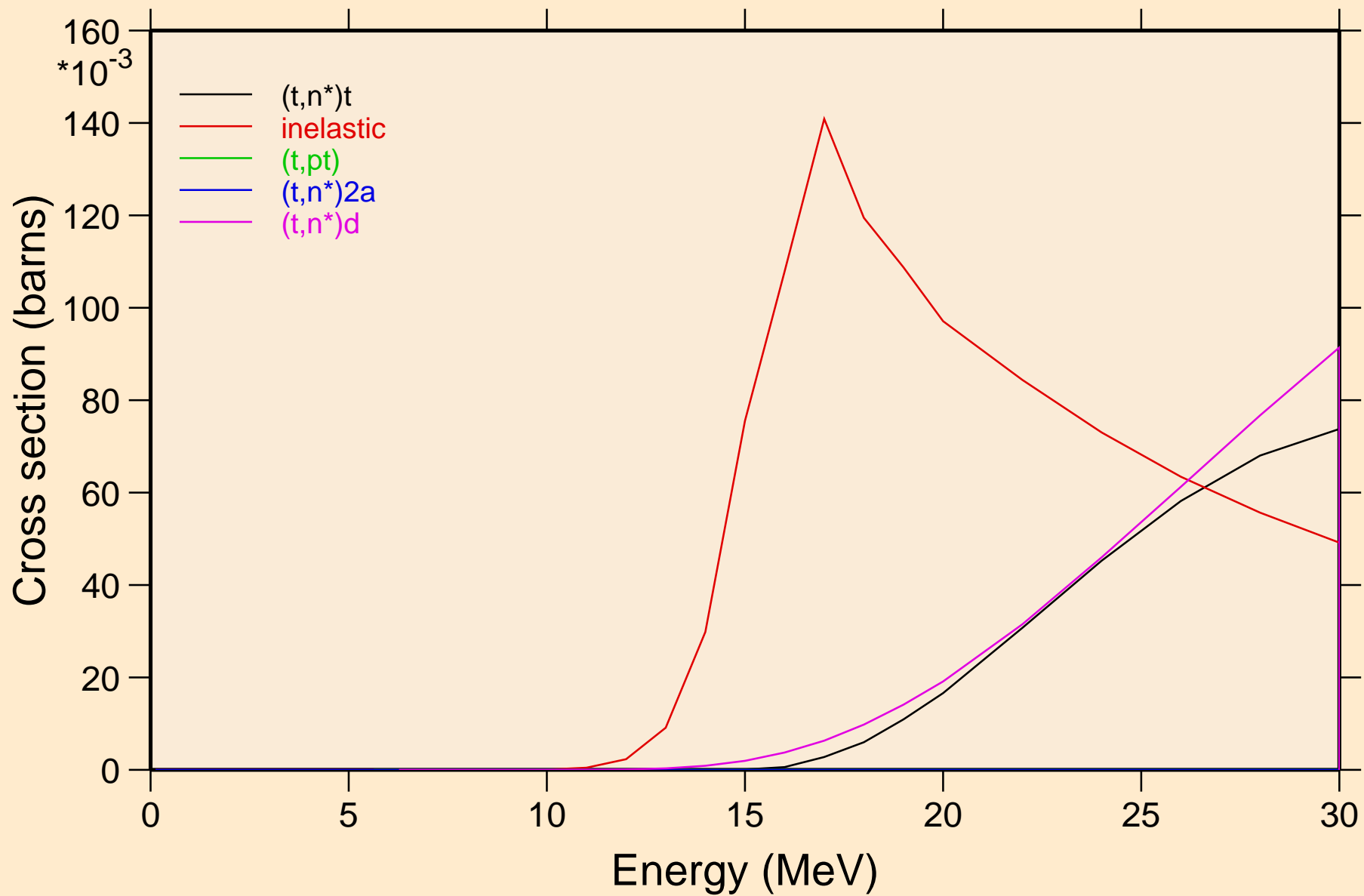

AU196M TRITON ACER TENDL-2021 LIBRARY; T=0.K  
Threshold reactions

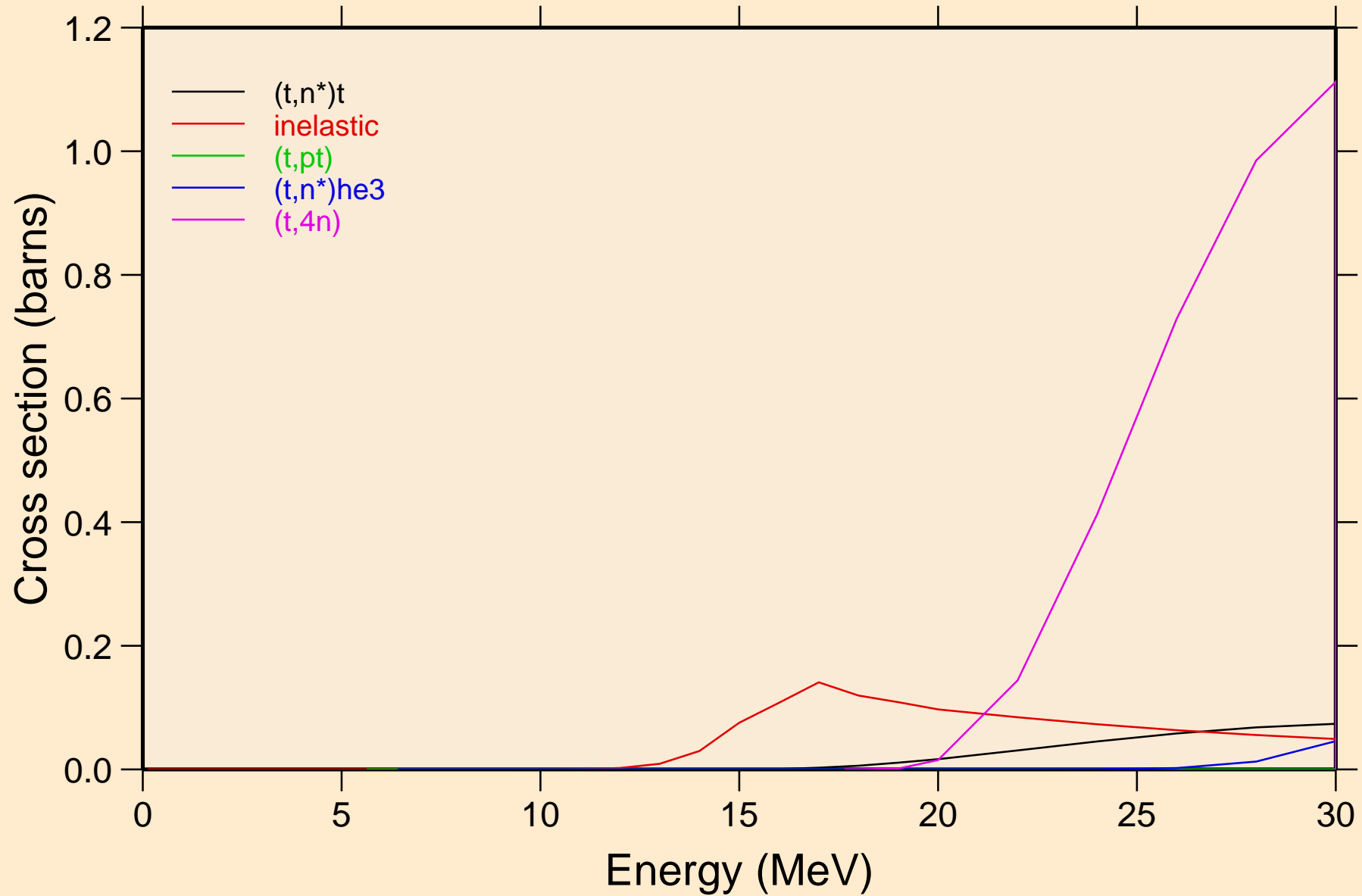

AU196M TRITON ACER TENDL-2021 LIBRARY; T=0.K  
Threshold reactions

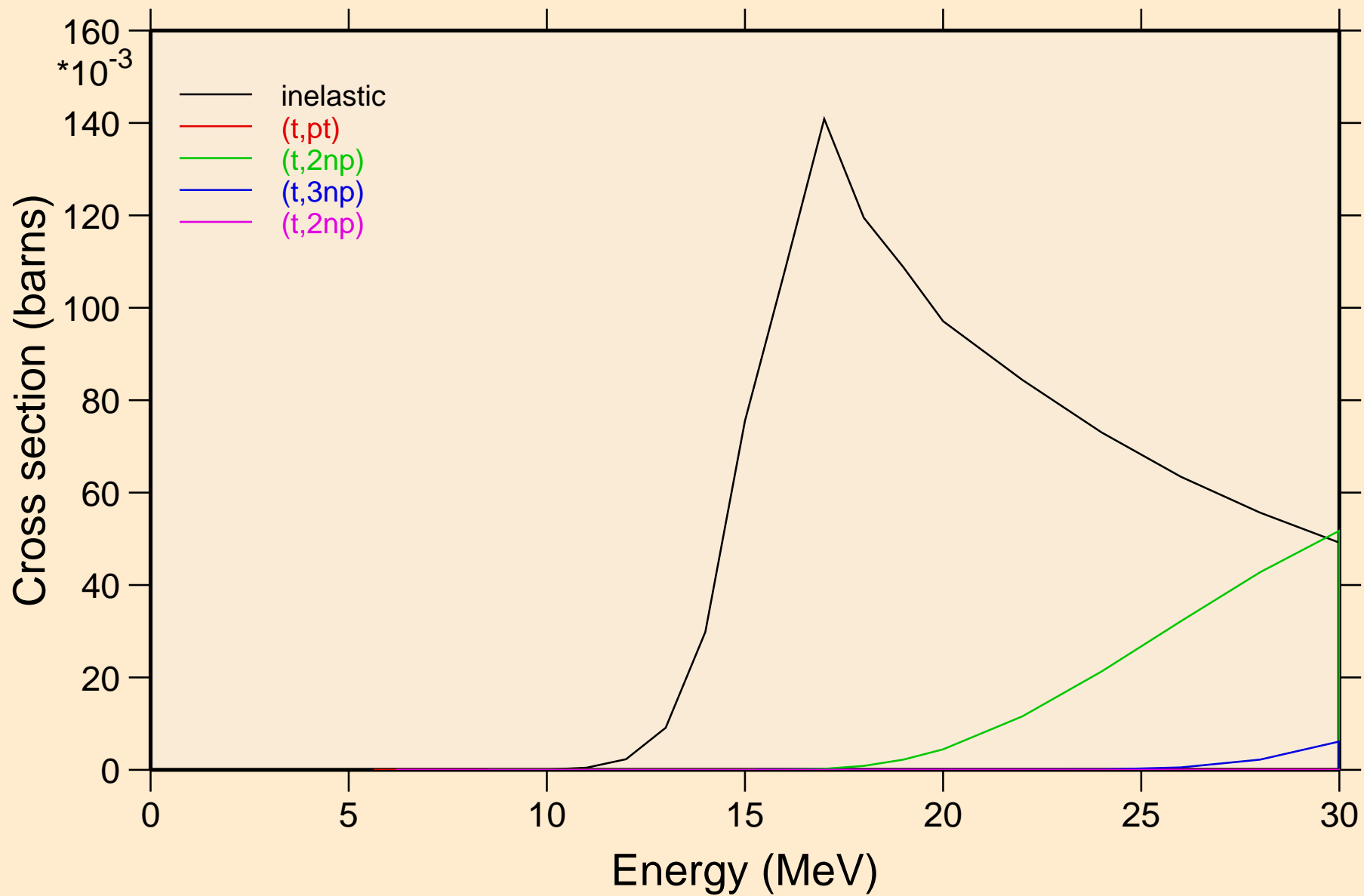

AU196M TRITON ACER TENDL-2021 LIBRARY; T=0.K  
Threshold reactions

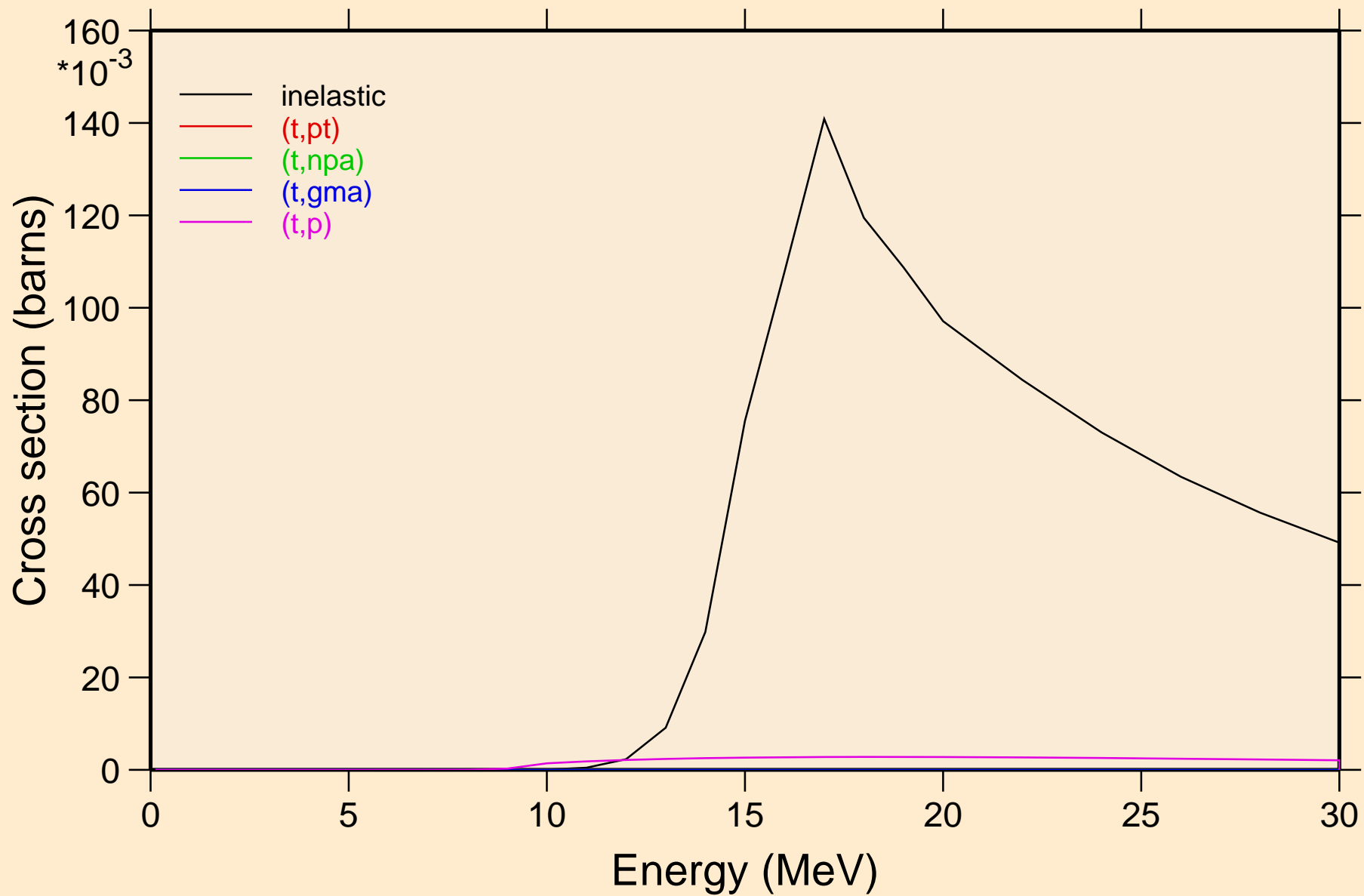

AU196M TRITON ACER TENDL-2021 LIBRARY; T=0.K  
Threshold reactions

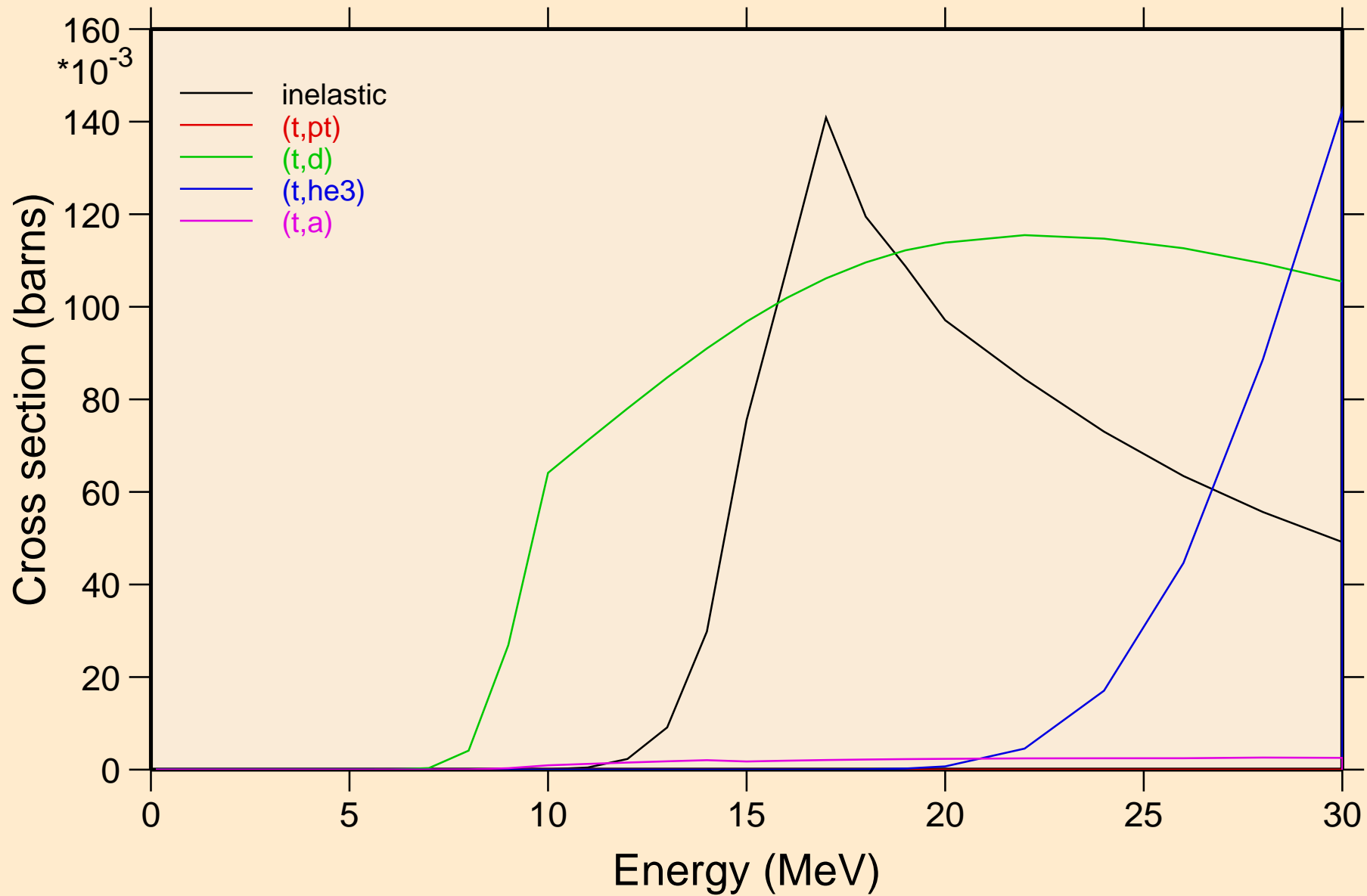

AU196M TRITON ACER TENDL-2021 LIBRARY; T=0.K  
Threshold reactions

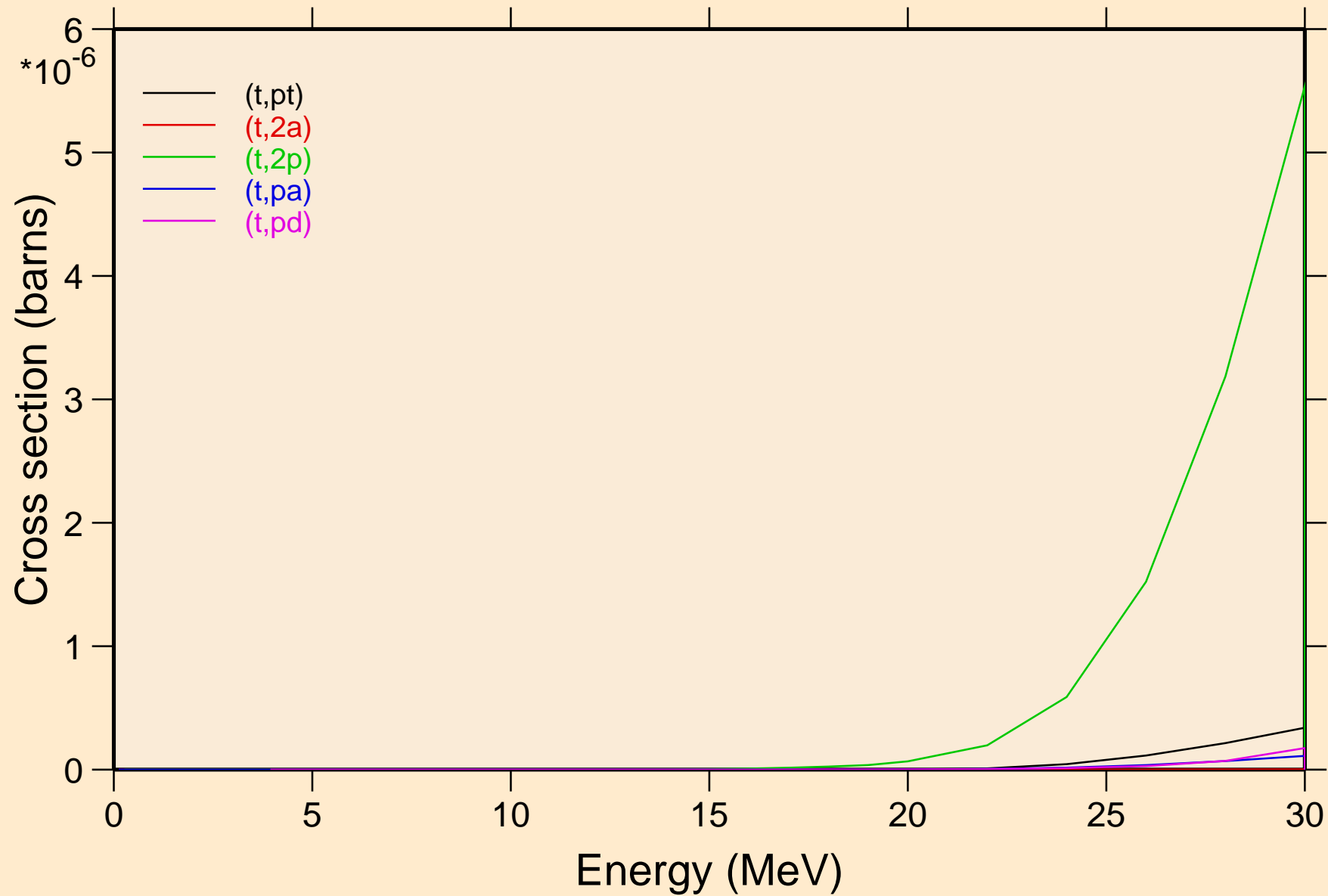

AU196M TRITON ACER TENDL-2021 LIBRARY; T=0.K  
Threshold reactions

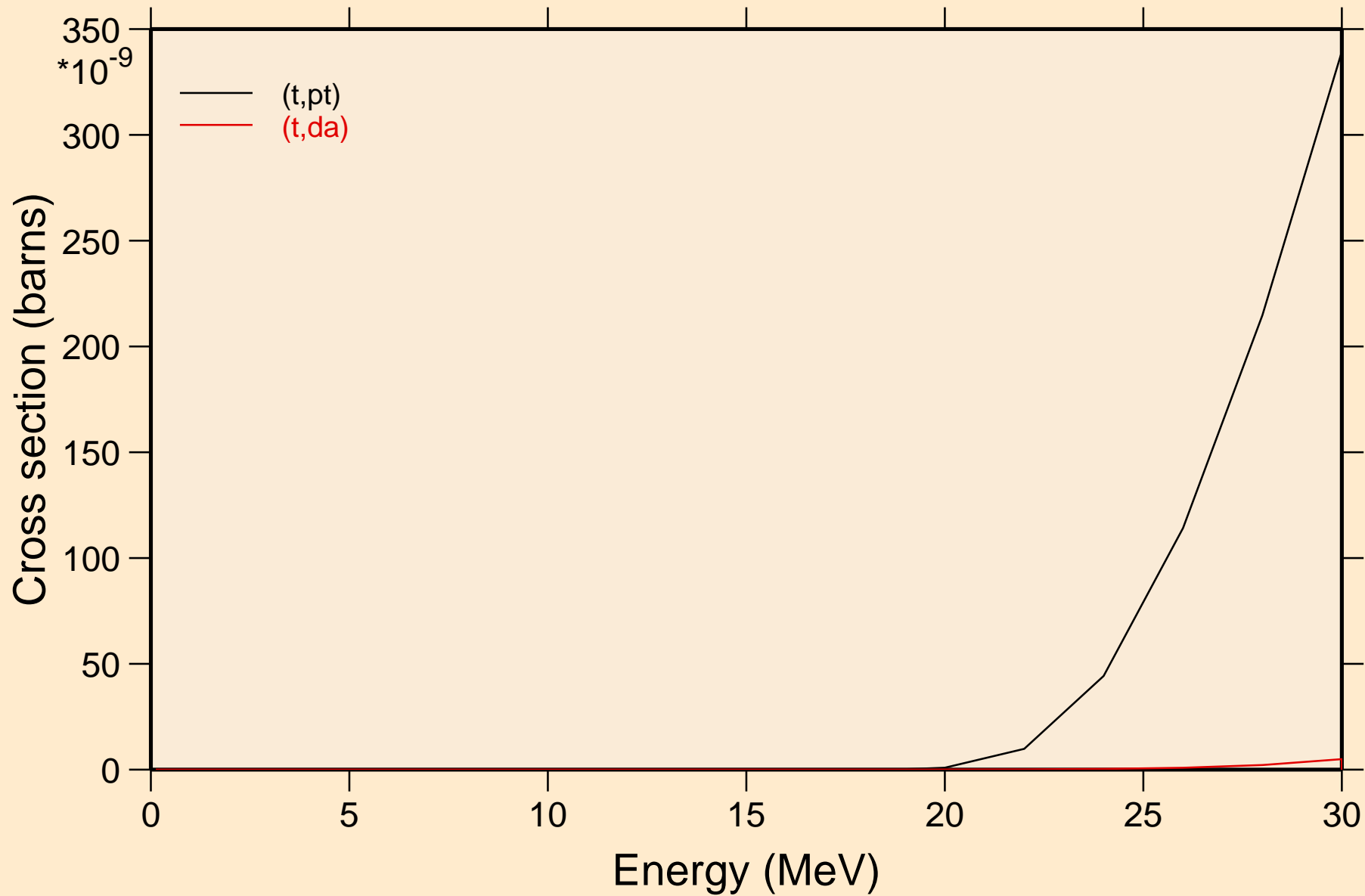

AU196M TRITON ACER TENDL-2021 LIBRARY; T=0.K  
angular distribution for elastic

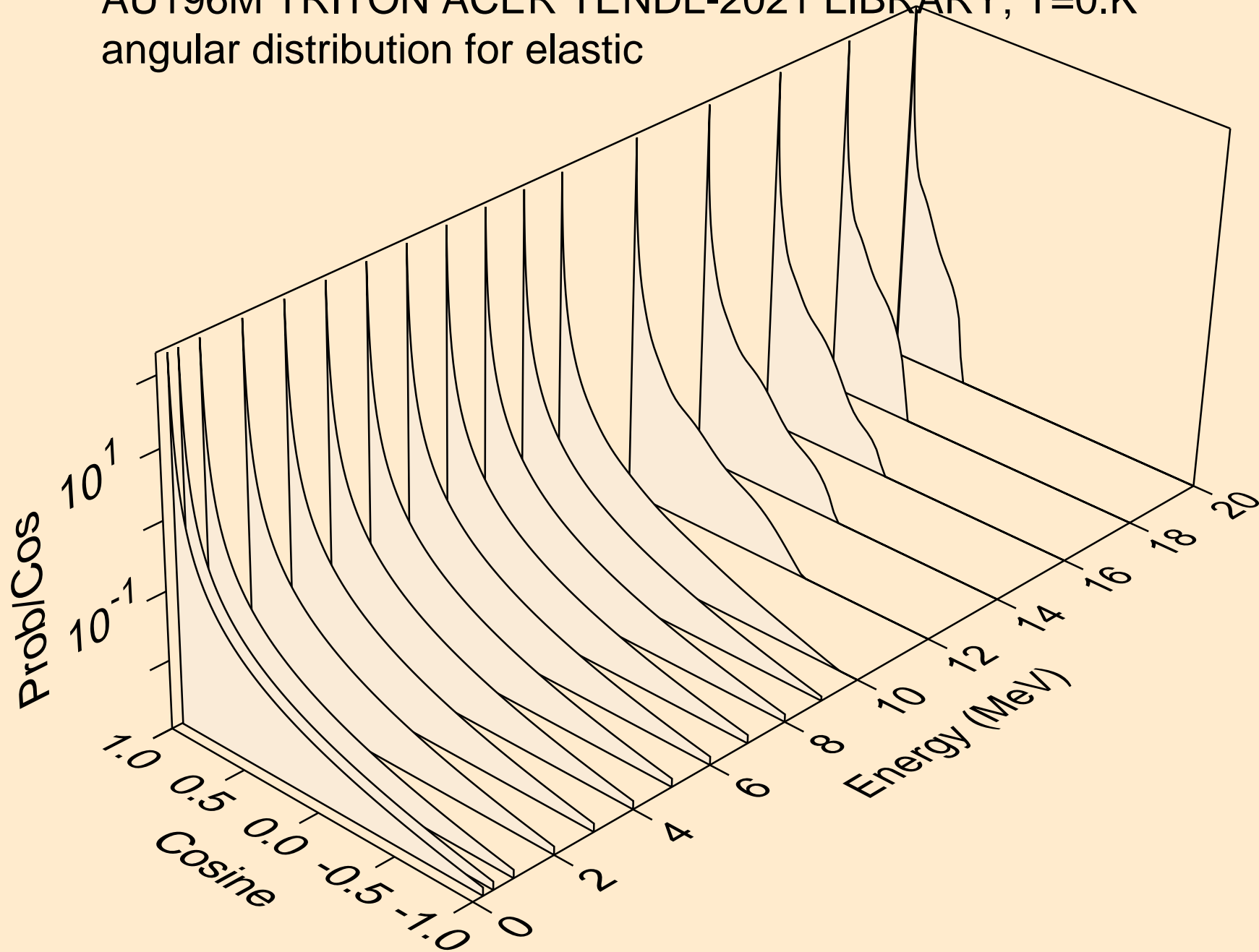



AU196M TRITON ACER TENDL-2021 LIBRARY; T=0.K  
angular distribution for elastic

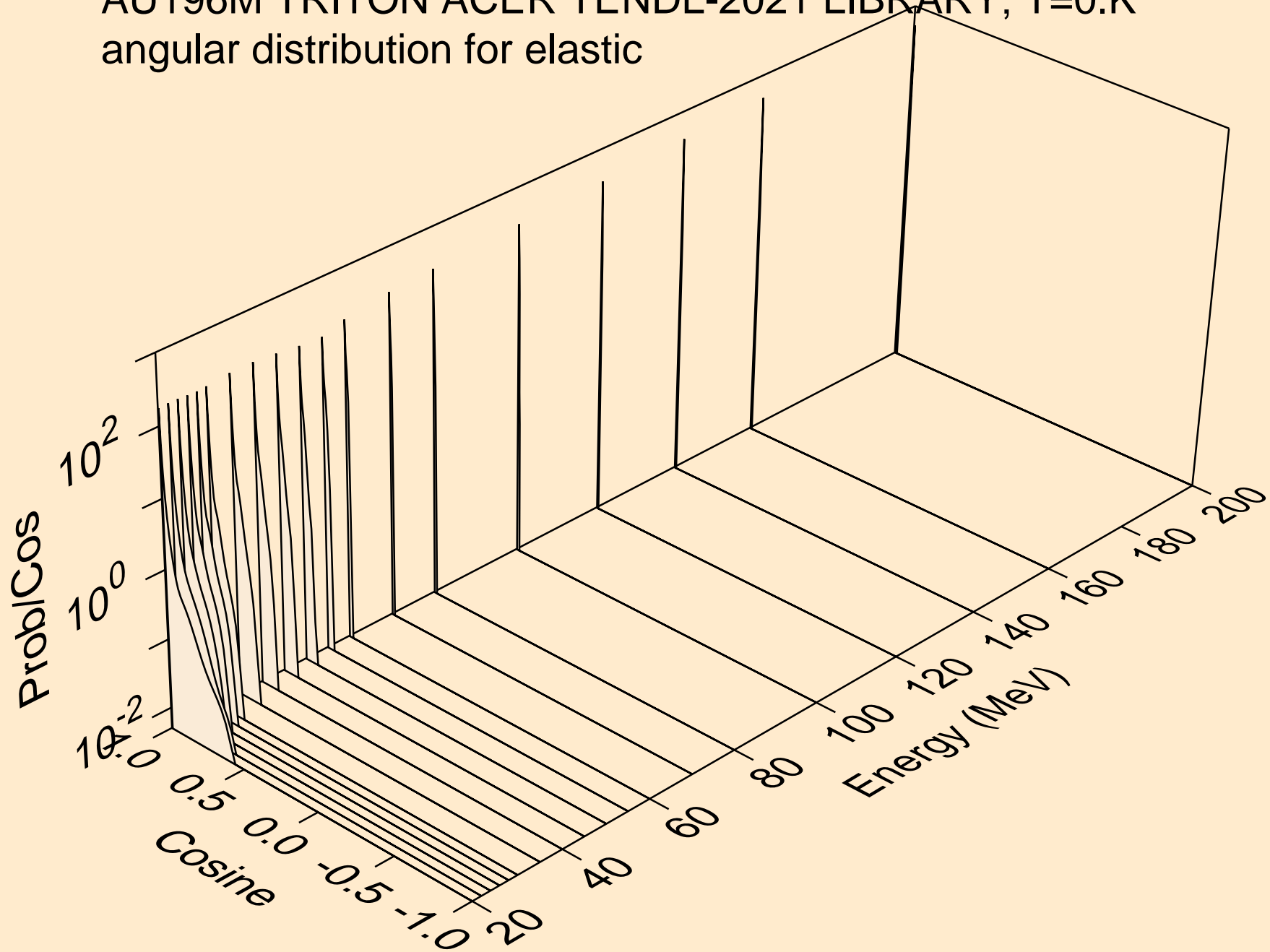

AU196M TRITON ACER TENDL-2021 LIBRARY; T=0.K  
Triton emission for (t,x)

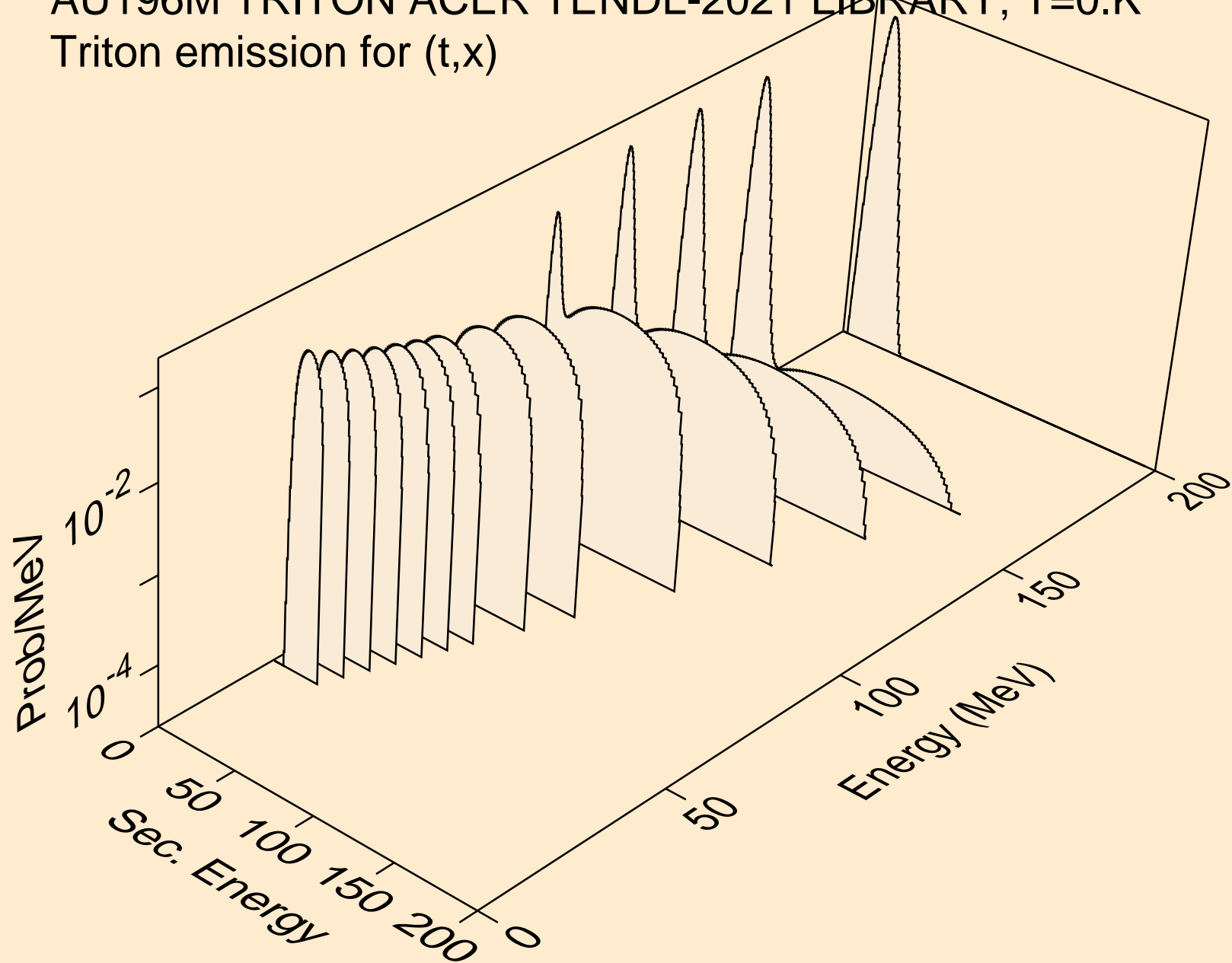

AU196M TRITON ACER TENDL-2021 LIBRARY; T=0.K  
Triton emission for (t,n\*)t

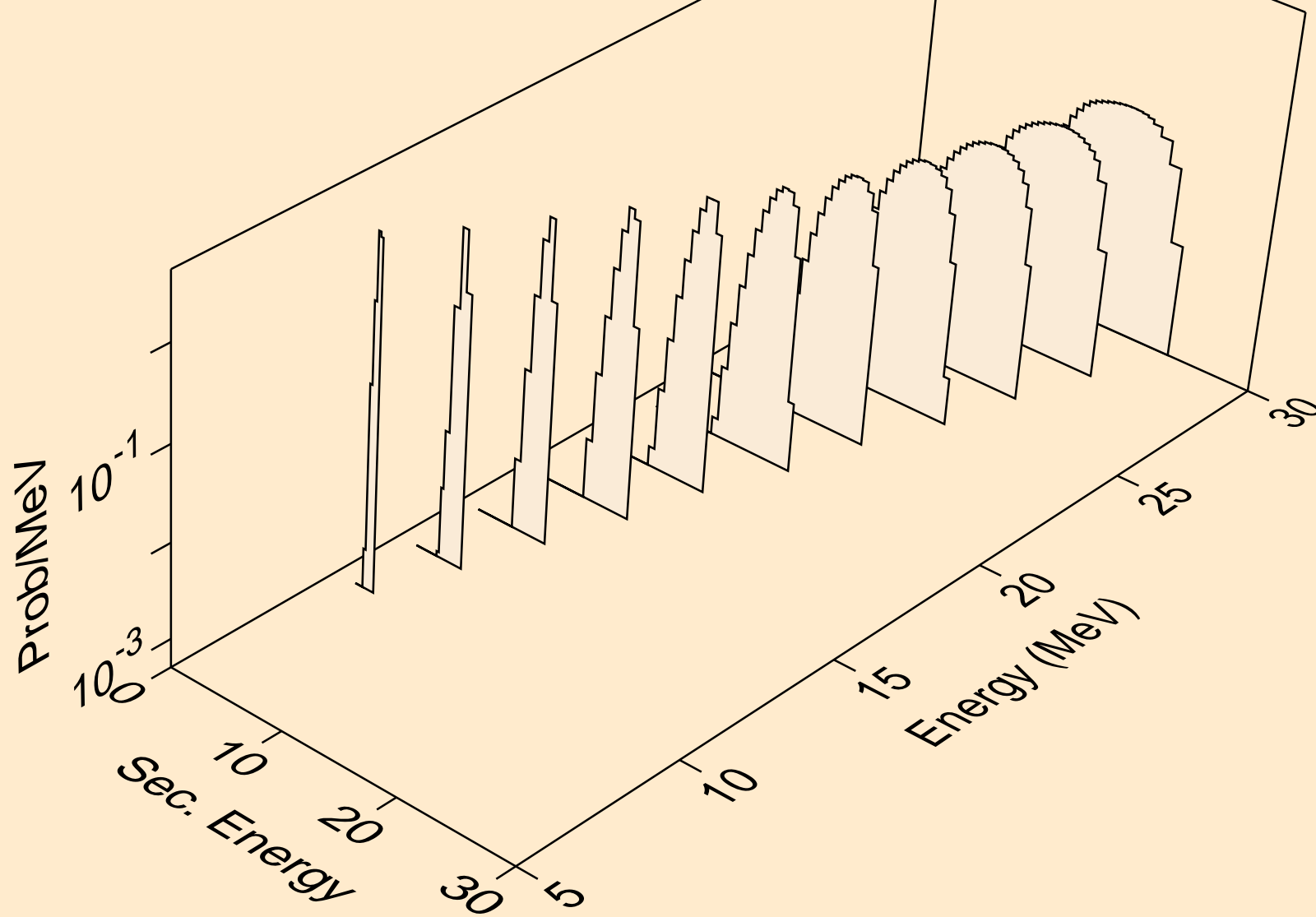

AU196M TRITON ACER TENDL-2021 LIBRARY; T=0.K  
Triton emission for inelastic

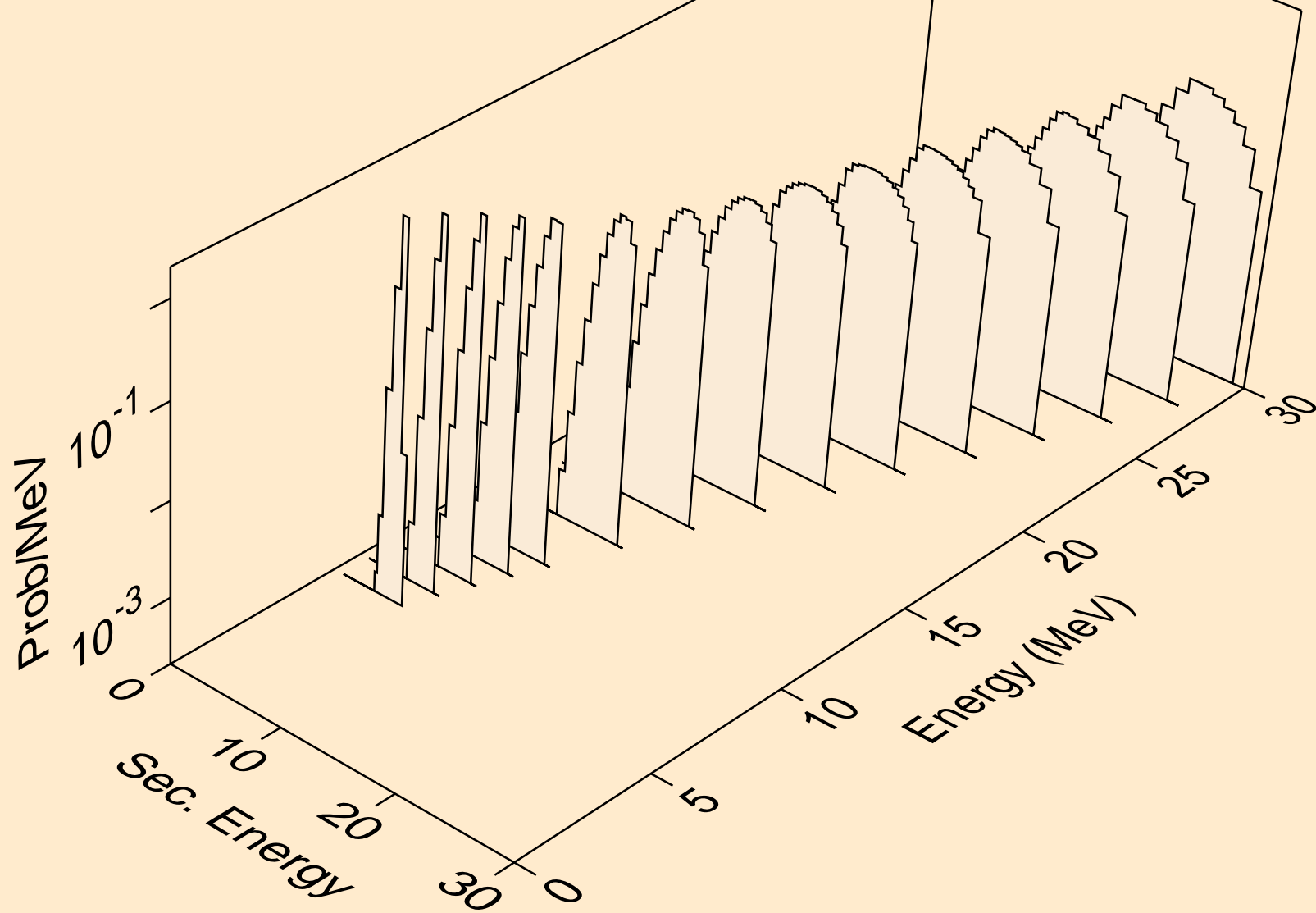

AU196M TRITON ACER TENDL-2021 LIBRARY; T=0.K  
Triton emission for (t,pt)

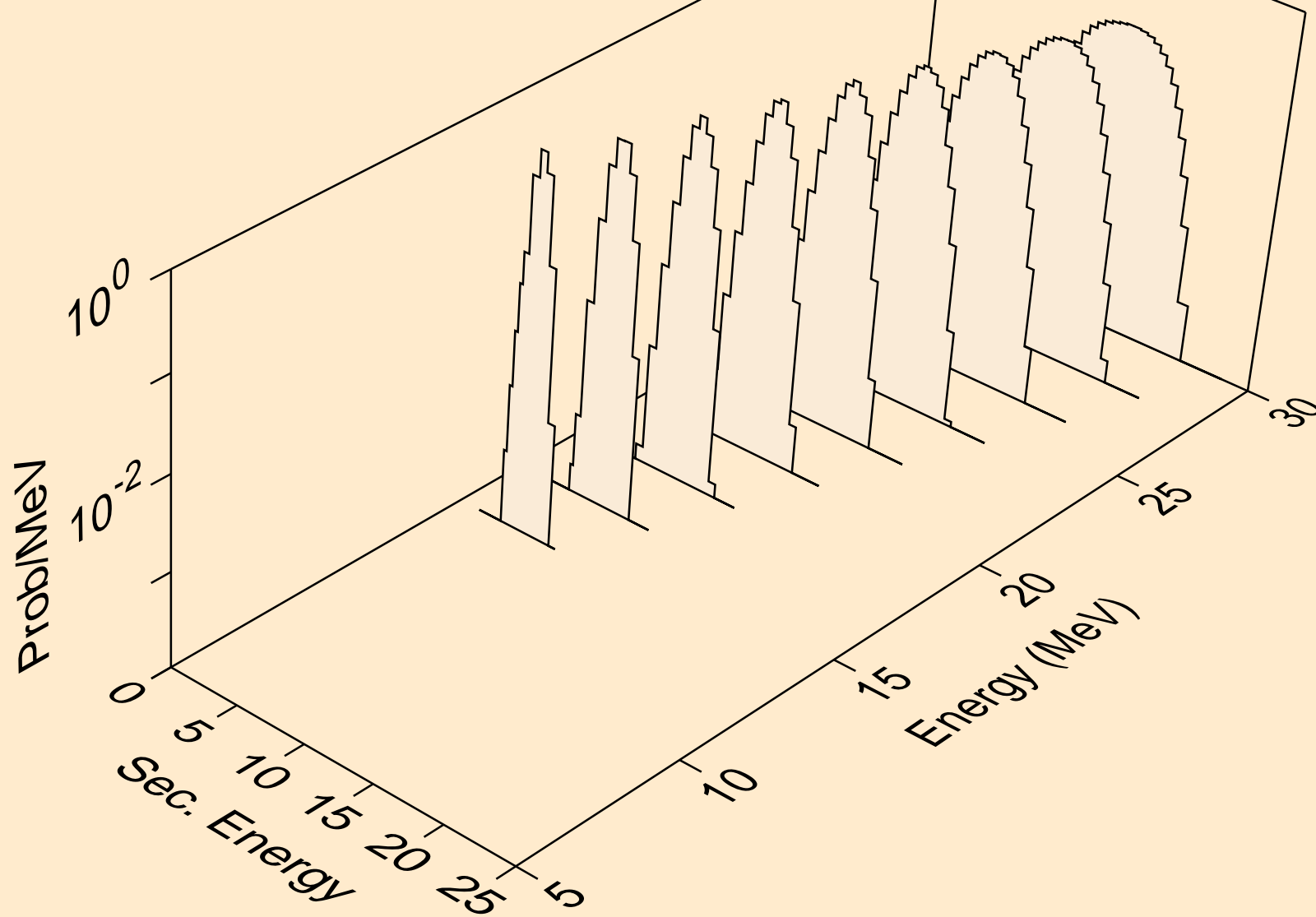

AU196M TRITON ACER TENDL-2021 LIBRARY; T=0.K  
Photon emission for (z,n)

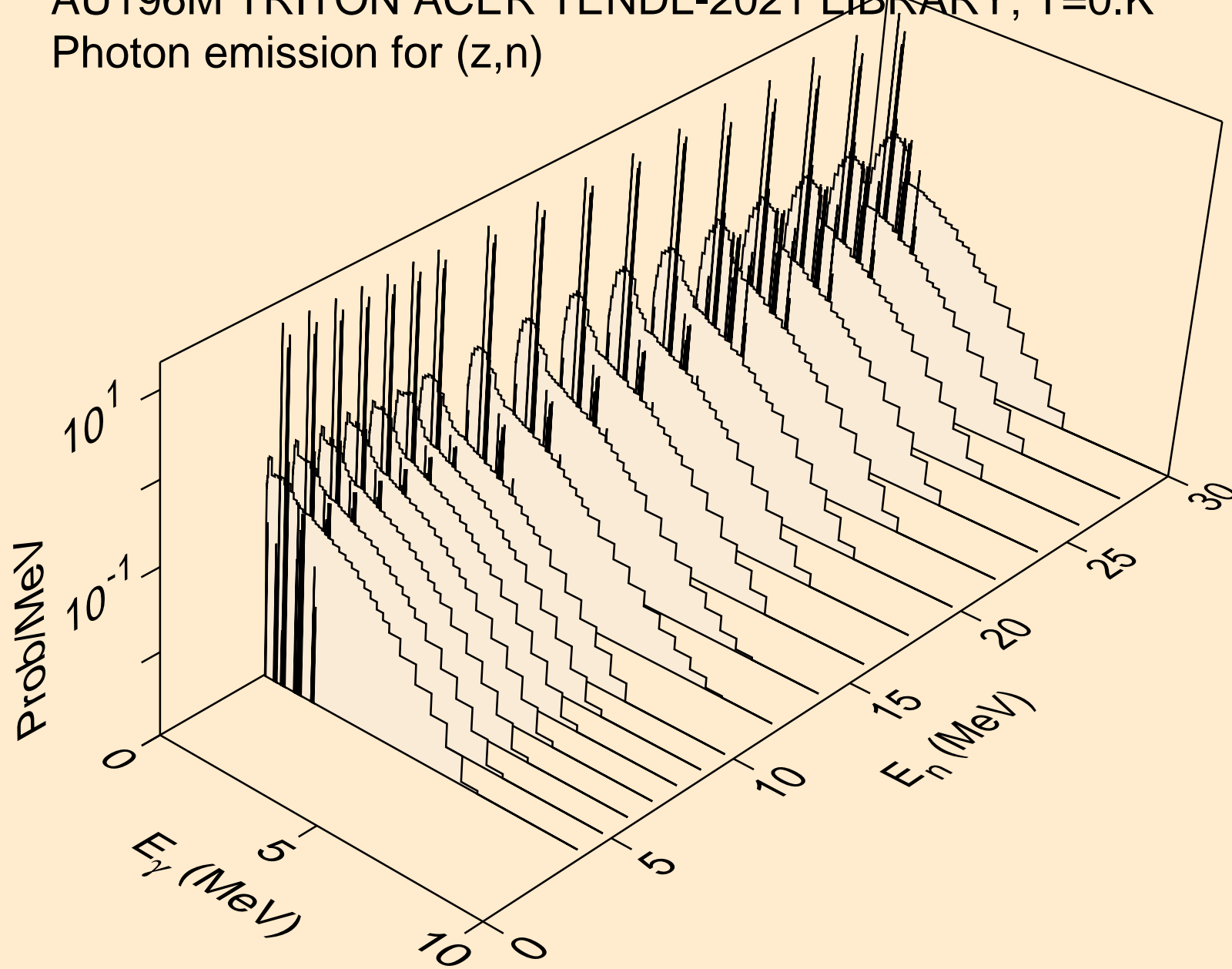

AU196M TRITON ACER TENDL-2021 LIBRARY; T=0.K  
Photon emission for (n,x)

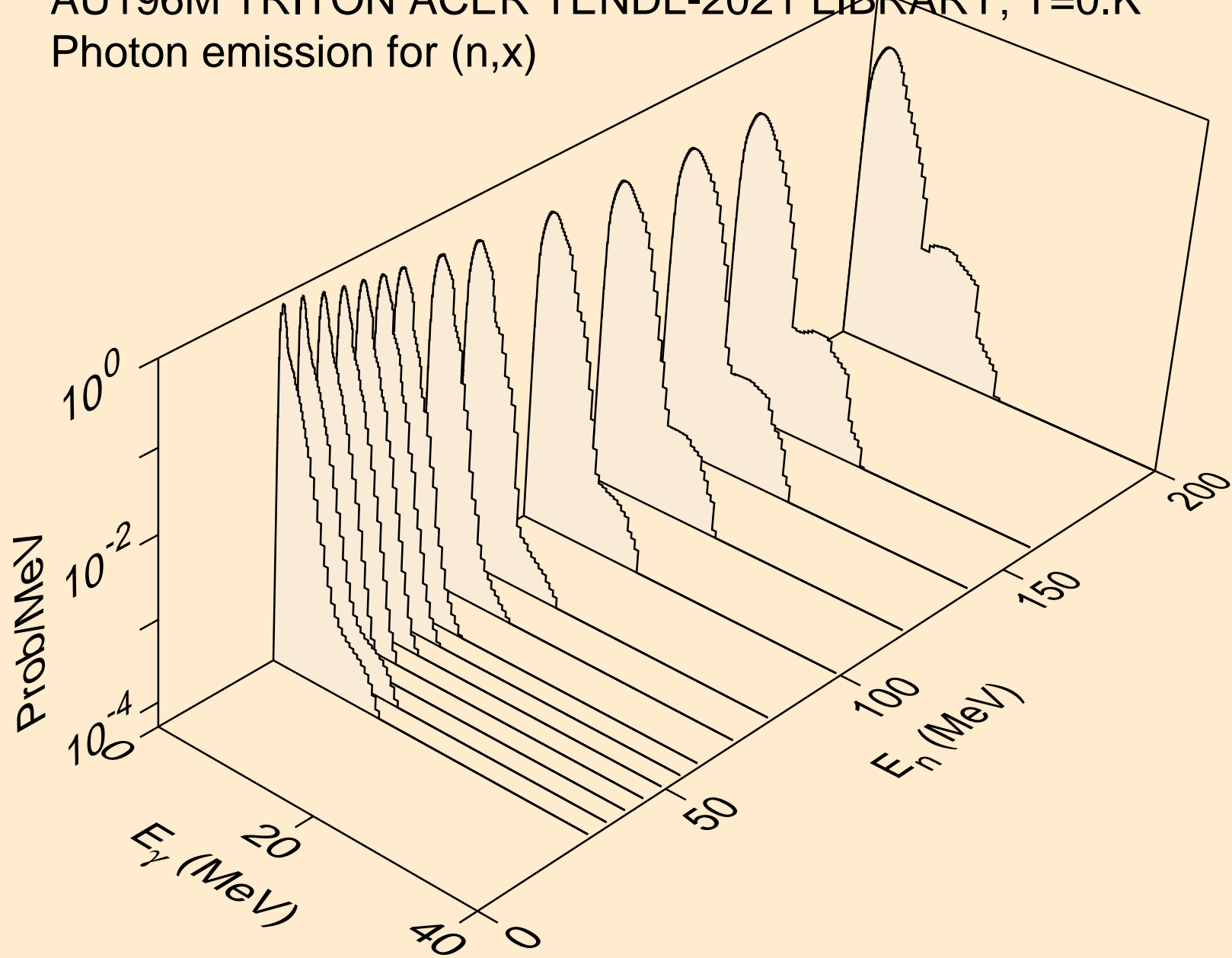

AU196M TRITON ACER TENDL-2021 LIBRARY; T=0.K  
Photon emission for (n,2nd)

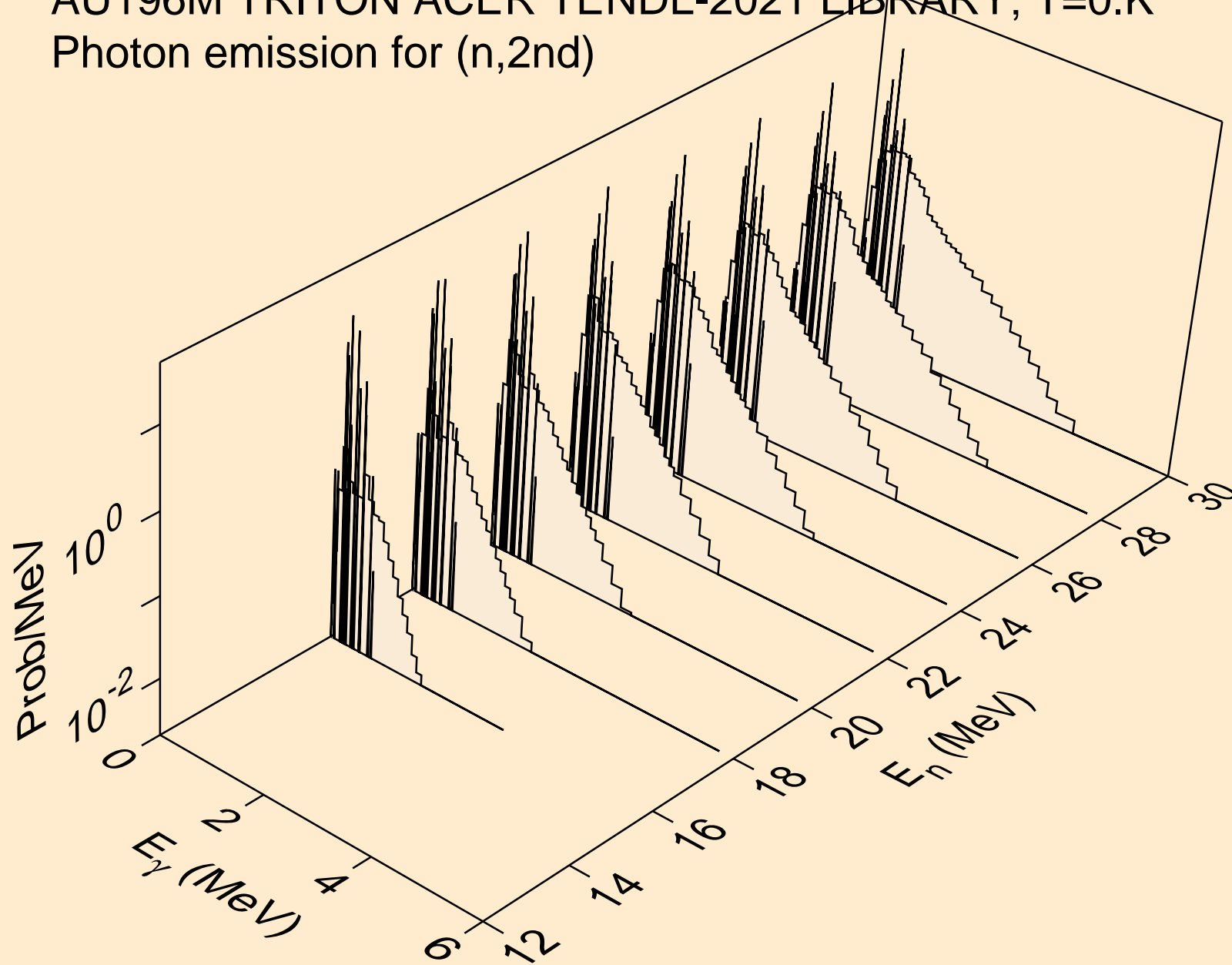



AU196M TRITON ACER TENDL-2021 LIBRARY; T=0.K  
Photon emission for (n,2n)

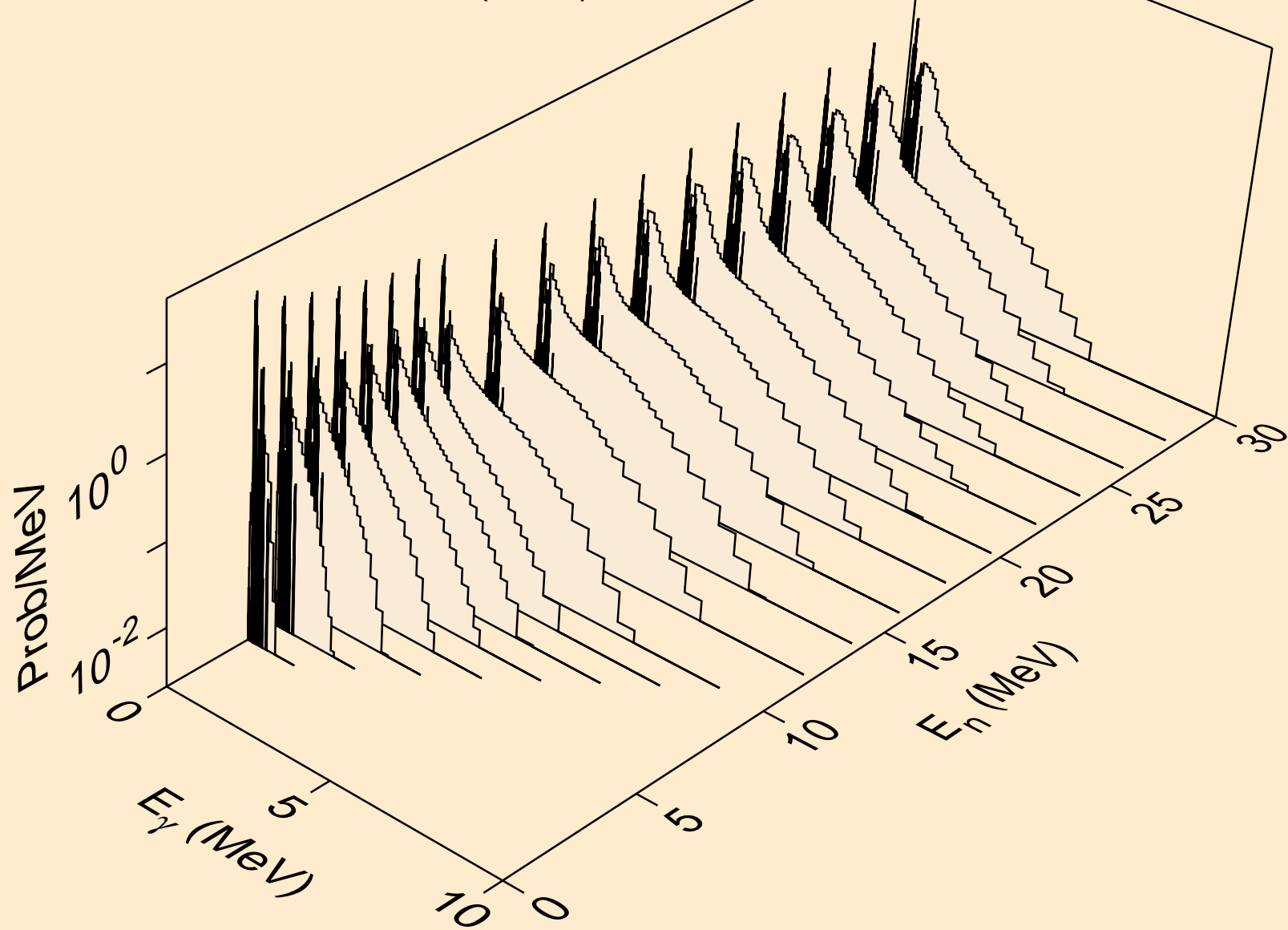

AU196M TRITON ACER TENDL-2021 LIBRARY; T=0.K  
Photon emission for (n,3n)

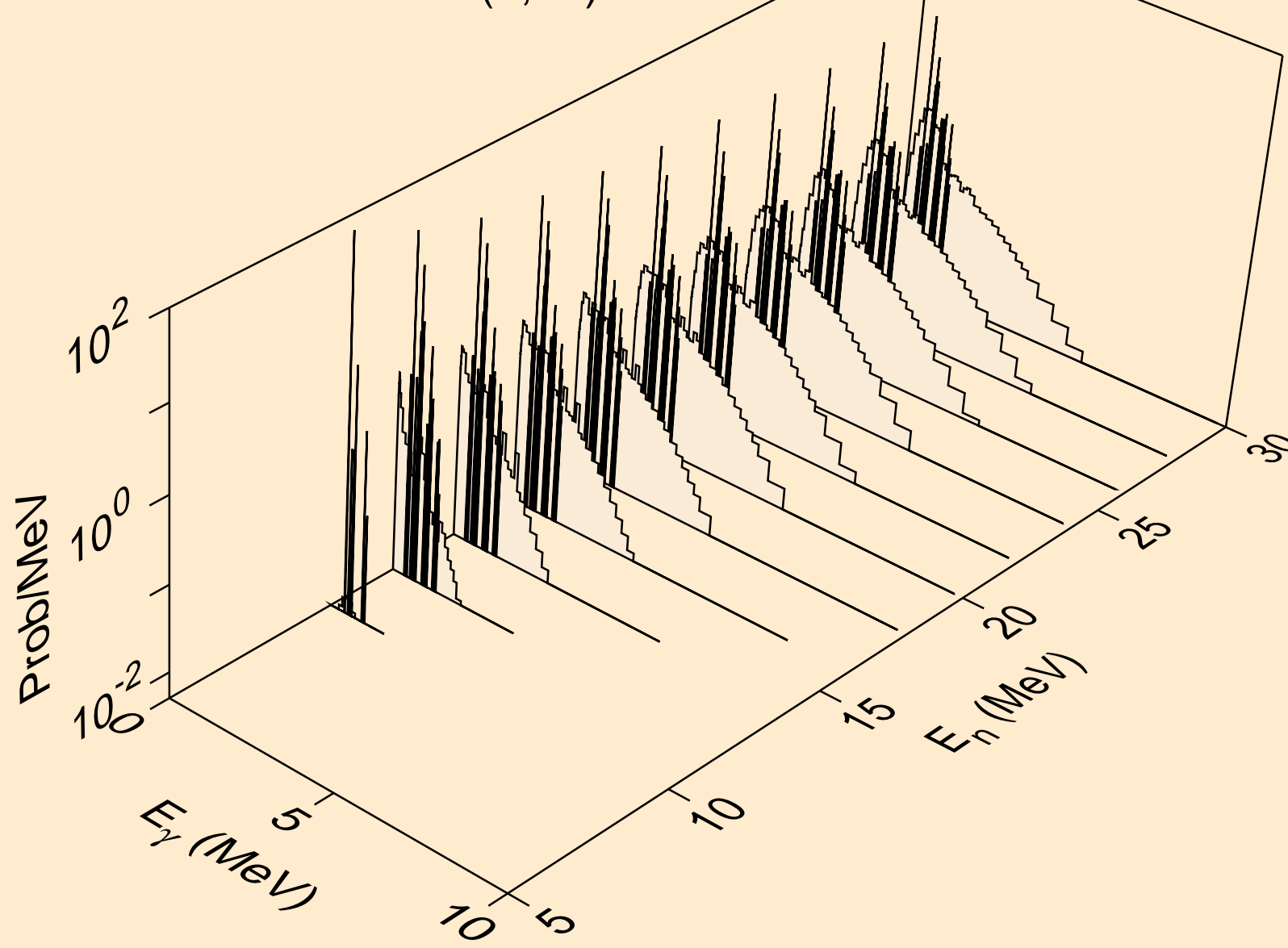

AU196M TRITON ACER TENDL-2021 LIBRARY; T=0.K  
Photon emission for (n,n\*)a

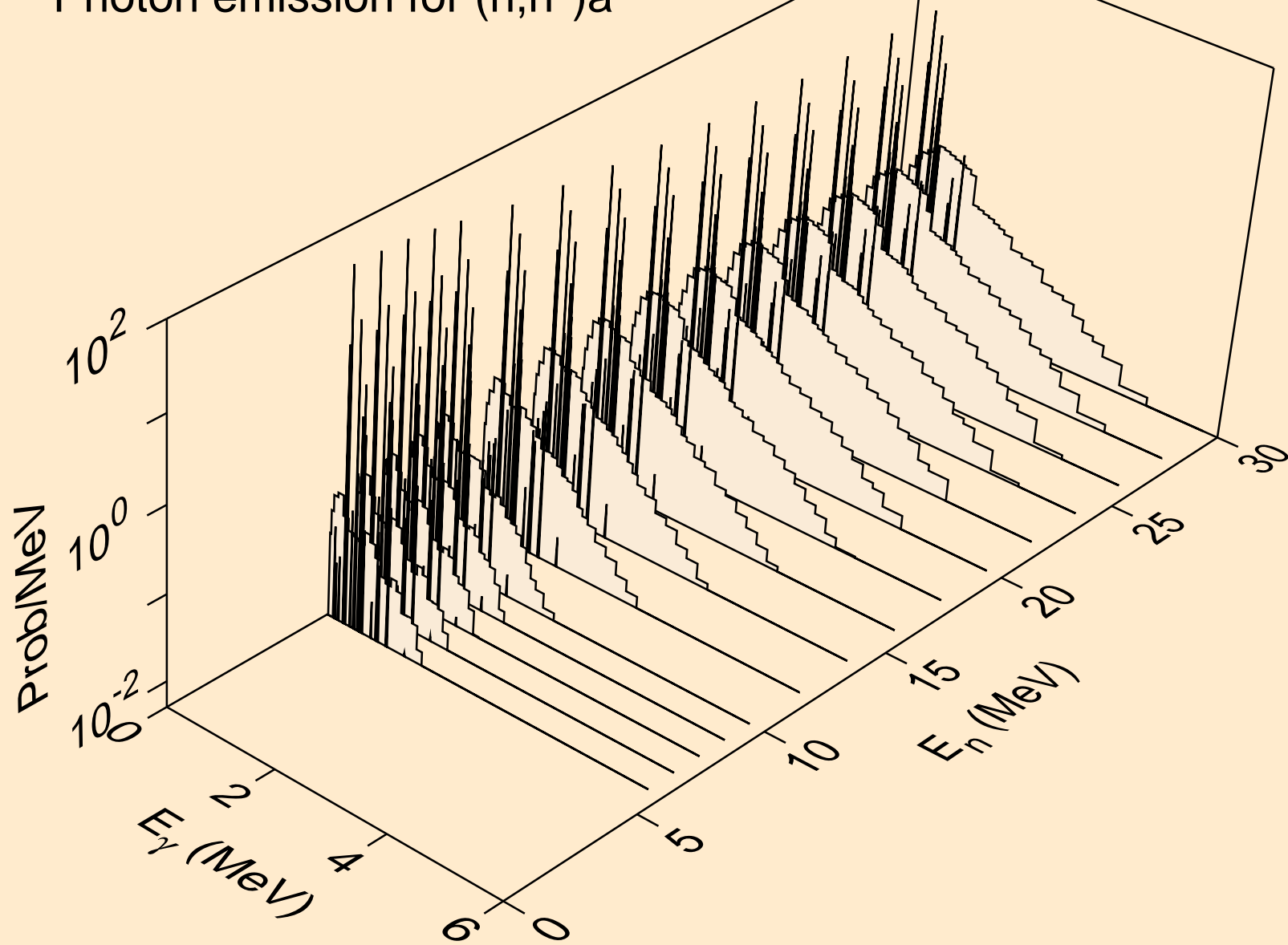

AU196M TRITON ACER TENDL-2021 LIBRARY; T=0.K  
Photon emission for (n,2n)a

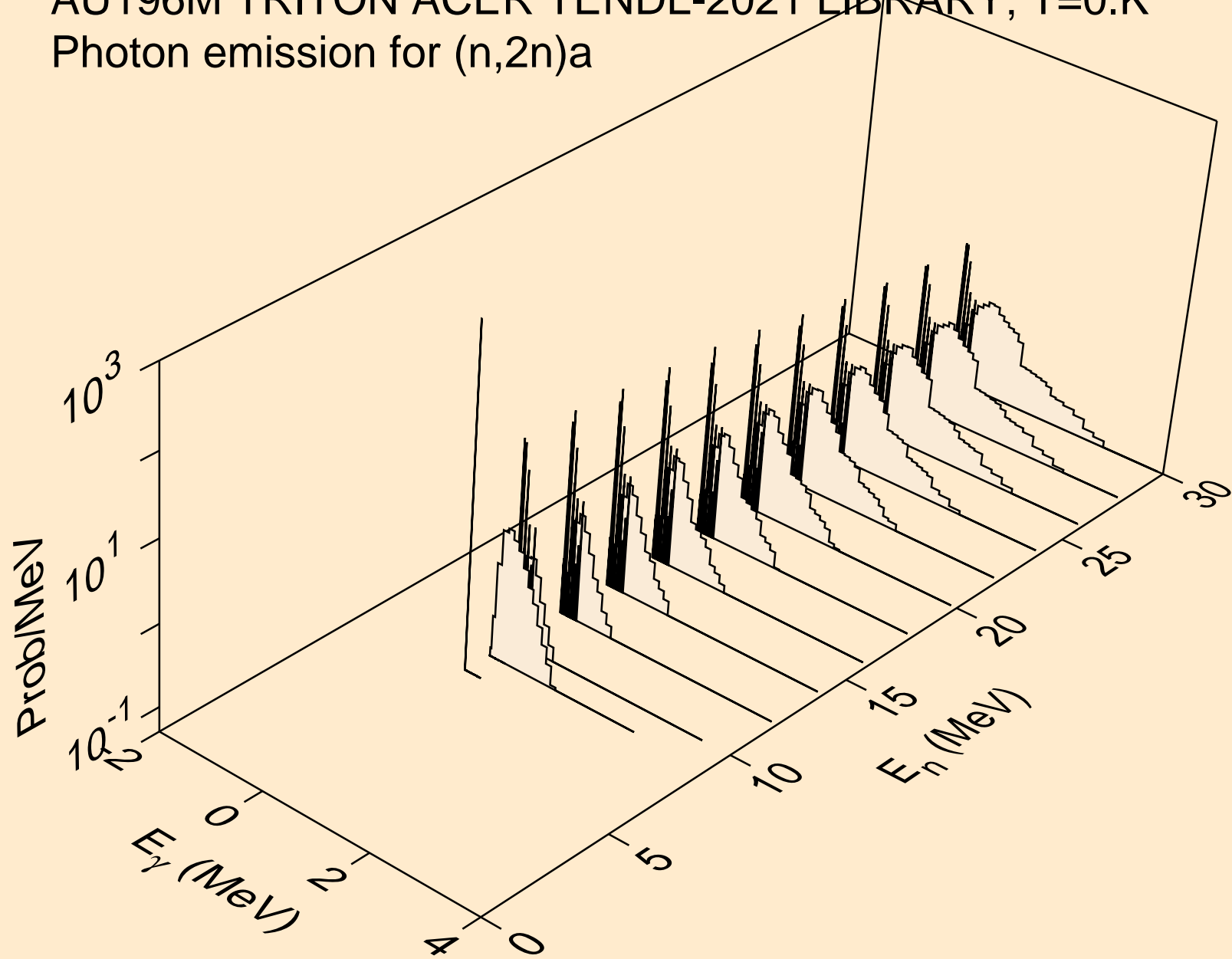

AU196M TRITON ACER TENDL-2021 LIBRARY; T=0.K  
Photon emission for (n,3n)a

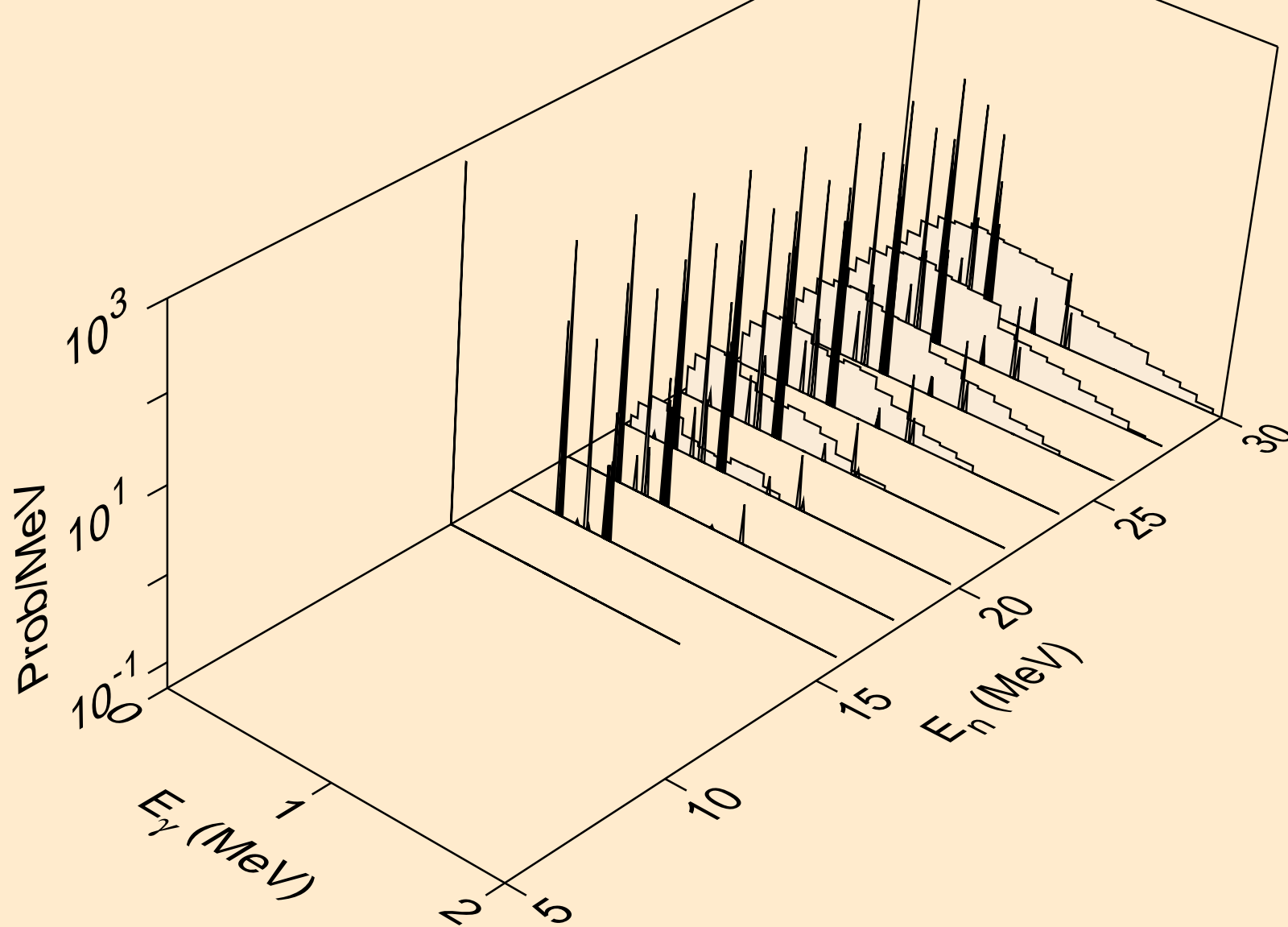

AU196M TRITON ACER TENDL-2021 LIBRARY; T=0.K  
Photon emission for (n,n\*)p

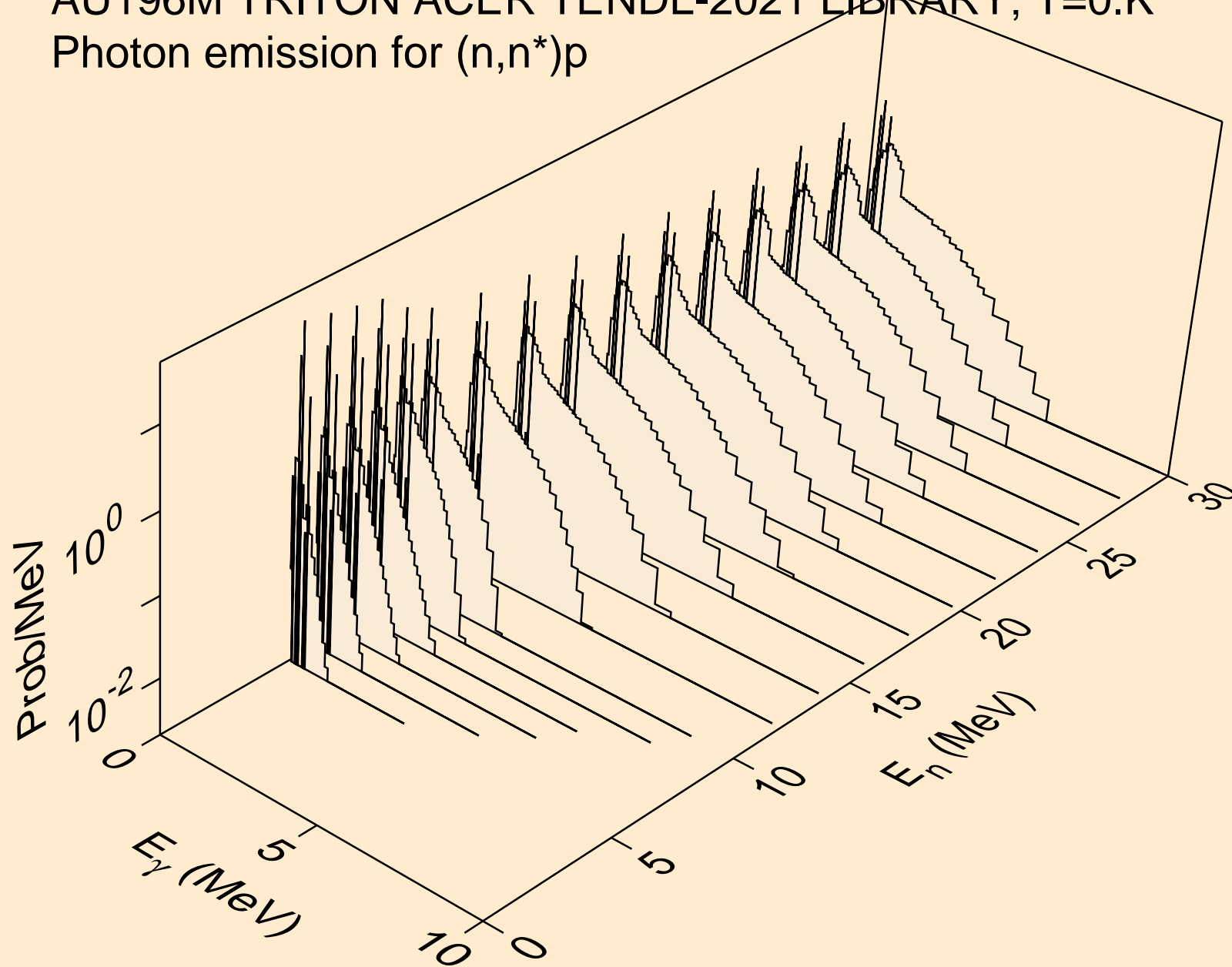

AU196M TRITON ACER TENDL-2021 LIBRARY; T=0.K  
Photon emission for (n,n\*)2a

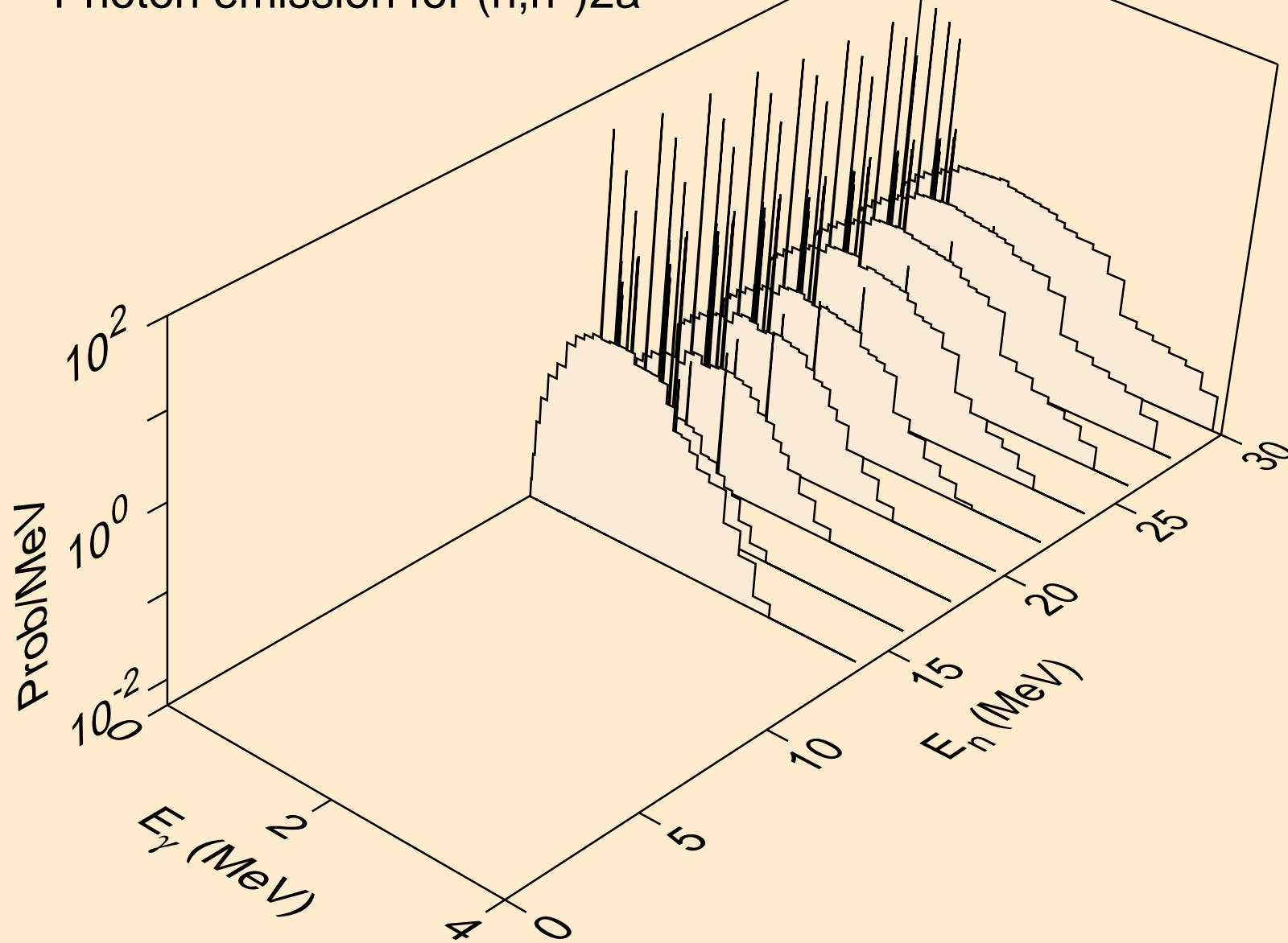

AU196M TRITON ACER TENDL-2021 LIBRARY; T=0.K  
Photon emission for (n,n\*)d

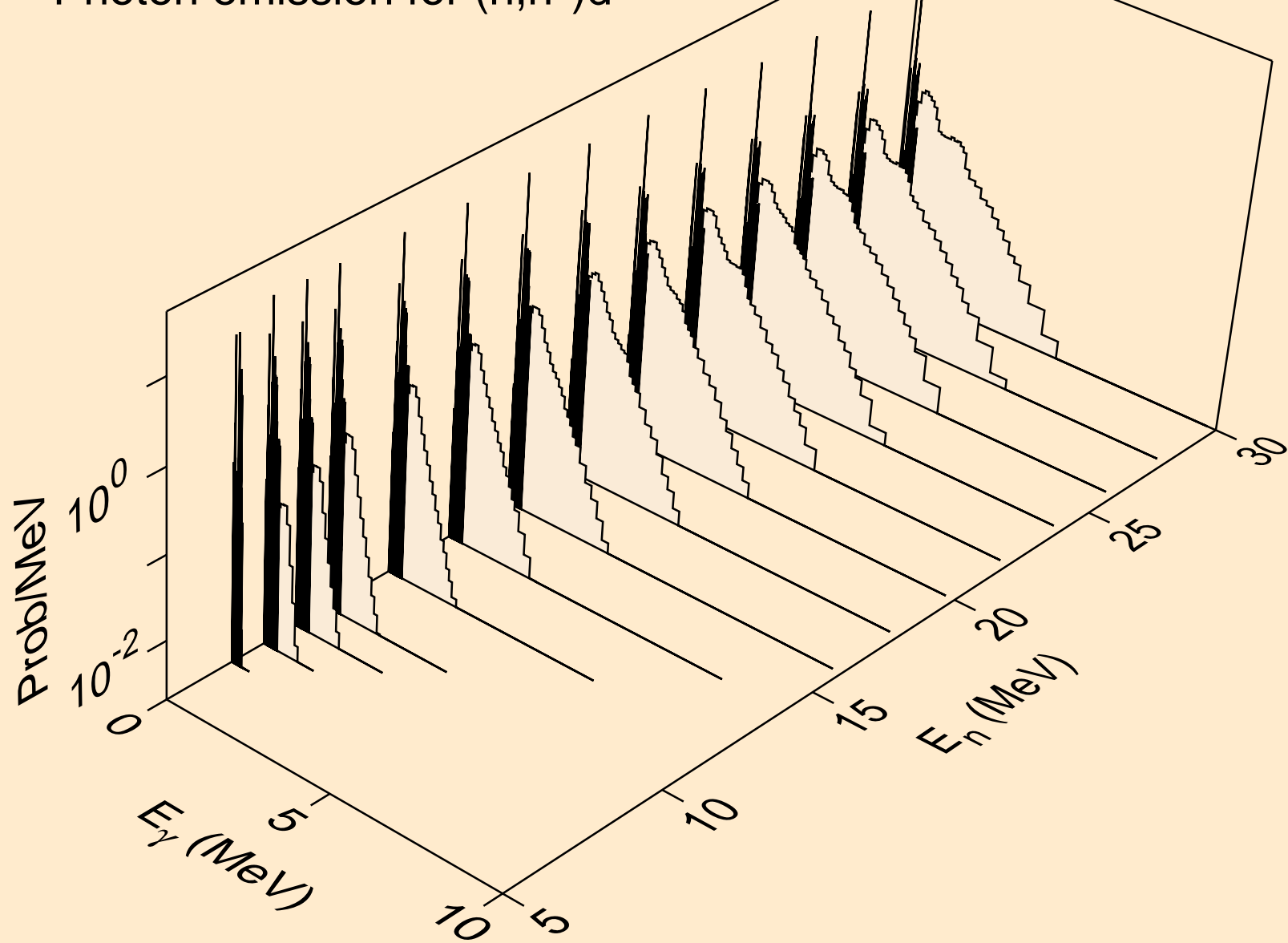



AU196M TRITON ACER TENDL-2021 LIBRARY; T=0.K  
Photon emission for (n,n\*)t

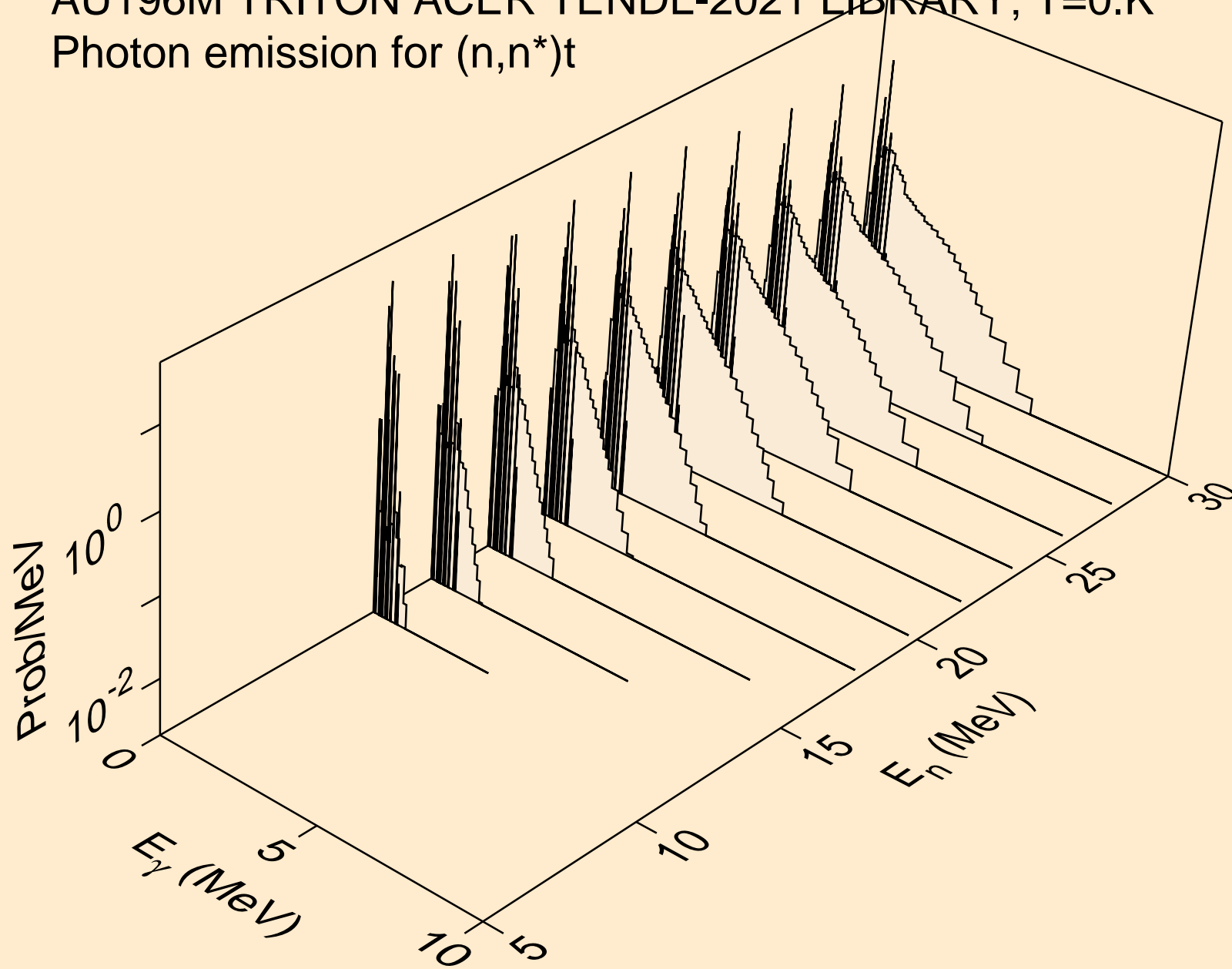

AU196M TRITON ACER TENDL-2021 LIBRARY; T=0.K  
Photon emission for (n,n\*)he3

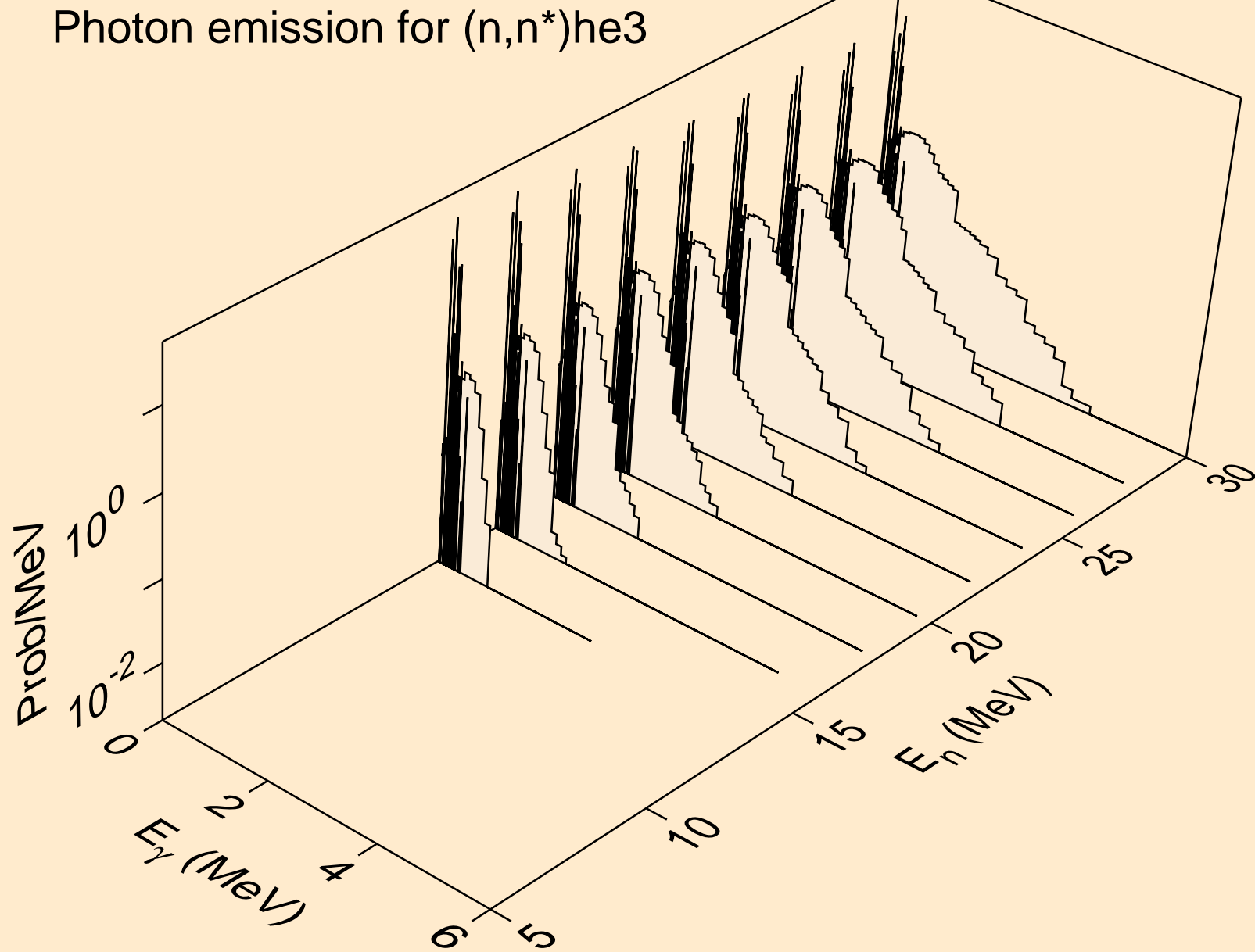

AU196M TRITON ACER TENDL-2021 LIBRARY; T=0.K  
Photon emission for (n,4n)

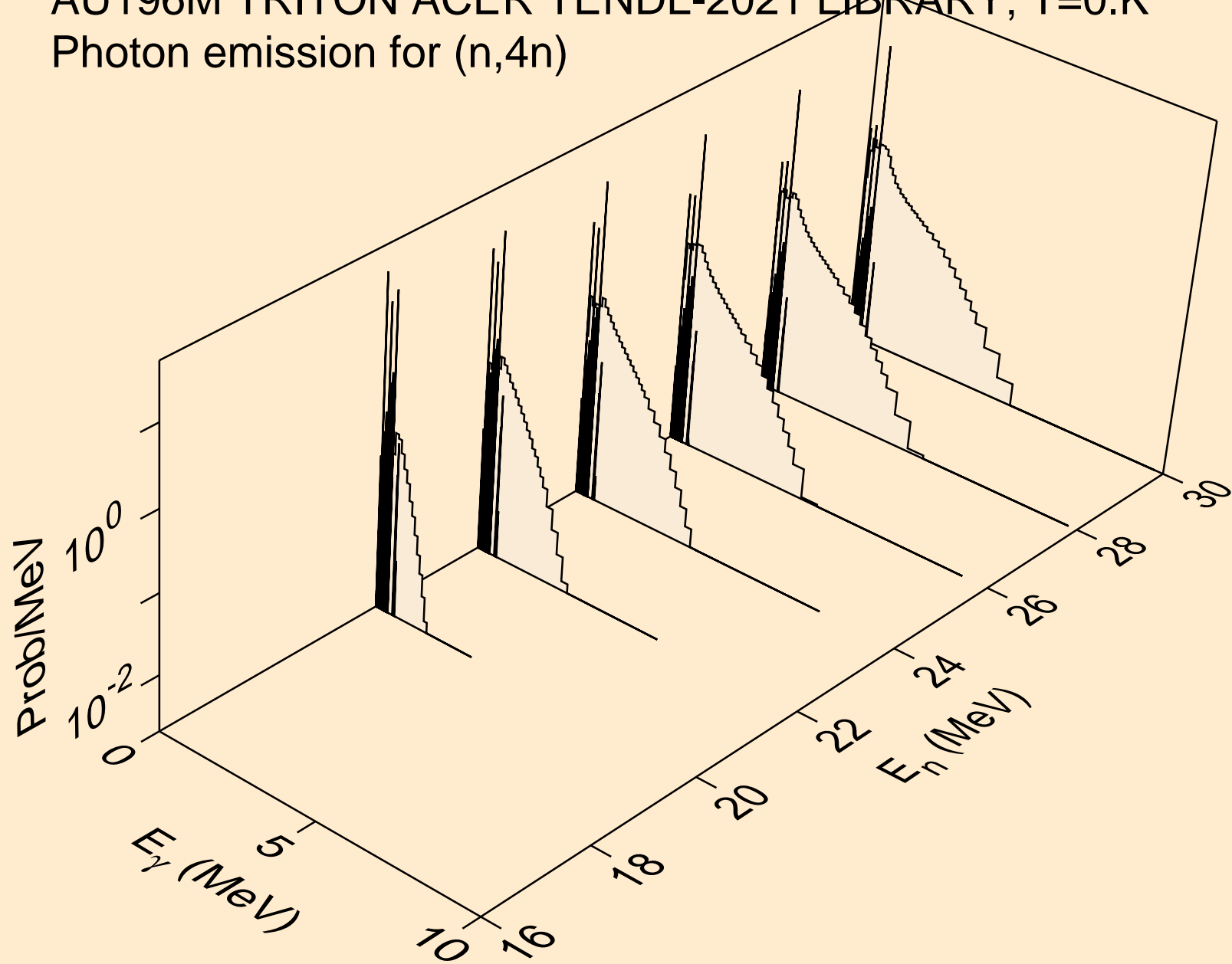

AU196M TRITON ACER TENDL-2021 LIBRARY; T=0.K  
Photon emission for (n,2np)

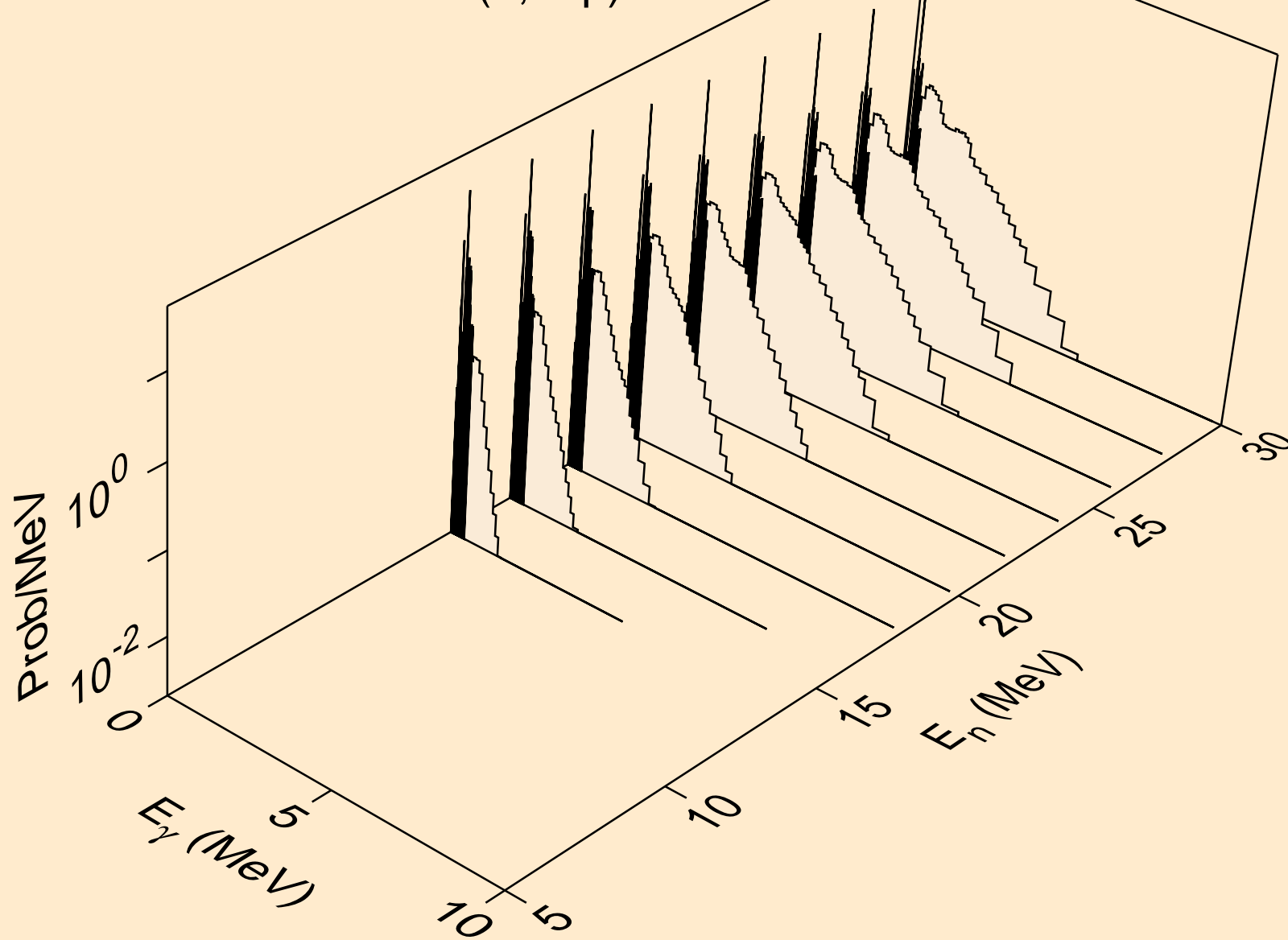

AU196M TRITON ACER TENDL-2021 LIBRARY; T=0.K  
Photon emission for (n,3np)

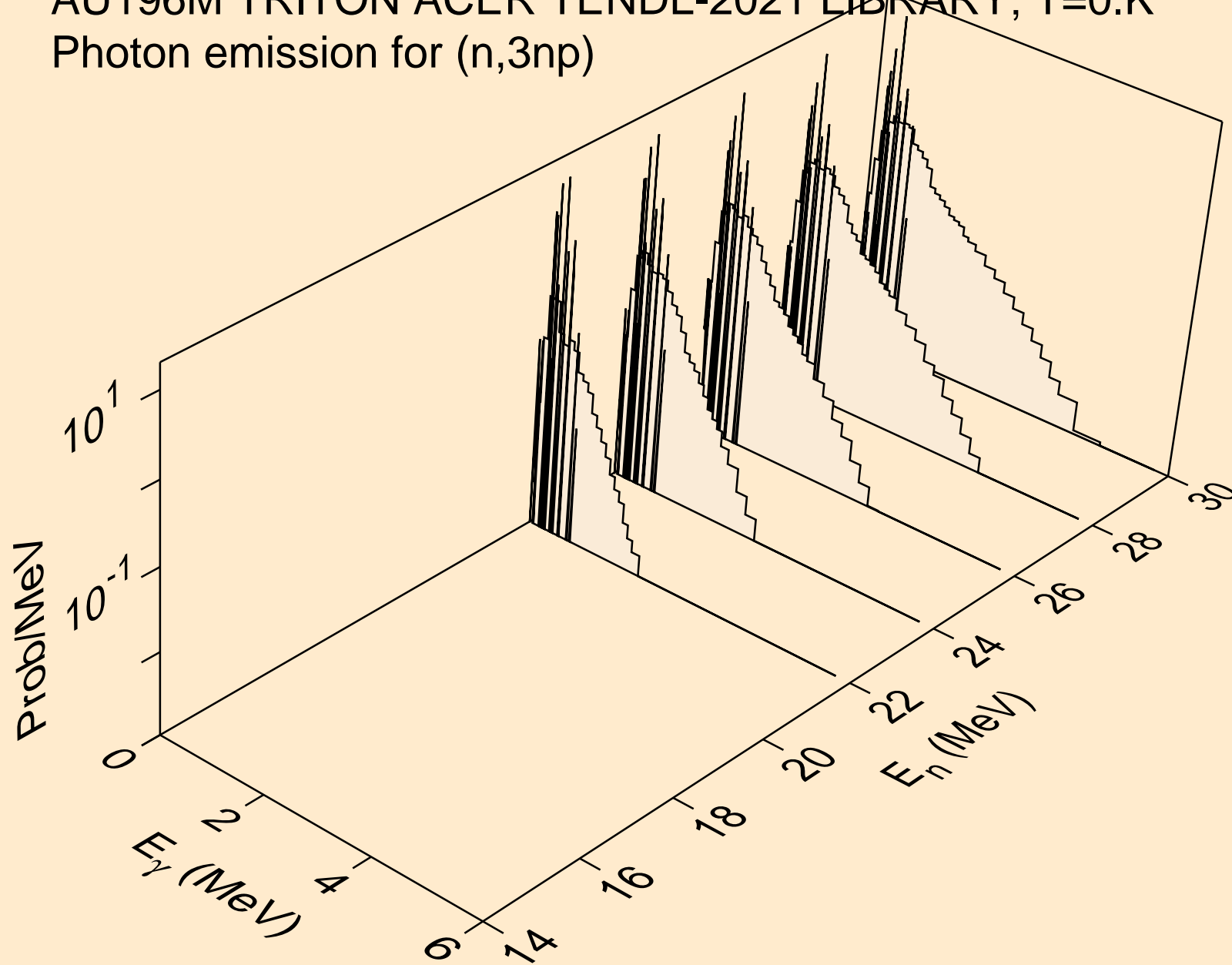

AU196M TRITON ACER TENDL-2021 LIBRARY; T=0.K  
Photon emission for (n,2np)

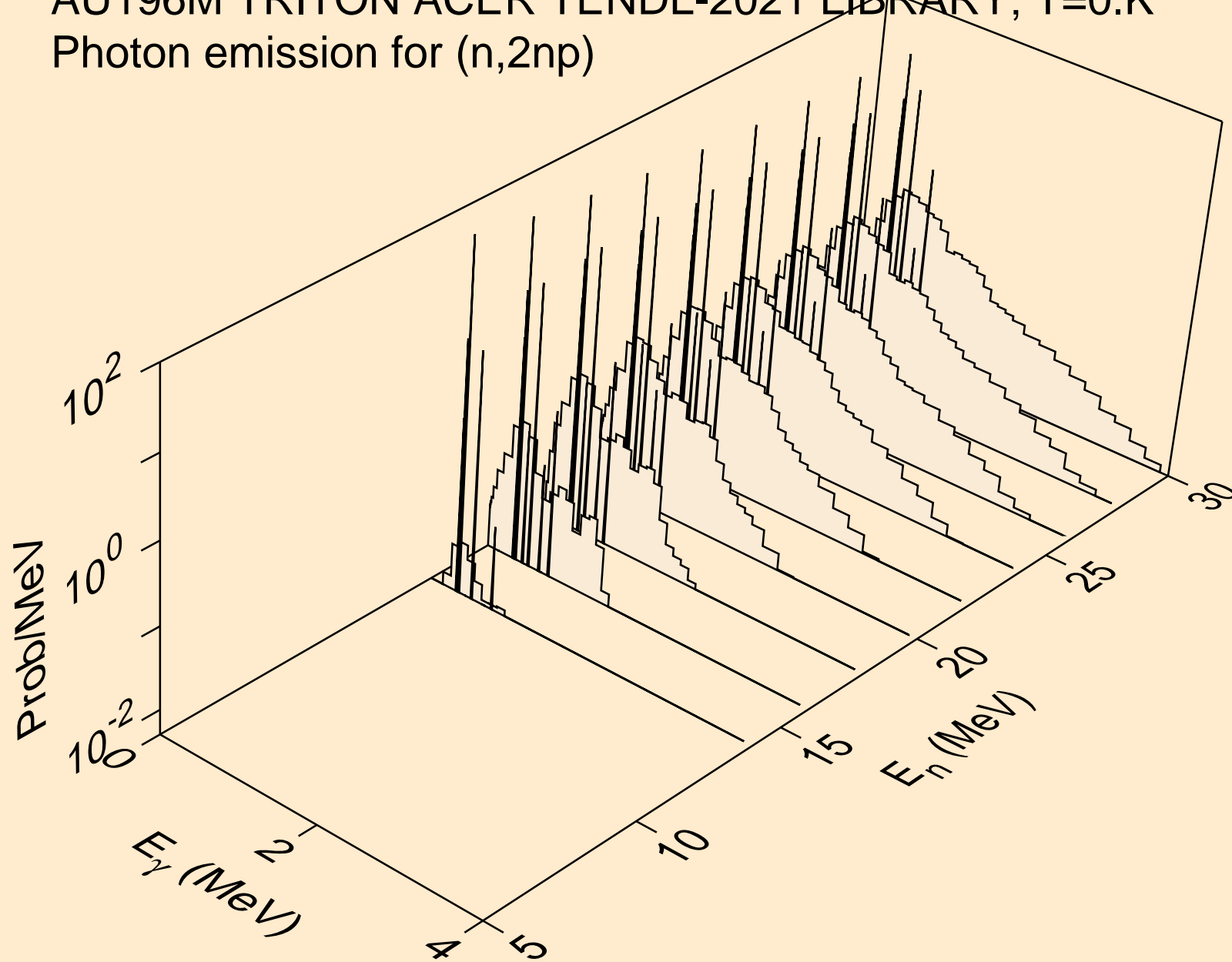

AU196M TRITON ACER TENDL-2021 LIBRARY; T=0.K  
Photon emission for (n,npa)

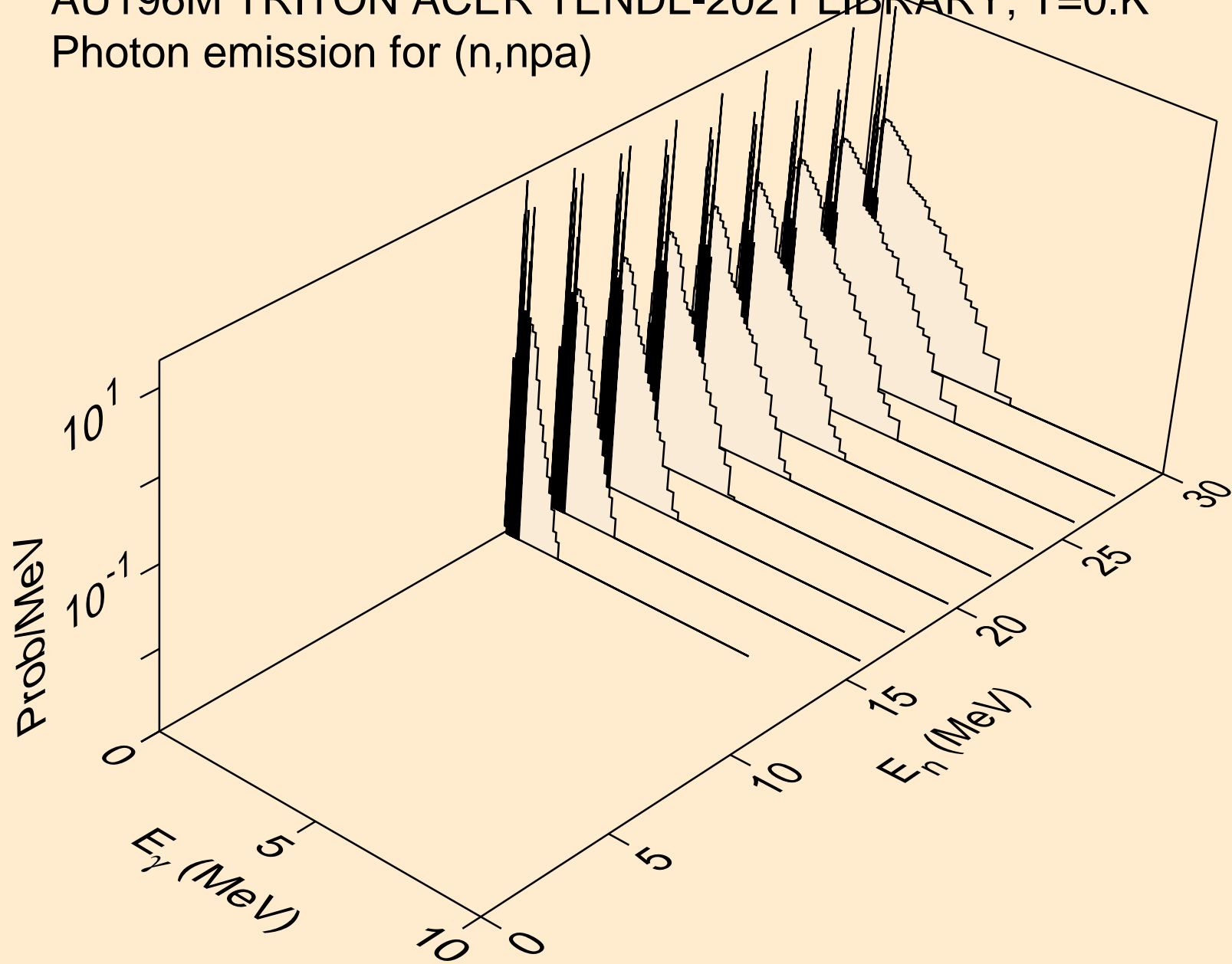

AU196M TRITON ACER TENDL-2021 LIBRARY; T=0.K  
Photon emission for (n,gma)

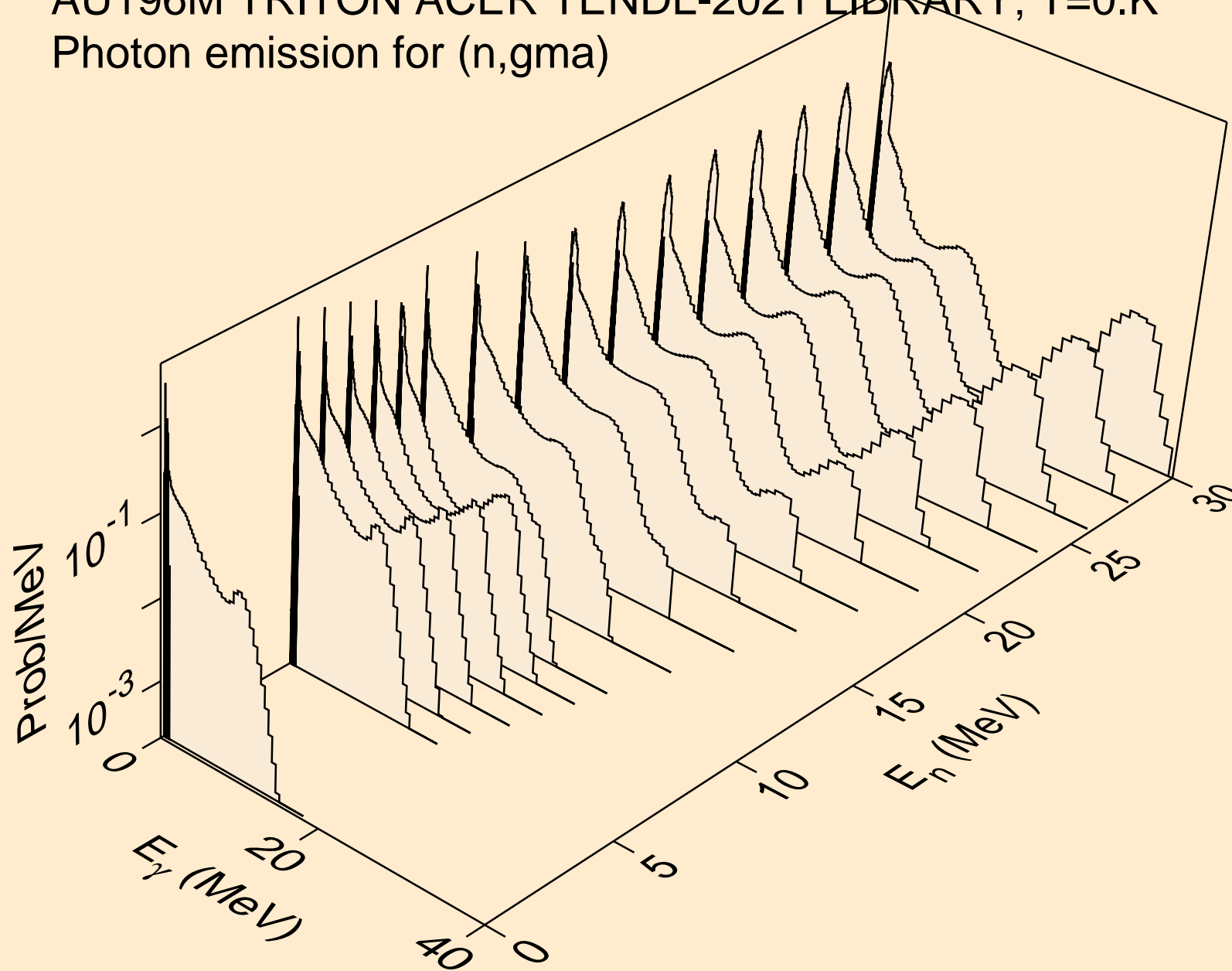



AU196M TRITON ACER TENDL-2021 LIBRARY; T=0.K  
Photon emission for (n,p)

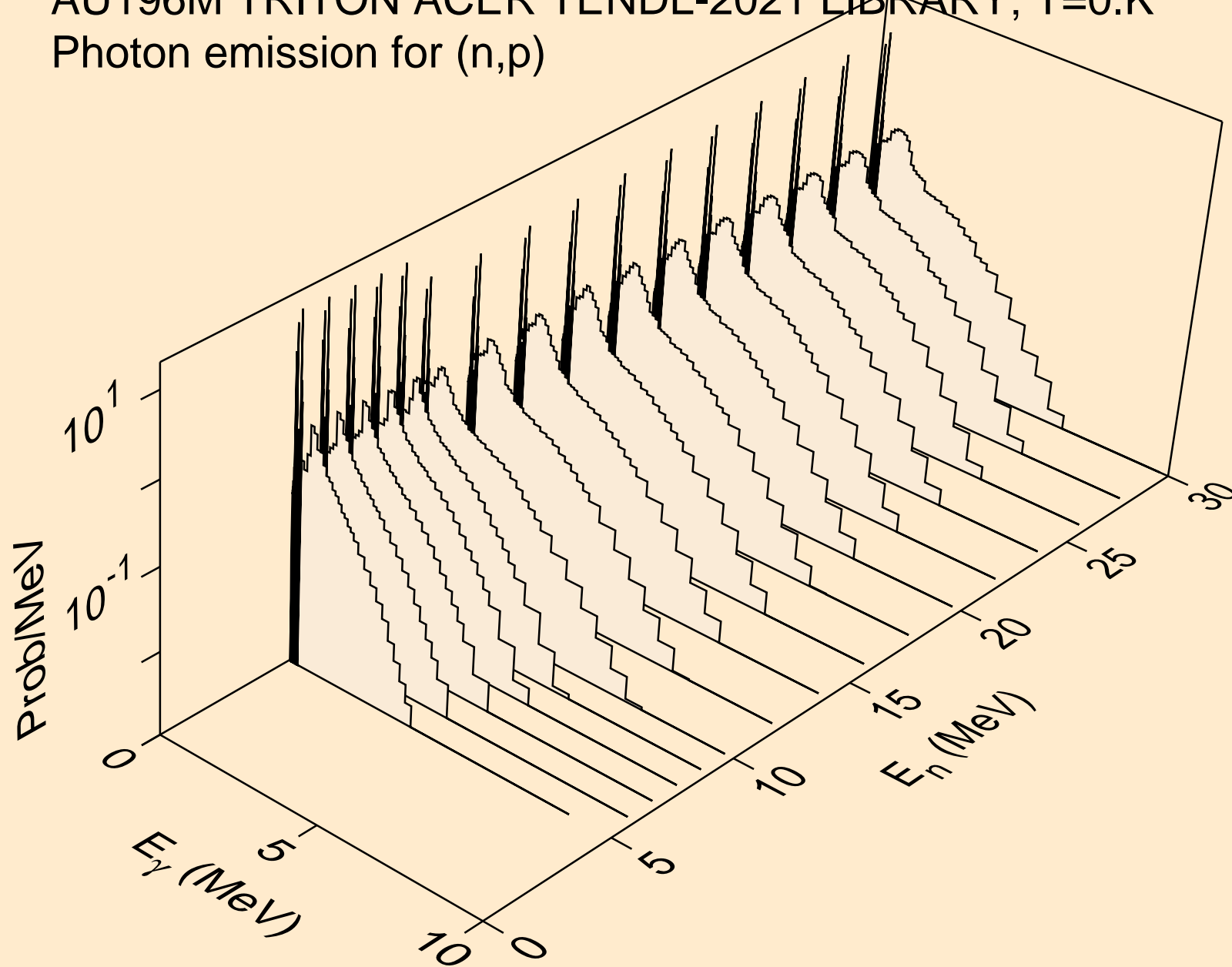

AU196M TRITON ACER TENDL-2021 LIBRARY; T=0.K  
Photon emission for (n,d)

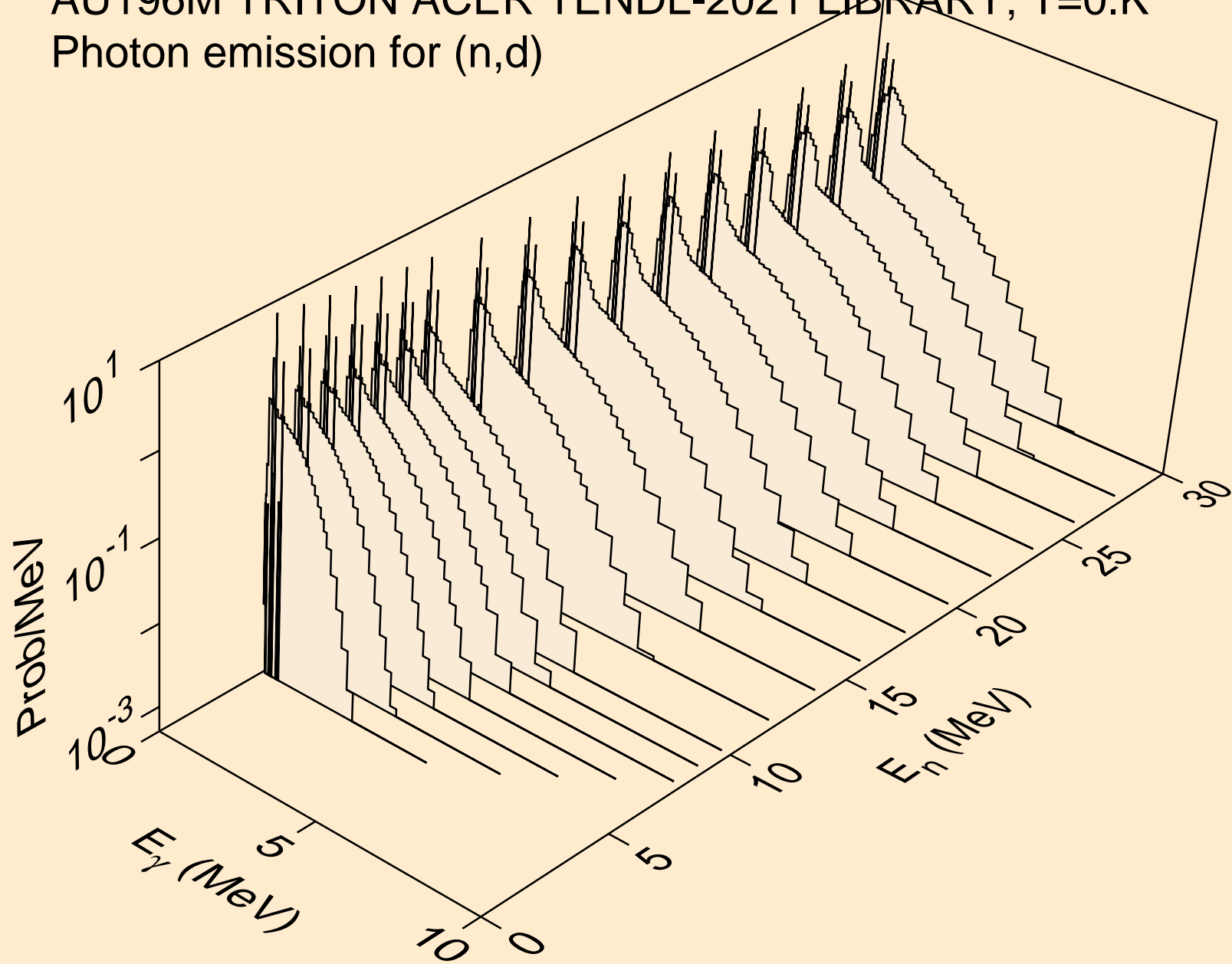

AU196M TRITON ACER TENDL-2021 LIBRARY; T=0.K  
Photon emission for inelastic

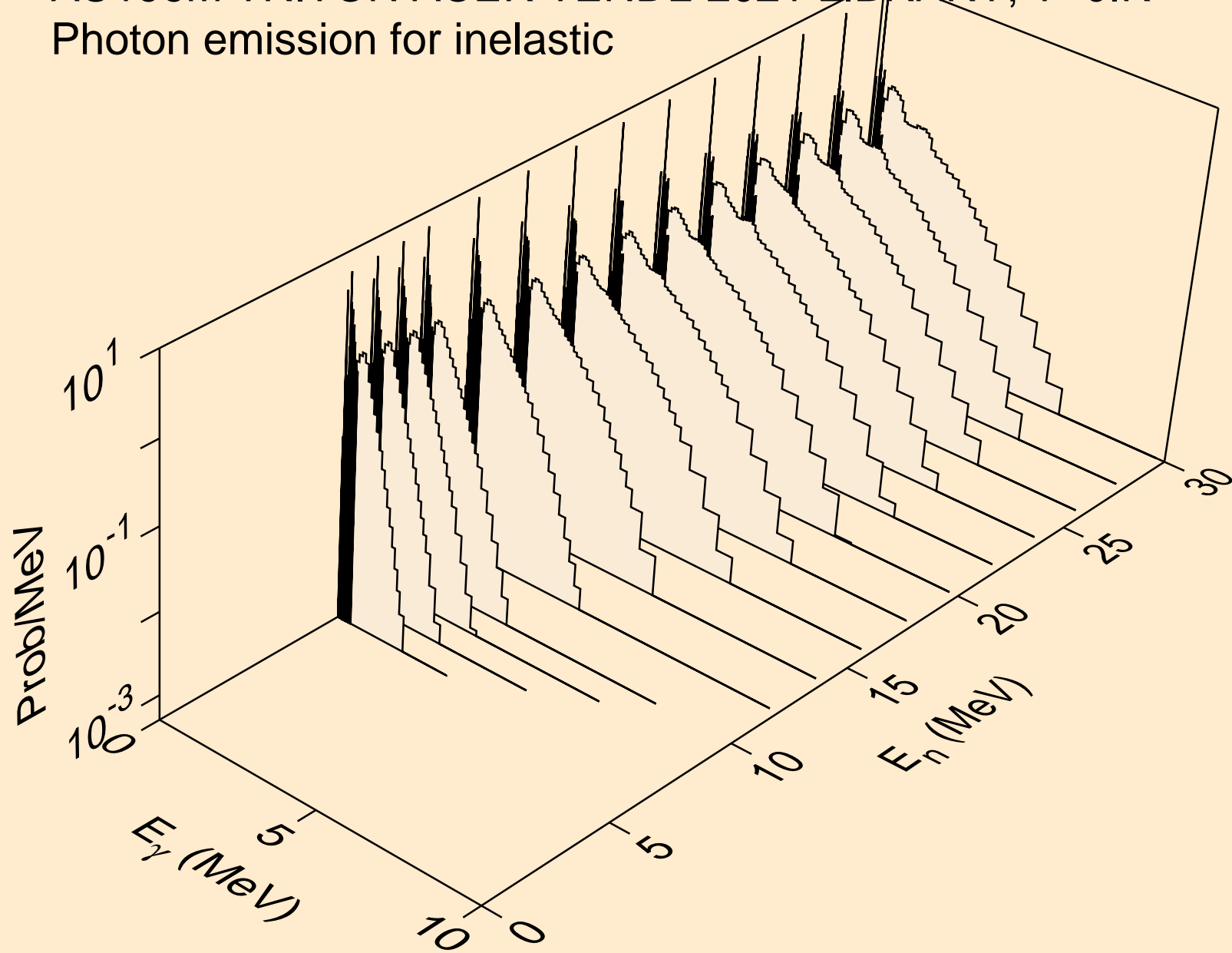

AU196M TRITON ACER TENDL-2021 LIBRARY; T=0.K  
Photon emission for (n,he3)

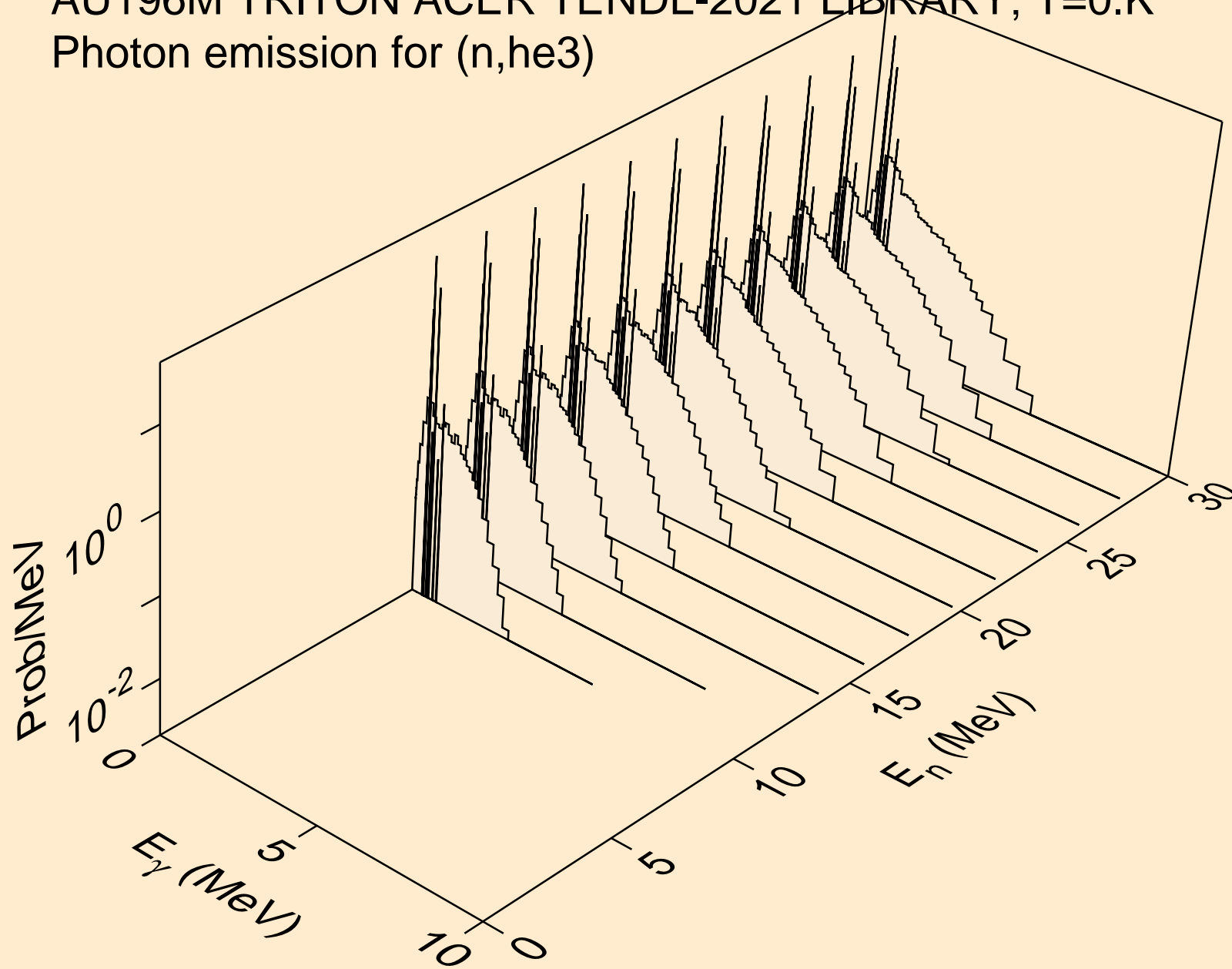

AU196M TRITON ACER TENDL-2021 LIBRARY; T=0.K  
Photon emission for (n,a)

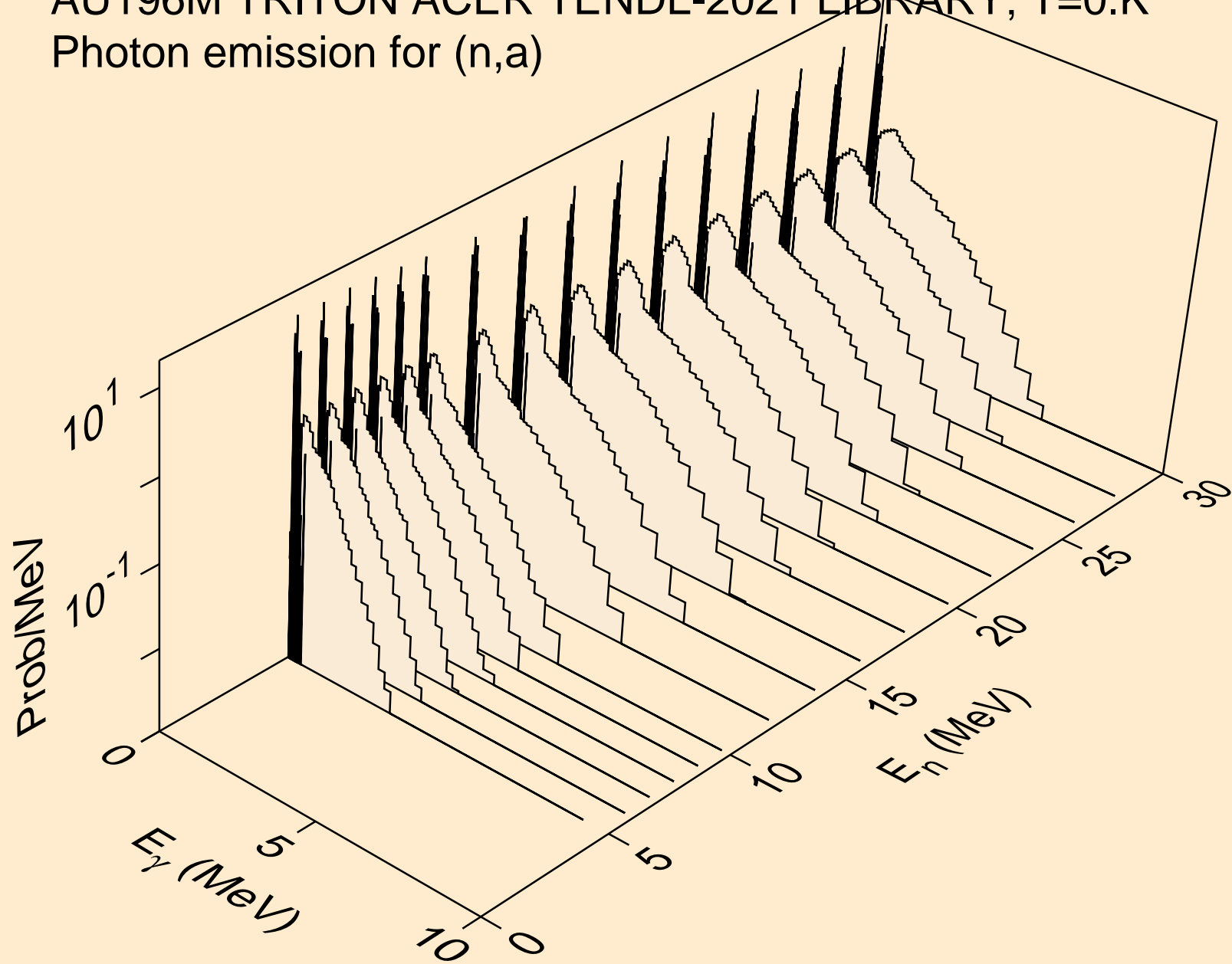

AU196M TRITON ACER TENDL-2021 LIBRARY; T=0.K  
Photon emission for (n,2a)

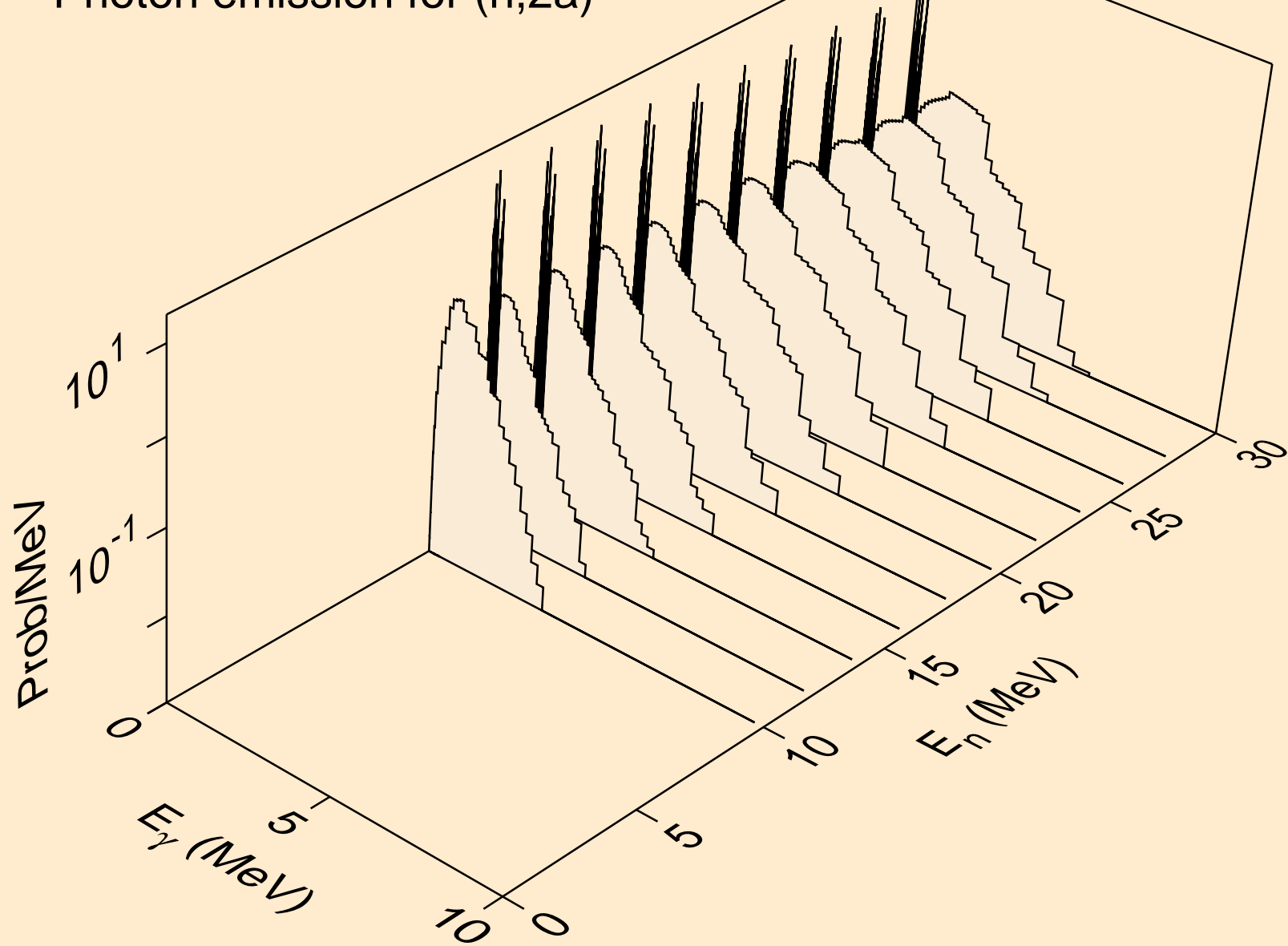

AU196M TRITON ACER TENDL-2021 LIBRARY; T=0.K  
Photon emission for (n,2p)

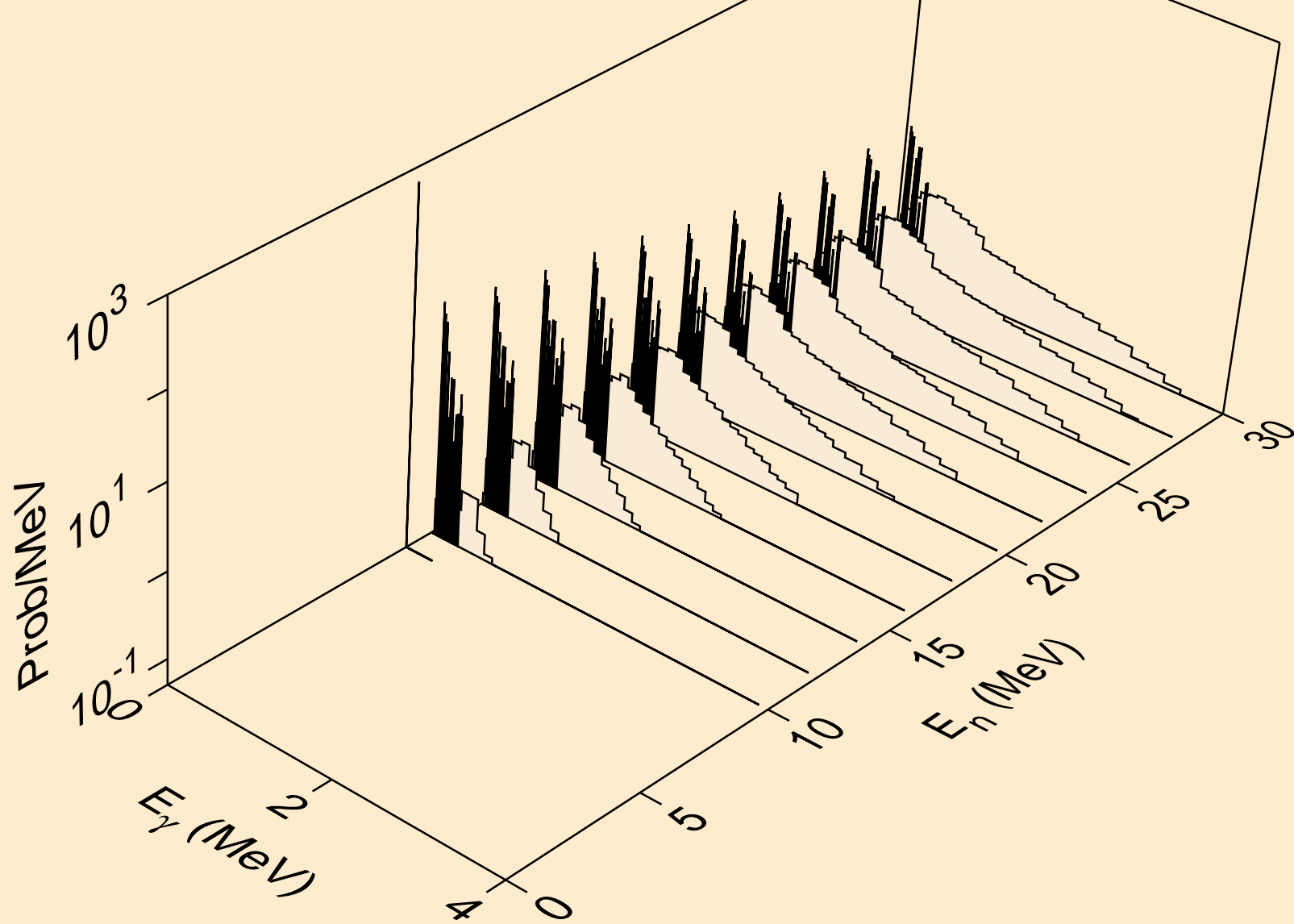

AU196M TRITON ACER TENDL-2021 LIBRARY; T=0.K  
Photon emission for (n,pa)

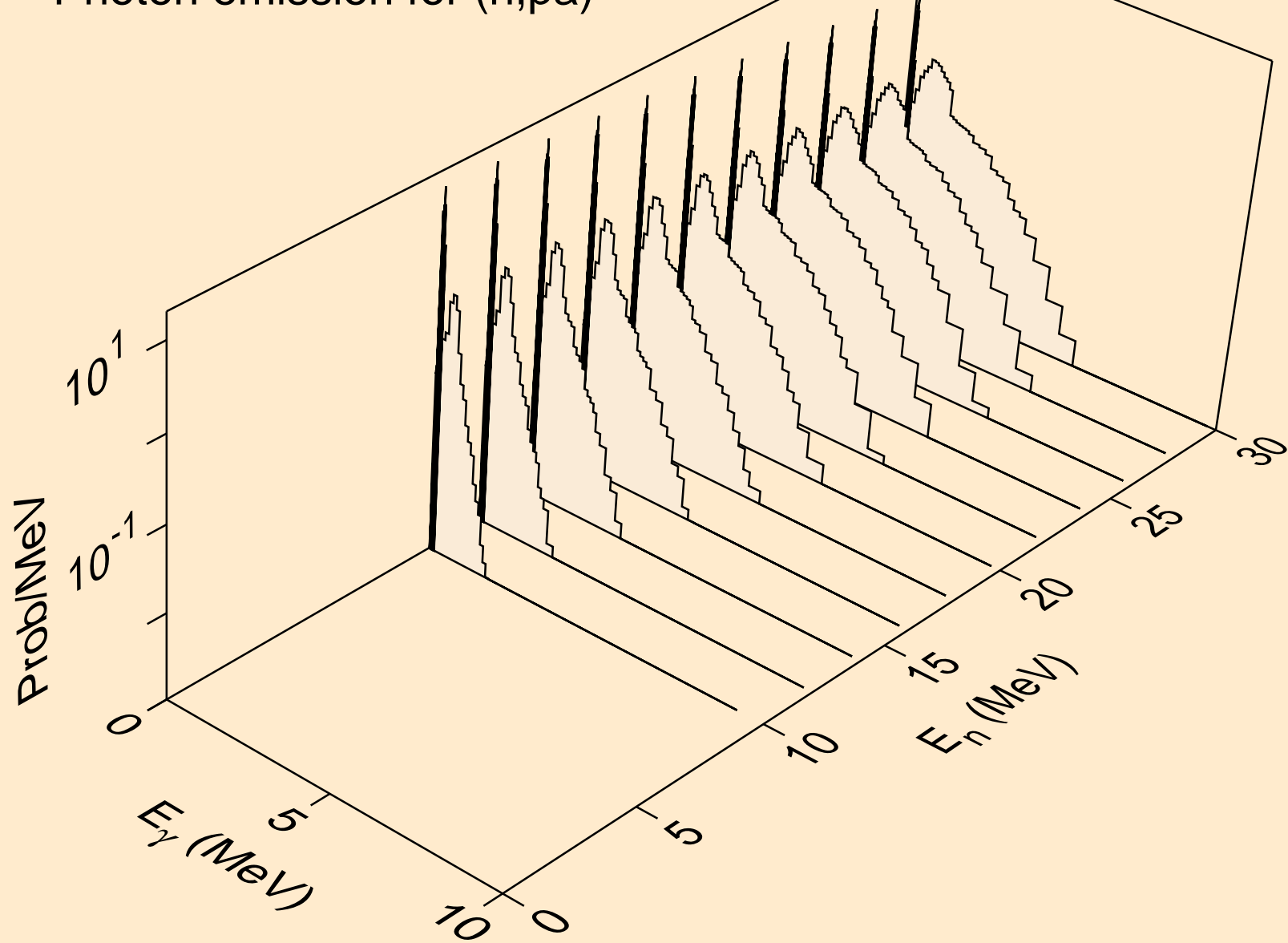



AU196M TRITON ACER TENDL-2021 LIBRARY; T=0.K  
Photon emission for (n,pd)

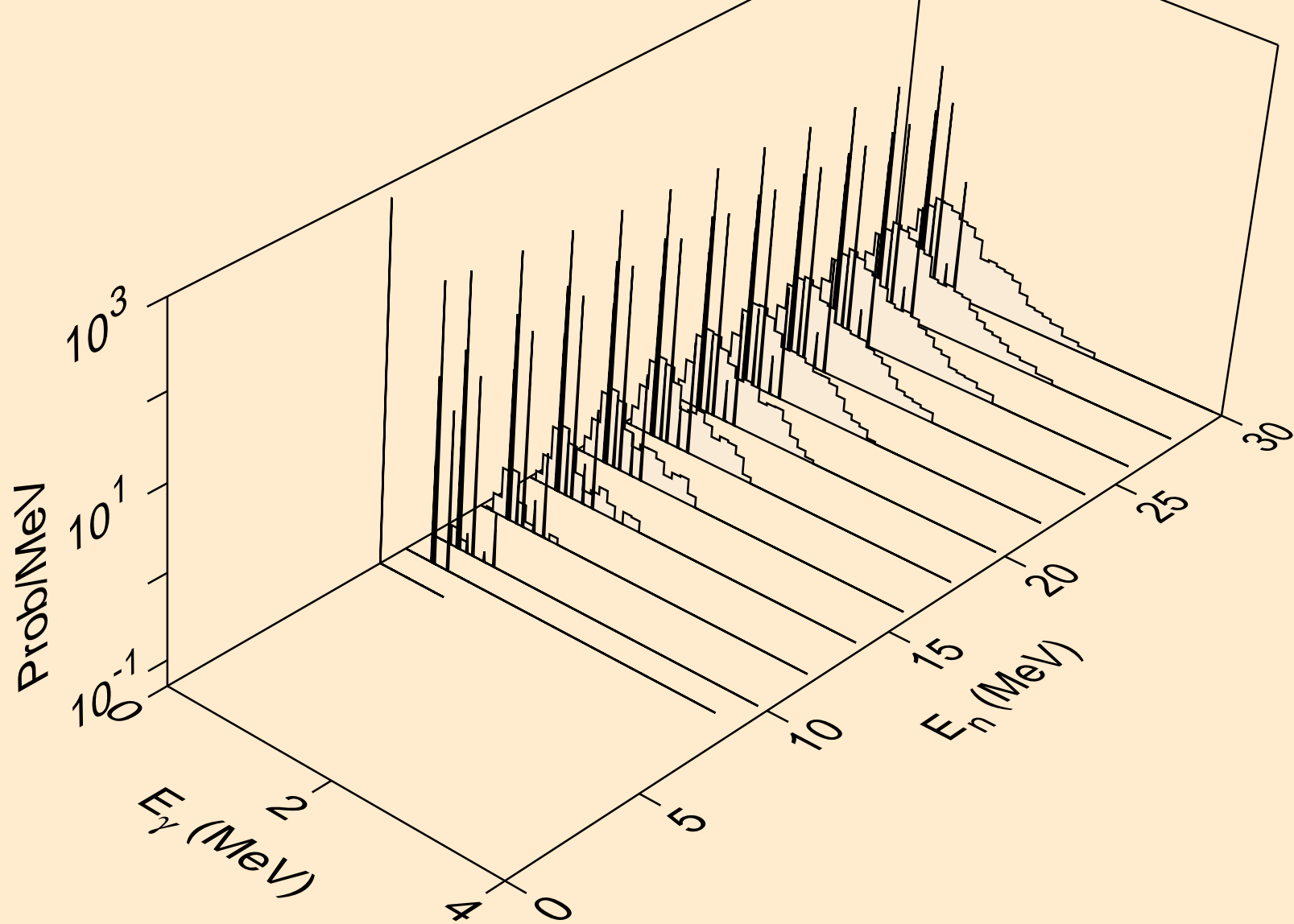

AU196M TRITON ACER TENDL-2021 LIBRARY; T=0.K  
Photon emission for (n,pt)

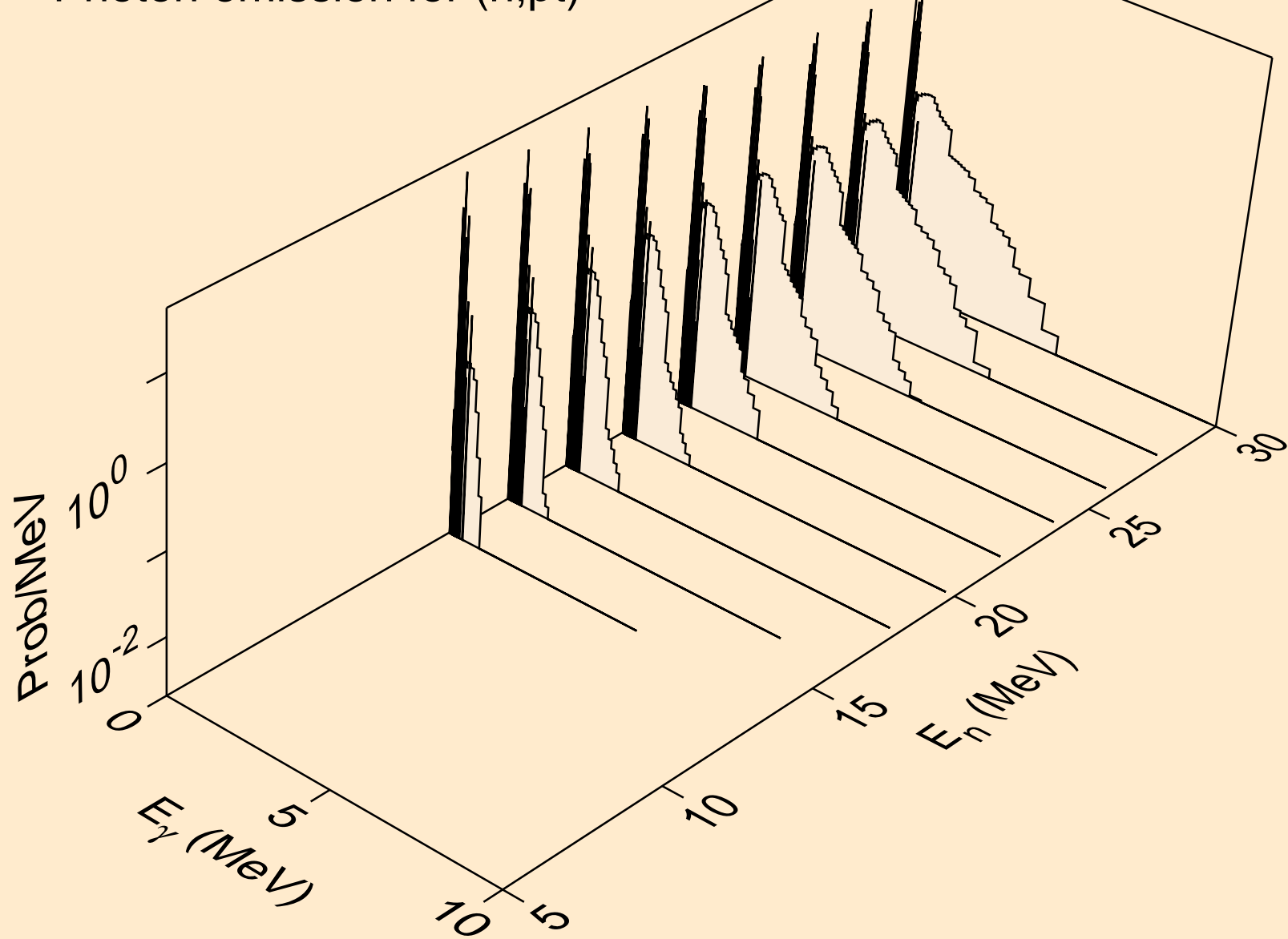

AU196M TRITON ACER TENDL-2021 LIBRARY; T=0.K  
Photon emission for (n,da)

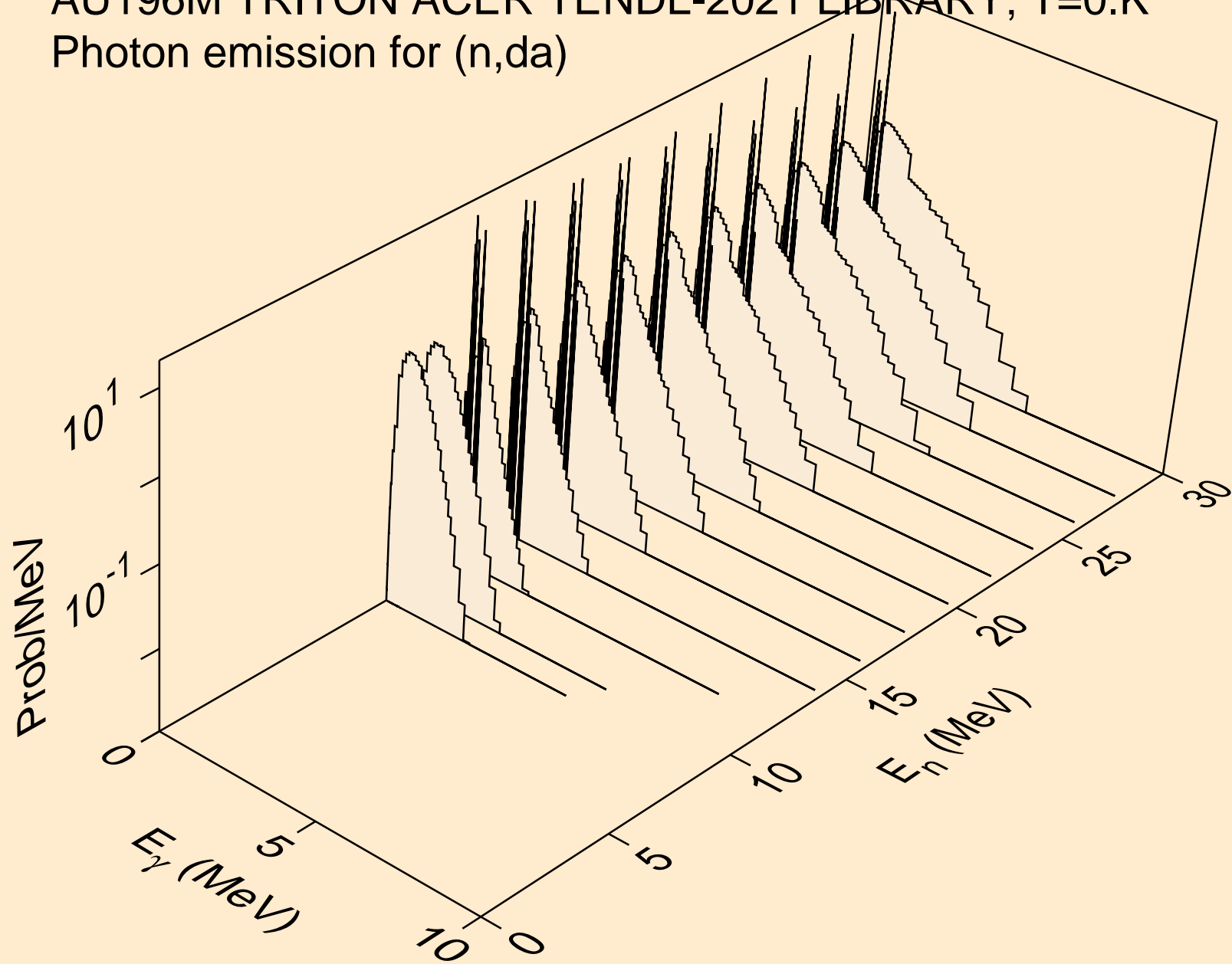

AU196M TRITON ACER TENDL-2021 LIBRARY; T=0.K  
Particle heating contributions

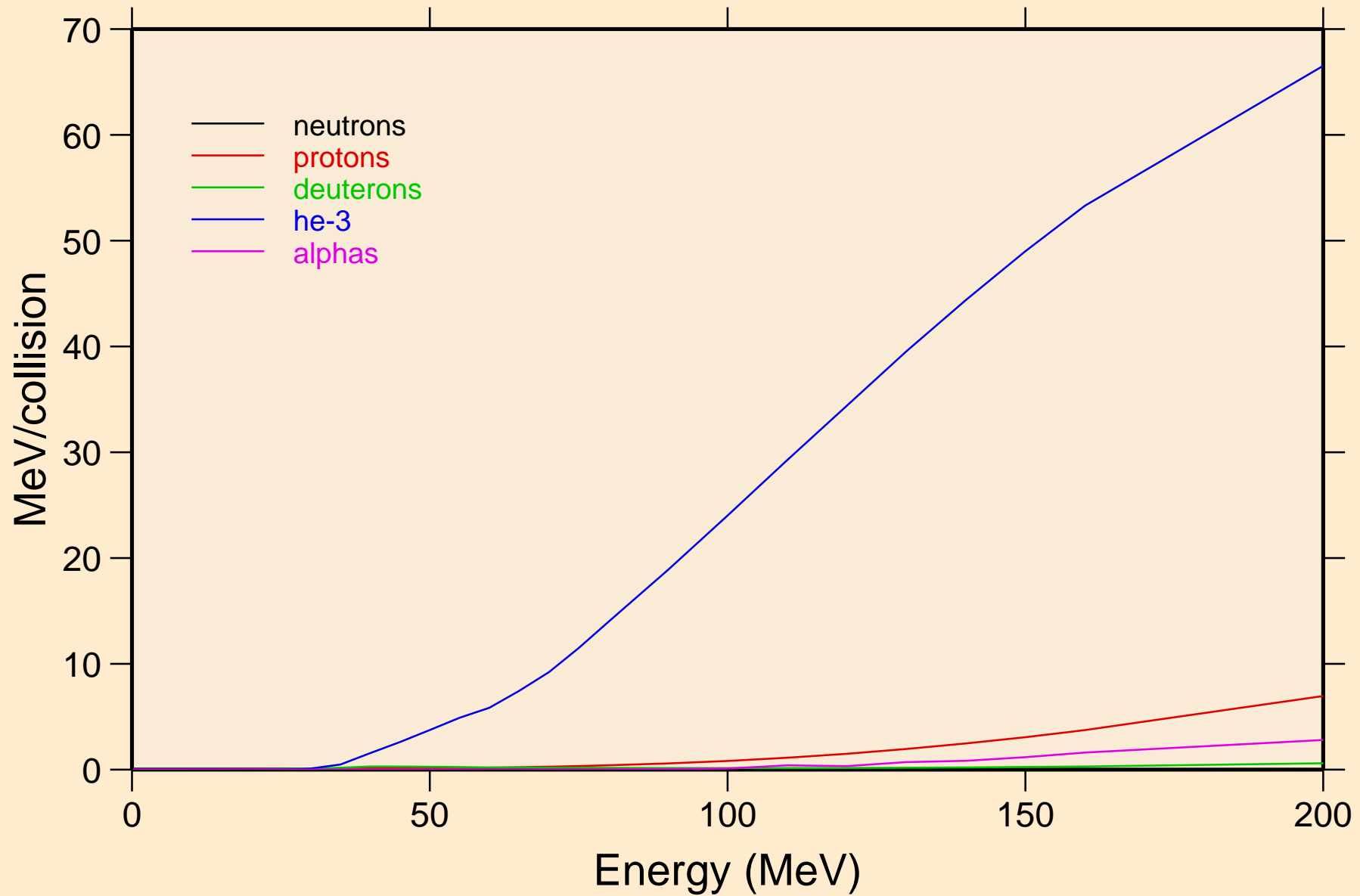

AU196M TRITON ACER TENDL-2021 LIBRARY; T=0.K  
Recoil Heating

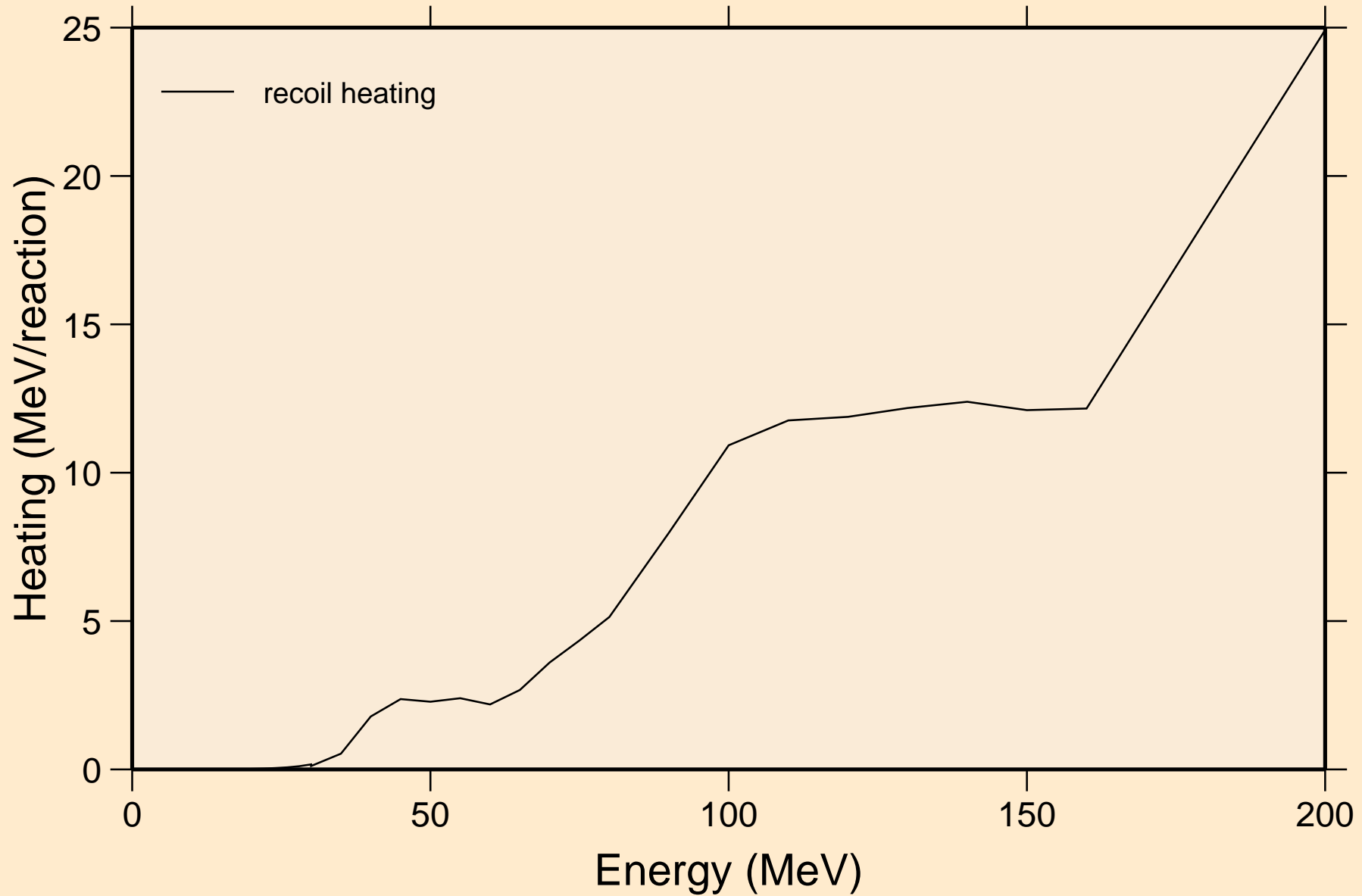

AU196M TRITON ACER TENDL-2021 LIBRARY; T=0.K  
Particle production cross sections

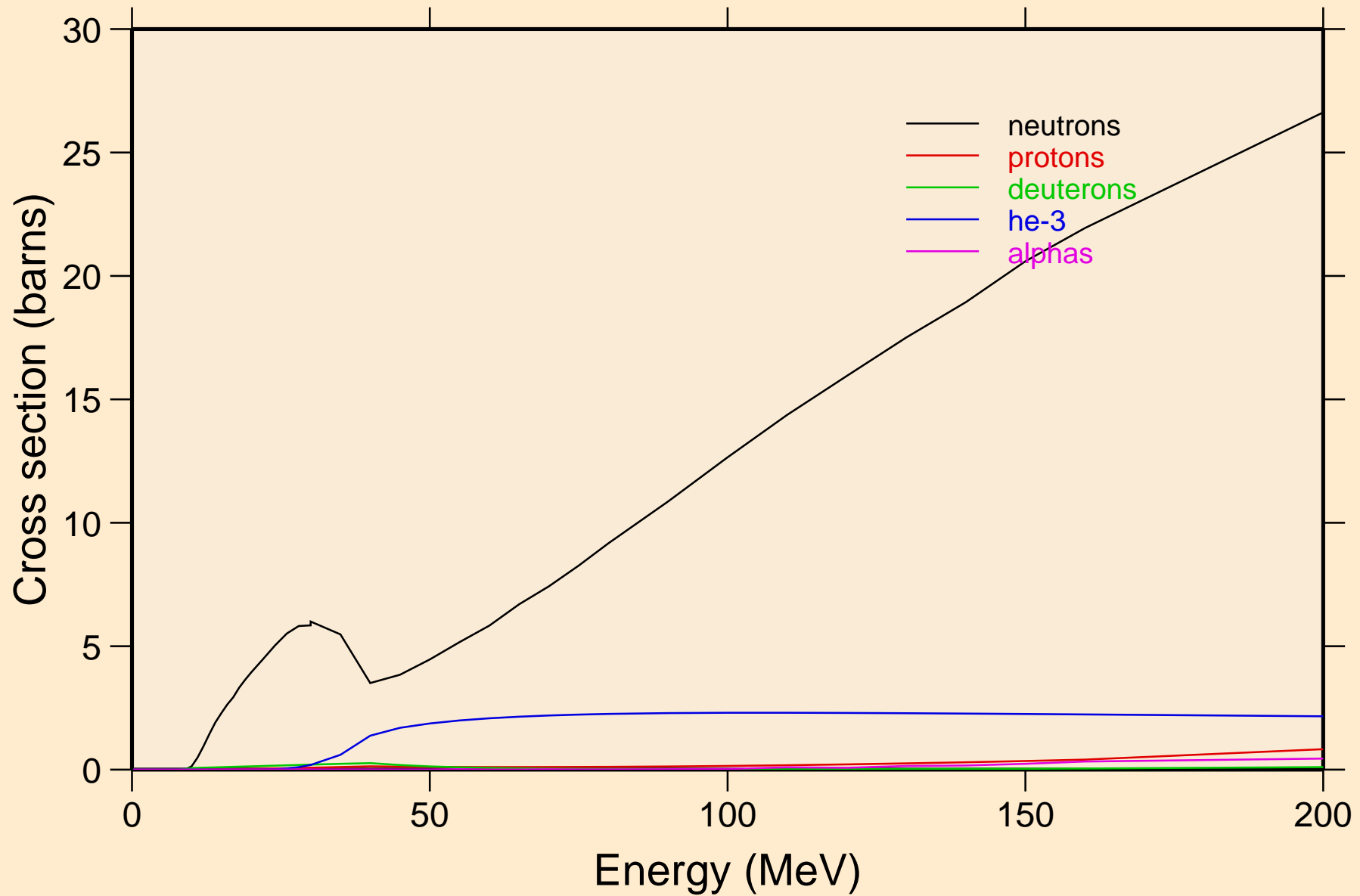

AU196M TRITON ACER TENDL-2021 LIBRARY; T=0.K  
neutrons from (t,n)

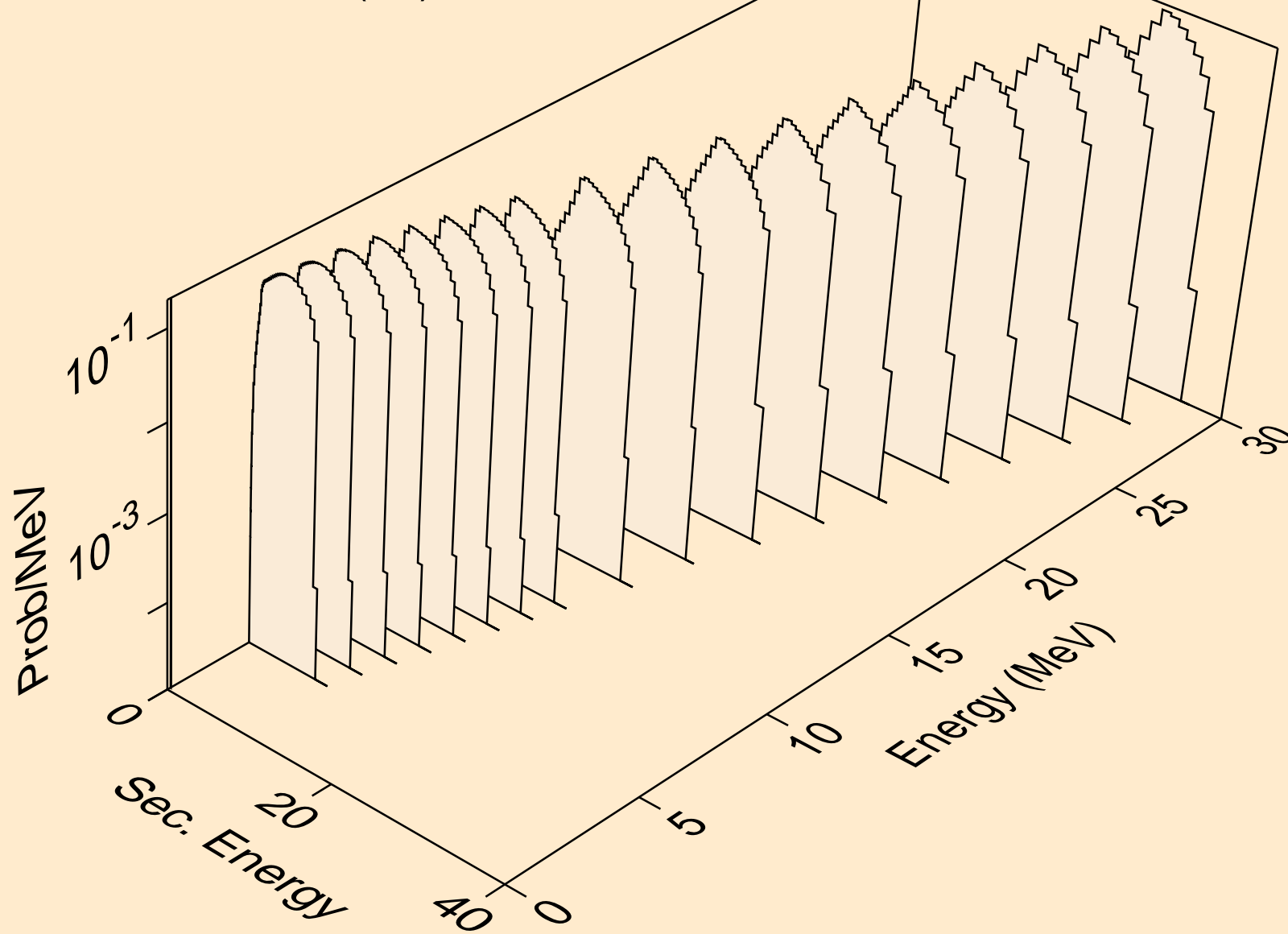

AU196M TRITON ACER TENDL-2021 LIBRARY; T=0.K  
neutrons from (t,x)

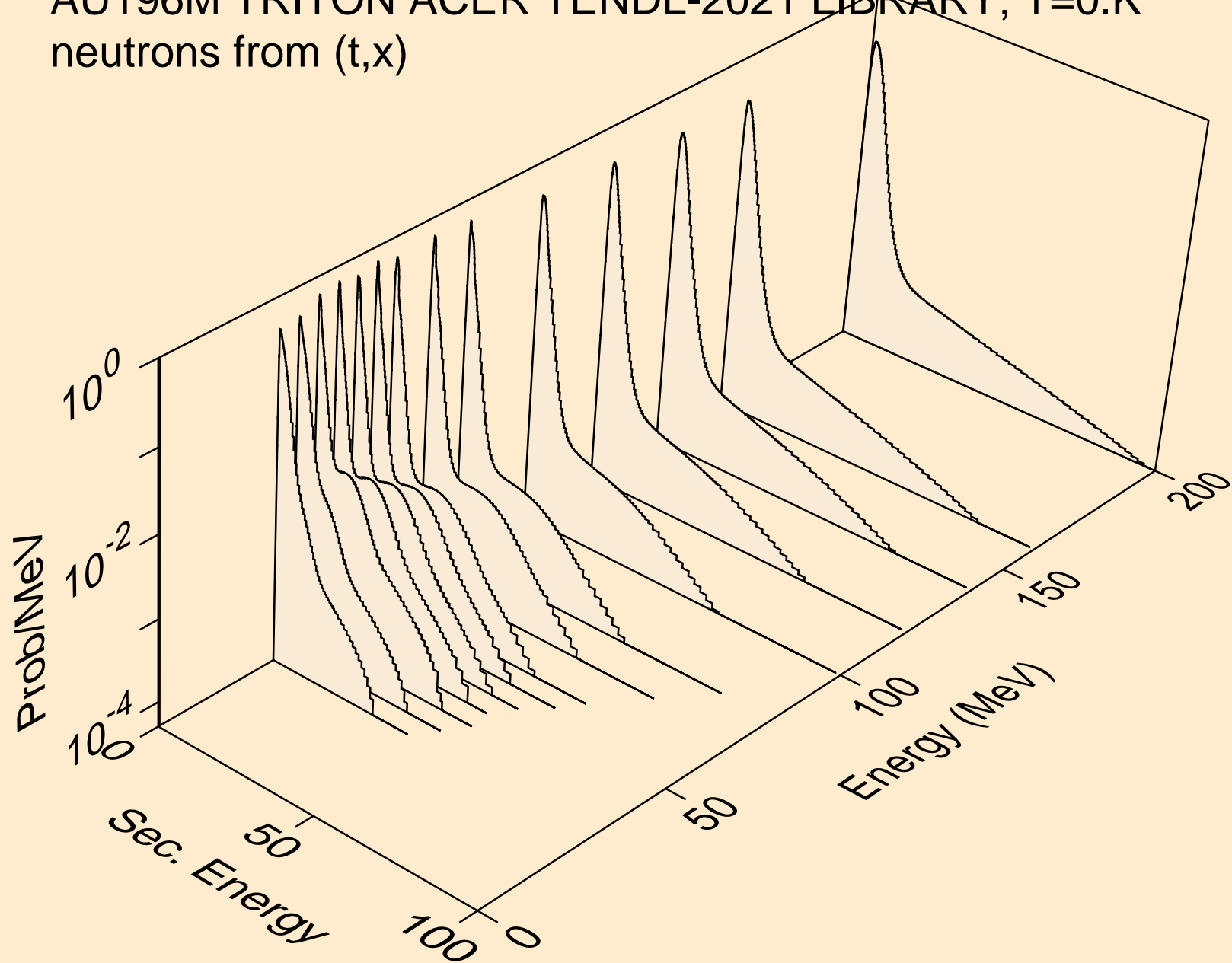



AU196M TRITON ACER TENDL-2021 LIBRARY; T=0.K  
neutrons from (t,2nd)

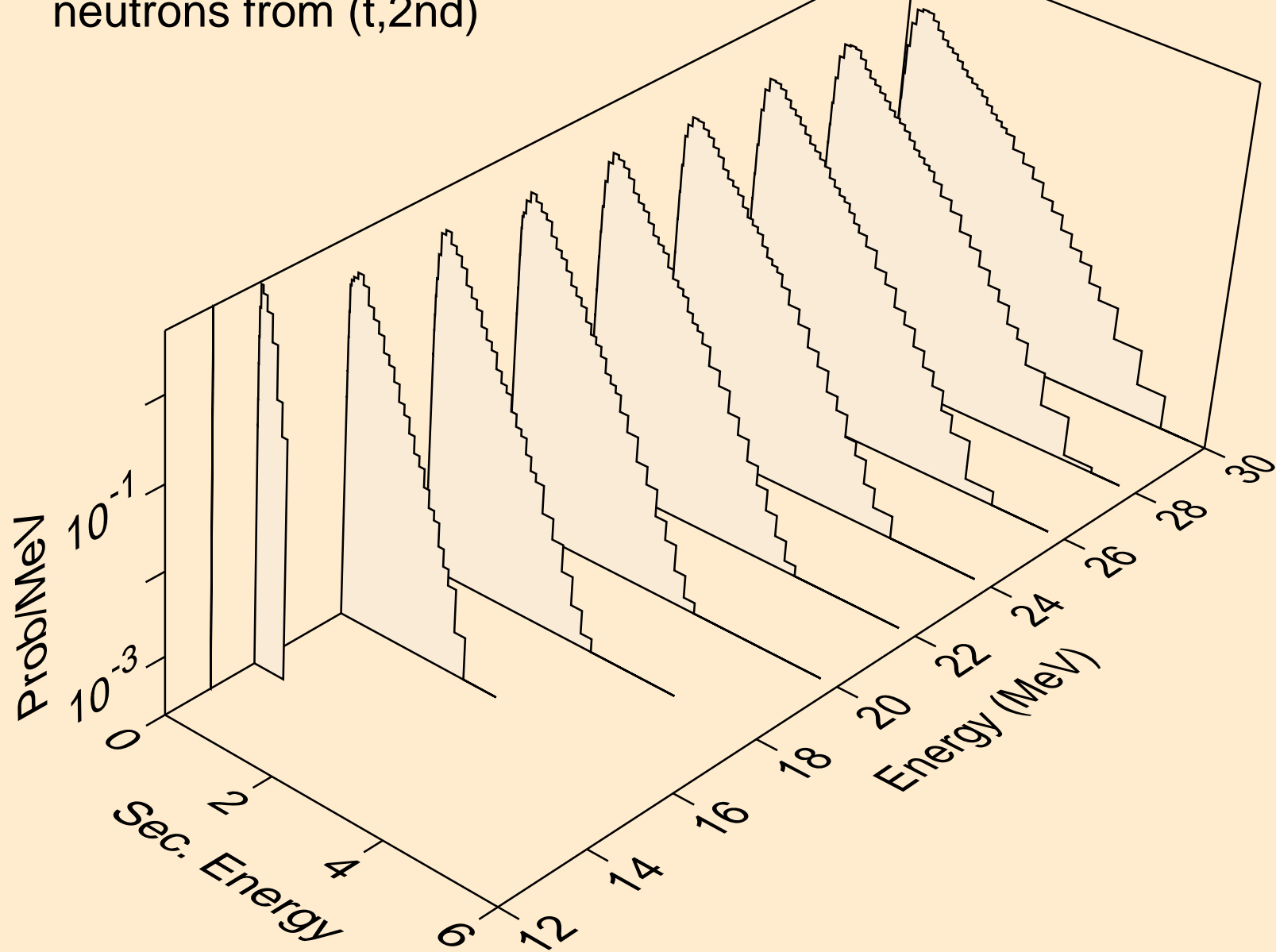

AU196M TRITON ACER TENDL-2021 LIBRARY; T=0.K  
neutrons from (t,2n)

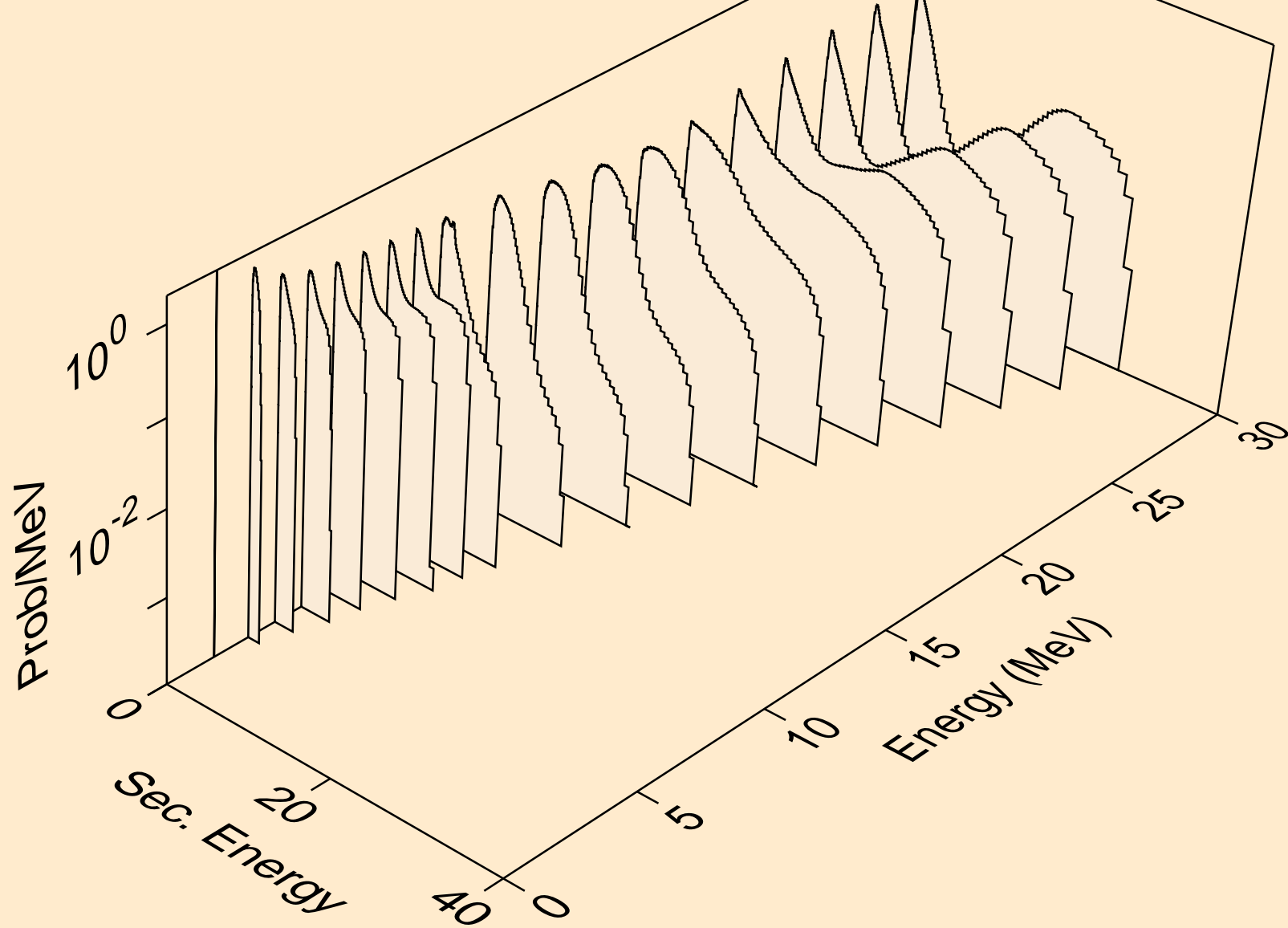

AU196M TRITON ACER TENDL-2021 LIBRARY; T=0.K  
neutrons from (t,3n)

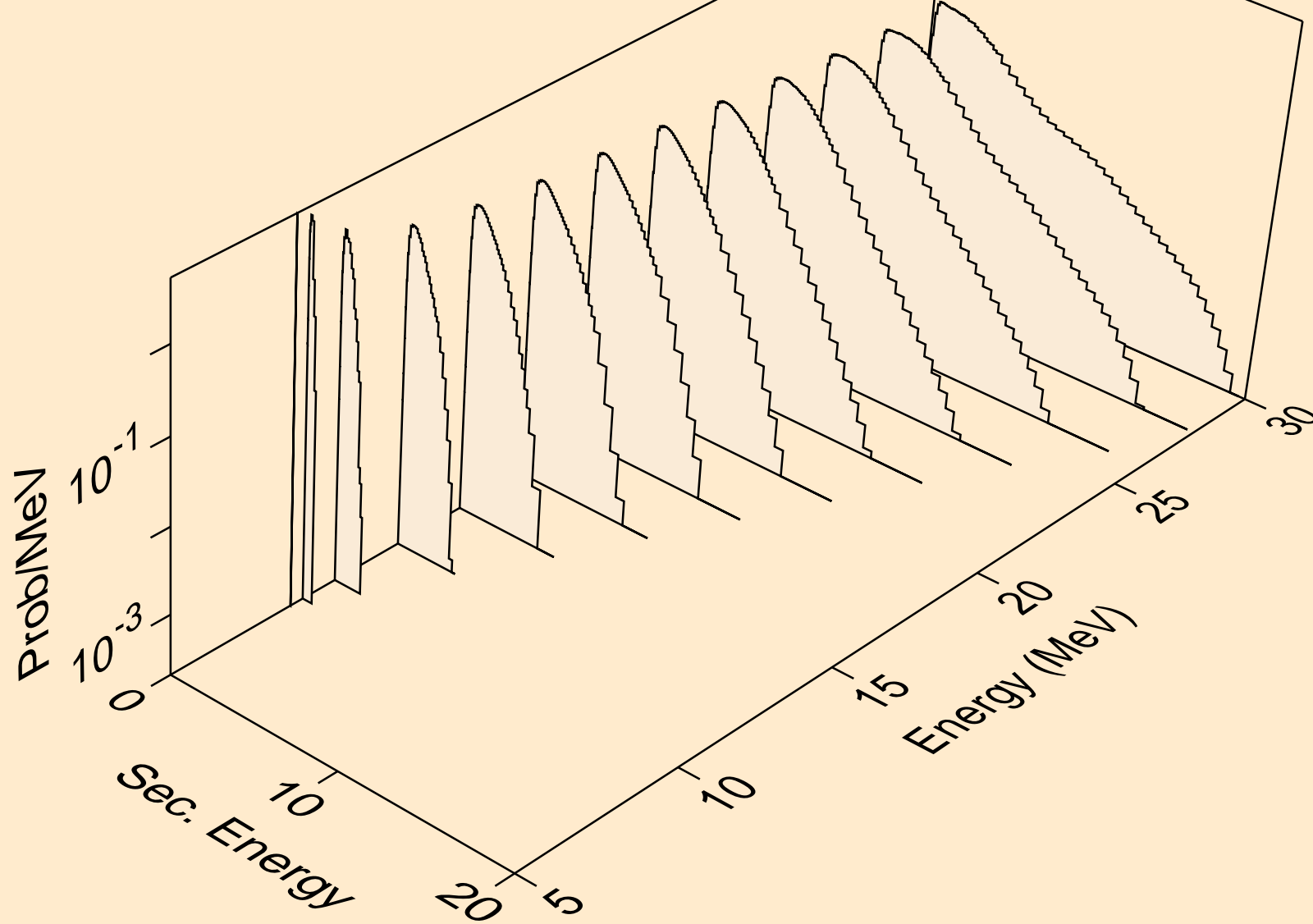

AU196M TRITON ACER TENDL-2021 LIBRARY; T=0.K  
neutrons from (t,n\*)a

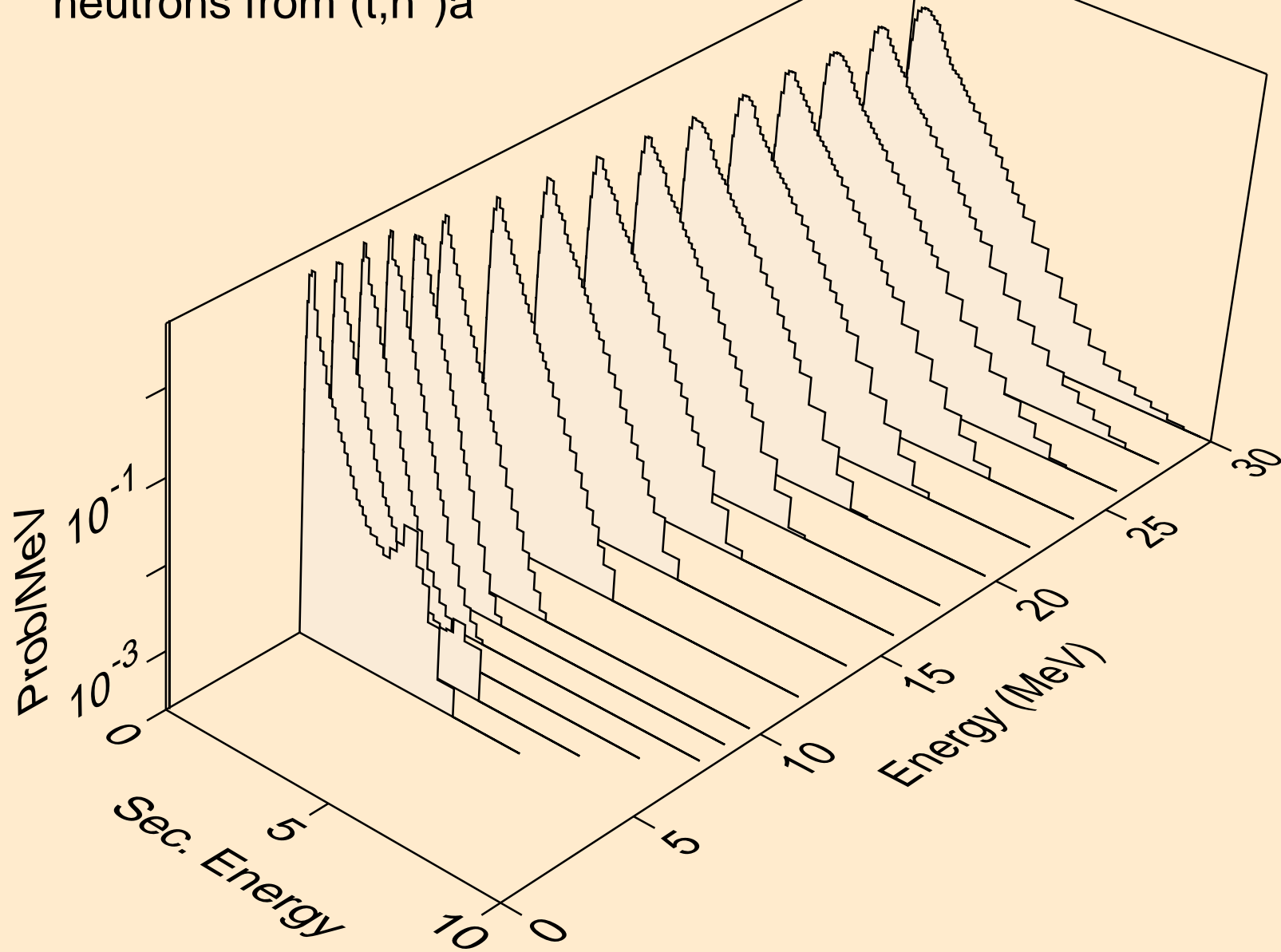

AU196M TRITON ACER TENDL-2021 LIBRARY; T=0.K  
neutrons from (t,2n)a

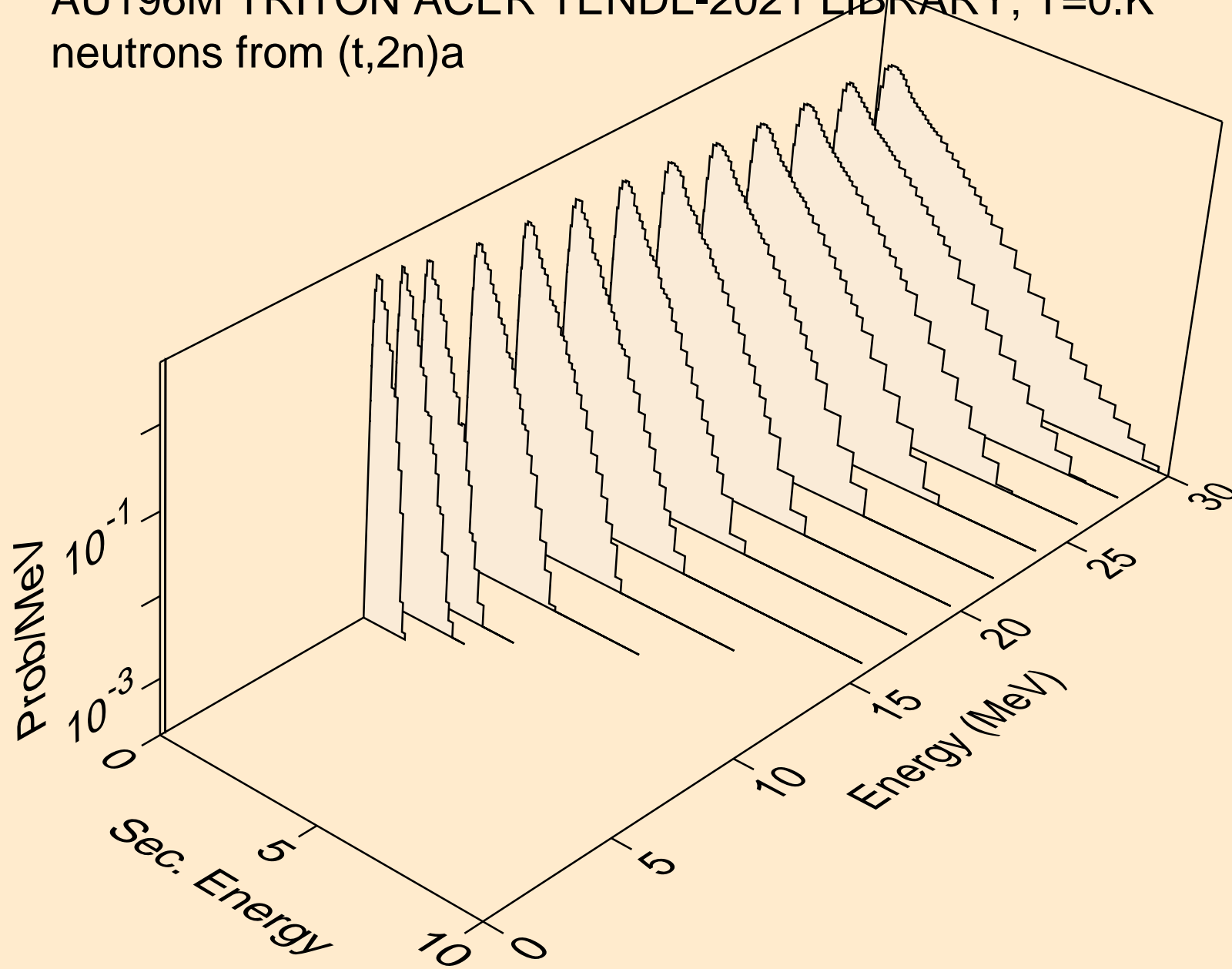

AU196M TRITON ACER TENDL-2021 LIBRARY; T=0.K  
neutrons from (t,3n)a

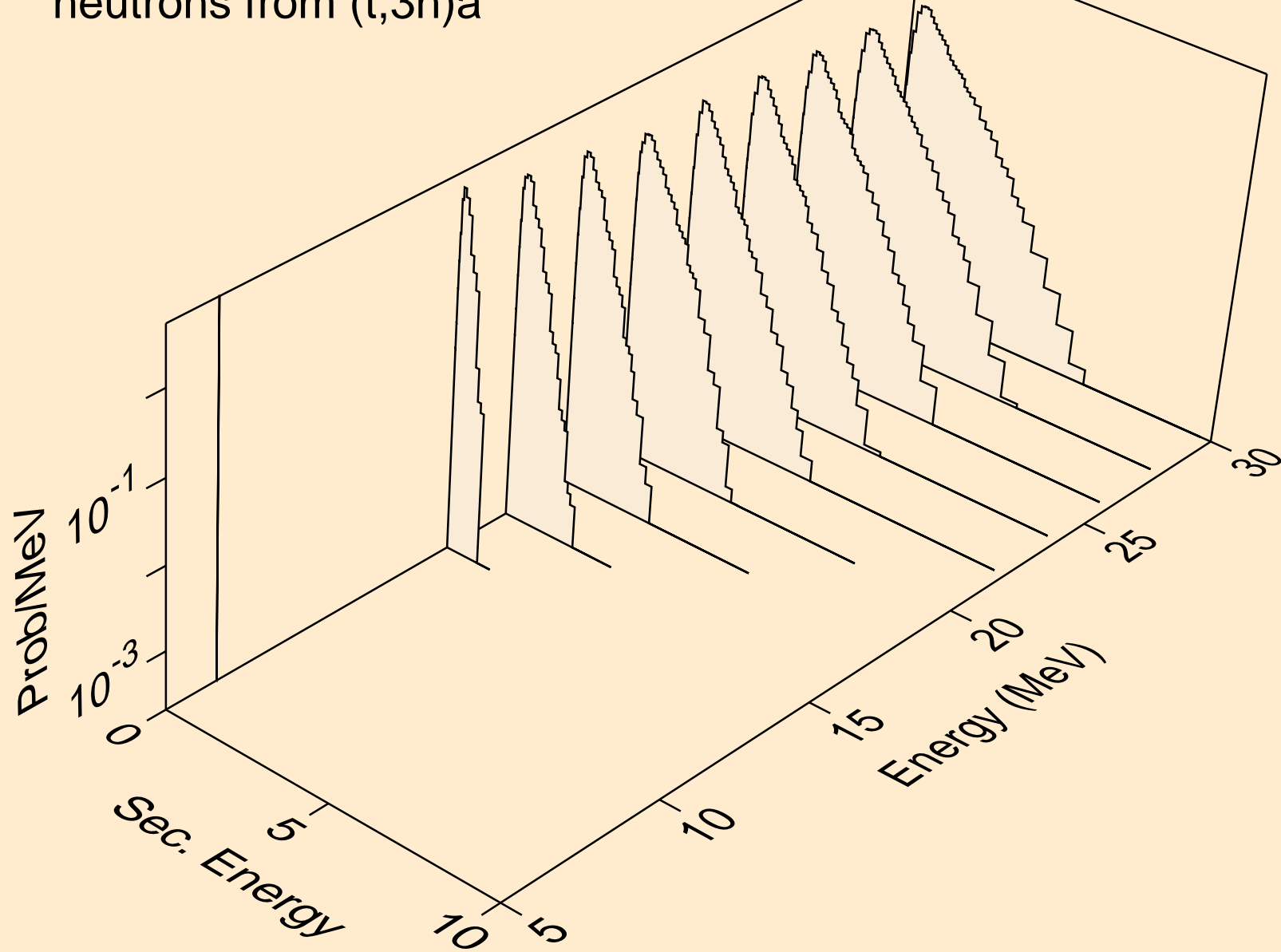

AU196M TRITON ACER TENDL-2021 LIBRARY; T=0.K  
neutrons from (t,n\*)p

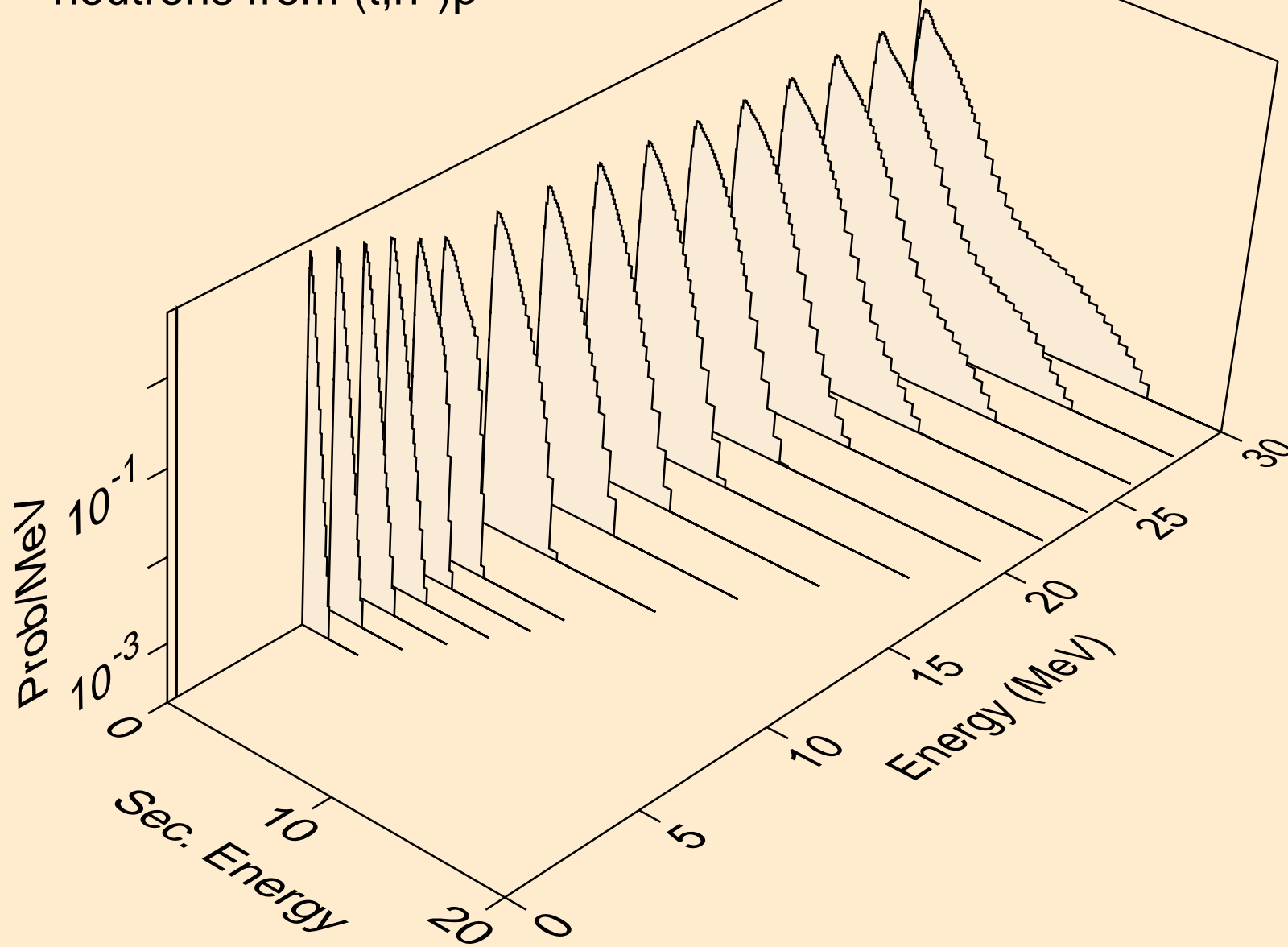

AU196M TRITON ACER TENDL-2021 LIBRARY; T=0.K  
neutrons from (t,n\*)2a

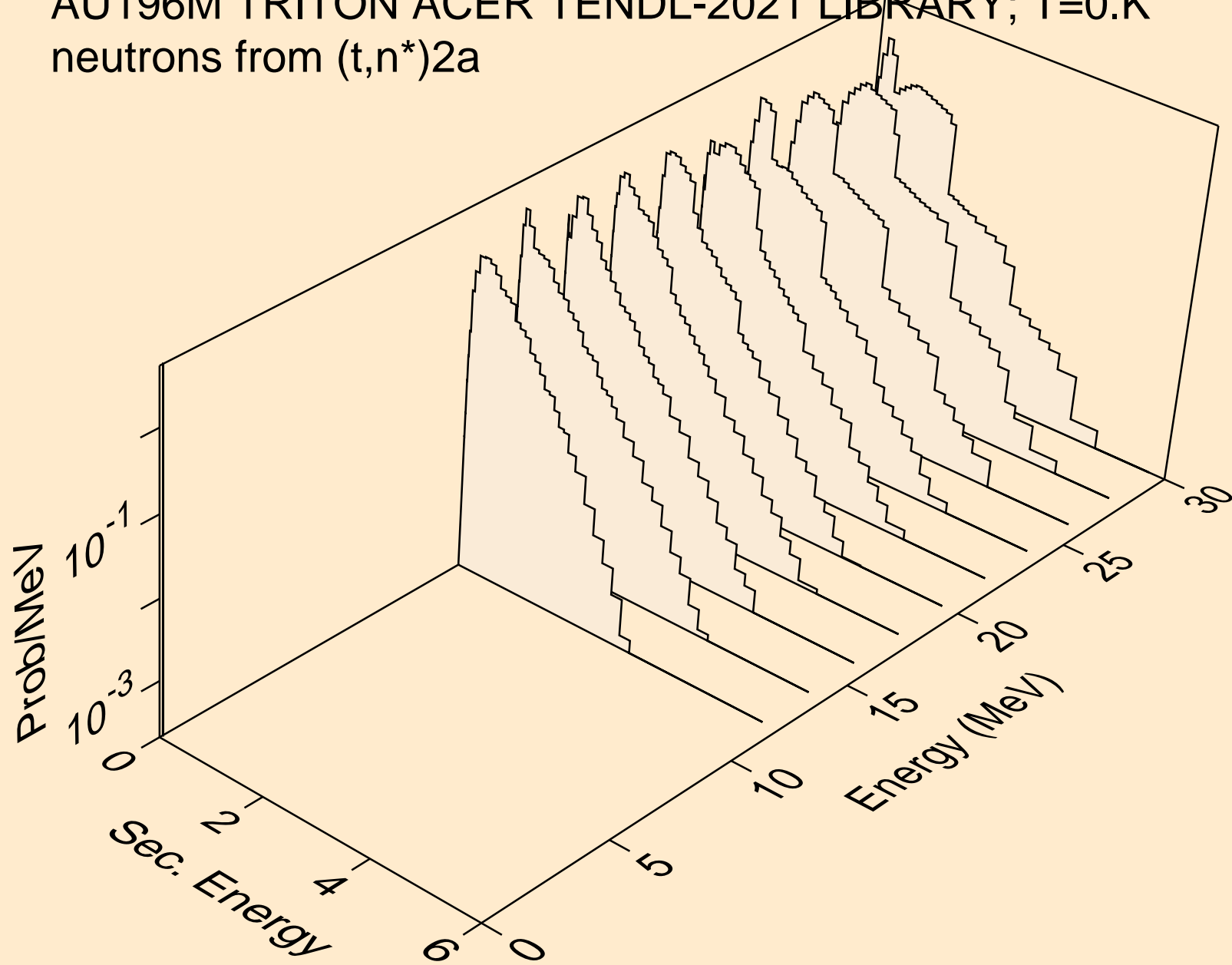



AU196M TRITON ACER TENDL-2021 LIBRARY; T=0.K  
neutrons from (t,n\*)d

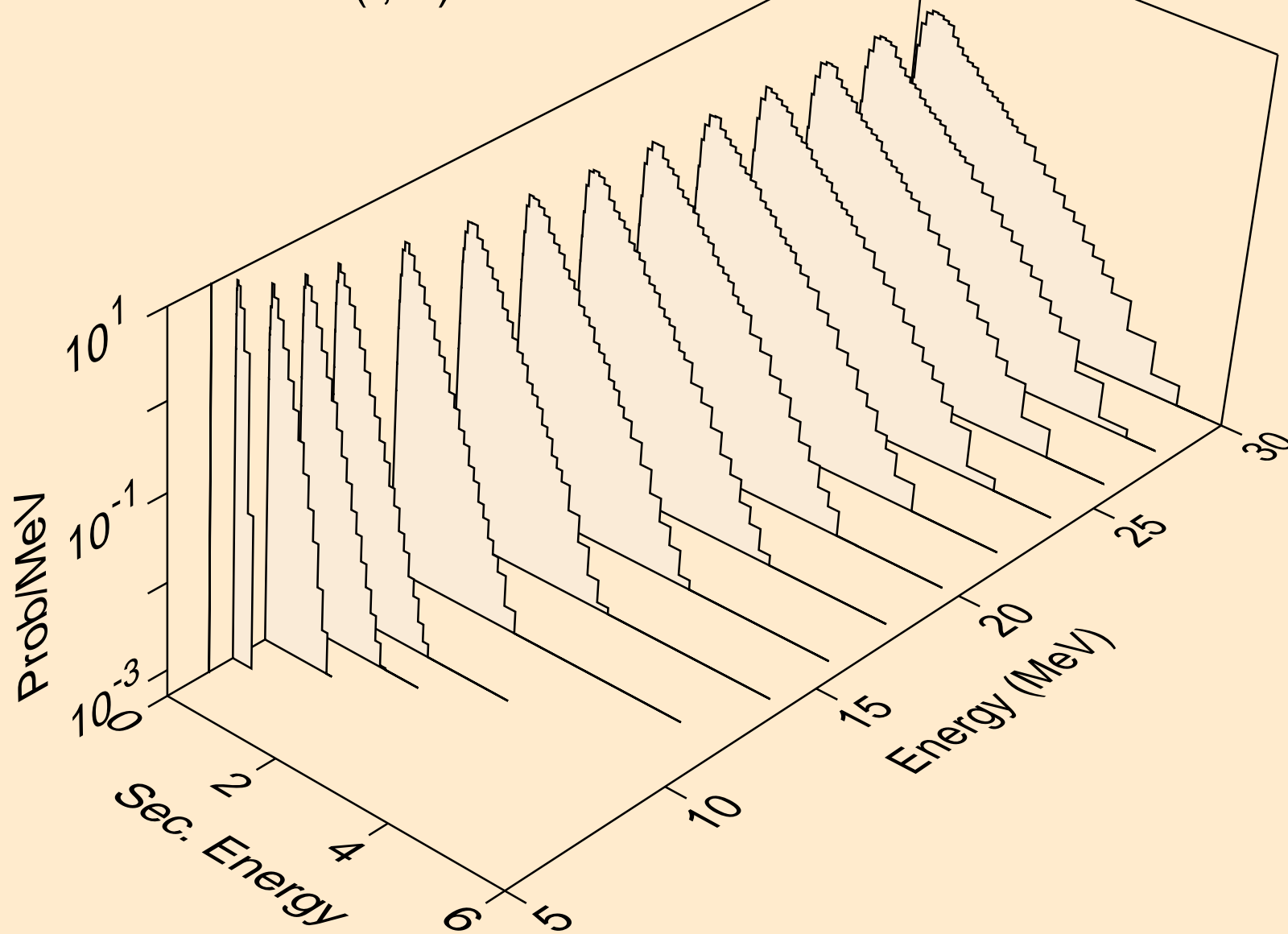

AU196M TRITON ACER TENDL-2021 LIBRARY; T=0.K  
neutrons from (t,n\*)t

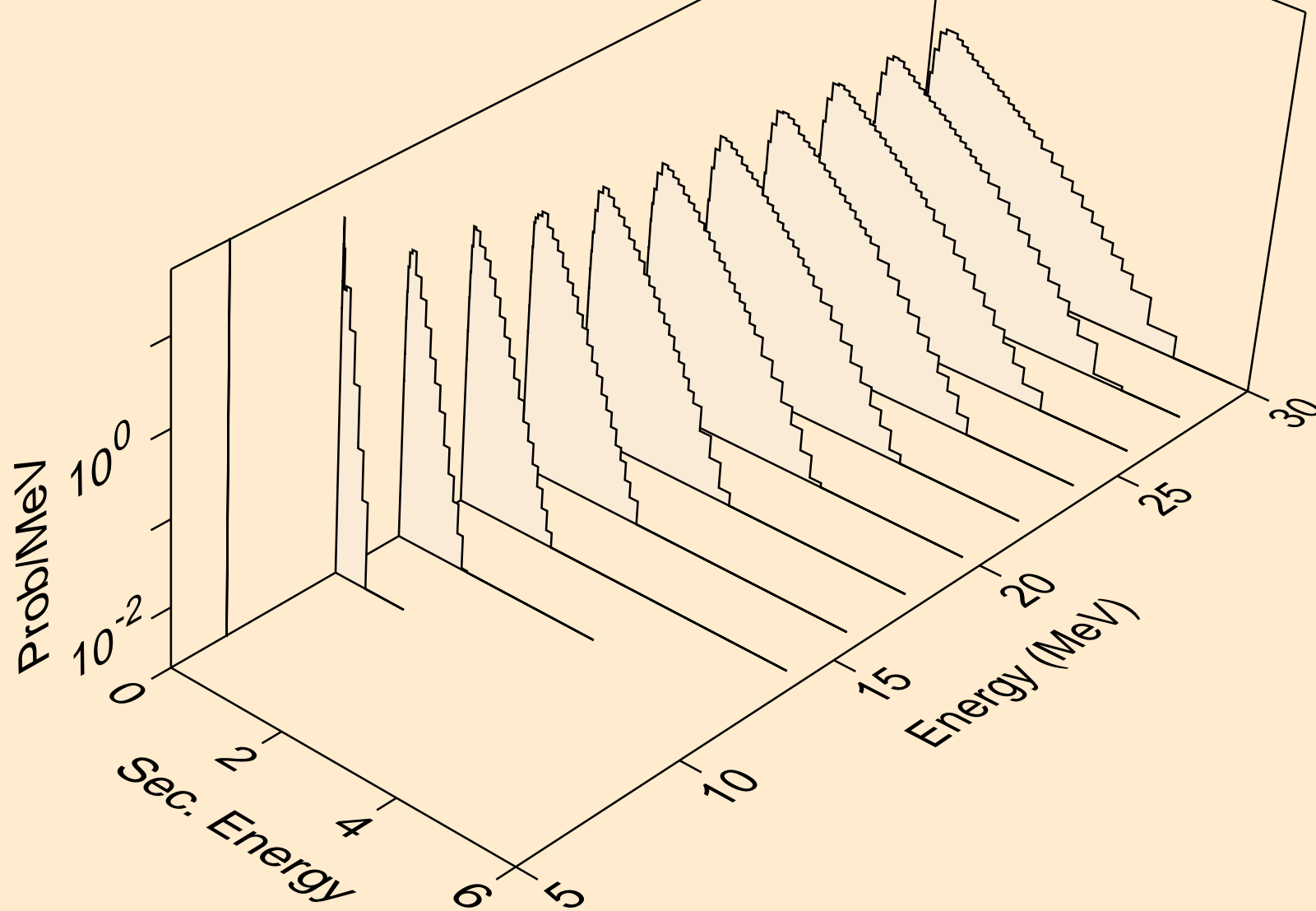

AU196M TRITON ACER TENDL-2021 LIBRARY; T=0.K  
neutrons from (t,n\*)he3

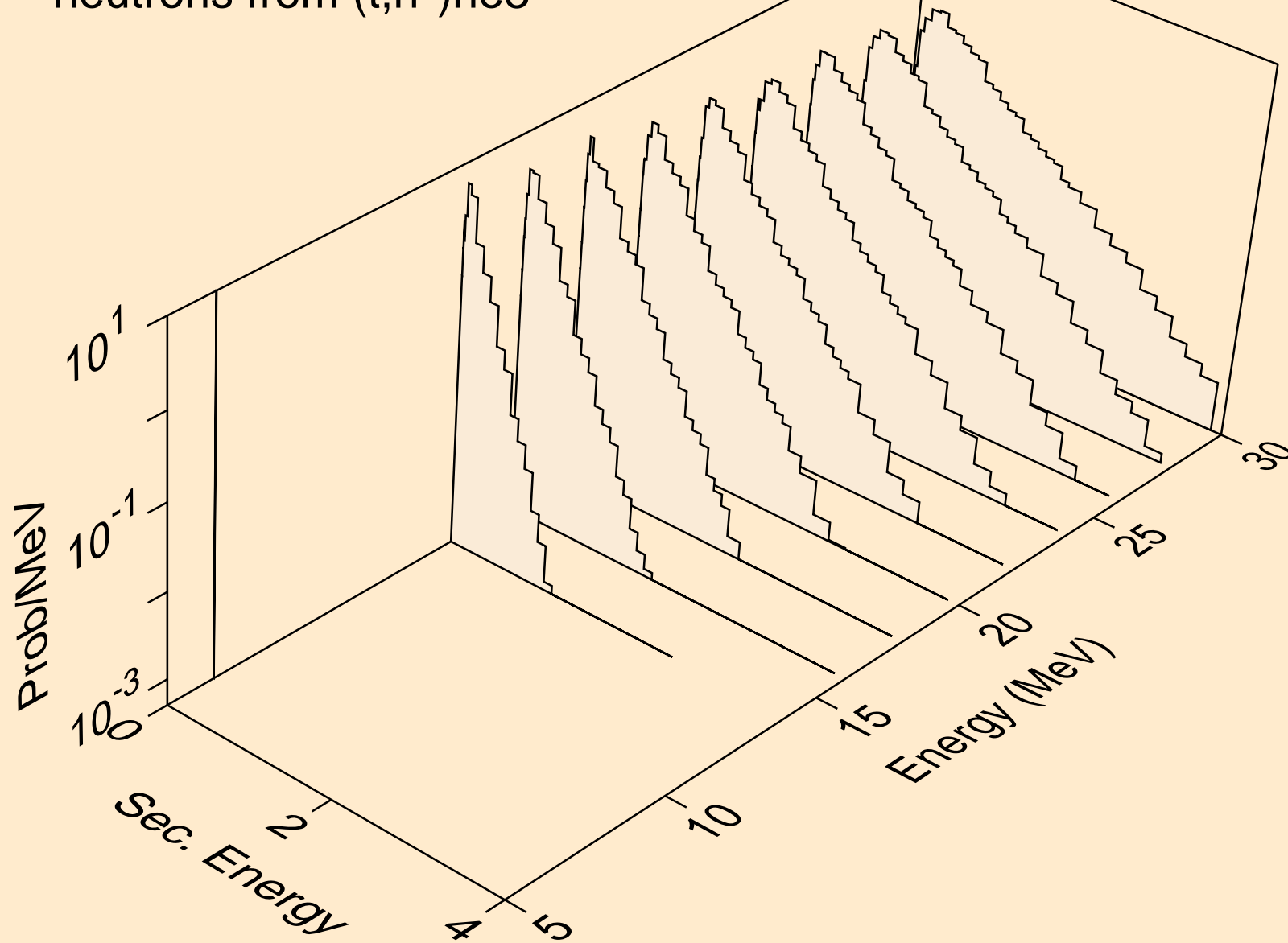

AU196M TRITON ACER TENDL-2021 LIBRARY; T=0.K  
neutrons from (t,4n)

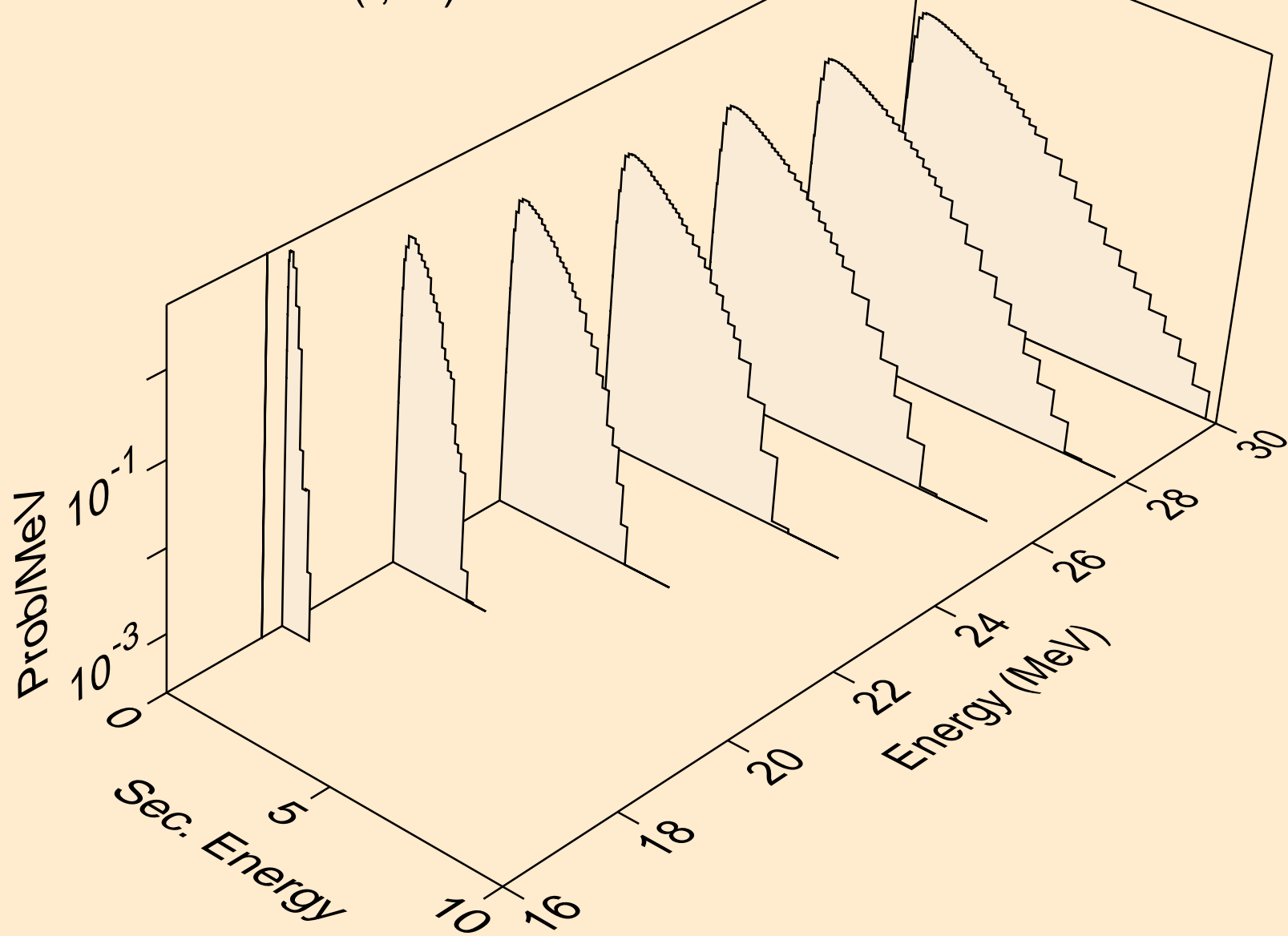

AU196M TRITON ACER TENDL-2021 LIBRARY; T=0.K  
neutrons from (t,2np)

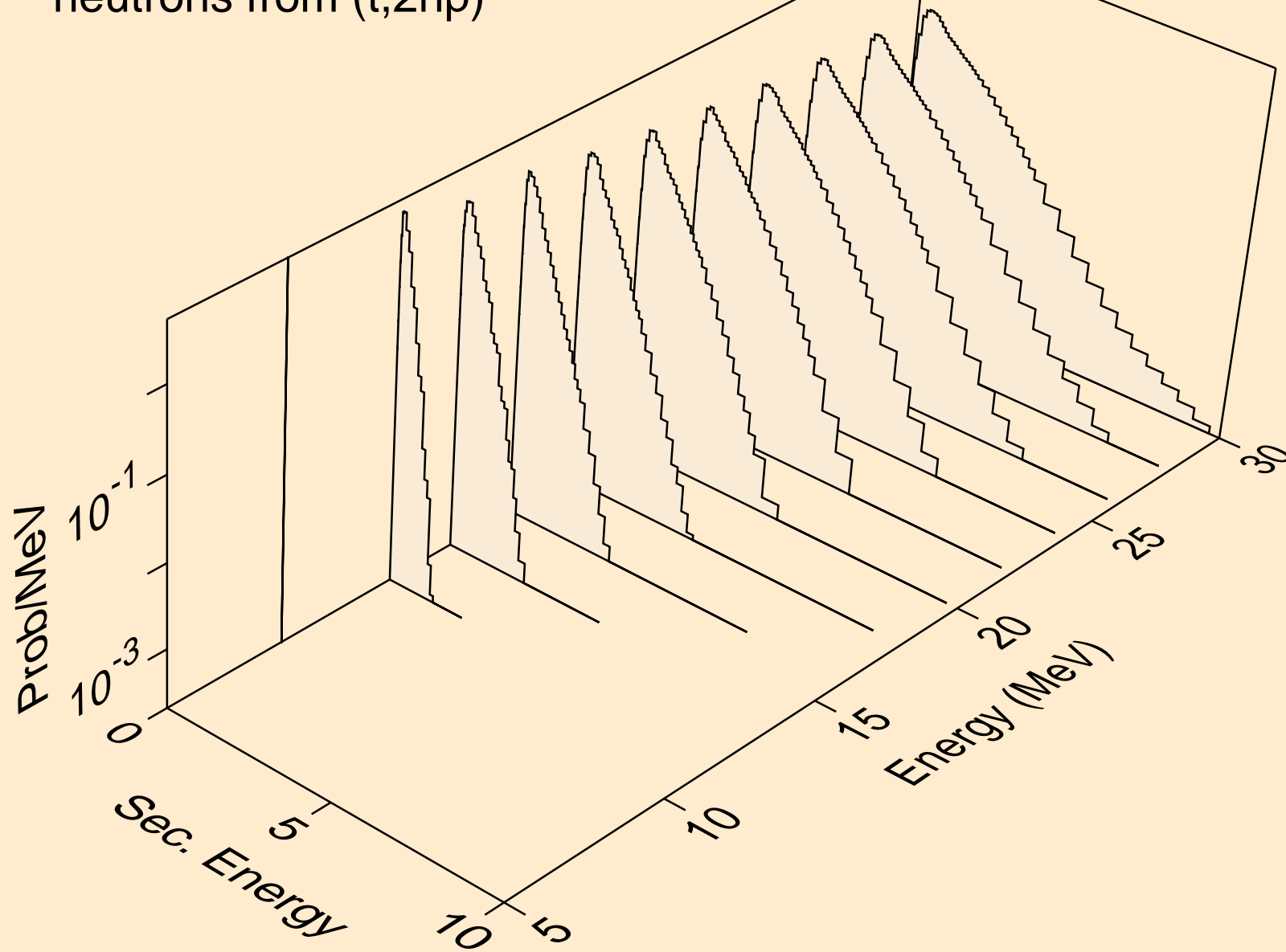

AU196M TRITON ACER TENDL-2021 LIBRARY; T=0.K  
neutrons from (t,3np)

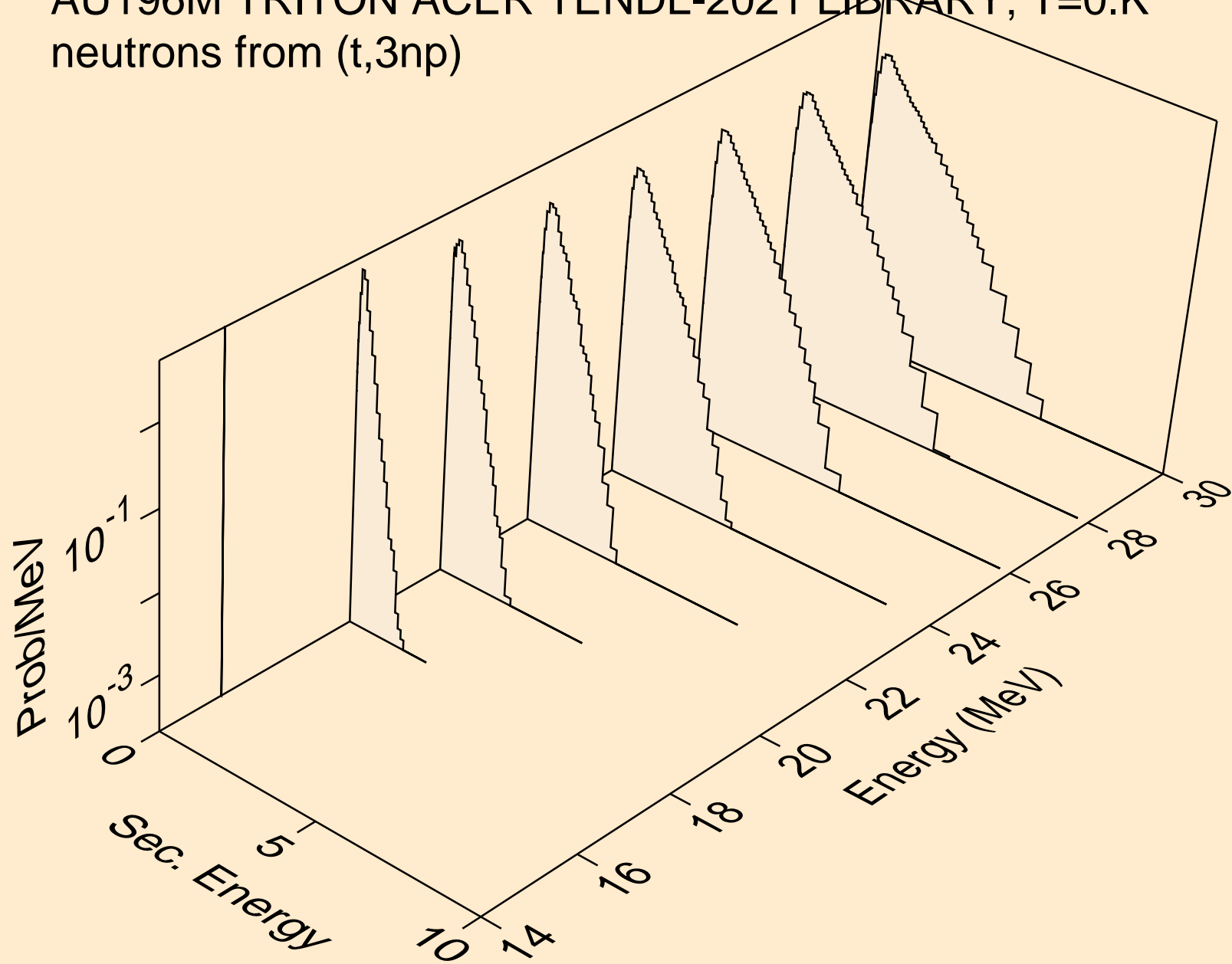

AU196M TRITON ACER TENDL-2021 LIBRARY; T=0.K  
neutrons from (t,2np)

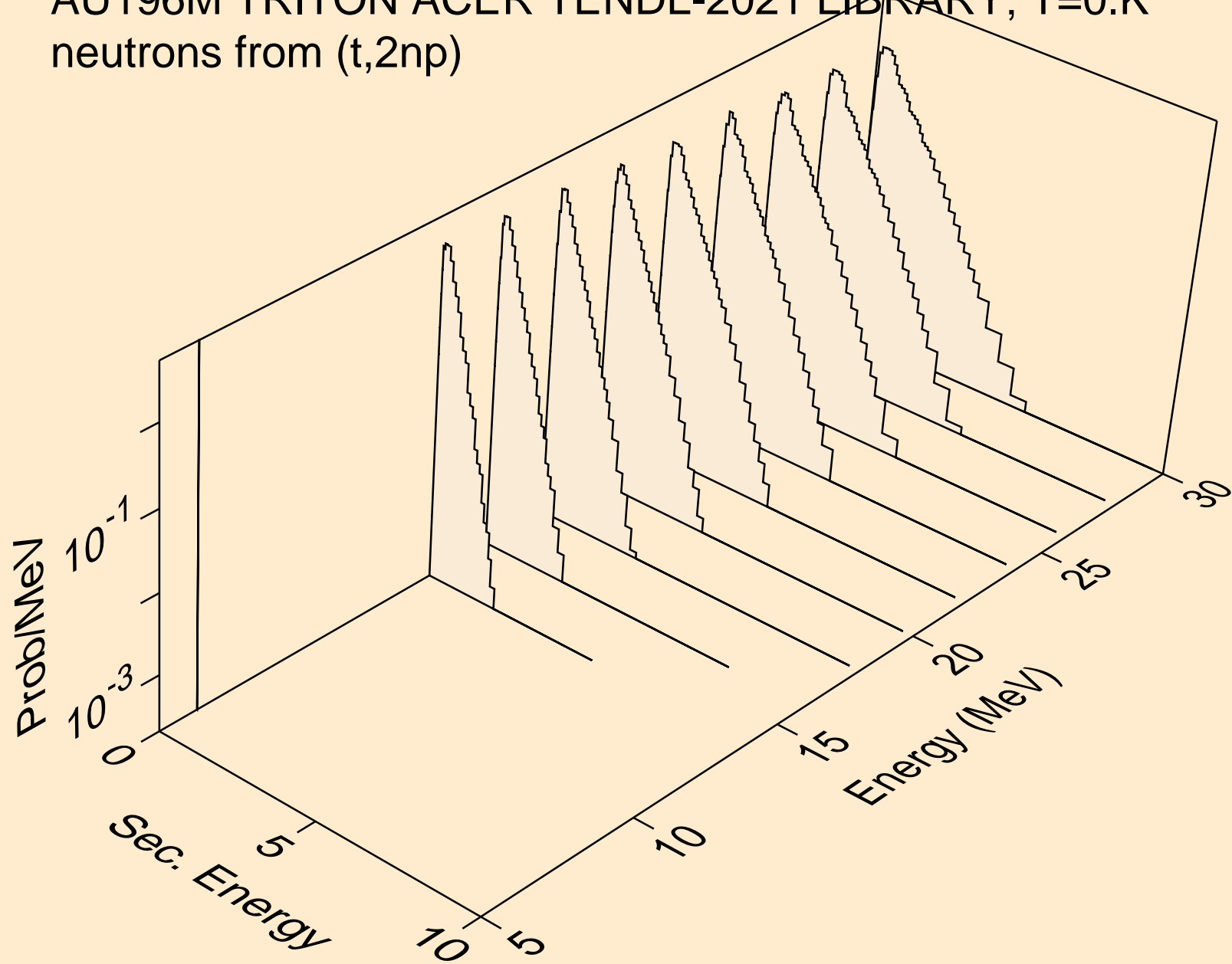

AU196M TRITON ACER TENDL-2021 LIBRARY; T=0.K  
neutrons from (t,npa)

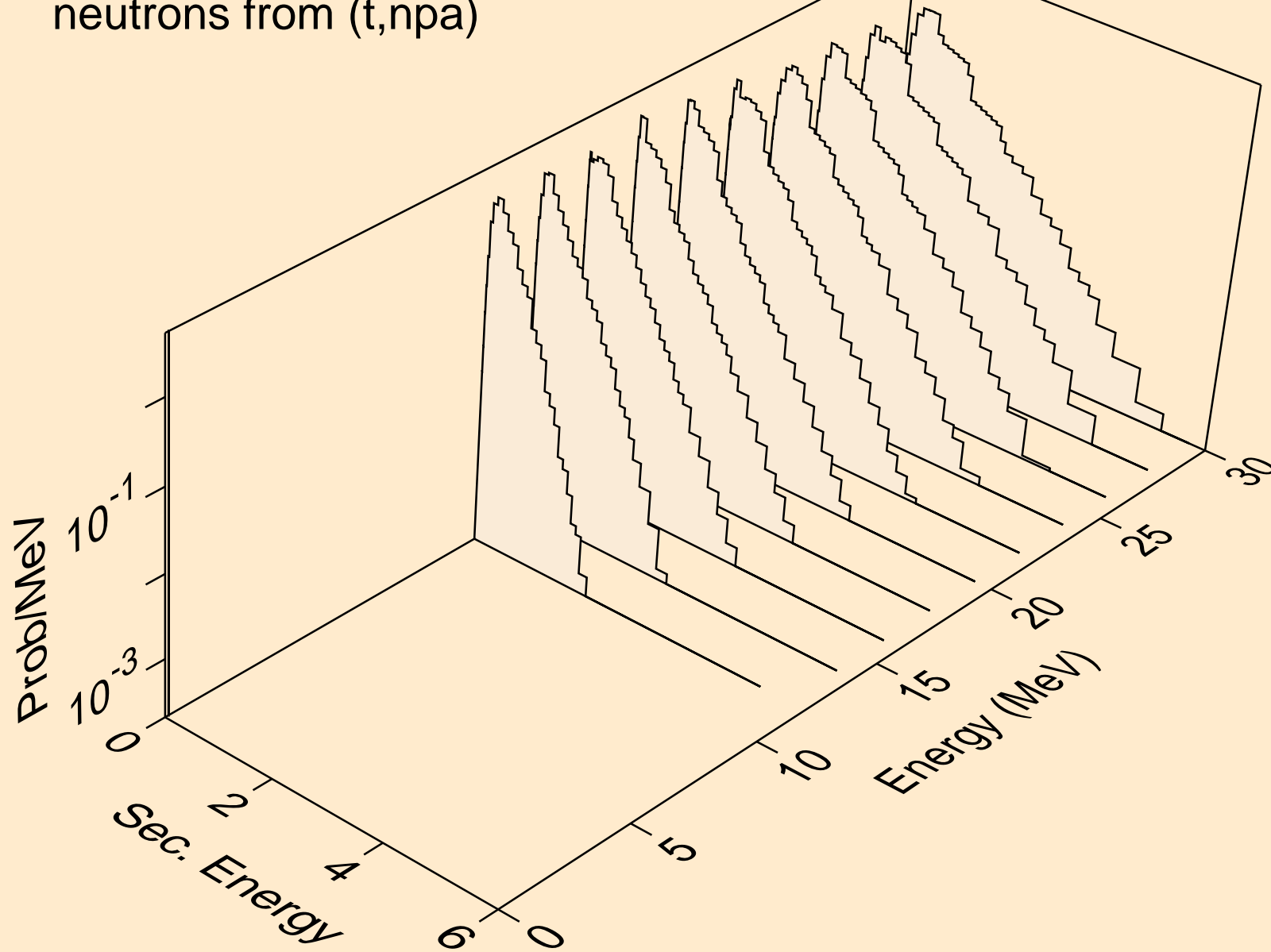



AU196M TRITON ACER TENDL-2021 LIBRARY; T=0.K  
protons from (t,x)

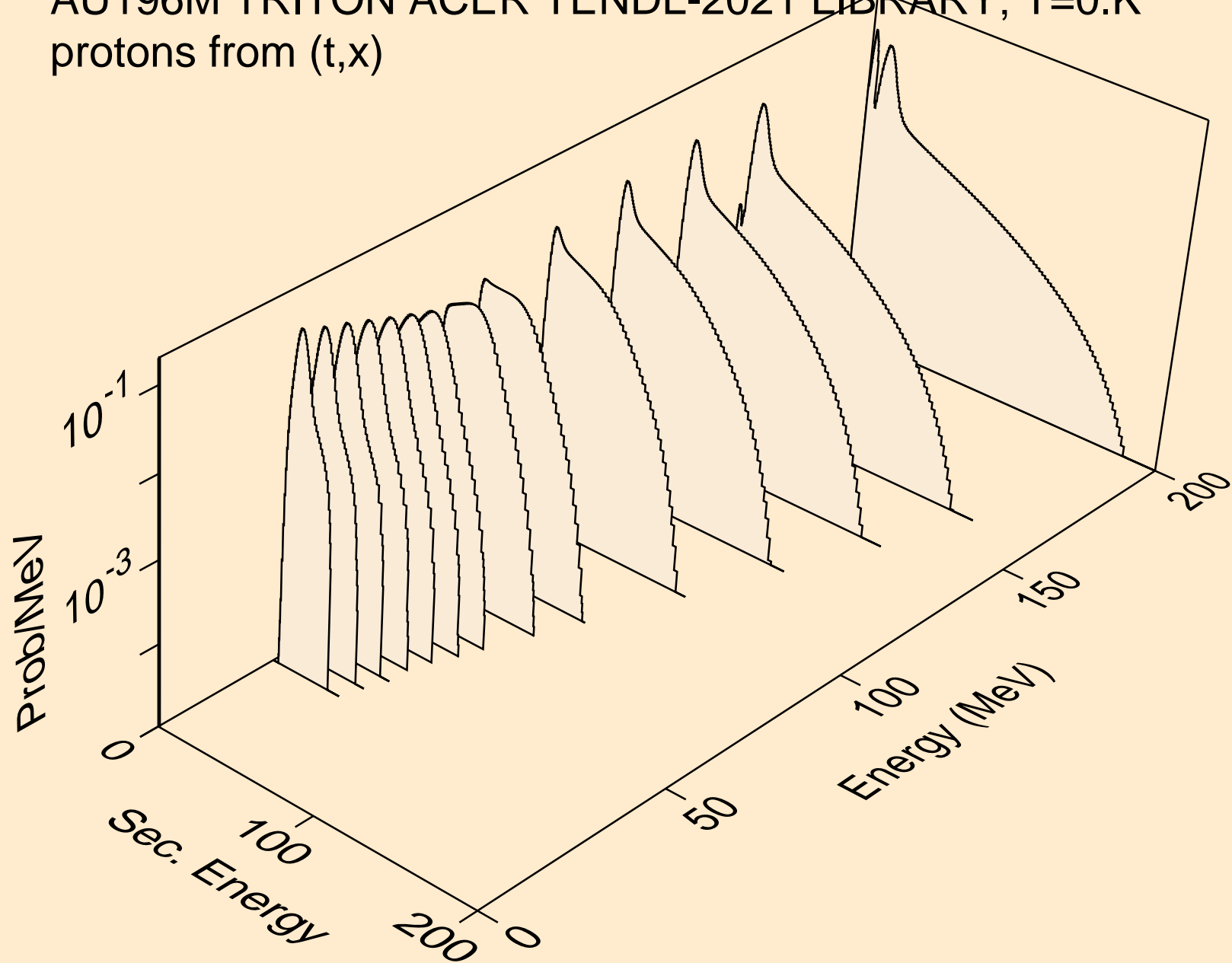

AU196M TRITON ACER TENDL-2021 LIBRARY; T=0.K  
protons from (t,n\*)p

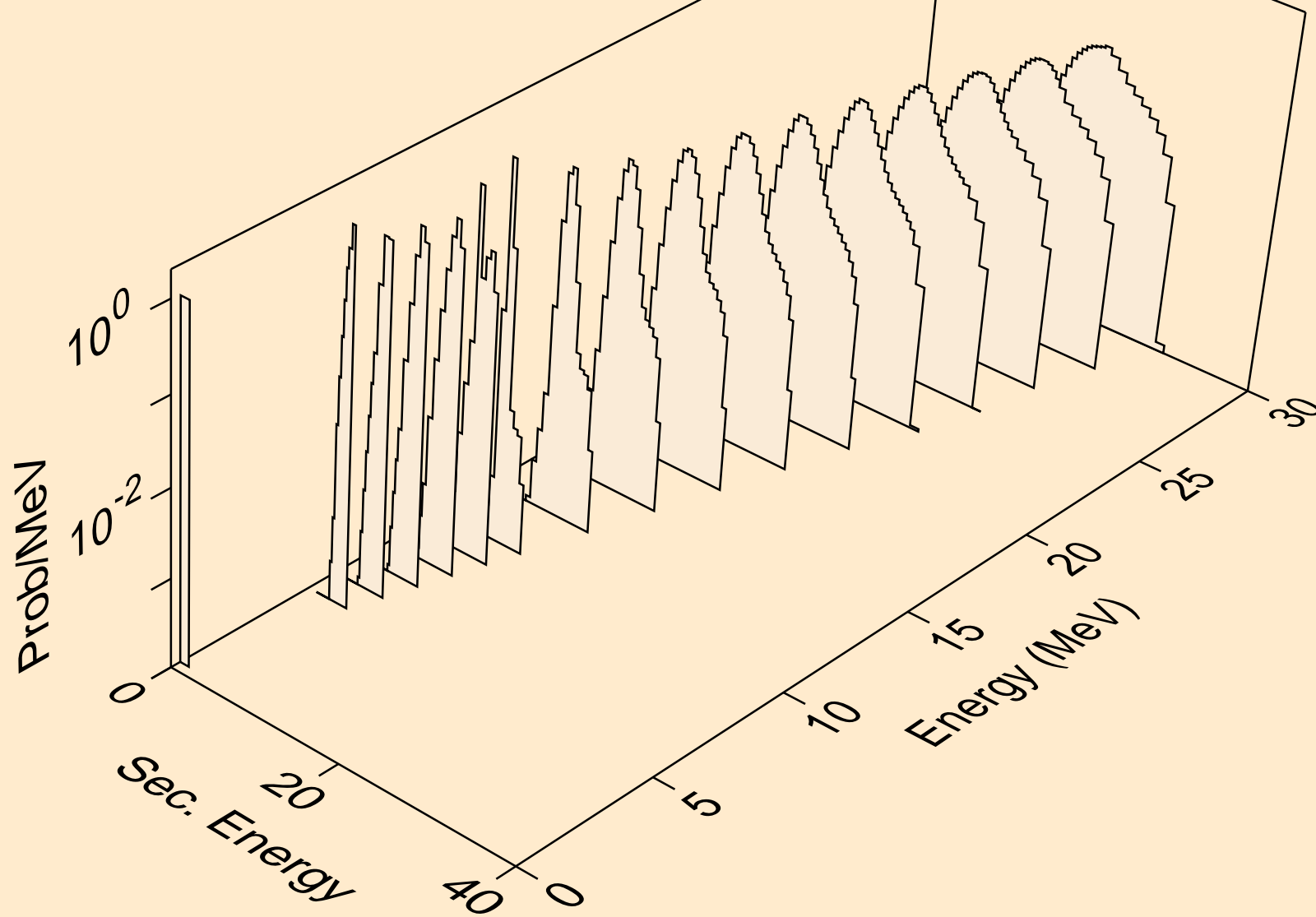

AU196M TRITON ACER TENDL-2021 LIBRARY; T=0.K  
protons from (t,2np)

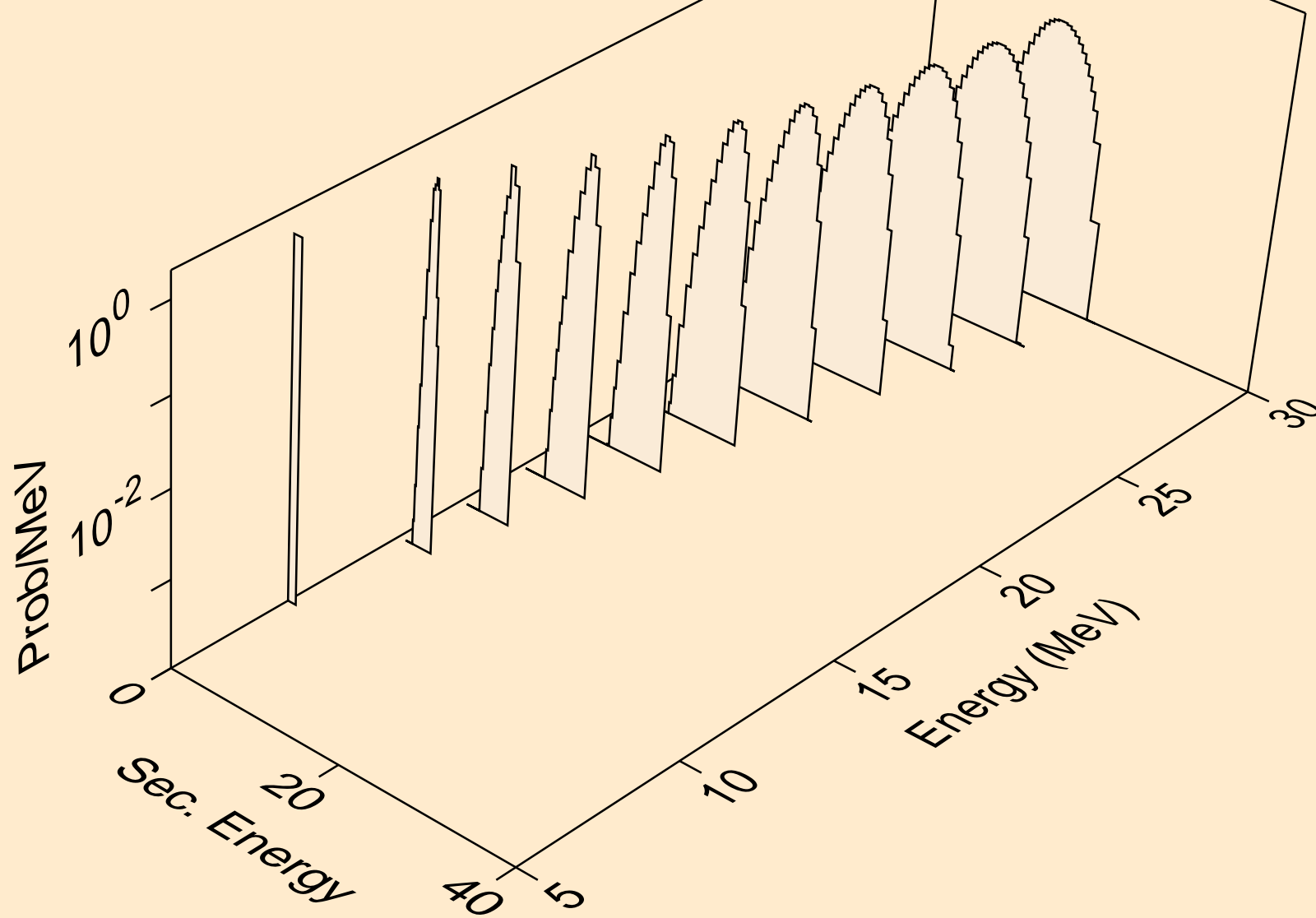

AU196M TRITON ACER TENDL-2021 LIBRARY; T=0.K  
protons from (t,3np)

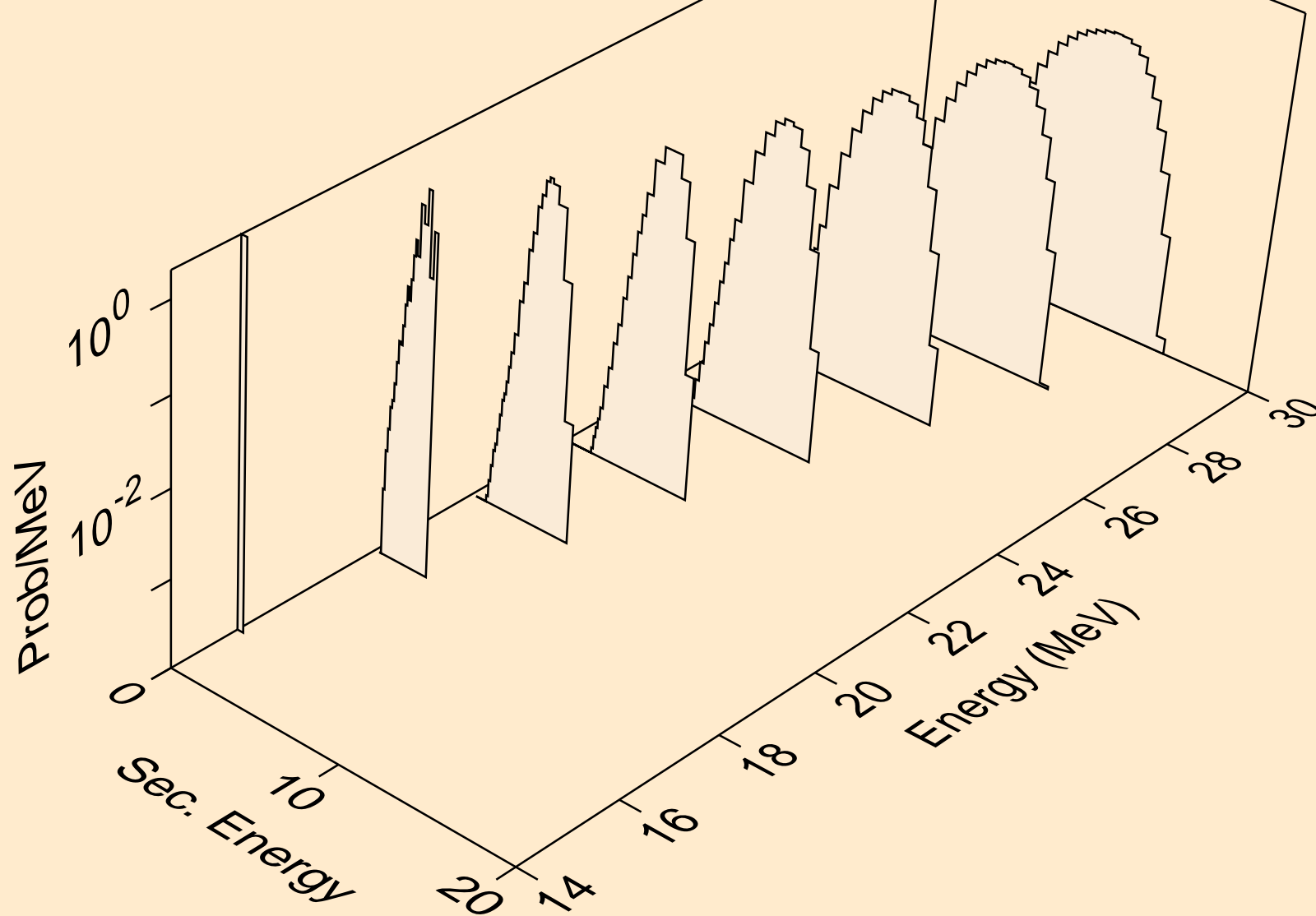

AU196M TRITON ACER TENDL-2021 LIBRARY; T=0.K  
protons from (t,2np)

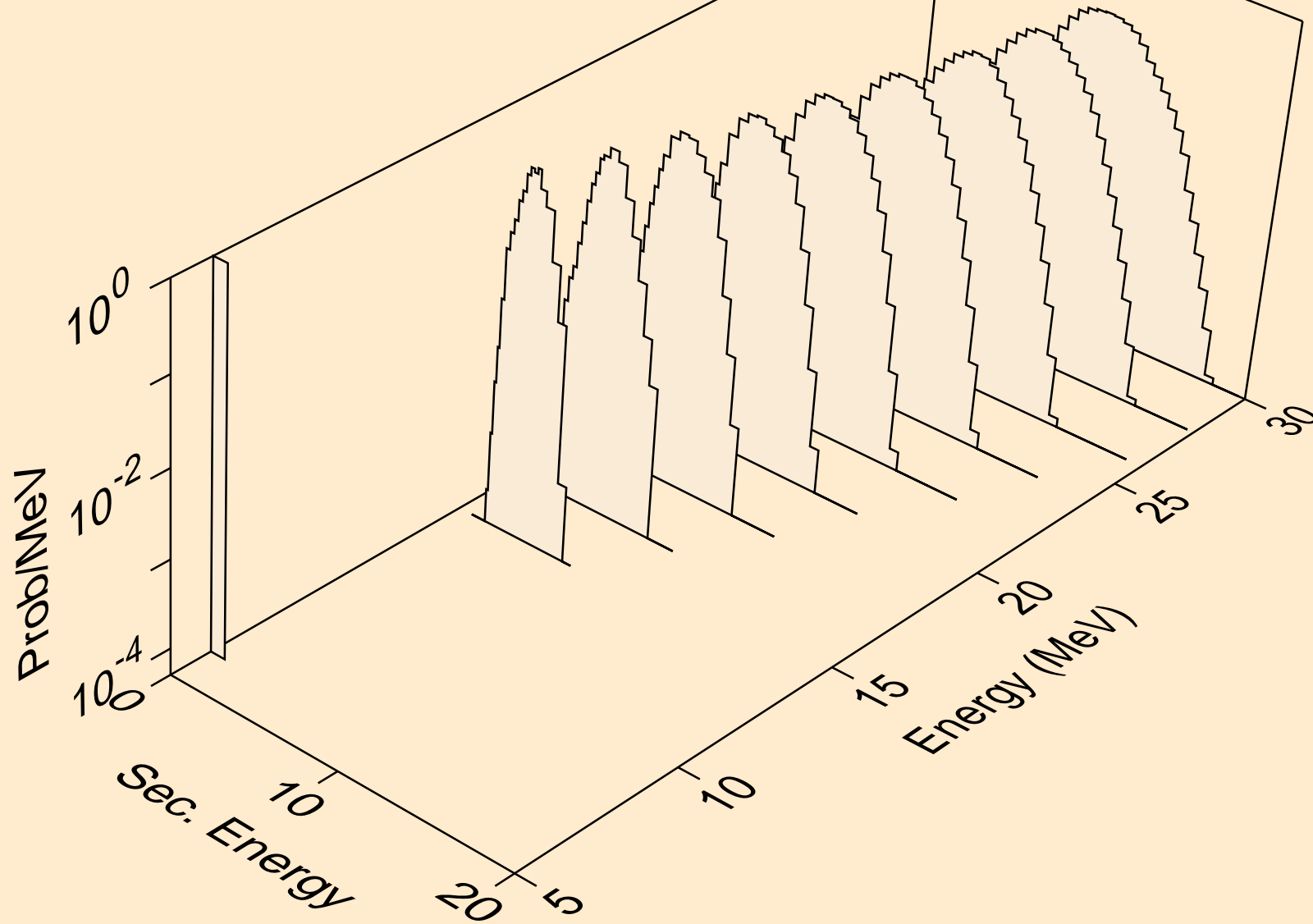

AU196M TRITON ACER TENDL-2021 LIBRARY; T=0.K  
protons from (t,npa)

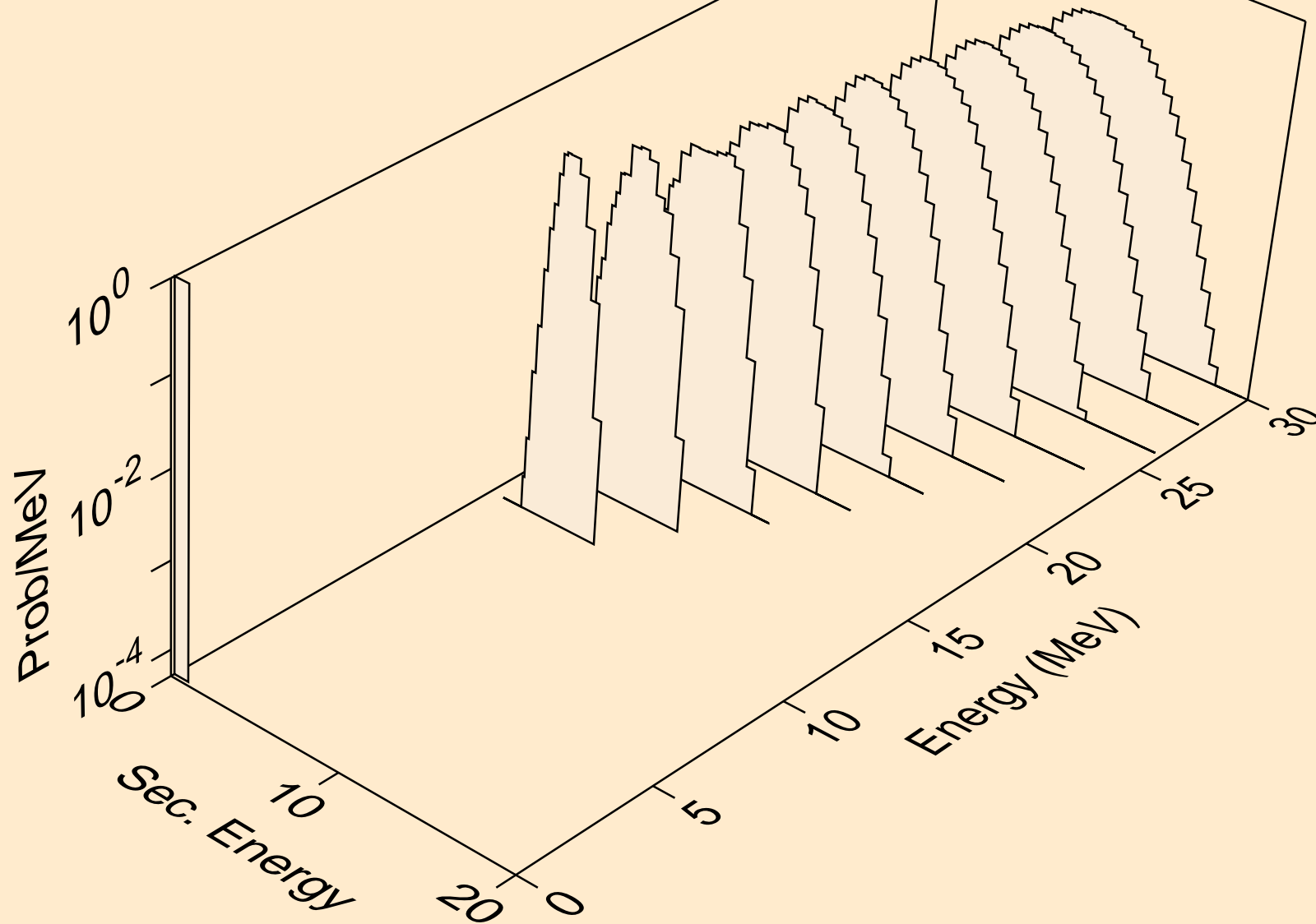

AU196M TRITON ACER TENDL-2021 LIBRARY; T=0.K  
protons from (t,p)

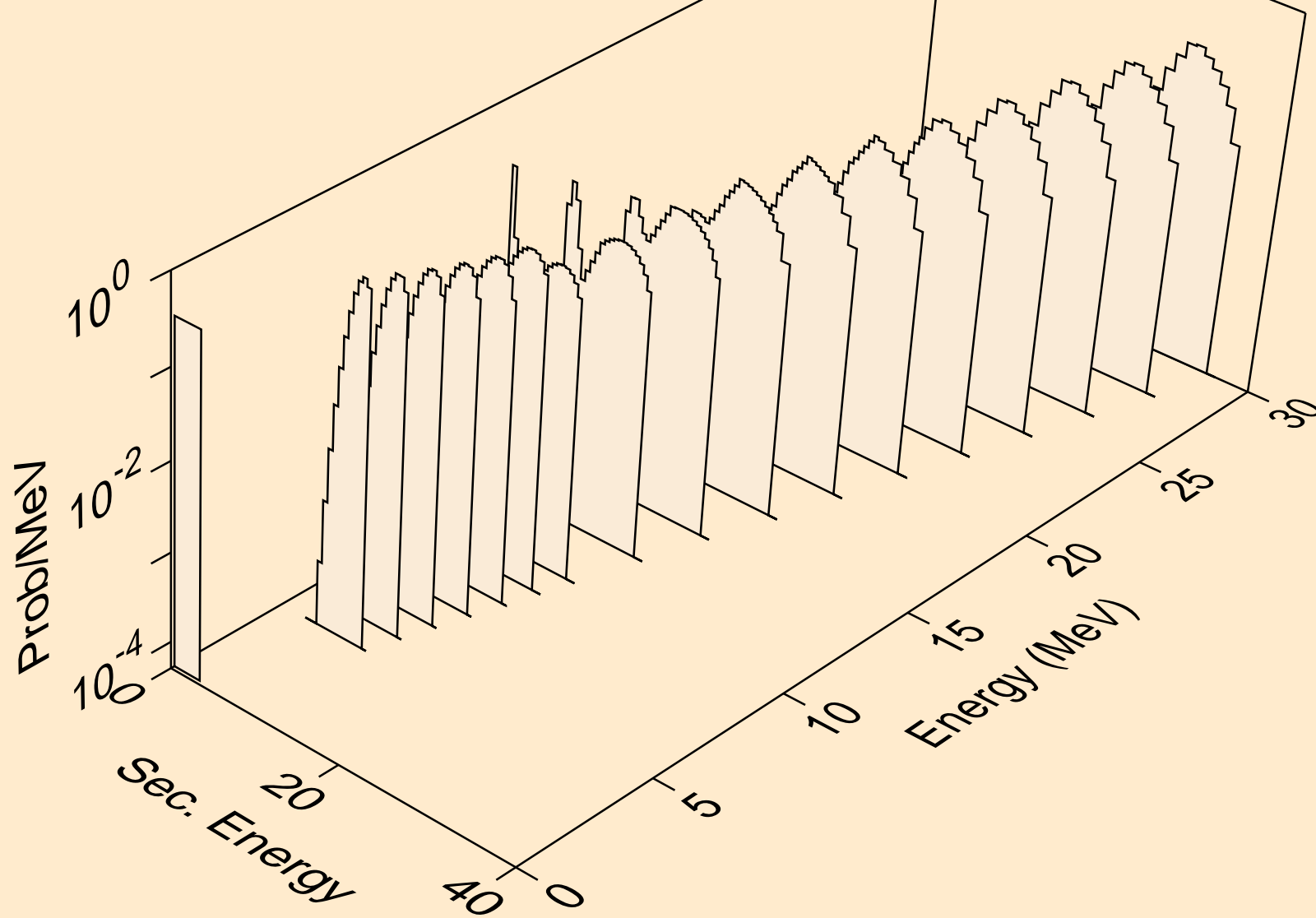

AU196M TRITON ACER TENDL-2021 LIBRARY; T=0.K  
protons from (t,2p)

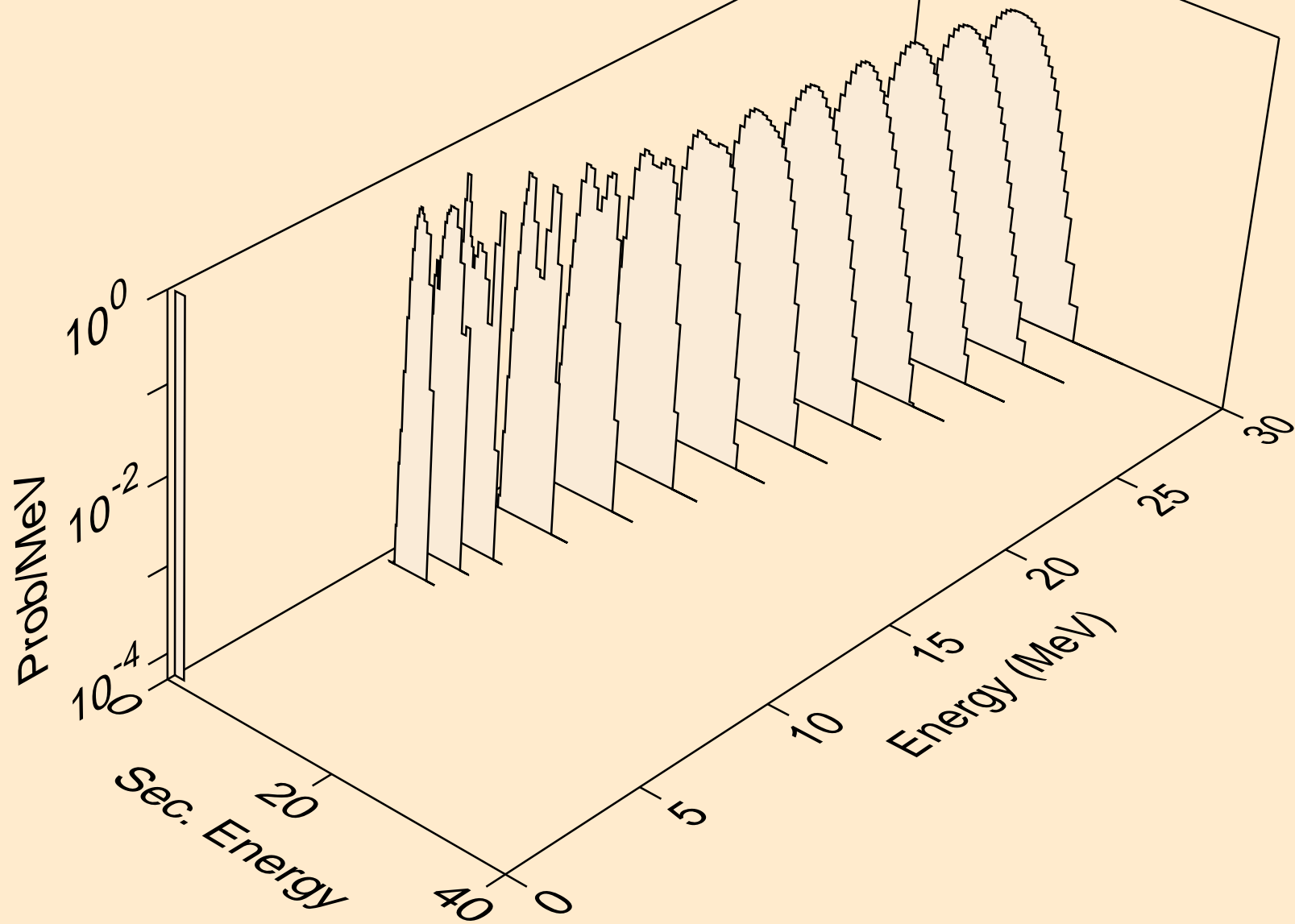



AU196M TRITON ACER TENDL-2021 LIBRARY; T=0.K  
protons from (t,pa)

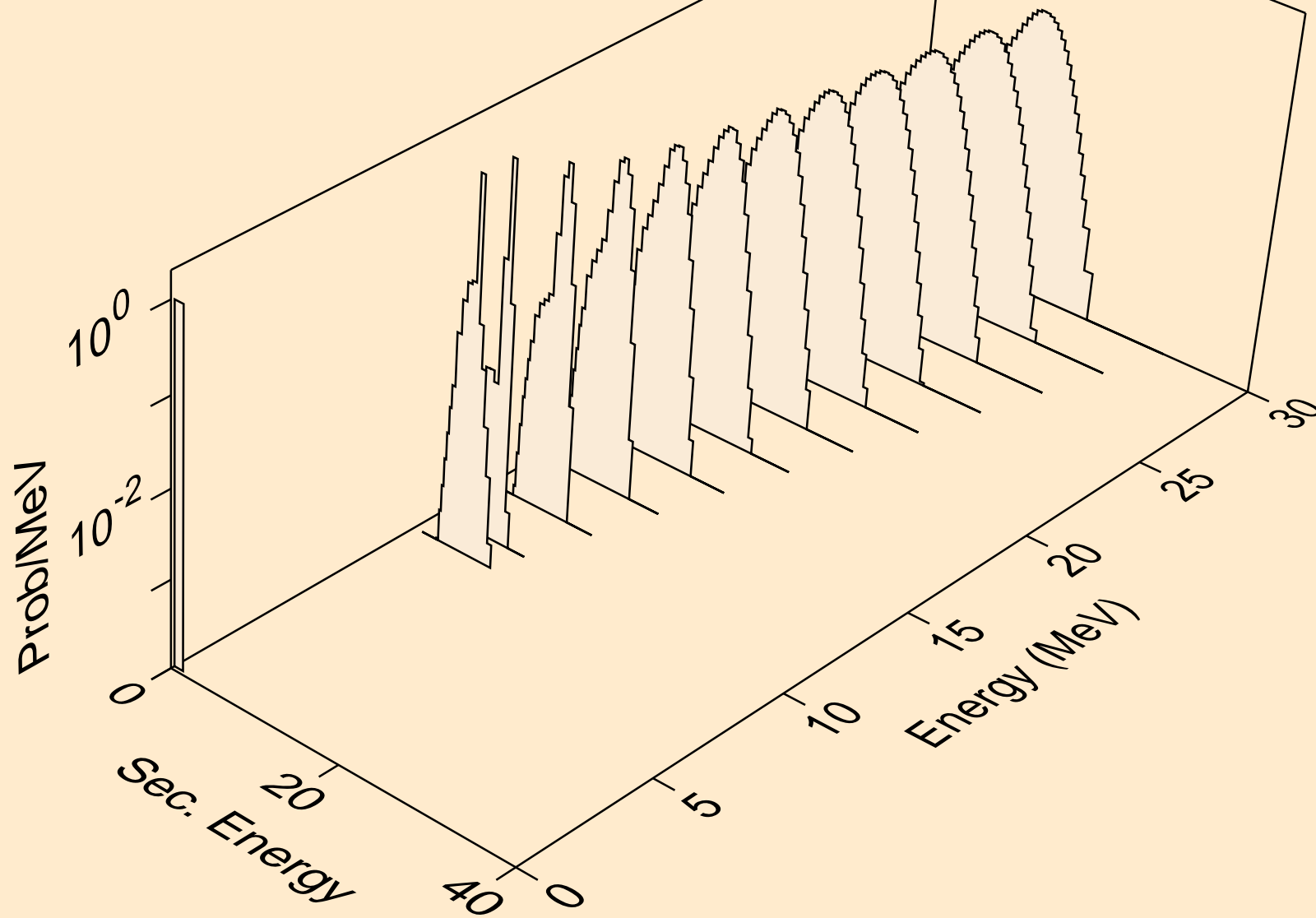

AU196M TRITON ACER TENDL-2021 LIBRARY; T=0.K  
protons from (t,pd)

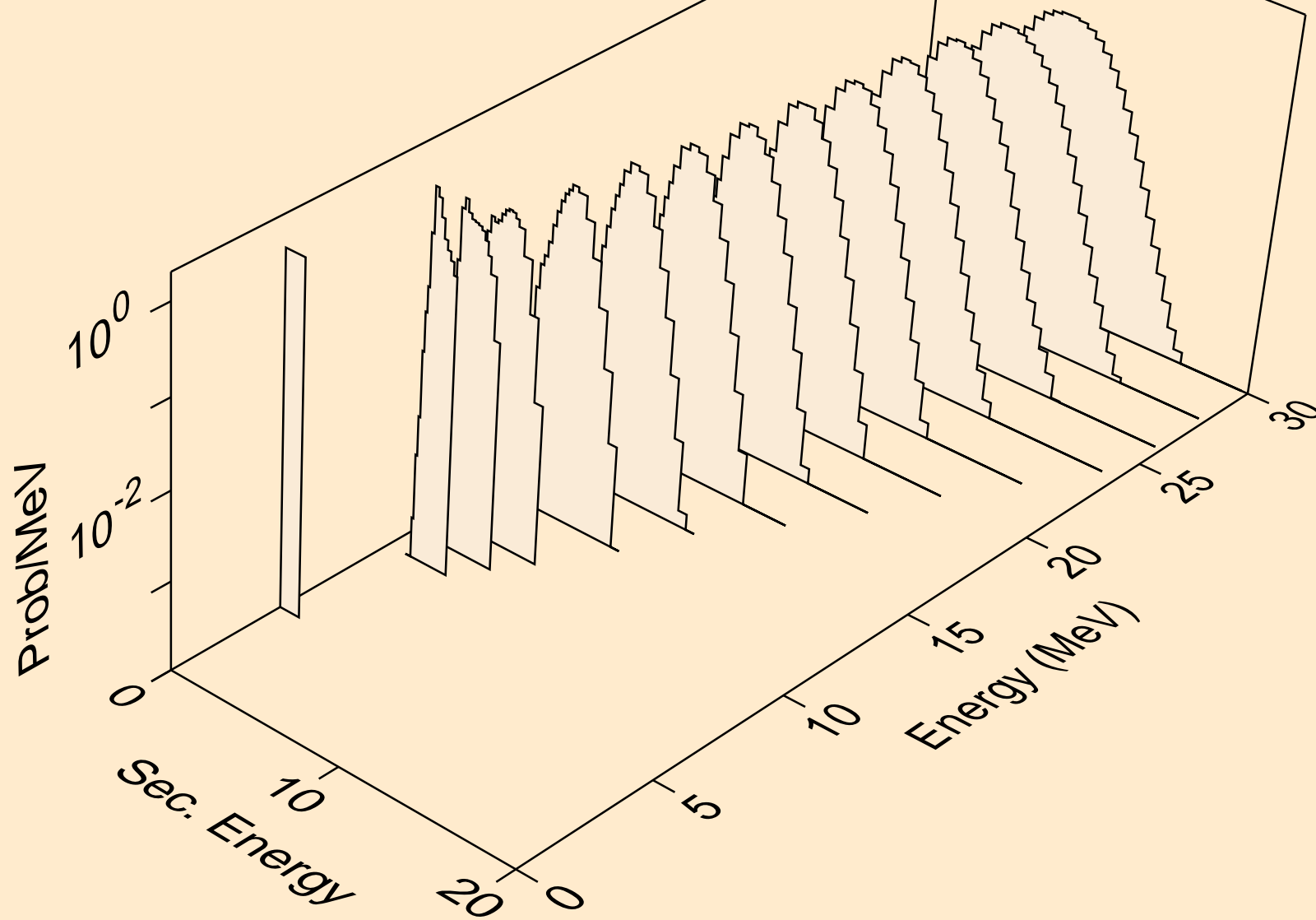

AU196M TRITON ACER TENDL-2021 LIBRARY; T=0.K  
protons from (t,pt)

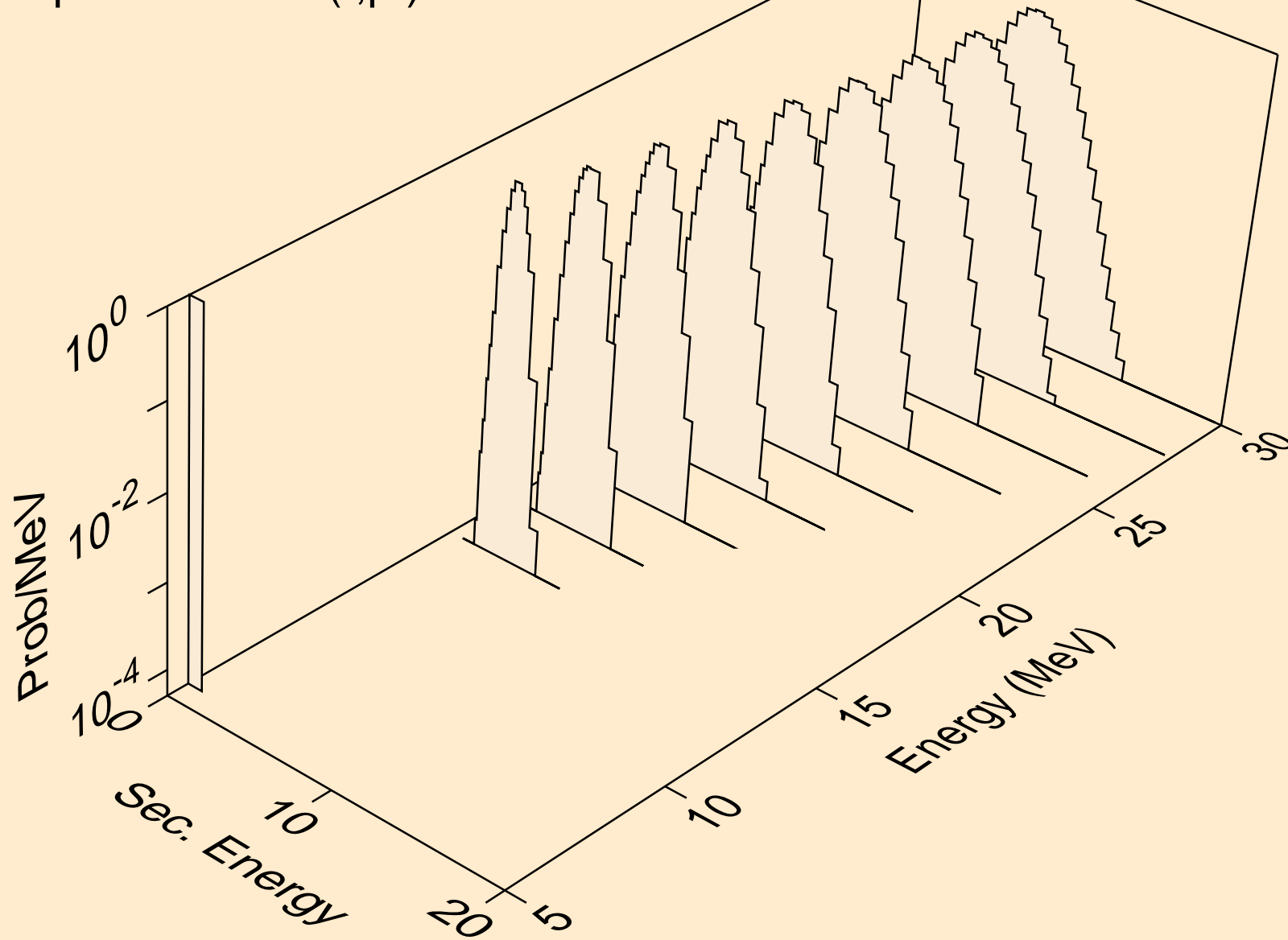

AU196M TRITON ACER TENDL-2021 LIBRARY; T=0.K  
deuterons from (t,x)

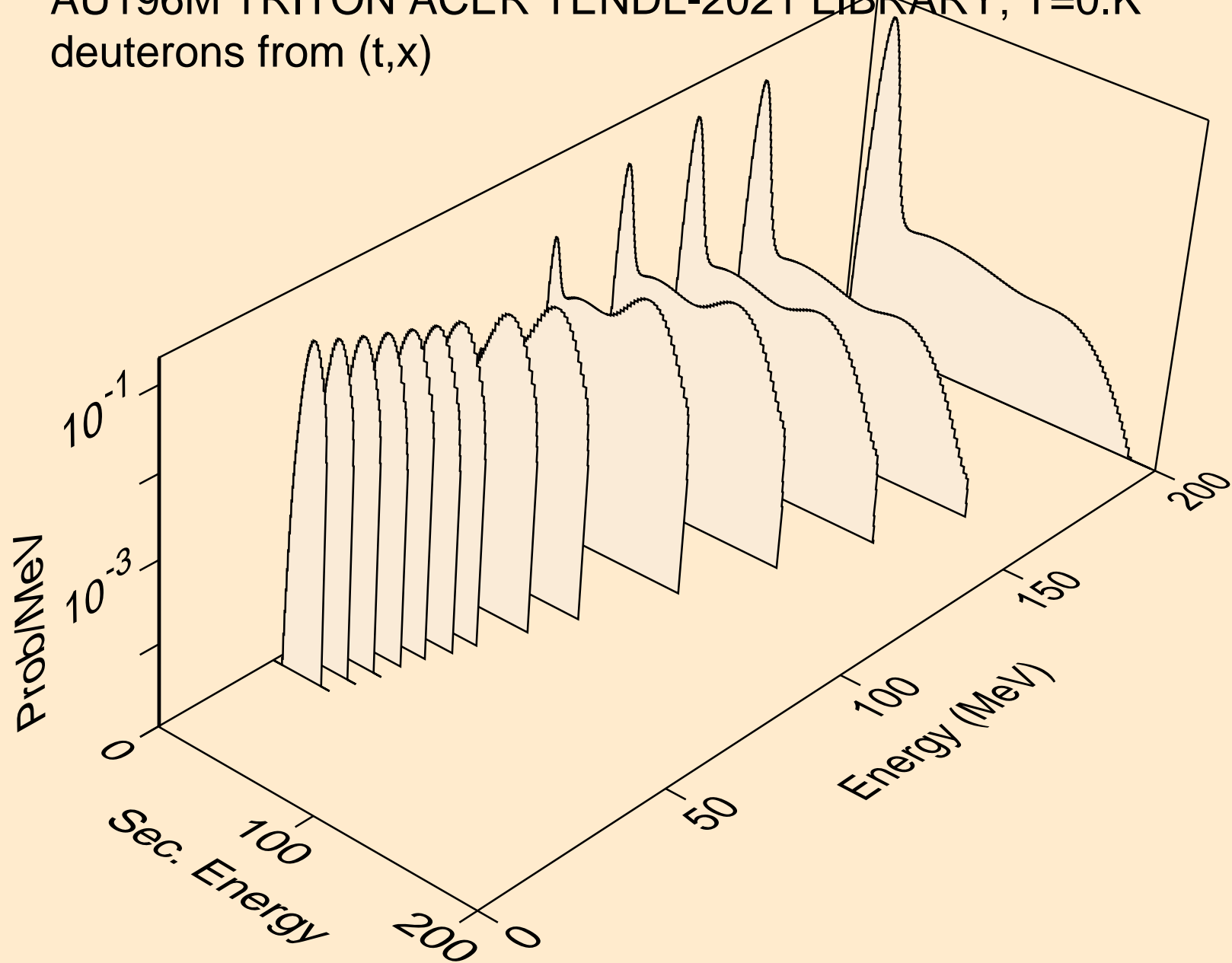

AU196M TRITON ACER TENDL-2021 LIBRARY; T=0.K  
deuterons from (t,2nd)

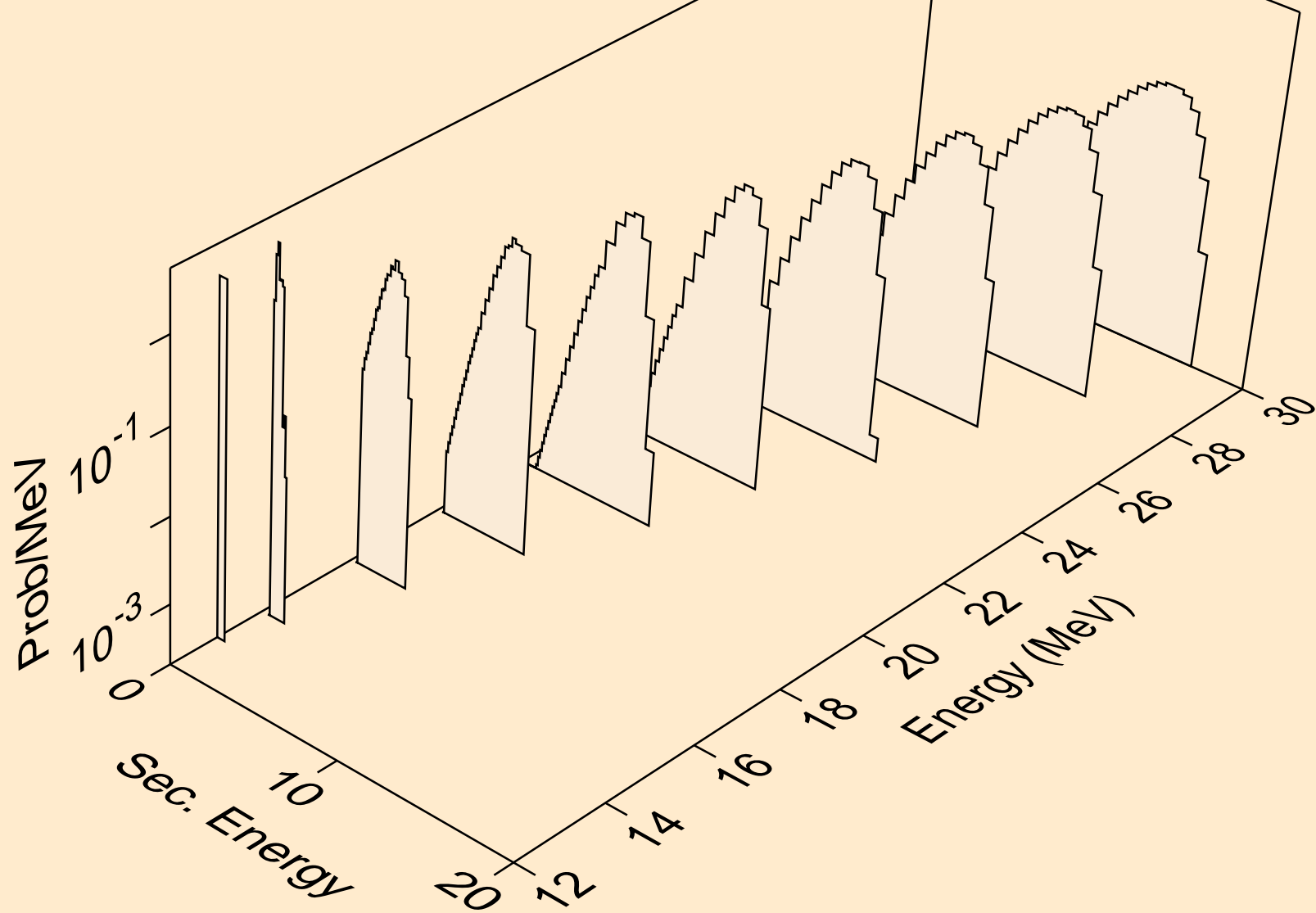

AU196M TRITON ACER TENDL-2021 LIBRARY; T=0.K  
deuterons from (t,n\*)d

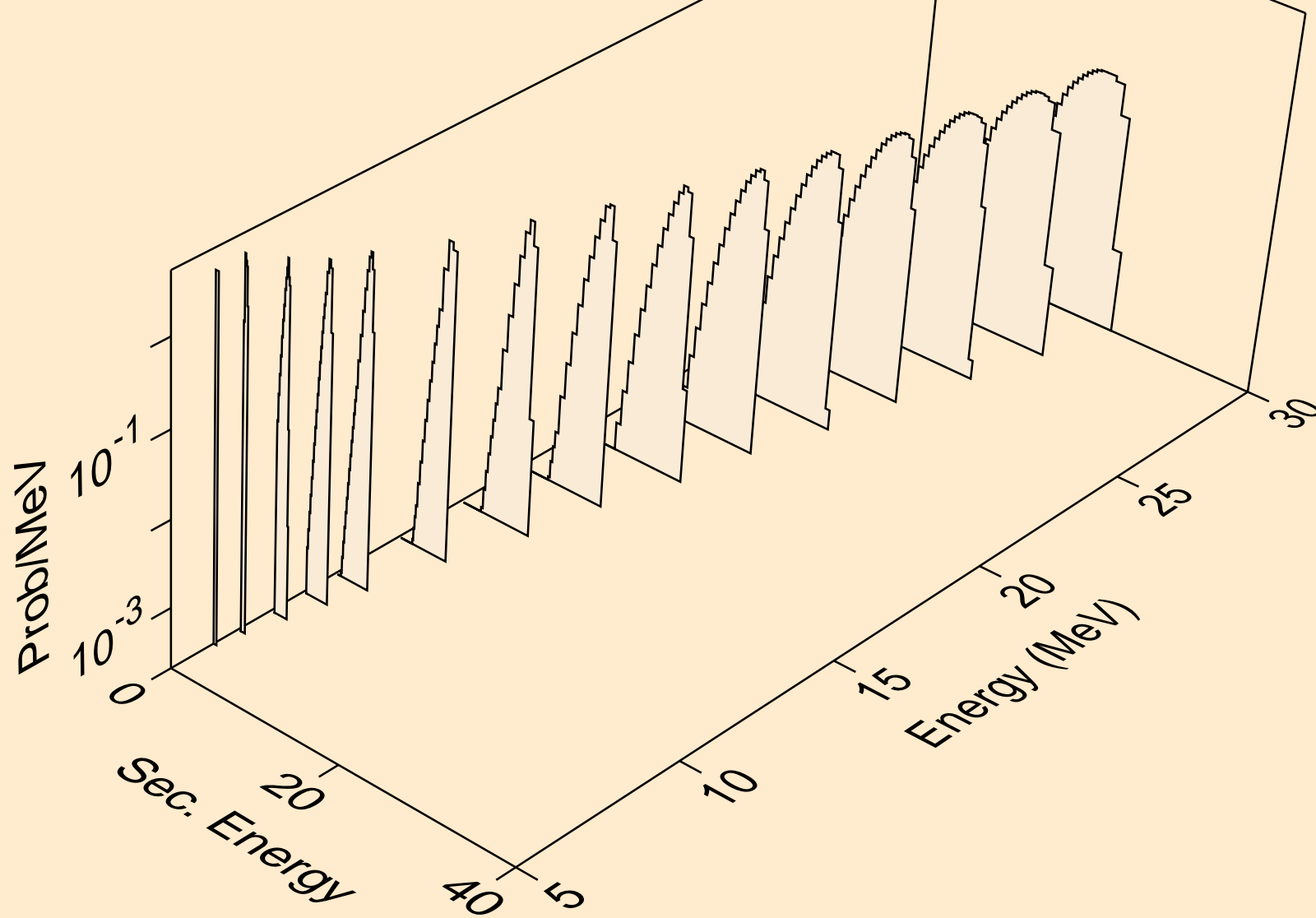

AU196M TRITON ACER TENDL-2021 LIBRARY; T=0.K  
deuterons from (t,d)

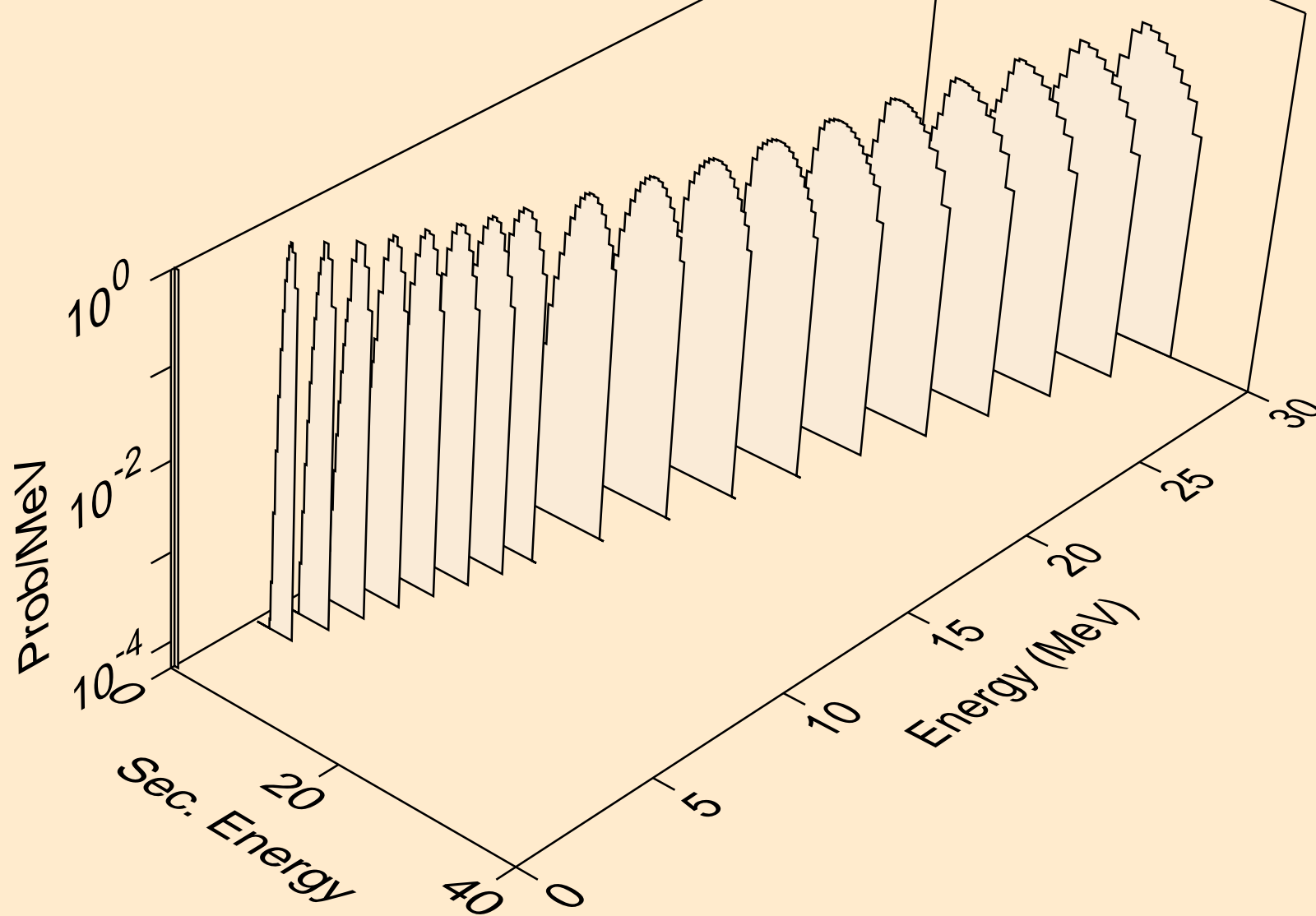

AU196M TRITON ACER TENDL-2021 LIBRARY; T=0.K  
deuterons from (t,pd)

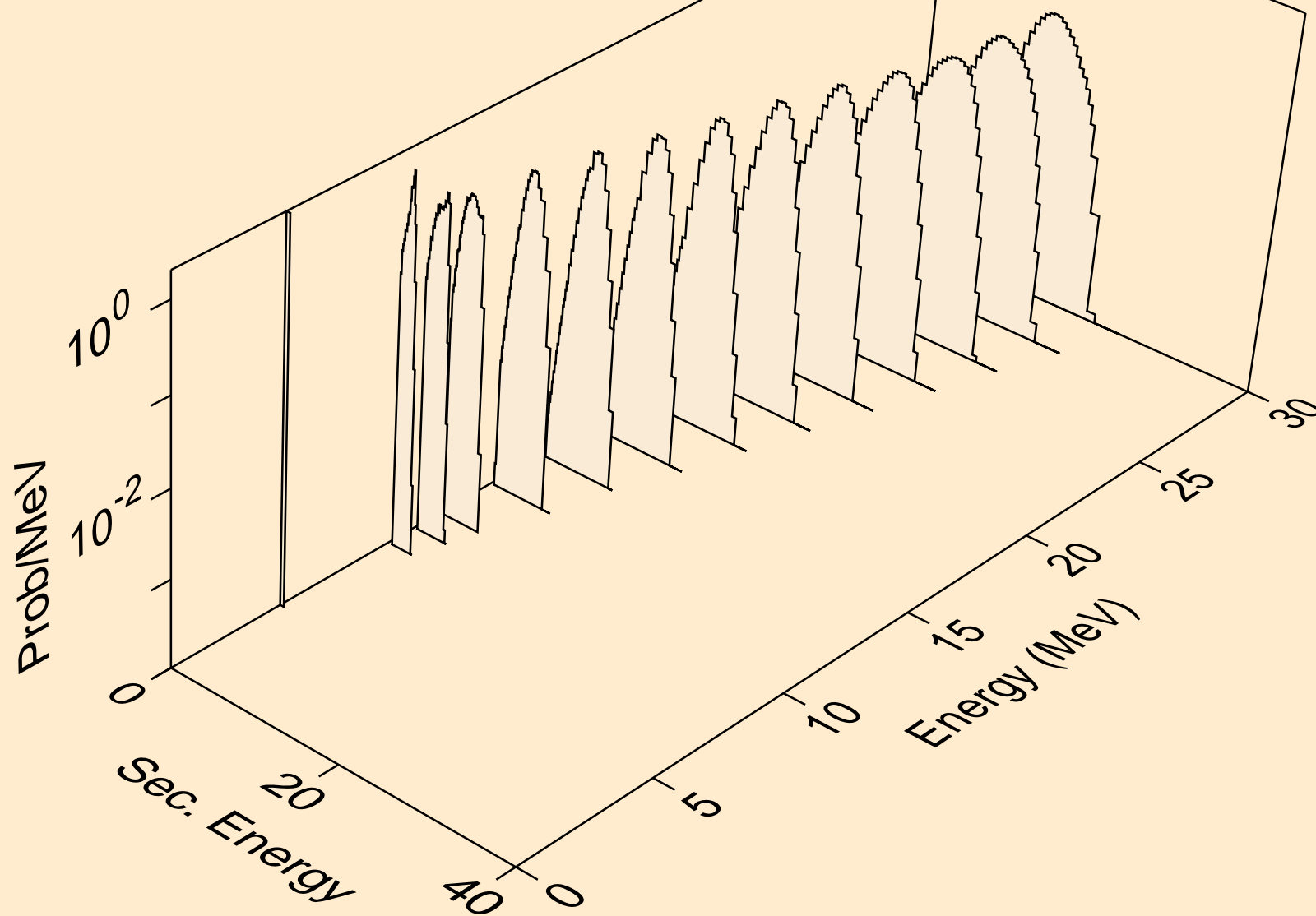



AU196M TRITON ACER TENDL-2021 LIBRARY; T=0.K  
deuterons from (t,da)

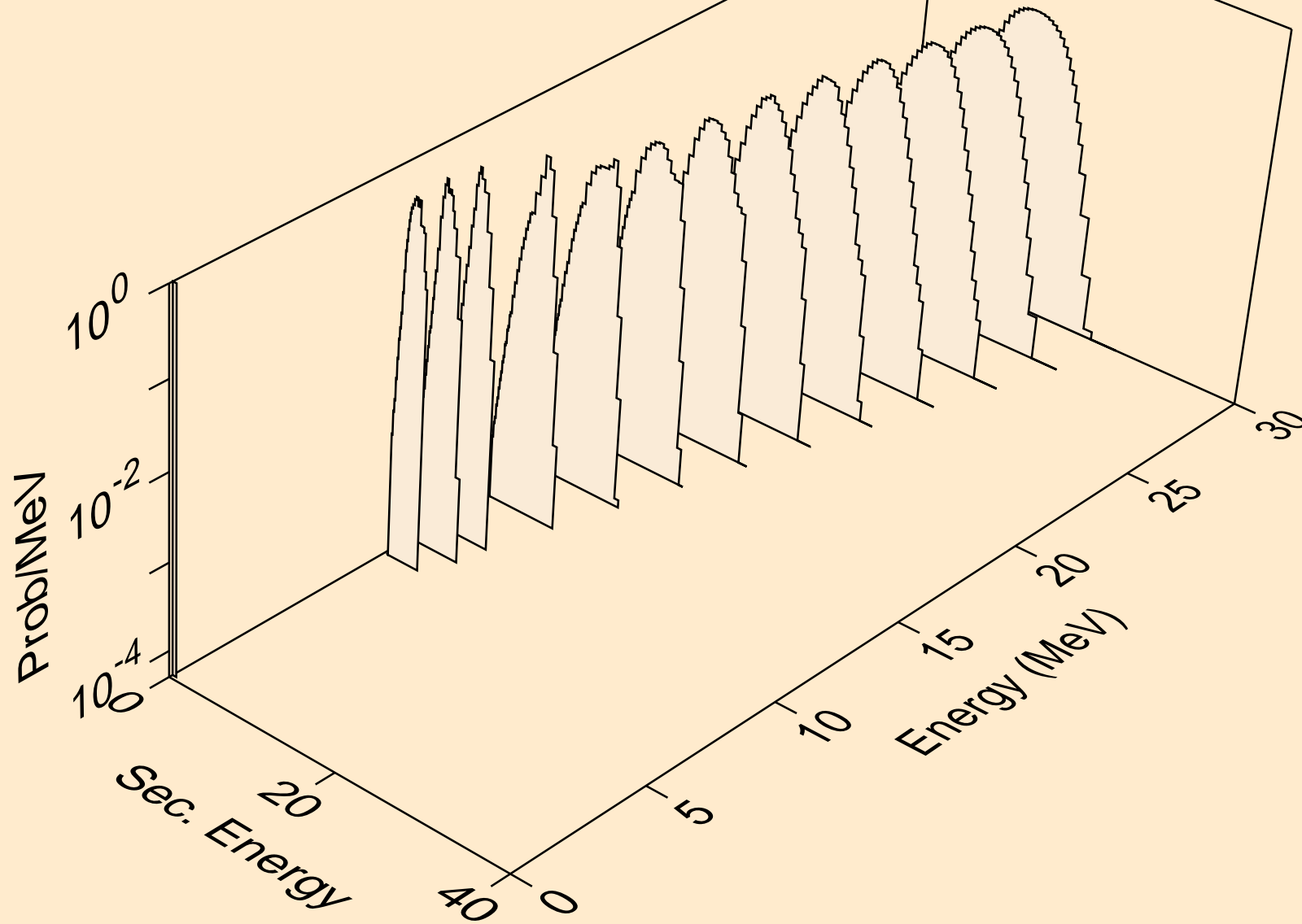

AU196M TRITON ACER TENDL-2021 LIBRARY; T=0.K  
he3s from (t,x)

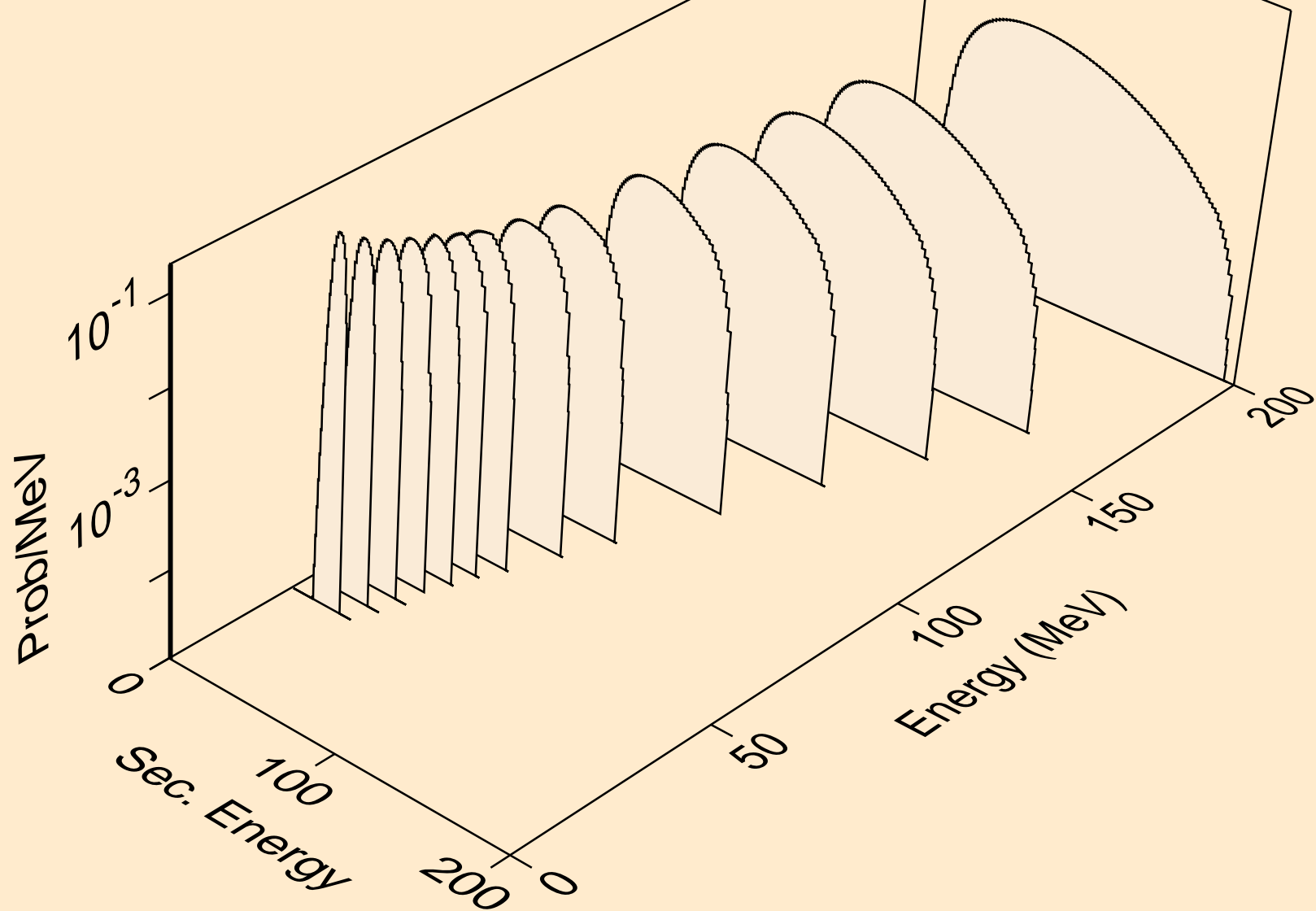

AU196M TRITON ACER TENDL-2021 LIBRARY; T=0.K  
he3s from (t,n\*)he3

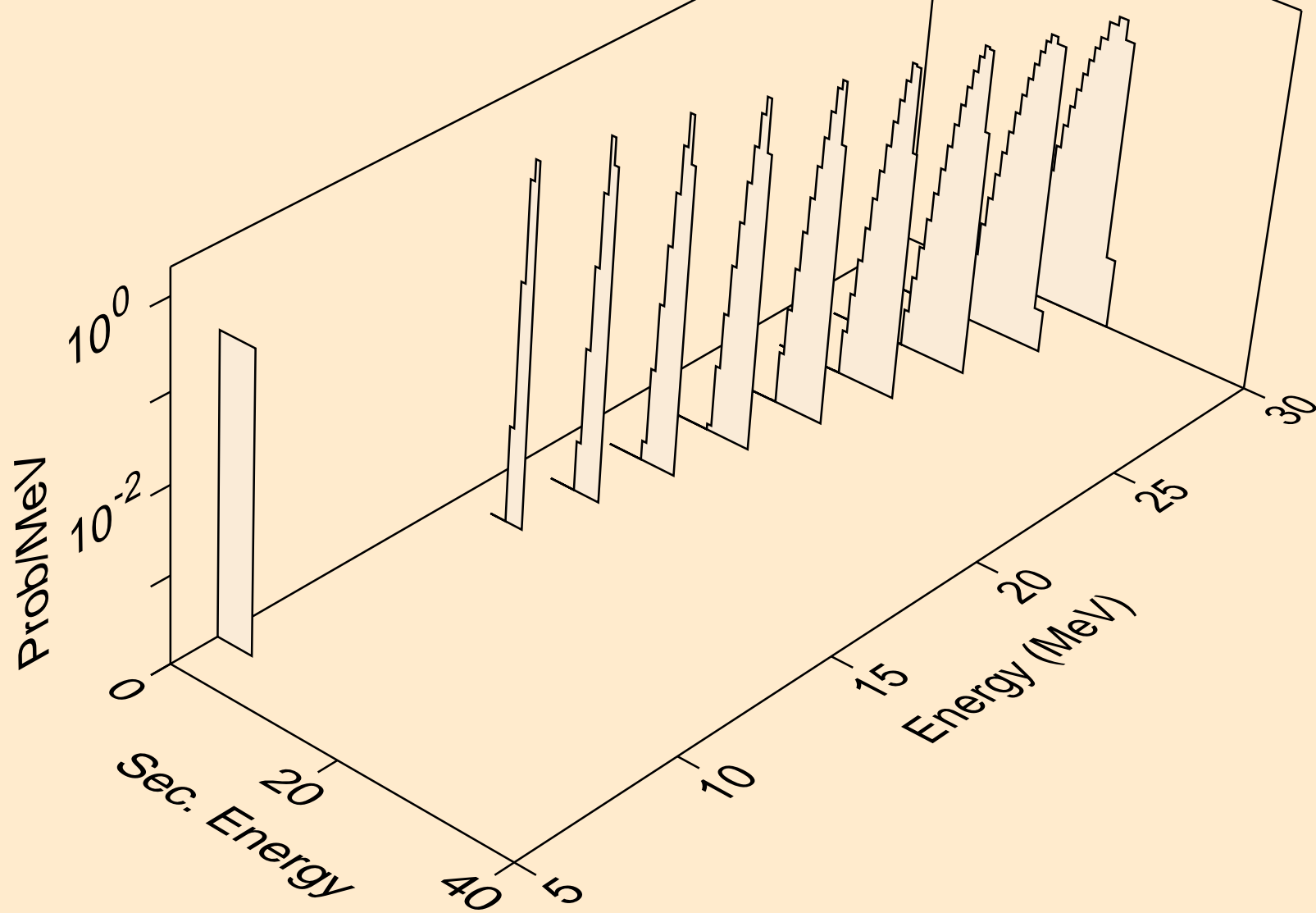

AU196M TRITON ACER TENDL-2021 LIBRARY; T=0.K  
he3s from (t,he3)

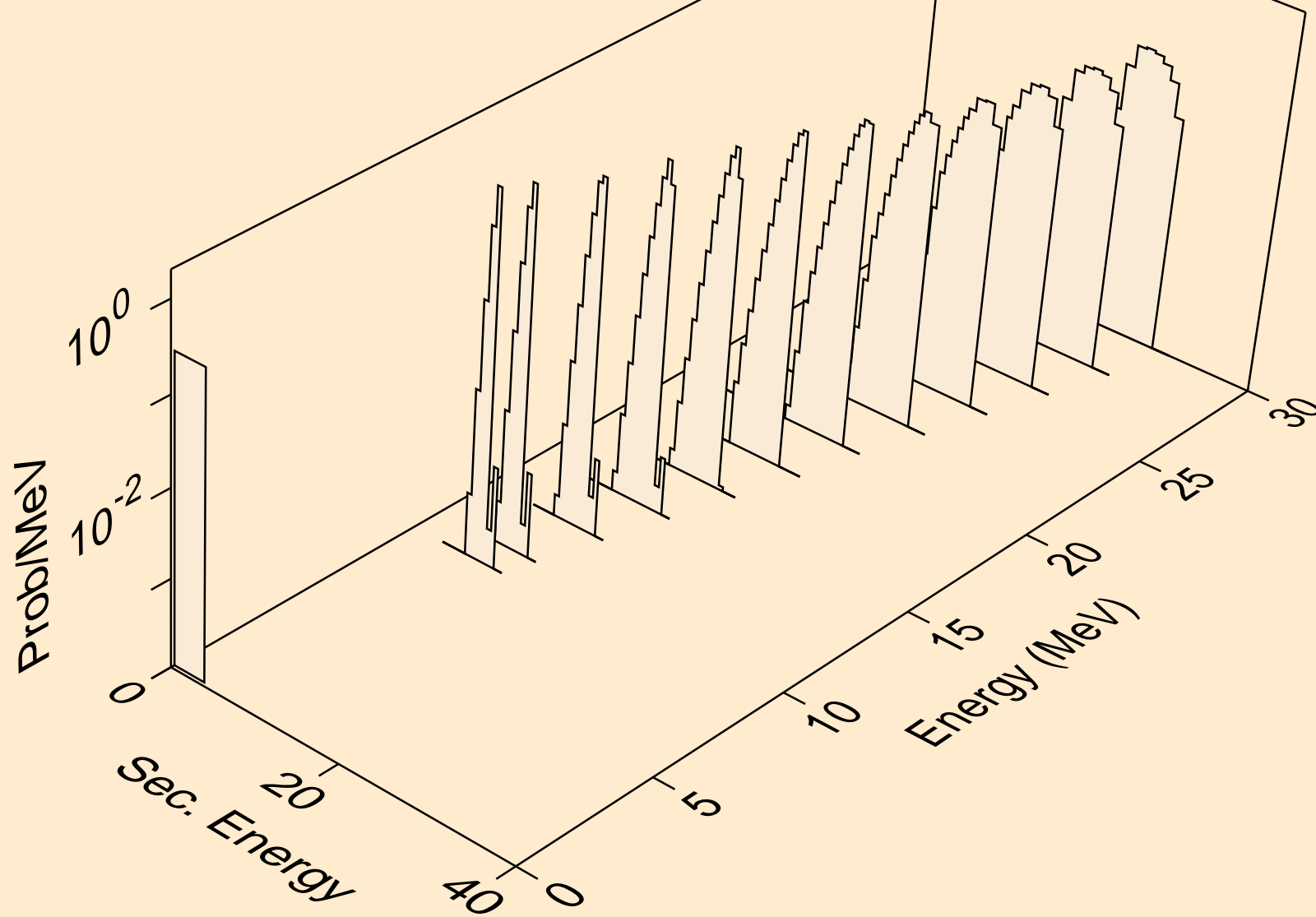

AU196M TRITON ACER TENDL-2021 LIBRARY; T=0.K  
alphas from (t,x)

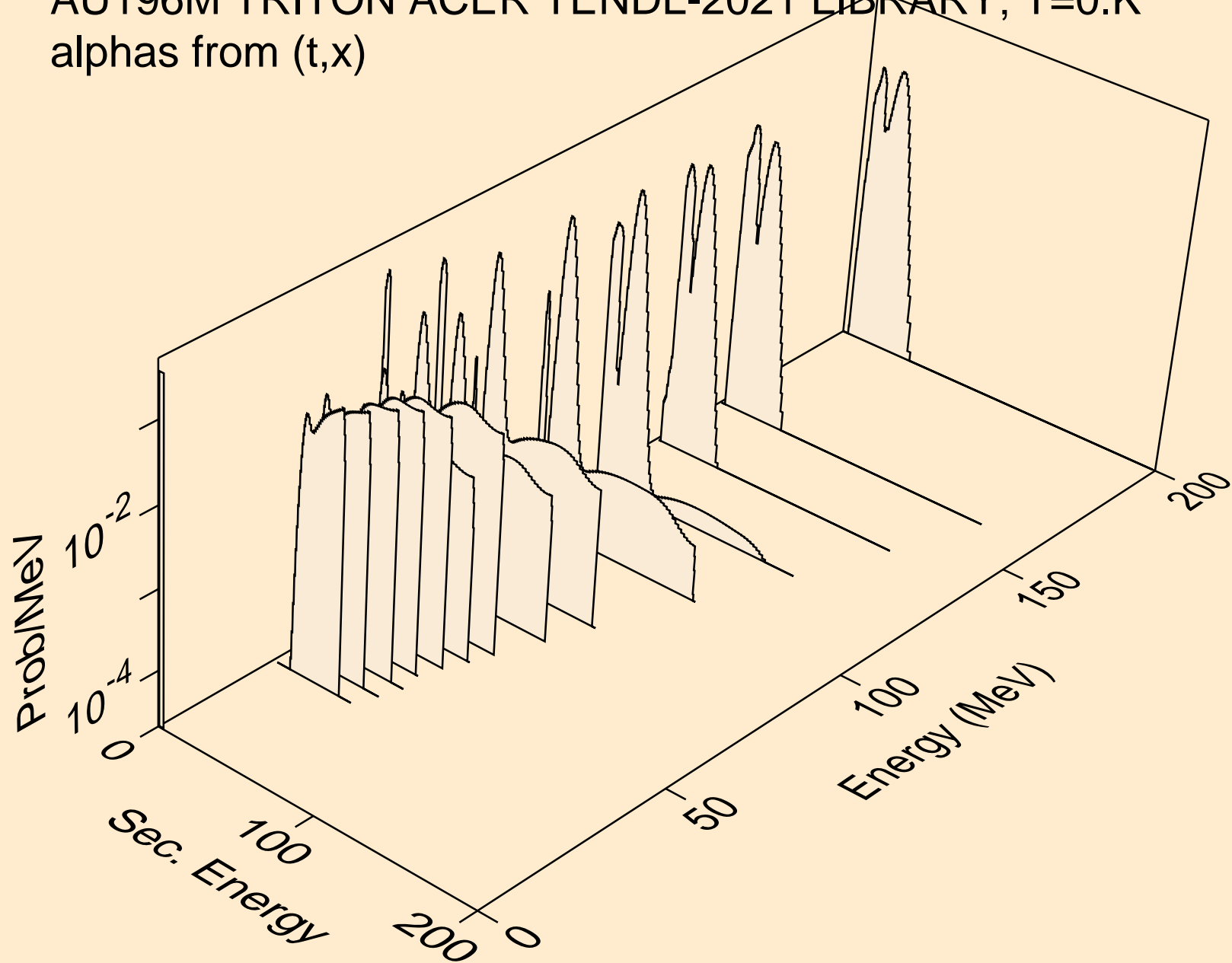

AU196M TRITON ACER TENDL-2021 LIBRARY; T=0.K  
alphas from (t,n\*)a

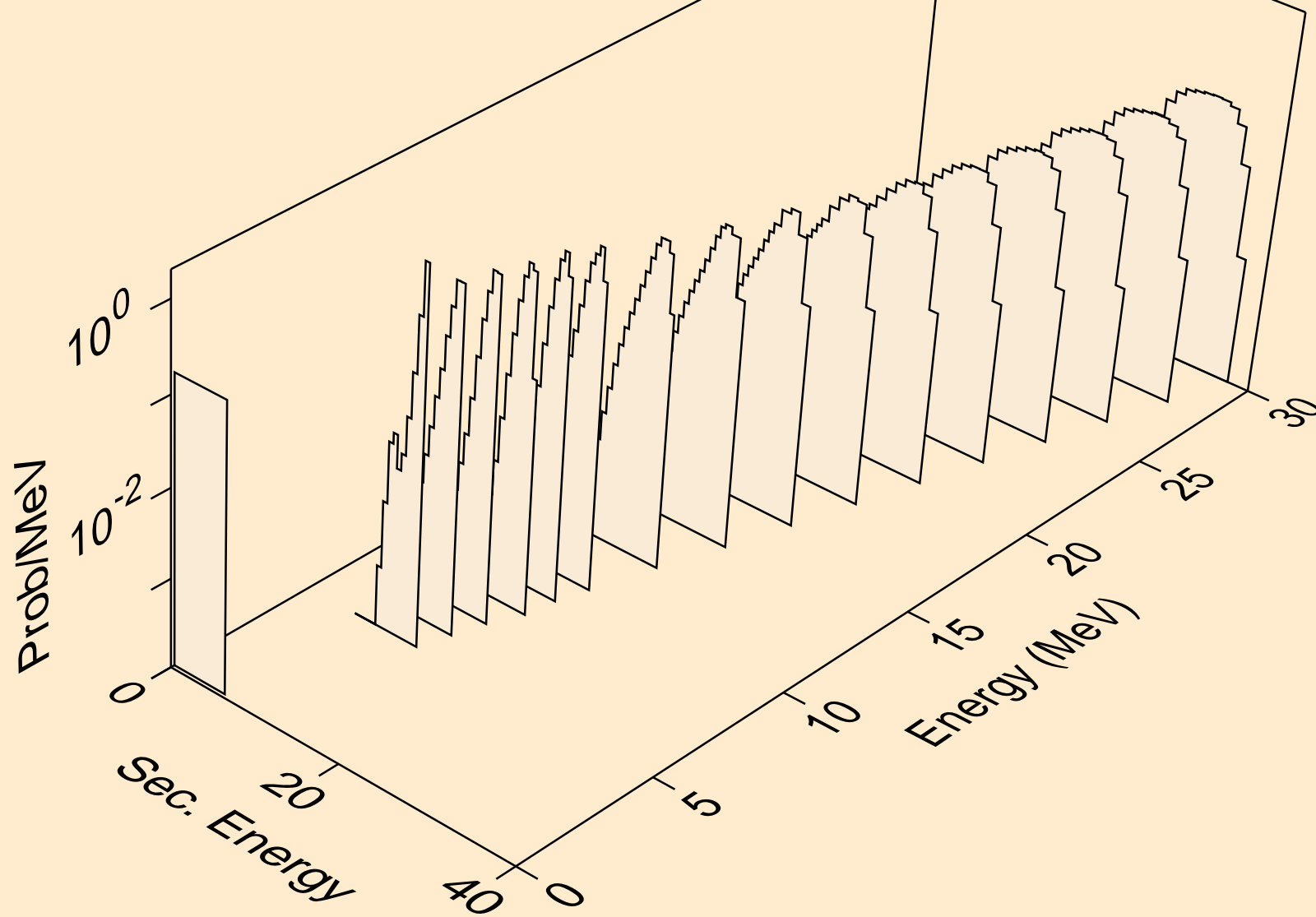

AU196M TRITON ACER TENDL-2021 LIBRARY; T=0.K  
alphas from (t,2n)a

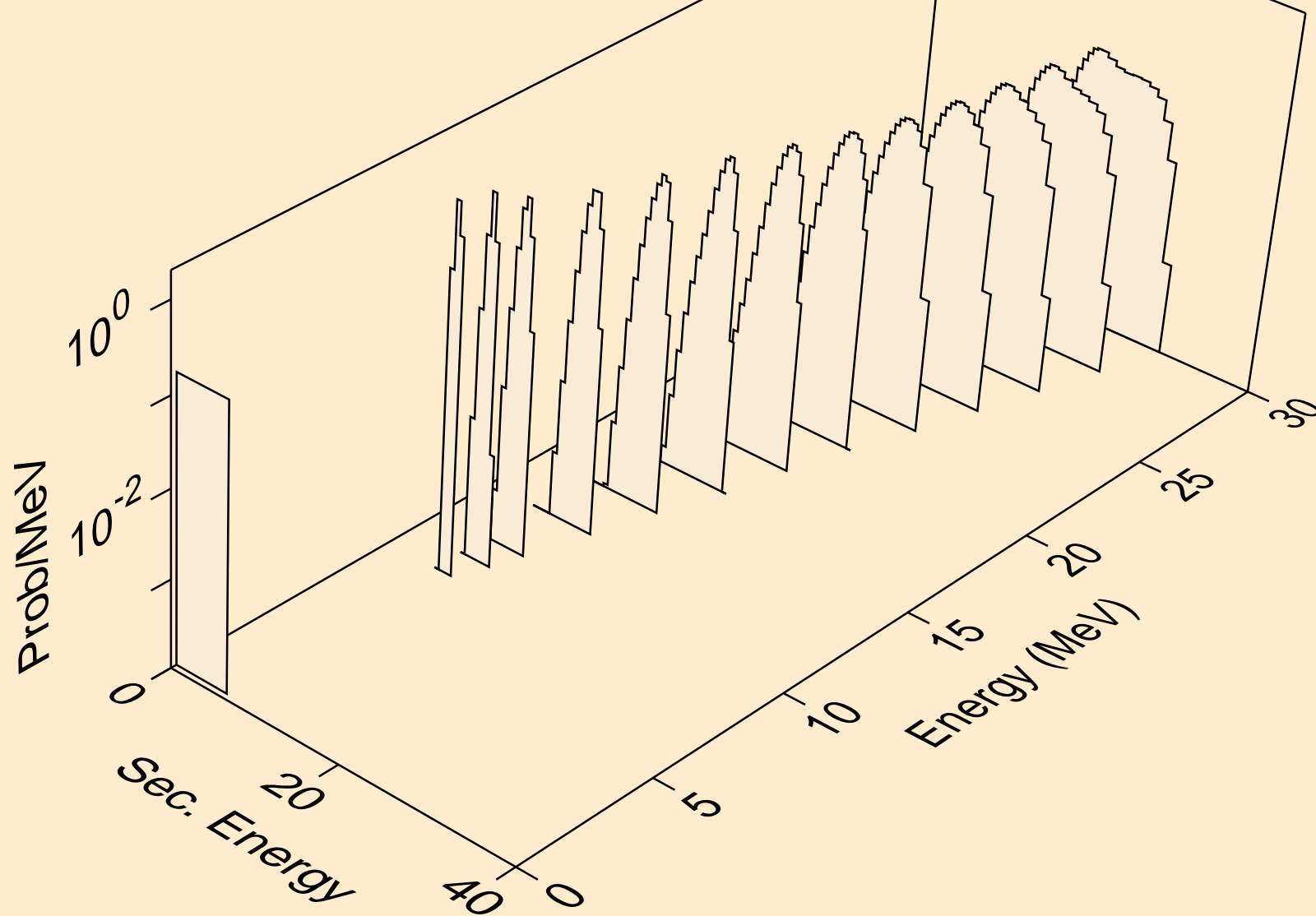

AU196M TRITON ACER TENDL-2021 LIBRARY; T=0.K  
alphas from (t,3n)a

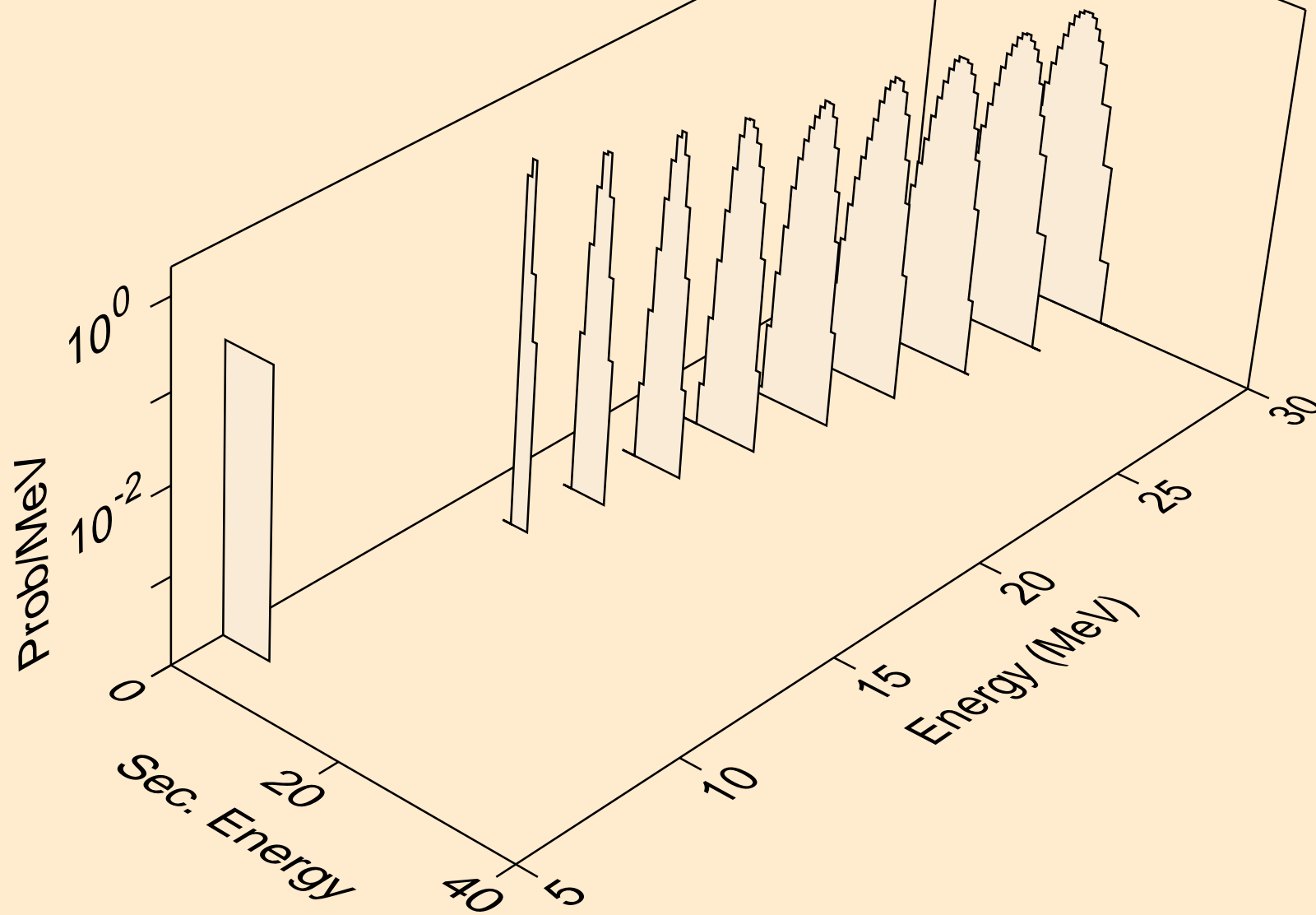



AU196M TRITON ACER TENDL-2021 LIBRARY; T=0.K  
alphas from (t,n\*)2a

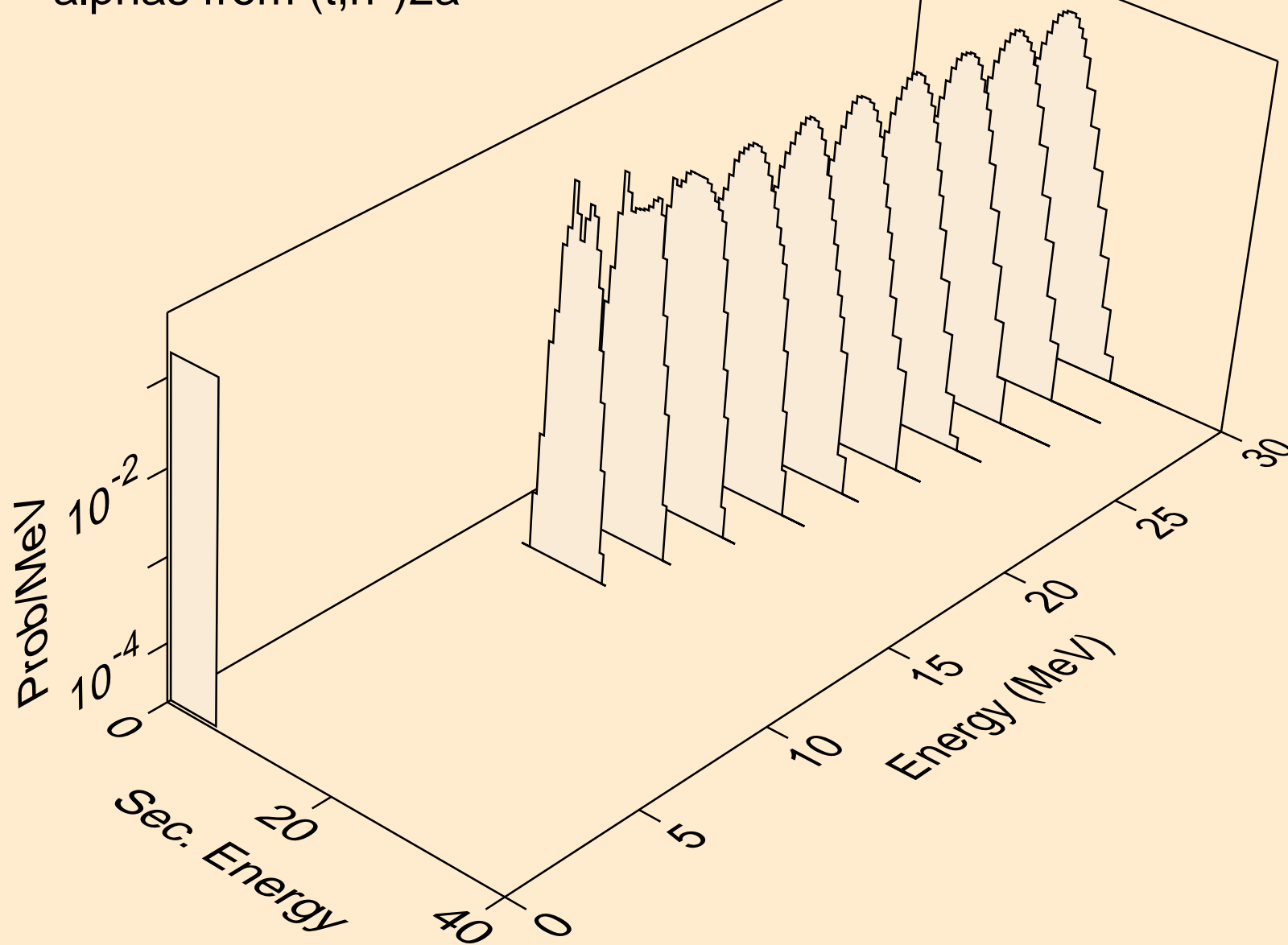

AU196M TRITON ACER TENDL-2021 LIBRARY; T=0.K  
alphas from (t,npa)

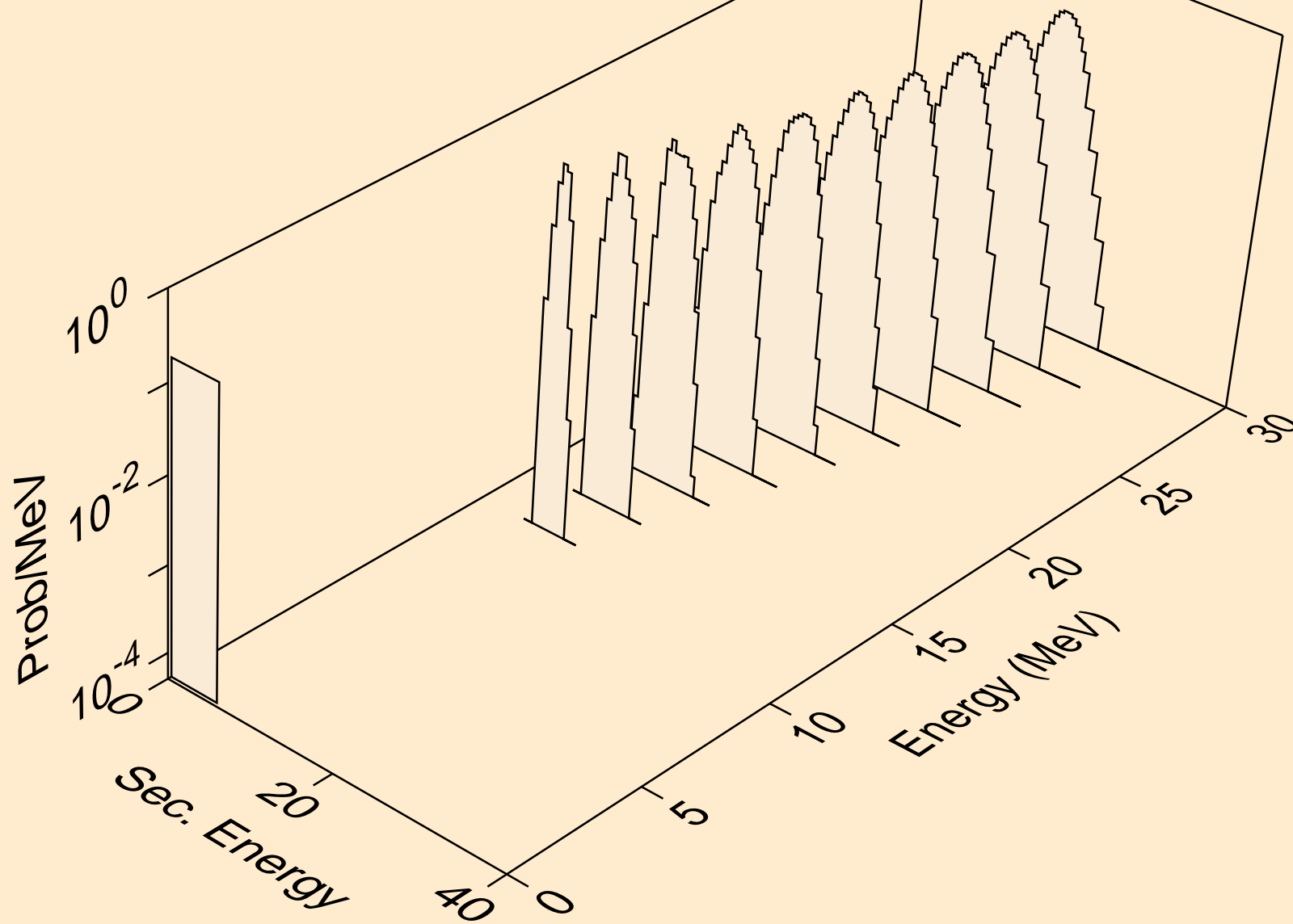

AU196M TRITON ACER TENDL-2021 LIBRARY; T=0.K  
alphas from (t,a)

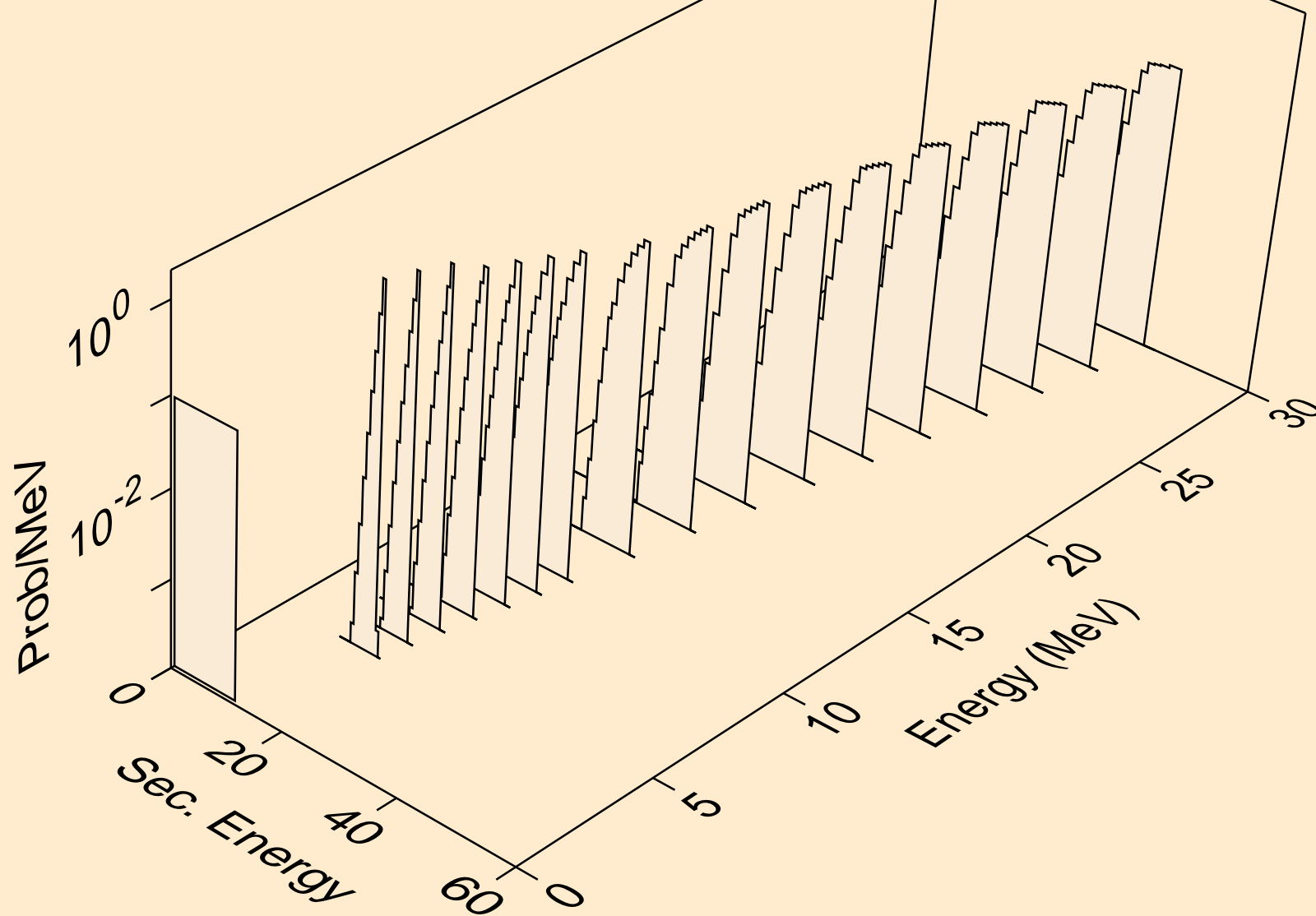

AU196M TRITON ACER TENDL-2021 LIBRARY; T=0.K  
alphas from (t,2a)

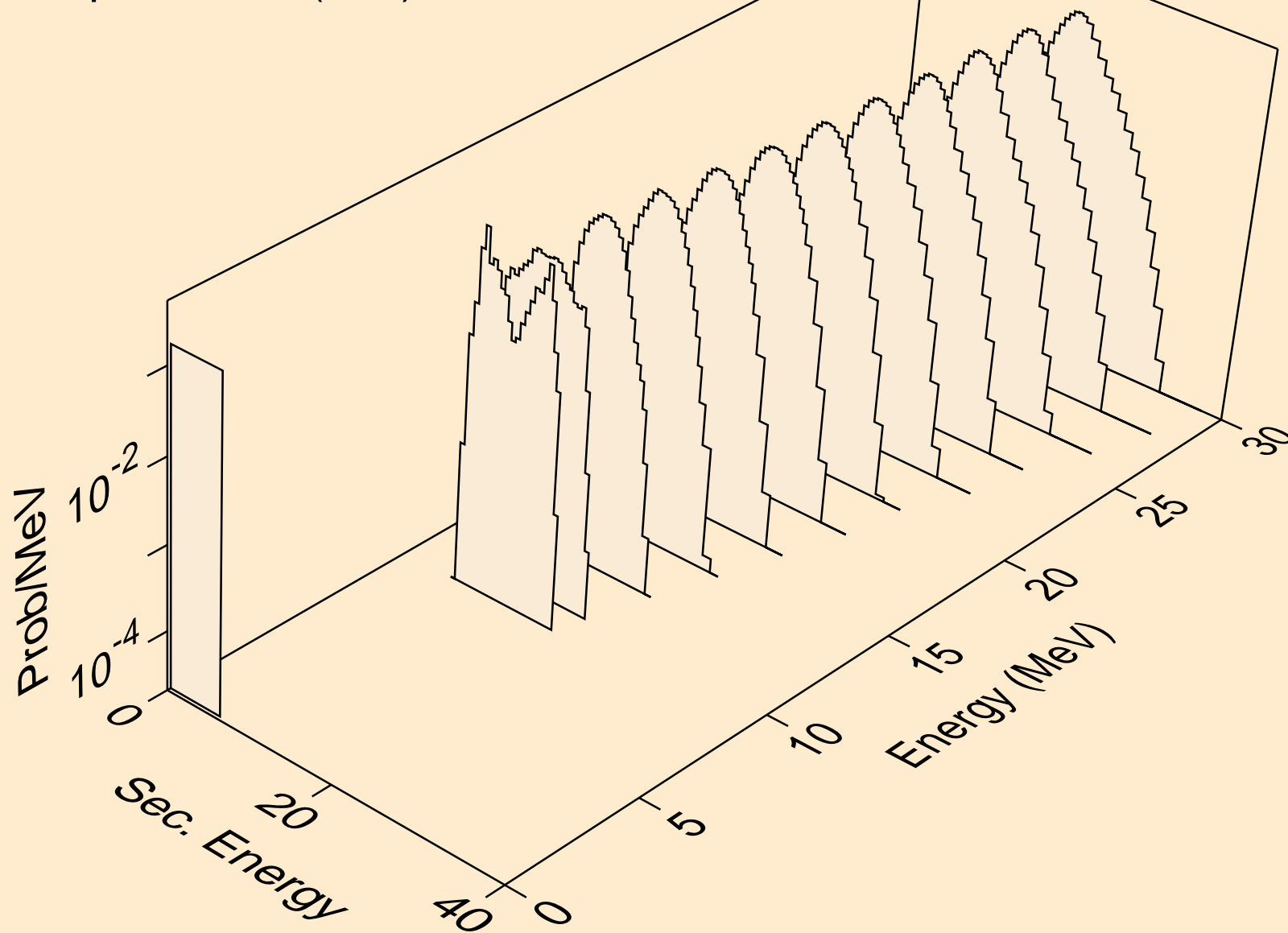

AU196M TRITON ACER TENDL-2021 LIBRARY; T=0.K  
alphas from (t,pa)

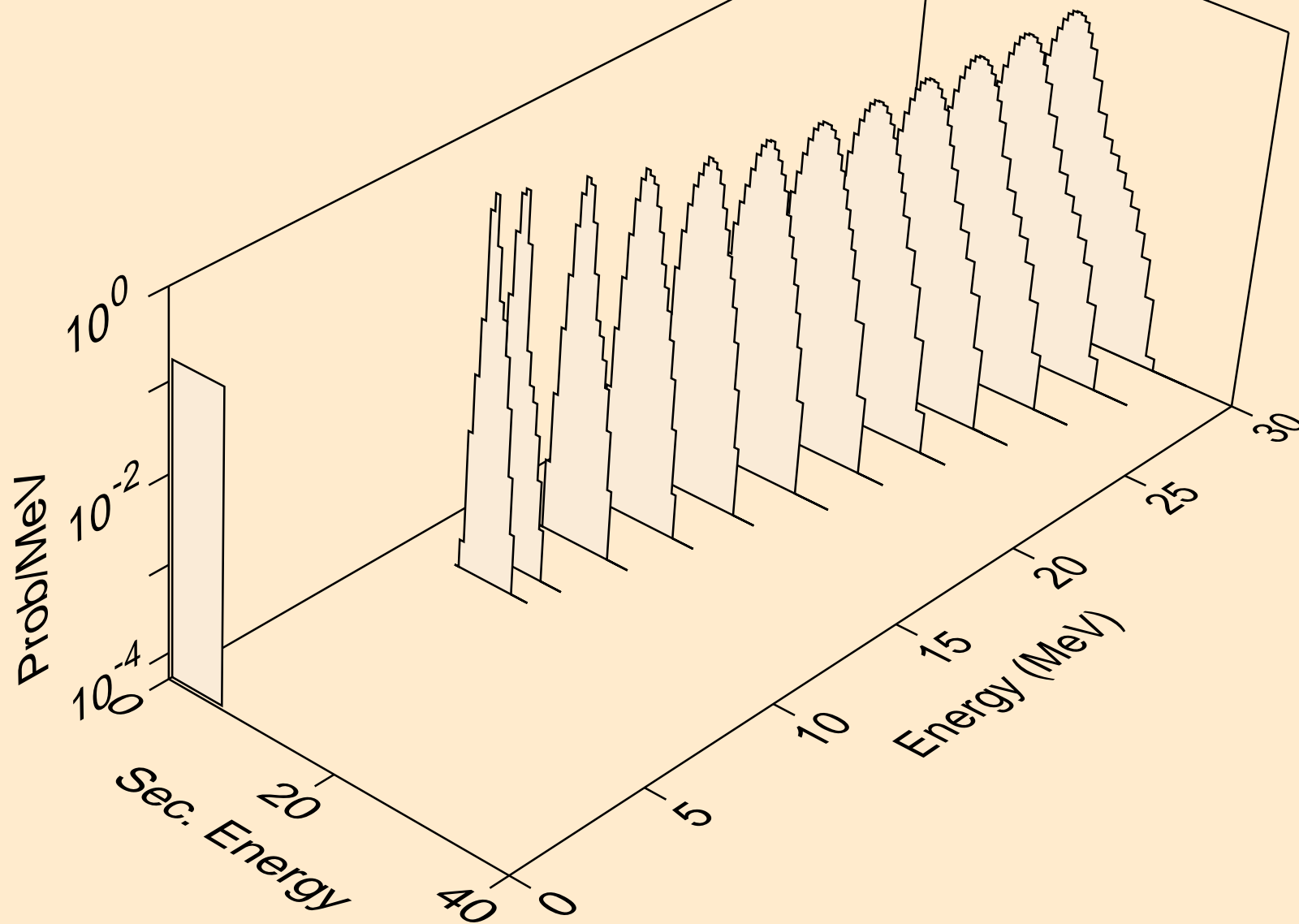

AU196M TRITON ACER TENDL-2021 LIBRARY; T=0.K  
alphas from (t,da)

