

BA117 TRITON ACER TENDL-2021 LIBRARY; T=0.K  
Principal cross sections

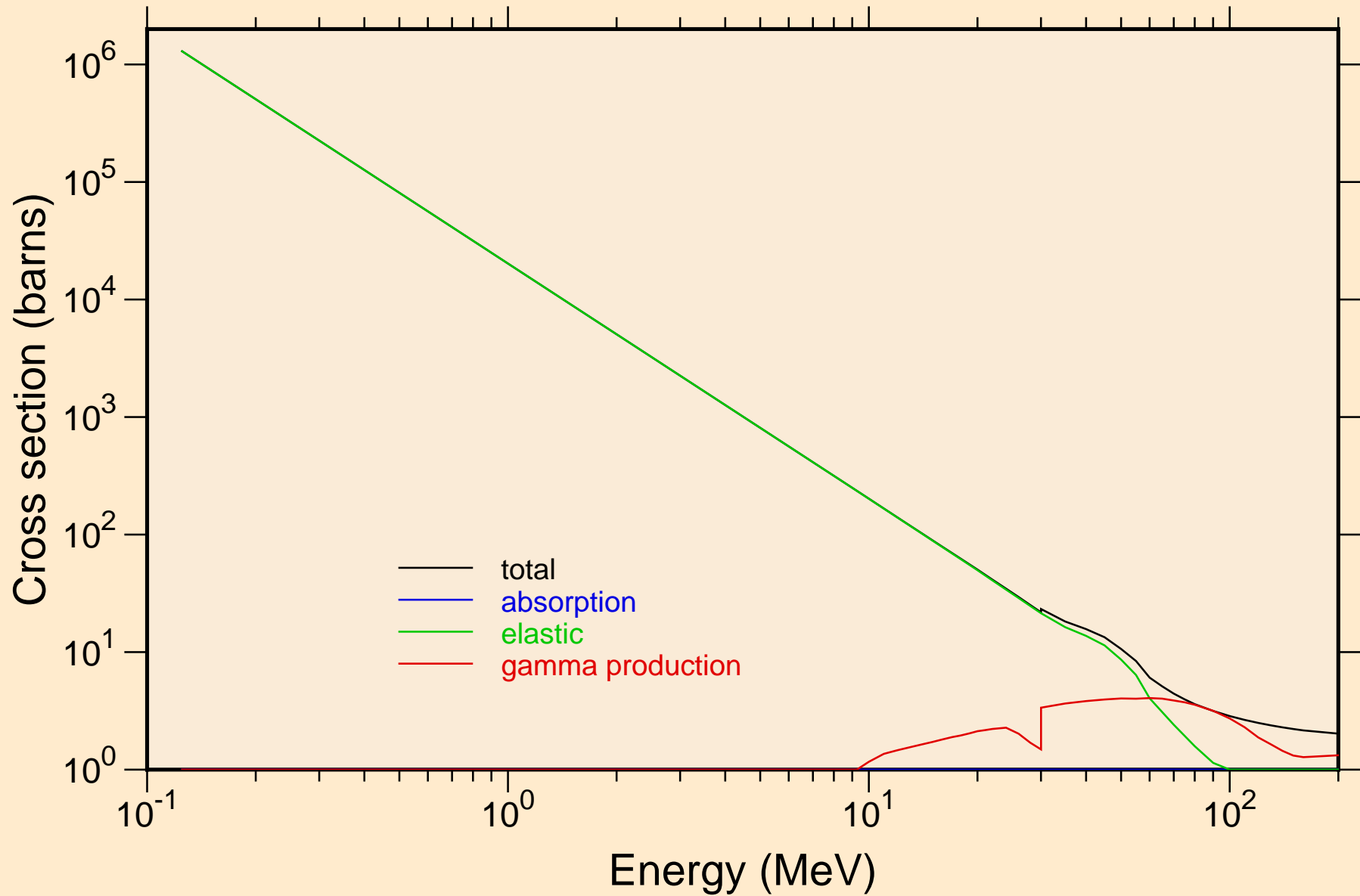

BA117 TRITON ACER TENDL-2021 LIBRARY; T=0.K

Heating

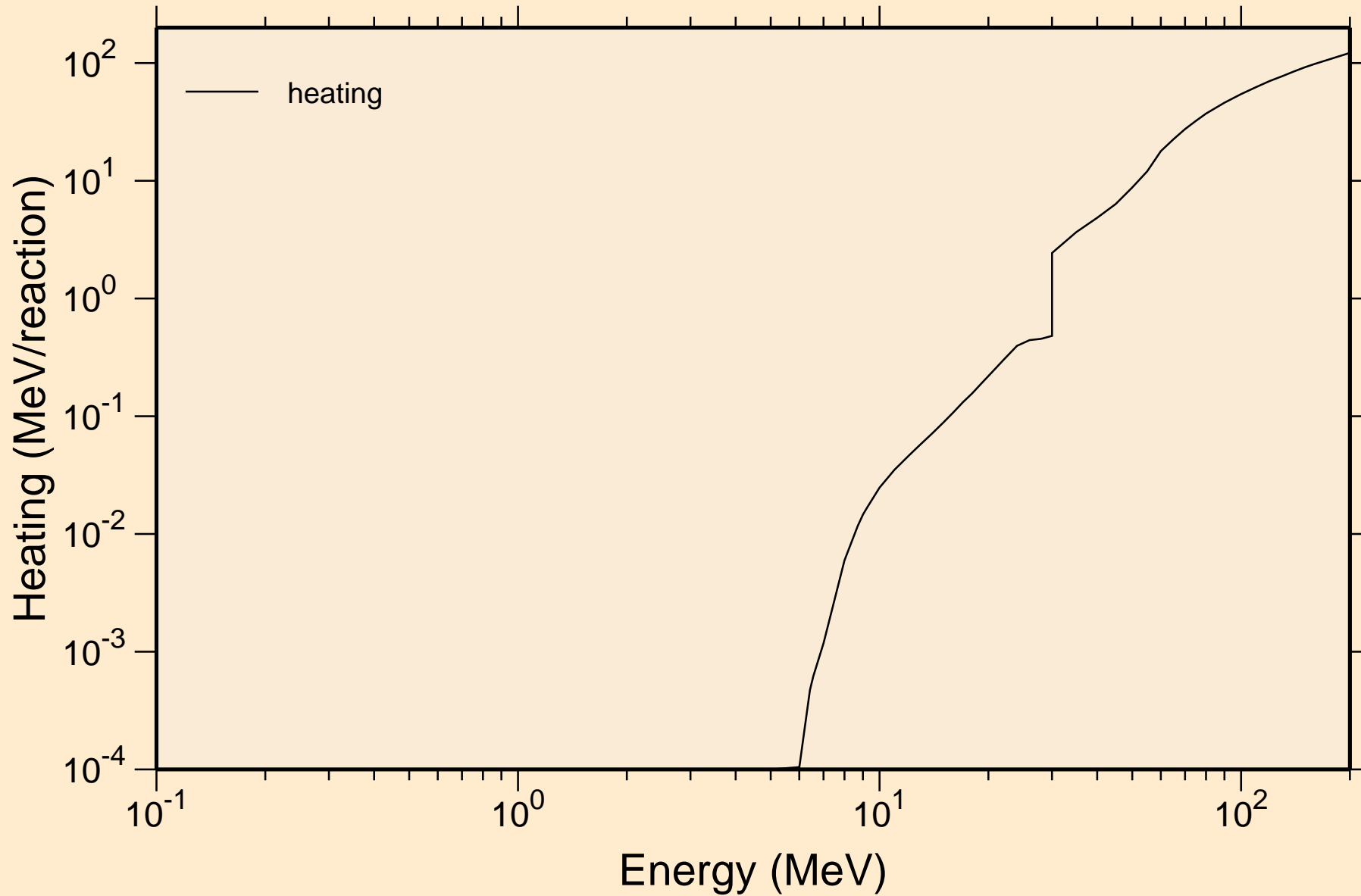

# BA117 TRITON ACER TENDL-2021 LIBRARY; T=0.K

## Principal cross sections

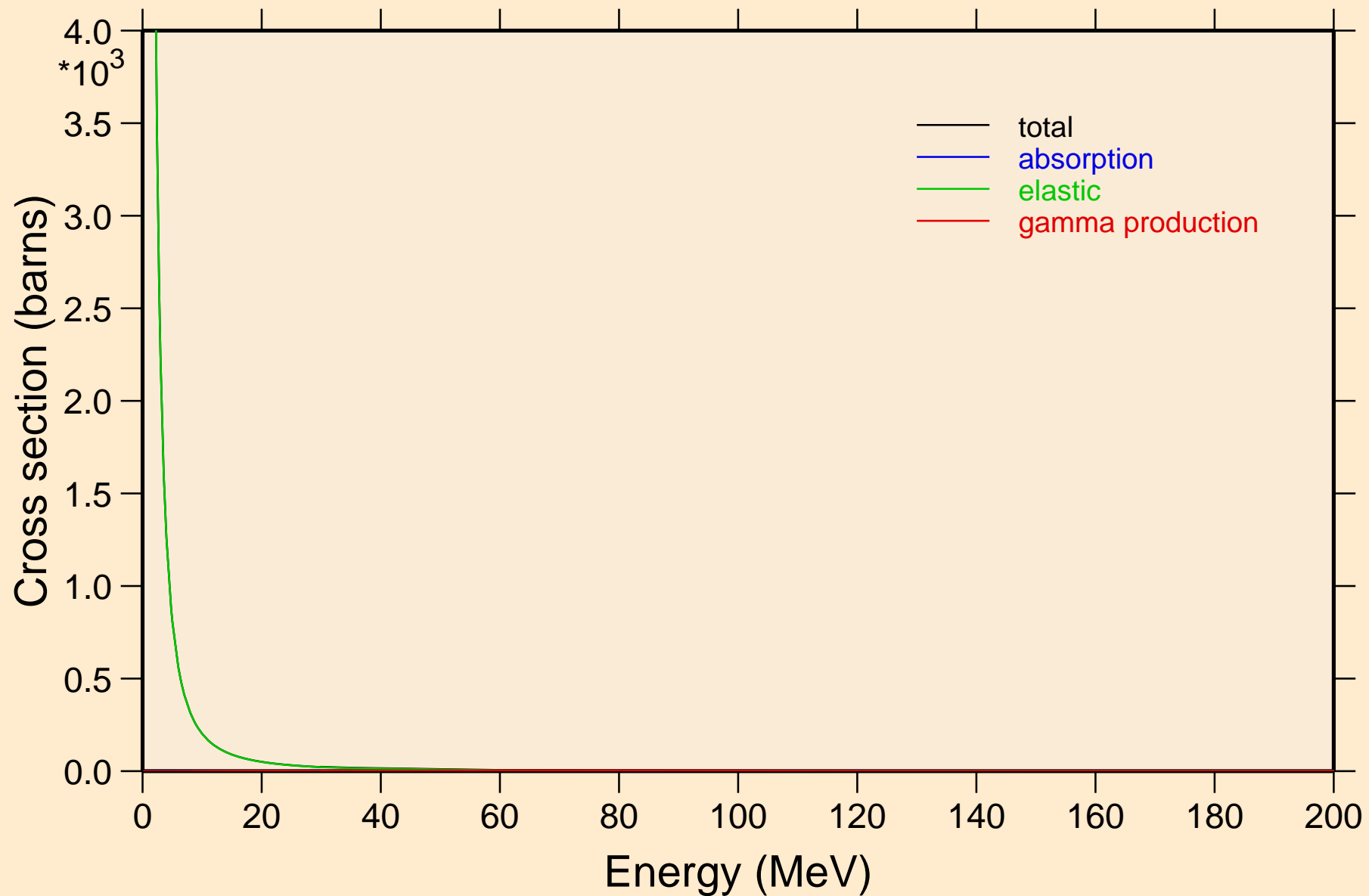

BA117 TRITON ACER TENDL-2021 LIBRARY; T=0.K

Heating

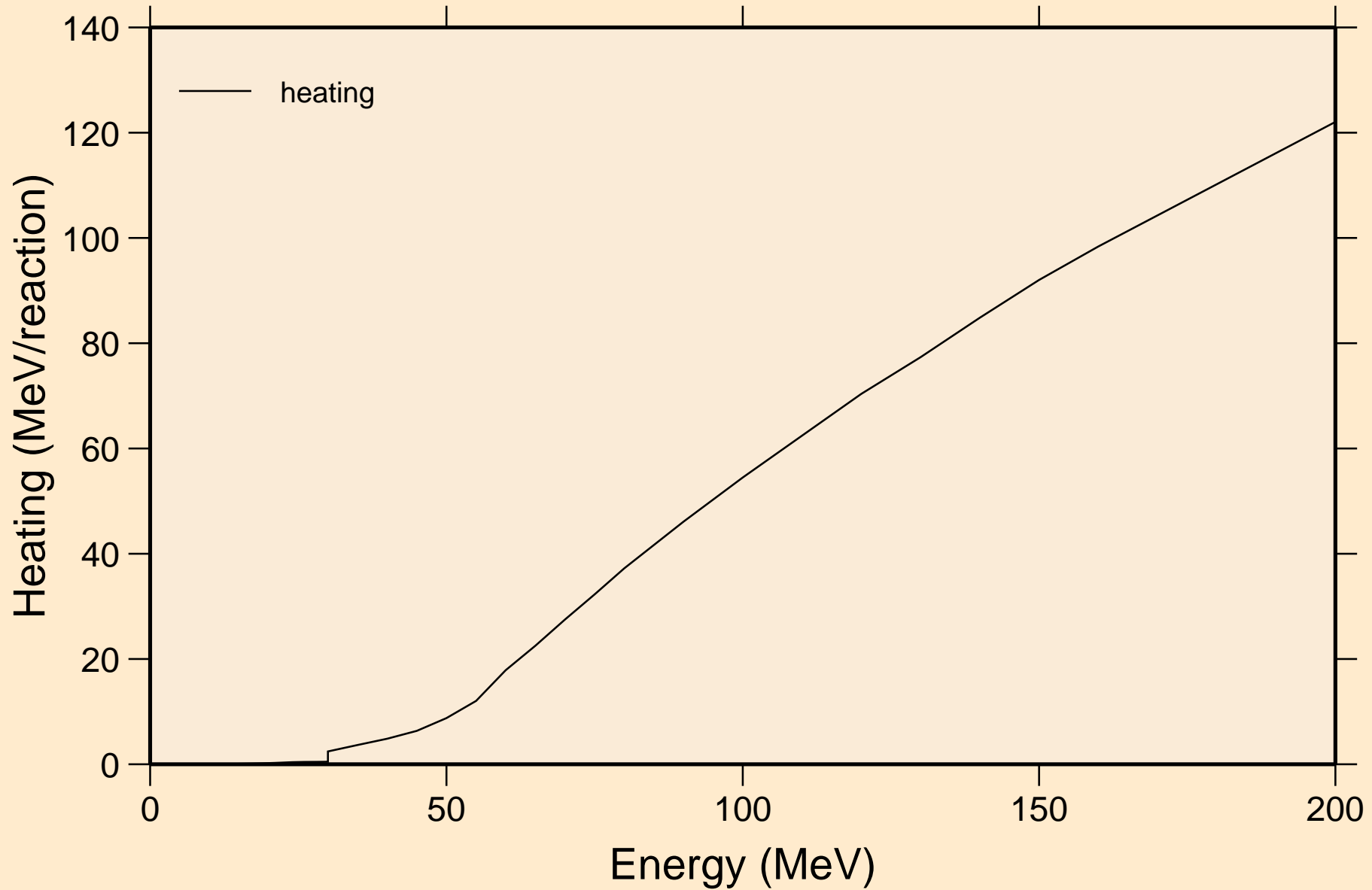

BA117 TRITON ACER TENDL-2021 LIBRARY; T=0.K  
Threshold reactions

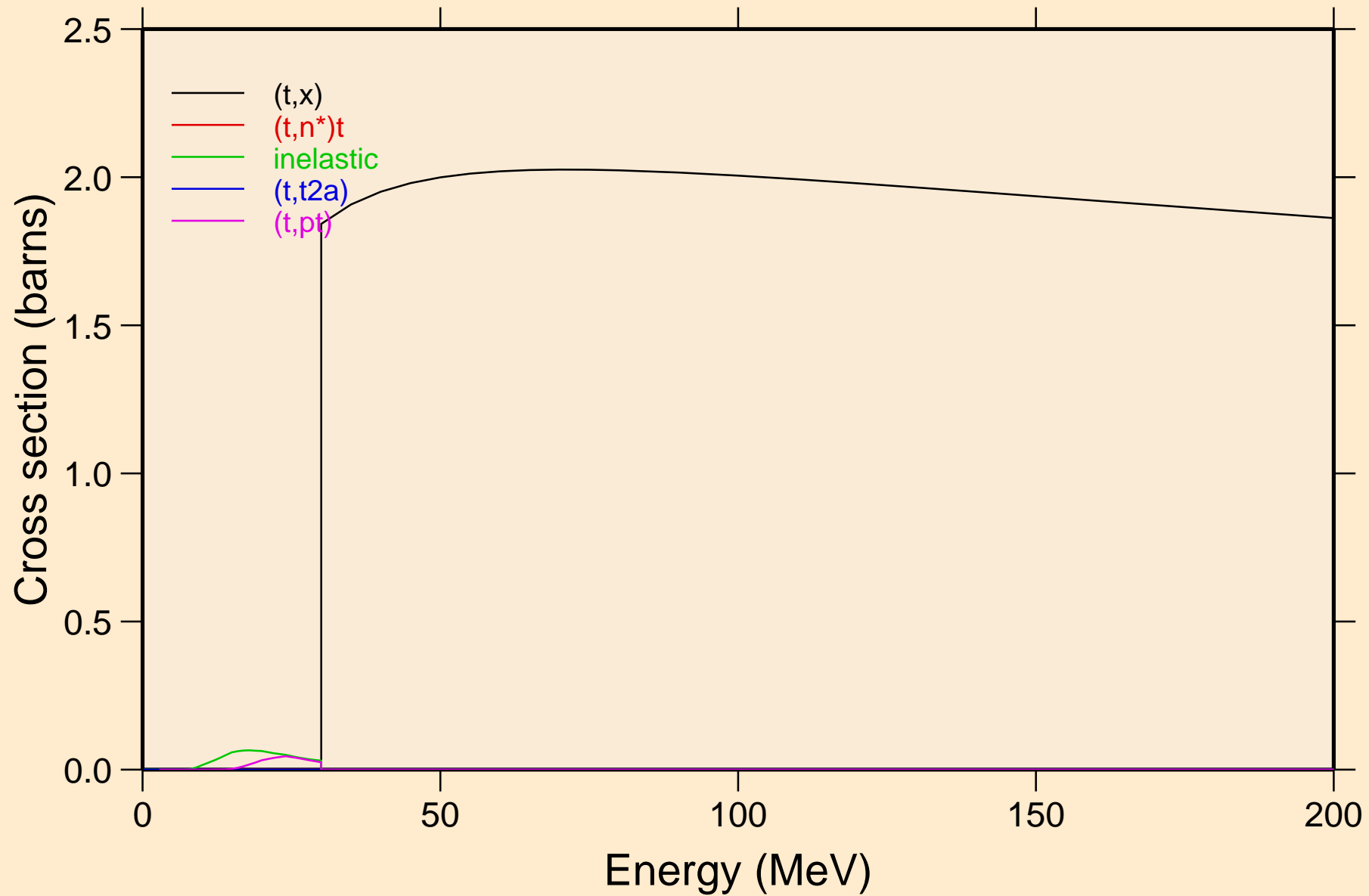

BA117 TRITON ACER TENDL-2021 LIBRARY; T=0.K  
Threshold reactions

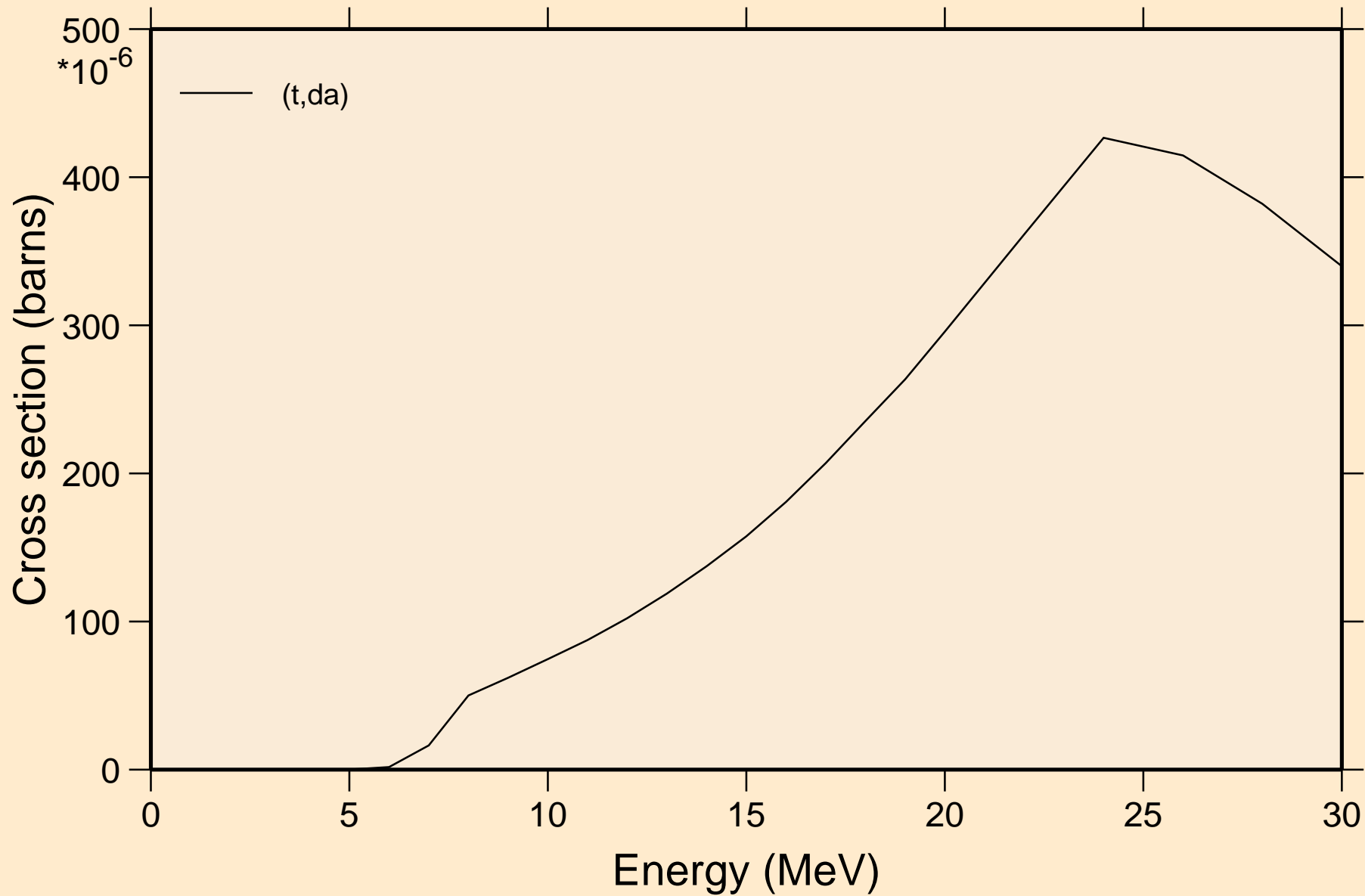

BA117 TRITON ACER TENDL-2021 LIBRARY; T=0.K  
angular distribution for elastic

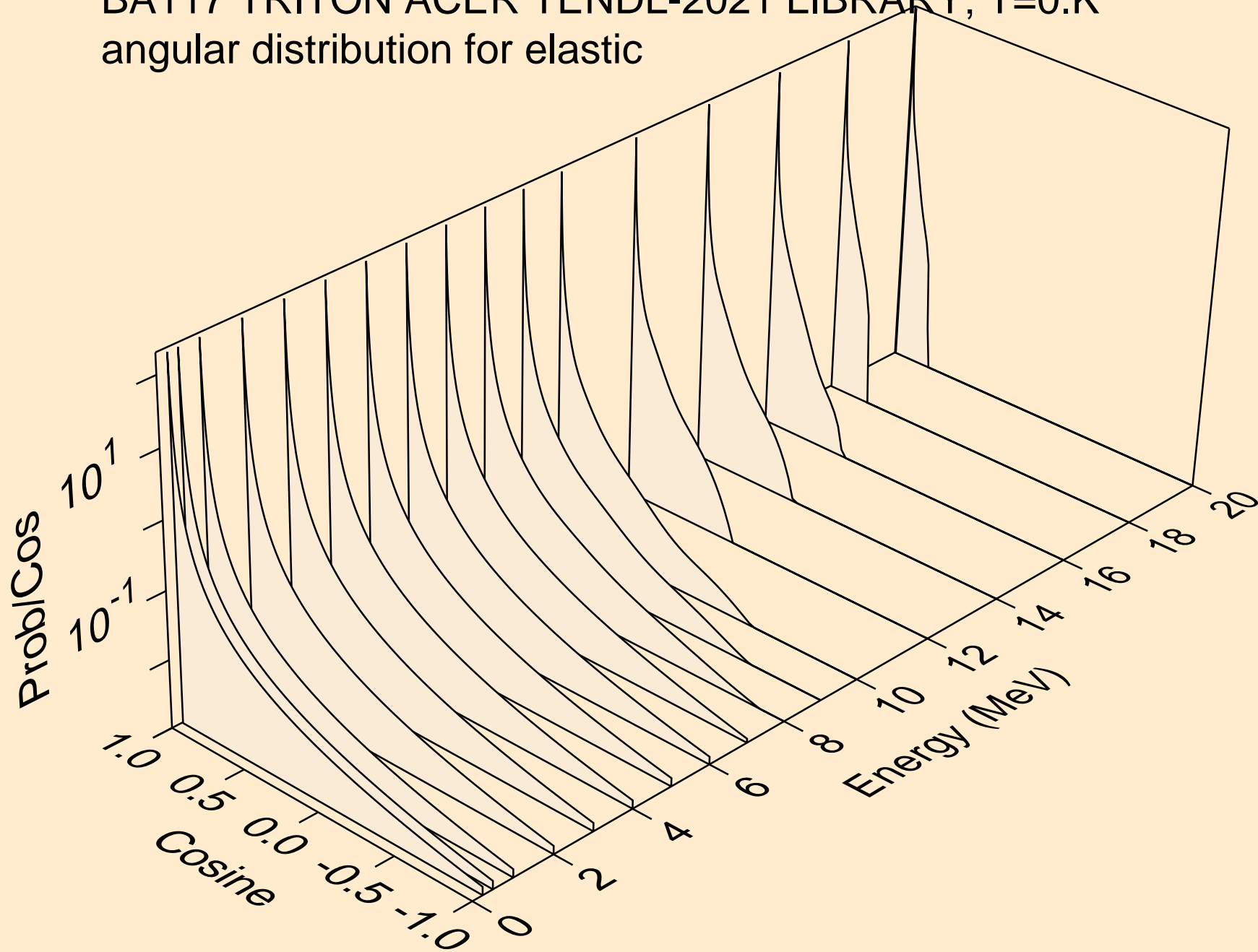

BA117 TRITON ACER TENDL-2021 LIBRARY; T=0.K  
angular distribution for elastic

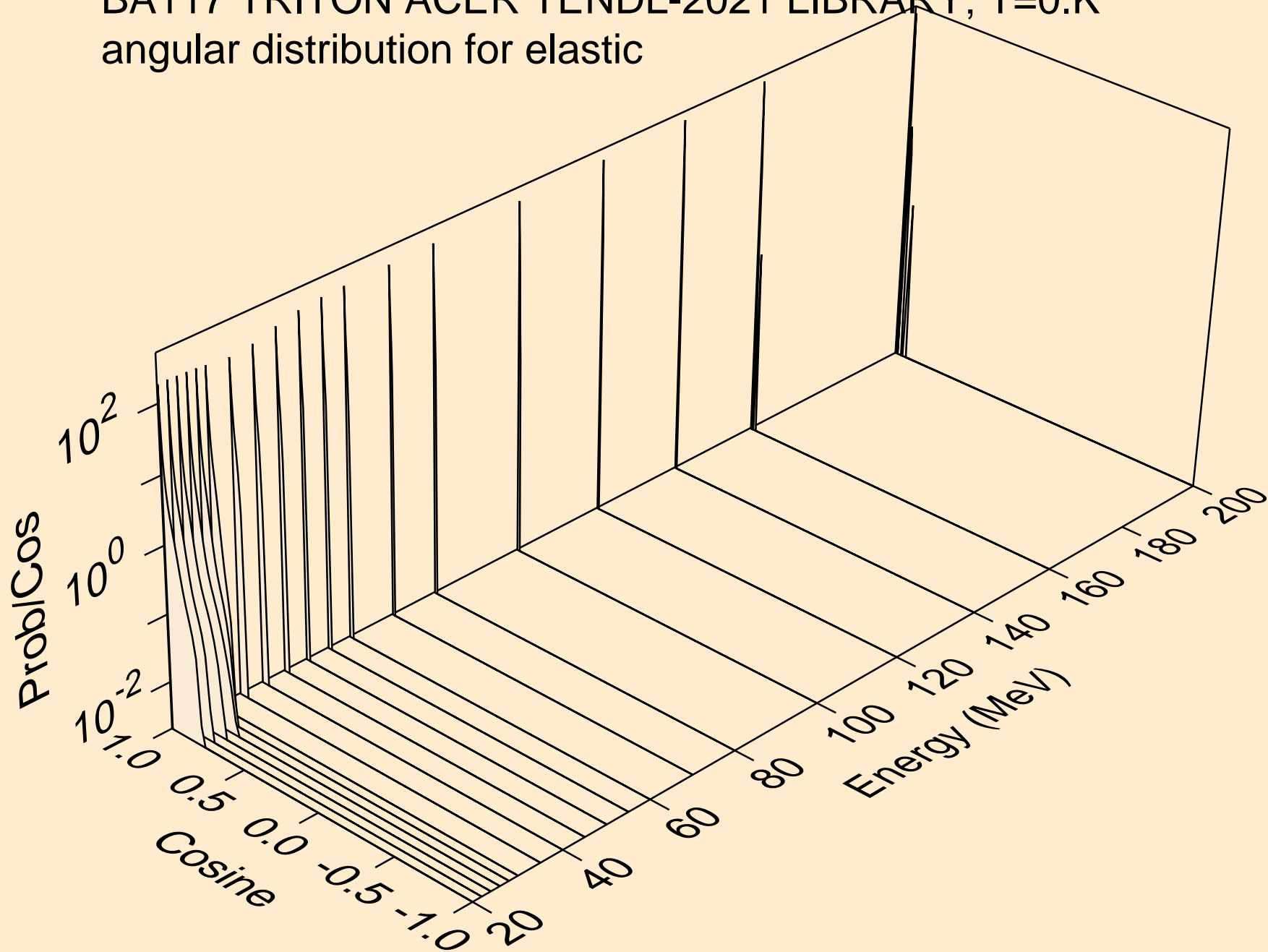



BA117 TRITON ACER TENDL-2021 LIBRARY; T=0.K  
Triton emission for (t,x)

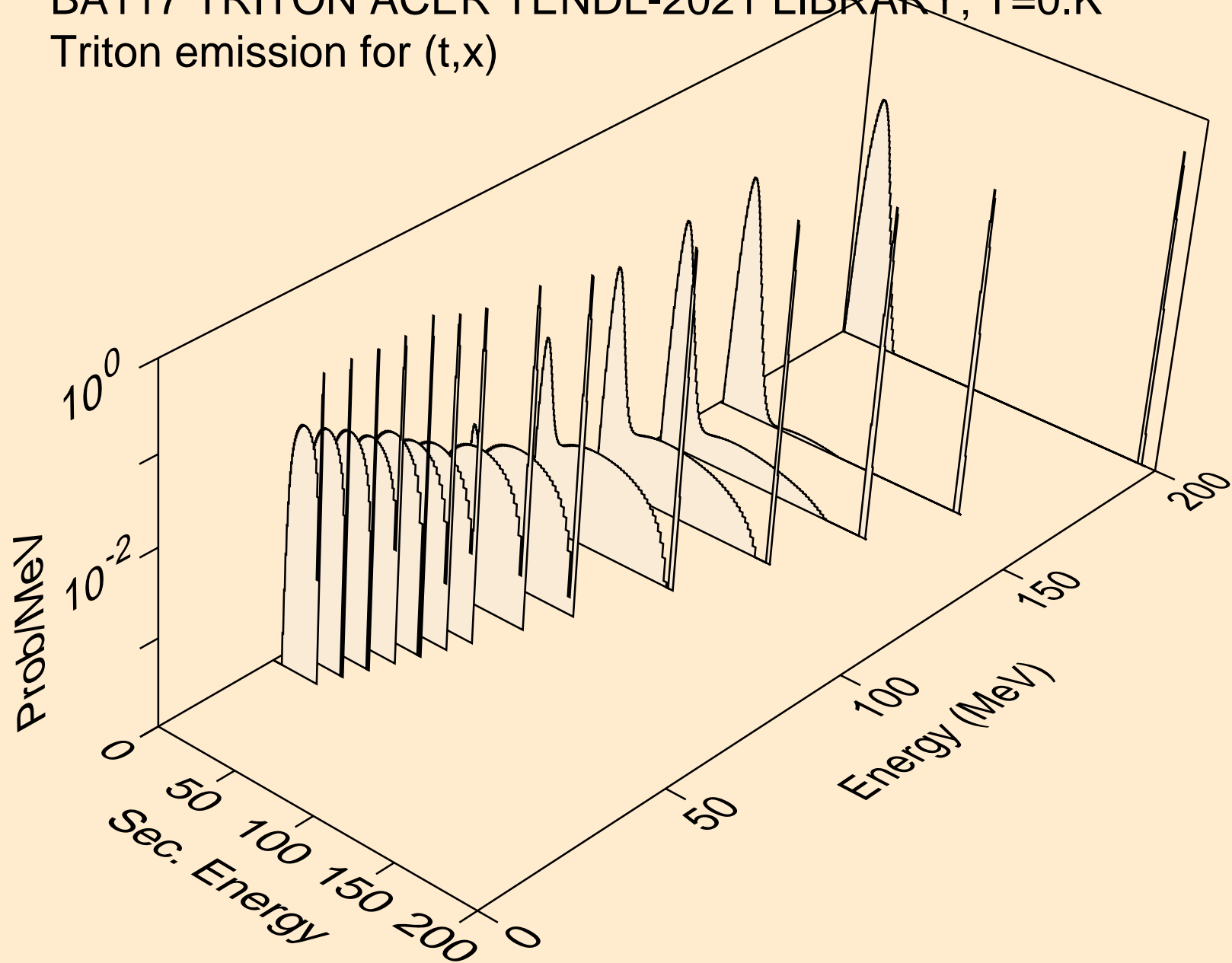

BA117 TRITON ACER TENDL-2021 LIBRARY; T=0.K  
Triton emission for (t,n\*)t

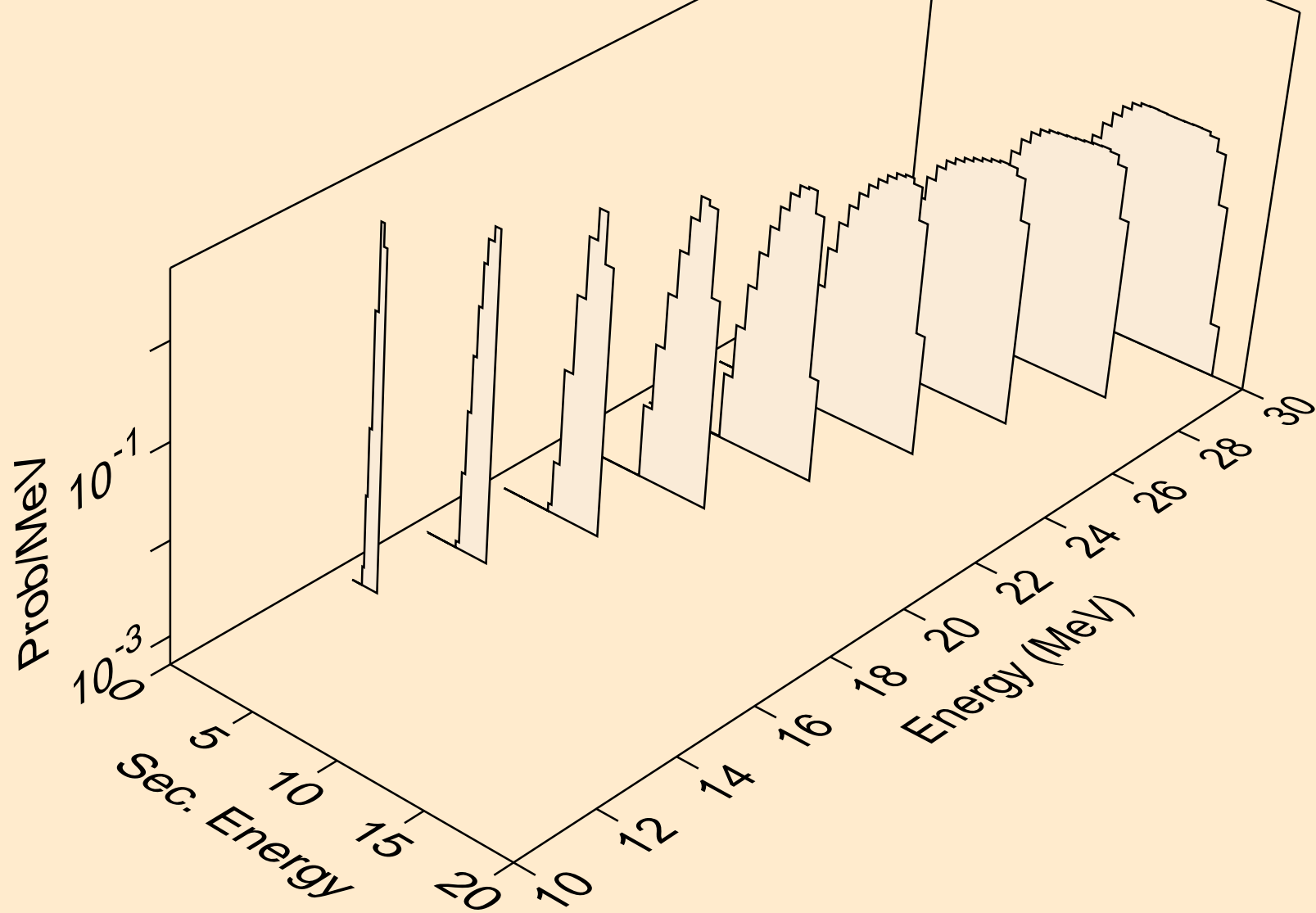

BA117 TRITON ACER TENDL-2021 LIBRARY; T=0.K  
Triton emission for inelastic

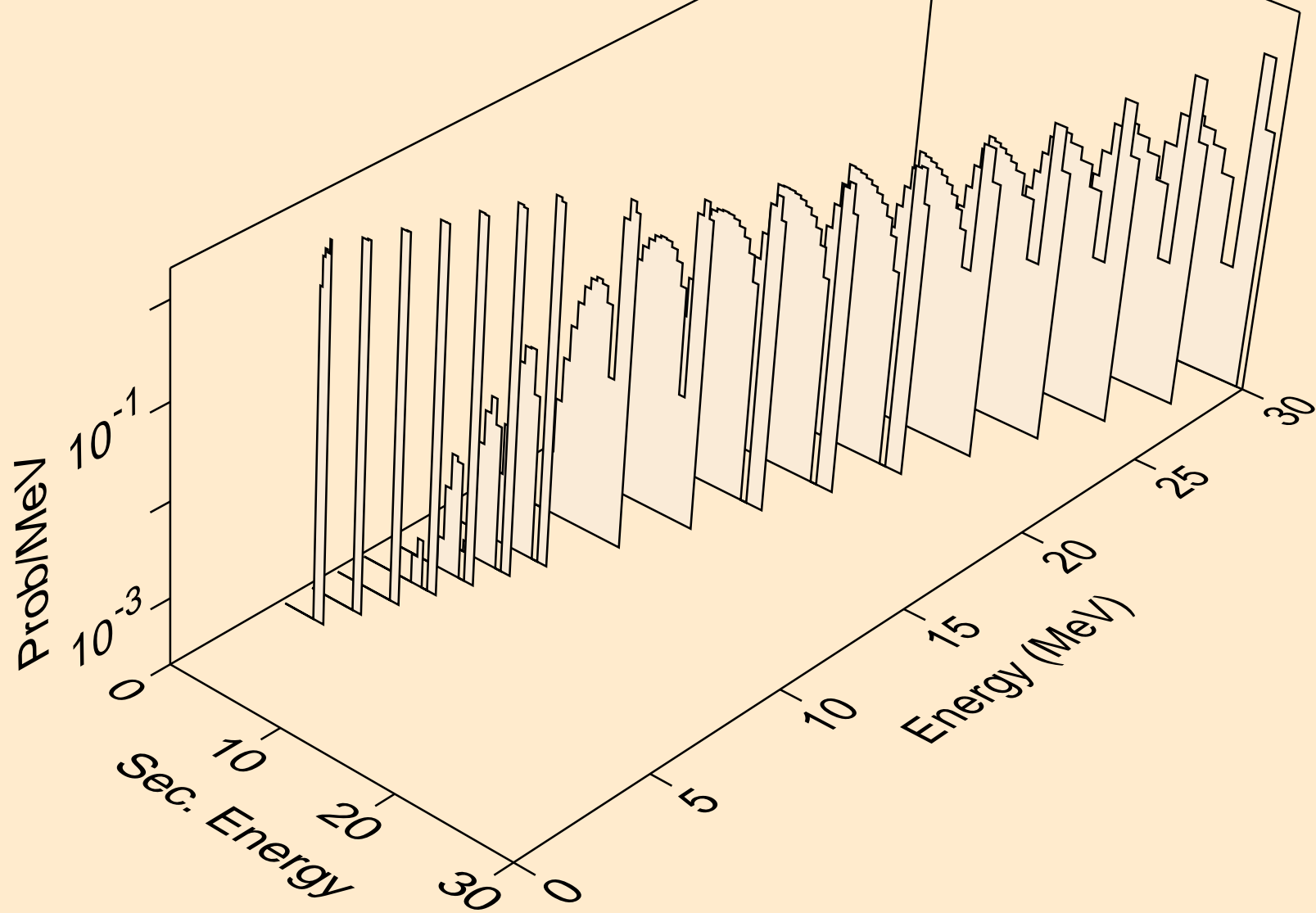

BA117 TRITON ACER TENDL-2021 LIBRARY; T=0.K  
Triton emission for (t,t2a)

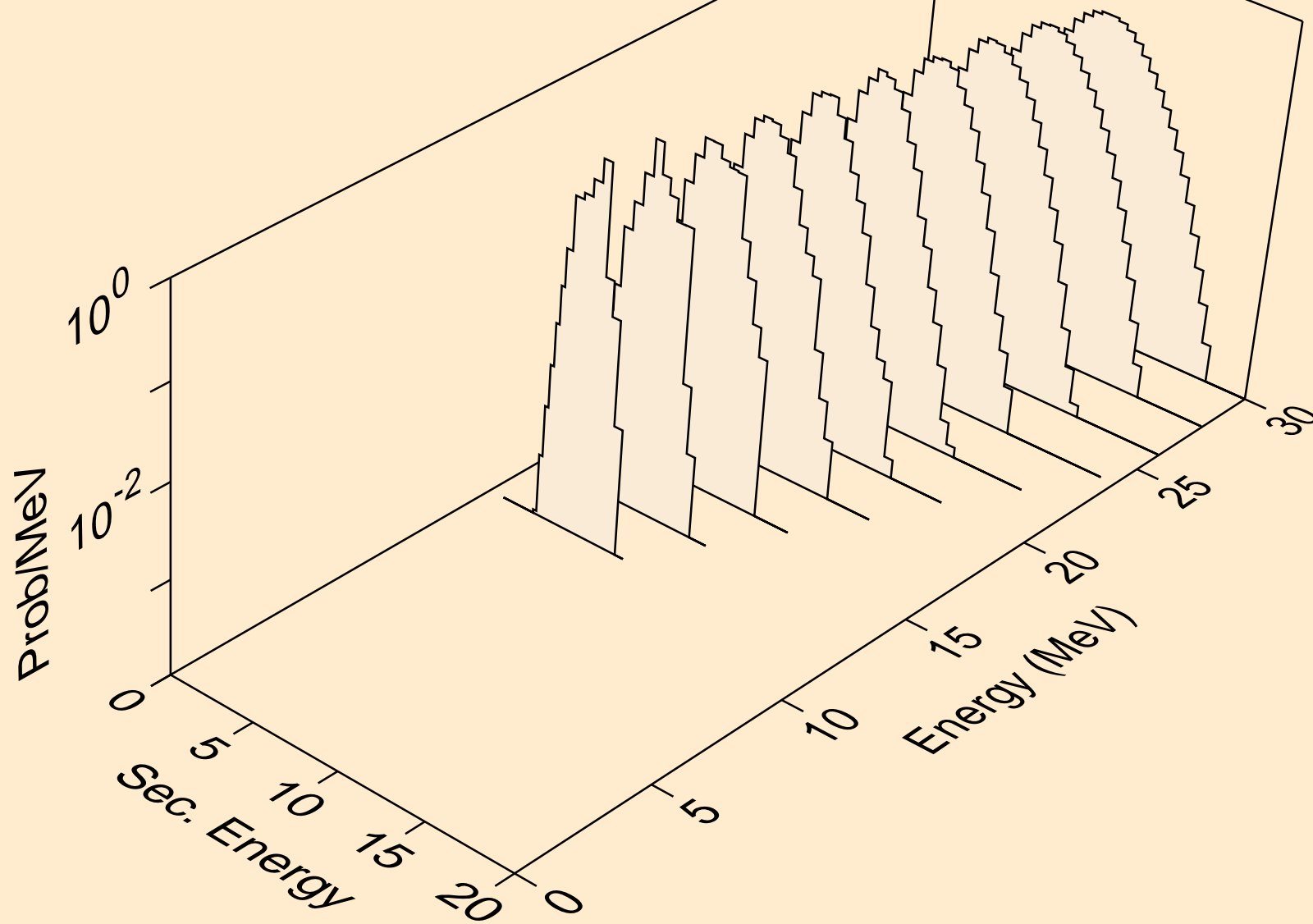

BA117 TRITON ACER TENDL-2021 LIBRARY; T=0.K  
Triton emission for (t,pt)

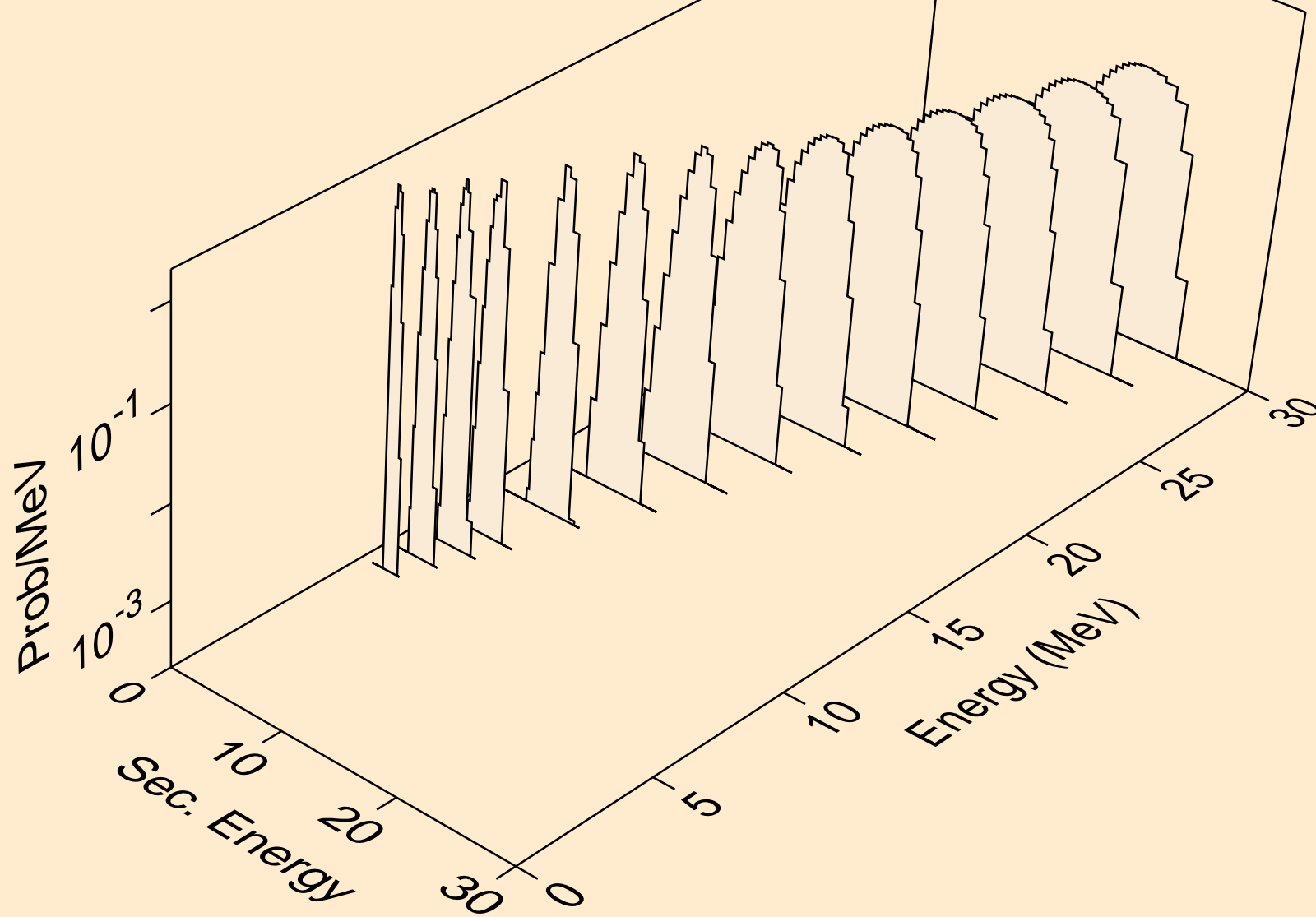

BA117 TRITON ACER TENDL-2021 LIBRARY; T=0.K  
Photon emission for (z,n)

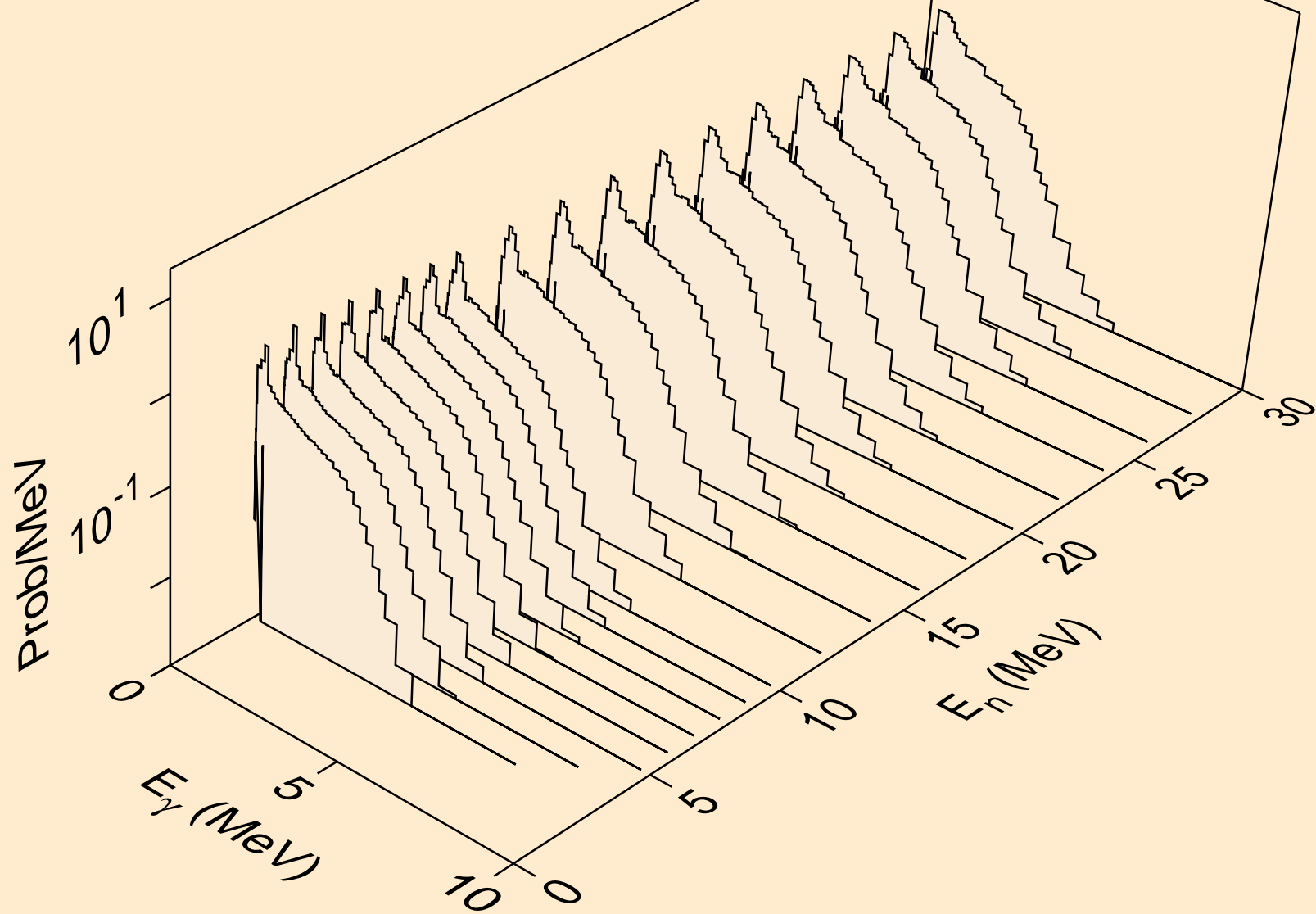

BA117 TRITON ACER TENDL-2021 LIBRARY; T=0.K  
Photon emission for (n,x)

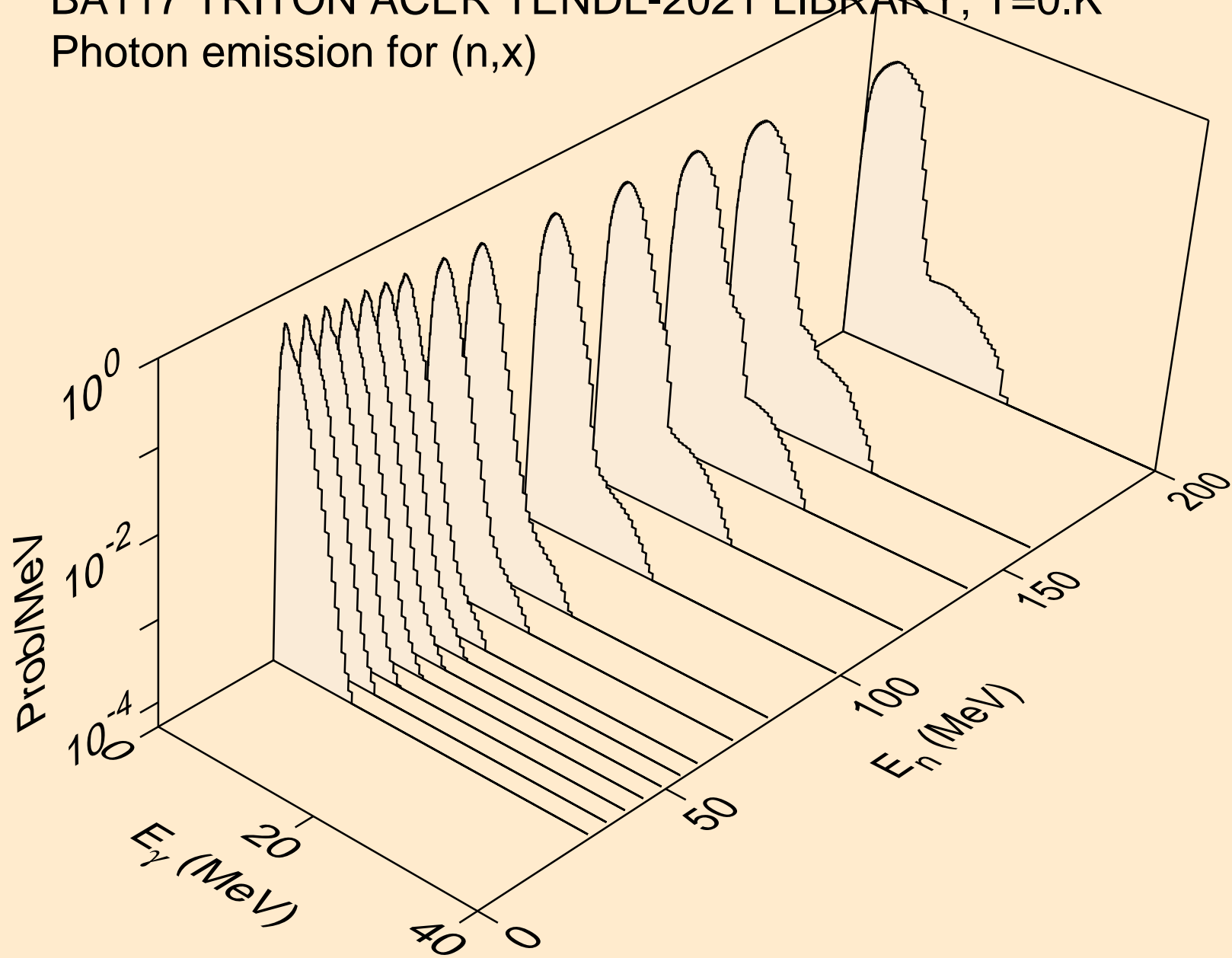

BA117 TRITON ACER TENDL-2021 LIBRARY; T=0.K  
Photon emission for (n,2nd)

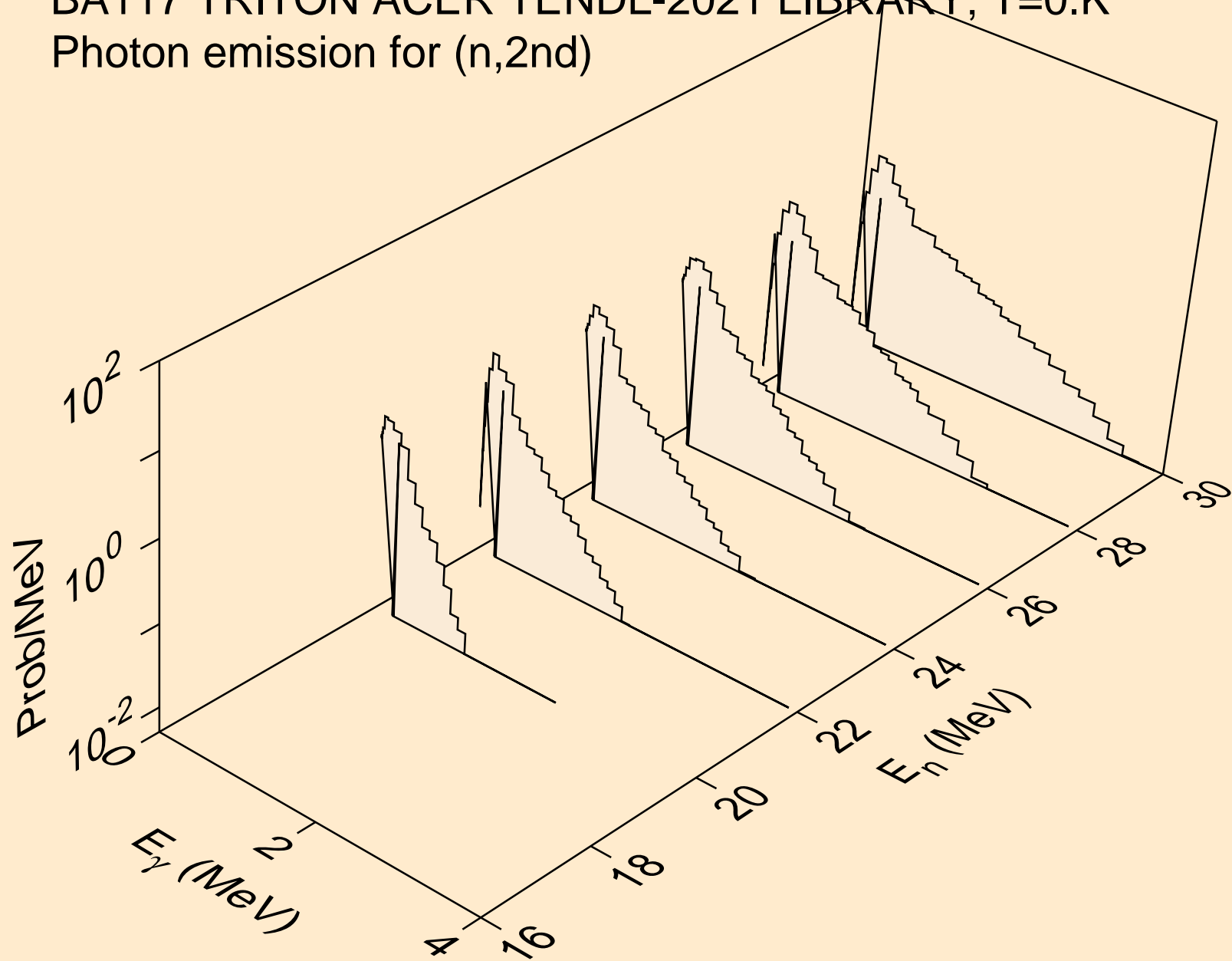



BA117 TRITON ACER TENDL-2021 LIBRARY; T=0.K  
Photon emission for (n,2n)

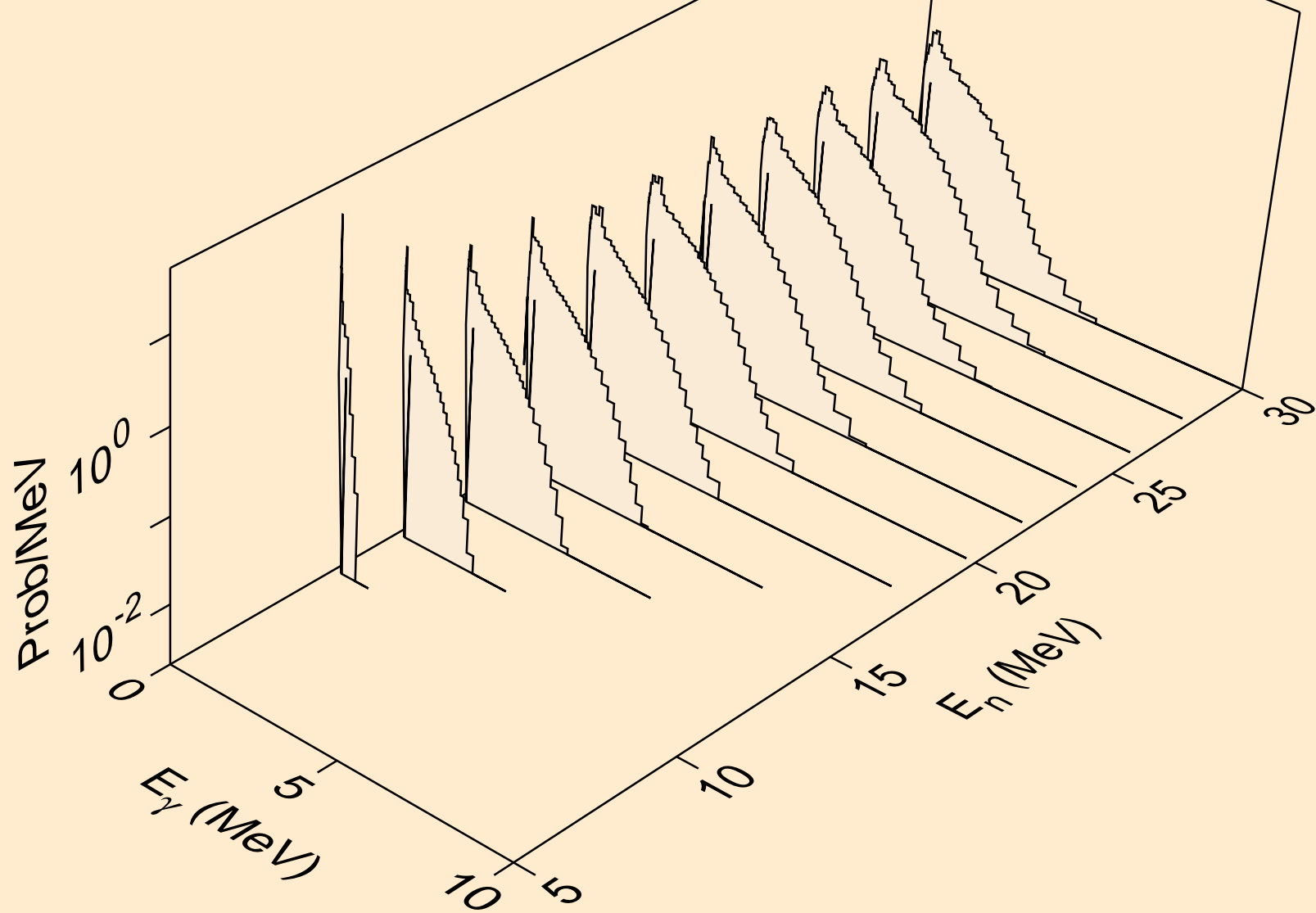

BA117 TRITON ACER TENDL-2021 LIBRARY; T=0.K  
Photon emission for (n,3n)

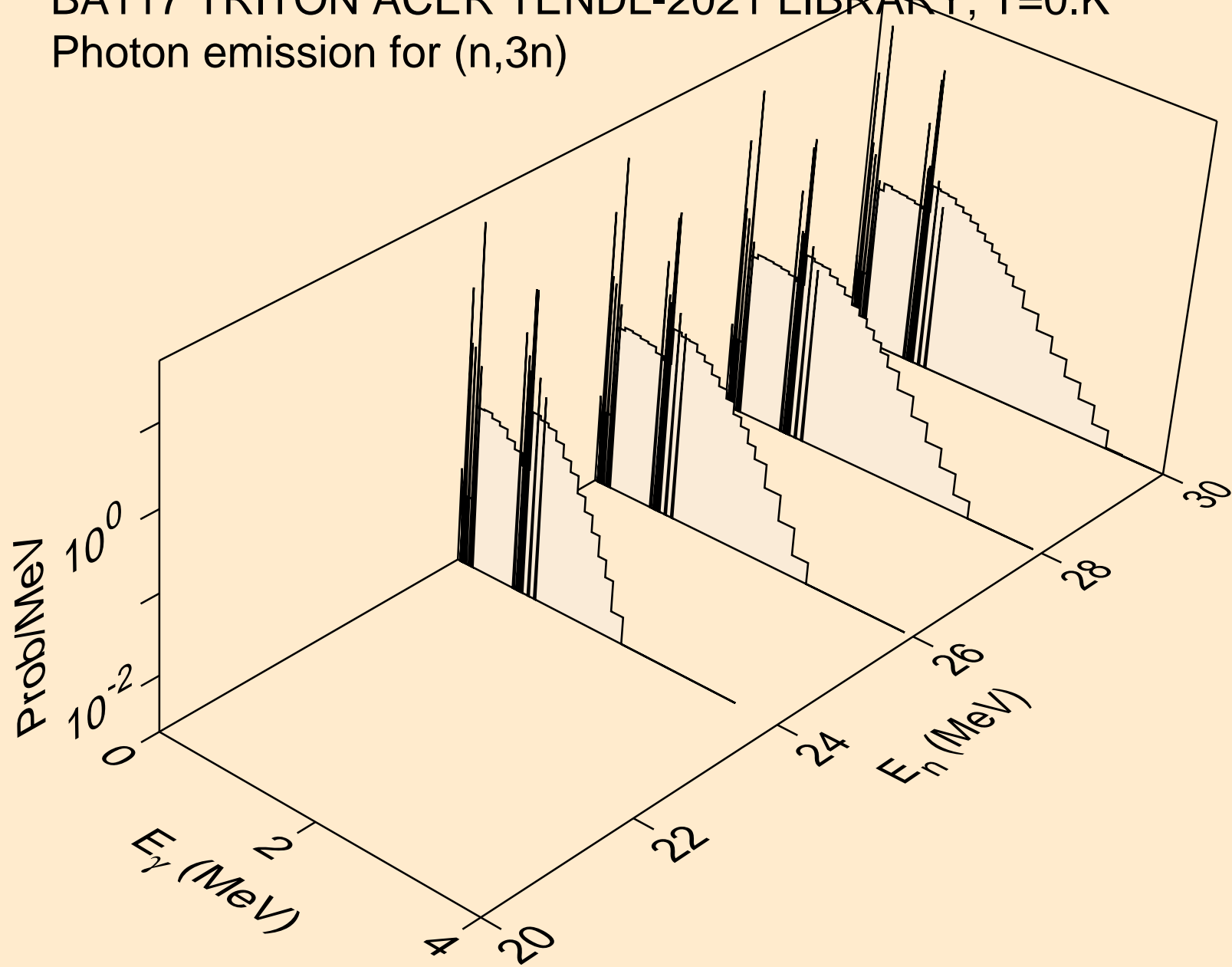

BA117 TRITON ACER TENDL-2021 LIBRARY; T=0.K  
Photon emission for (n,n\*)a

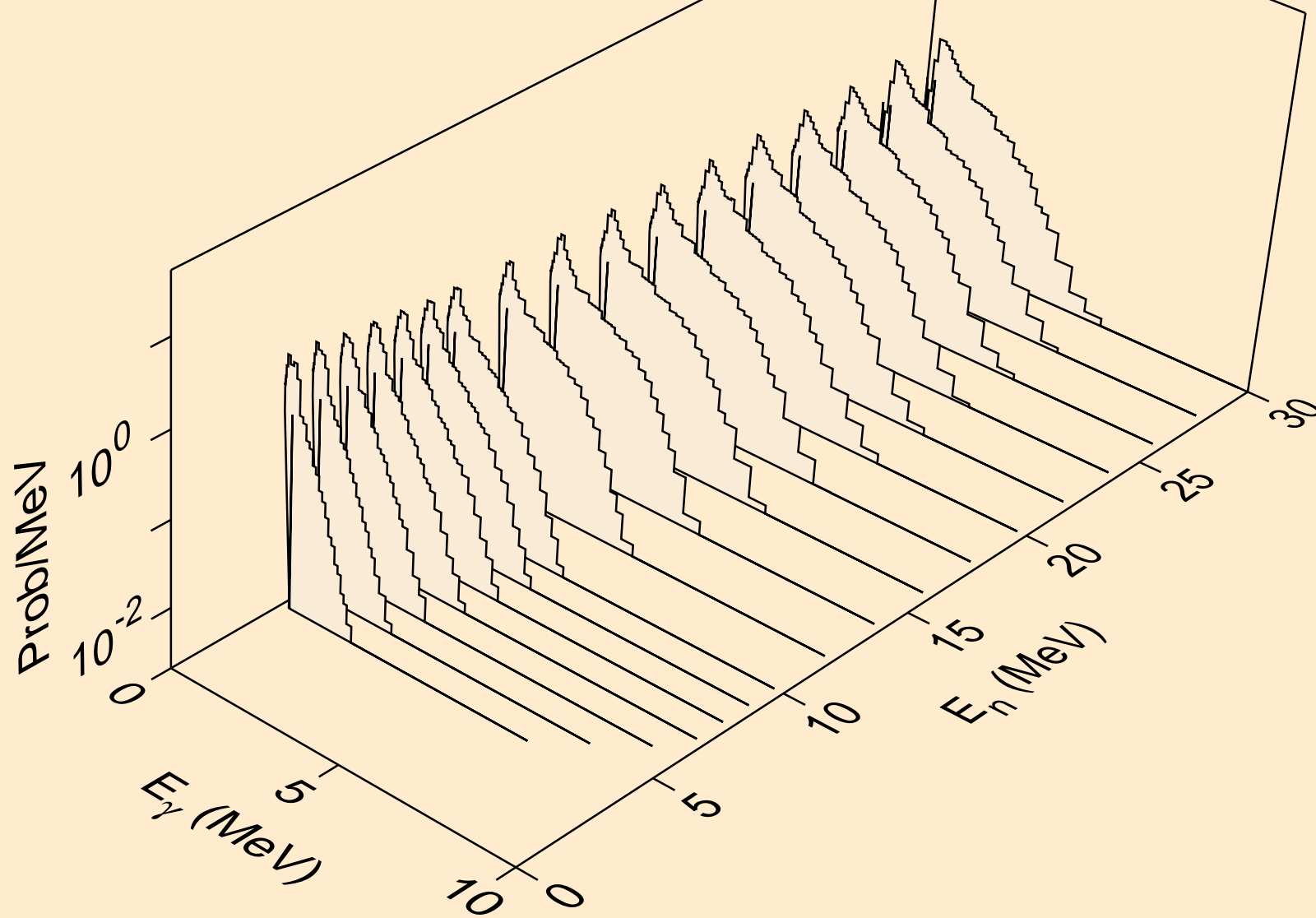

BA117 TRITON ACER TENDL-2021 LIBRARY; T=0.K  
Photon emission for (n,n\*)3a

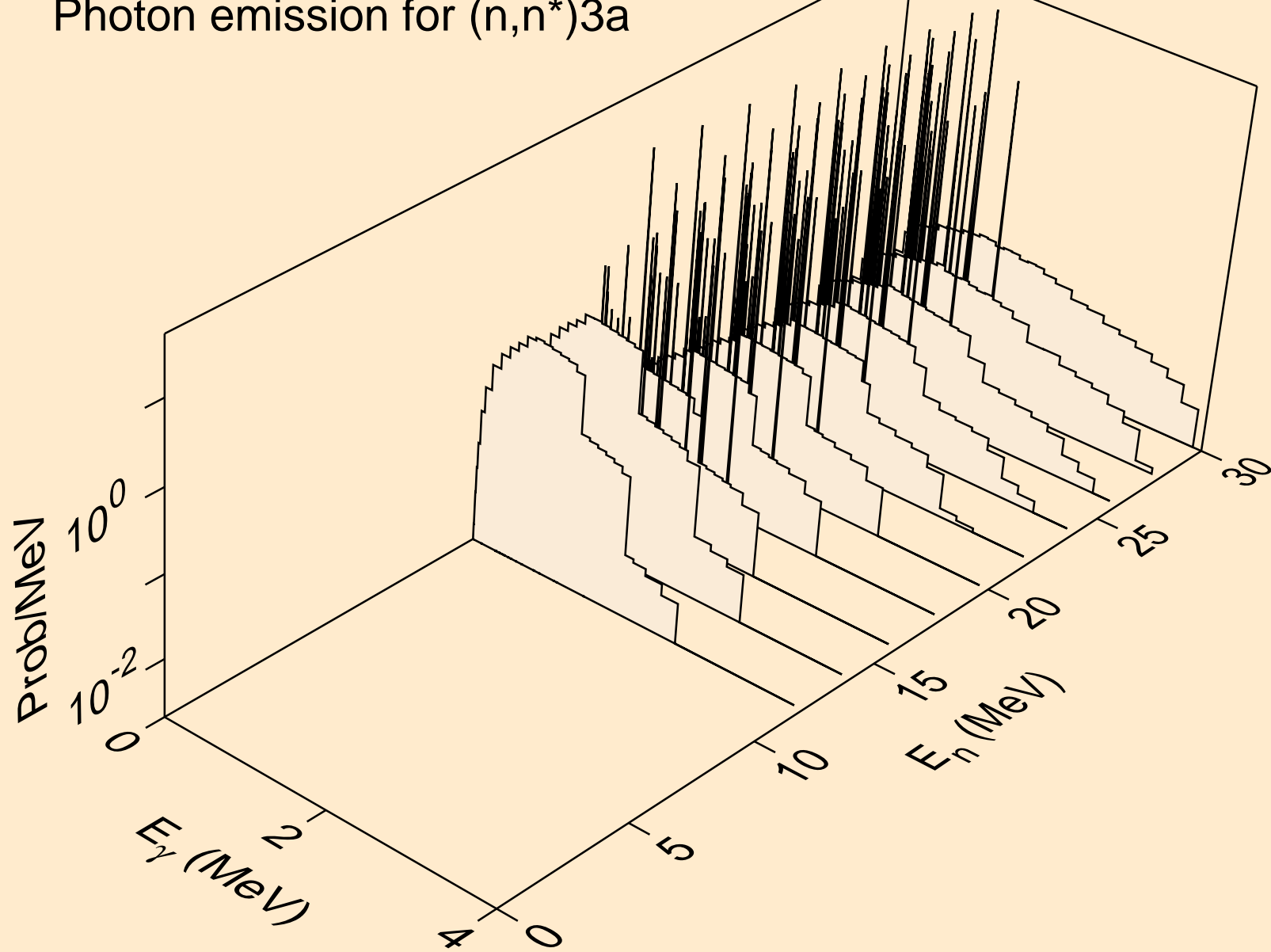

BA117 TRITON ACER TENDL-2021 LIBRARY; T=0.K  
Photon emission for (n,2n)a

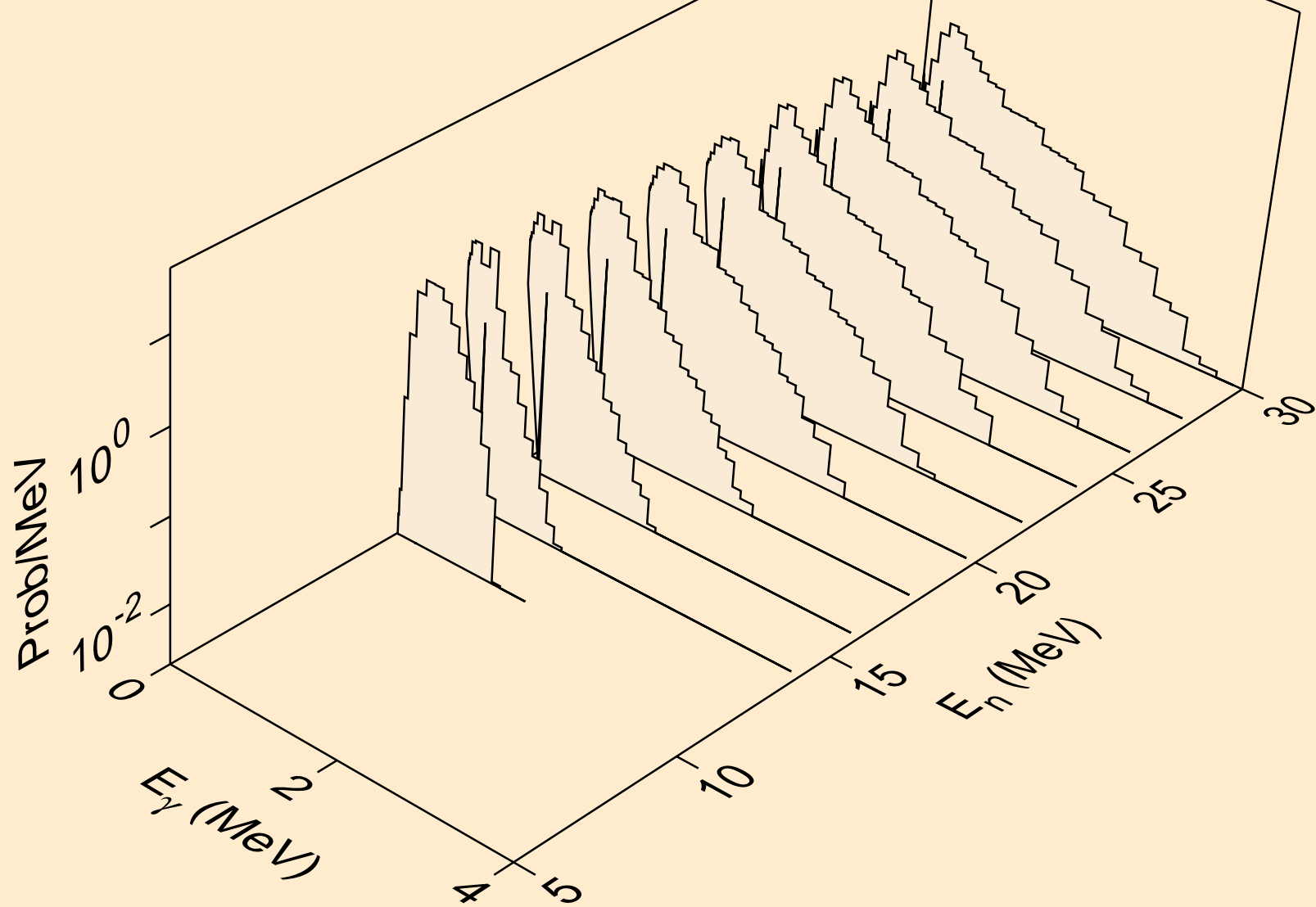

BA117 TRITON ACER TENDL-2021 LIBRARY; T=0.K  
Photon emission for (n,n\*)p

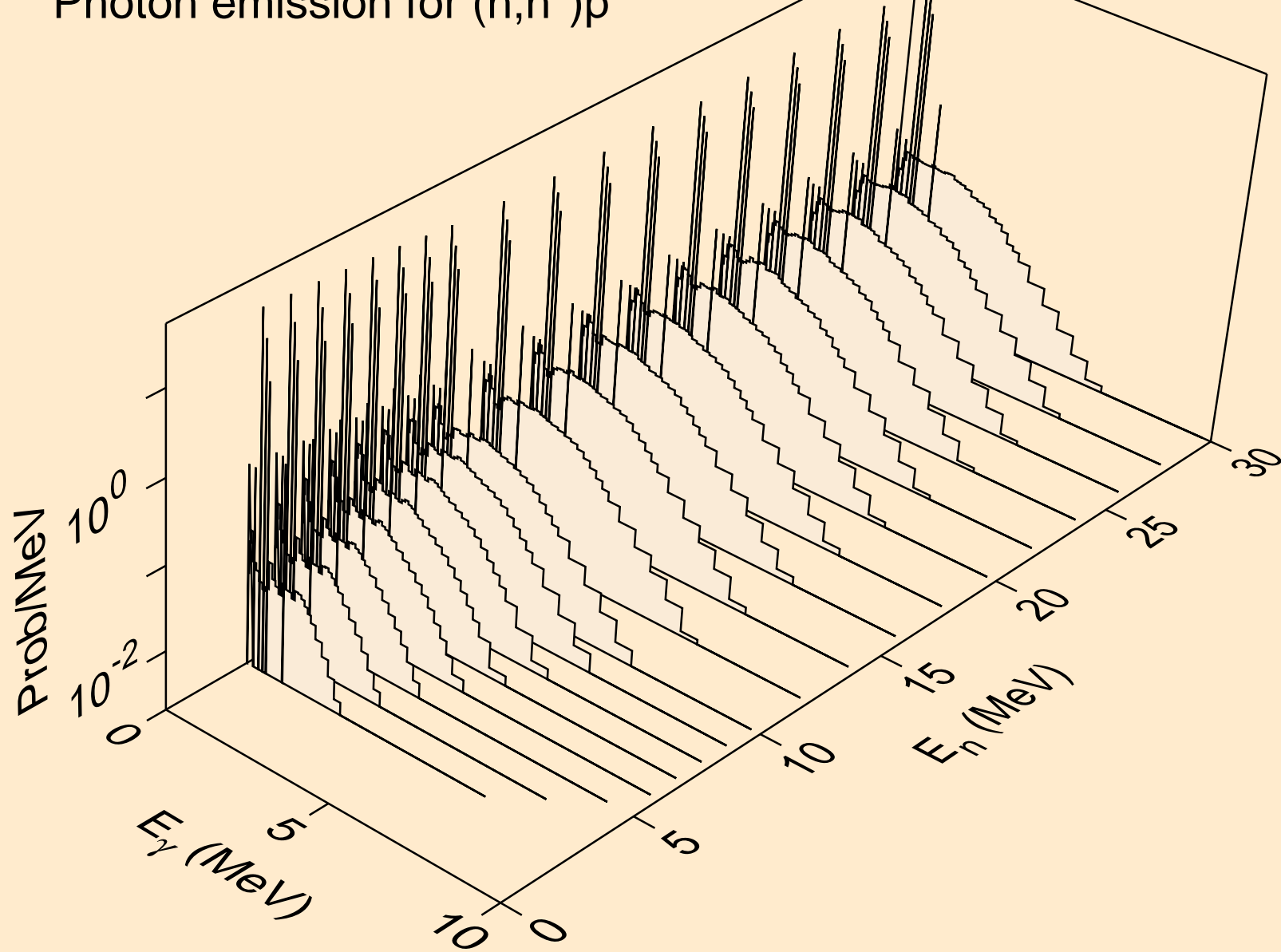

BA117 TRITON ACER TENDL-2021 LIBRARY; T=0.K  
Photon emission for (n,n\*)2a

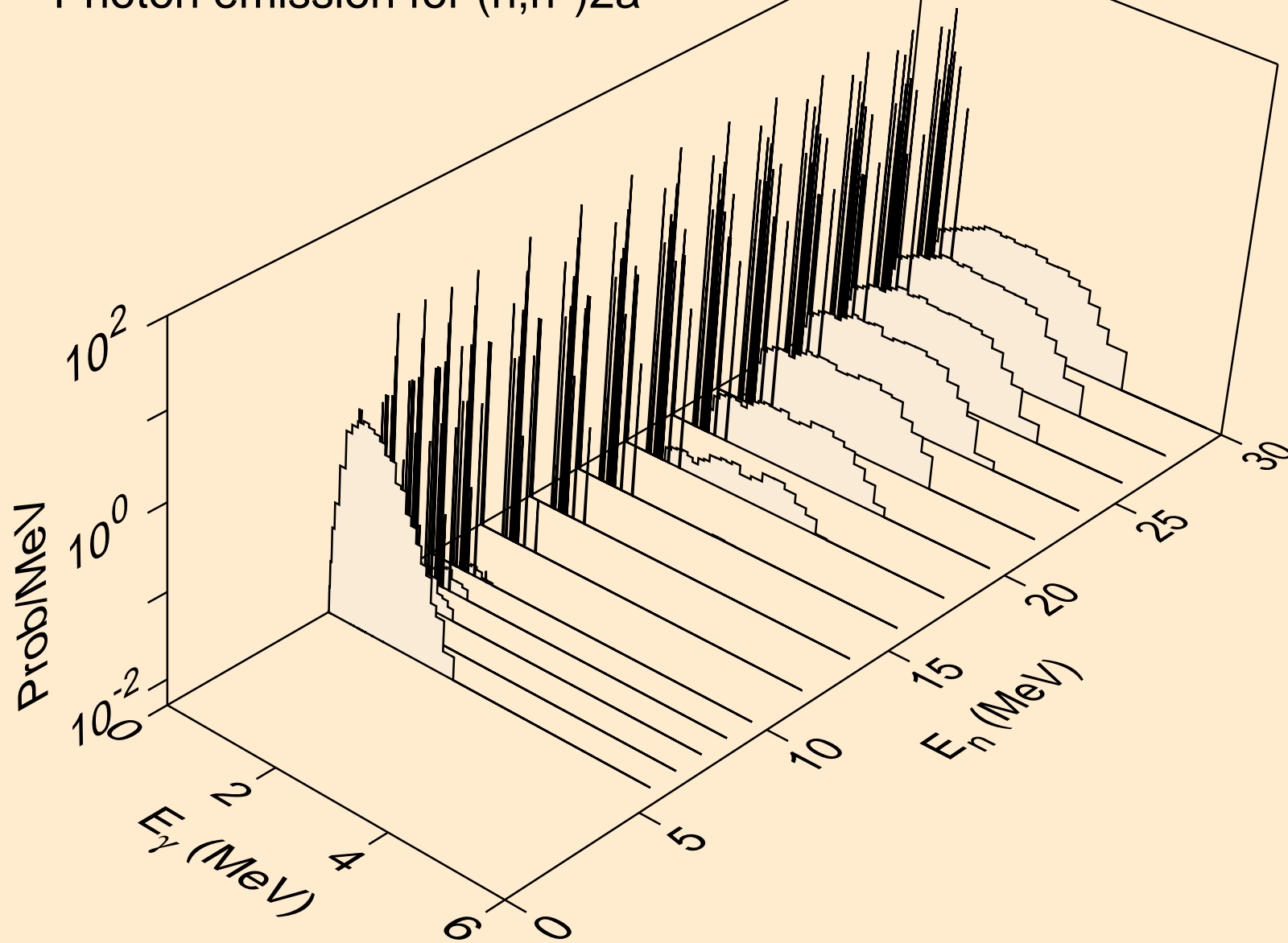

BA117 TRITON ACER TENDL-2021 LIBRARY; T=0.K  
Photon emission for (n,n\*)d

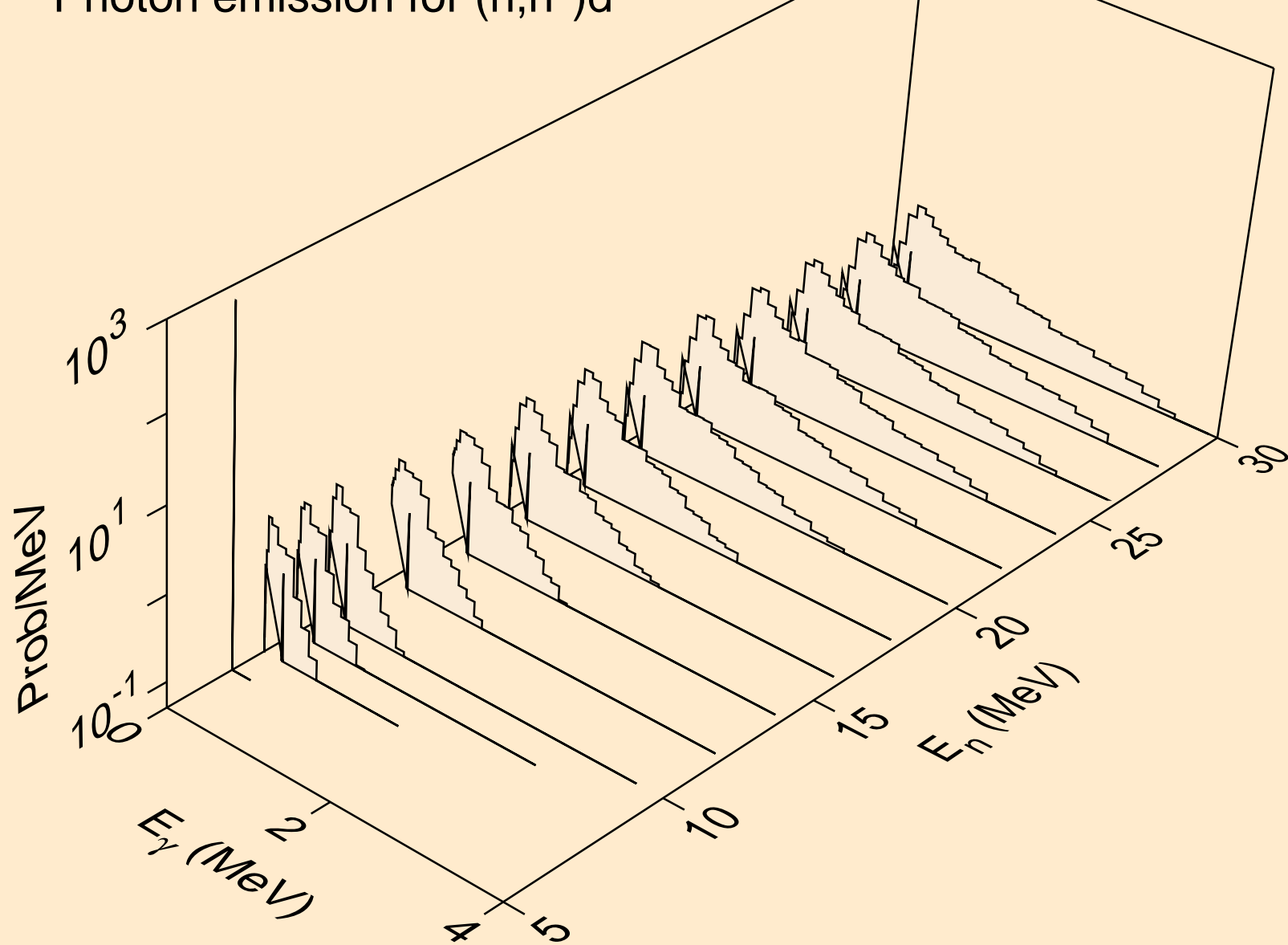



BA117 TRITON ACER TENDL-2021 LIBRARY; T=0.K  
Photon emission for (n,n\*)t

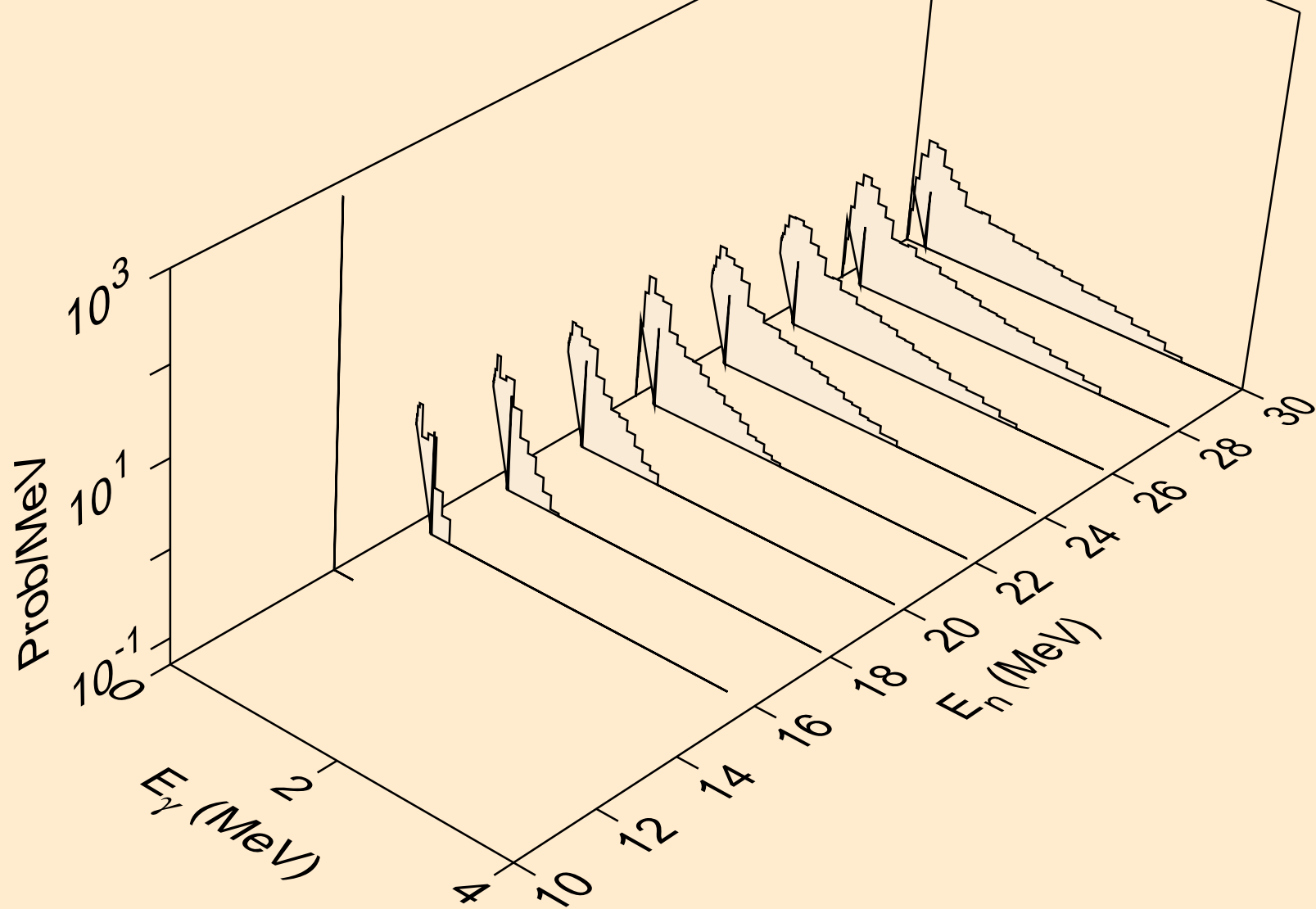

BA117 TRITON ACER TENDL-2021 LIBRARY; T=0.K  
Photon emission for (n,n\*)he3

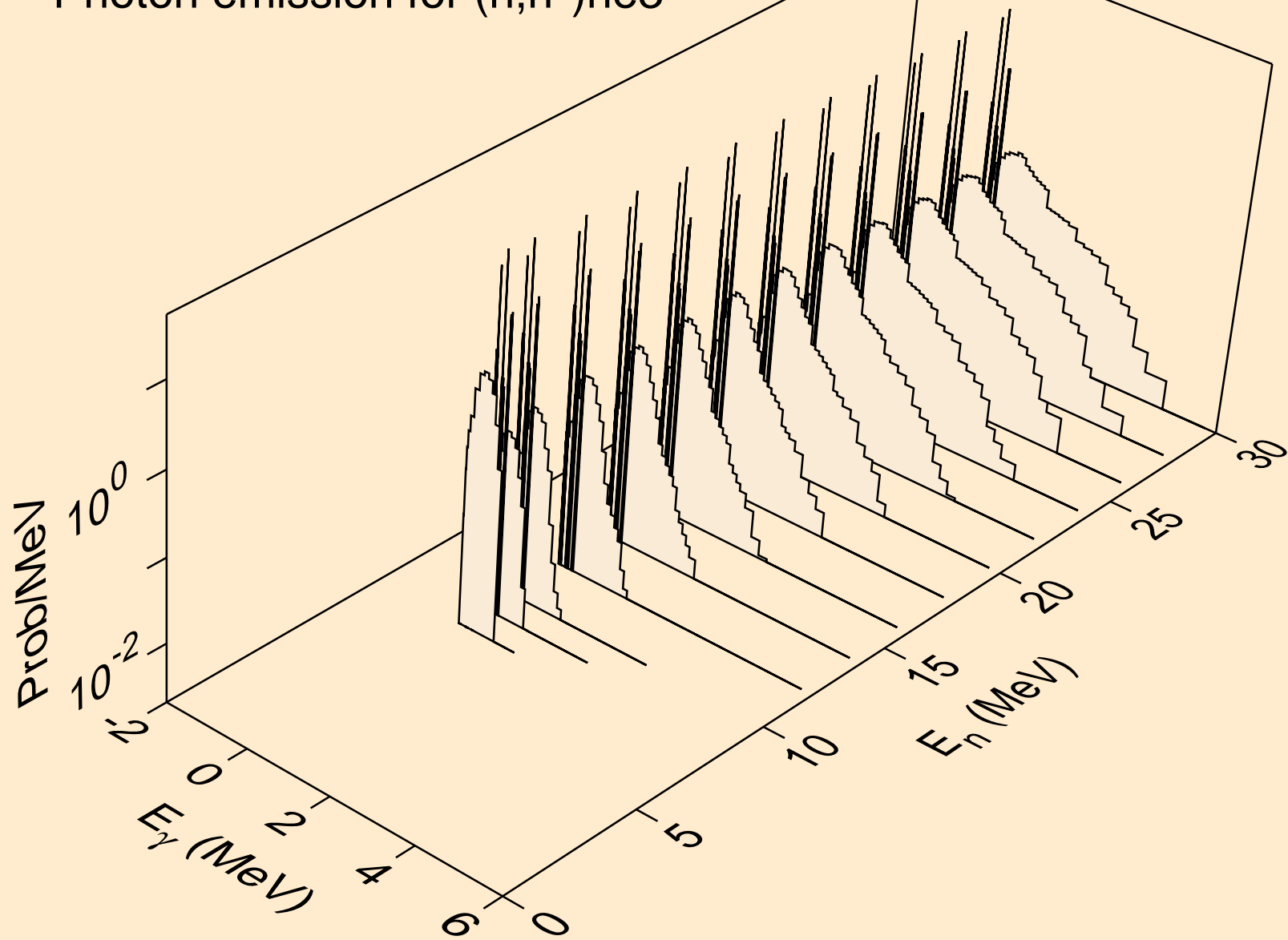

BA117 TRITON ACER TENDL-2021 LIBRARY; T=0.K  
Photon emission for (n,2np)

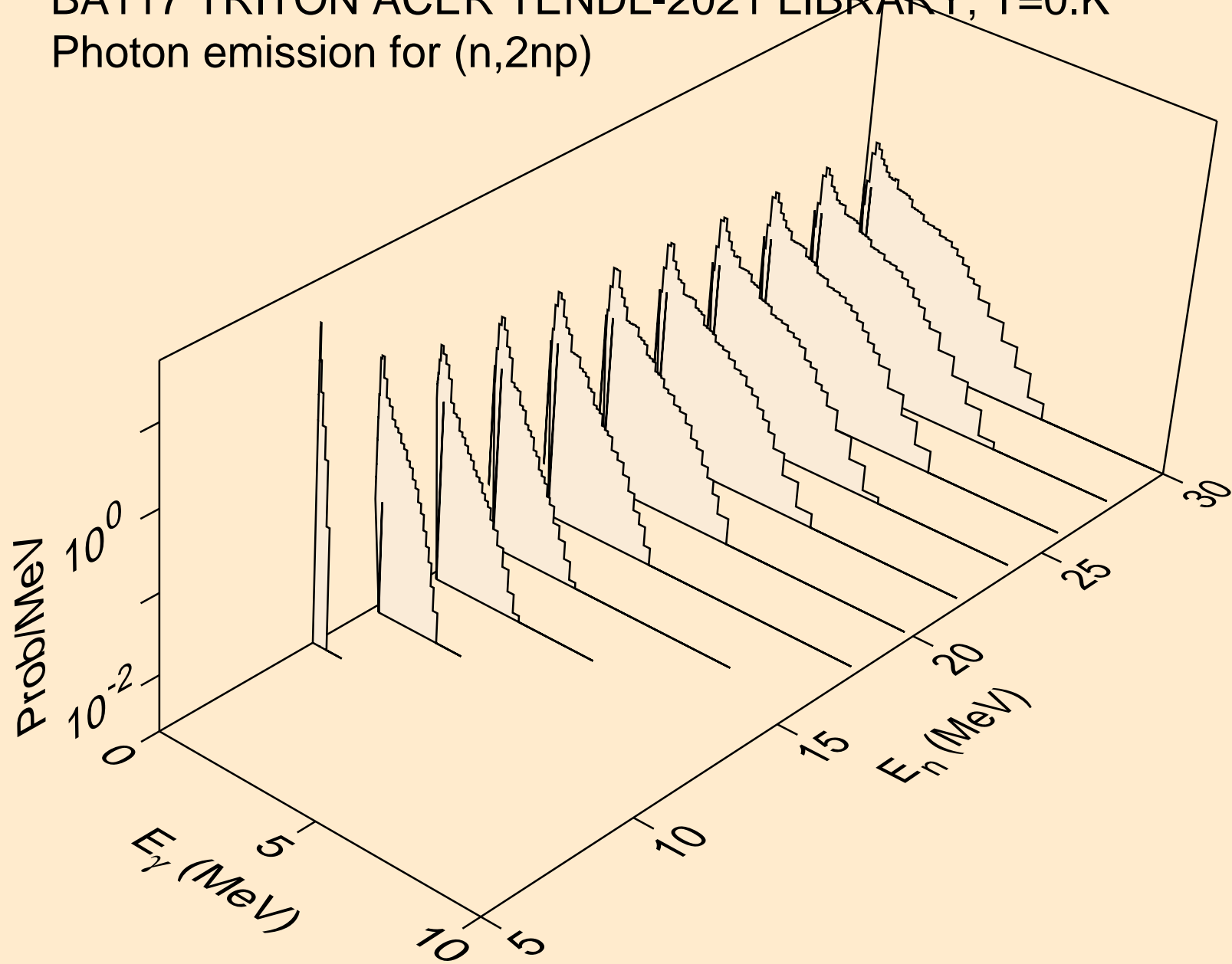

BA117 TRITON ACER TENDL-2021 LIBRARY; T=0.K  
Photon emission for (n,3np)

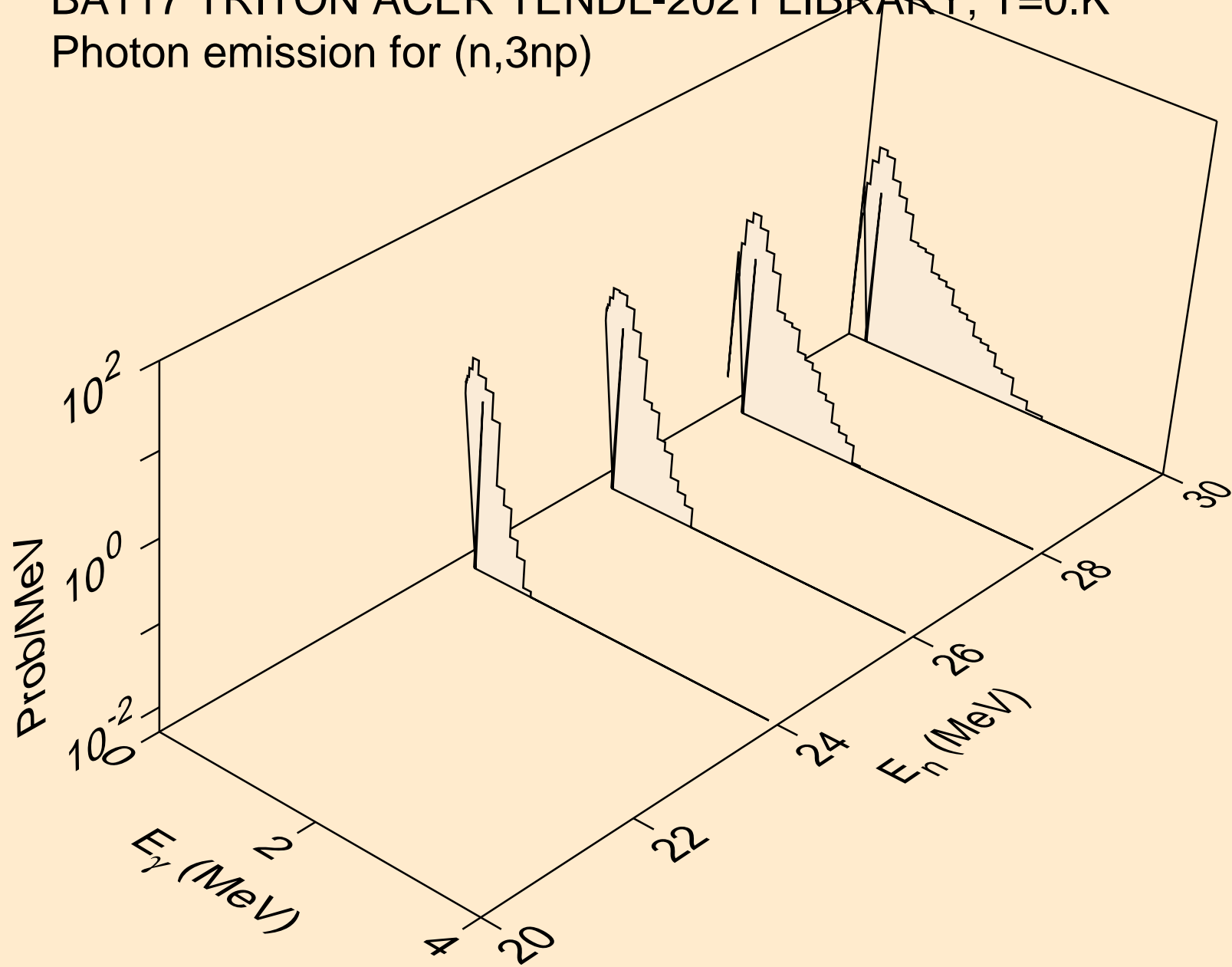

BA117 TRITON ACER TENDL-2021 LIBRARY; T=0.K  
Photon emission for (n,2np)

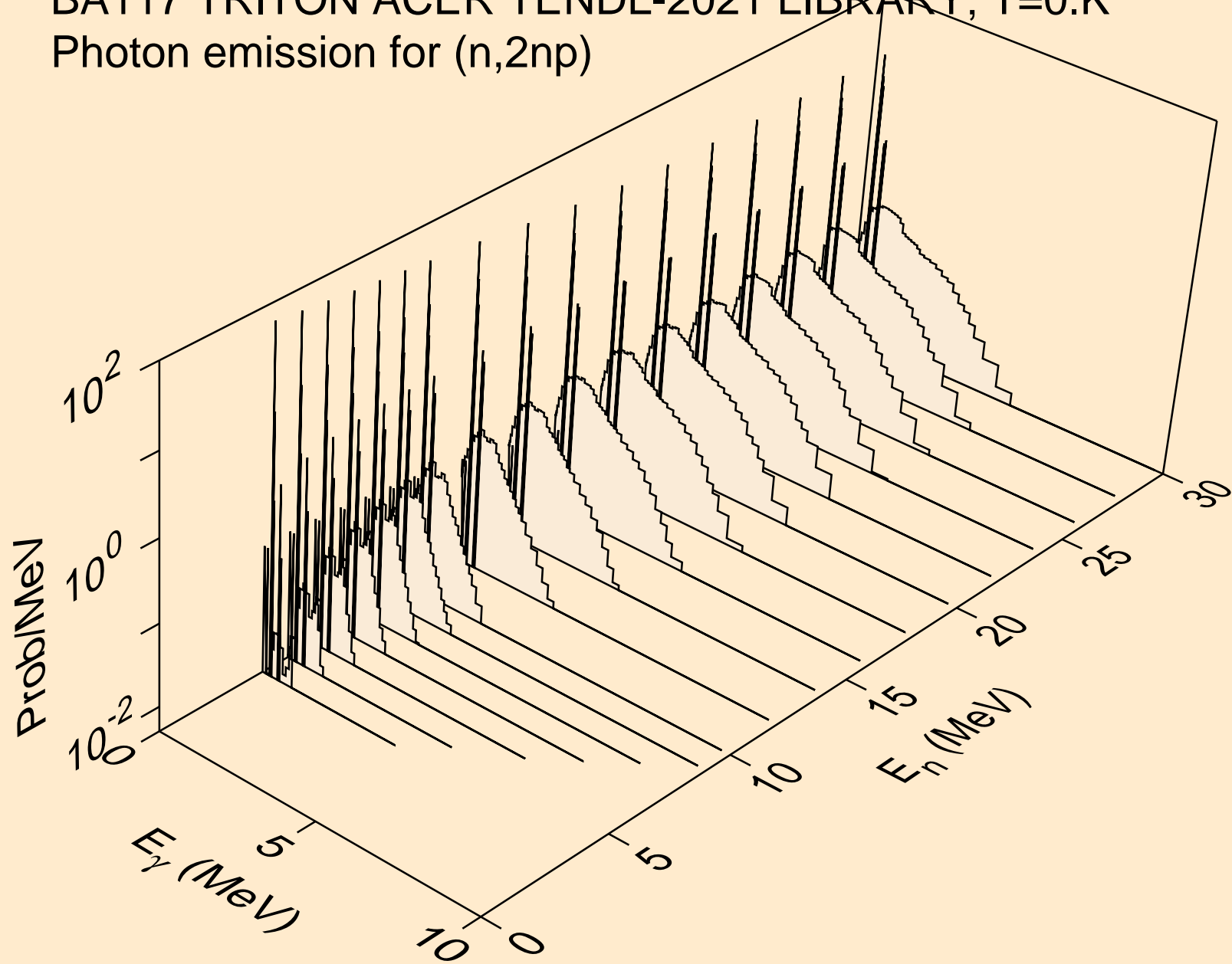

BA117 TRITON ACER TENDL-2021 LIBRARY; T=0.K  
Photon emission for (n,npa)

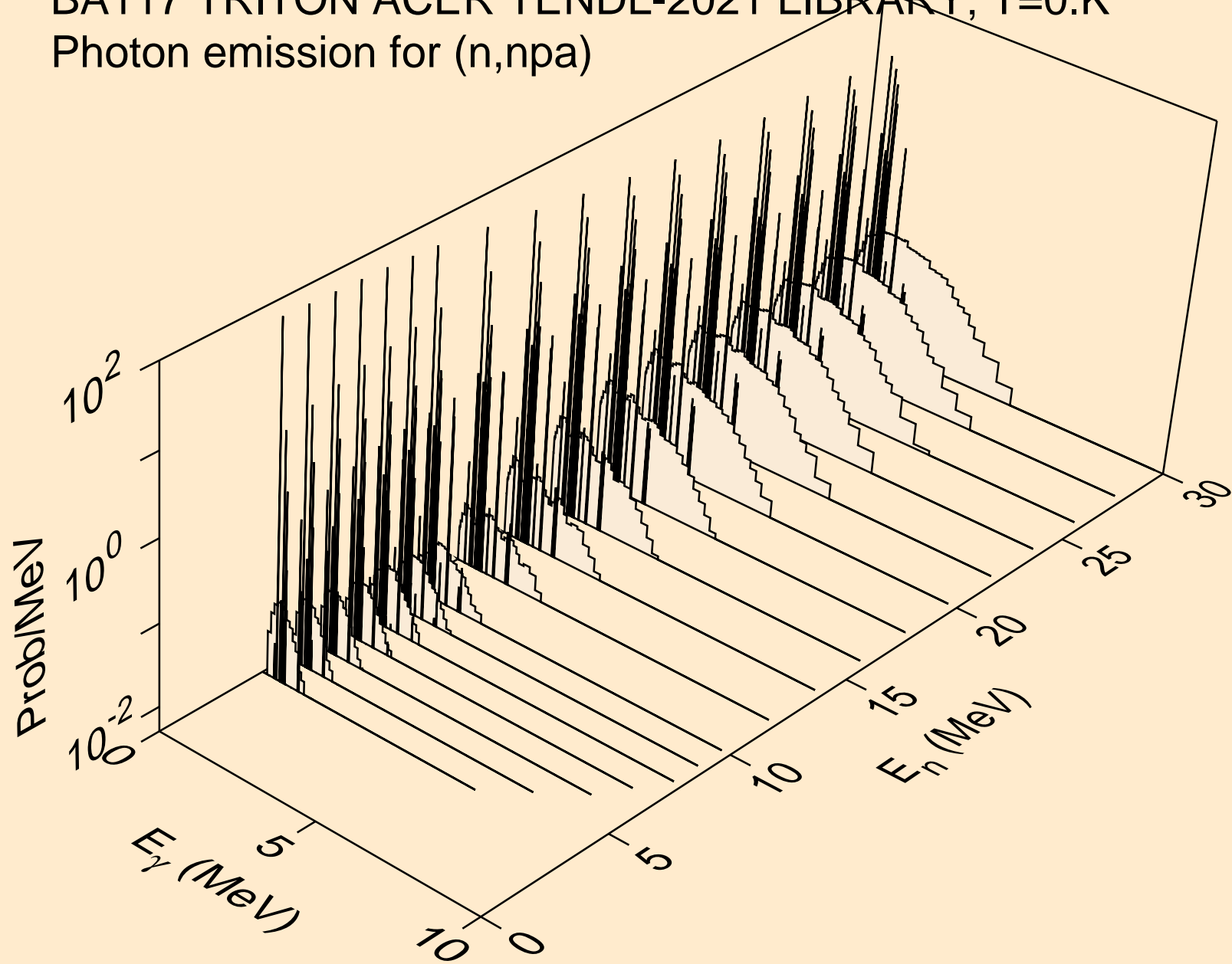

BA117 TRITON ACER TENDL-2021 LIBRARY; T=0.K  
Photon emission for (n,gma)

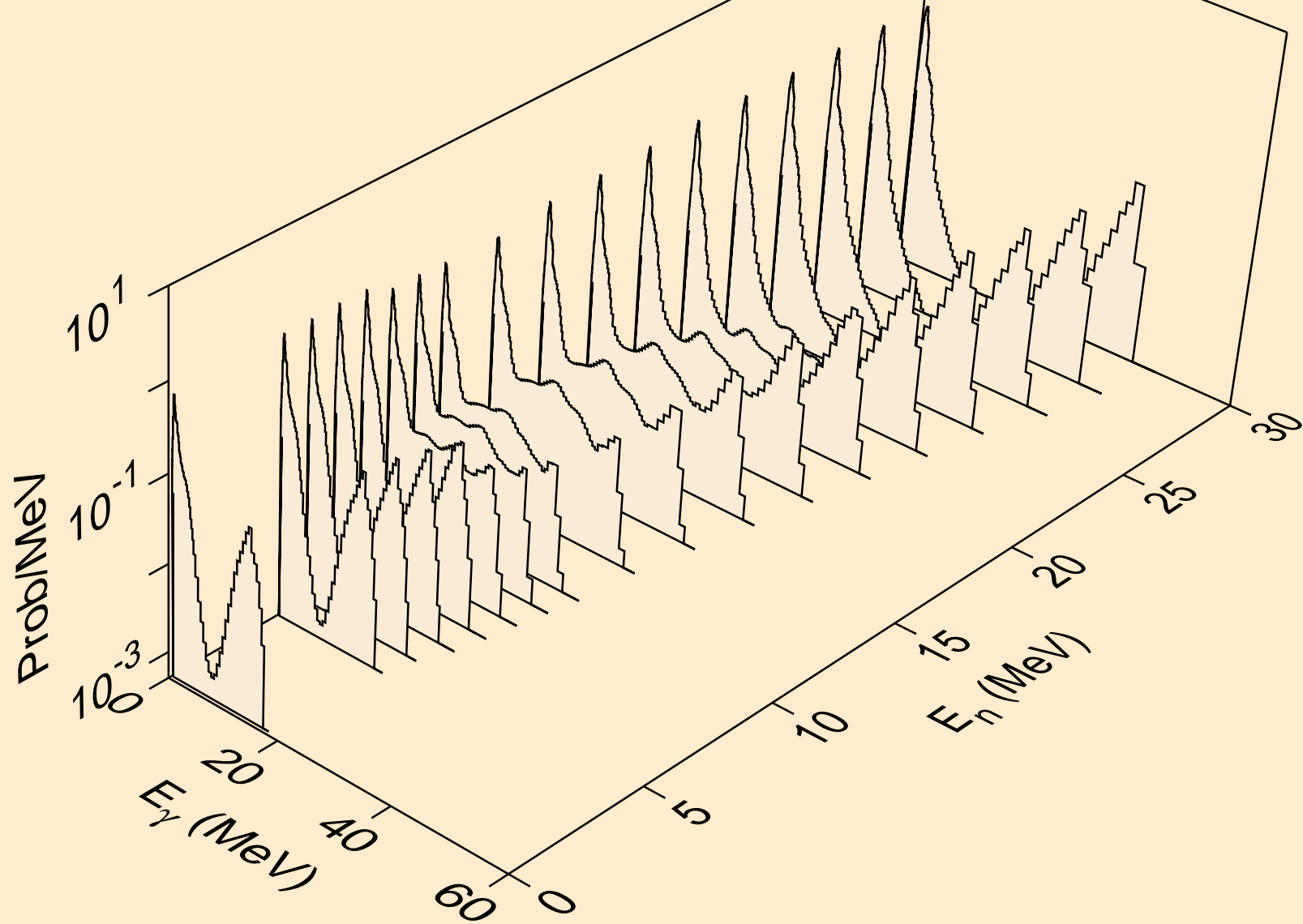

BA117 TRITON ACER TENDL-2021 LIBRARY; T=0.K  
Photon emission for (n,p)

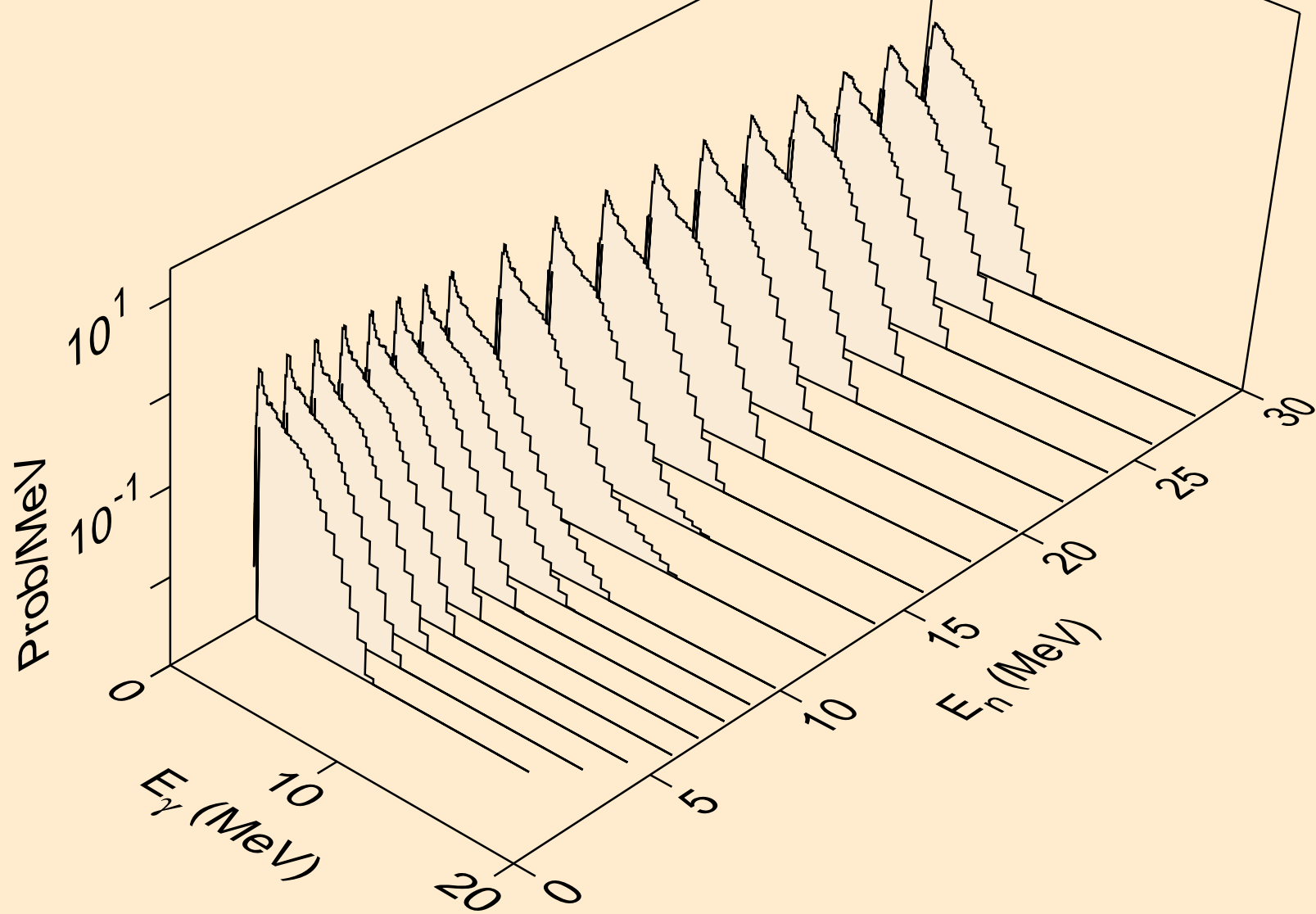



BA117 TRITON ACER TENDL-2021 LIBRARY; T=0.K  
Photon emission for (n,d)

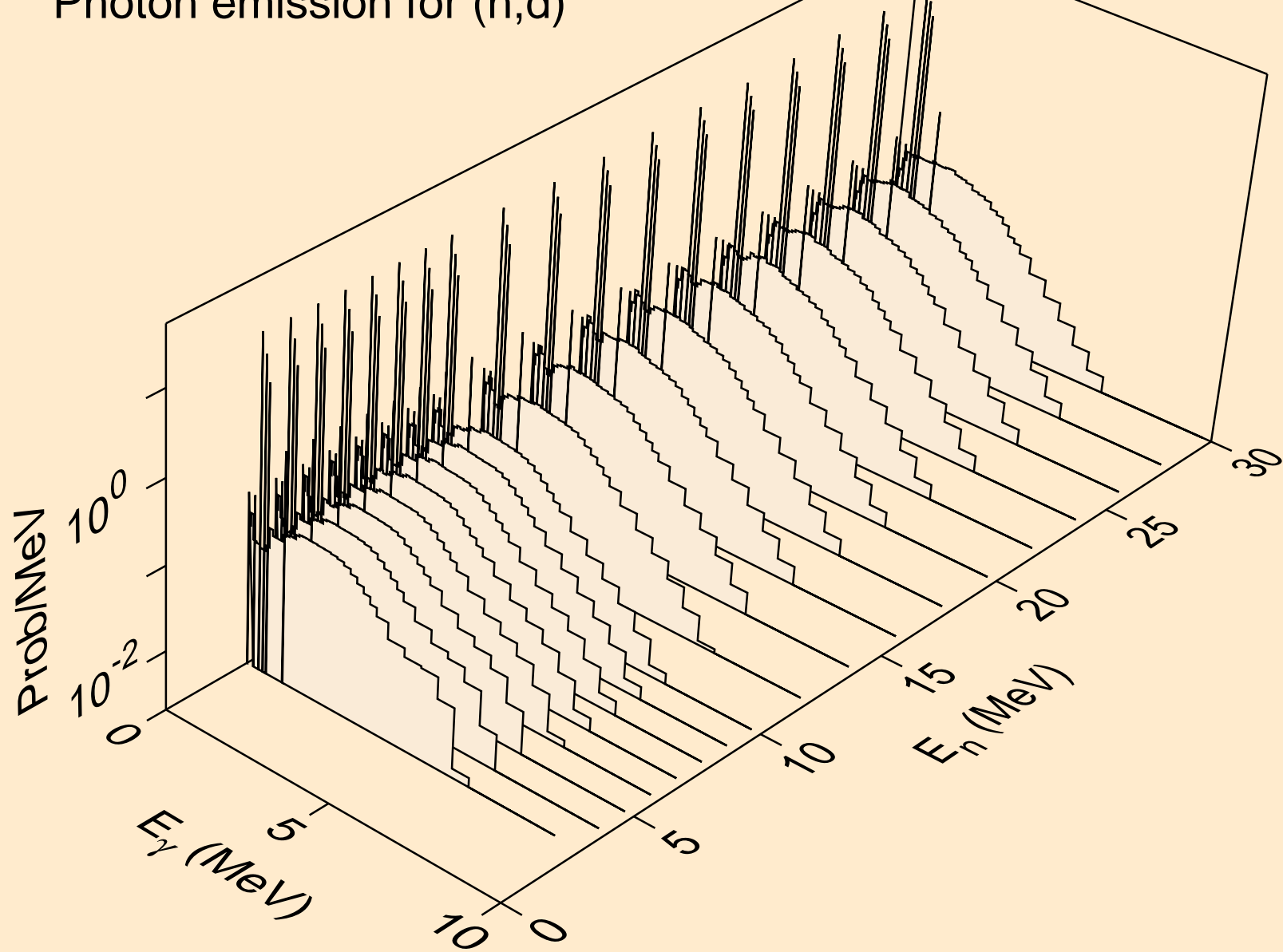

BA117 TRITON ACER TENDL-2021 LIBRARY; T=0.K  
Photon emission for inelastic

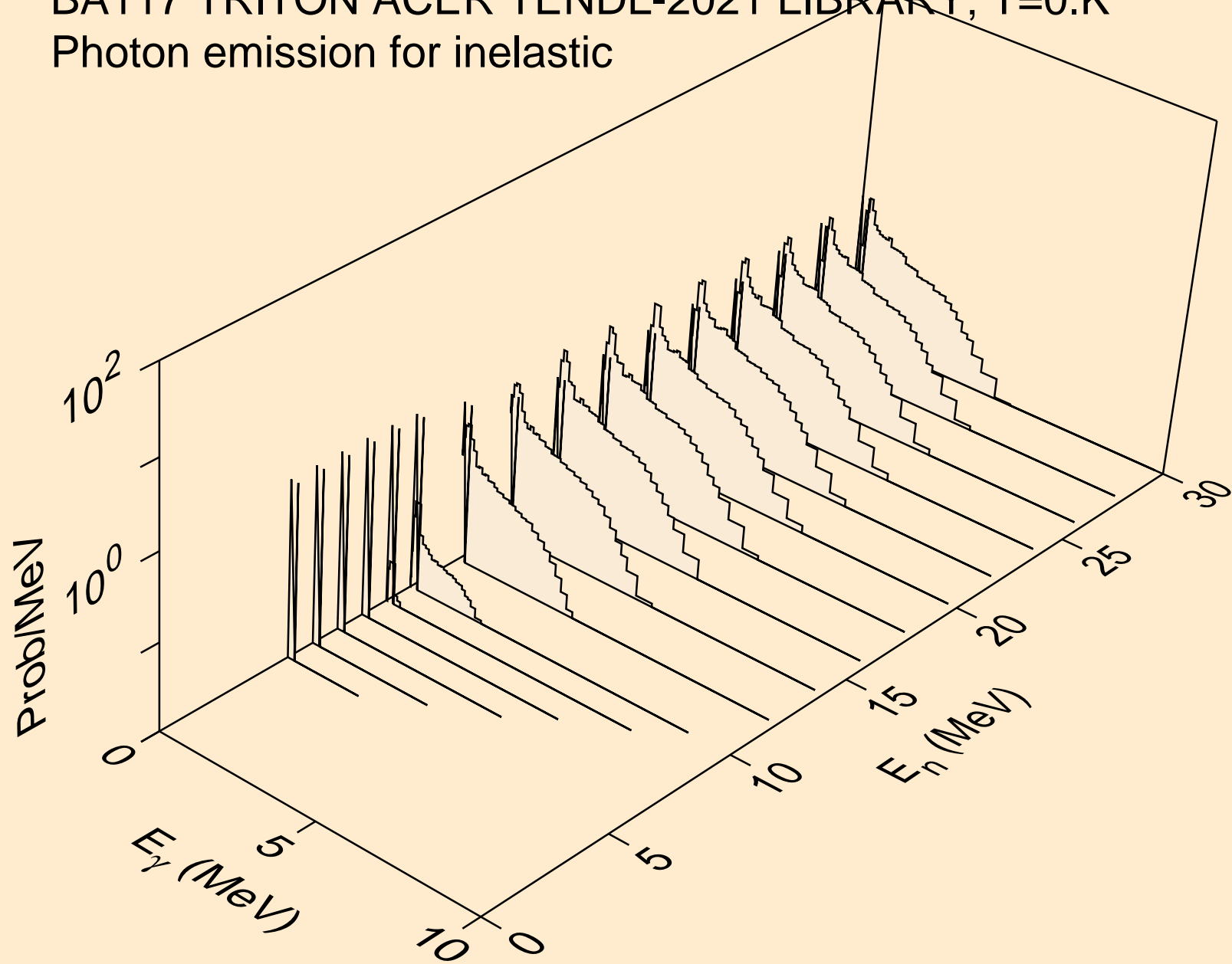

BA117 TRITON ACER TENDL-2021 LIBRARY; T=0.K  
Photon emission for (n,he3)

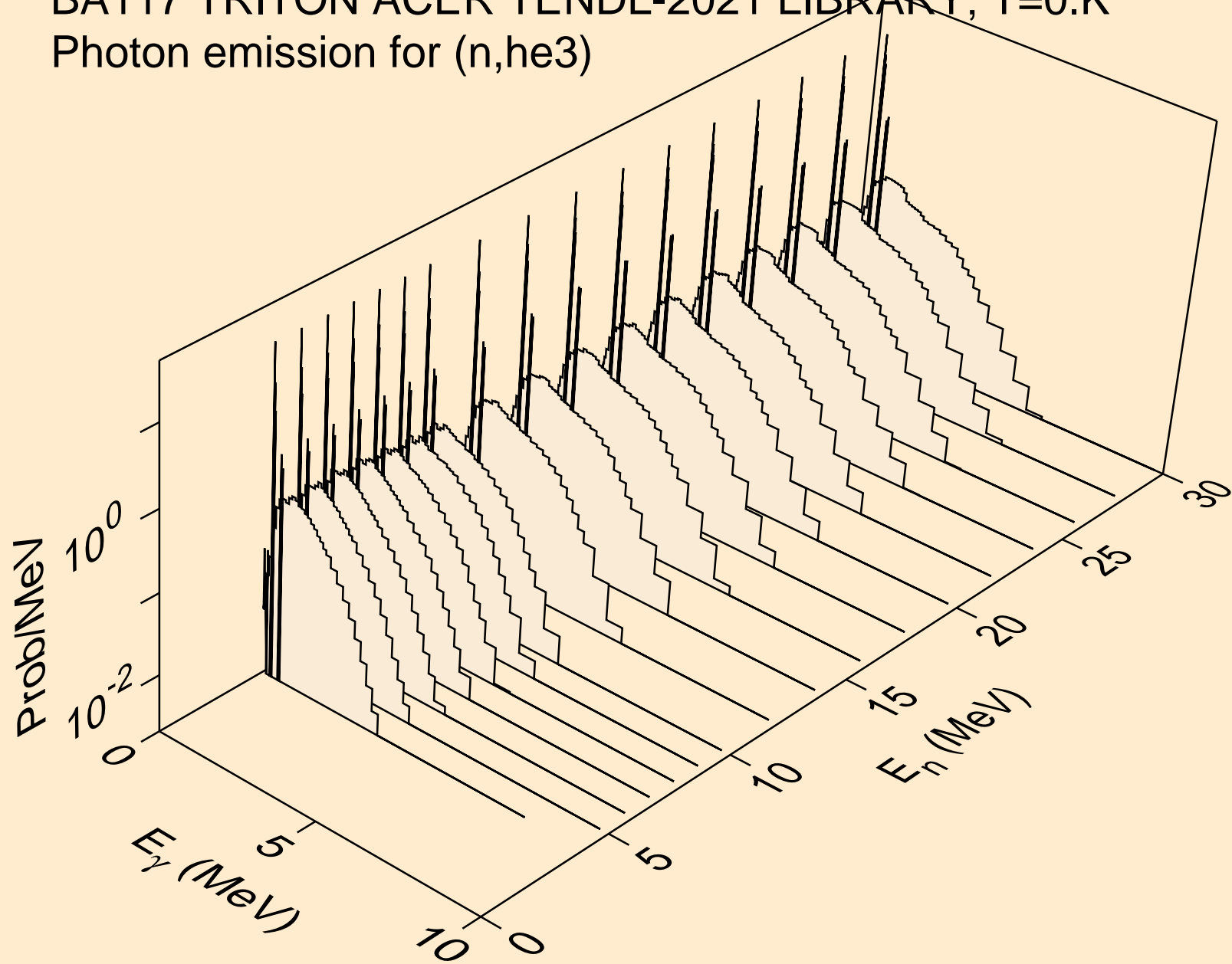

BA117 TRITON ACER TENDL-2021 LIBRARY; T=0.K  
Photon emission for (n,a)

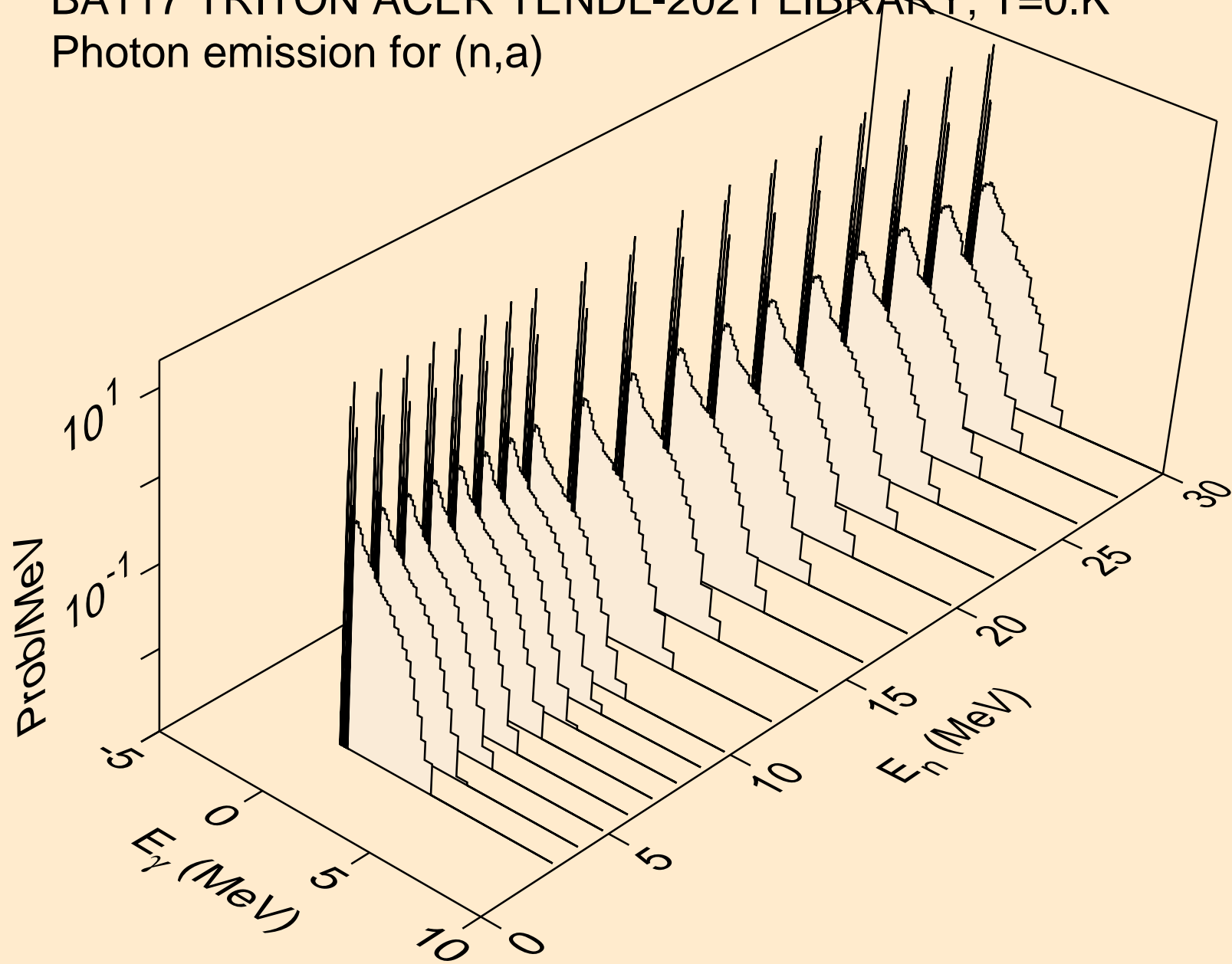

BA117 TRITON ACER TENDL-2021 LIBRARY; T=0.K  
Photon emission for (n,2a)

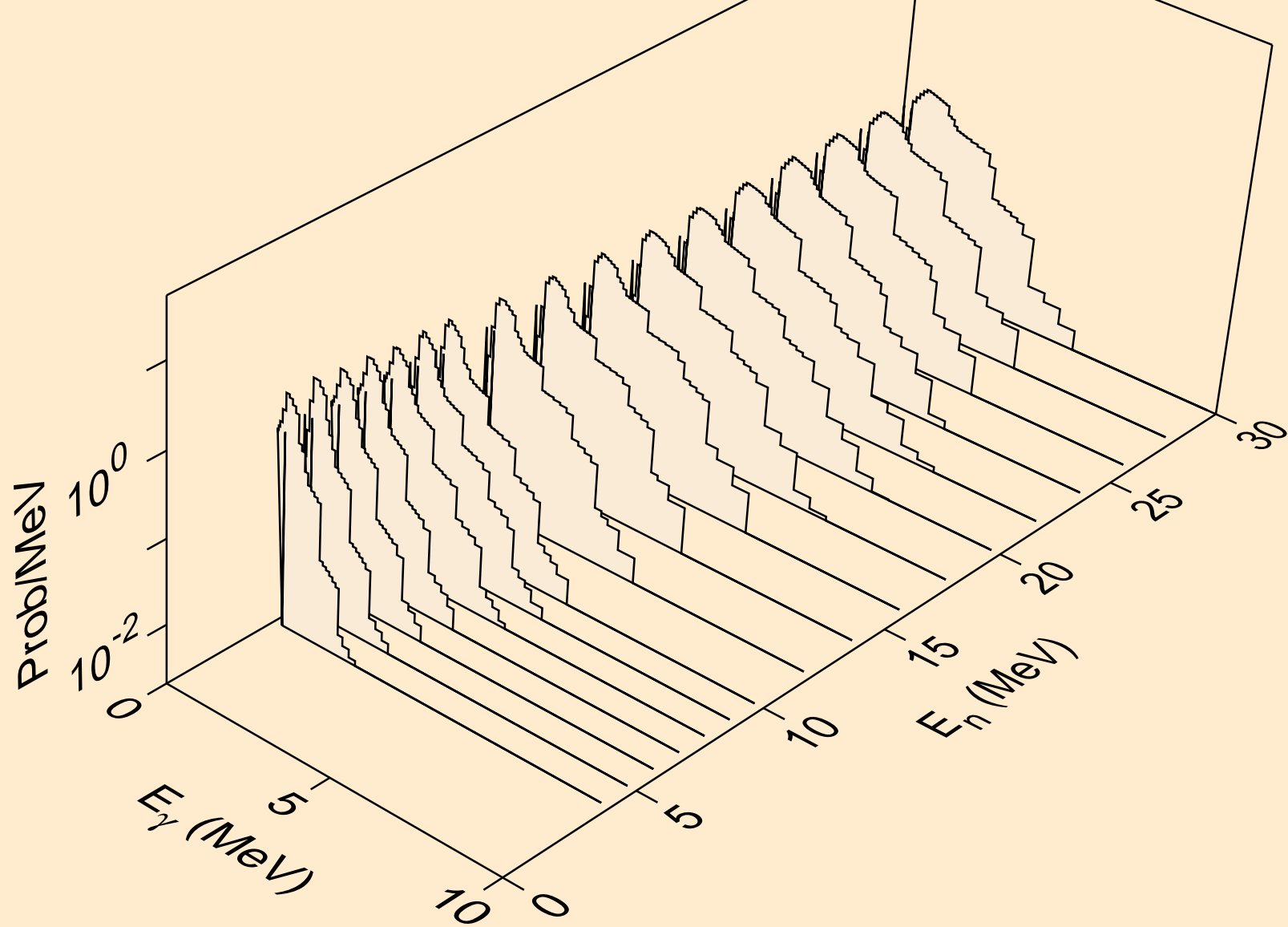

BA117 TRITON ACER TENDL-2021 LIBRARY; T=0.K  
Photon emission for (n,3a)

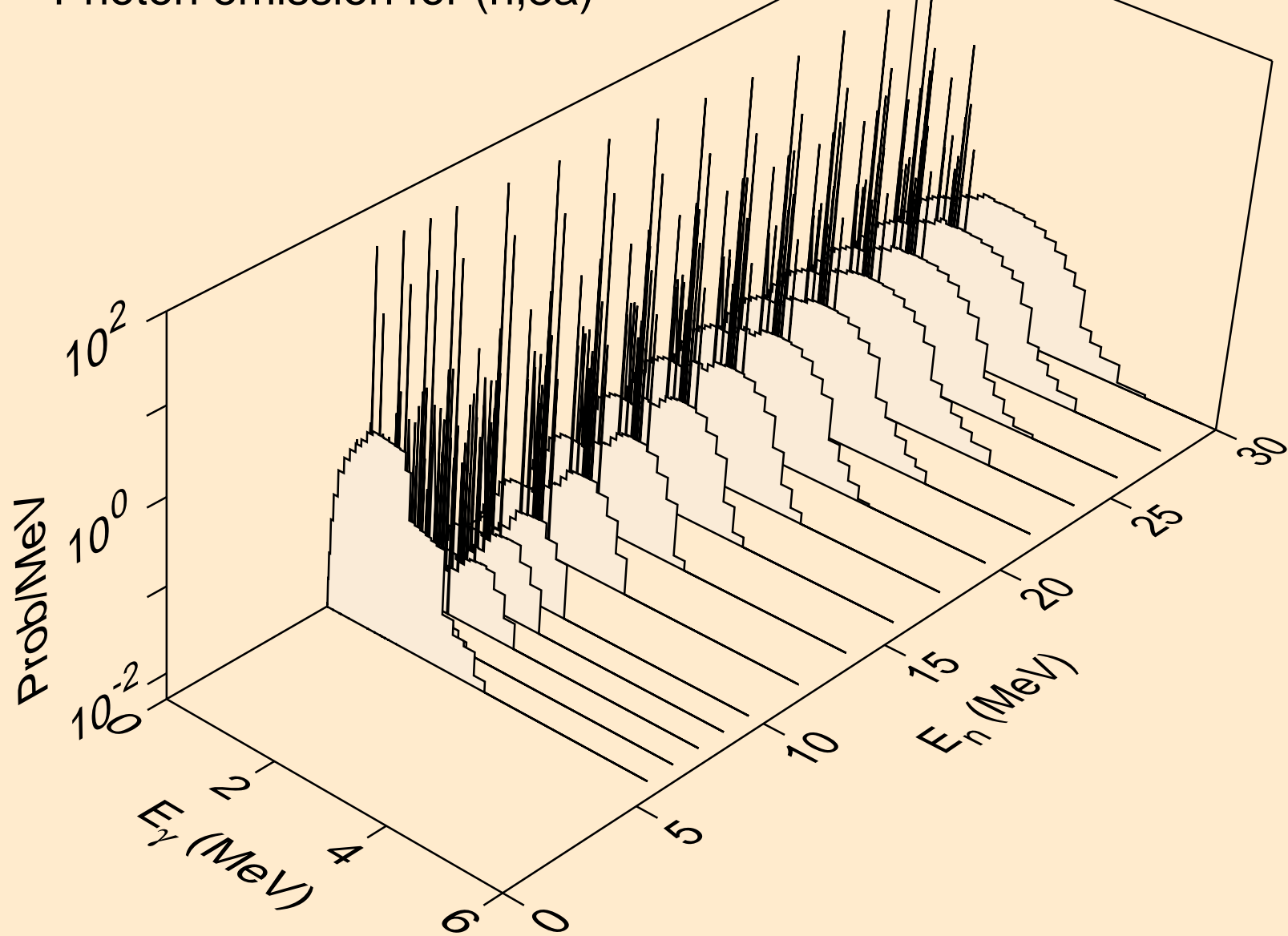

BA117 TRITON ACER TENDL-2021 LIBRARY; T=0.K  
Photon emission for (n,2p)

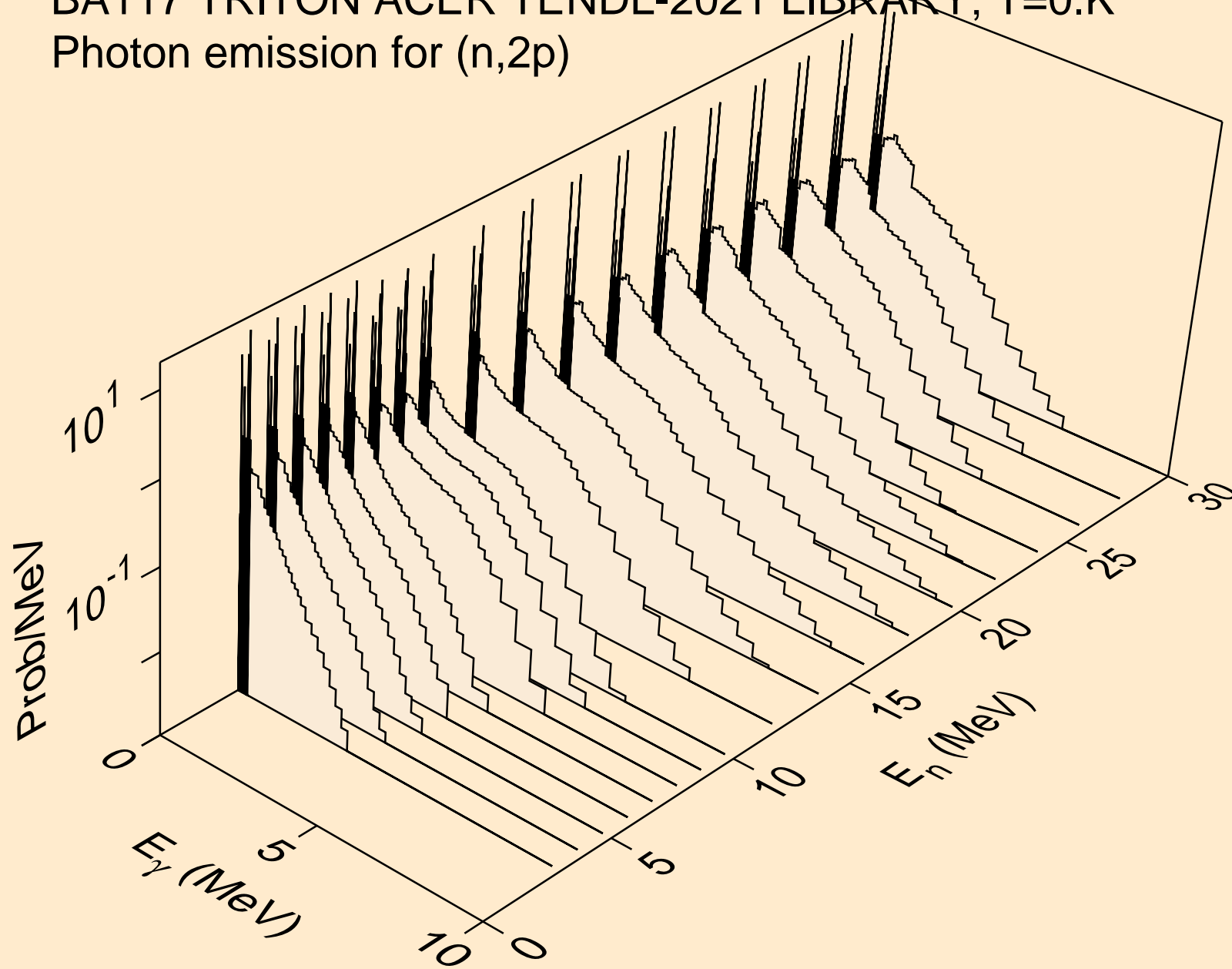

BA117 TRITON ACER TENDL-2021 LIBRARY; T=0.K  
Photon emission for (n,pa)

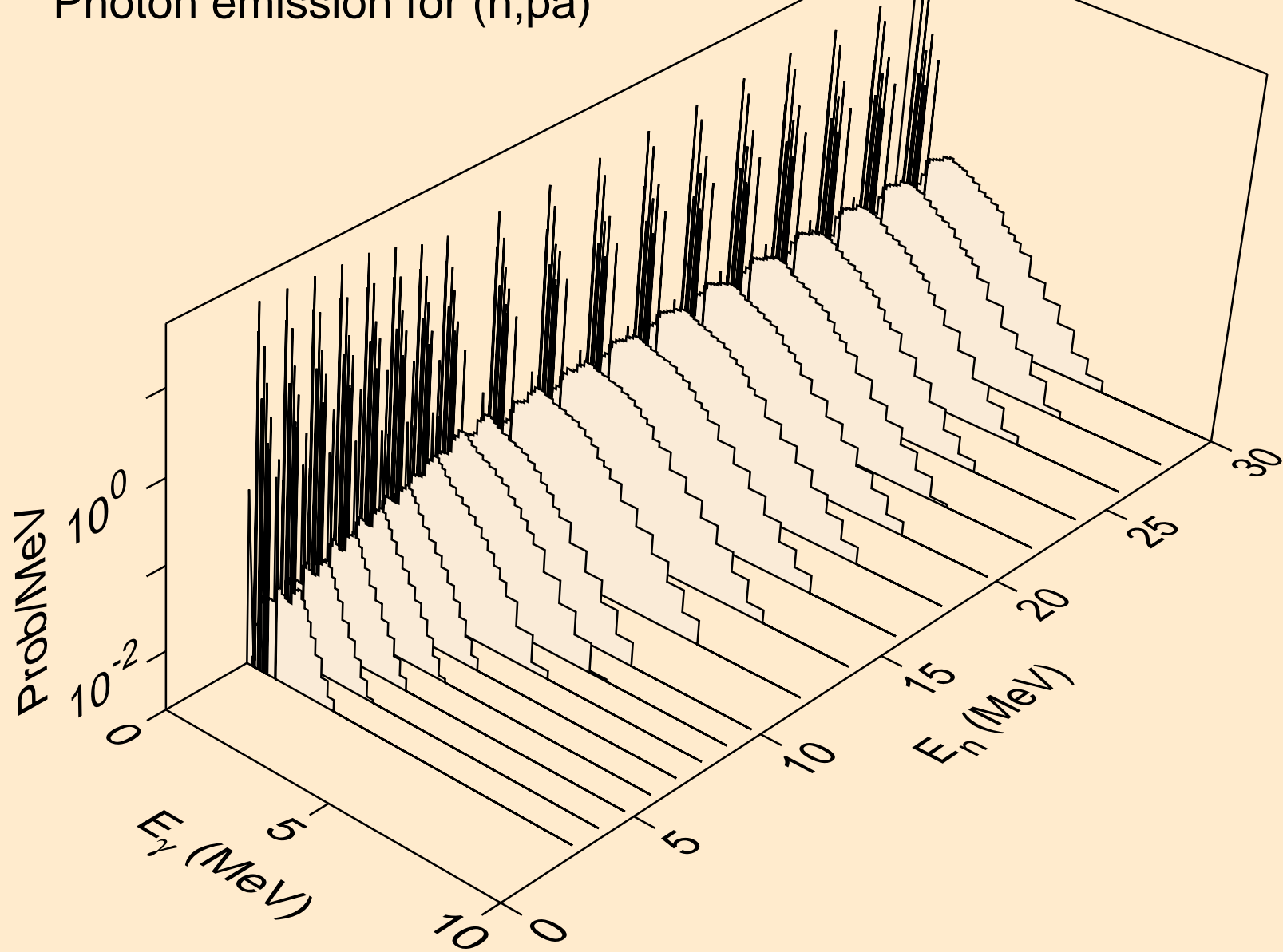



BA117 TRITON ACER TENDL-2021 LIBRARY; T=0.K  
Photon emission for (n,t2a)

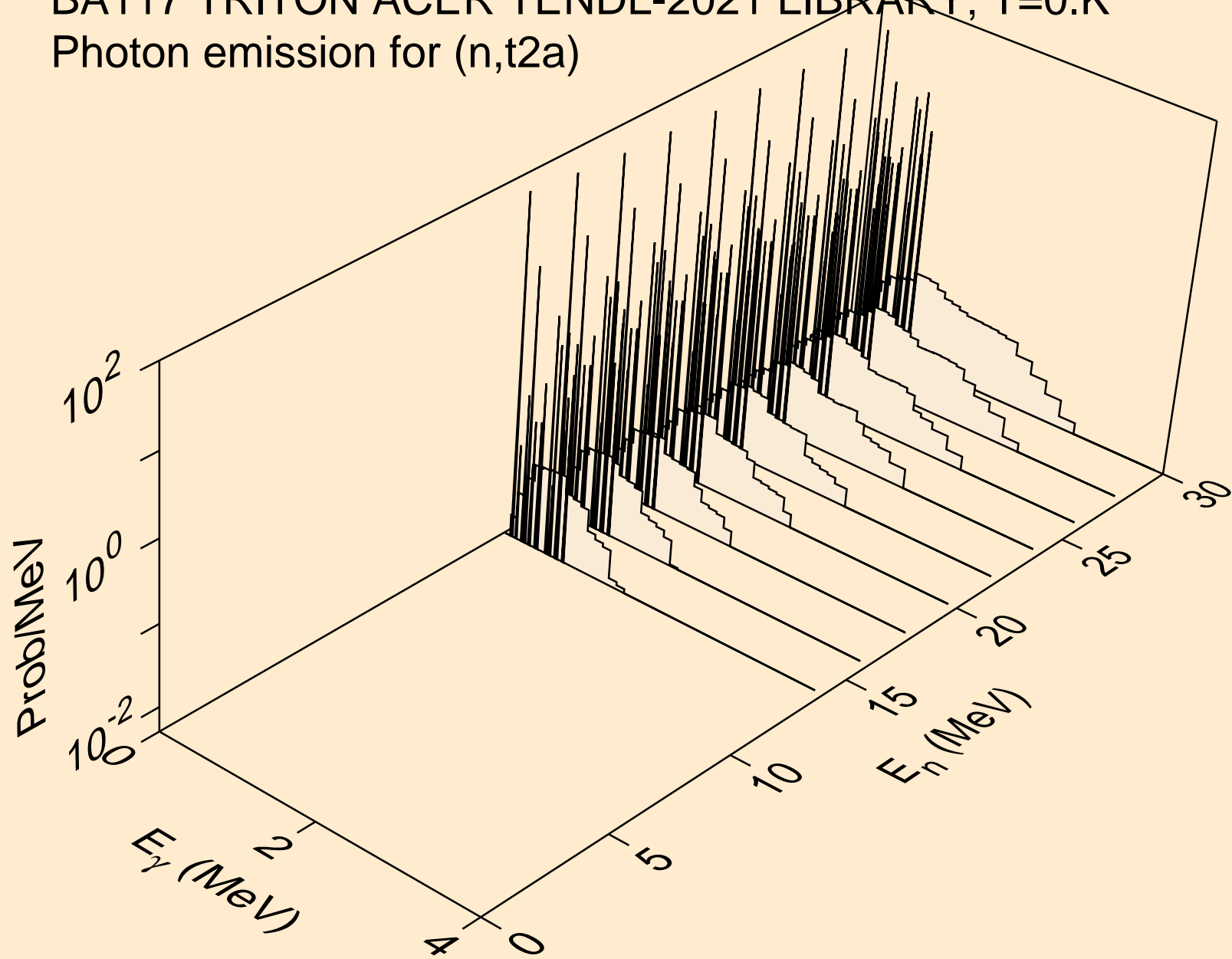

BA117 TRITON ACER TENDL-2021 LIBRARY; T=0.K  
Photon emission for (n,d2a)

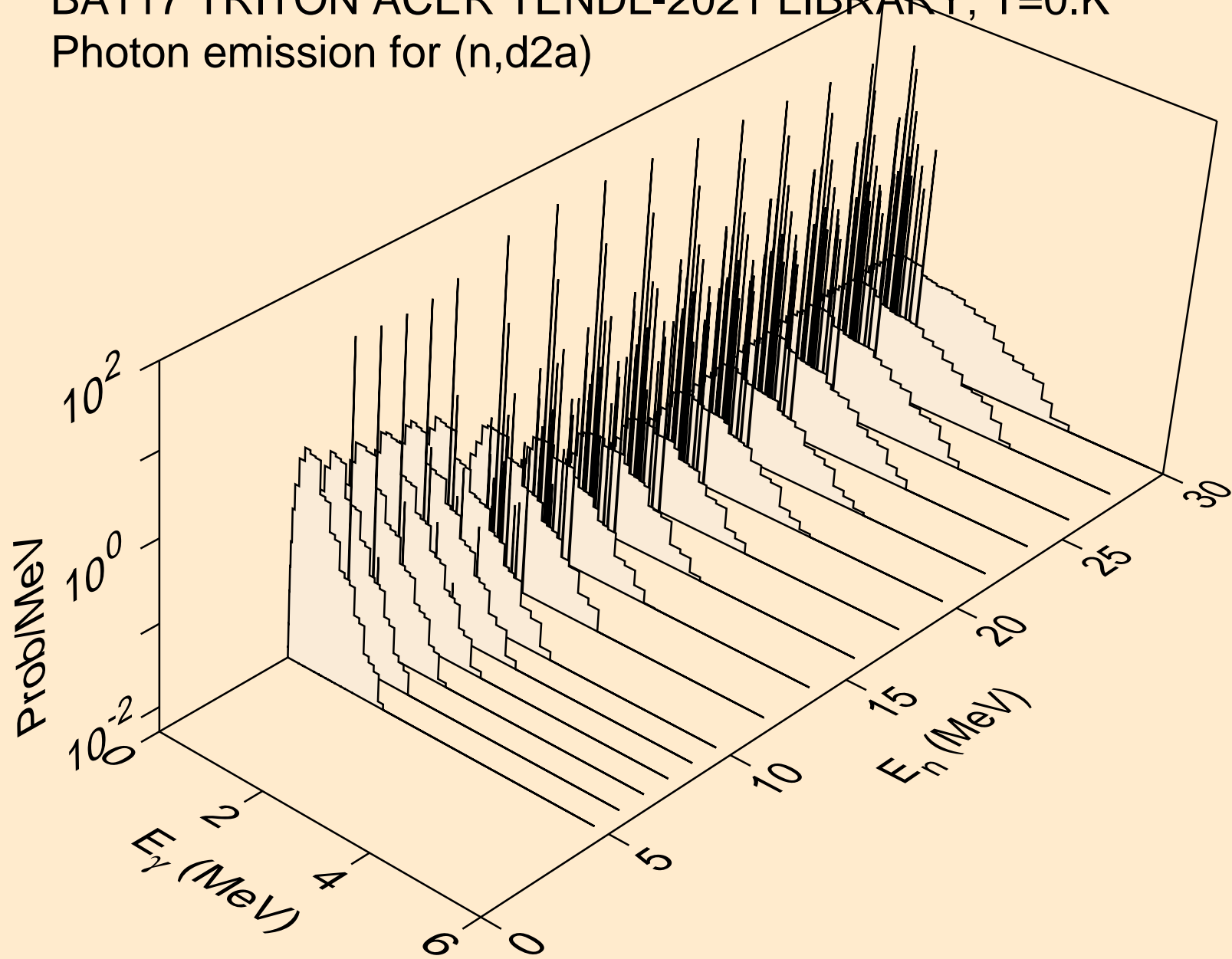

BA117 TRITON ACER TENDL-2021 LIBRARY; T=0.K  
Photon emission for (n,pd)

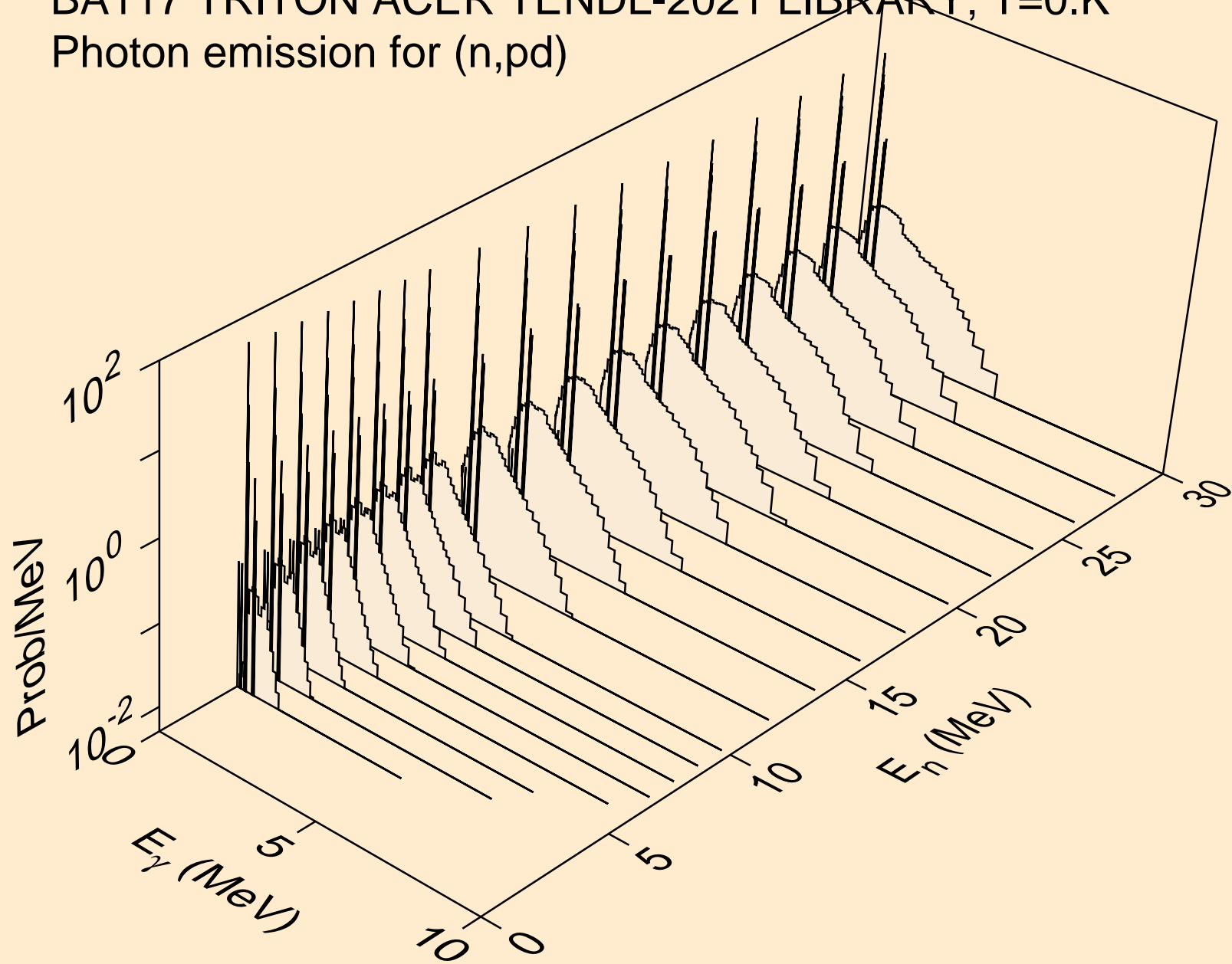

BA117 TRITON ACER TENDL-2021 LIBRARY; T=0.K  
Photon emission for (n,pt)

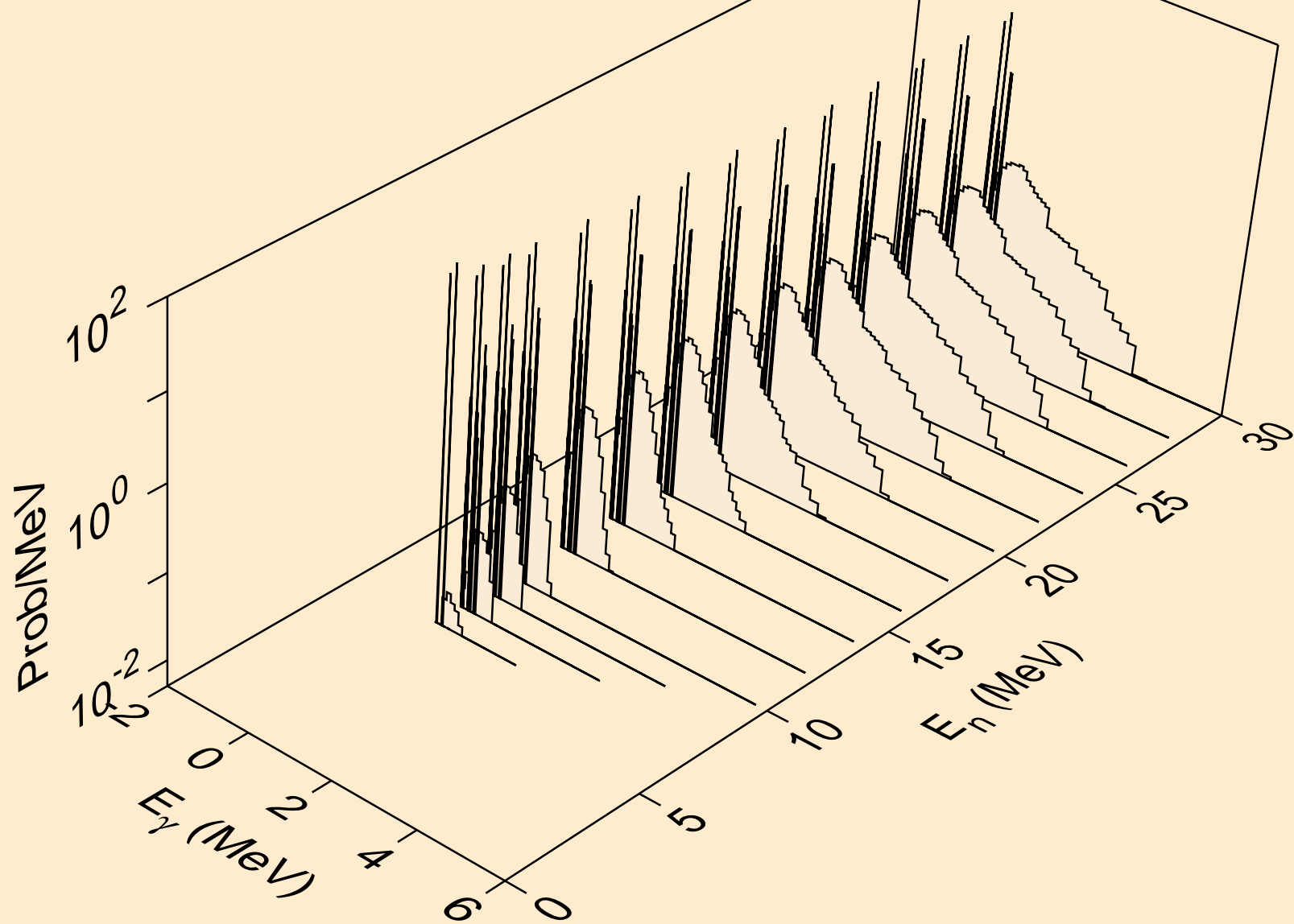

BA117 TRITON ACER TENDL-2021 LIBRARY; T=0.K  
Photon emission for (n,da)

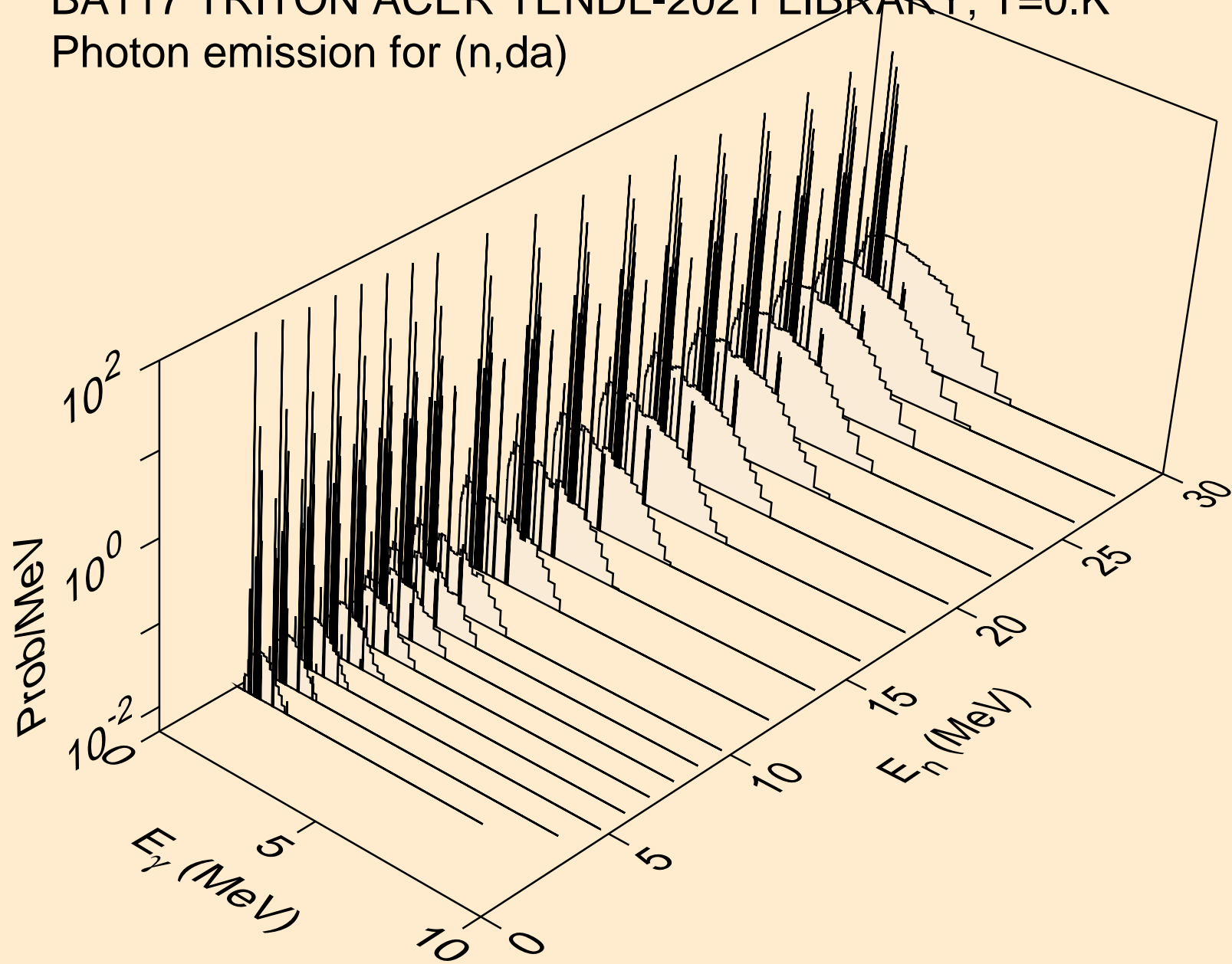

BA117 TRITON ACER TENDL-2021 LIBRARY; T=0.K  
Particle heating contributions

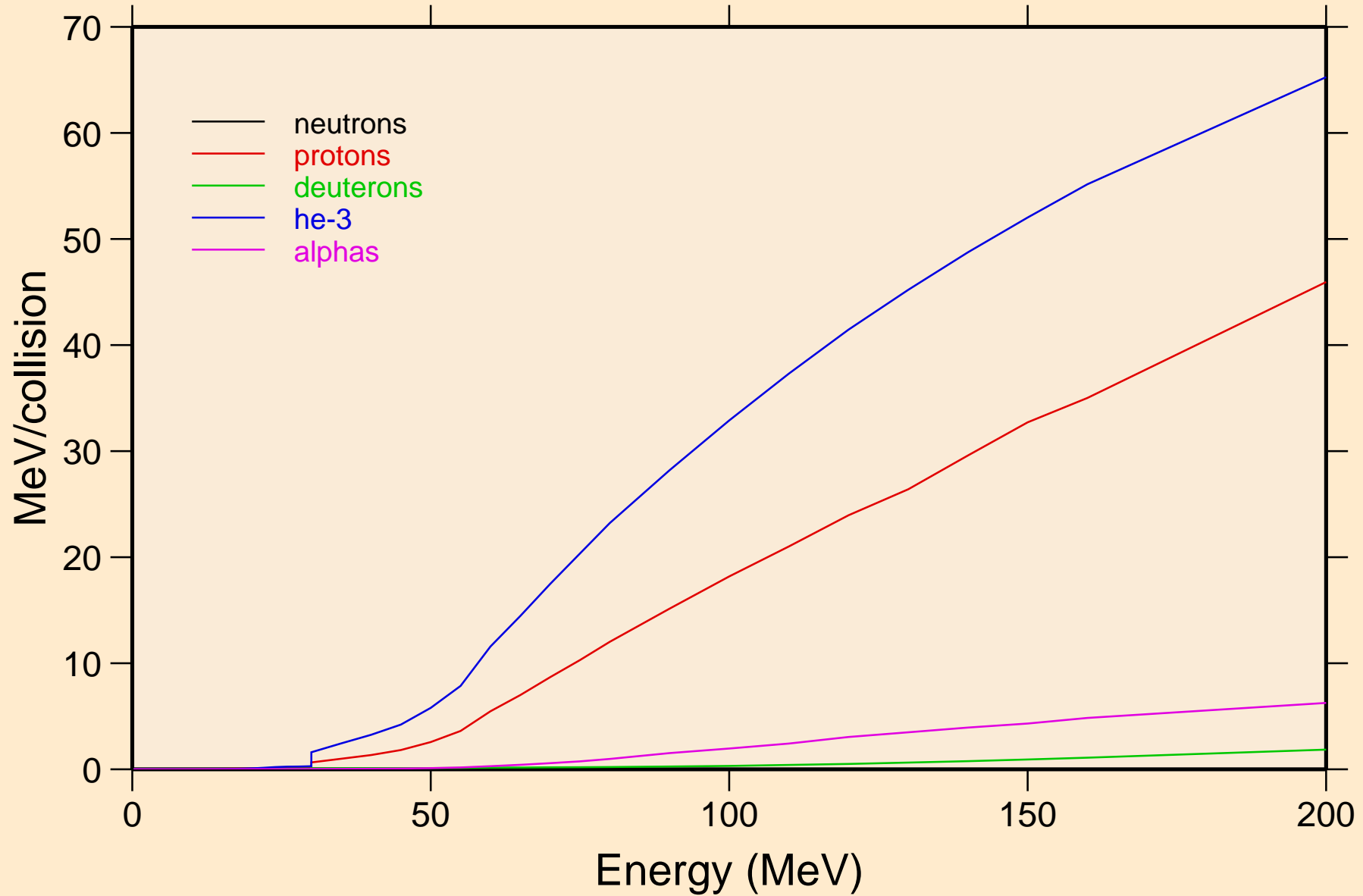

BA117 TRITON ACER TENDL-2021 LIBRARY; T=0.K  
Recoil Heating

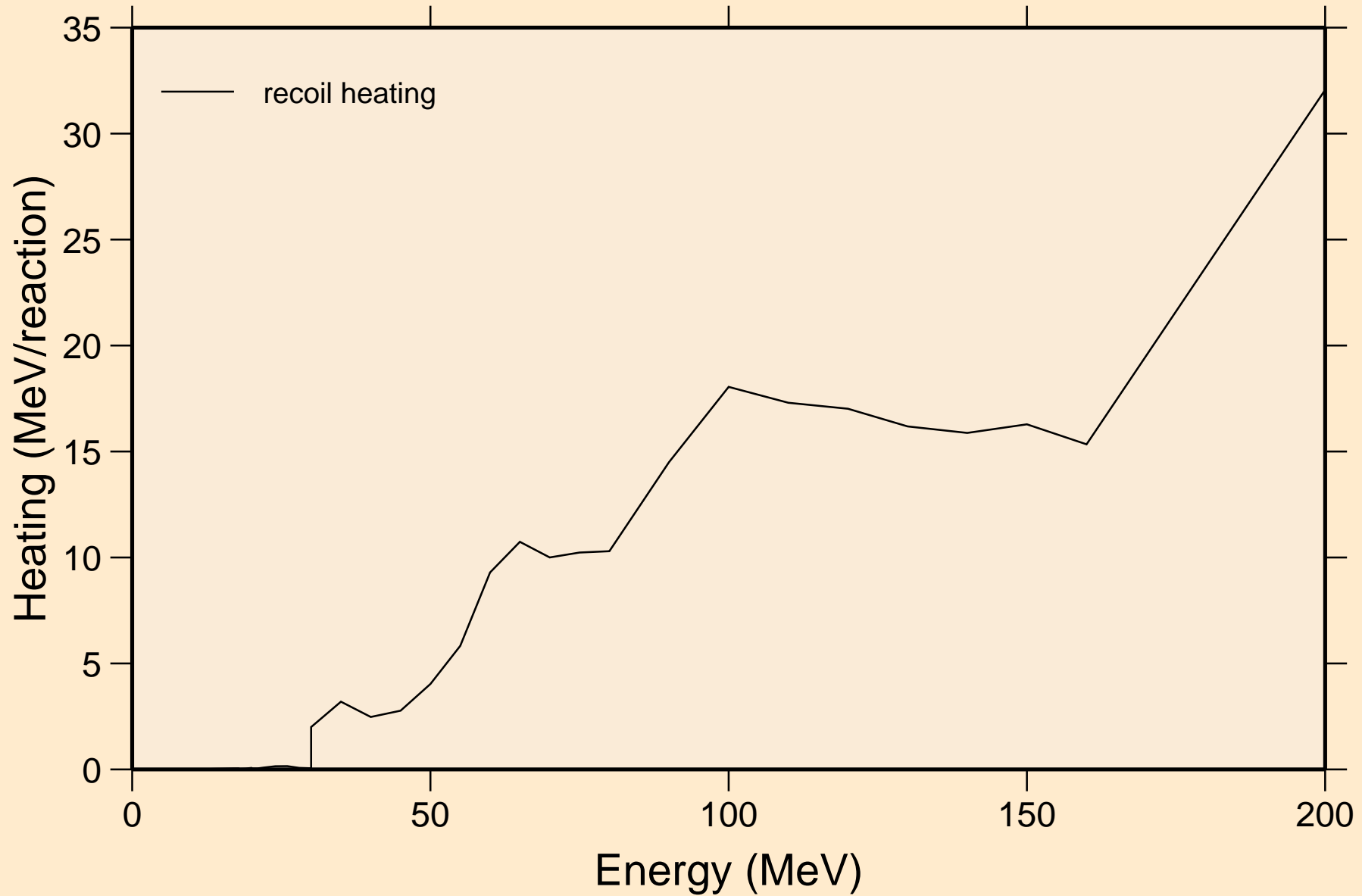

BA117 TRITON ACER TENDL-2021 LIBRARY; T=0.K  
Particle production cross sections

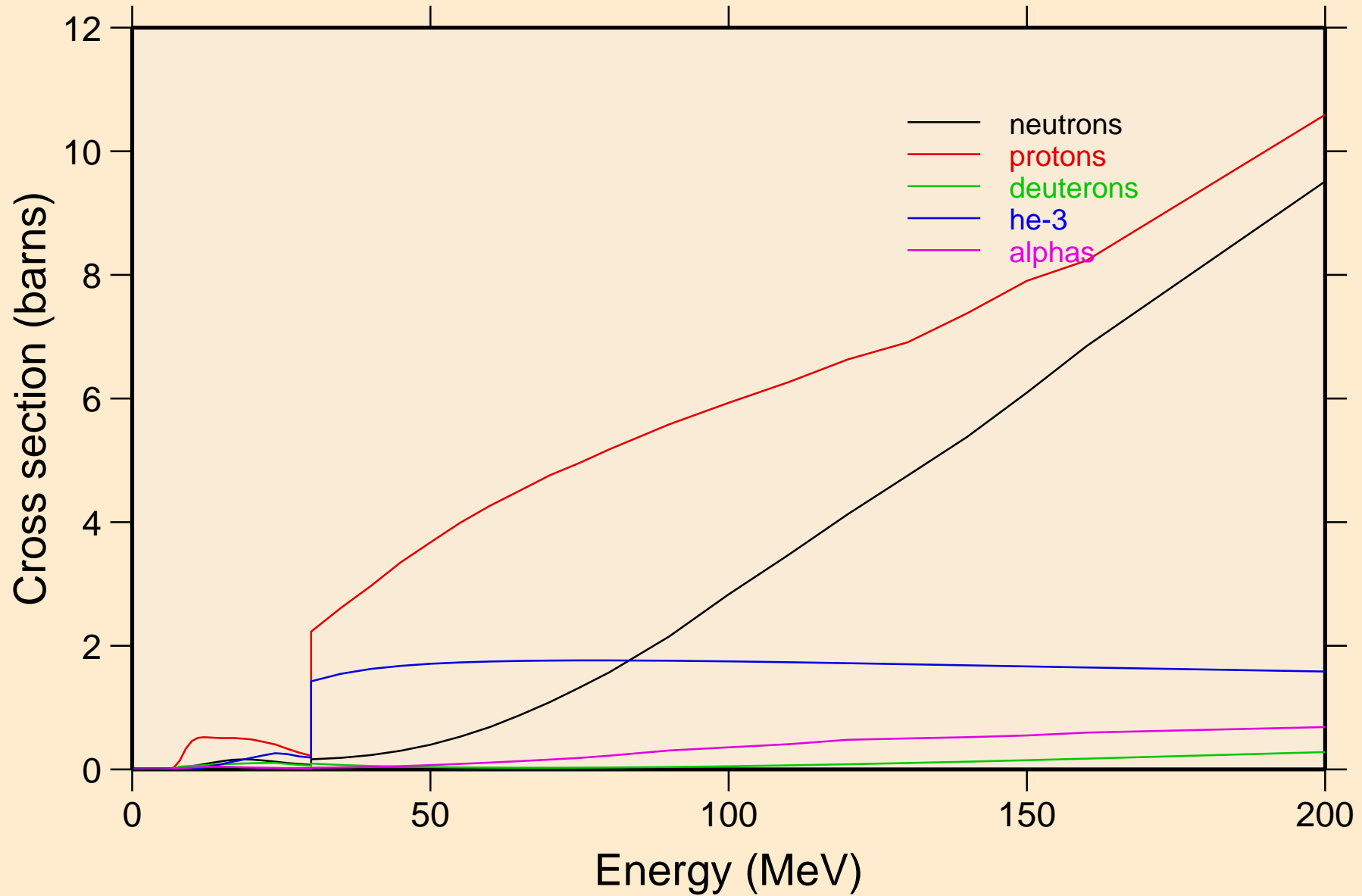



BA117 TRITON ACER TENDL-2021 LIBRARY; T=0.K  
neutrons from (t,n)

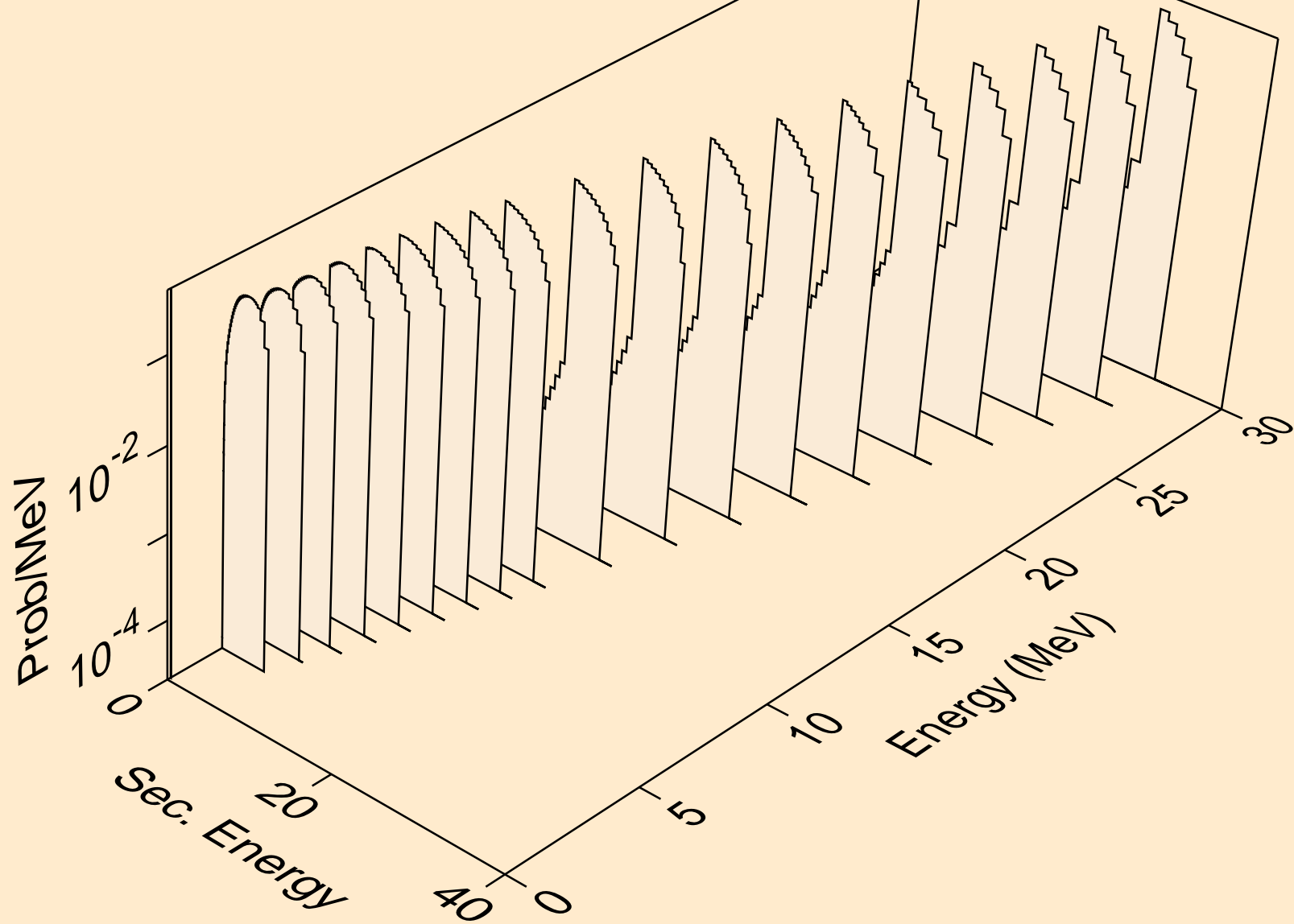

BA117 TRITON ACER TENDL-2021 LIBRARY; T=0.K  
neutrons from (t,x)

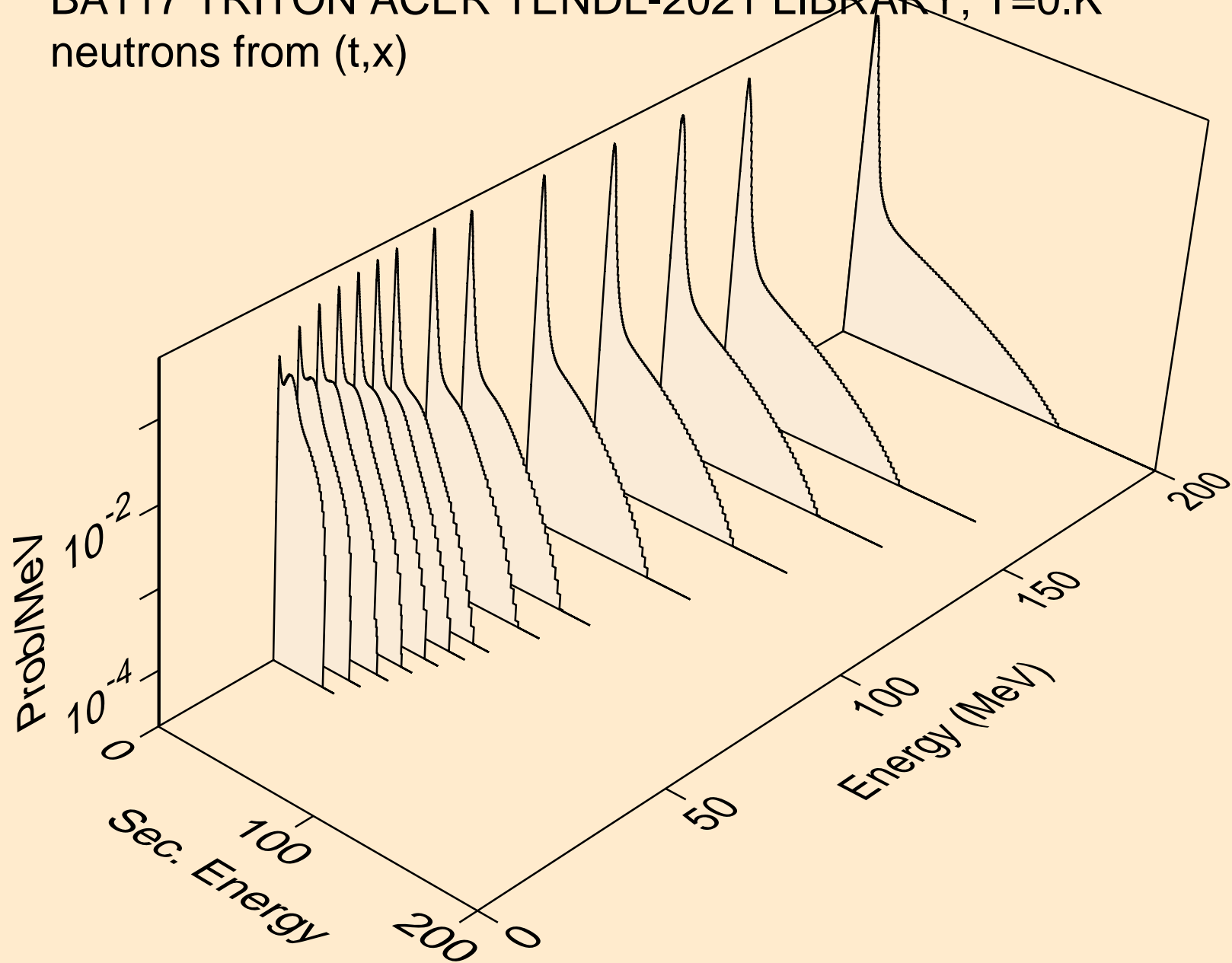

BA117 TRITON ACER TENDL-2021 LIBRARY; T=0.K  
neutrons from (t,2nd)

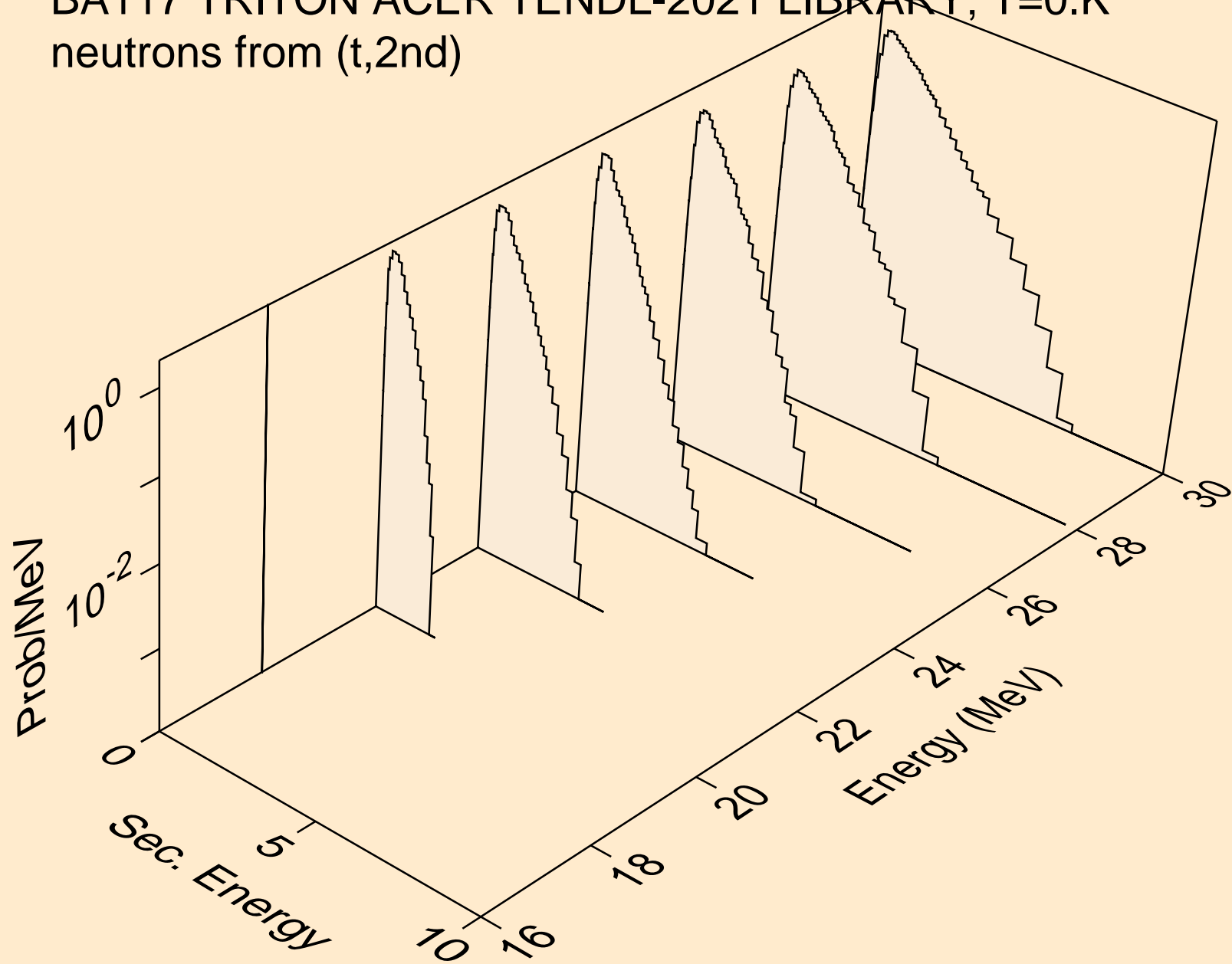

BA117 TRITON ACER TENDL-2021 LIBRARY; T=0.K  
neutrons from (t,2n)

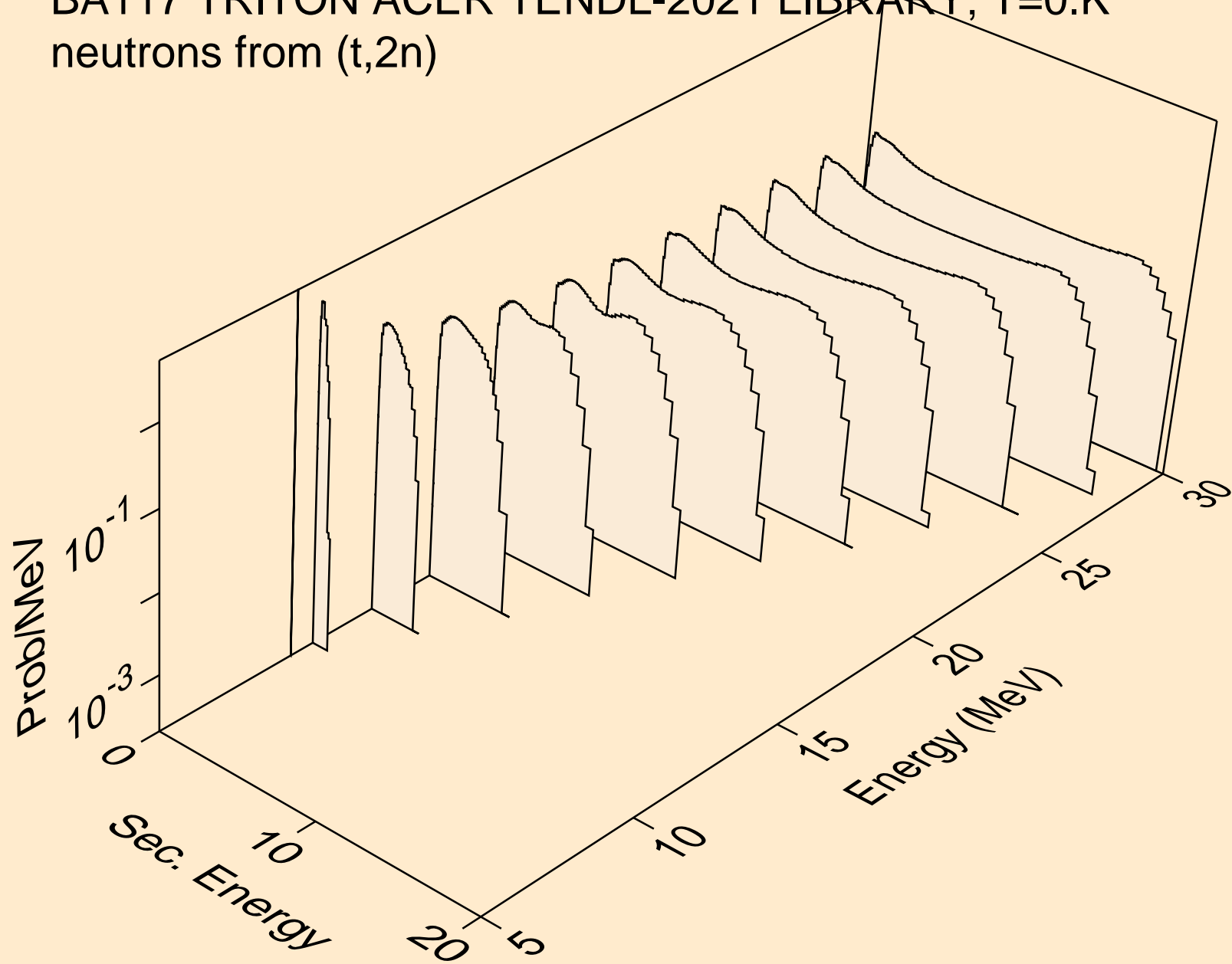

BA117 TRITON ACER TENDL-2021 LIBRARY; T=0.K  
neutrons from (t,3n)

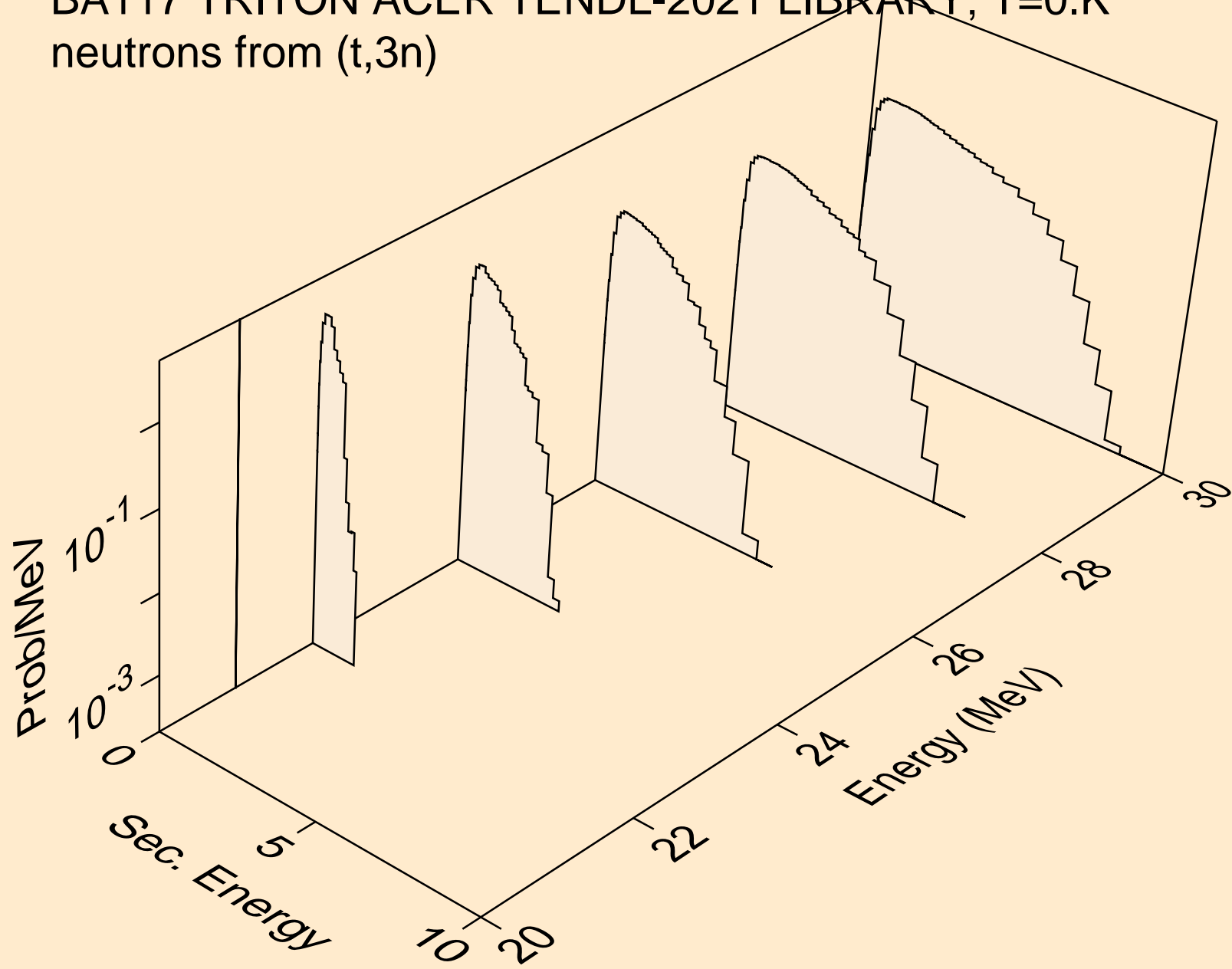

BA117 TRITON ACER TENDL-2021 LIBRARY; T=0.K  
neutrons from (t,n\*)a

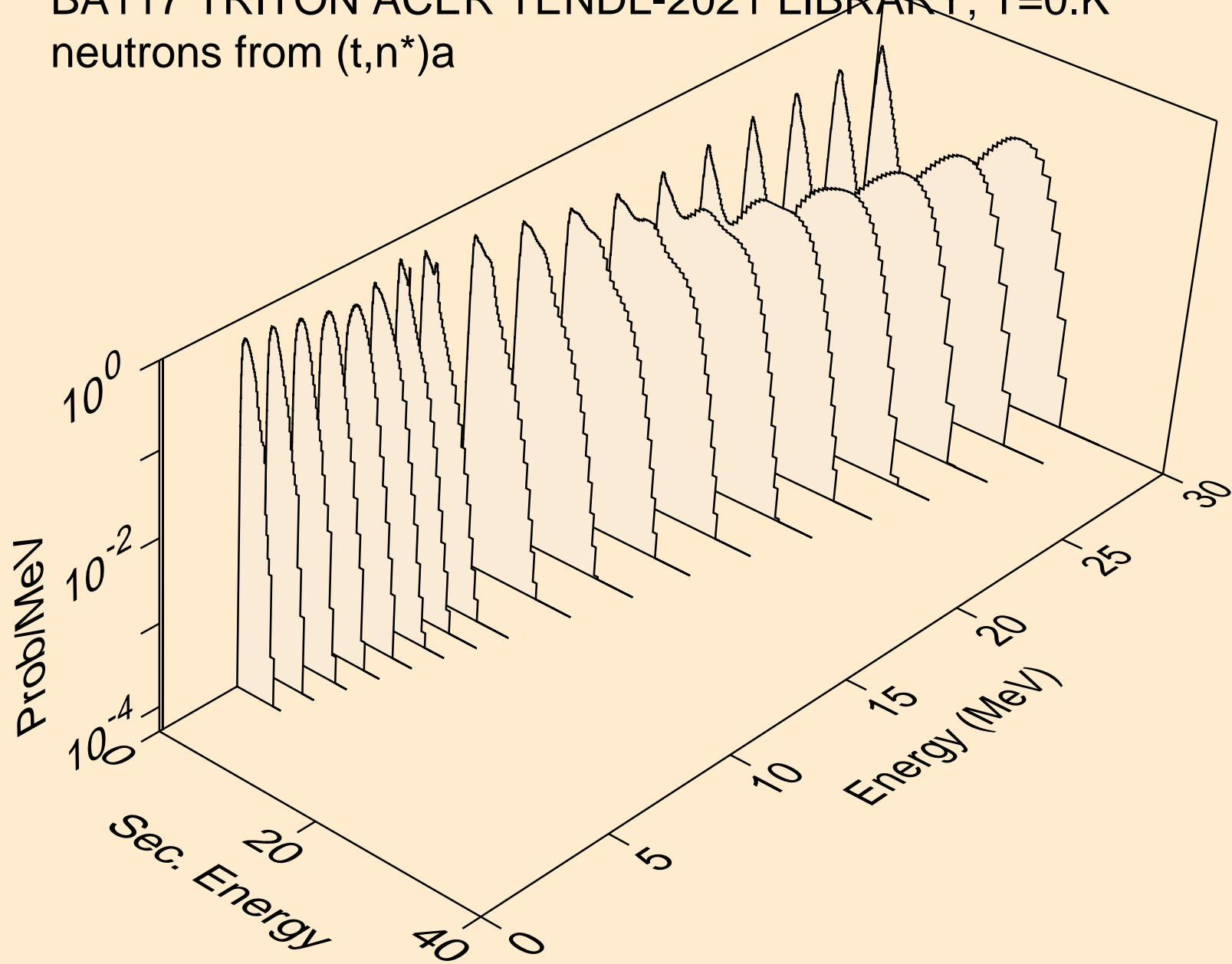

BA117 TRITON ACER TENDL-2021 LIBRARY; T=0.K  
neutrons from (t,n\*)3a

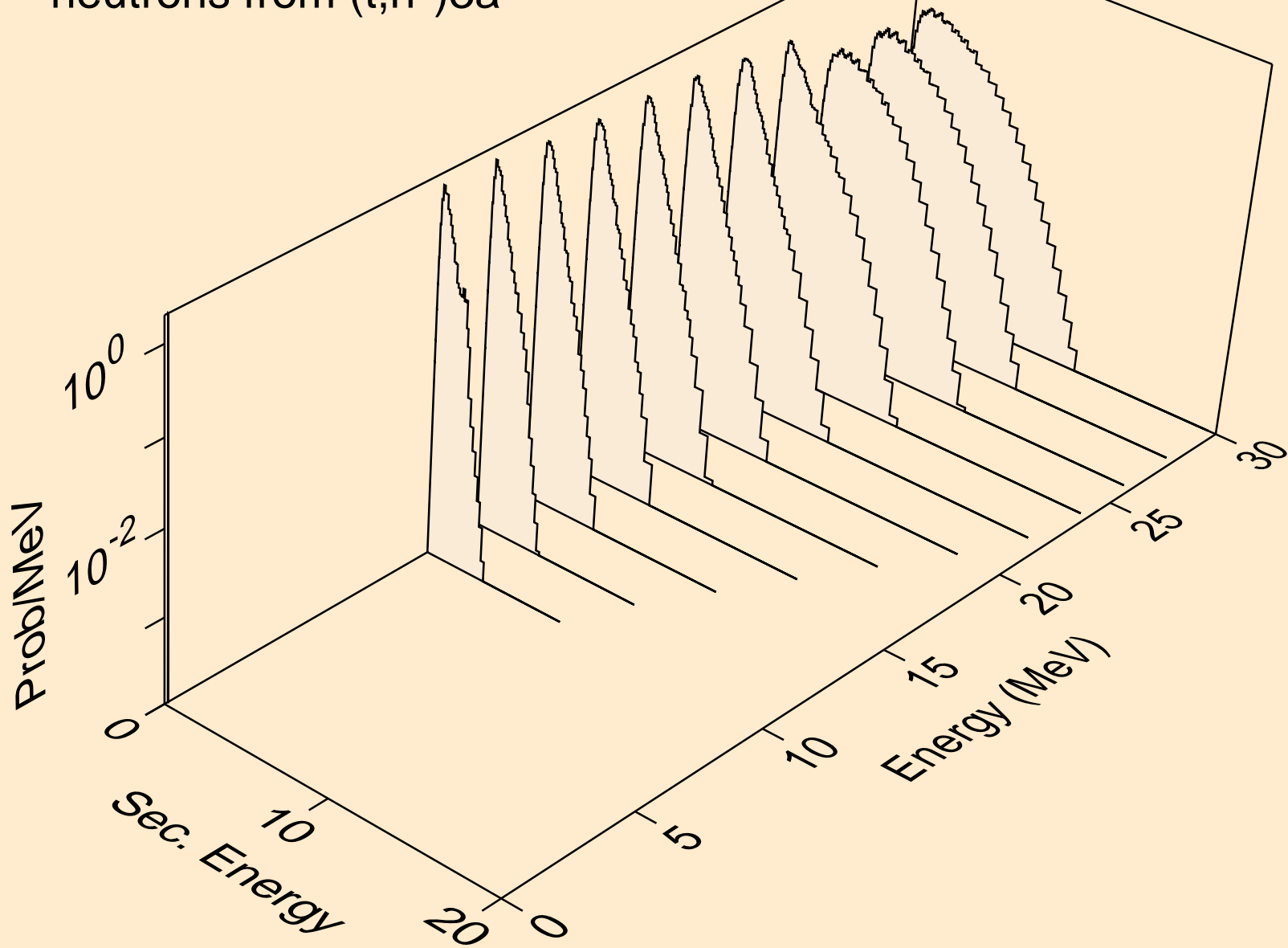

BA117 TRITON ACER TENDL-2021 LIBRARY; T=0.K  
neutrons from (t,2n)a

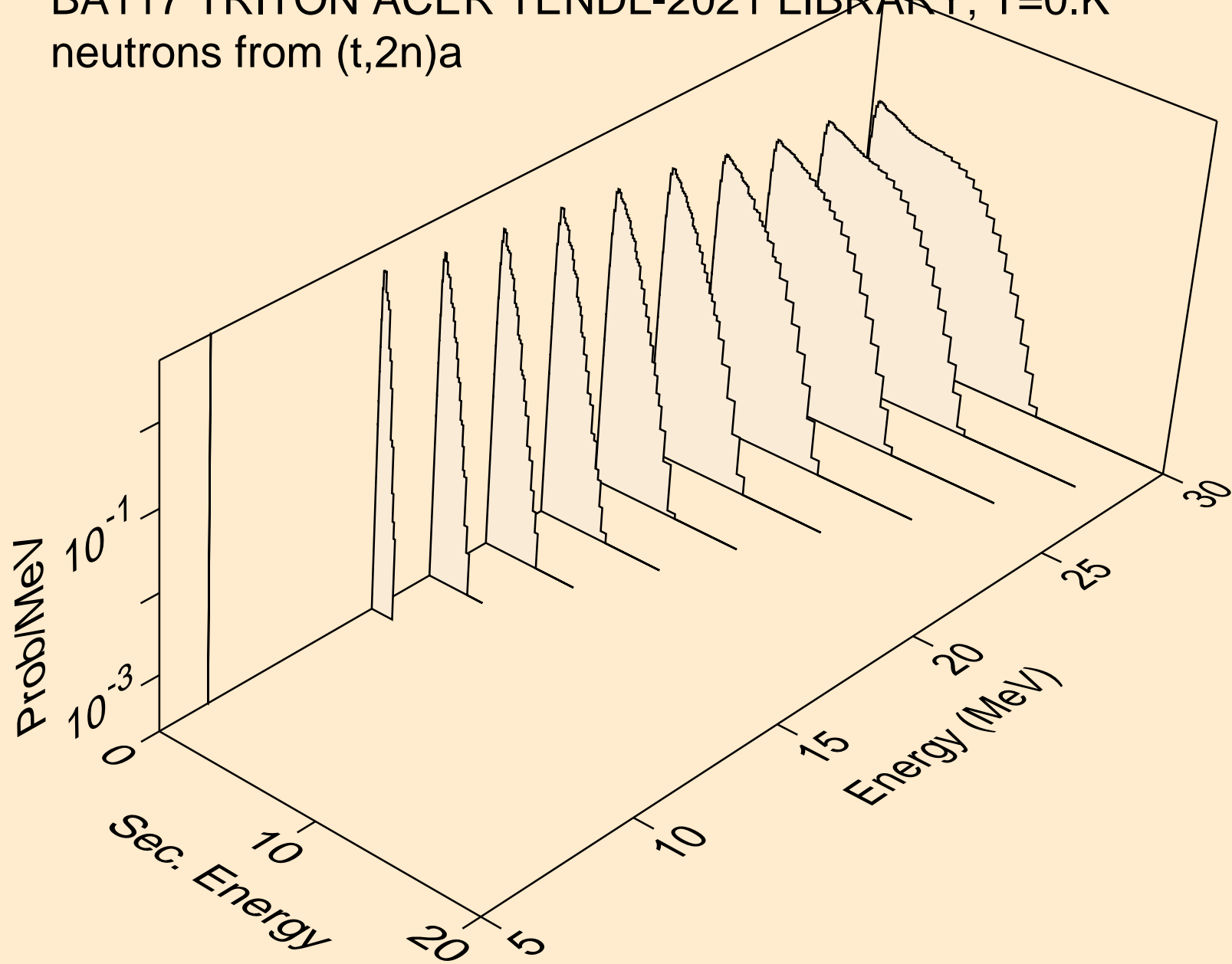



BA117 TRITON ACER TENDL-2021 LIBRARY; T=0.K  
neutrons from (t,n\*)p

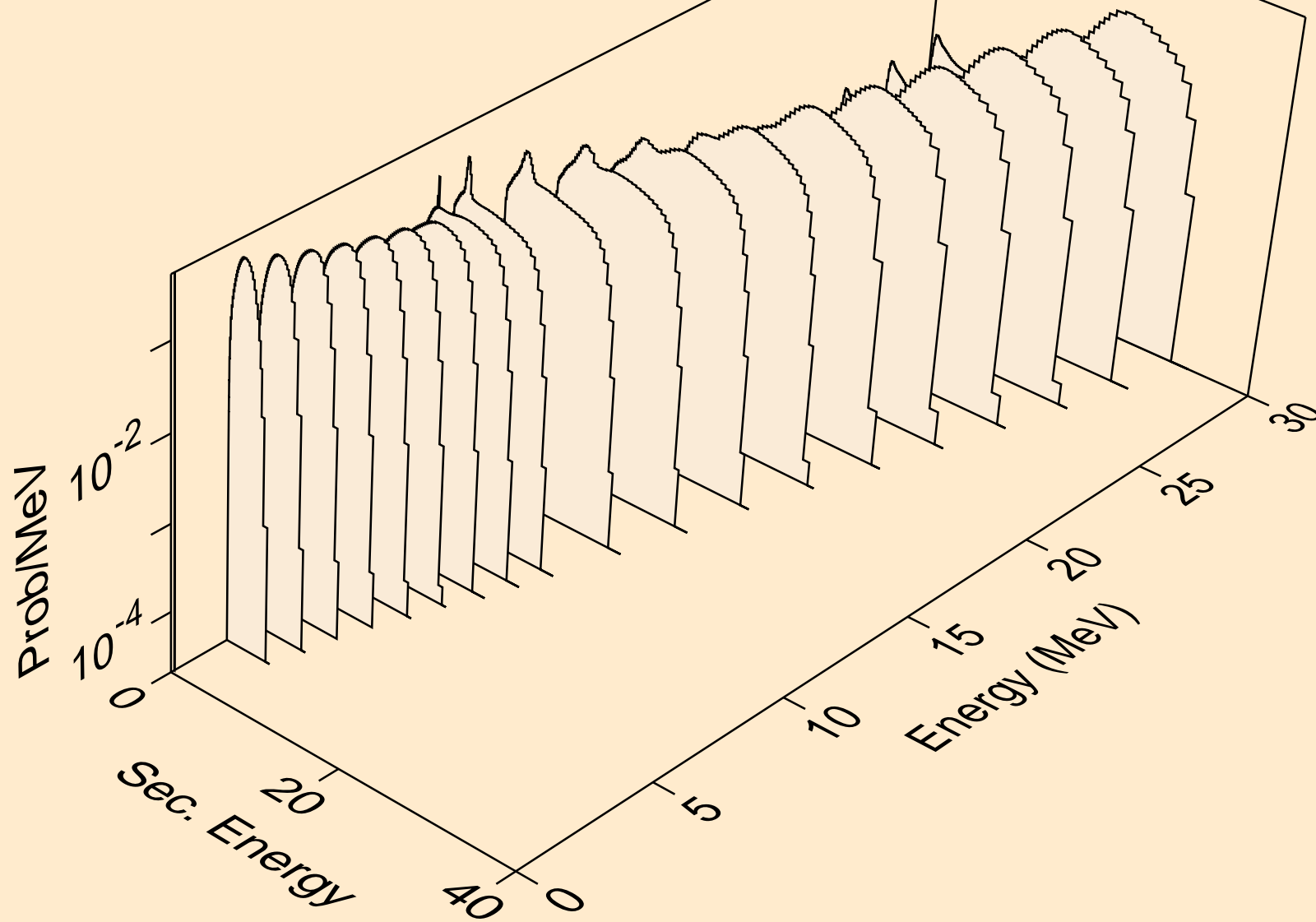

BA117 TRITON ACER TENDL-2021 LIBRARY; T=0.K  
neutrons from (t,n\*)2a

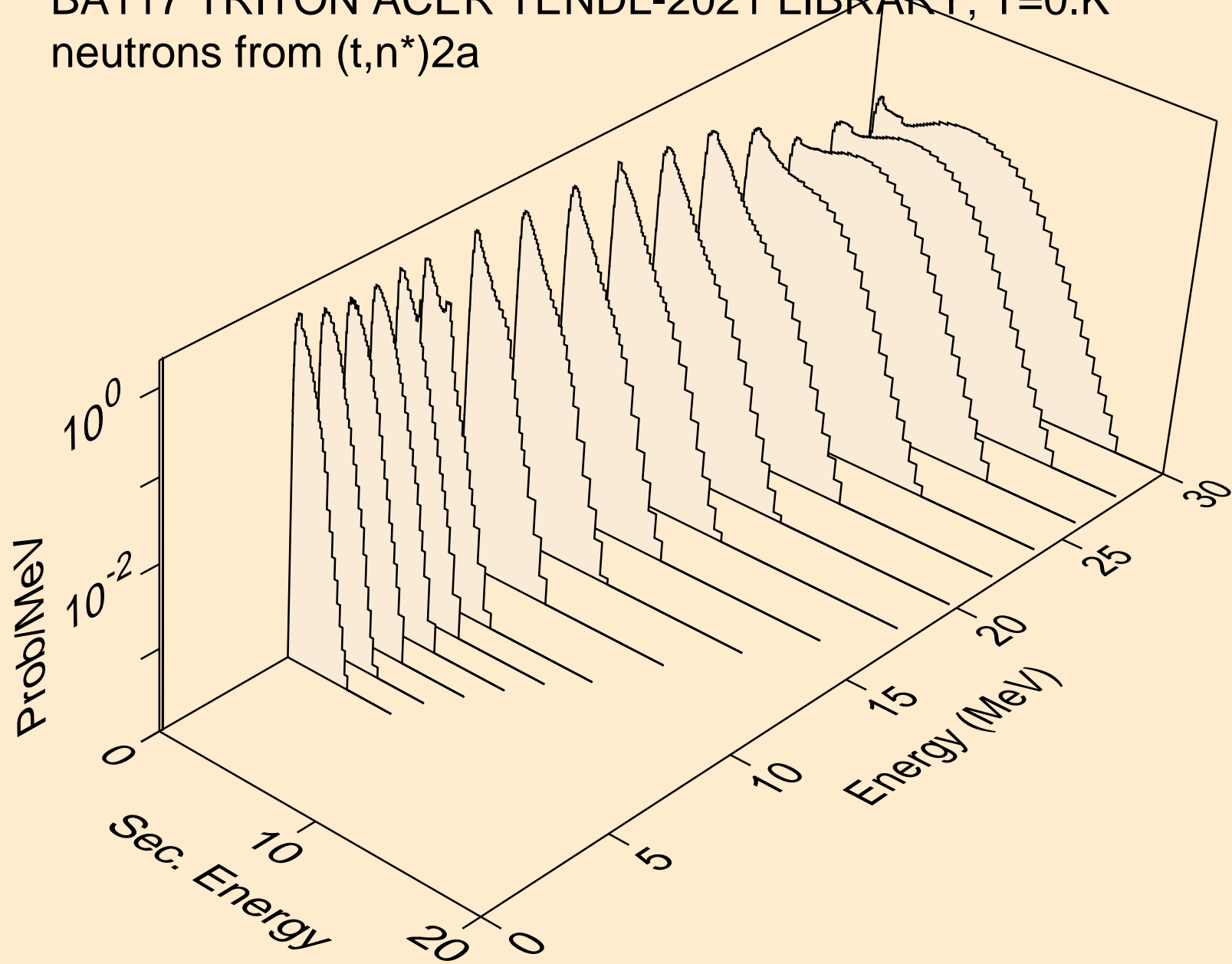

BA117 TRITON ACER TENDL-2021 LIBRARY; T=0.K  
neutrons from (t,n\*)d

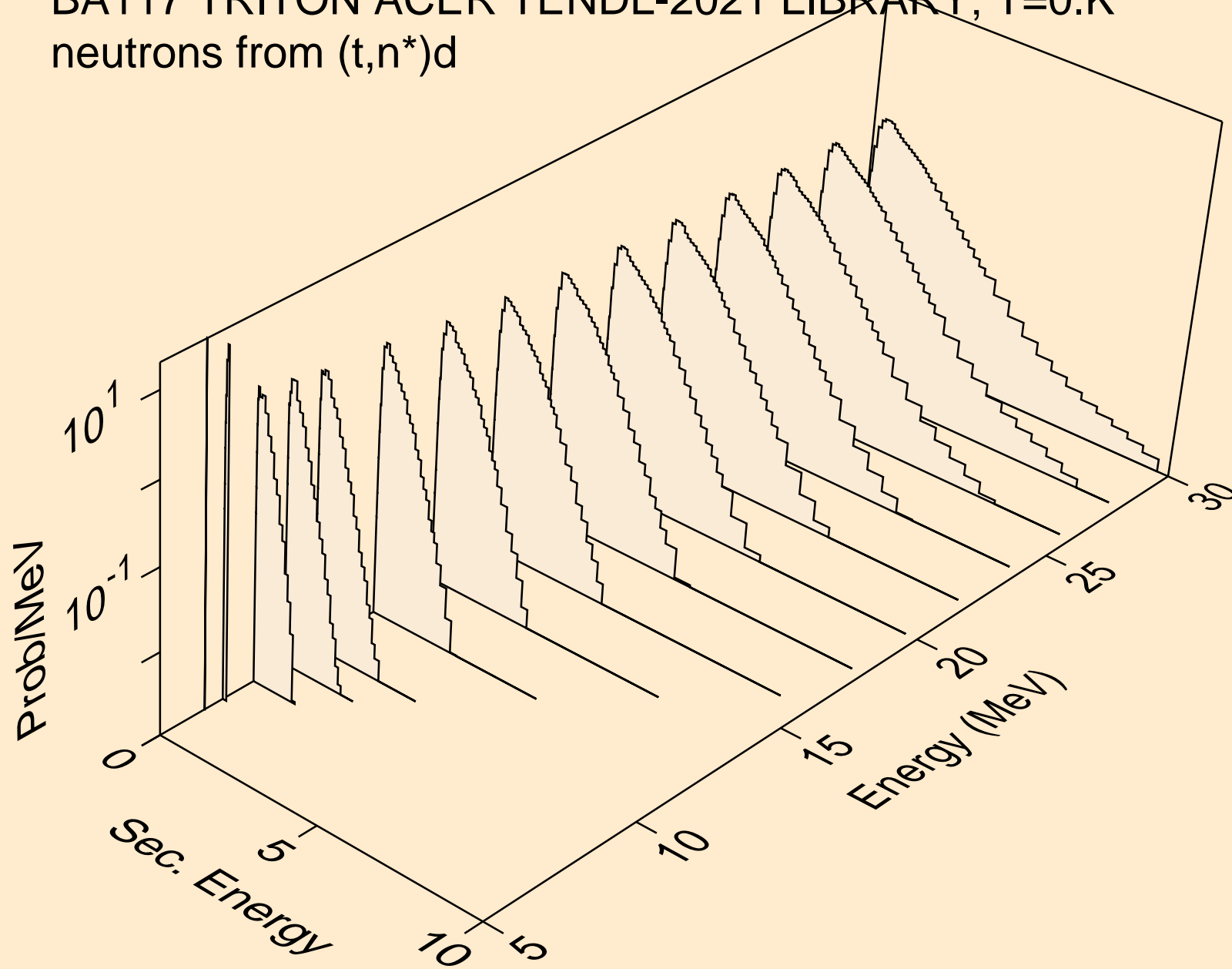

BA117 TRITON ACER TENDL-2021 LIBRARY; T=0.K  
neutrons from (t,n\*)t

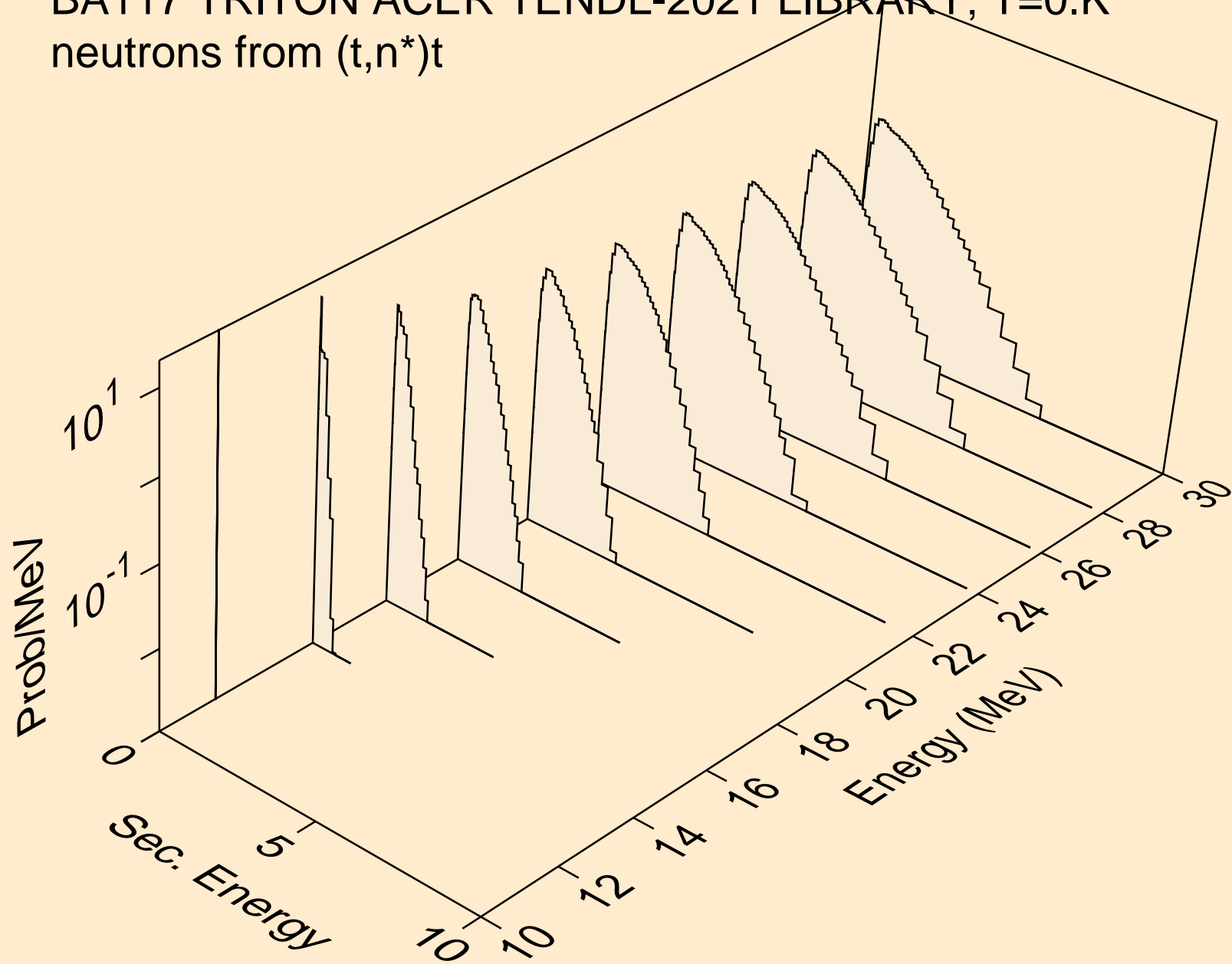

BA117 TRITON ACER TENDL-2021 LIBRARY; T=0.K  
neutrons from (t,n\*)he3

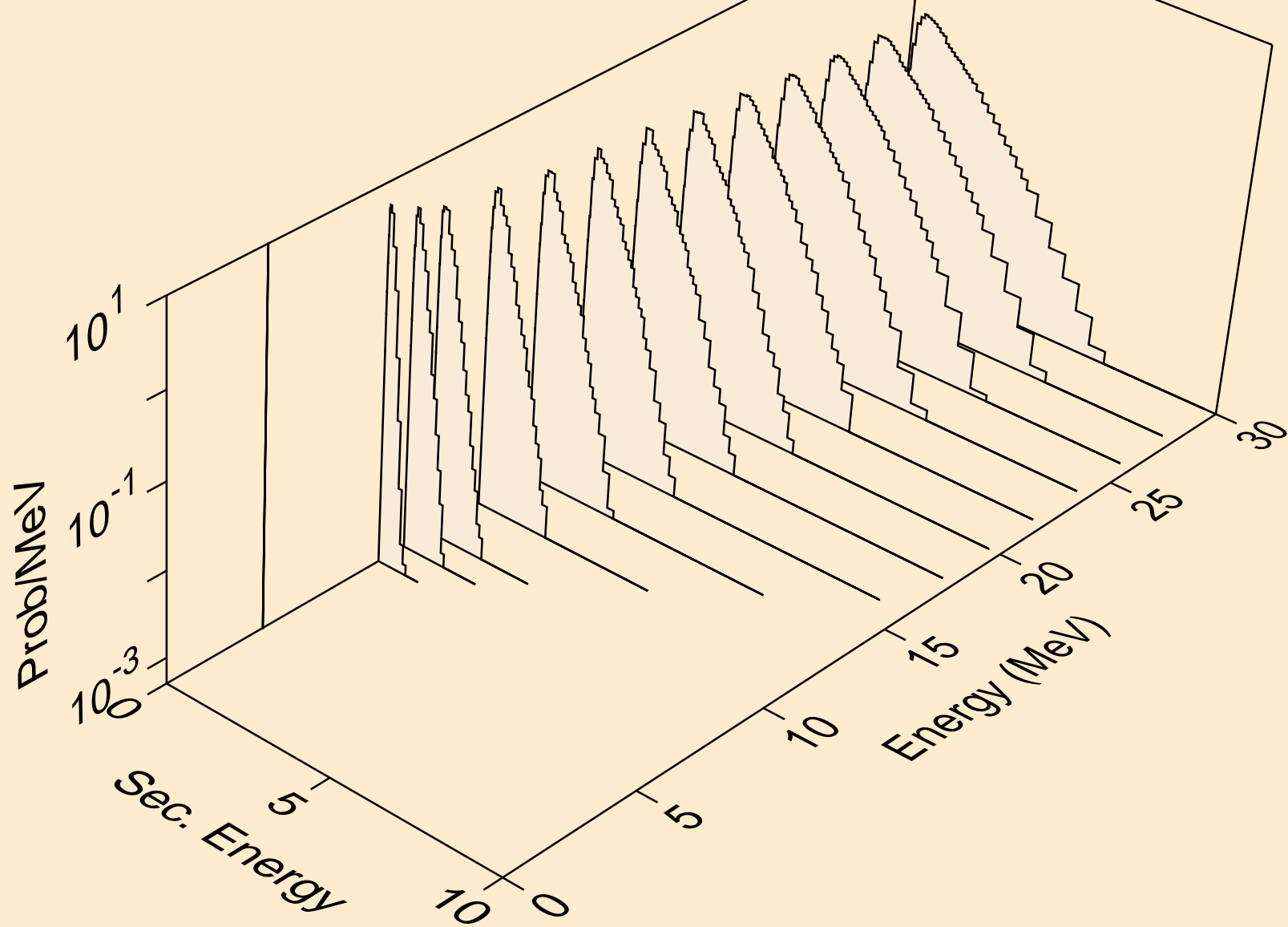

BA117 TRITON ACER TENDL-2021 LIBRARY; T=0.K  
neutrons from (t,2np)

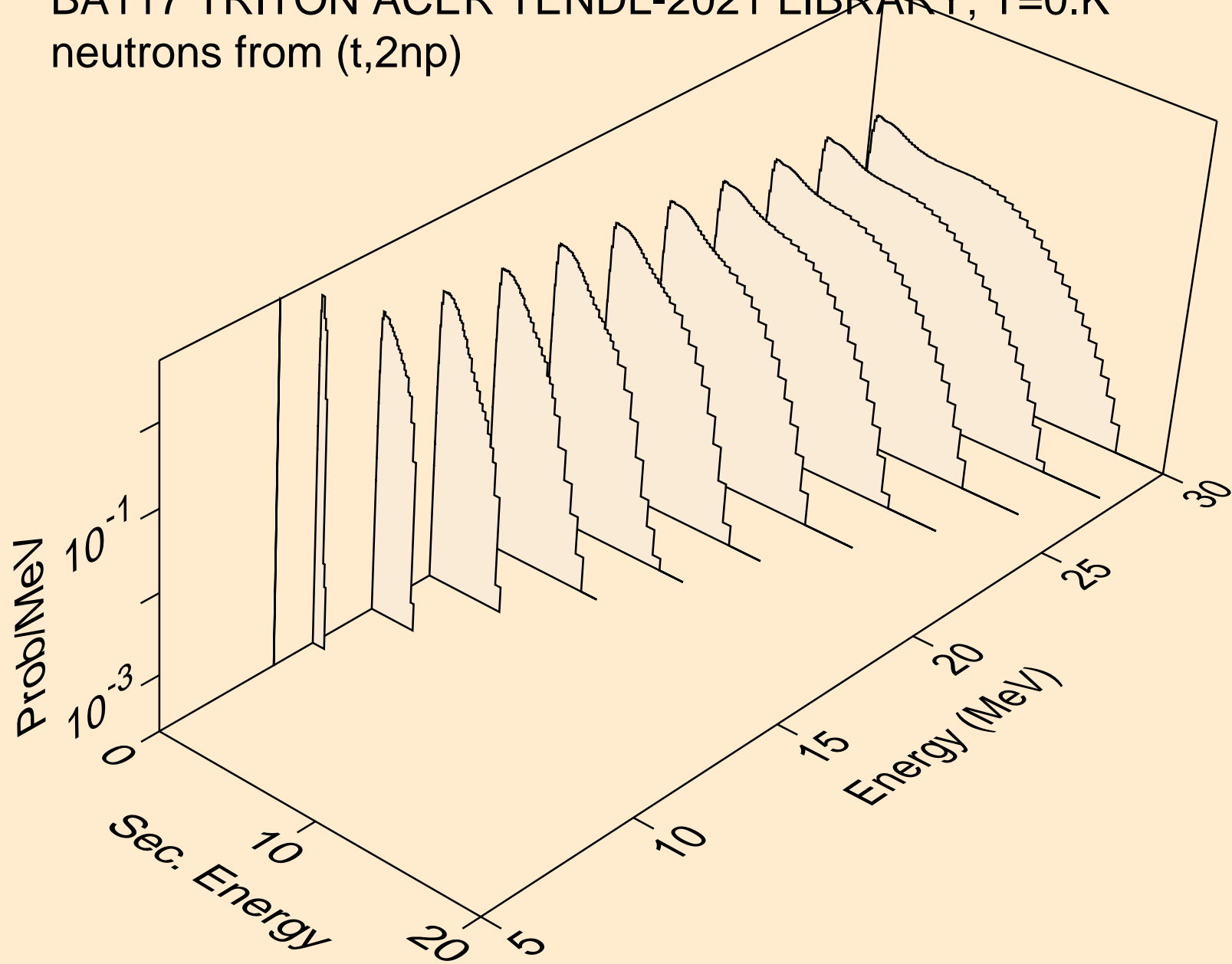

BA117 TRITON ACER TENDL-2021 LIBRARY; T=0.K  
neutrons from (t,3np)

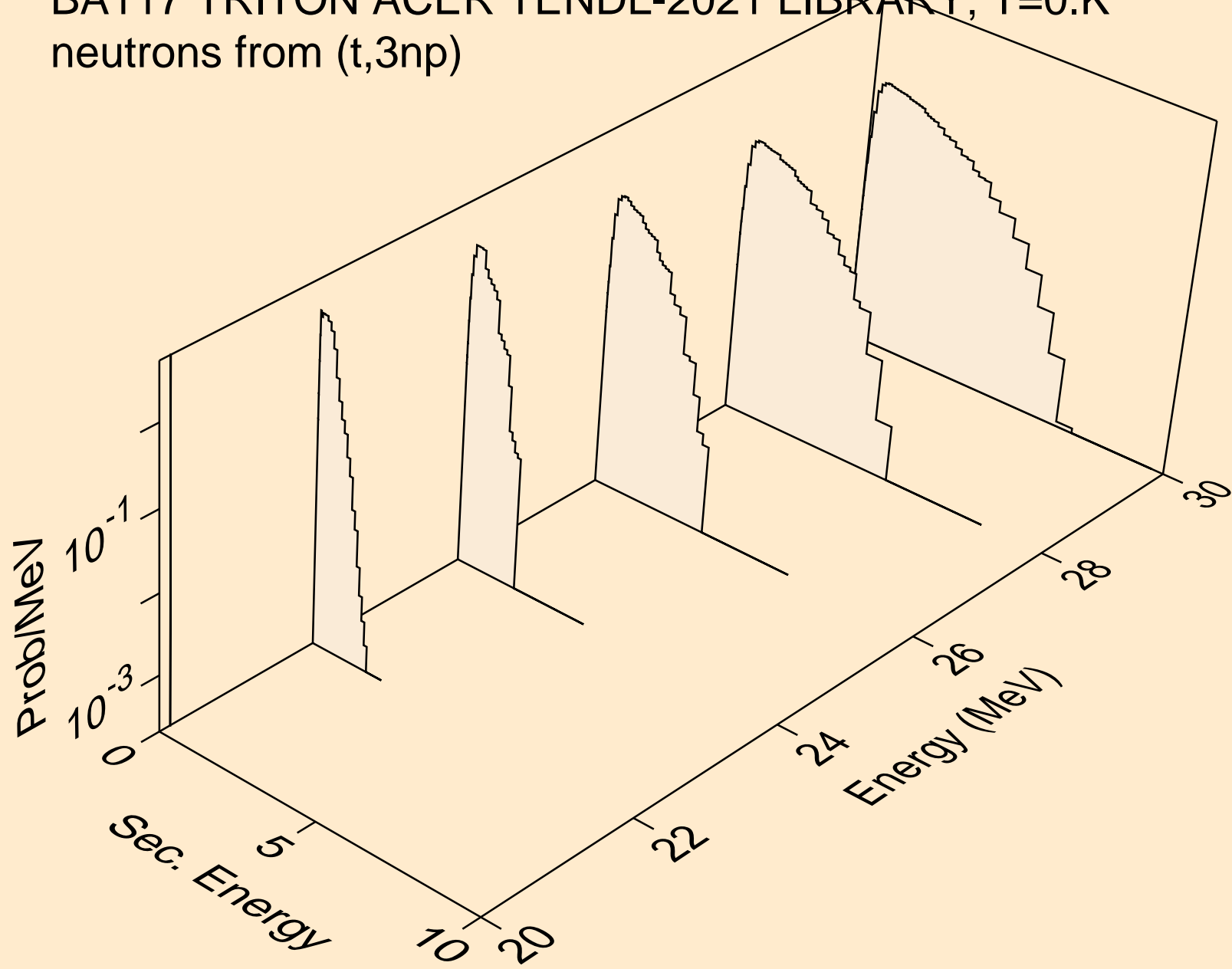

BA117 TRITON ACER TENDL-2021 LIBRARY; T=0.K  
neutrons from (t,2np)

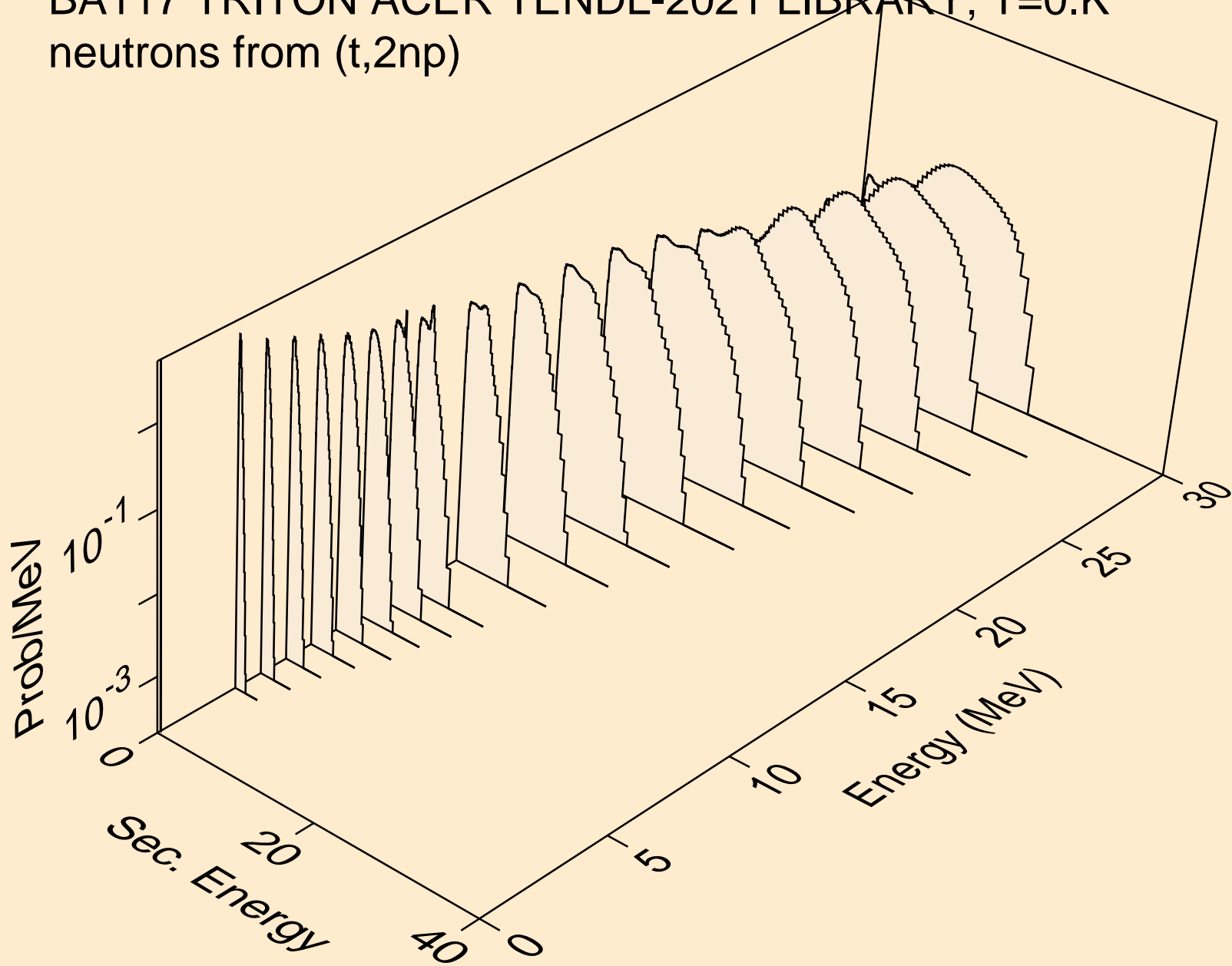



BA117 TRITON ACER TENDL-2021 LIBRARY; T=0.K  
neutrons from (t,npa)

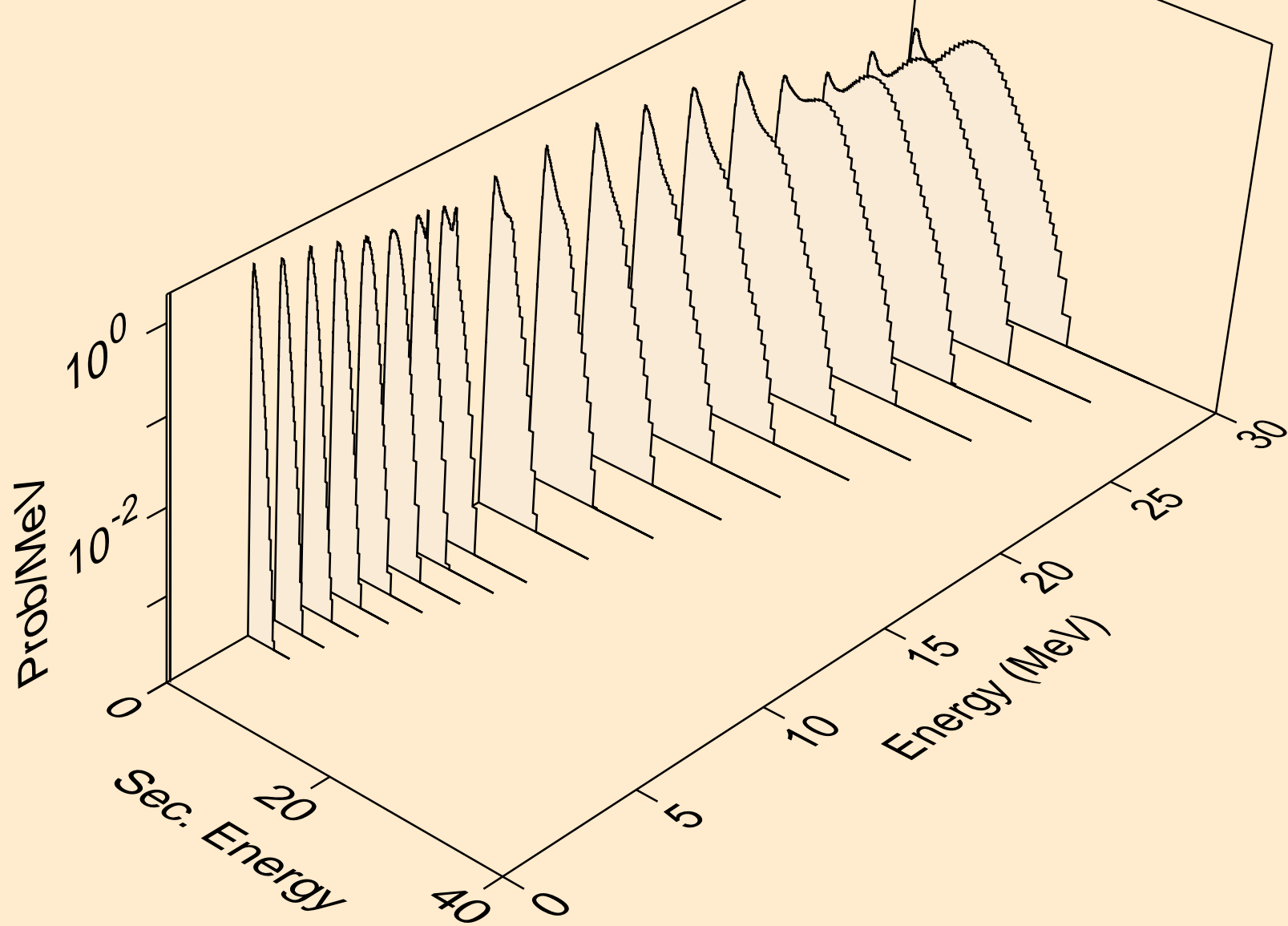

BA117 TRITON ACER TENDL-2021 LIBRARY; T=0.K  
protons from (t,x)

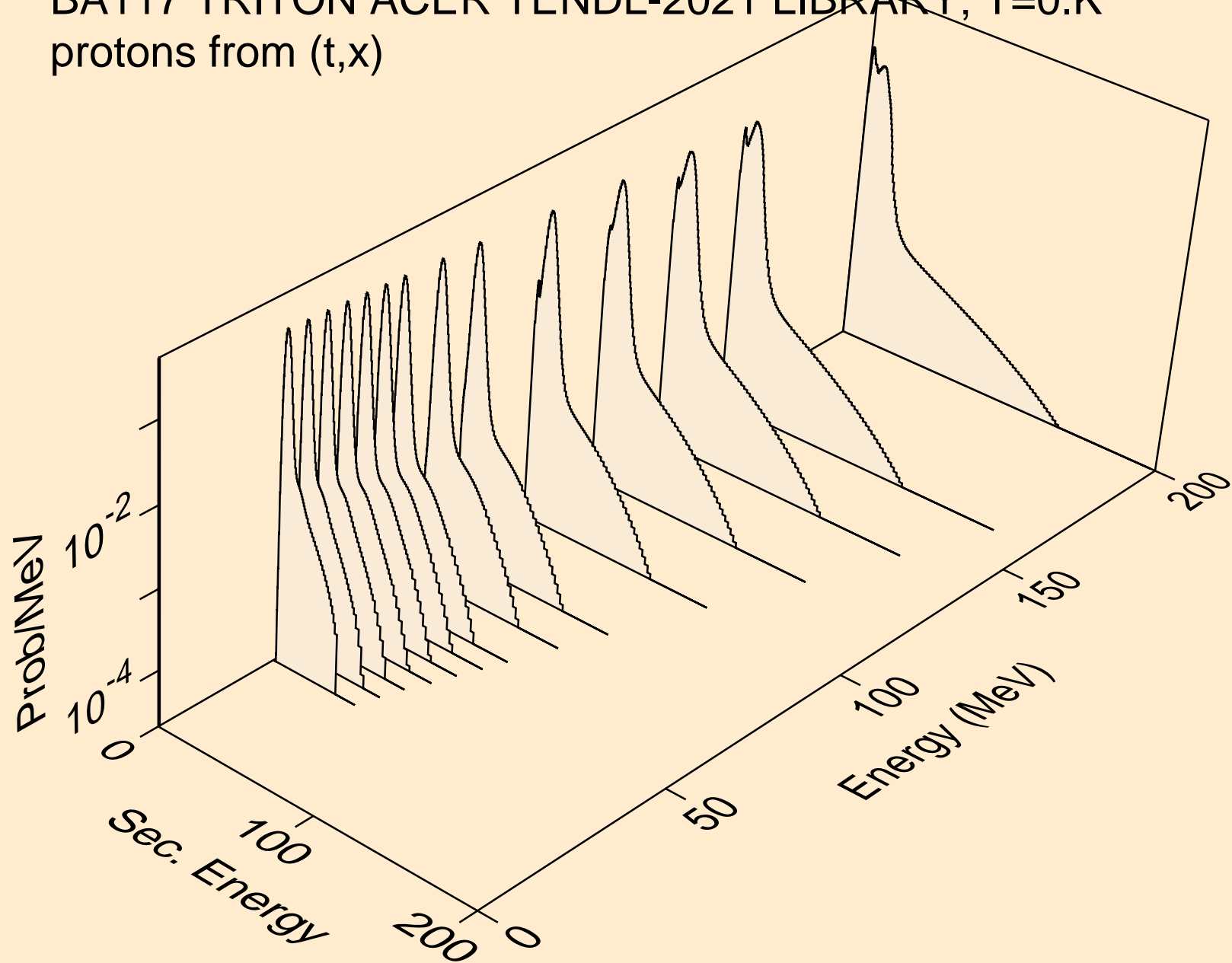

BA117 TRITON ACER TENDL-2021 LIBRARY; T=0.K  
protons from (t,n\*)p

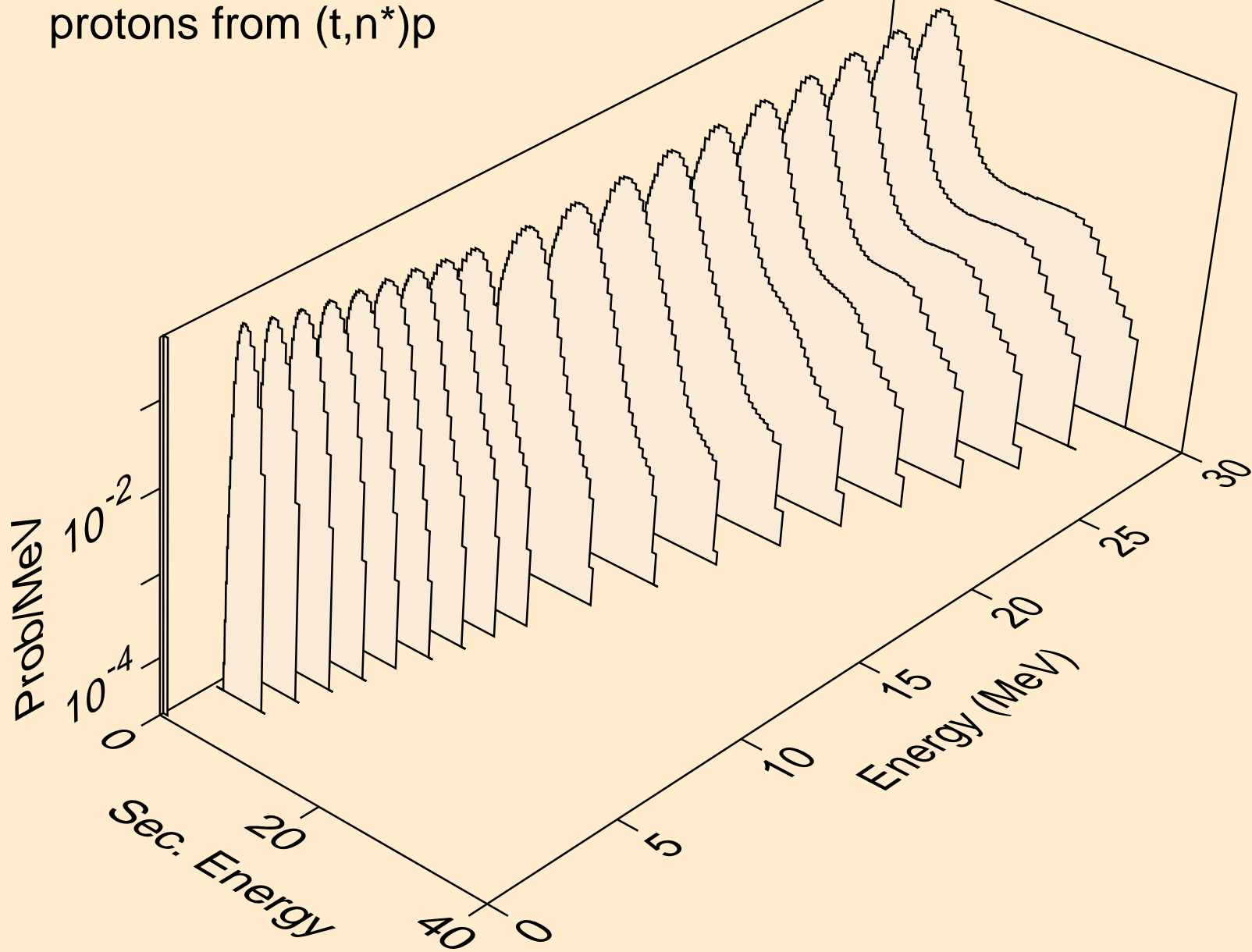

BA117 TRITON ACER TENDL-2021 LIBRARY; T=0.K  
protons from (t,2np)

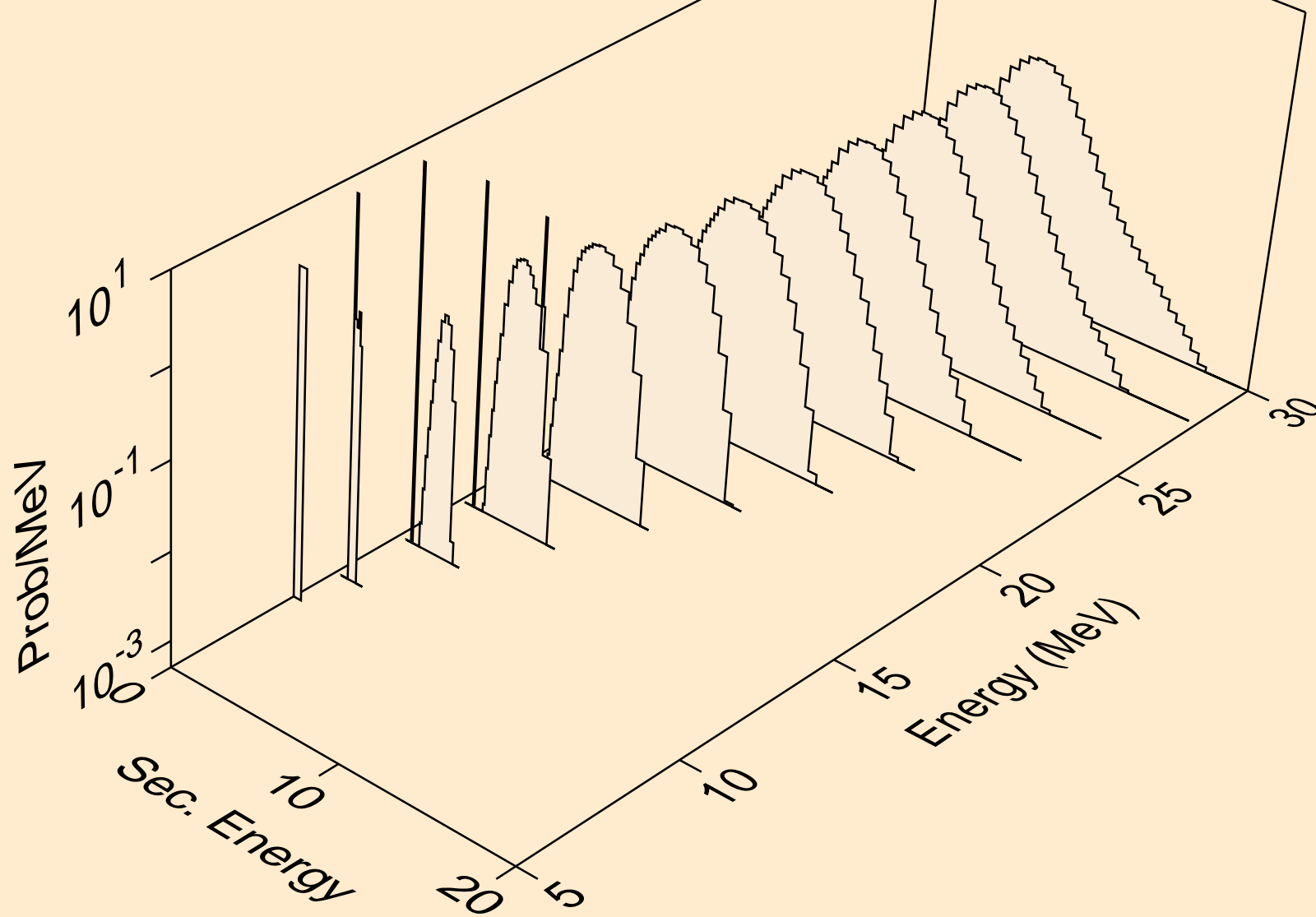

BA117 TRITON ACER TENDL-2021 LIBRARY; T=0.K  
protons from (t,3np)

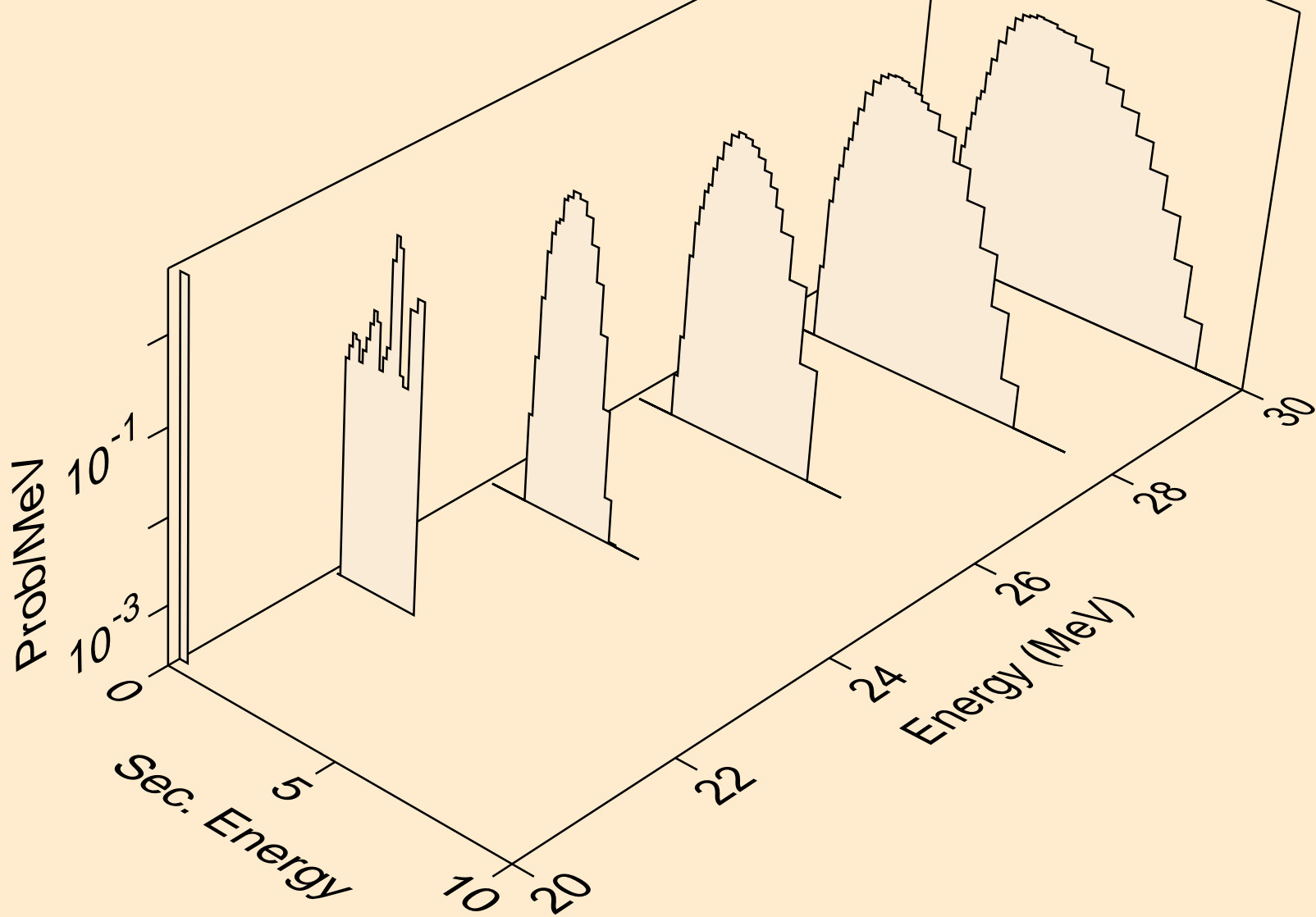

BA117 TRITON ACER TENDL-2021 LIBRARY; T=0.K  
protons from (t,2np)

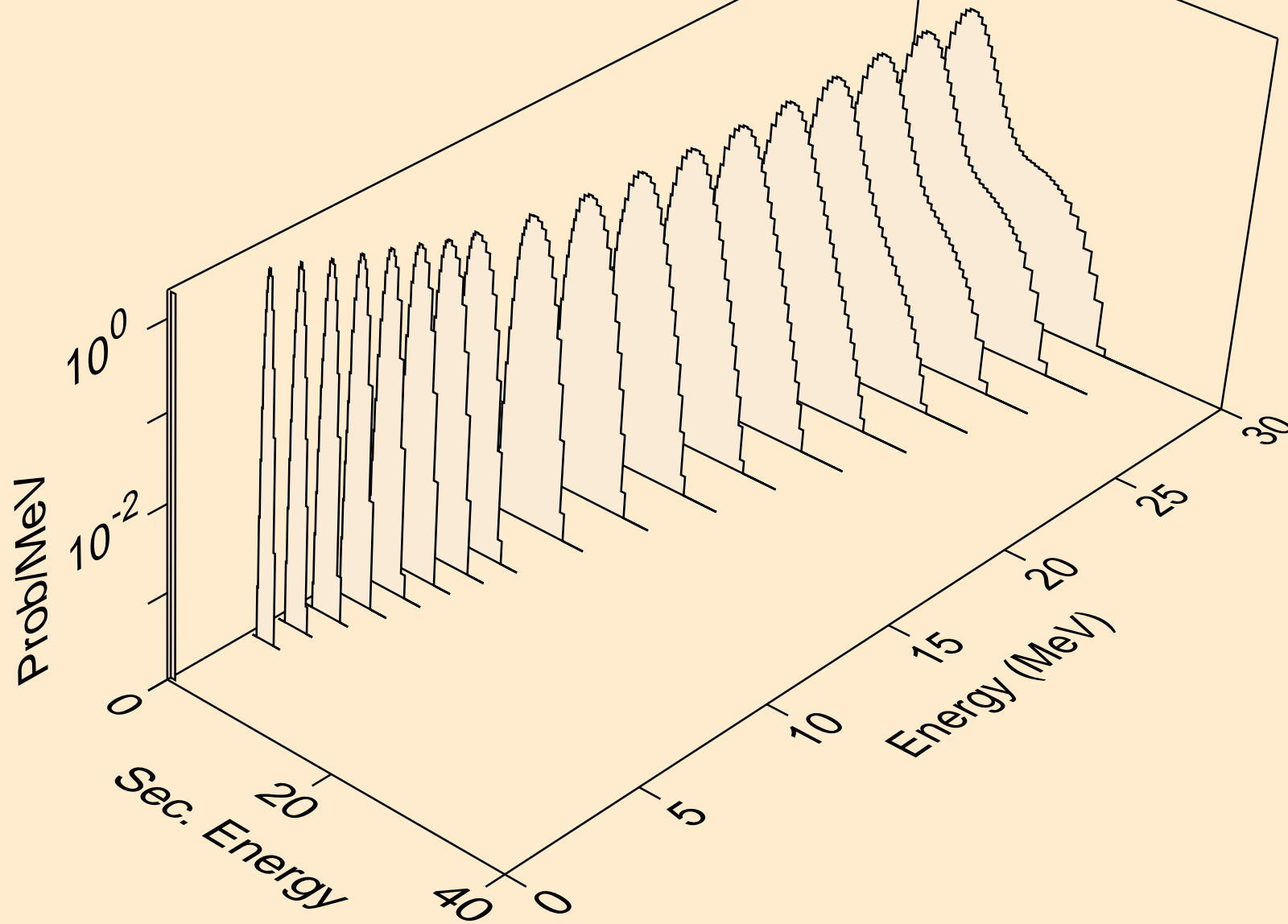

BA117 TRITON ACER TENDL-2021 LIBRARY; T=0.K  
protons from (t,npa)

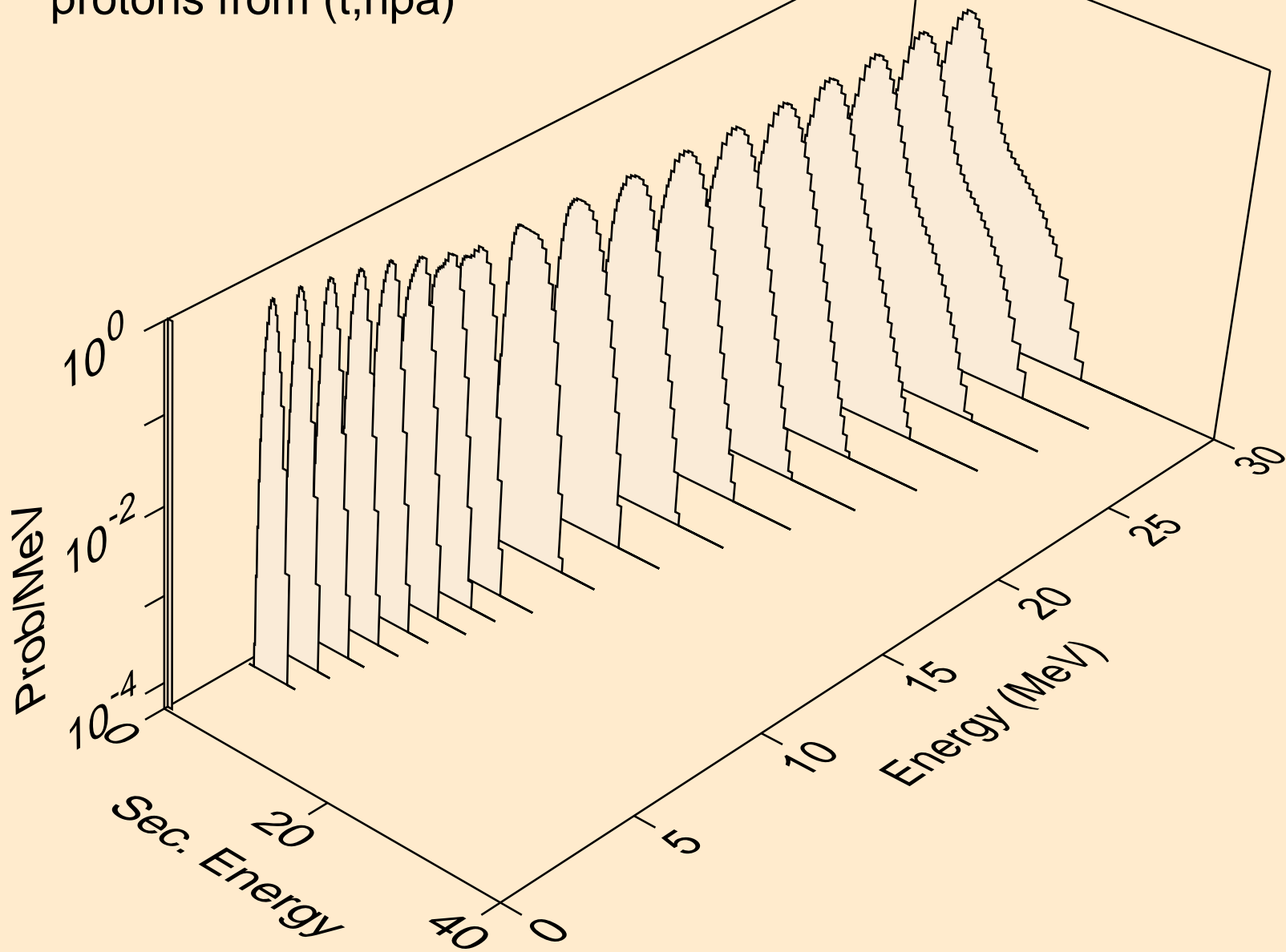

BA117 TRITON ACER TENDL-2021 LIBRARY; T=0.K  
protons from (t,p)

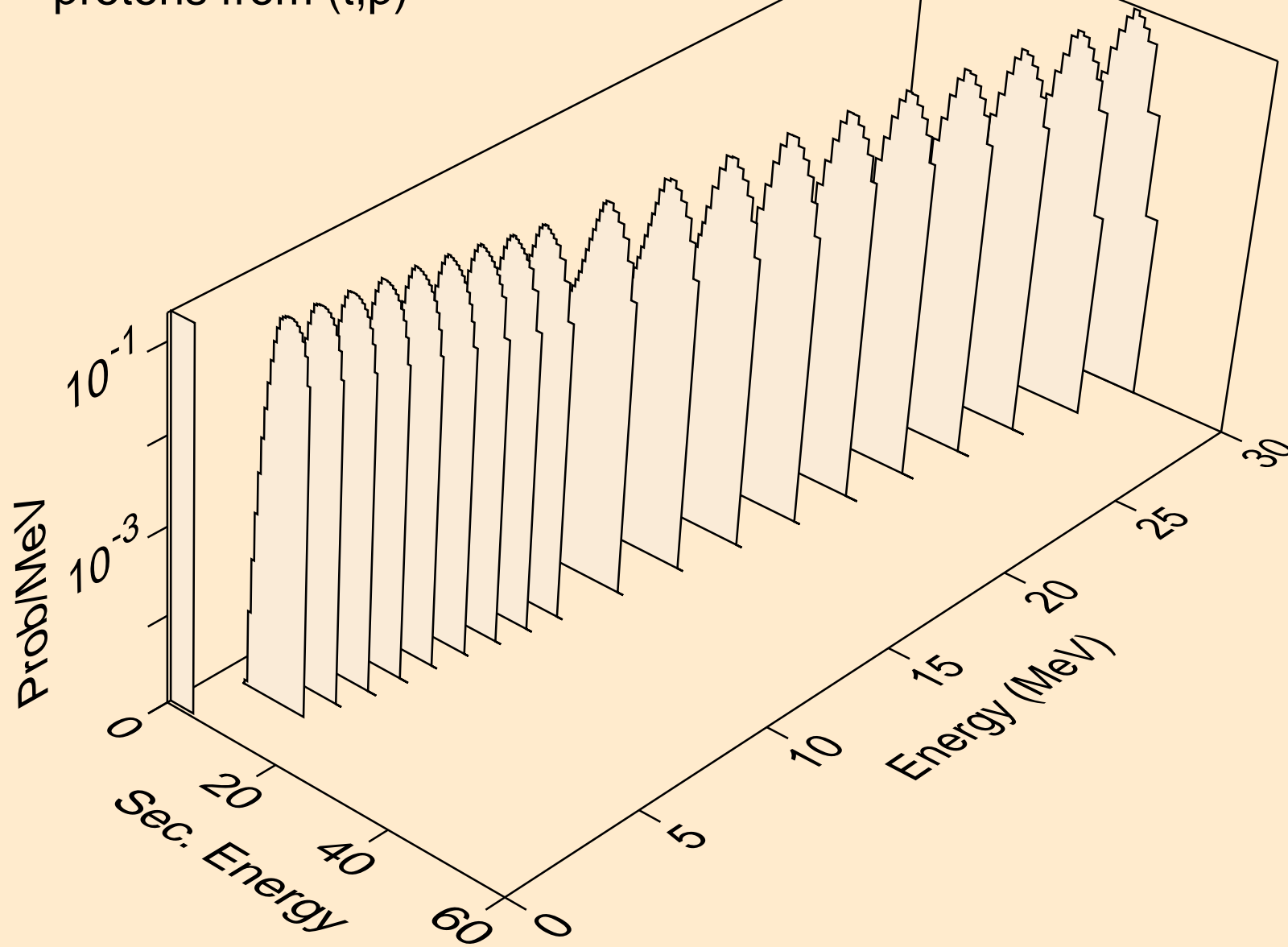



BA117 TRITON ACER TENDL-2021 LIBRARY; T=0.K  
protons from (t,2p)

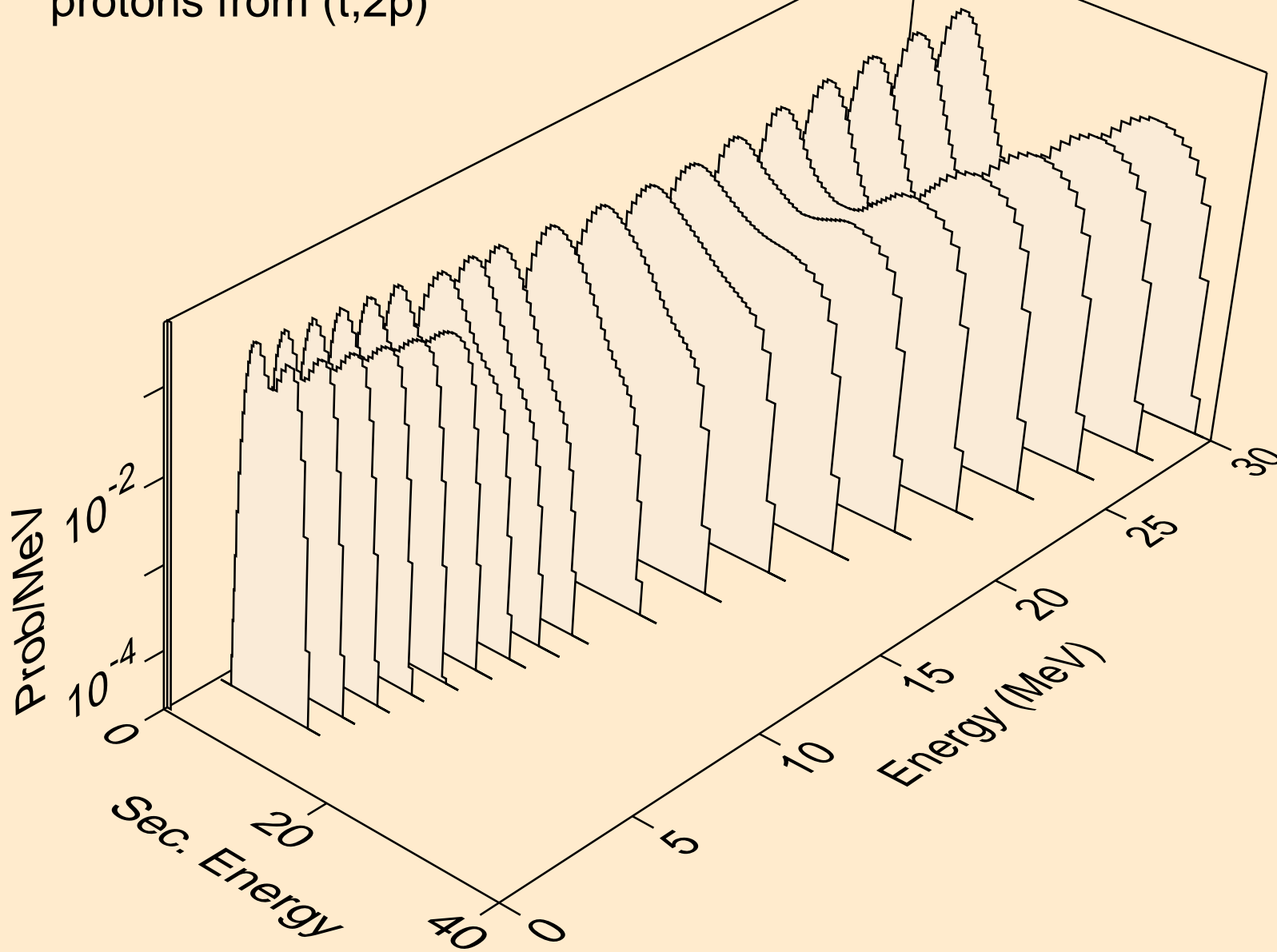

BA117 TRITON ACER TENDL-2021 LIBRARY; T=0.K  
protons from (t,pa)

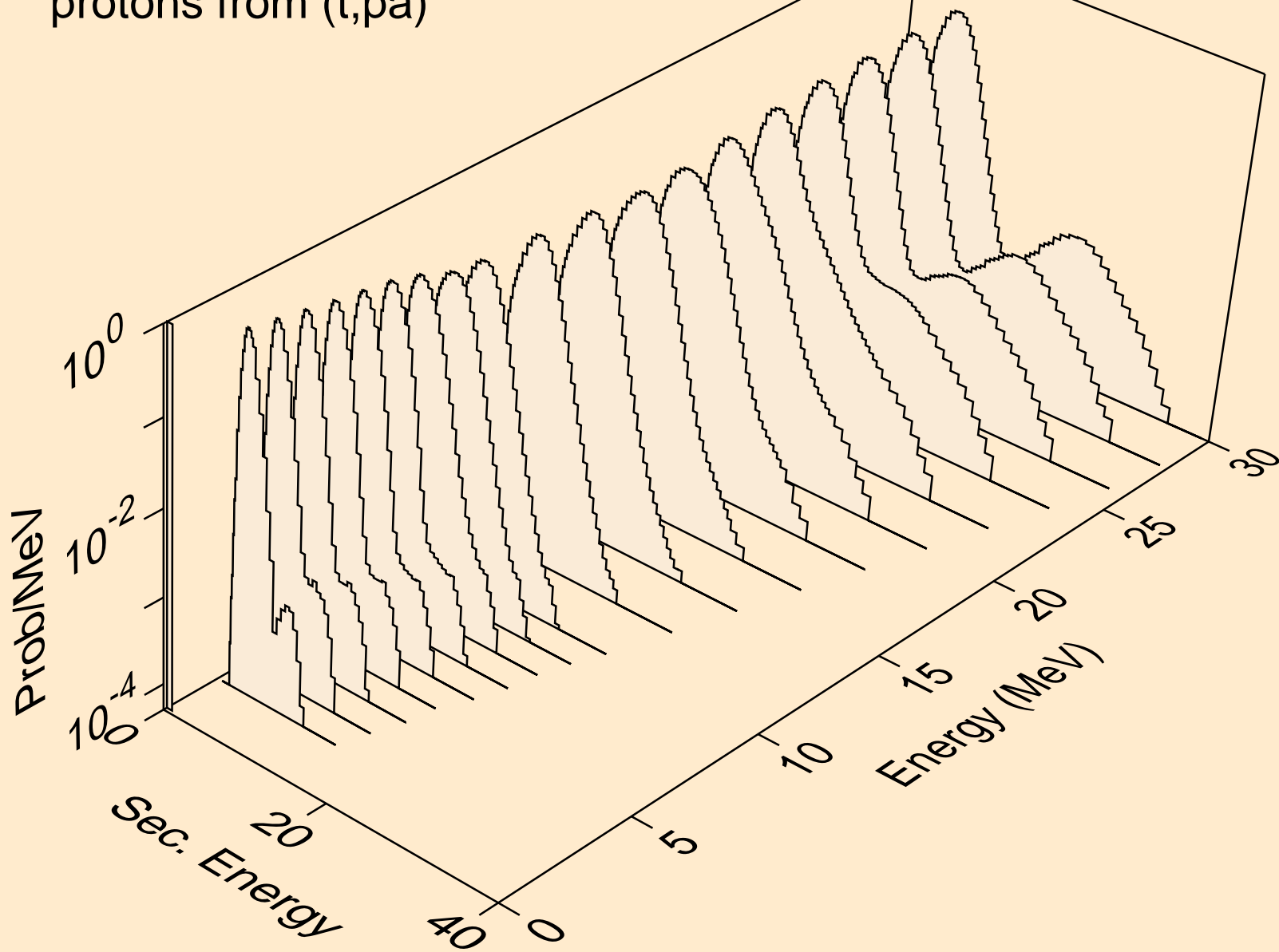

BA117 TRITON ACER TENDL-2021 LIBRARY; T=0.K  
protons from (t,pd)

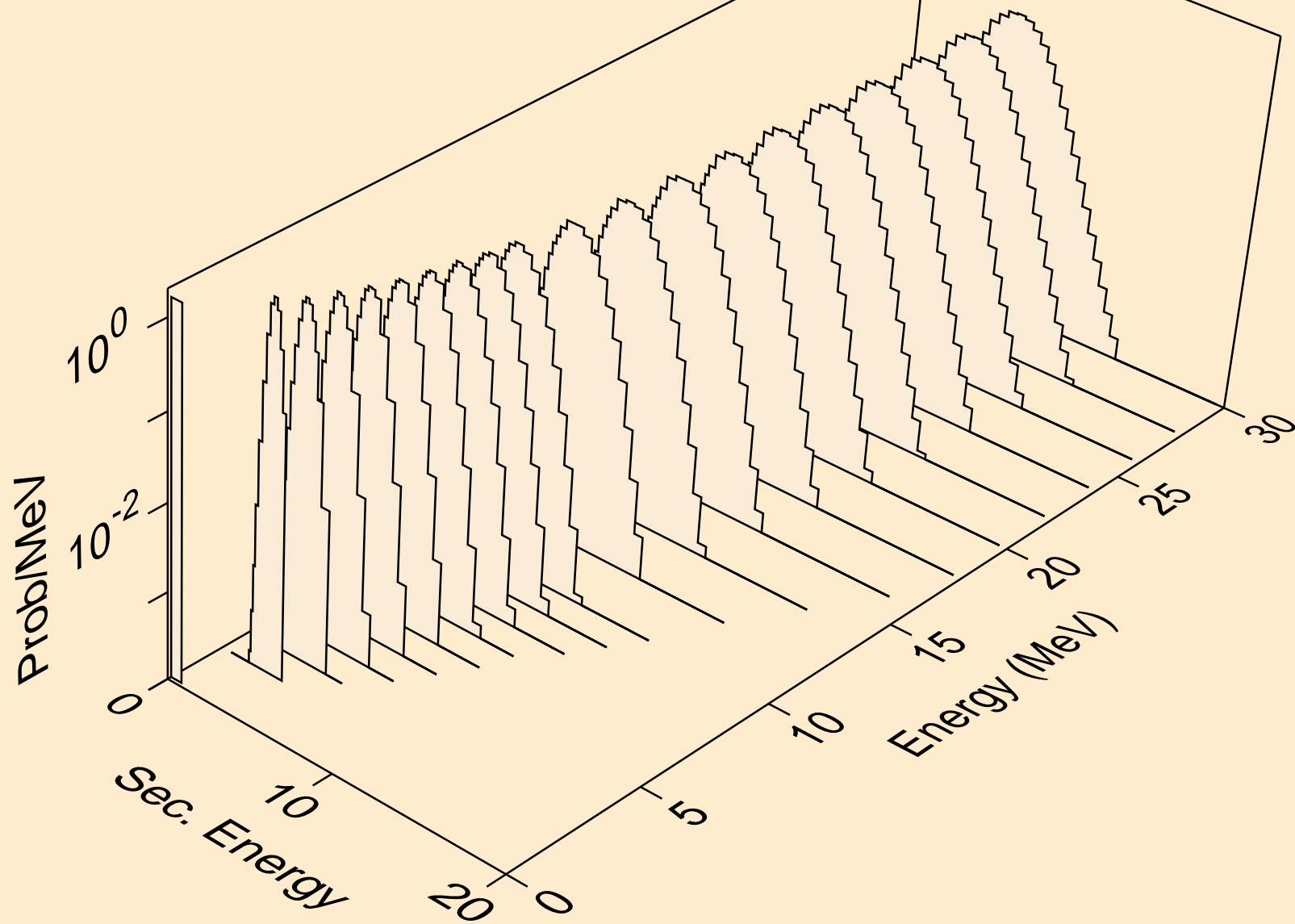

BA117 TRITON ACER TENDL-2021 LIBRARY; T=0.K  
protons from (t,pt)

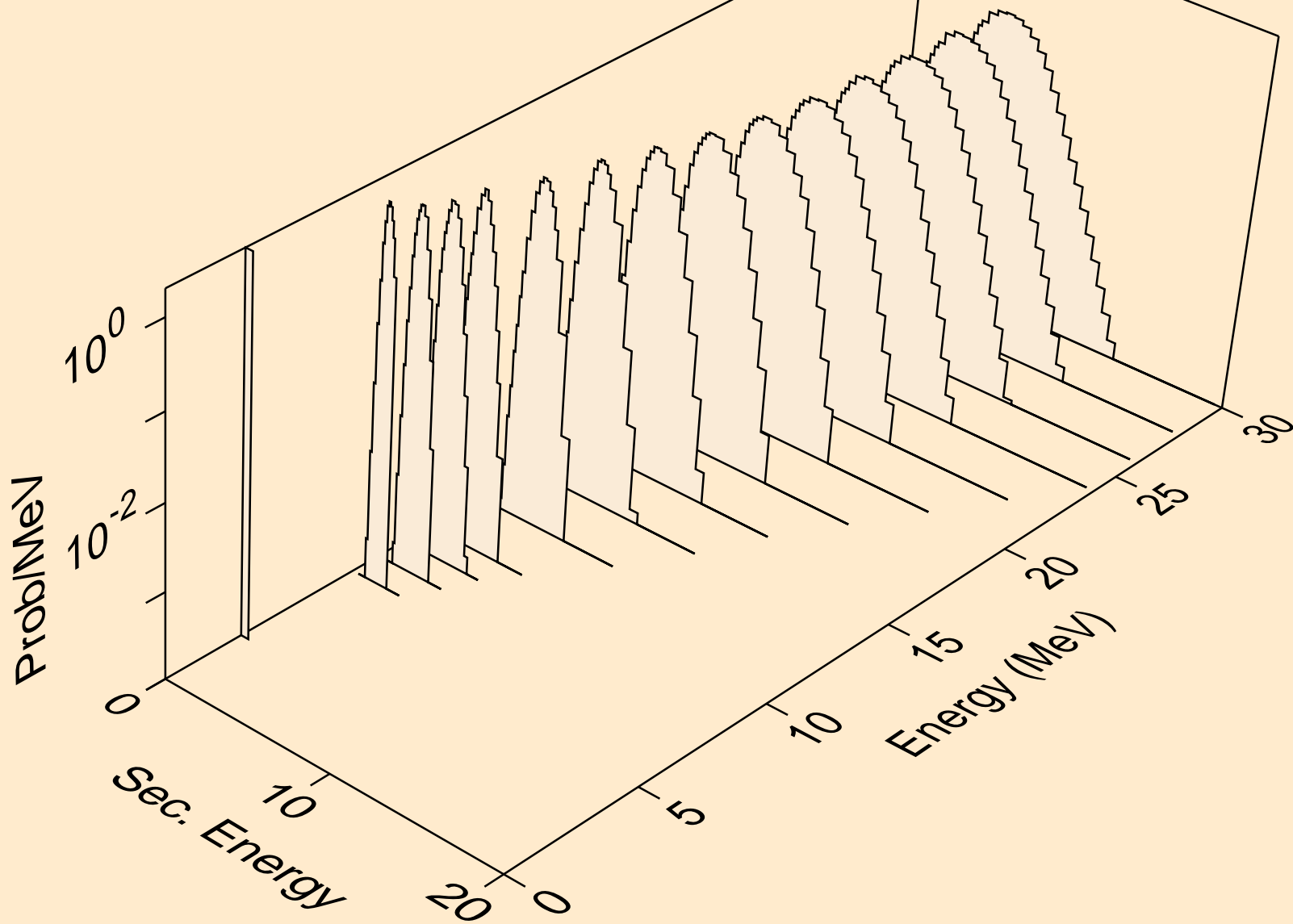

BA117 TRITON ACER TENDL-2021 LIBRARY; T=0.K  
deuterons from (t,x)

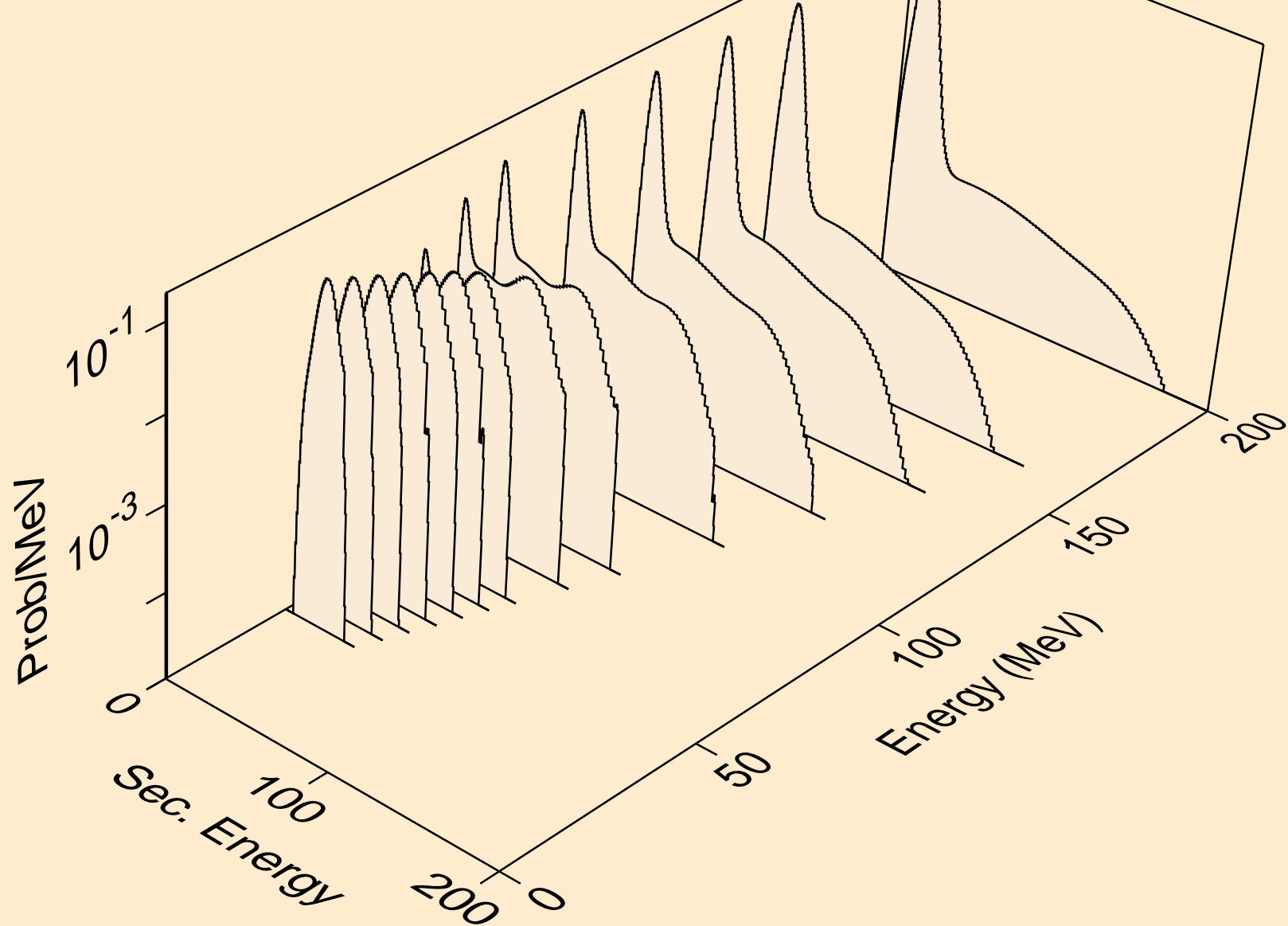

BA117 TRITON ACER TENDL-2021 LIBRARY; T=0.K  
deuterons from (t,2nd)

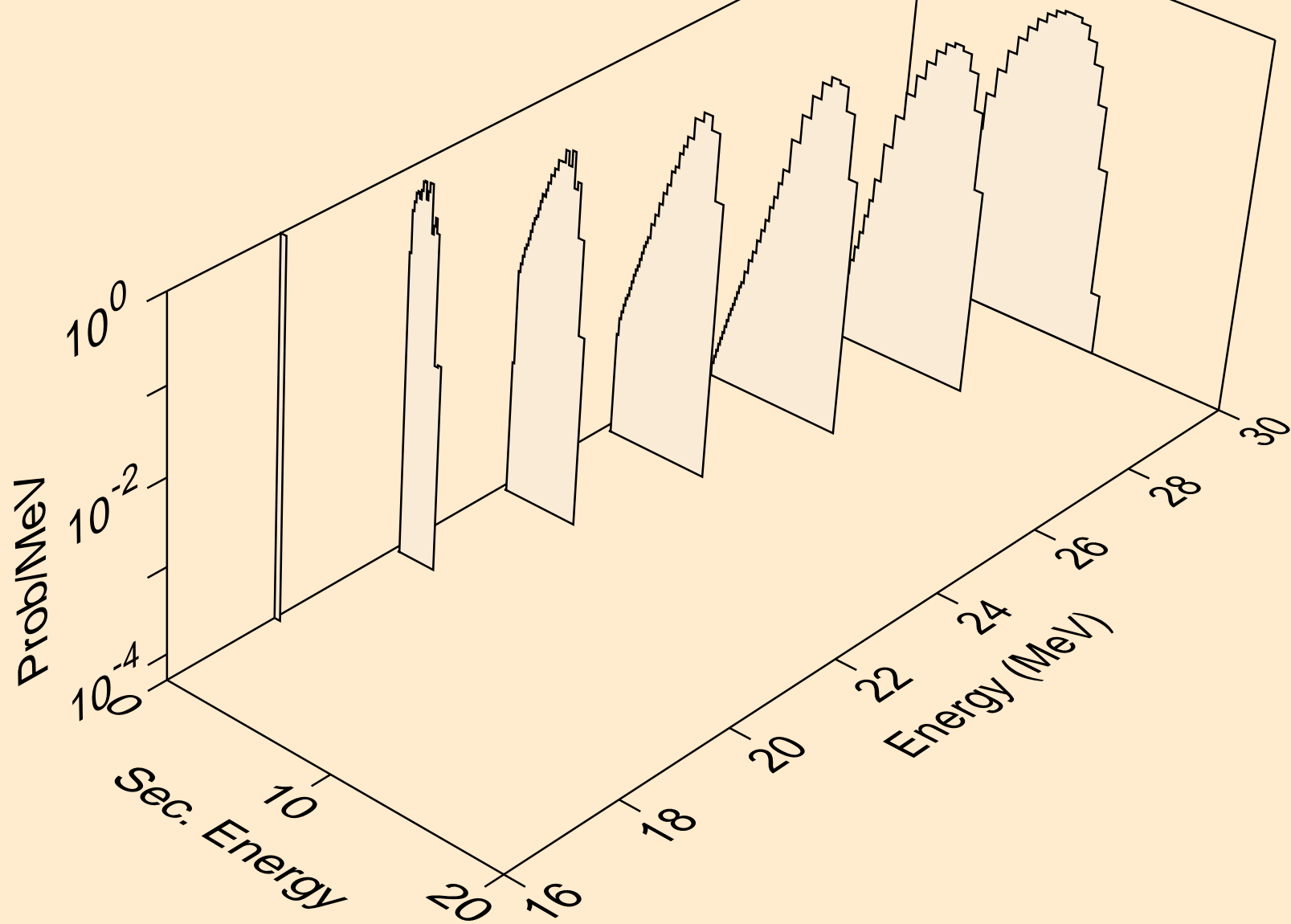

BA117 TRITON ACER TENDL-2021 LIBRARY; T=0.K  
deuterons from (t,n\*)d

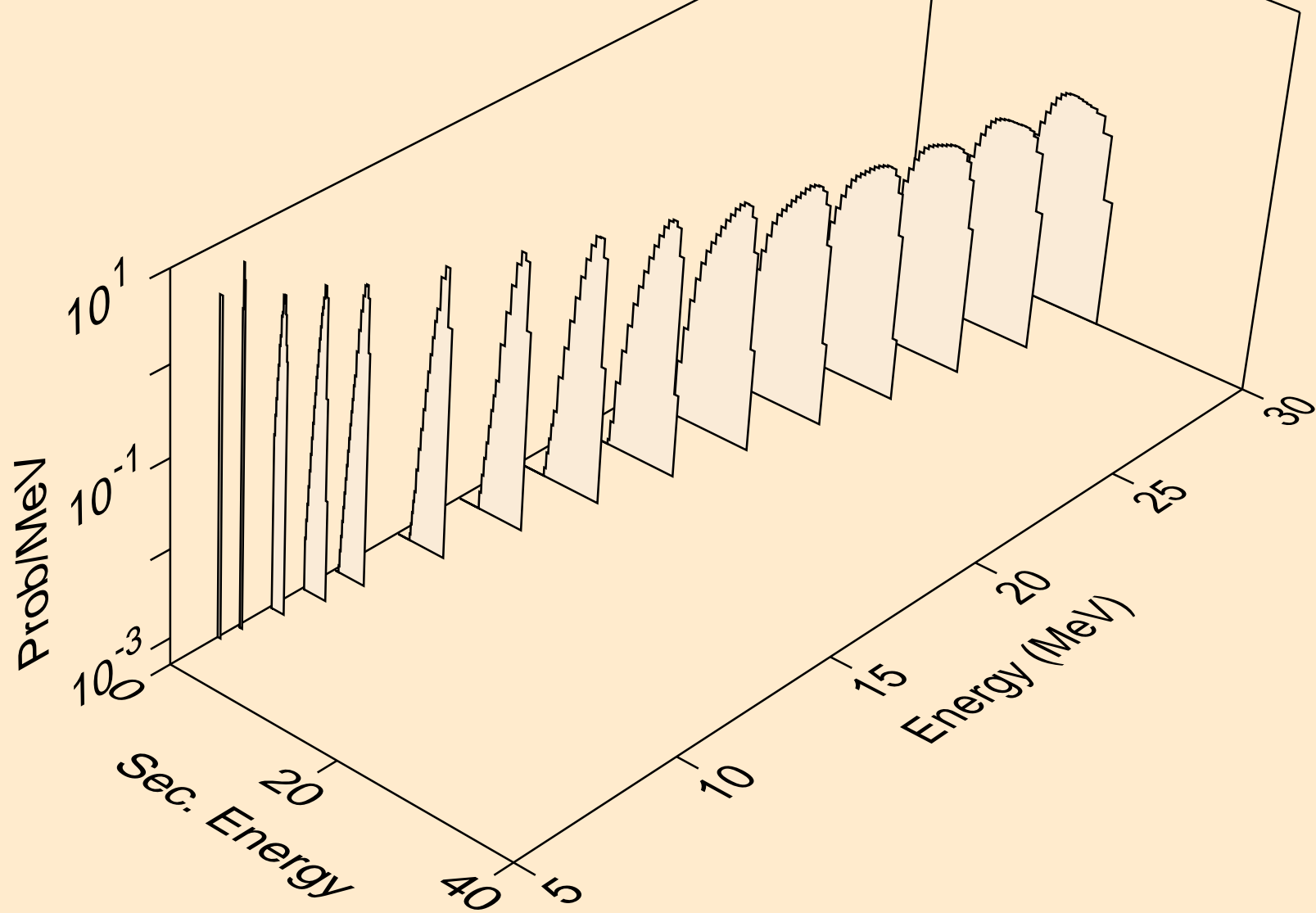

BA117 TRITON ACER TENDL-2021 LIBRARY; T=0.K  
deuterons from (t,d)

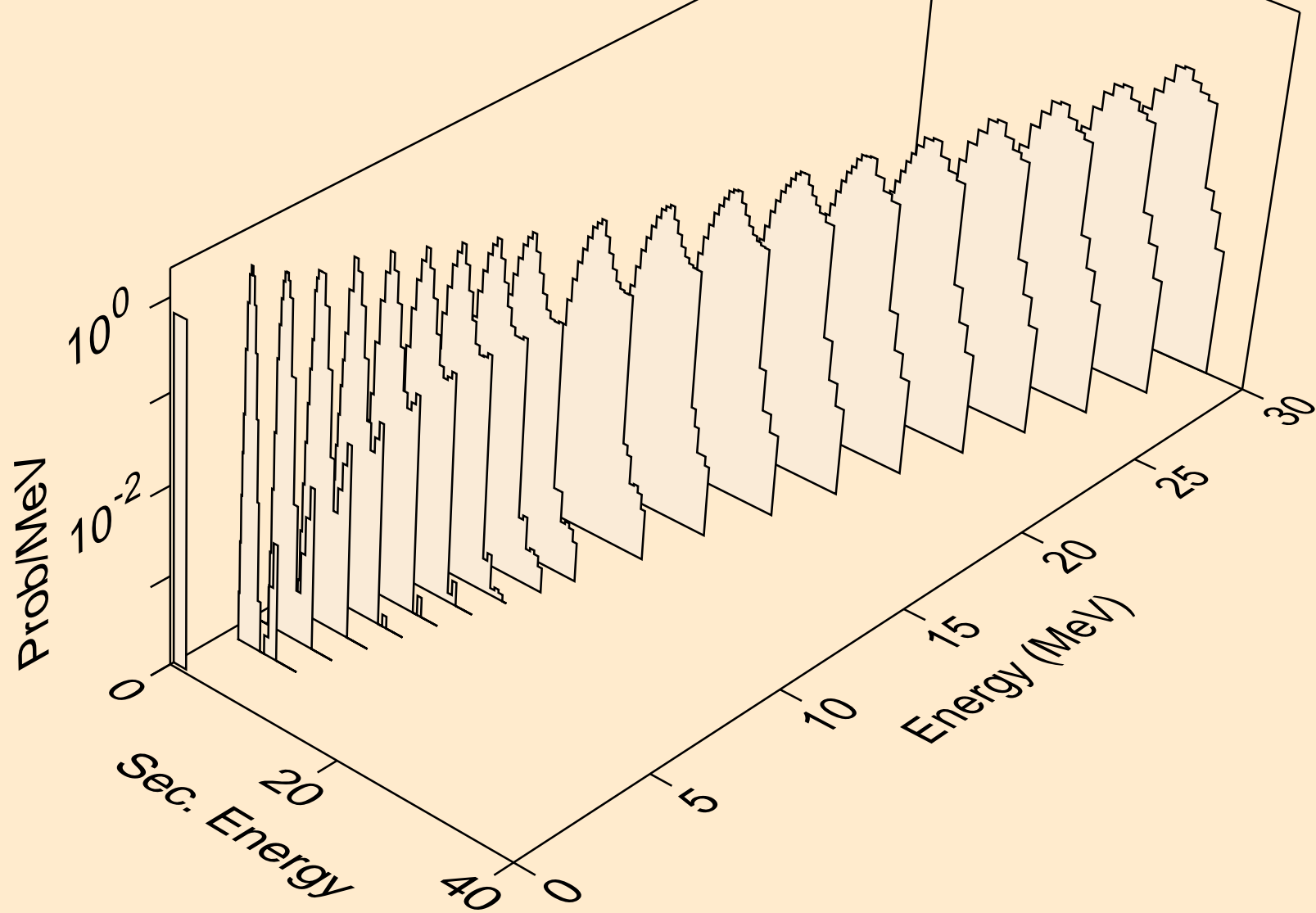



BA117 TRITON ACER TENDL-2021 LIBRARY; T=0.K  
deuterons from (t,d2a)

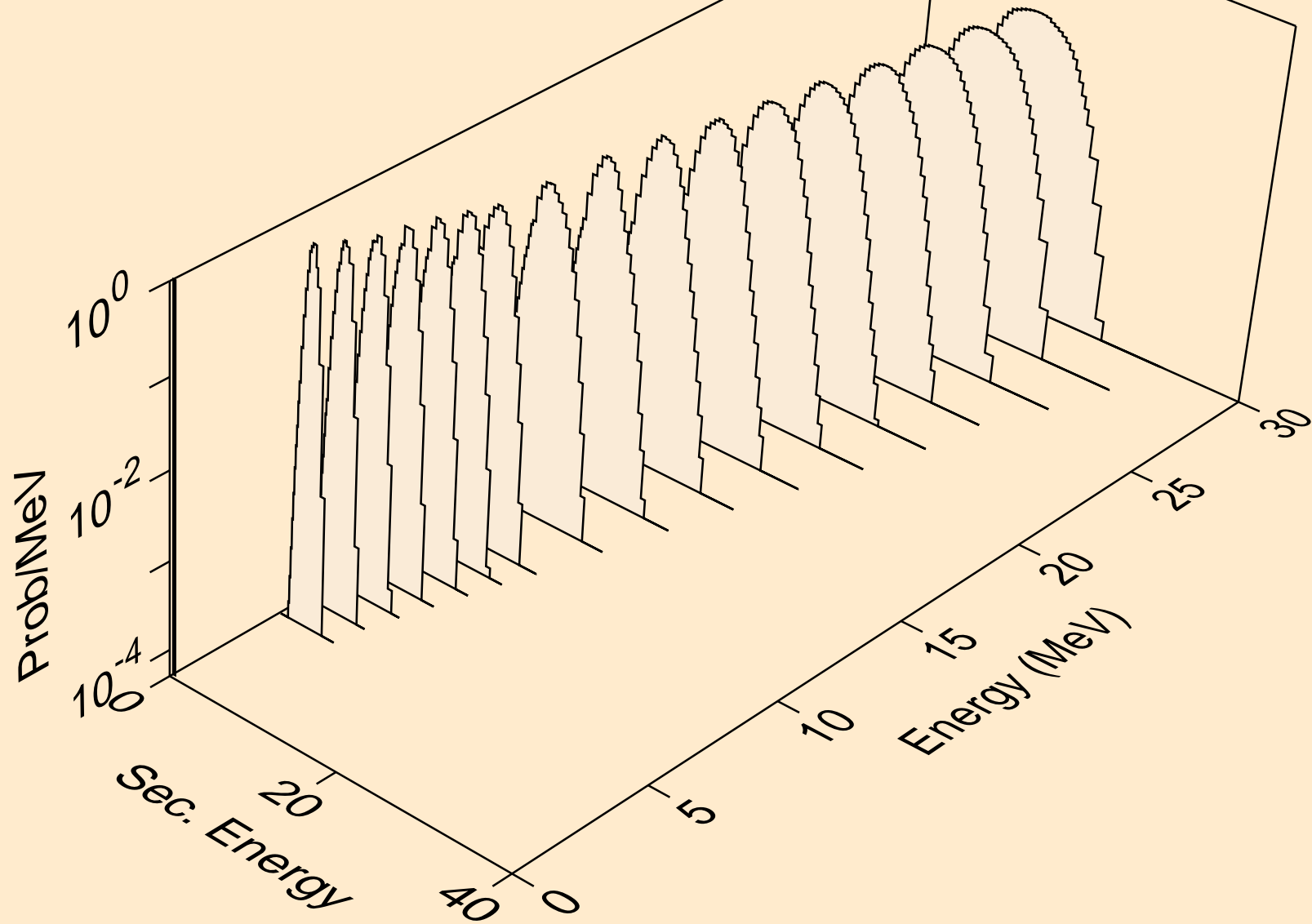

BA117 TRITON ACER TENDL-2021 LIBRARY; T=0.K  
deuterons from (t,pd)

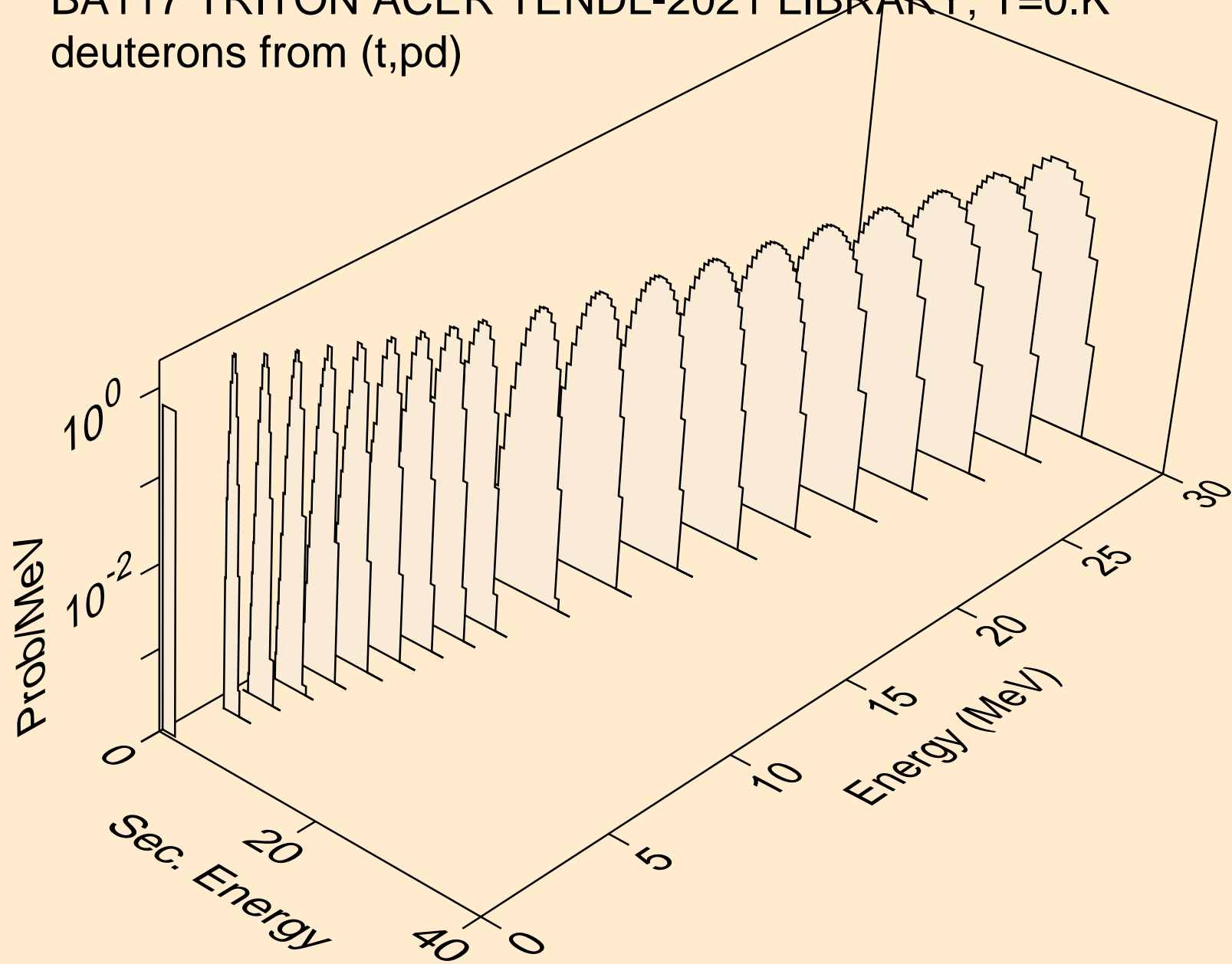

BA117 TRITON ACER TENDL-2021 LIBRARY; T=0.K  
deuterons from (t,da)

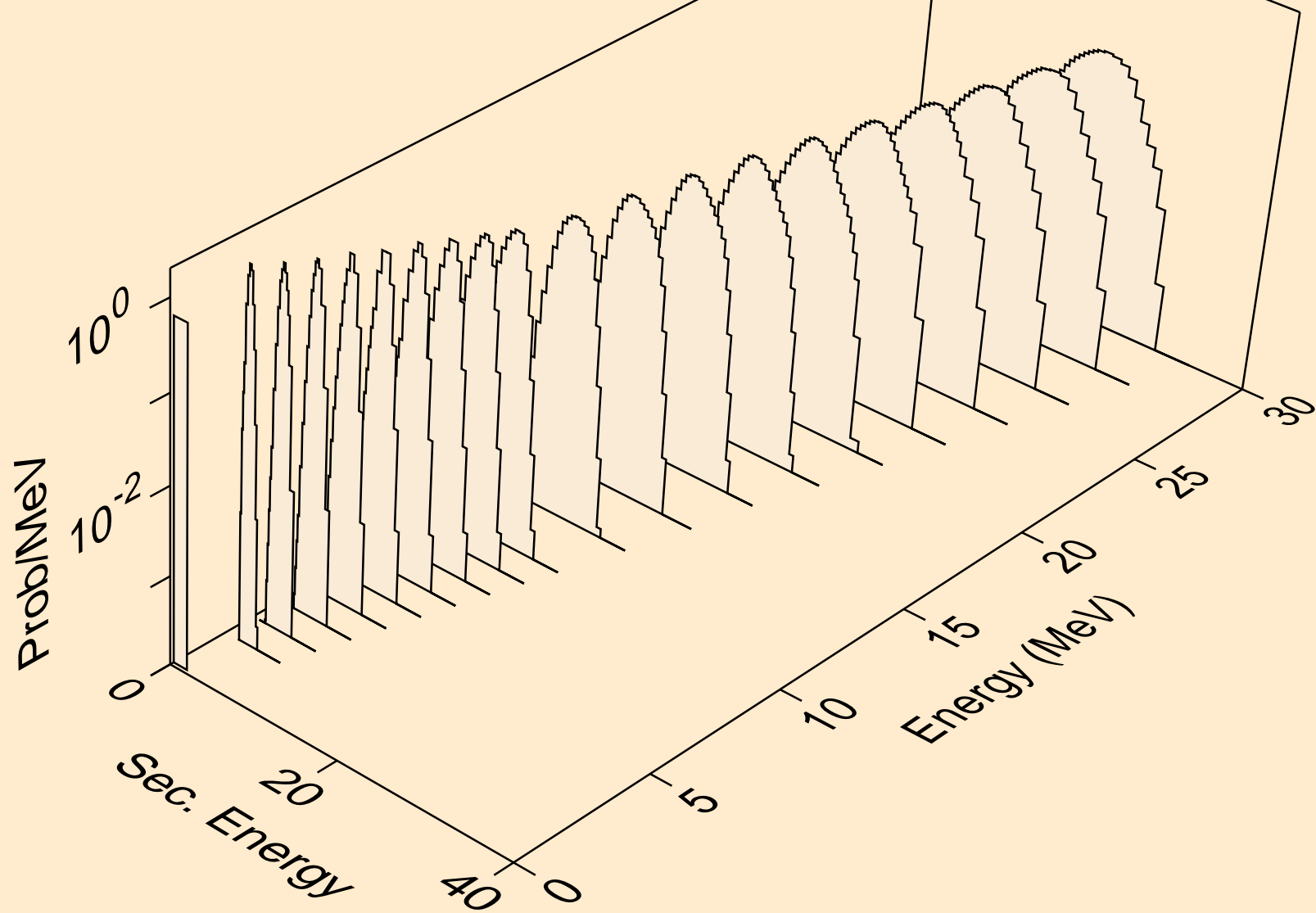

BA117 TRITON ACER TENDL-2021 LIBRARY; T=0.K  
he3s from (t,x)

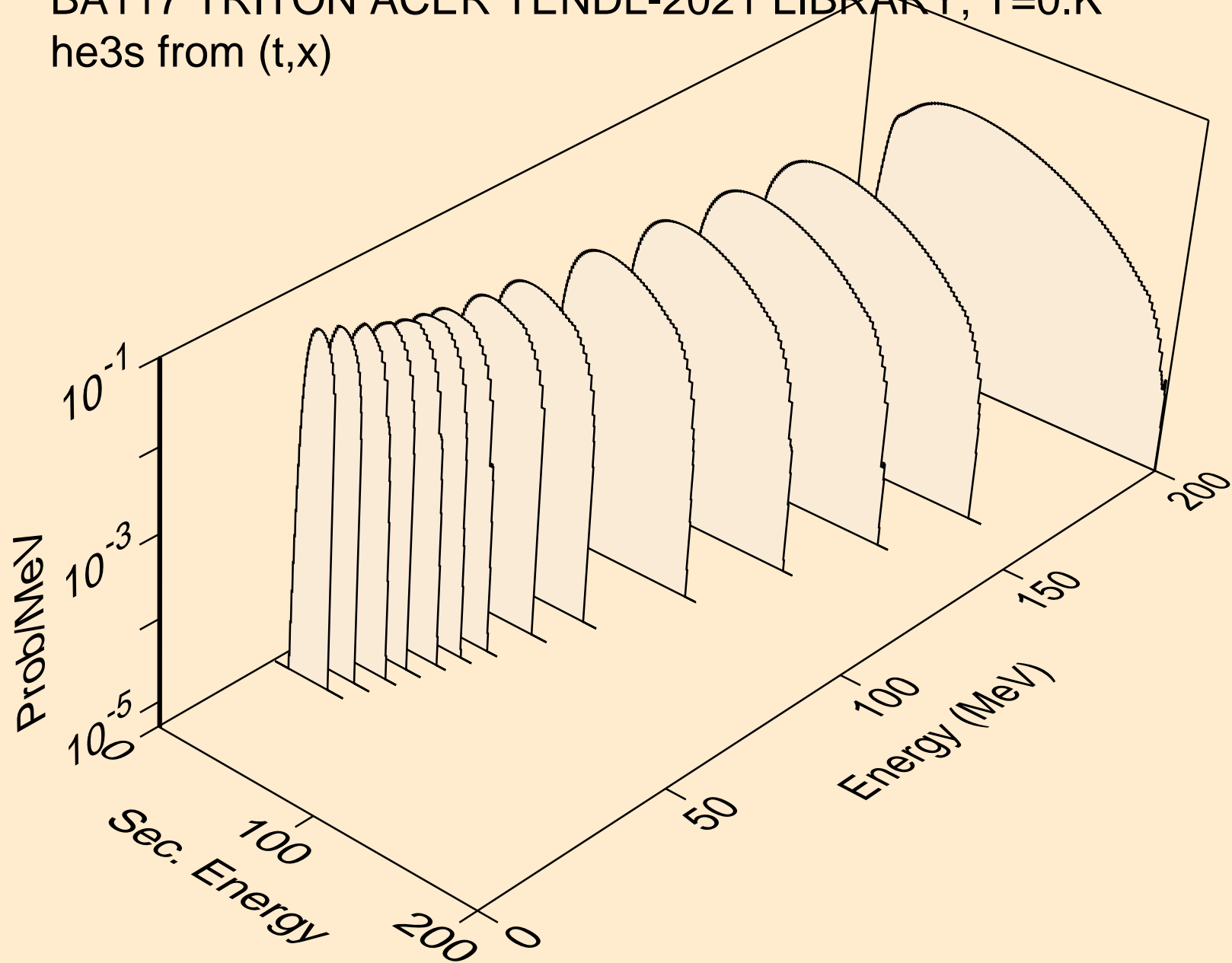

BA117 TRITON ACER TENDL-2021 LIBRARY; T=0.K  
he3s from (t,n\*)he3

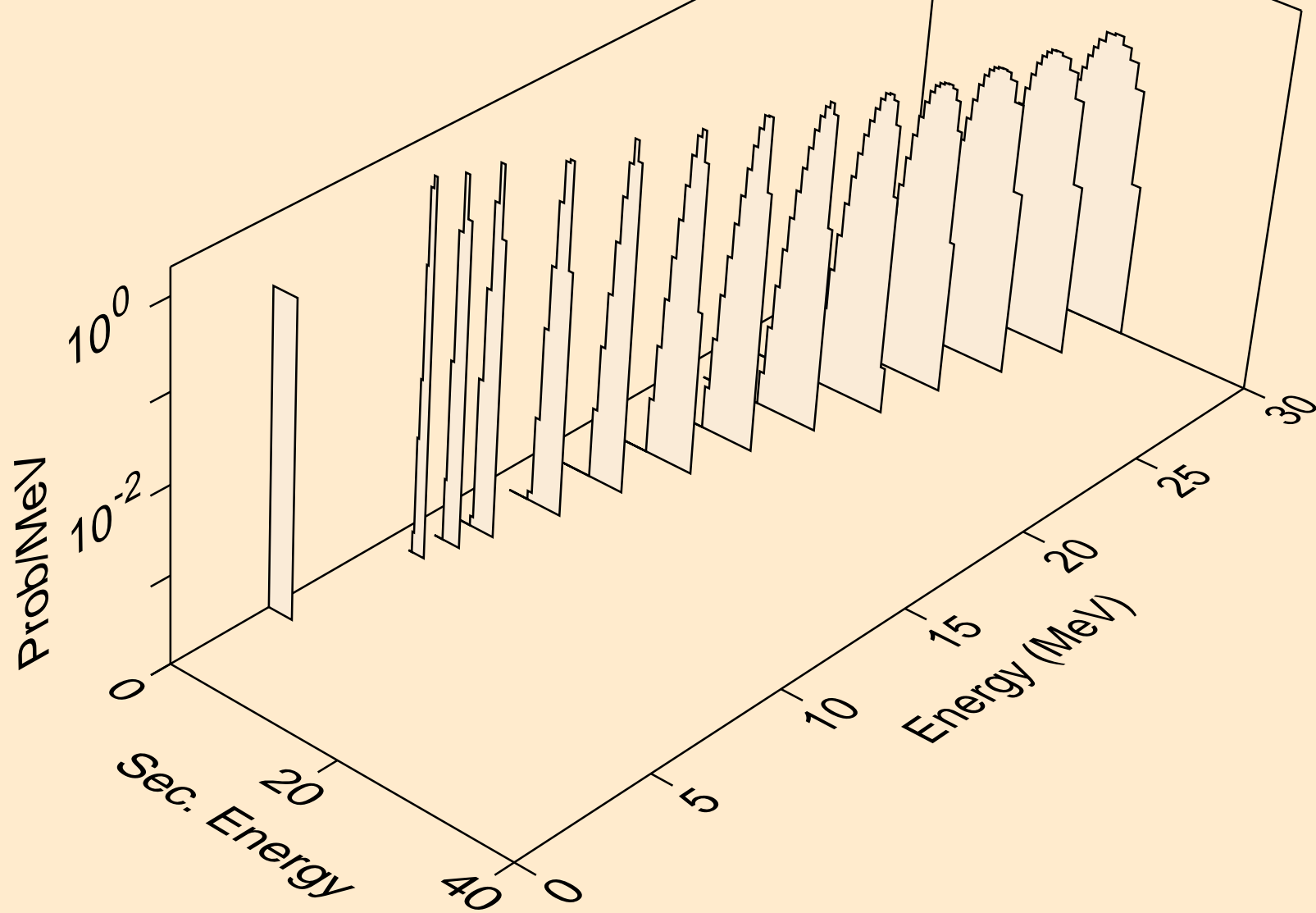

BA117 TRITON ACER TENDL-2021 LIBRARY; T=0.K  
he3s from (t,he3)

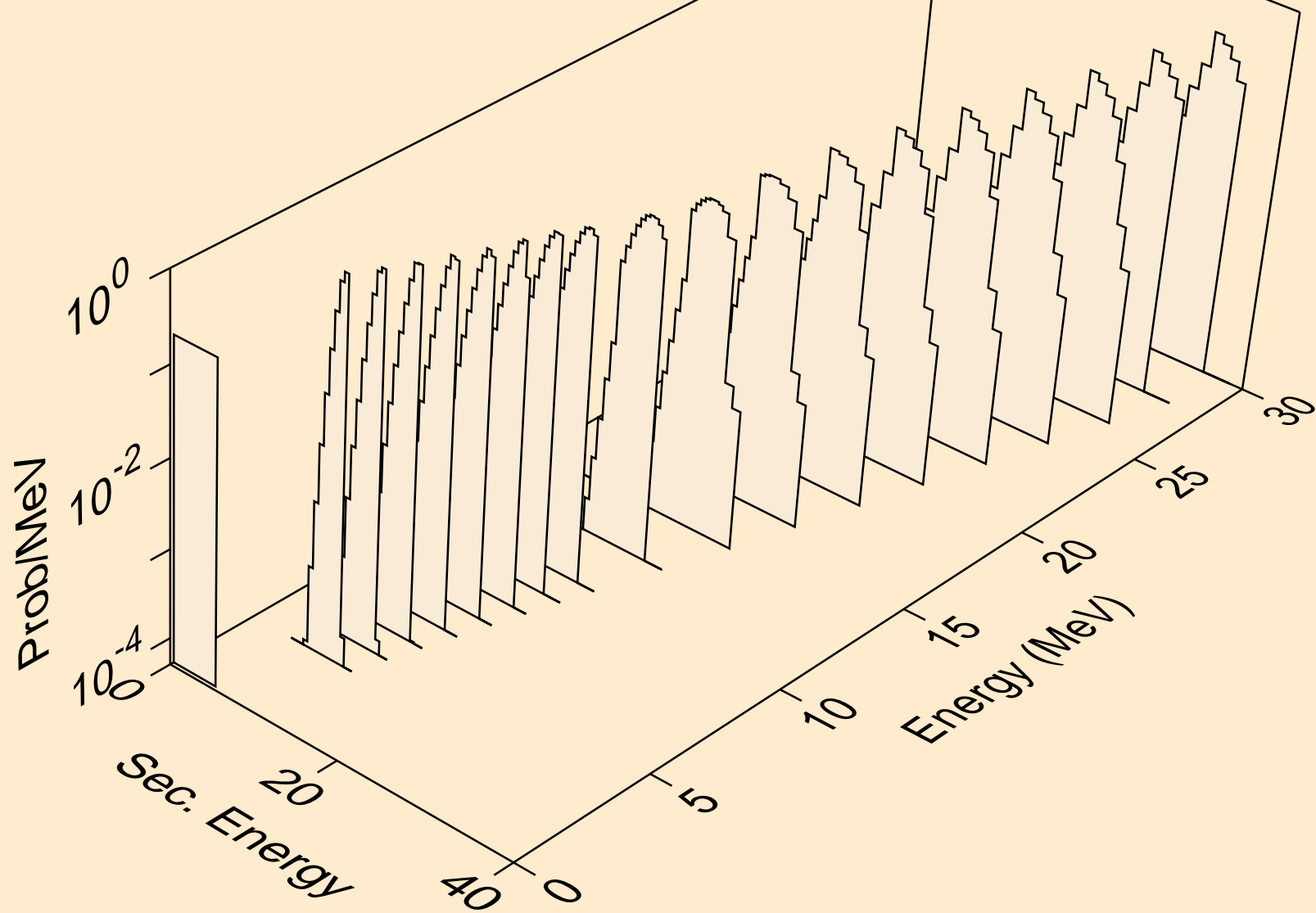

BA117 TRITON ACER TENDL-2021 LIBRARY; T=0.K  
alphas from (t,x)

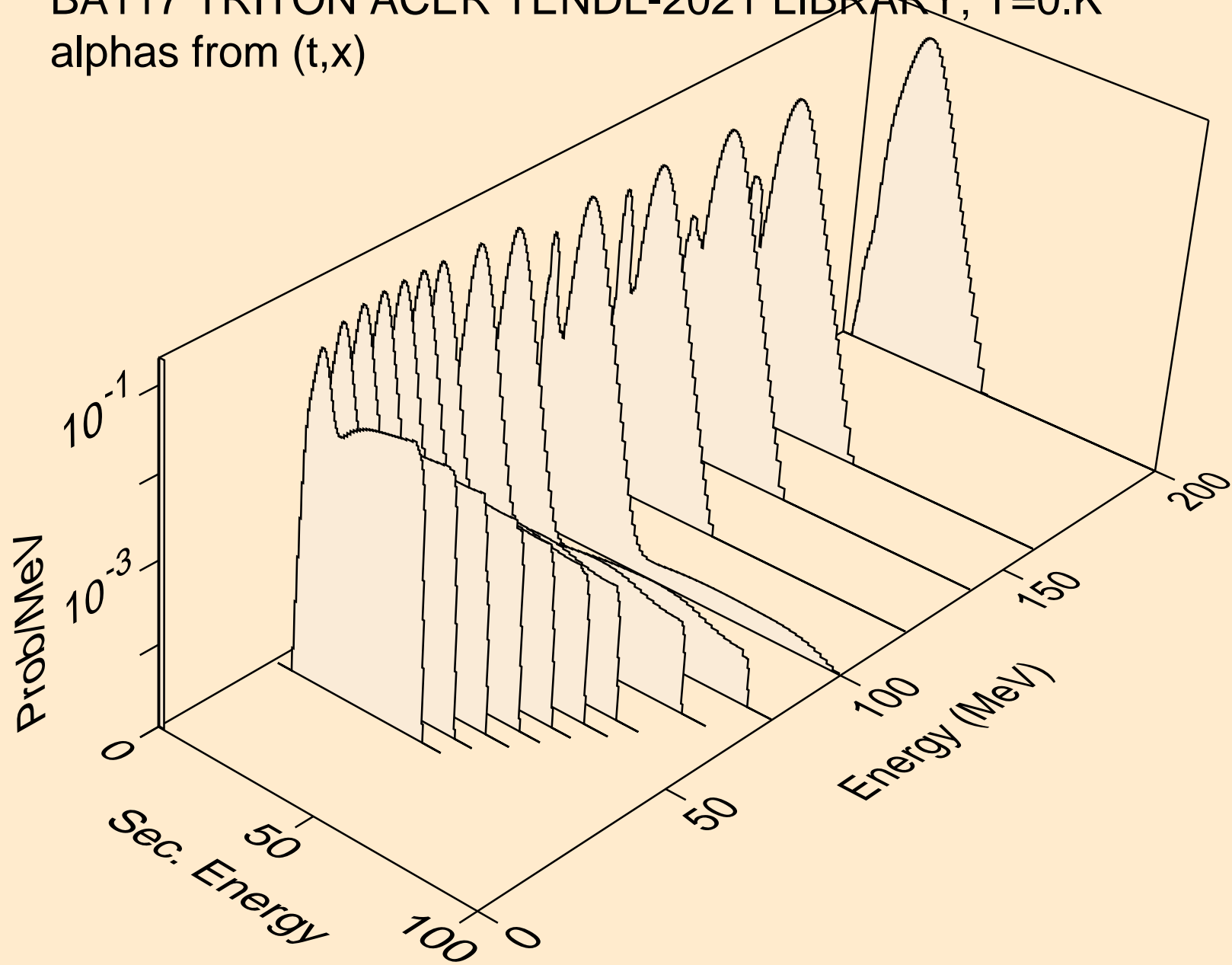

BA117 TRITON ACER TENDL-2021 LIBRARY; T=0.K  
alphas from (t,n\*)a

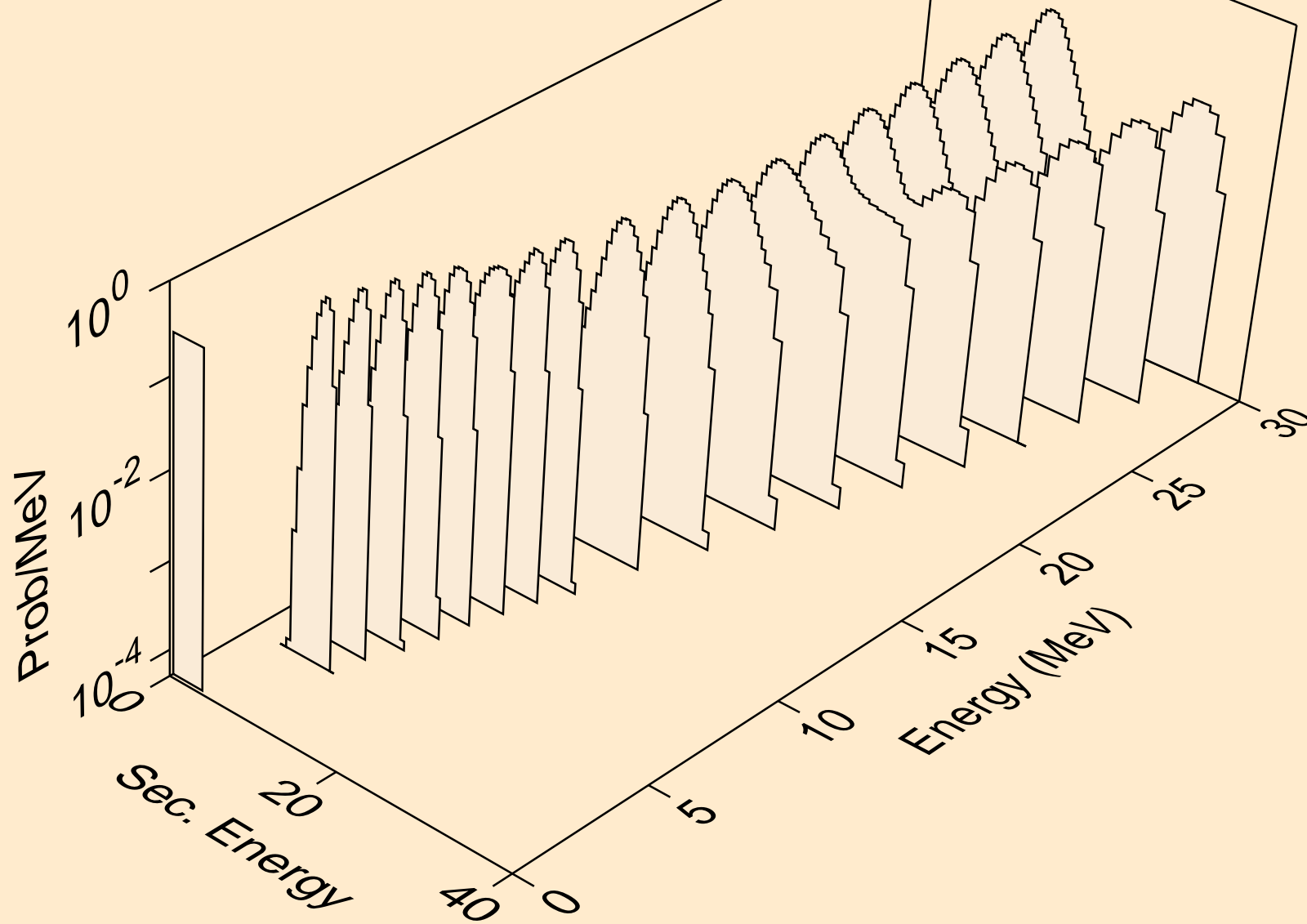



BA117 TRITON ACER TENDL-2021 LIBRARY; T=0.K  
alphas from (t,n\*)3a

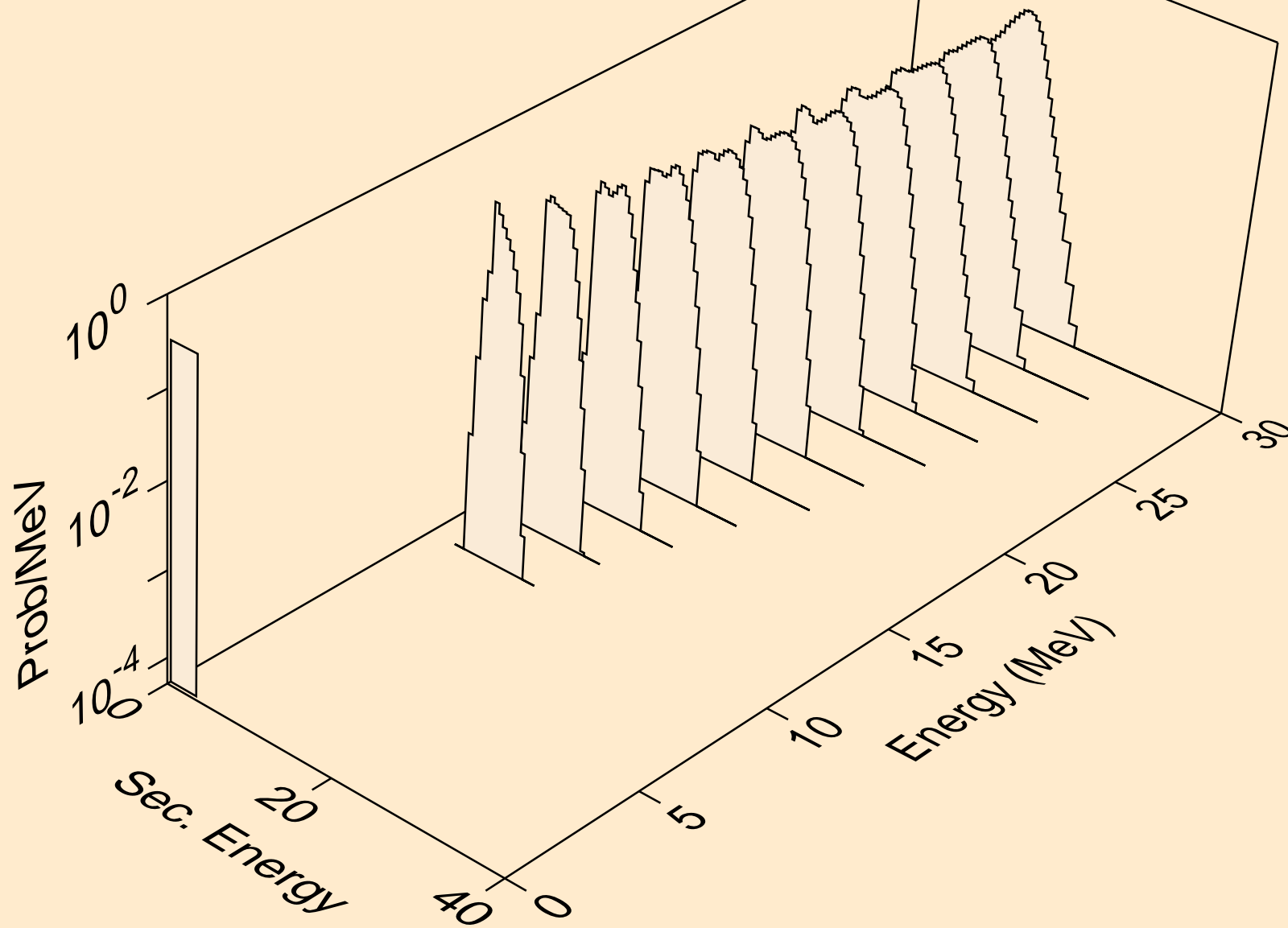

BA117 TRITON ACER TENDL-2021 LIBRARY; T=0.K  
alphas from (t,2n)a

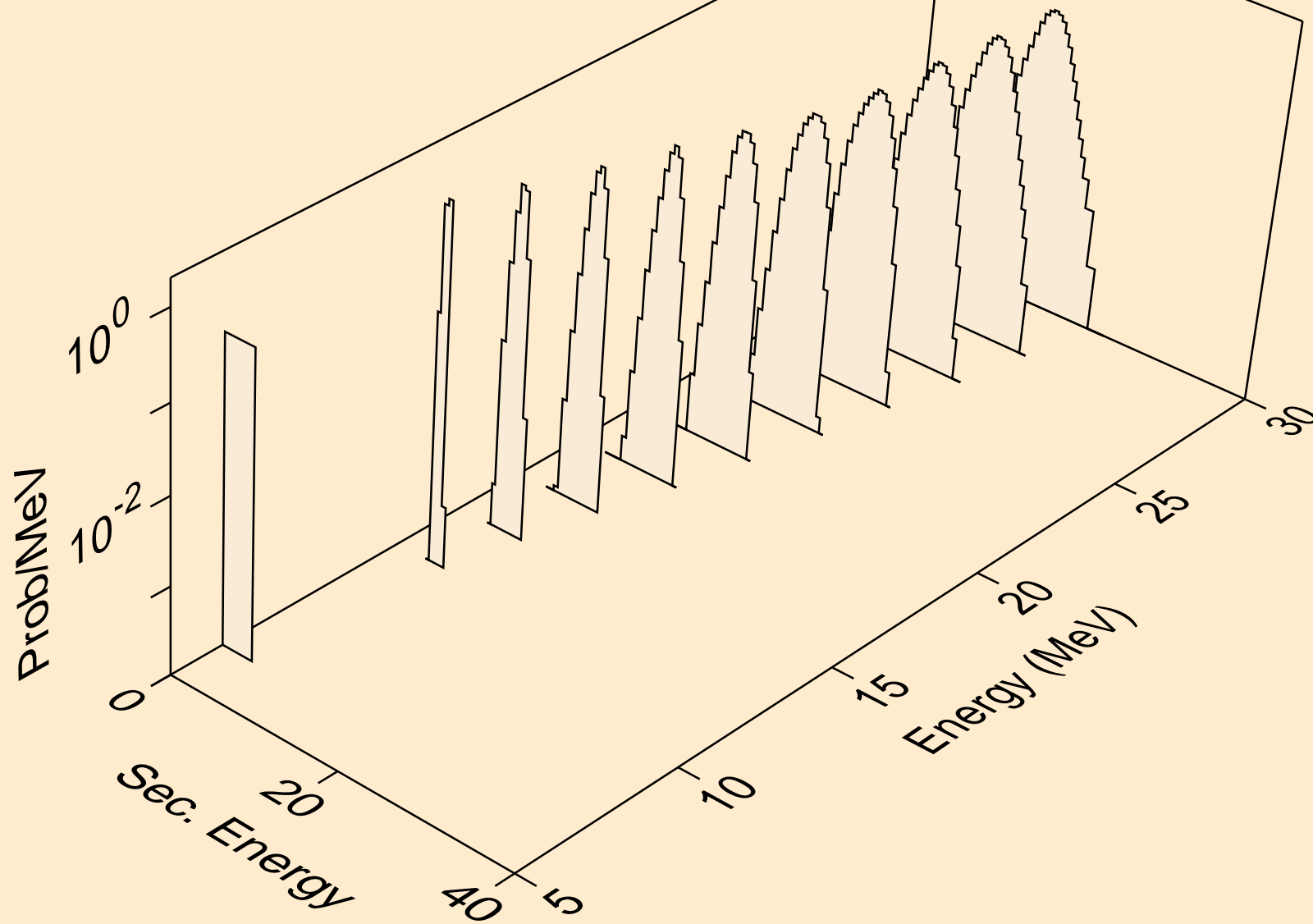

BA117 TRITON ACER TENDL-2021 LIBRARY; T=0.K  
alphas from (t,n\*)2a

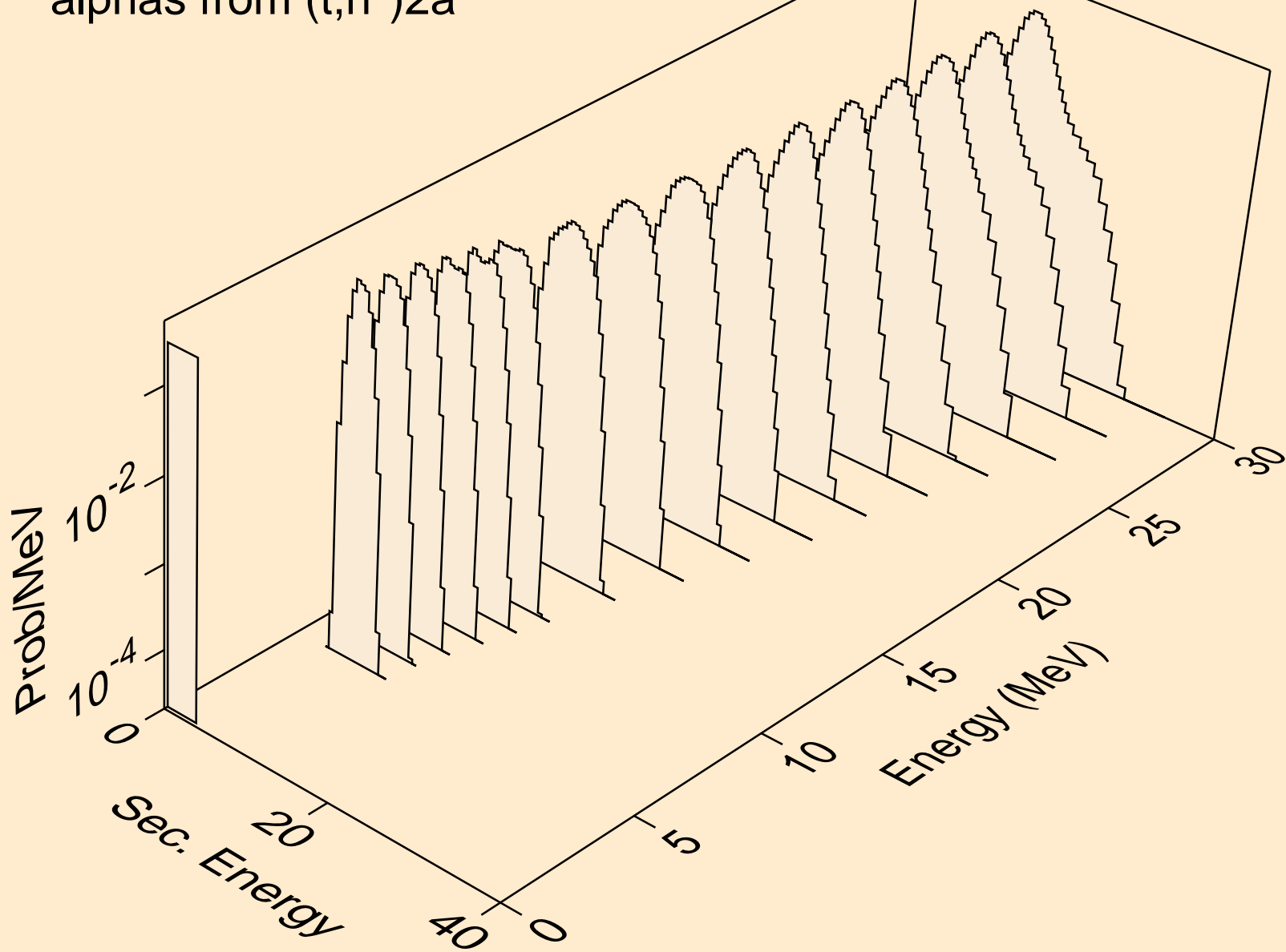

BA117 TRITON ACER TENDL-2021 LIBRARY; T=0.K  
alphas from (t,npa)

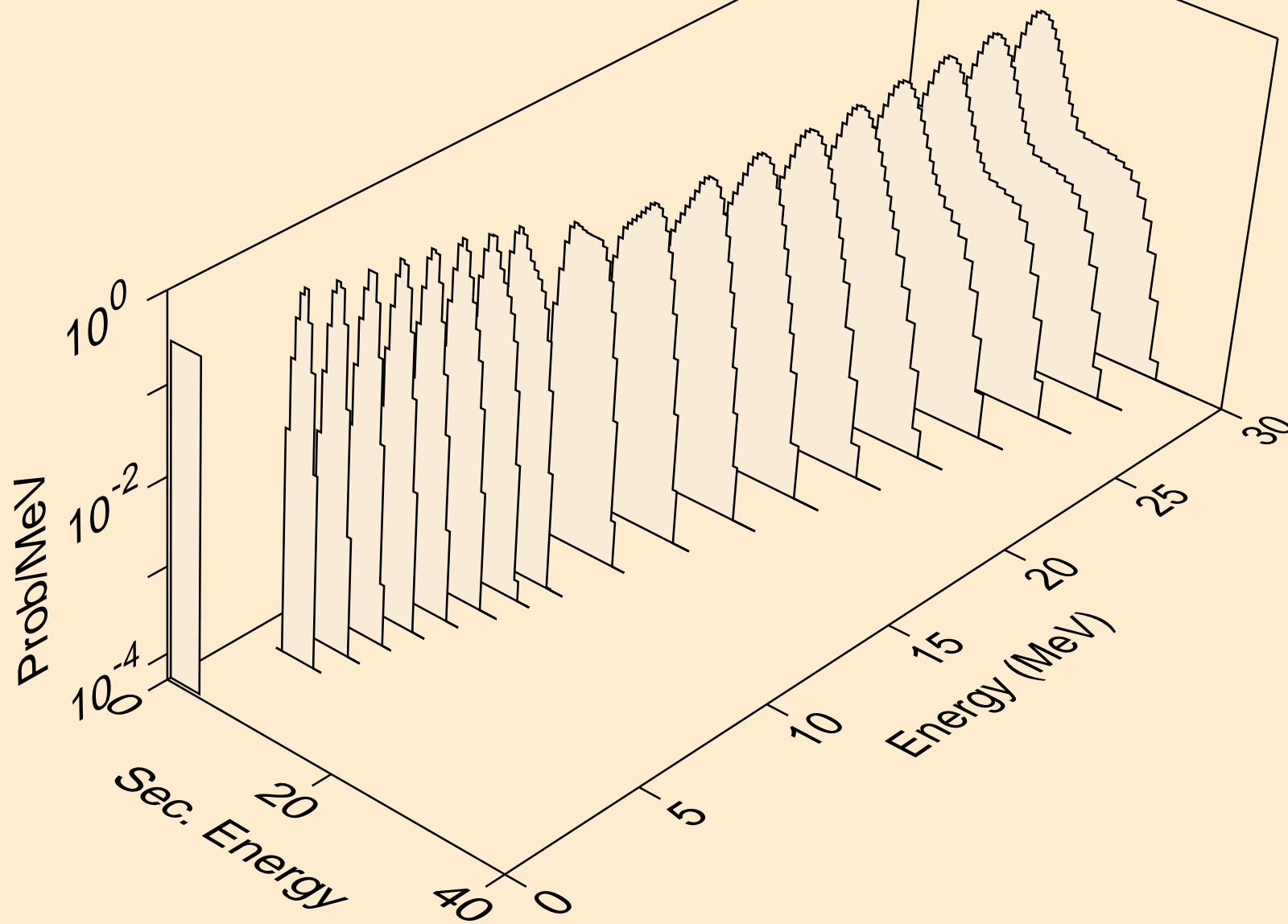

BA117 TRITON ACER TENDL-2021 LIBRARY; T=0.K  
alphas from (t,a)

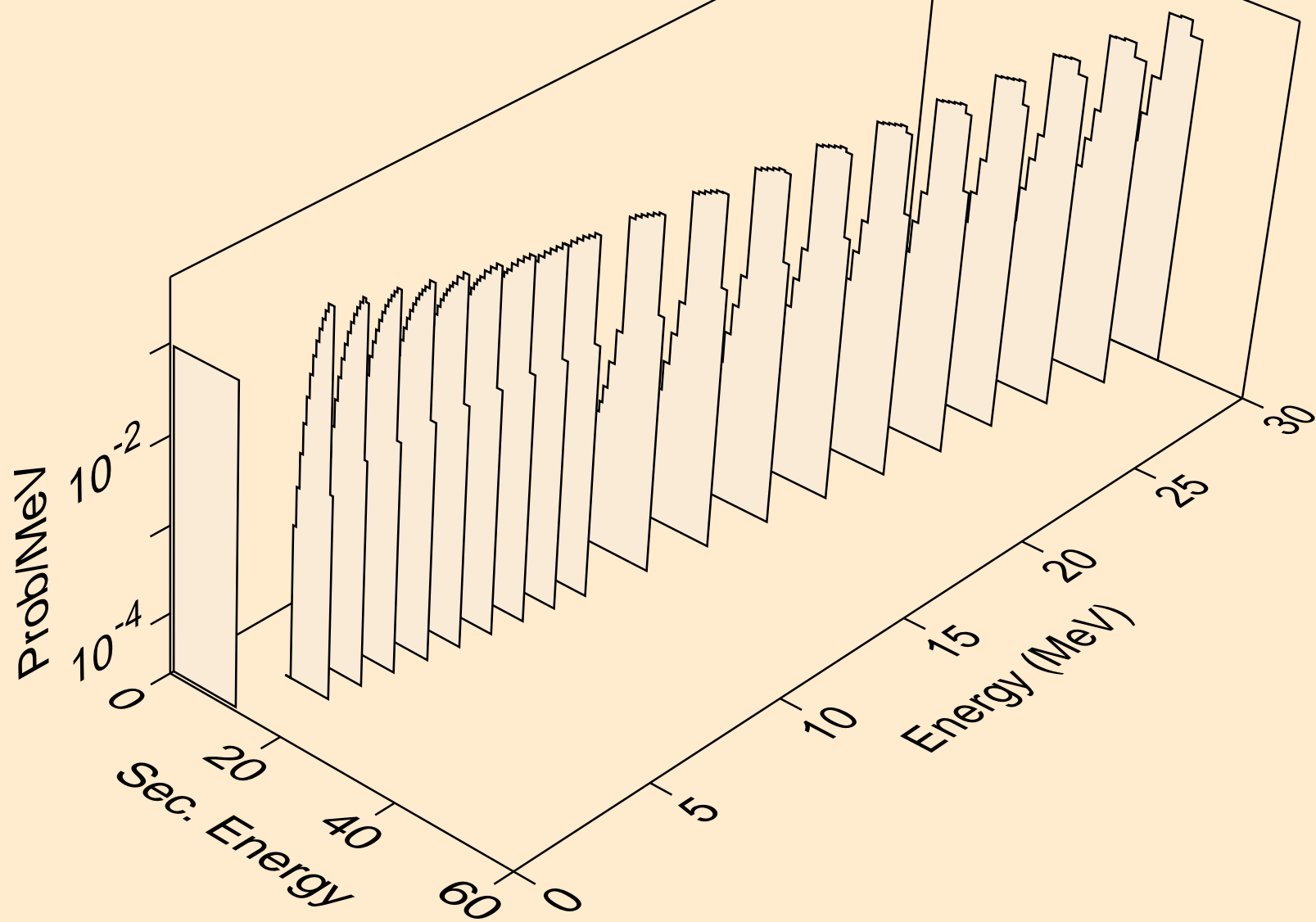

BA117 TRITON ACER TENDL-2021 LIBRARY; T=0.K  
alphas from (t,2a)

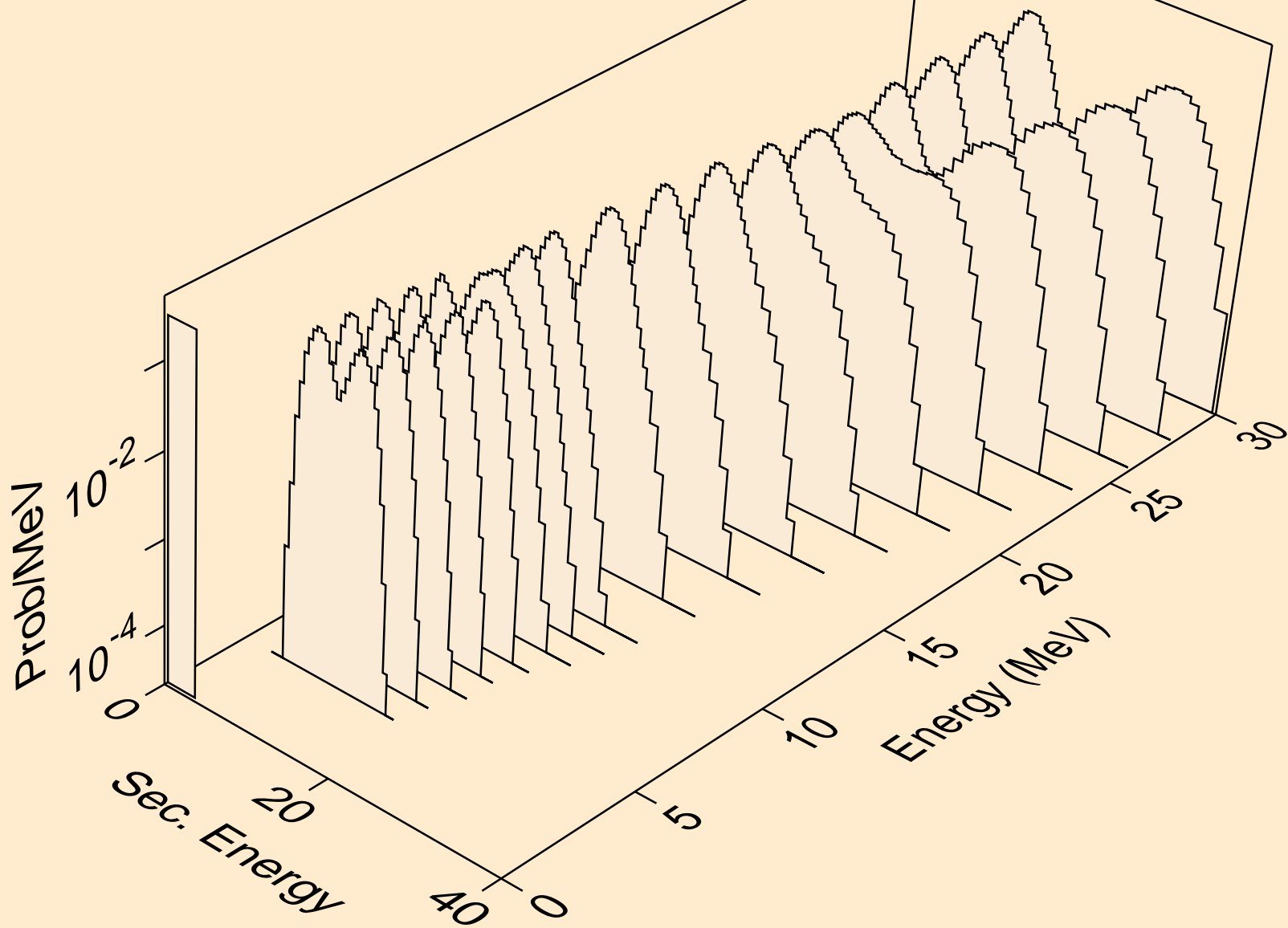

BA117 TRITON ACER TENDL-2021 LIBRARY; T=0.K  
alphas from (t,3a)

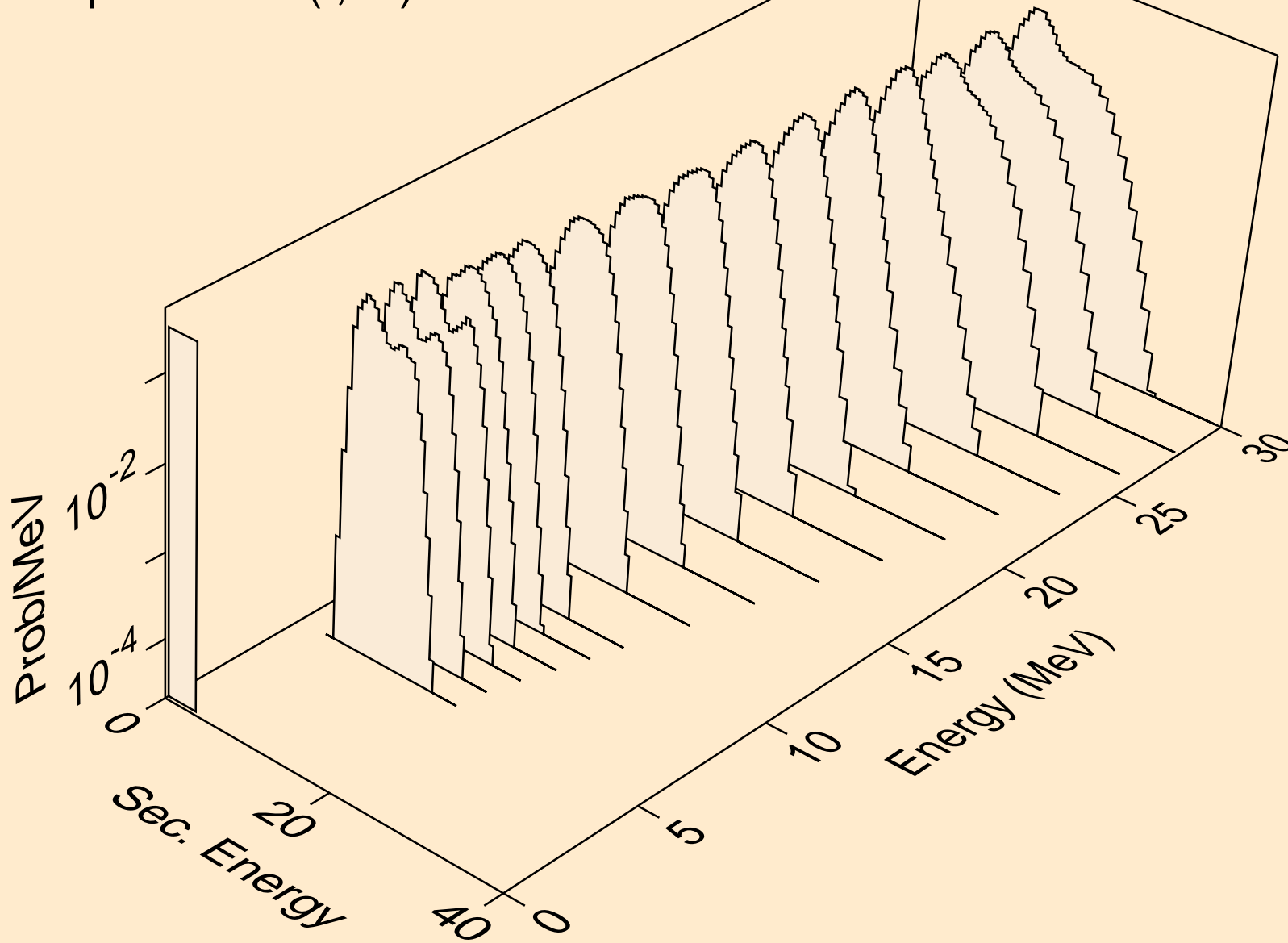

BA117 TRITON ACER TENDL-2021 LIBRARY; T=0.K  
alphas from (t,pa)

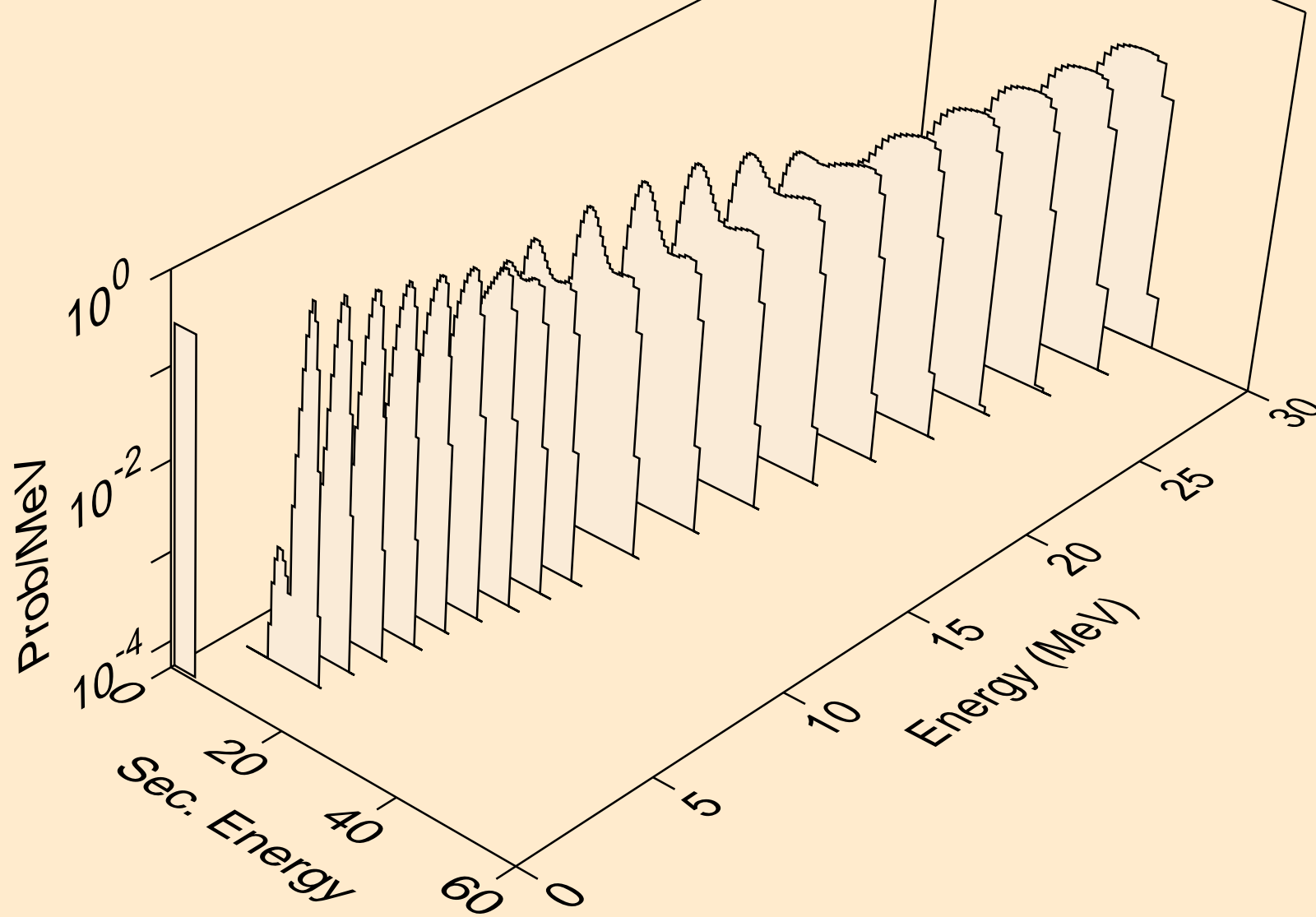



BA117 TRITON ACER TENDL-2021 LIBRARY; T=0.K  
alphas from (t,t2a)

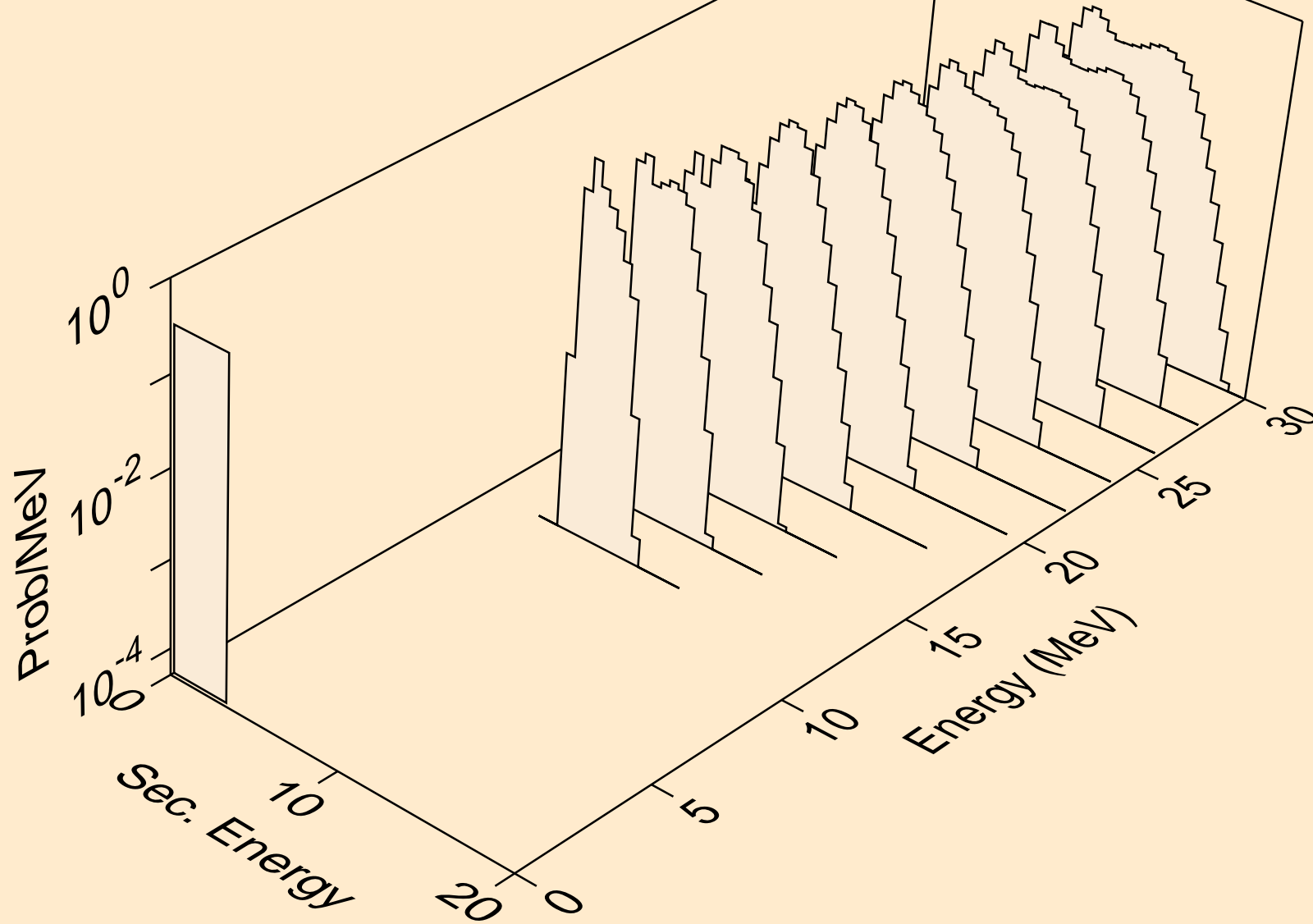

BA117 TRITON ACER TENDL-2021 LIBRARY; T=0.K  
alphas from (t,d2a)

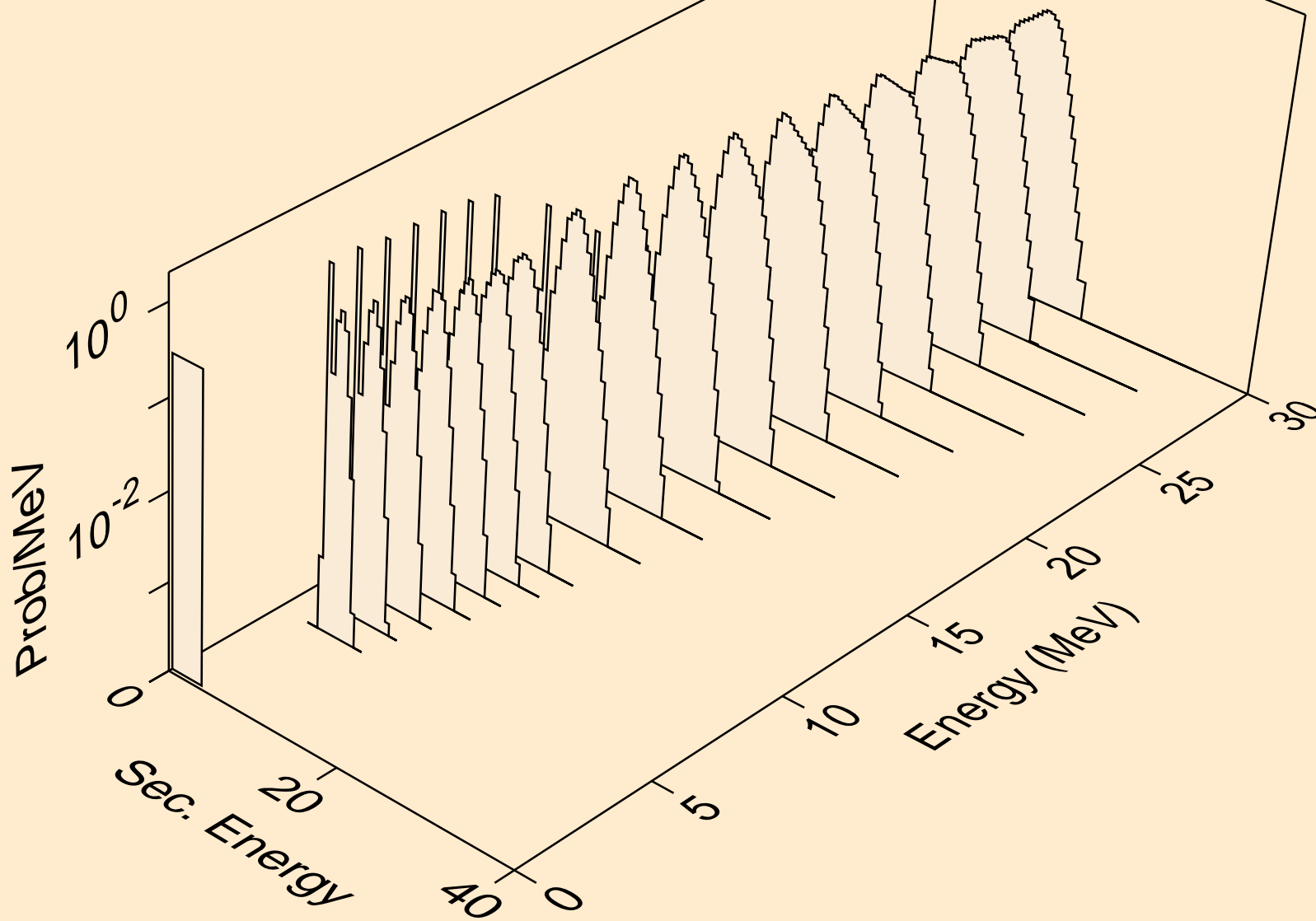

BA117 TRITON ACER TENDL-2021 LIBRARY; T=0.K  
alphas from (t,da)

