

DB263 TRITON ACER TENDL-2021 LIBRARY; T=0.K  
Principal cross sections

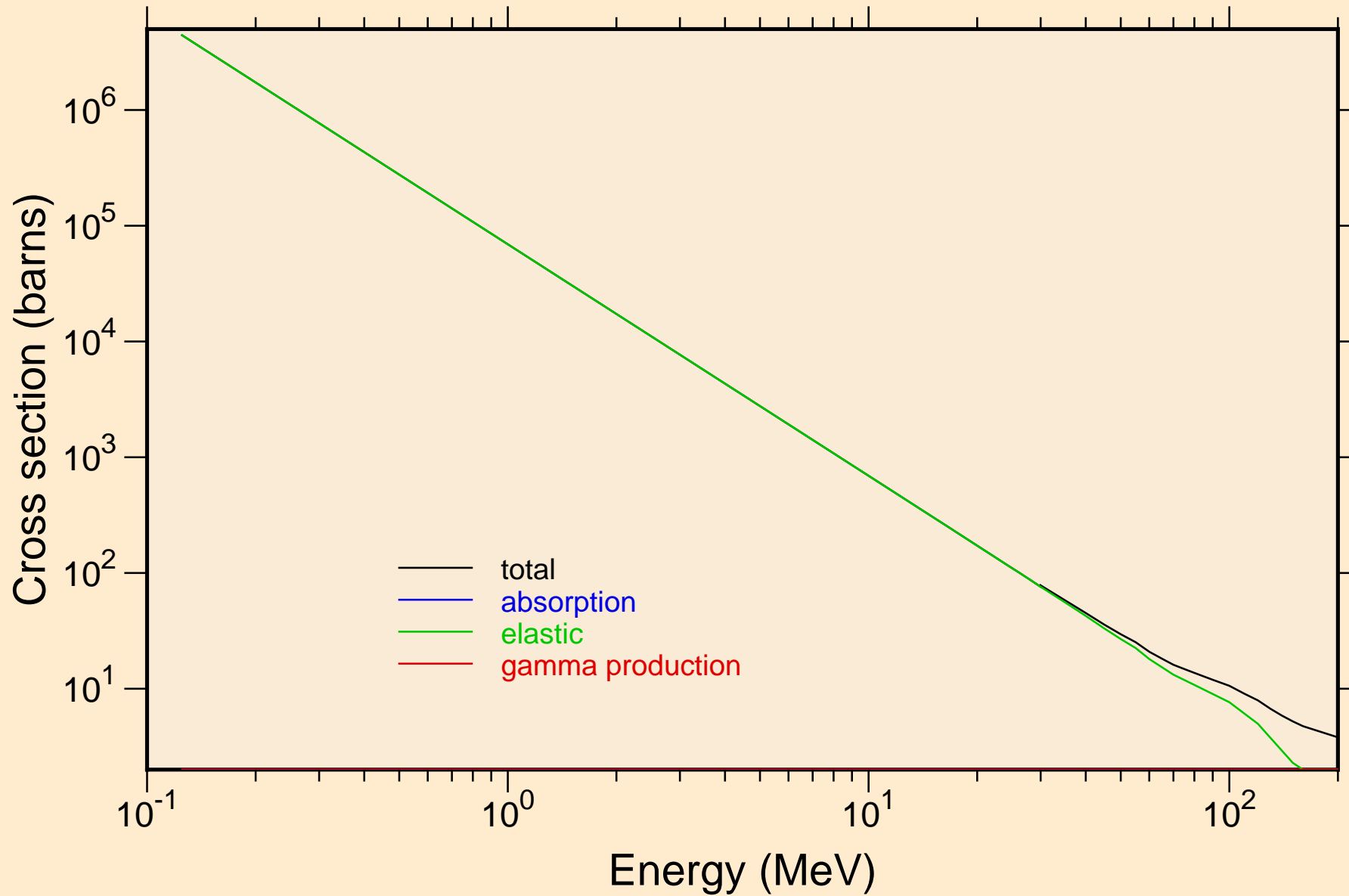

DB263 TRITON ACER TENDL-2021 LIBRARY; T=0.K

Heating

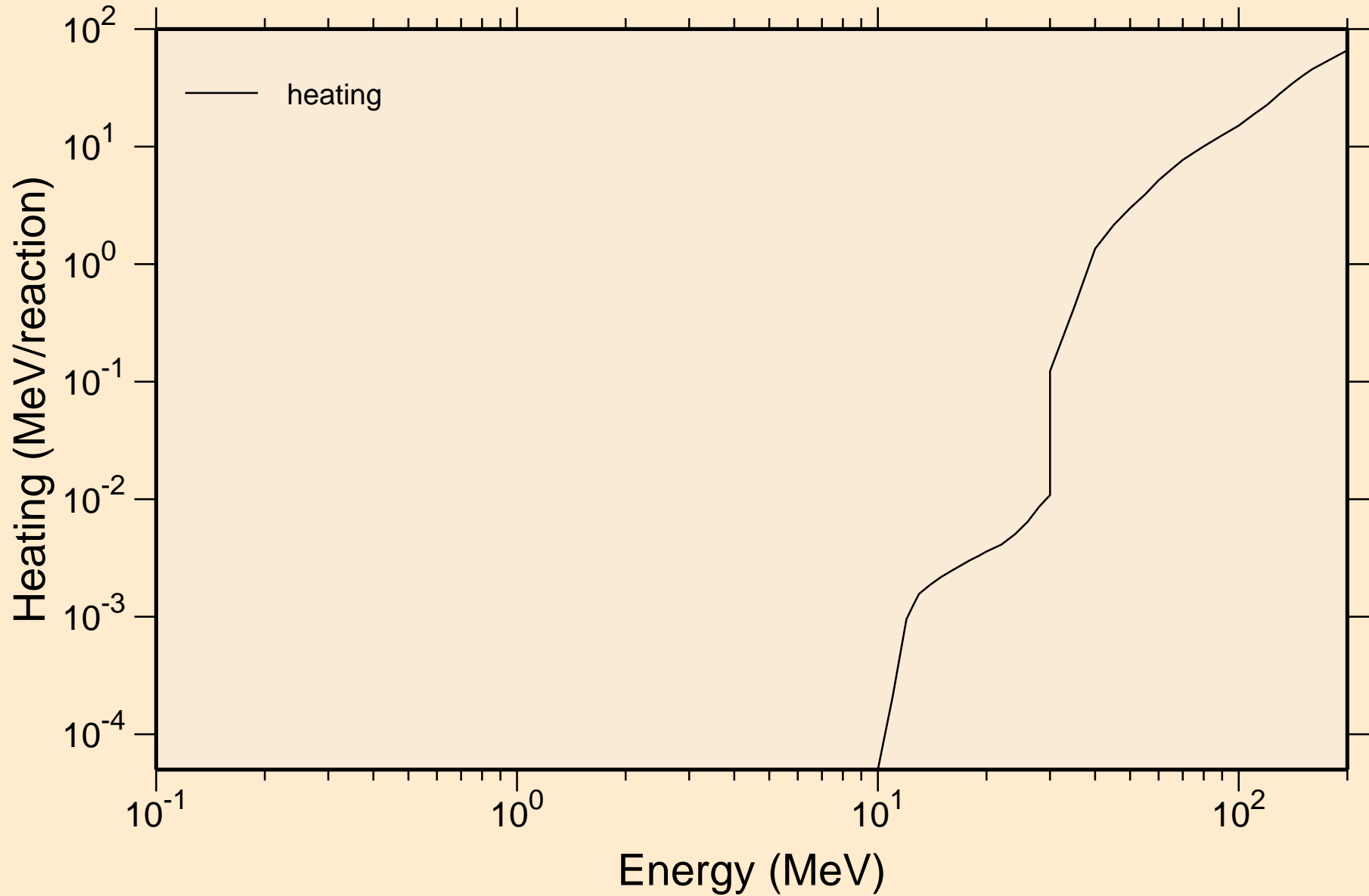

# DB263 TRITON ACER TENDL-2021 LIBRARY; T=0.K

## Principal cross sections

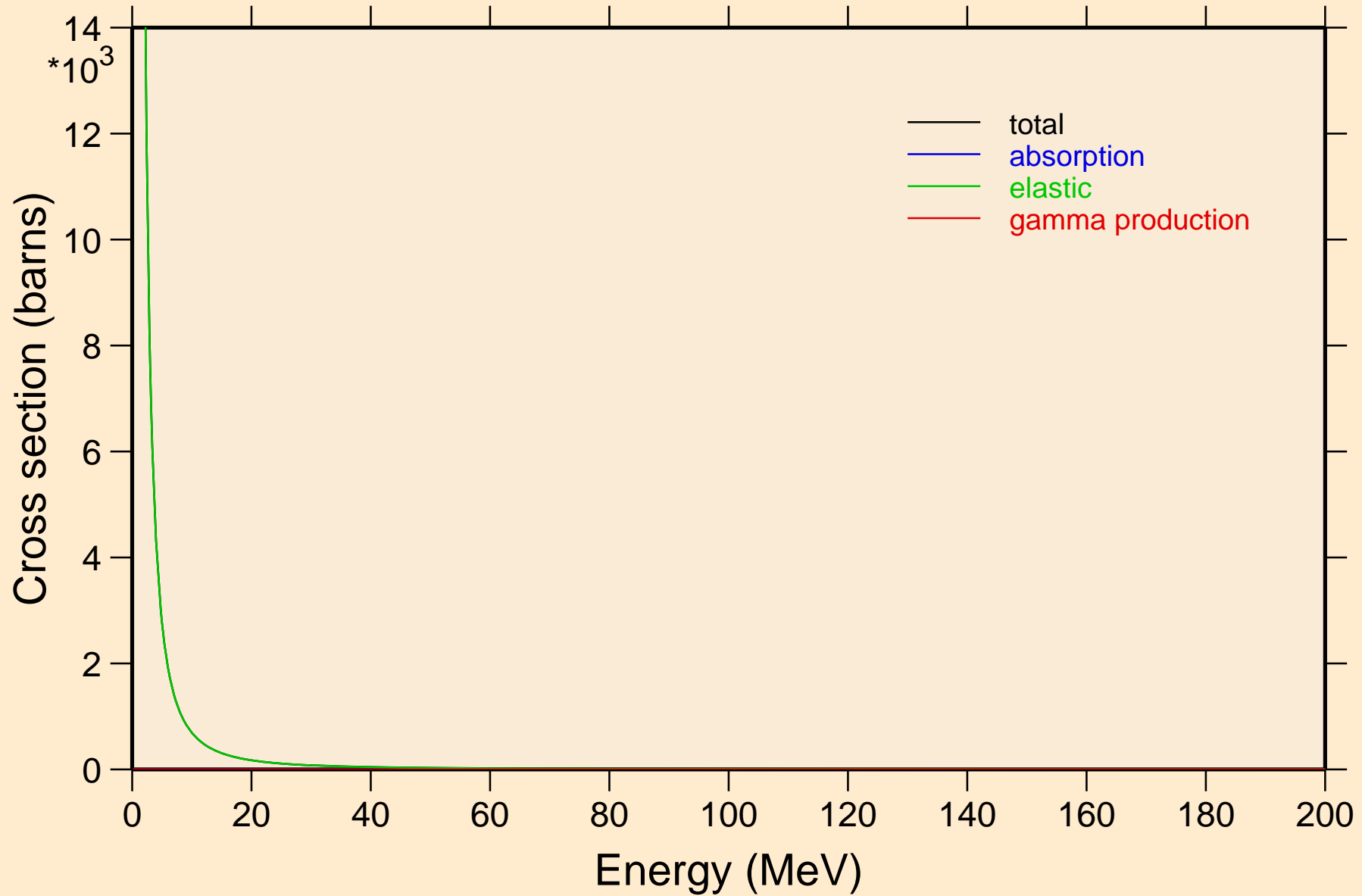

DB263 TRITON ACER TENDL-2021 LIBRARY; T=0.K

Heating

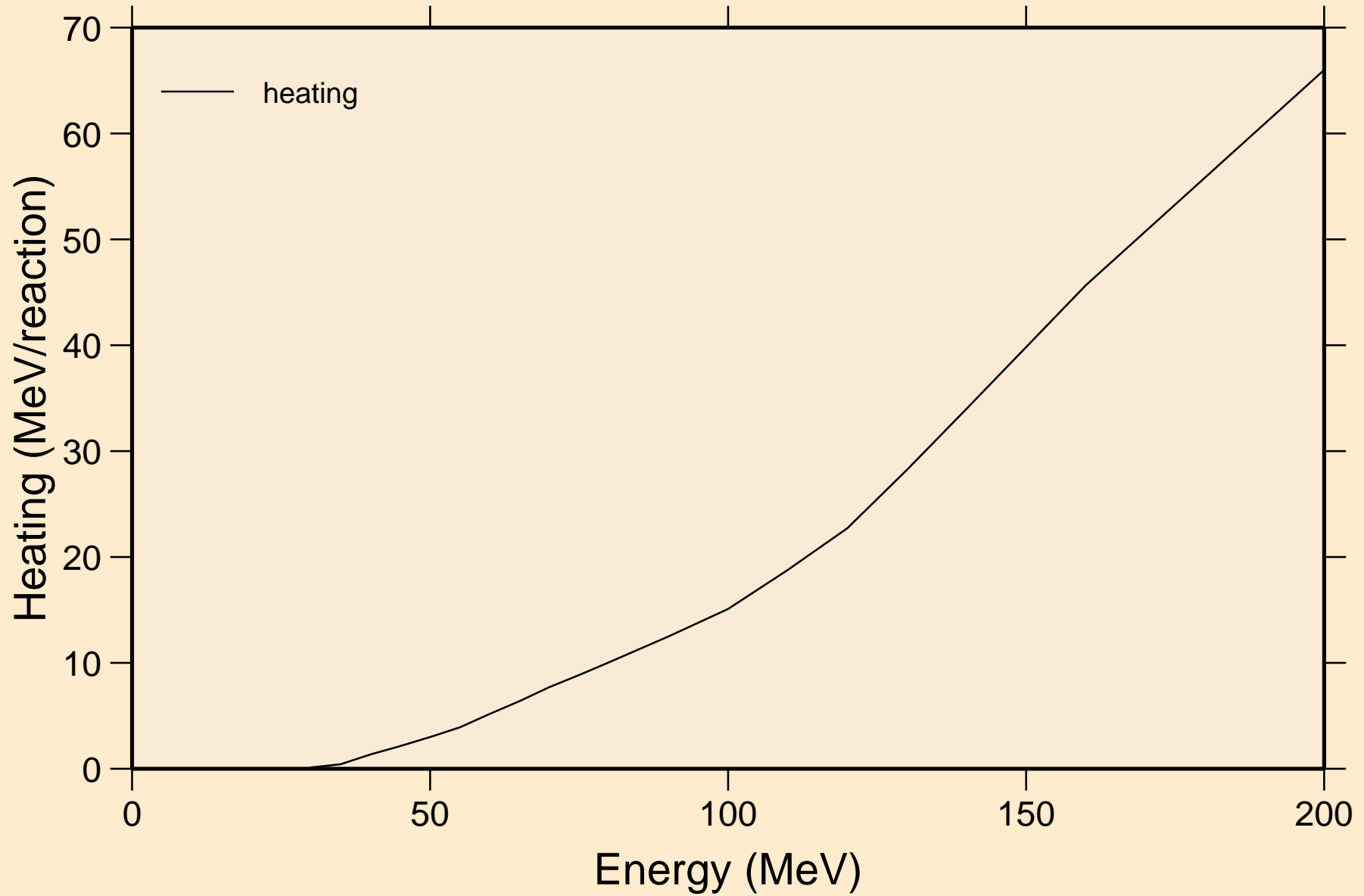

DB263 TRITON ACER TENDL-2021 LIBRARY; T=0.K  
Threshold reactions

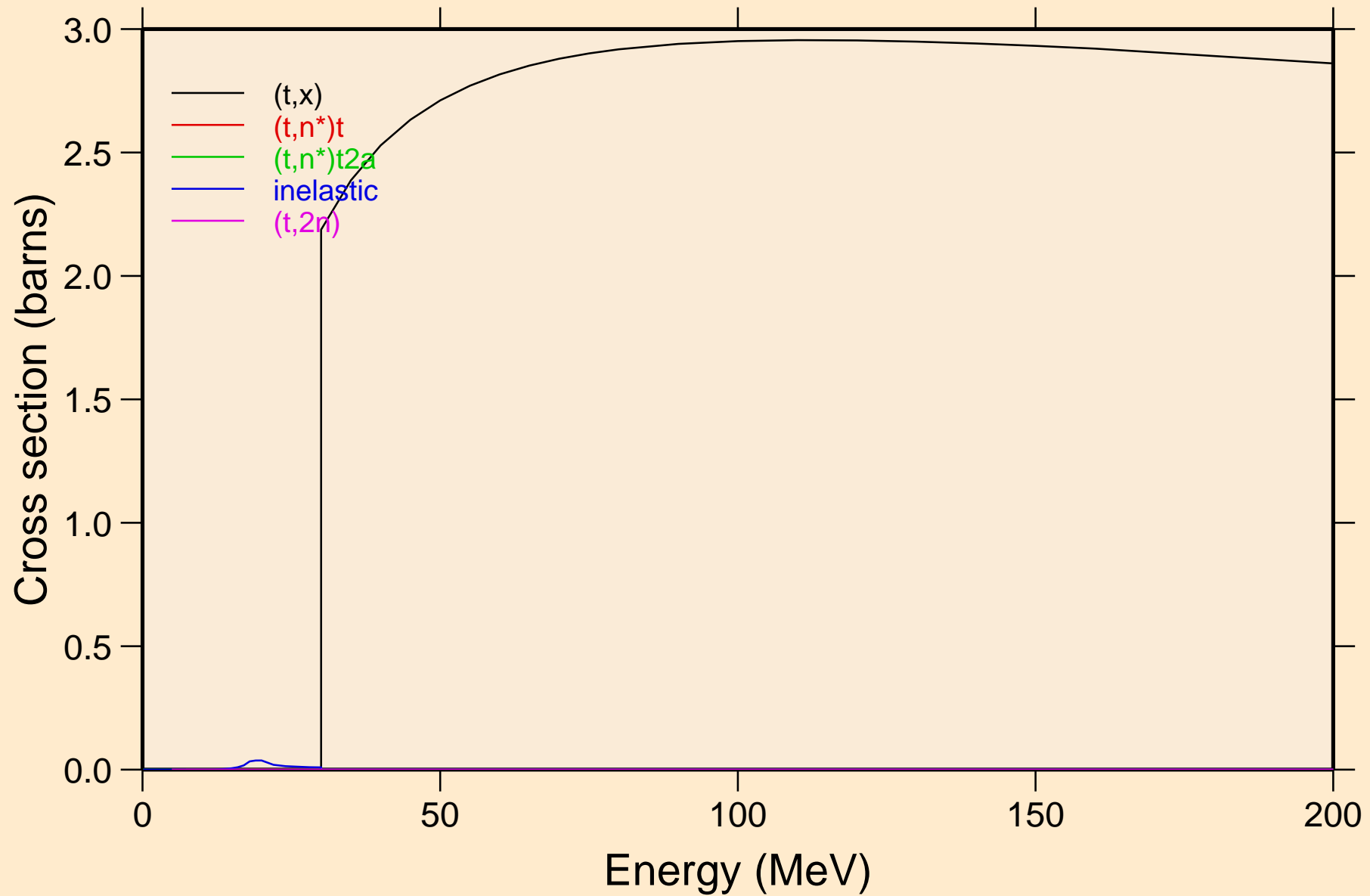

DB263 TRITON ACER TENDL-2021 LIBRARY; T=0.K  
Threshold reactions

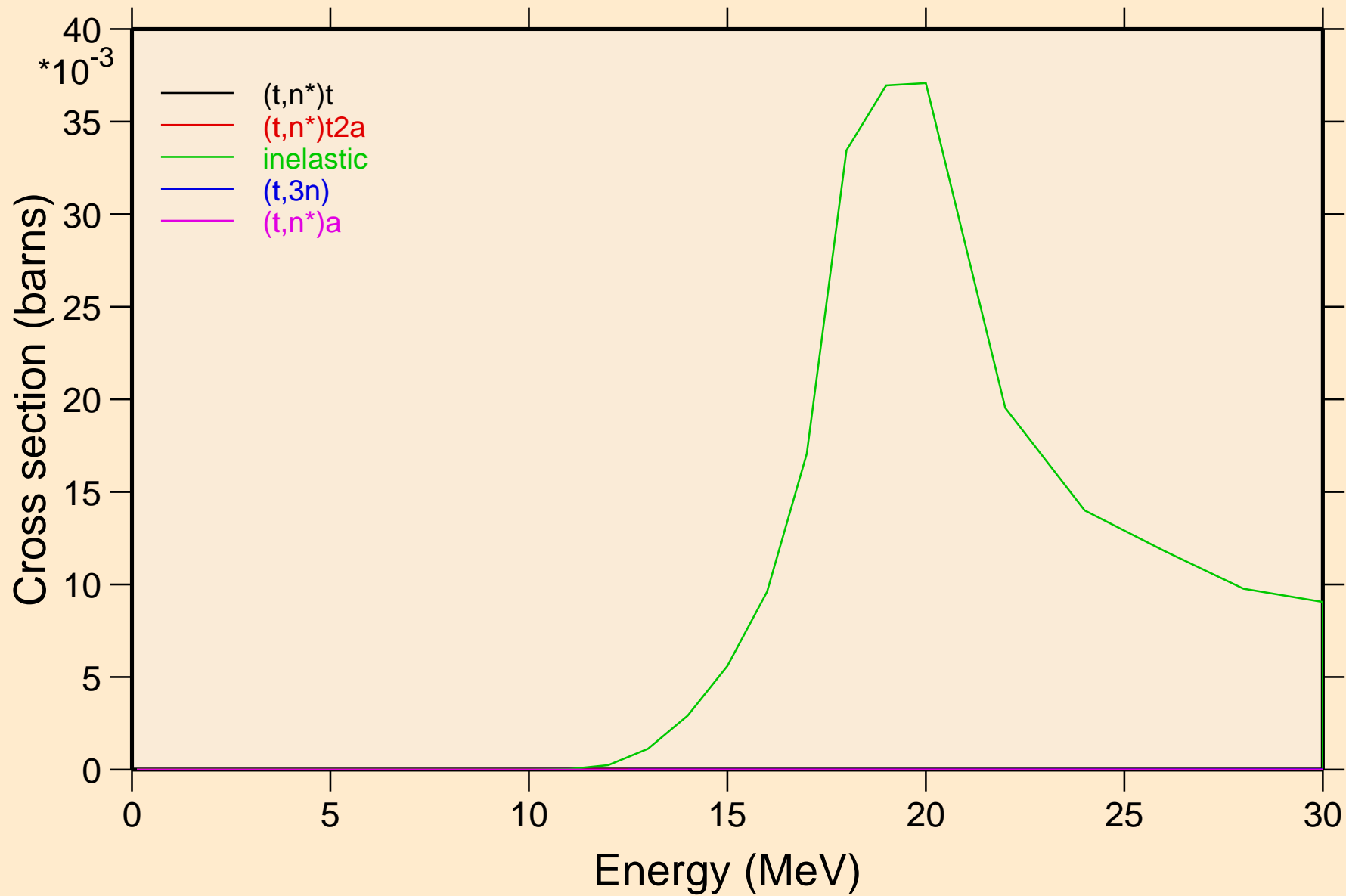

DB263 TRITON ACER TENDL-2021 LIBRARY; T=0.K  
Threshold reactions

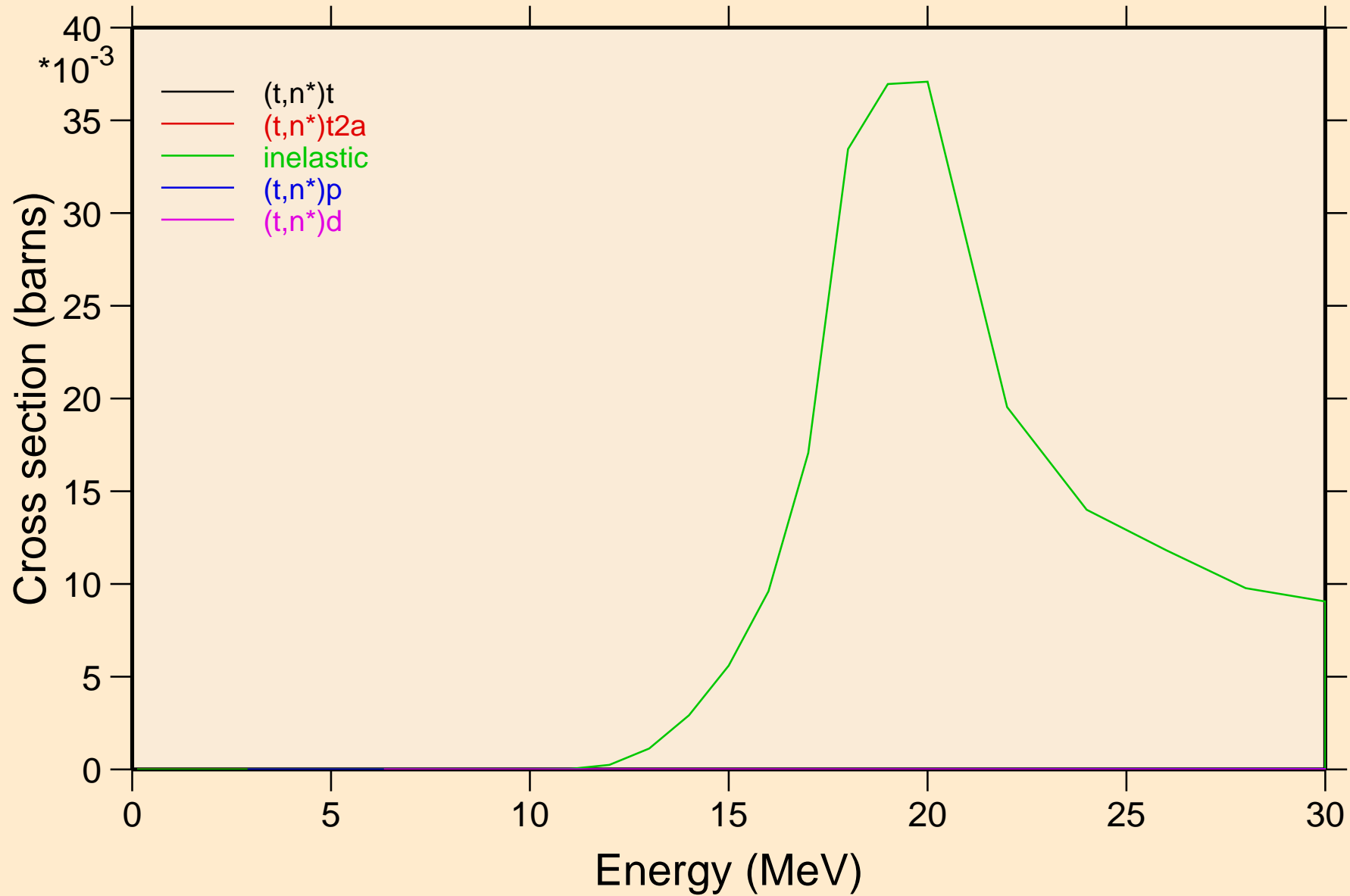

DB263 TRITON ACER TENDL-2021 LIBRARY; T=0.K  
Threshold reactions

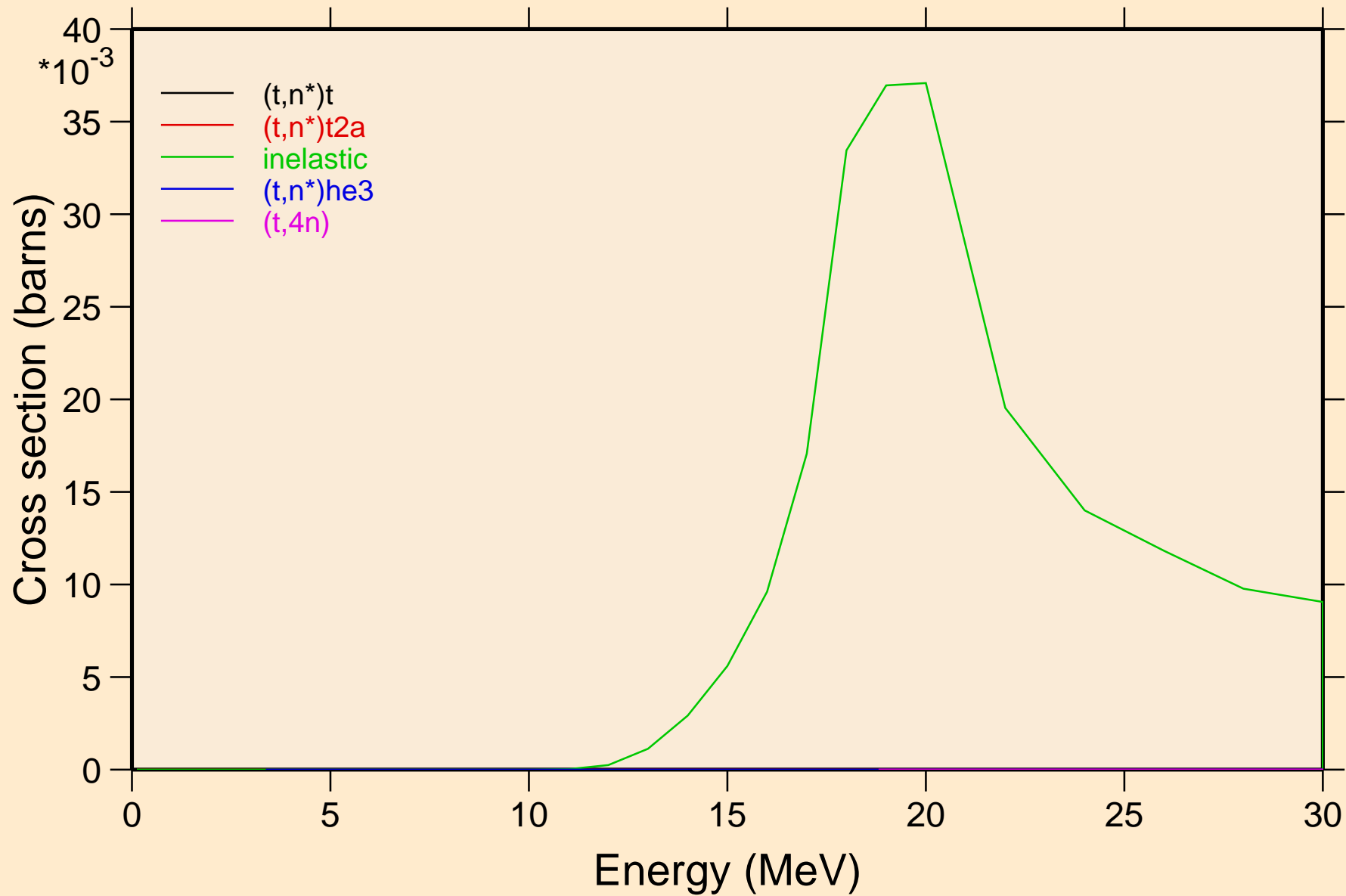



DB263 TRITON ACER TENDL-2021 LIBRARY; T=0.K  
Threshold reactions

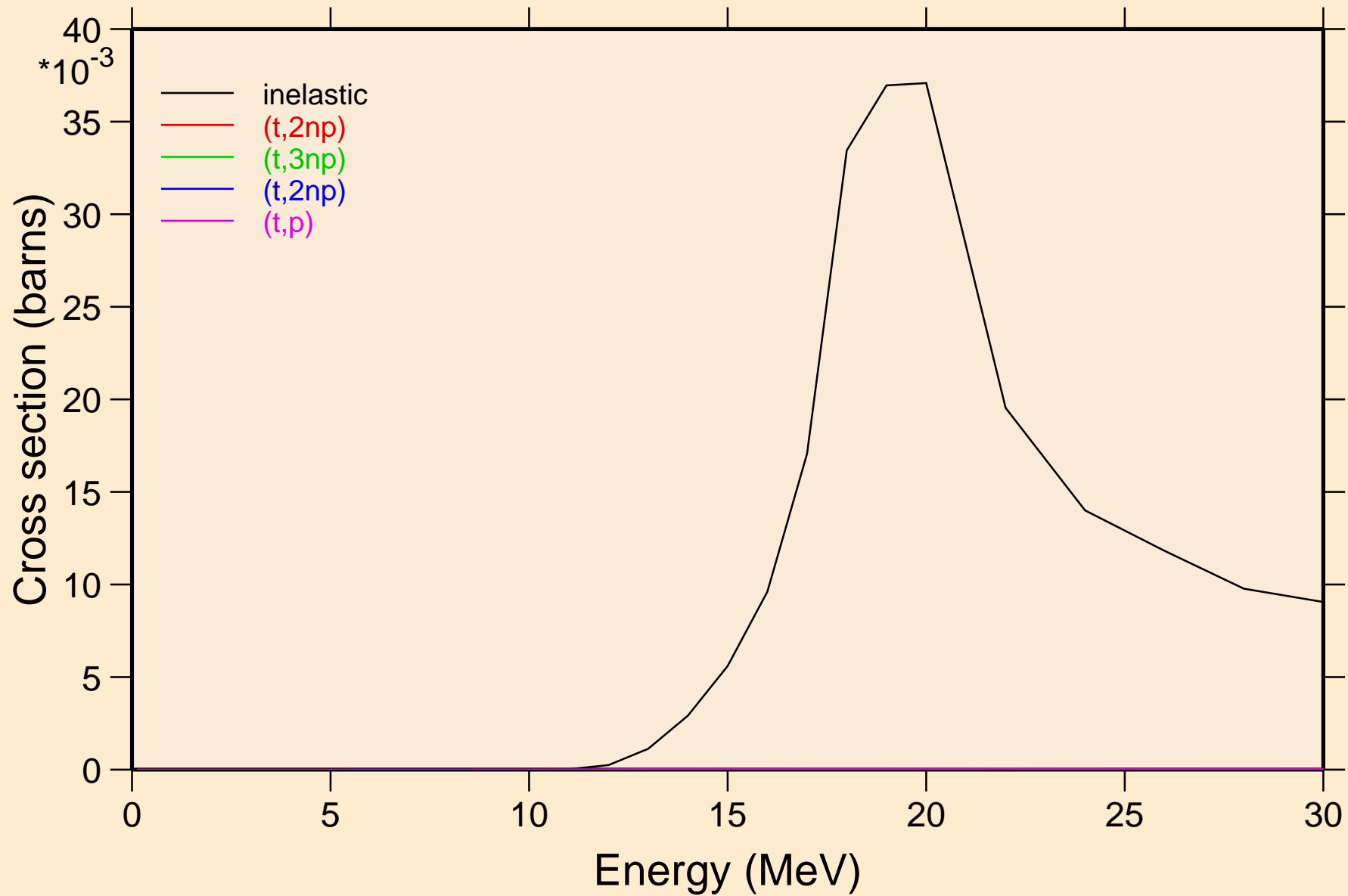

DB263 TRITON ACER TENDL-2021 LIBRARY; T=0.K  
Threshold reactions

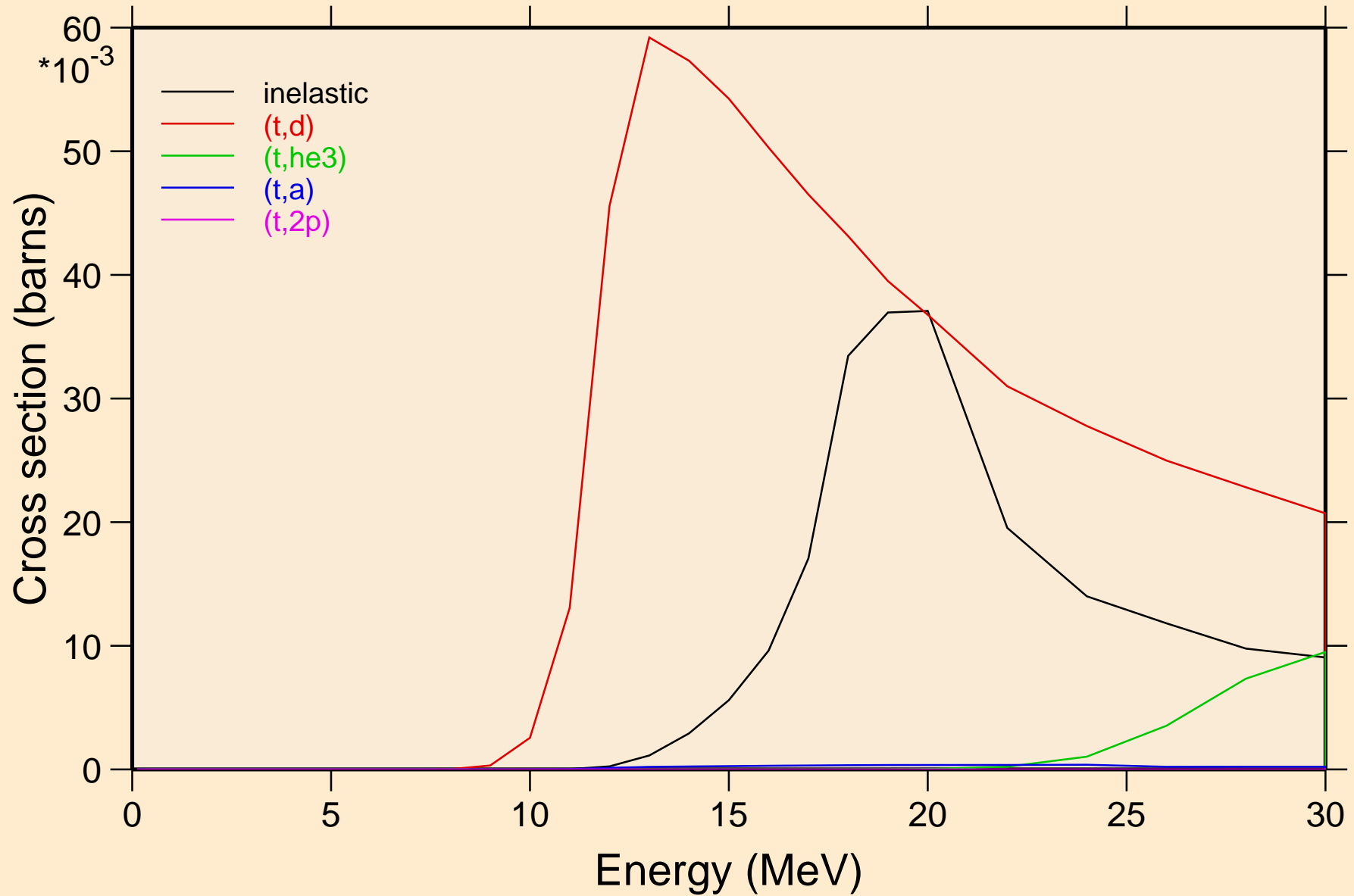

DB263 TRITON ACER TENDL-2021 LIBRARY; T=0.K  
Threshold reactions

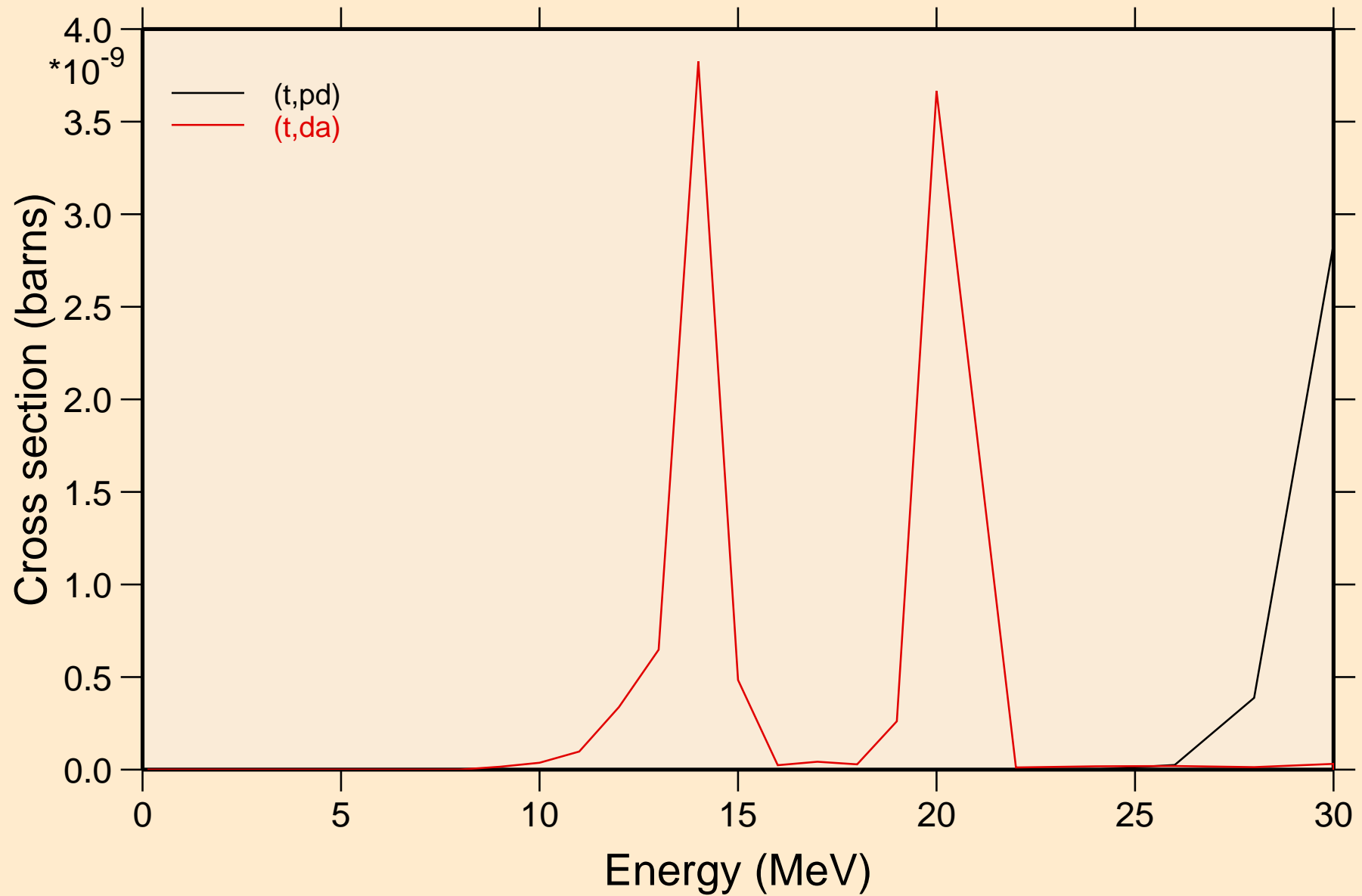

DB263 TRITON ACER TENDL-2021 LIBRARY; T=0.K  
angular distribution for elastic

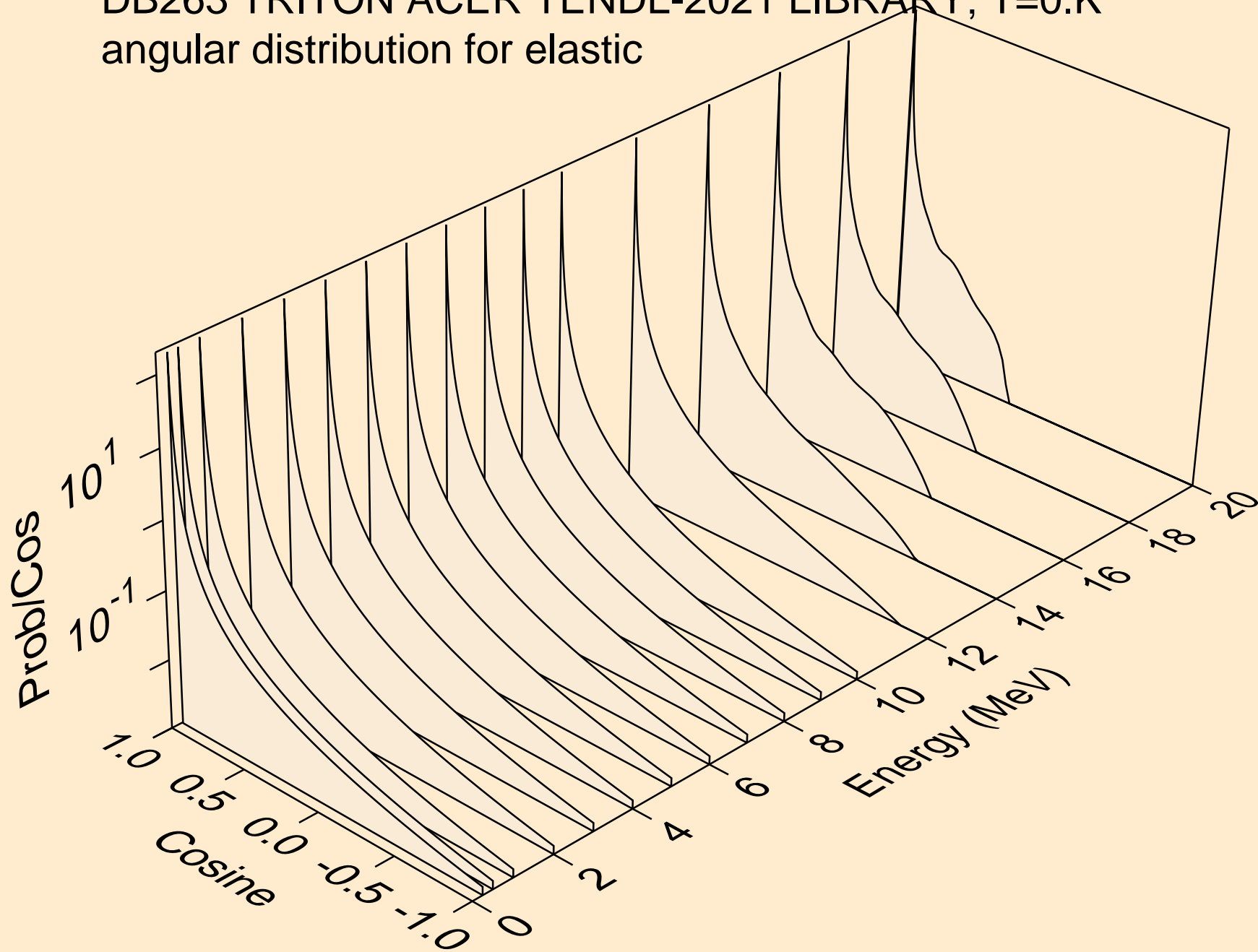

DB263 TRITON ACER TENDL-2021 LIBRARY; T=0.K  
angular distribution for elastic

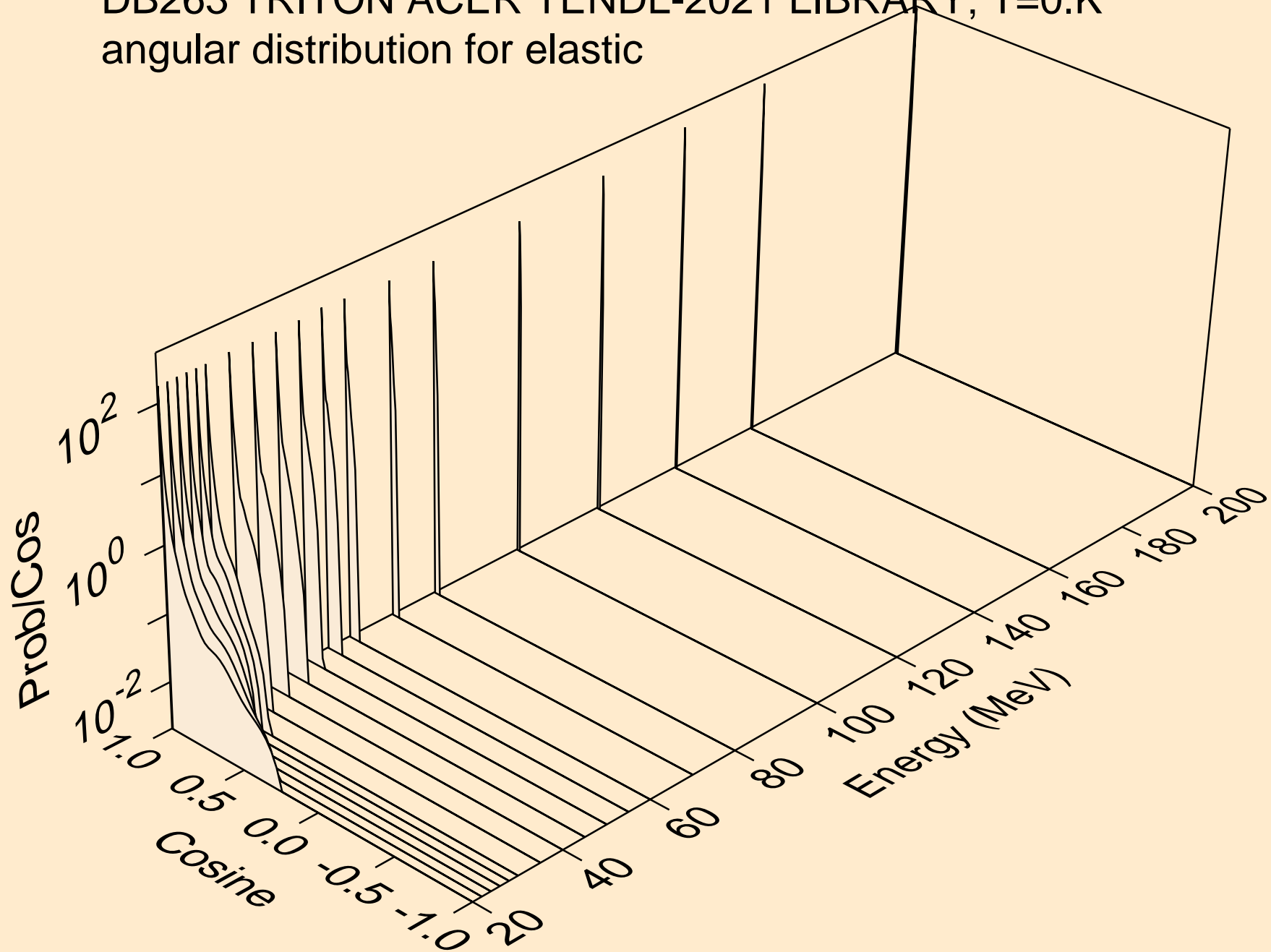

DB263 TRITON ACER TENDL-2021 LIBRARY; T=0.K  
Triton emission for (t,x)

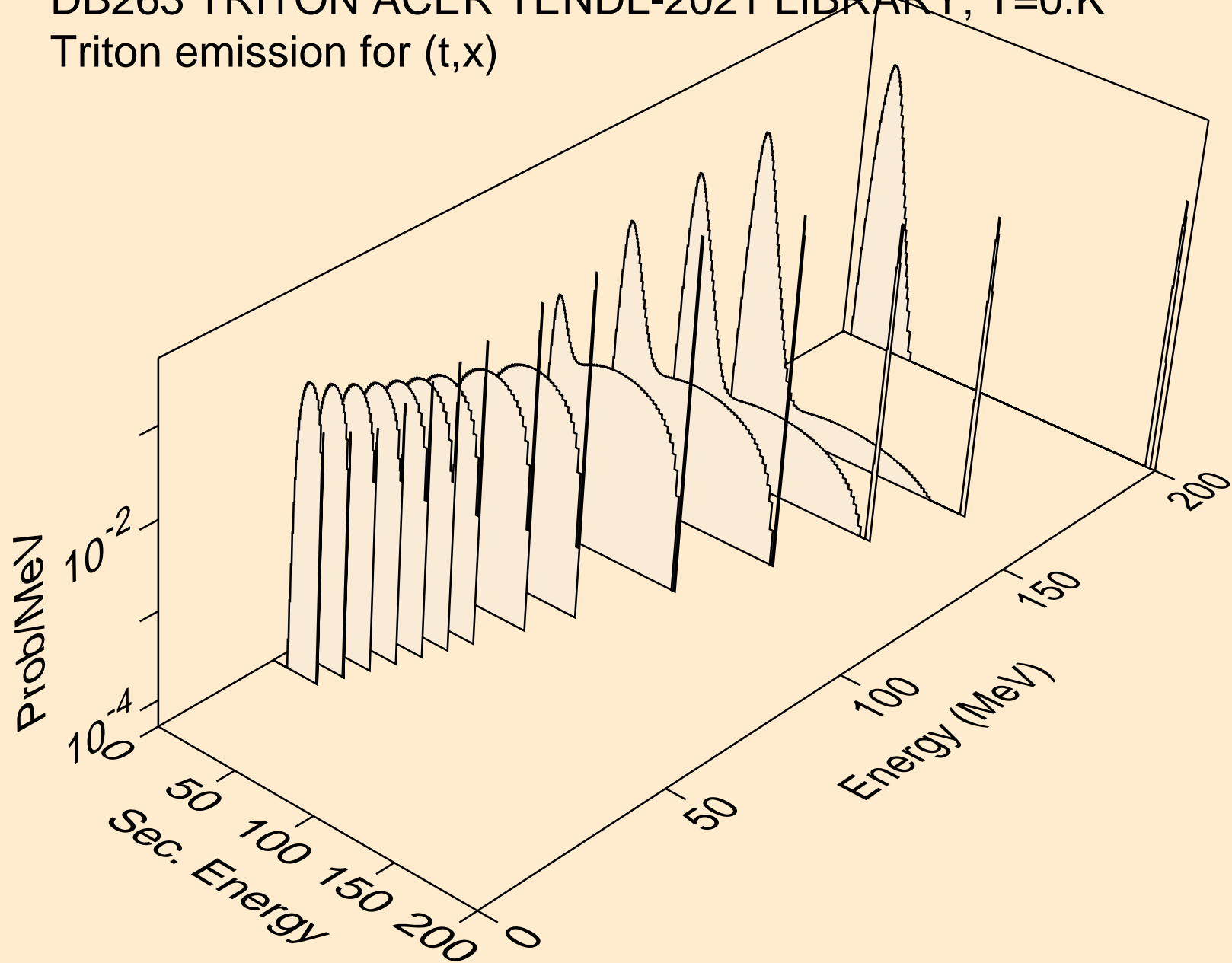

DB263 TRITON ACER TENDL-2021 LIBRARY; T=0.K  
Triton emission for (t,n\*)t

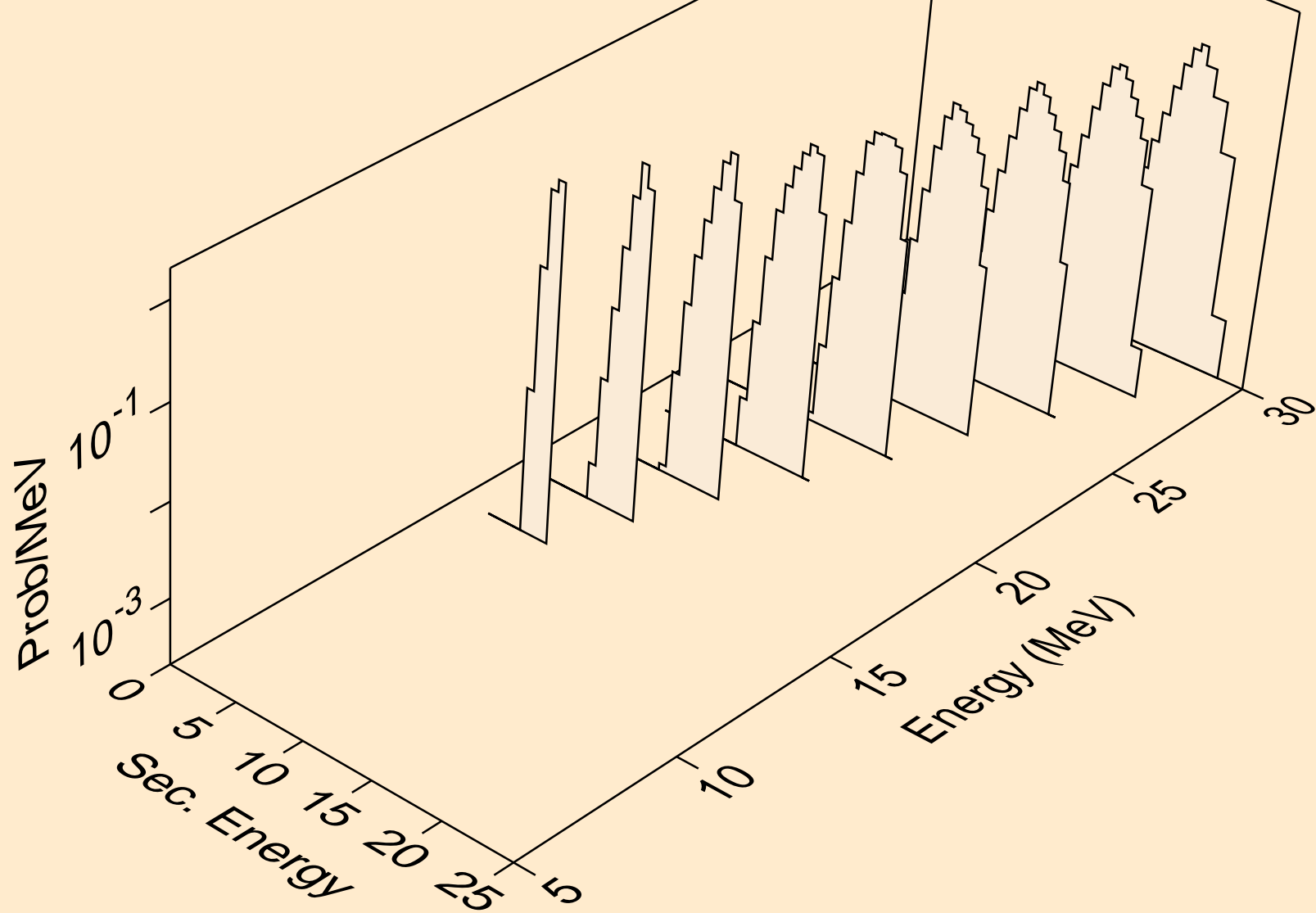

DB263 TRITON ACER TENDL-2021 LIBRARY; T=0.K  
Triton emission for (t,n\*)t2a

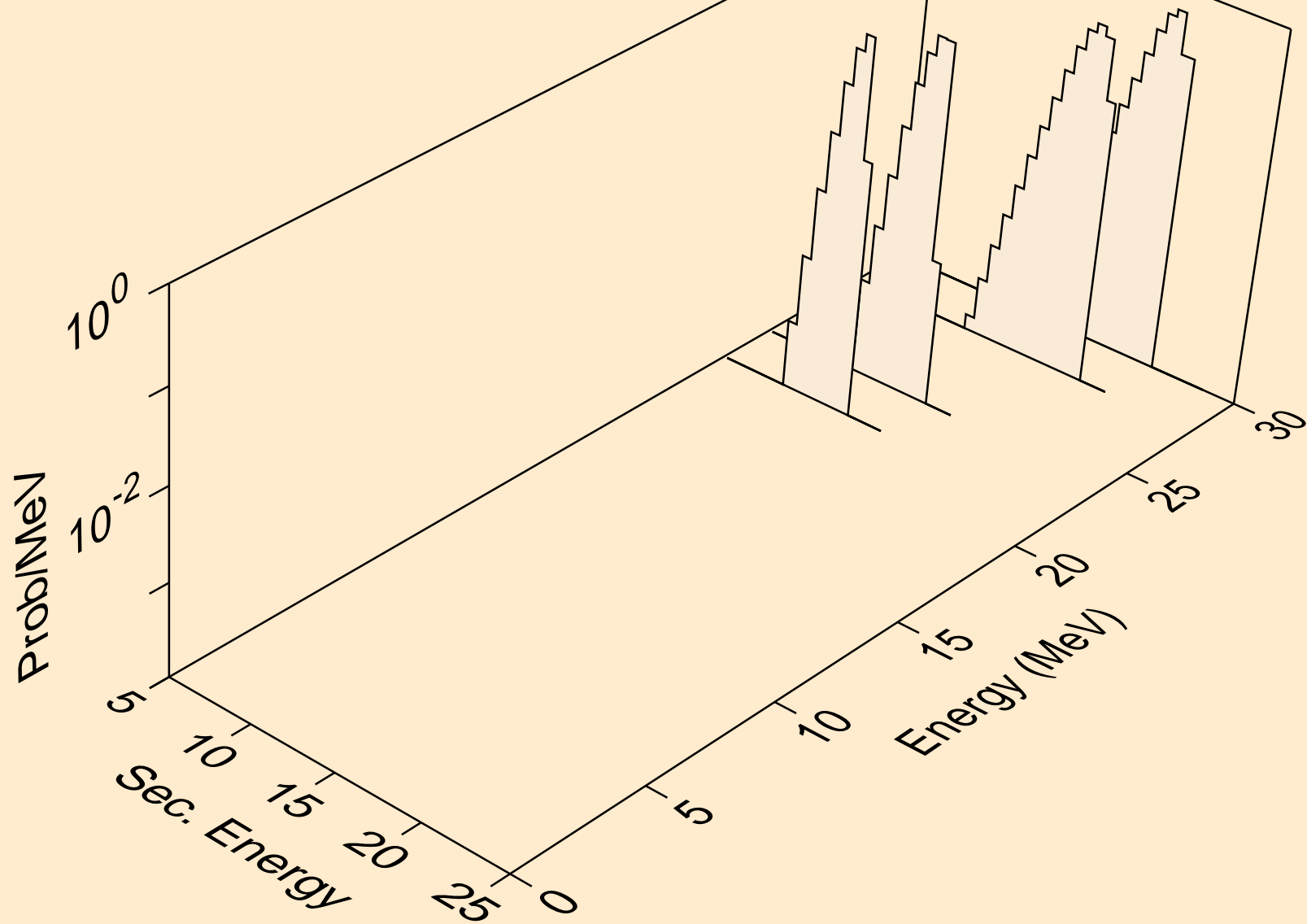



DB263 TRITON ACER TENDL-2021 LIBRARY; T=0.K  
Triton emission for inelastic

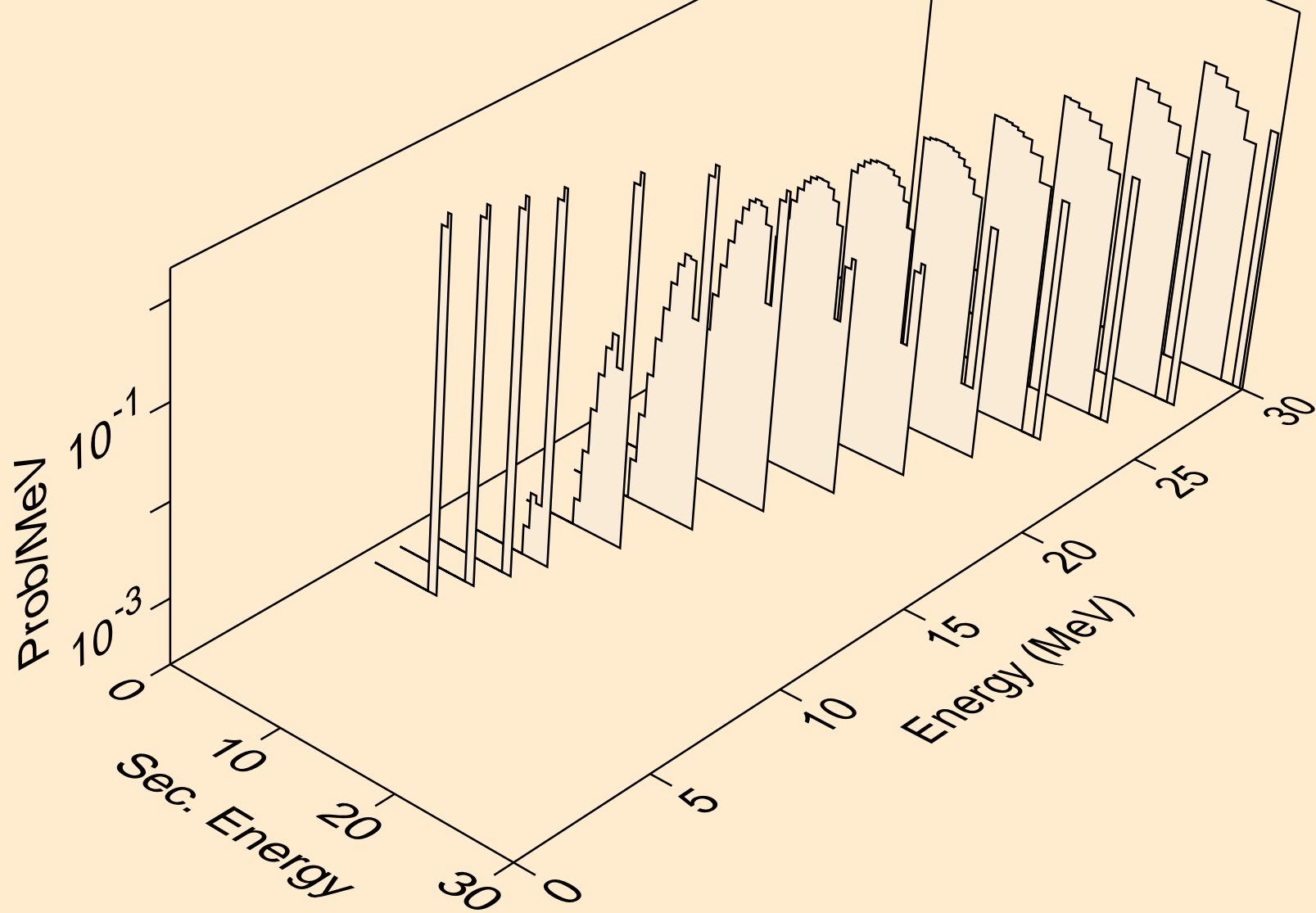

DB263 TRITON ACER TENDL-2021 LIBRARY; T=0.K  
Photon emission for (z,n)

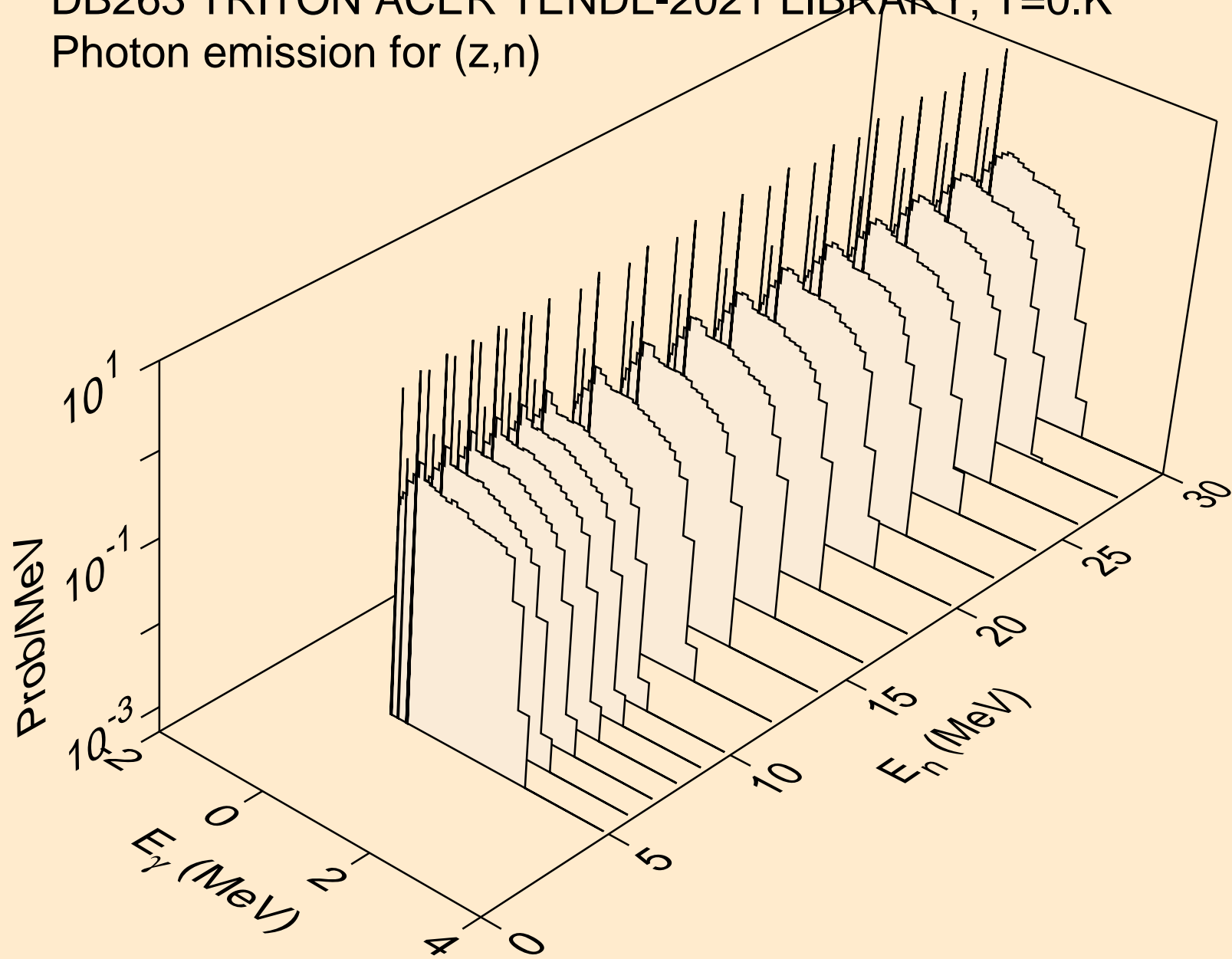

DB263 TRITON ACER TENDL-2021 LIBRARY; T=0.K  
Photon emission for (n,x)

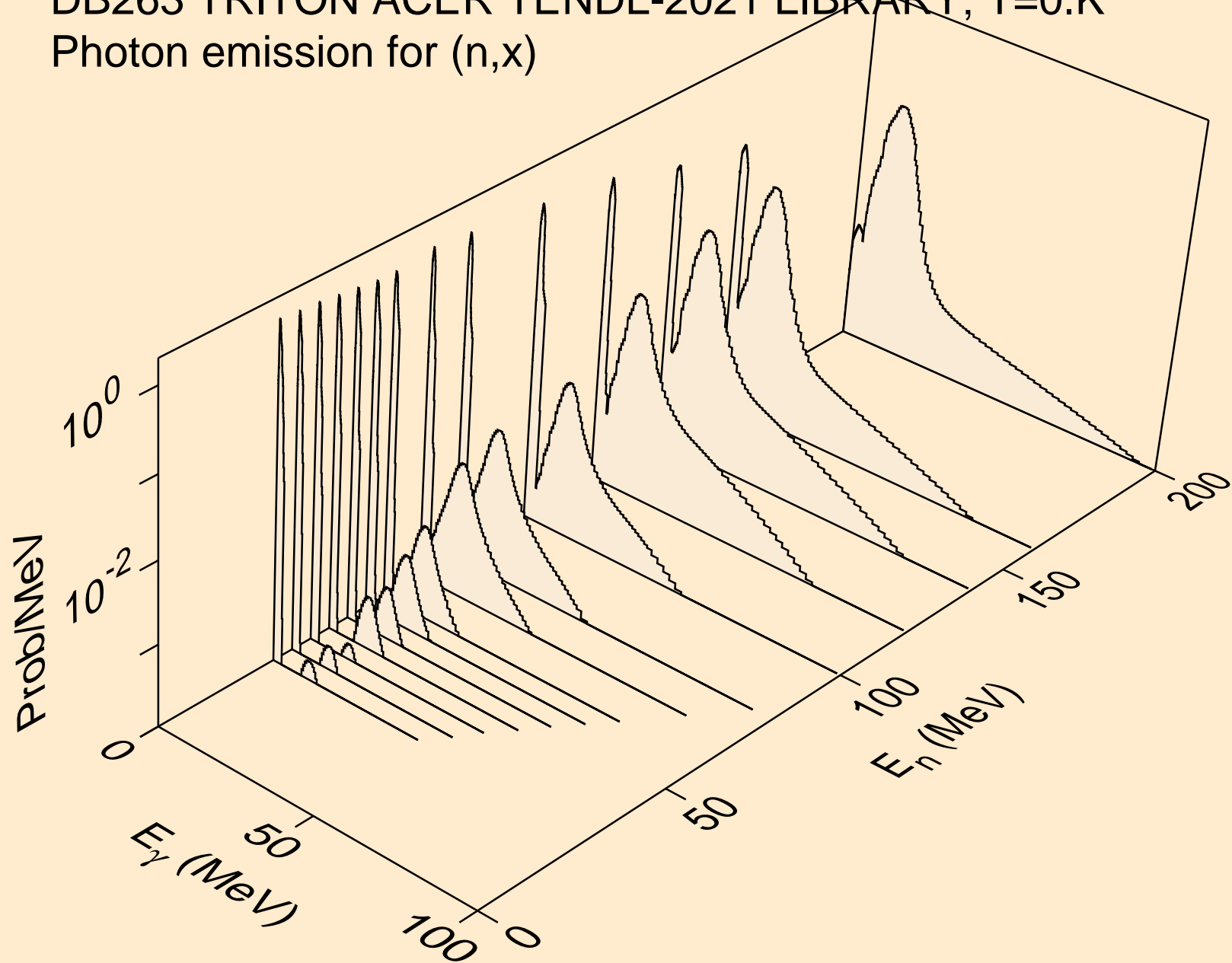

DB263 TRITON ACER TENDL-2021 LIBRARY; T=0.K  
Photon emission for (n,2n)

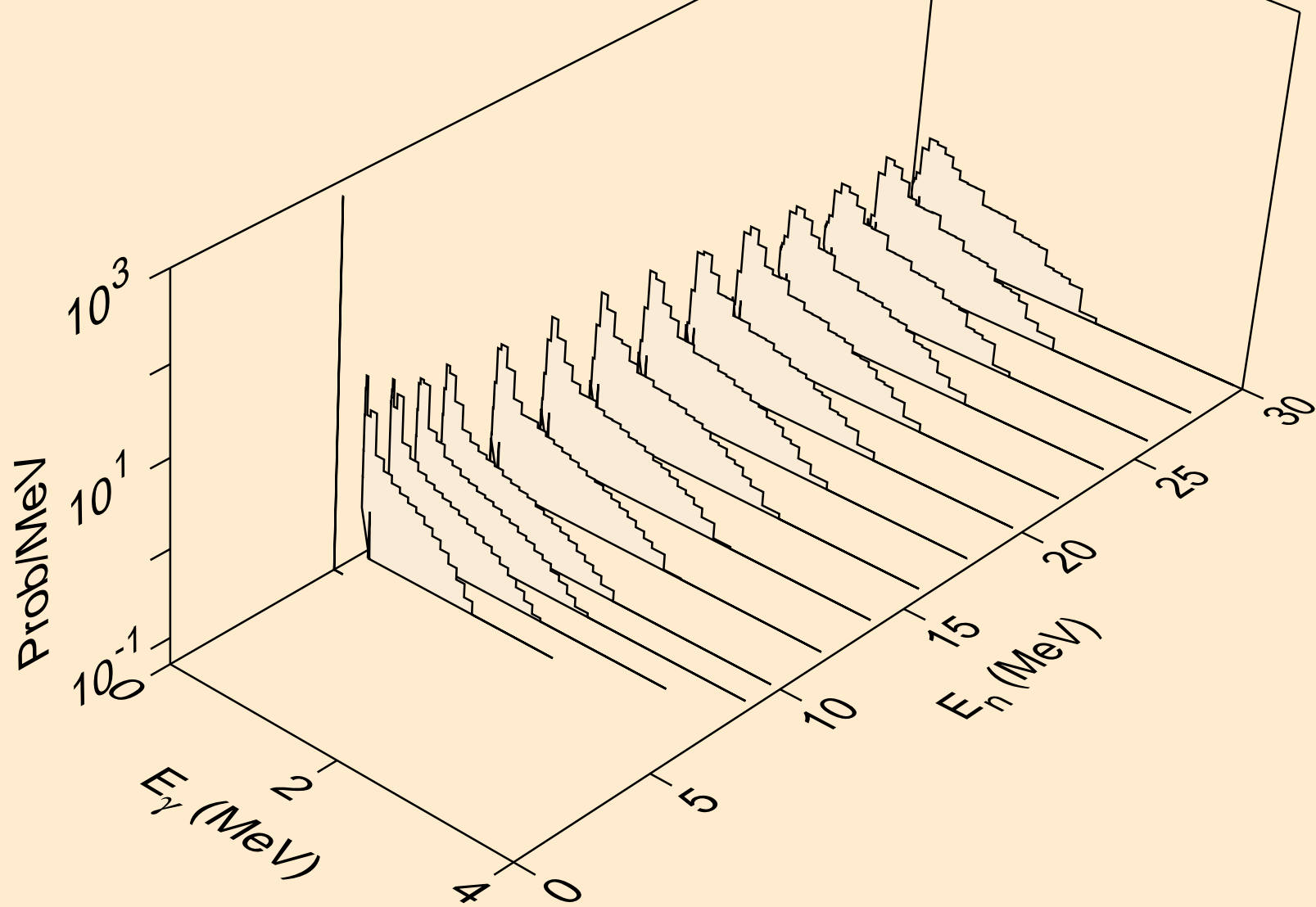

DB263 TRITON ACER TENDL-2021 LIBRARY; T=0.K  
Photon emission for (n,3n)

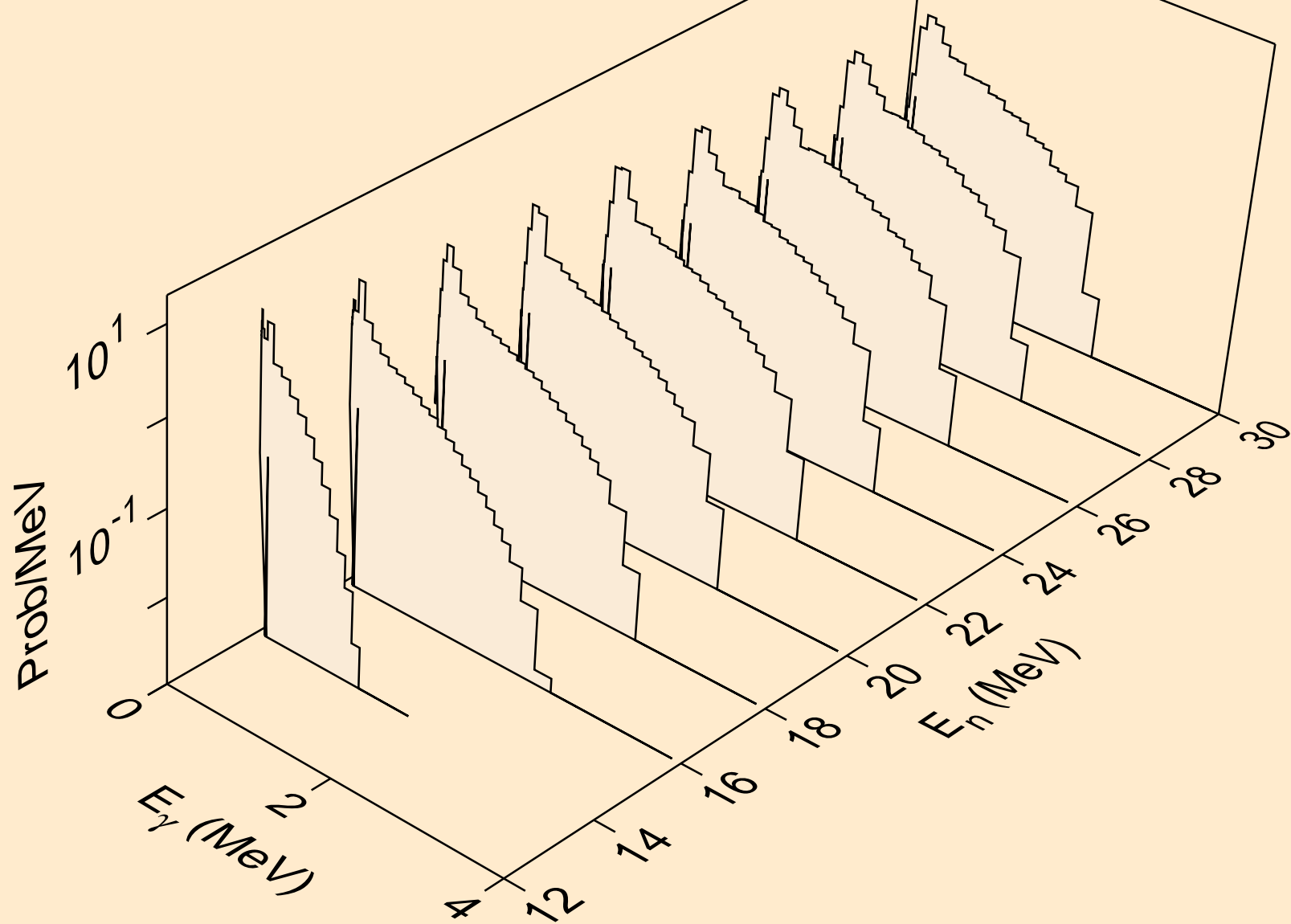

DB263 TRITON ACER TENDL-2021 LIBRARY; T=0.K  
Photon emission for (n,n\*)a

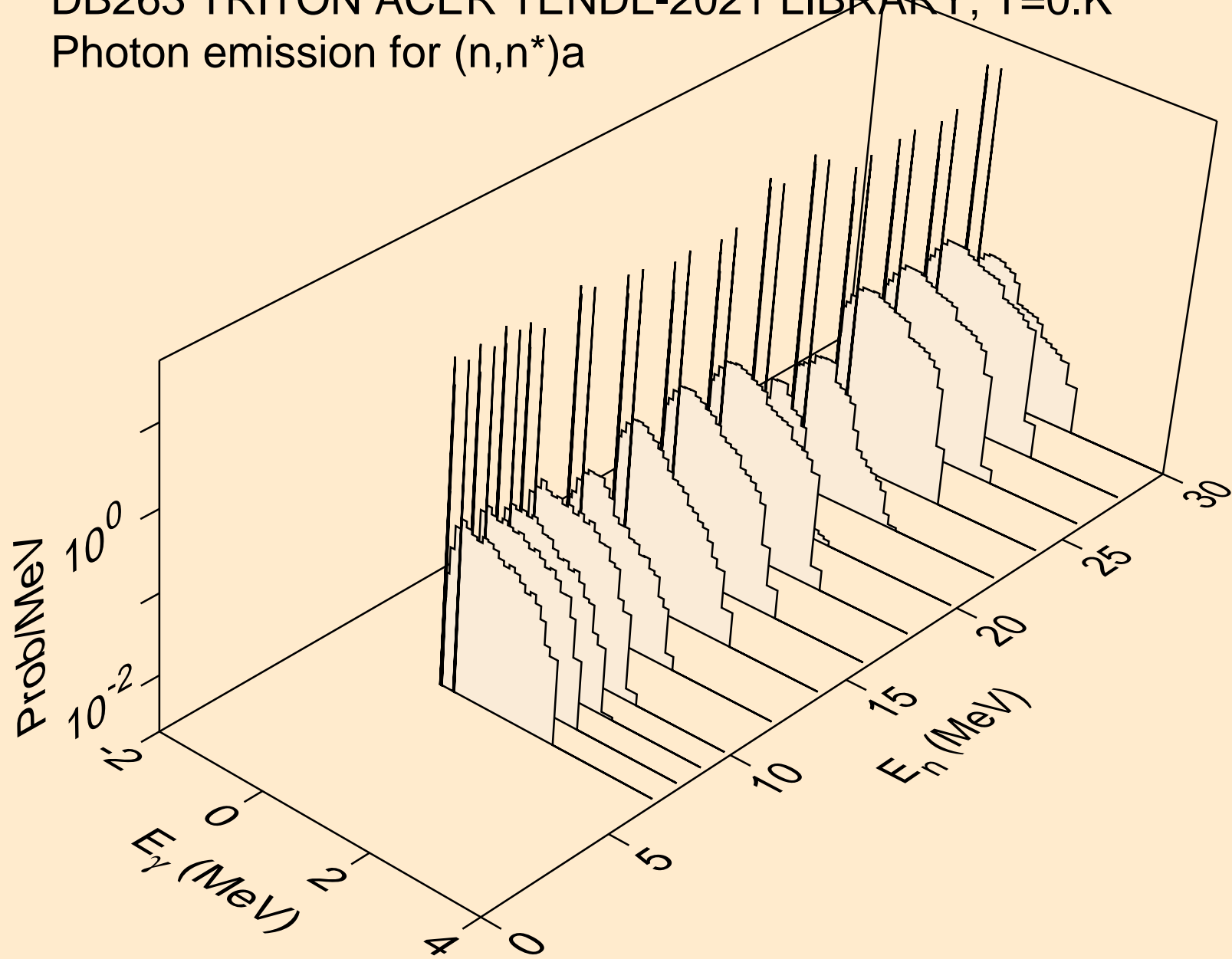

DB263 TRITON ACER TENDL-2021 LIBRARY; T=0.K  
Photon emission for (n,n\*)p

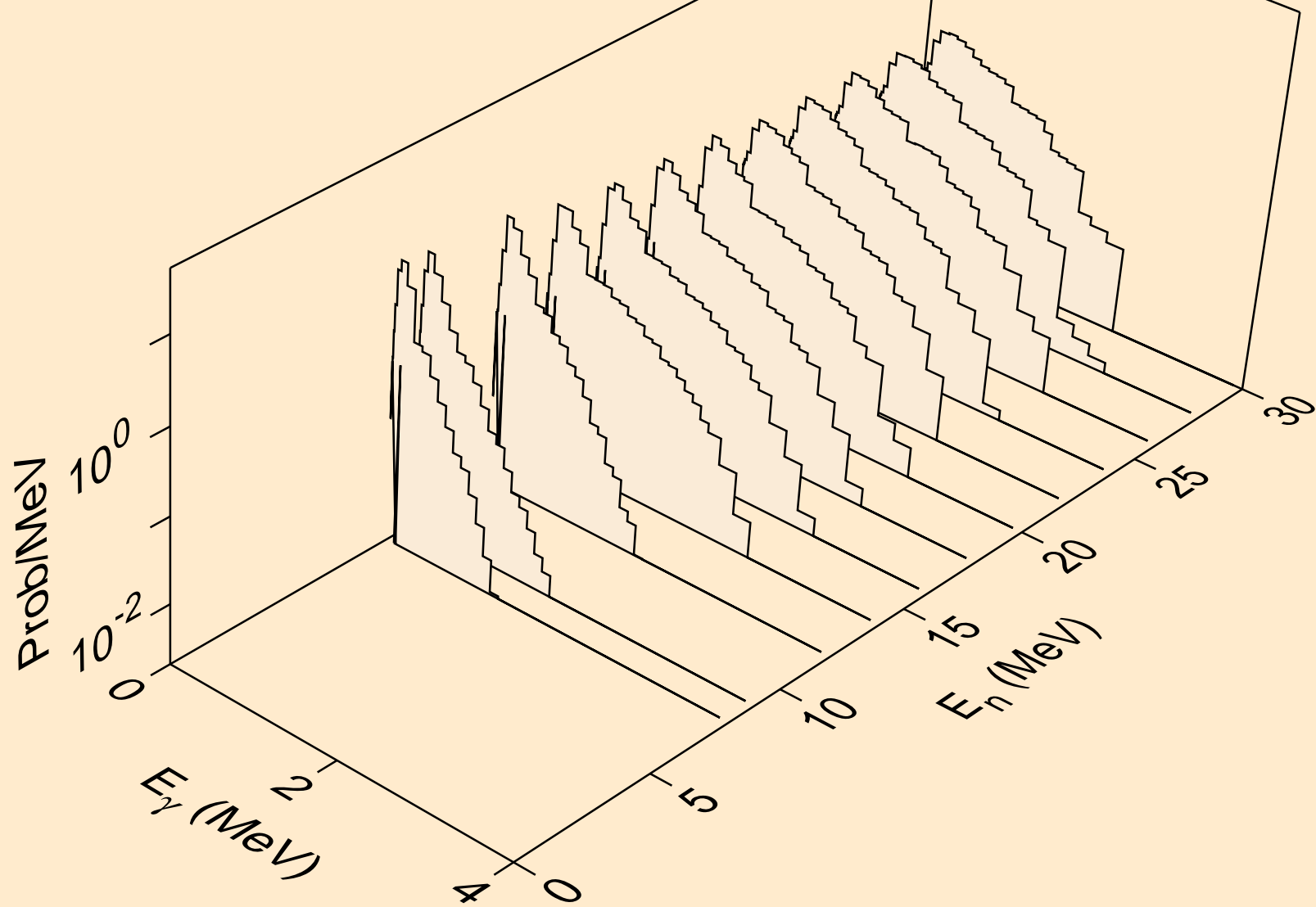

DB263 TRITON ACER TENDL-2021 LIBRARY; T=0.K  
Photon emission for (n,n\*)d

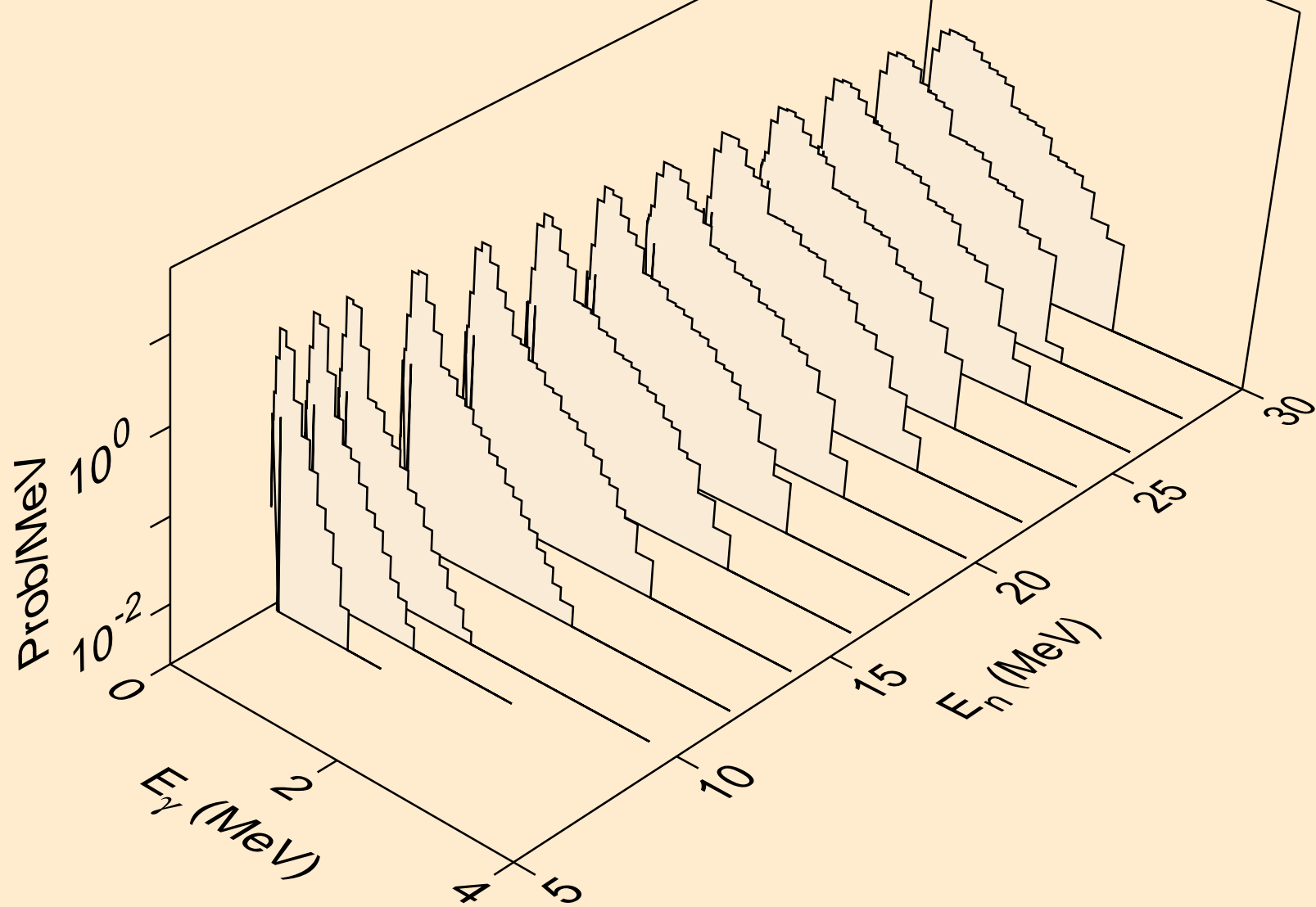



DB263 TRITON ACER TENDL-2021 LIBRARY; T=0.K  
Photon emission for (n,n\*)t

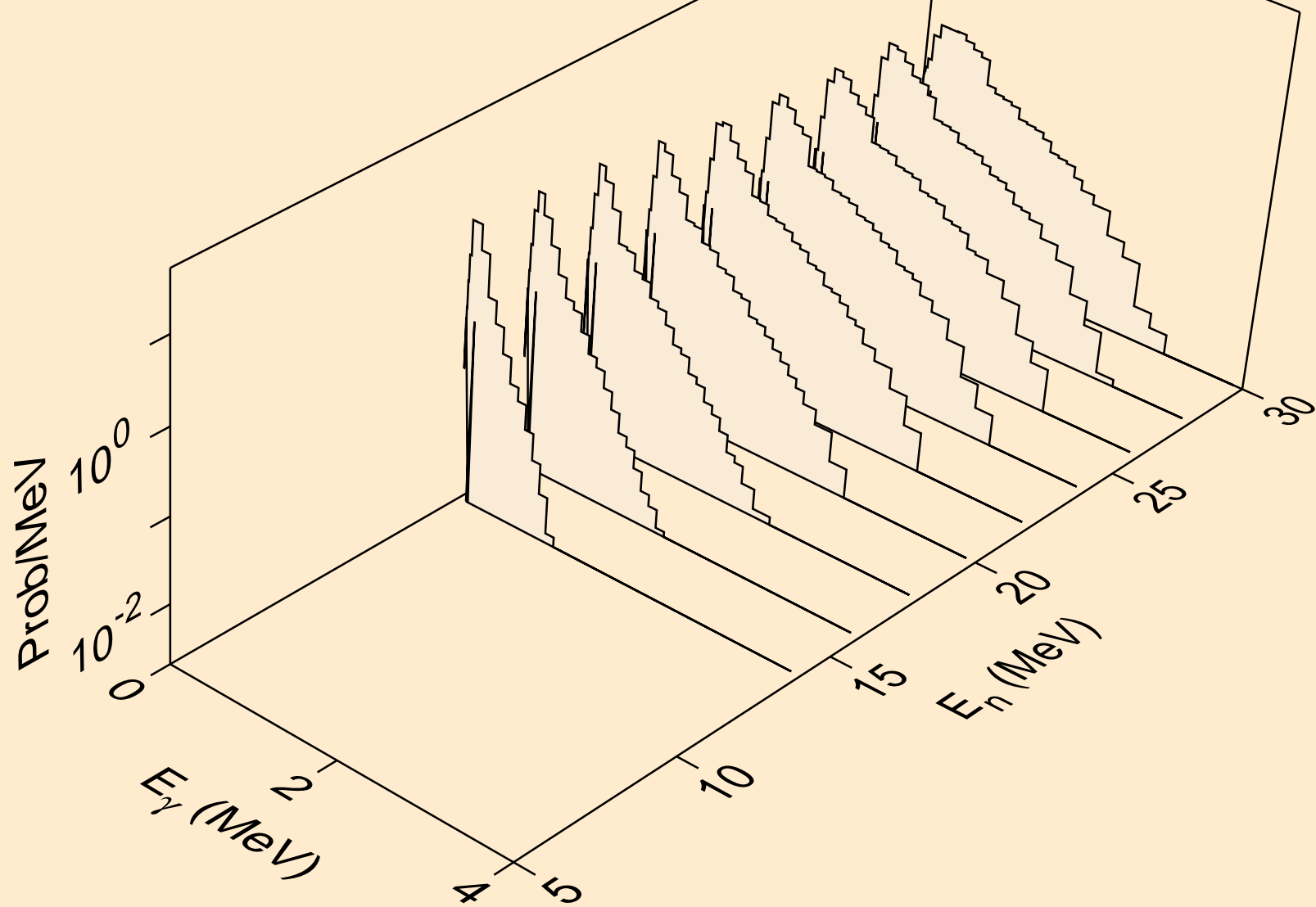

DB263 TRITON ACER TENDL-2021 LIBRARY; T=0.K  
Photon emission for (n,n\*)he3

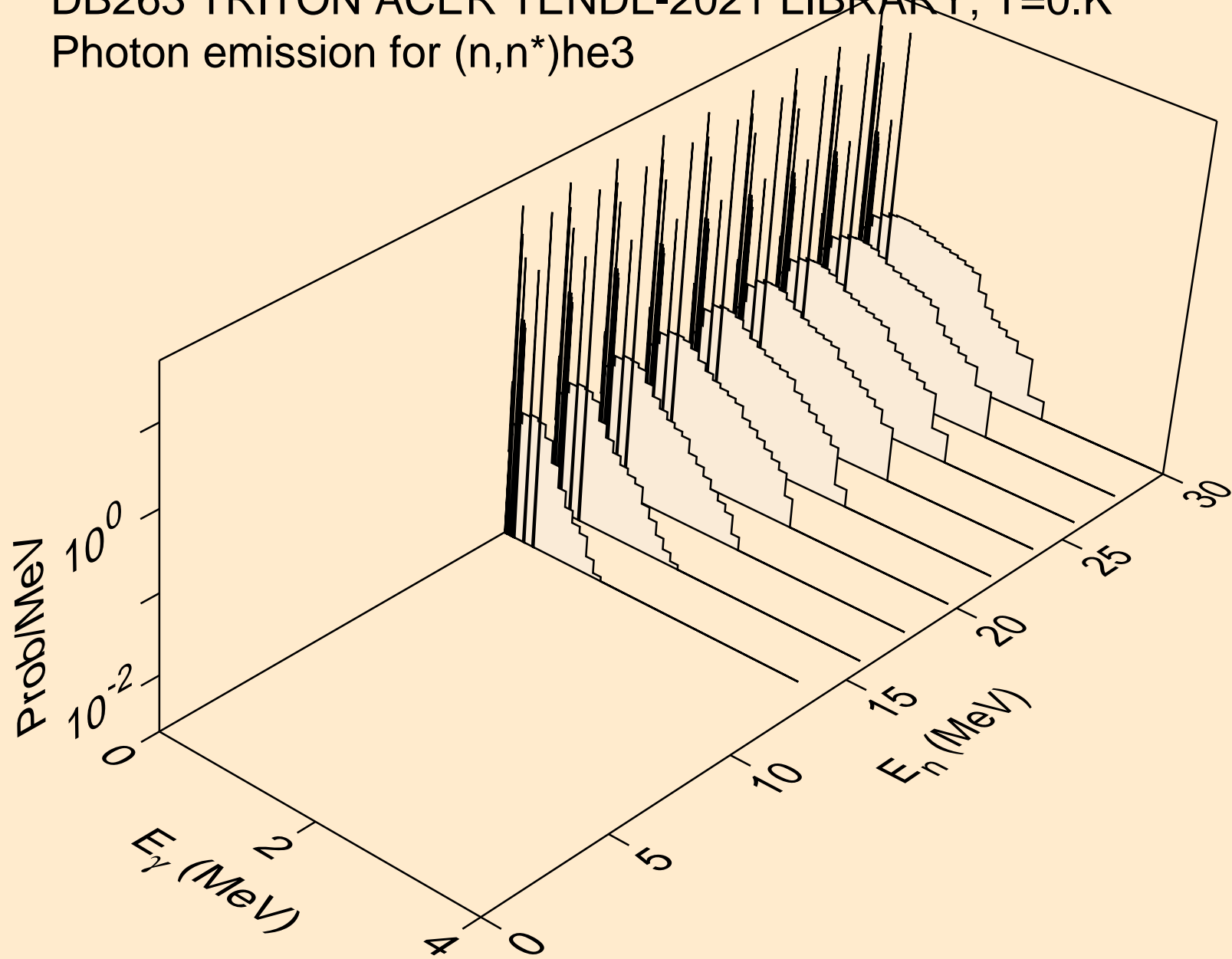

DB263 TRITON ACER TENDL-2021 LIBRARY; T=0.K  
Photon emission for (n,n\*)t2a

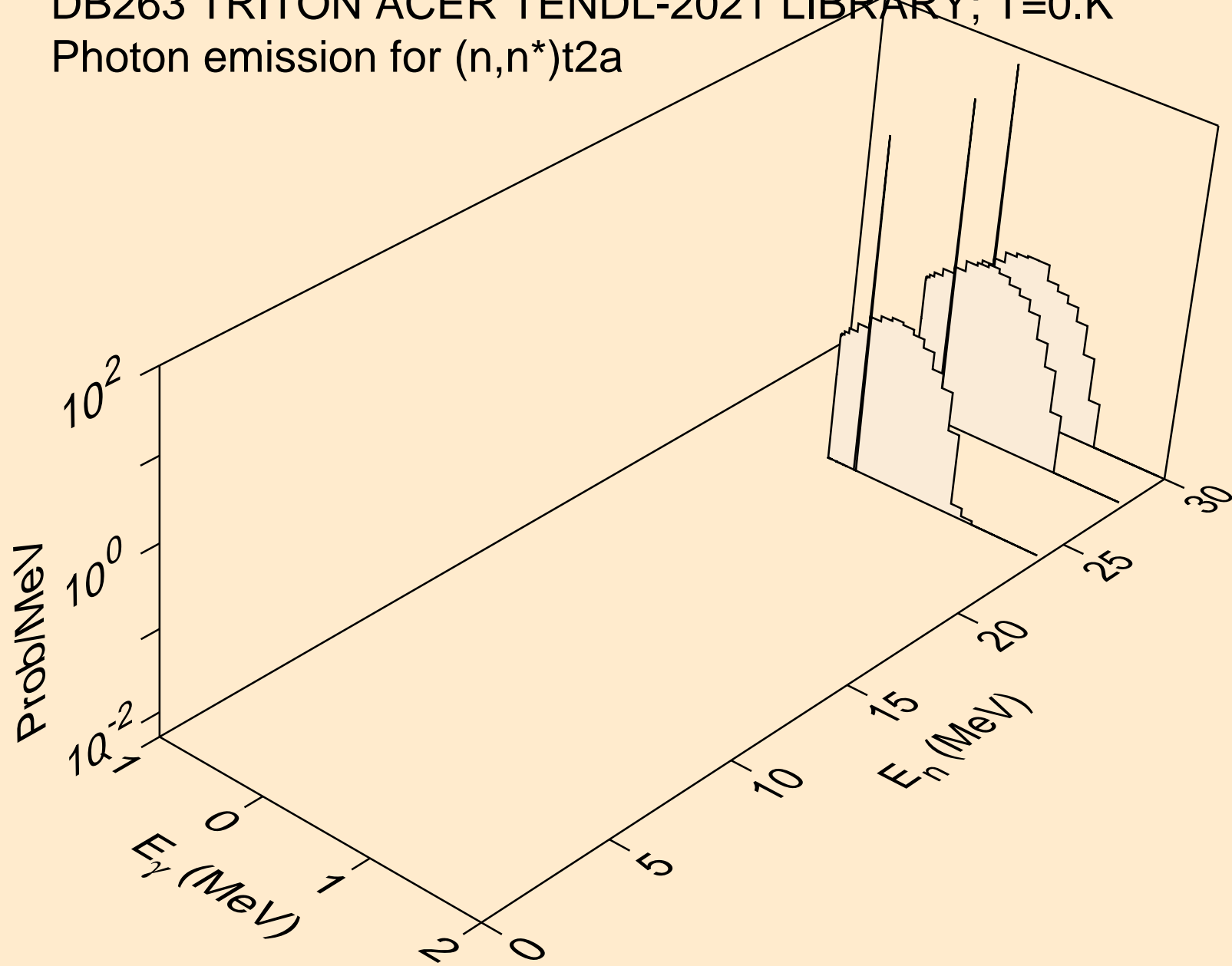

DB263 TRITON ACER TENDL-2021 LIBRARY; T=0.K  
Photon emission for (n,4n)

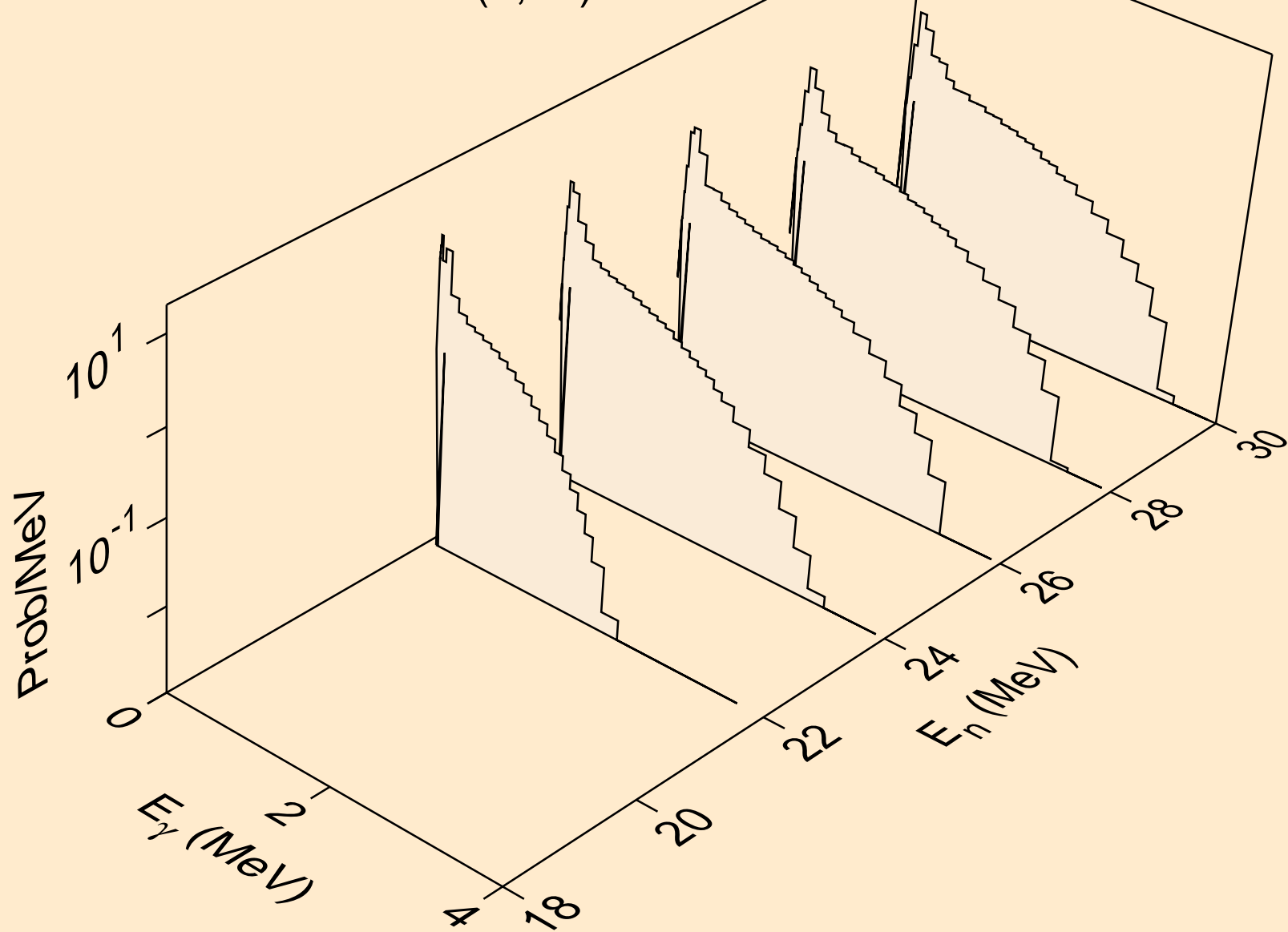

DB263 TRITON ACER TENDL-2021 LIBRARY; T=0.K  
Photon emission for (n,2np)

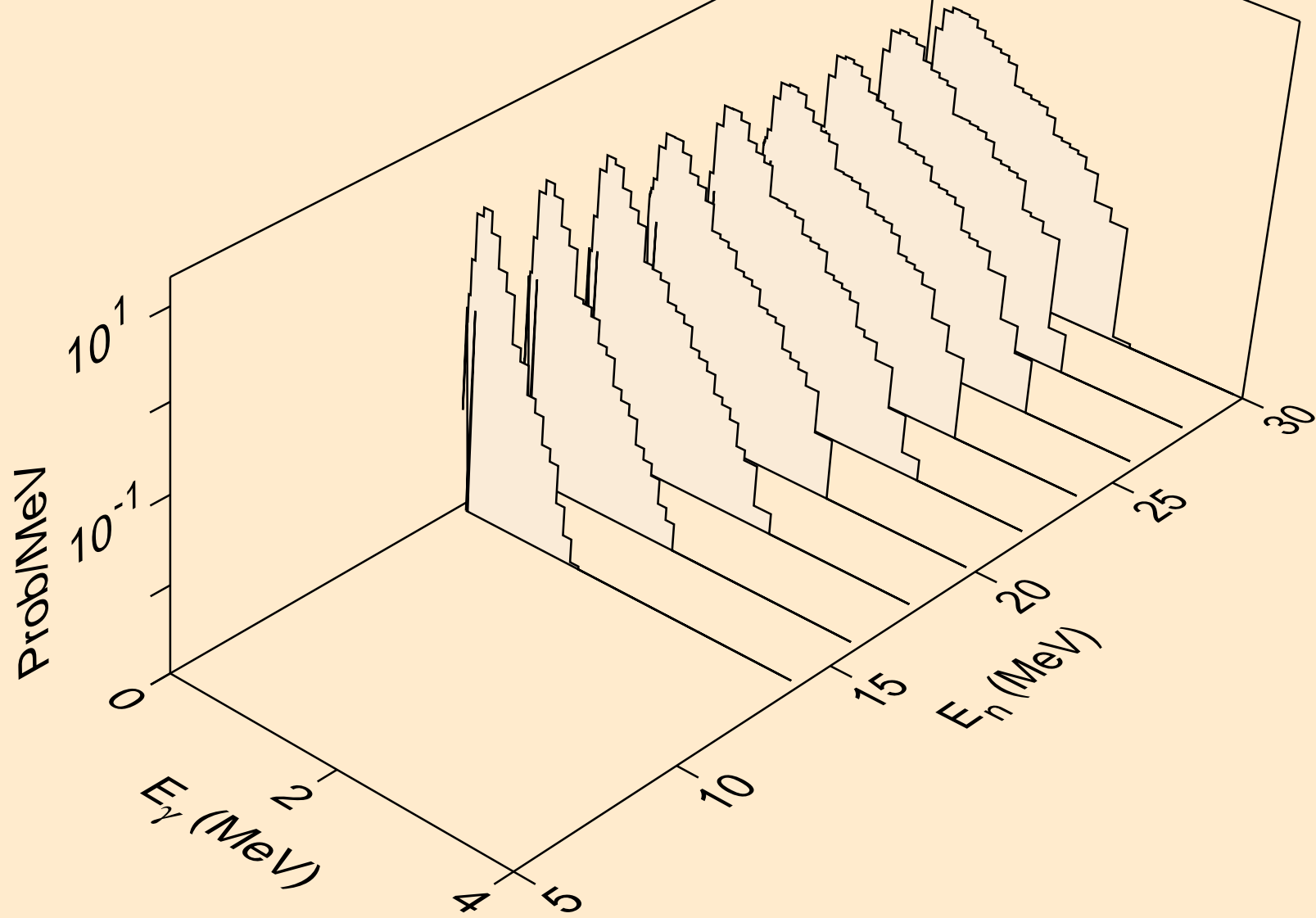

DB263 TRITON ACER TENDL-2021 LIBRARY; T=0.K  
Photon emission for (n,3np)

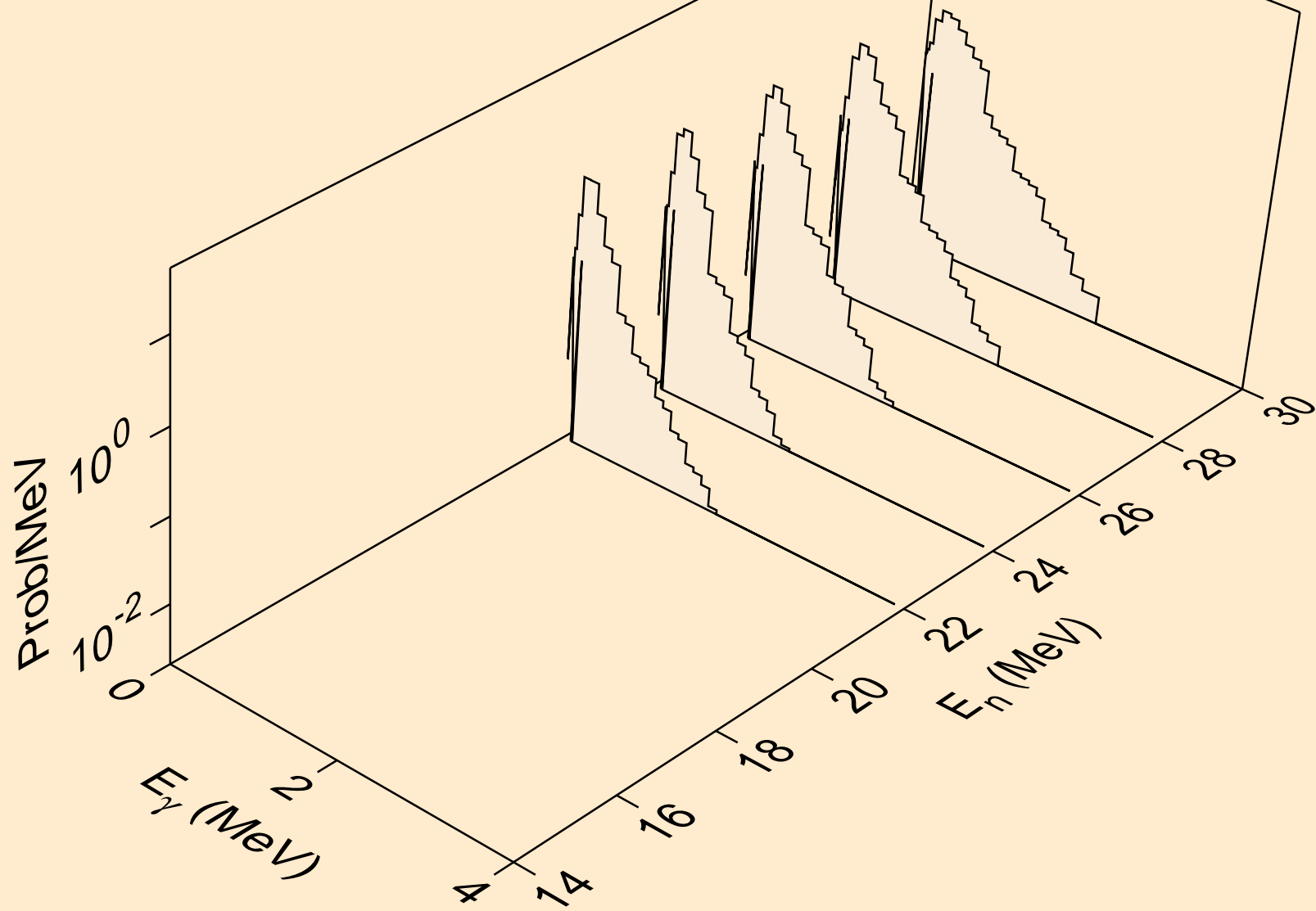

DB263 TRITON ACER TENDL-2021 LIBRARY; T=0.K  
Photon emission for (n,2np)

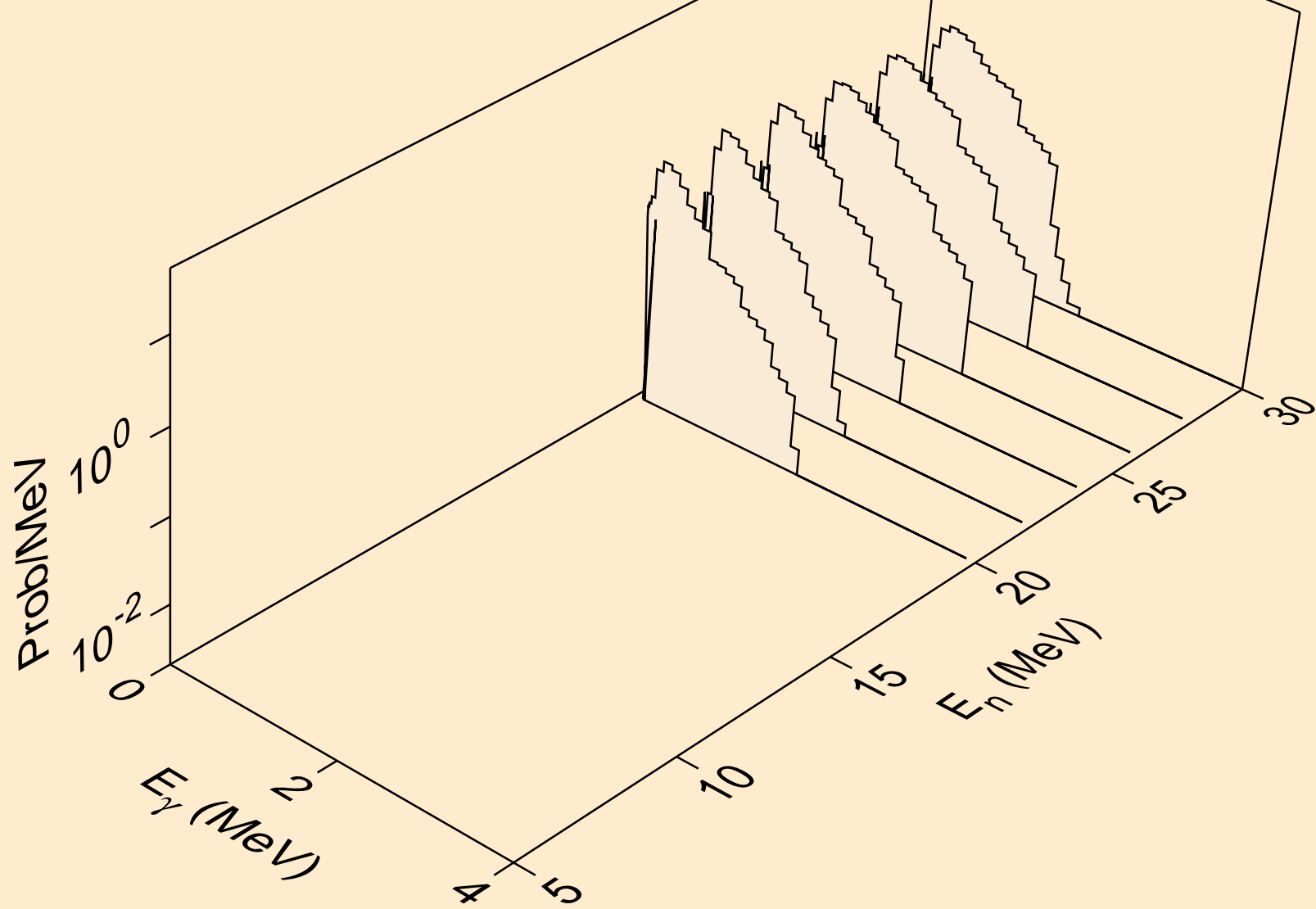

DB263 TRITON ACER TENDL-2021 LIBRARY; T=0.K  
Photon emission for (n,p)

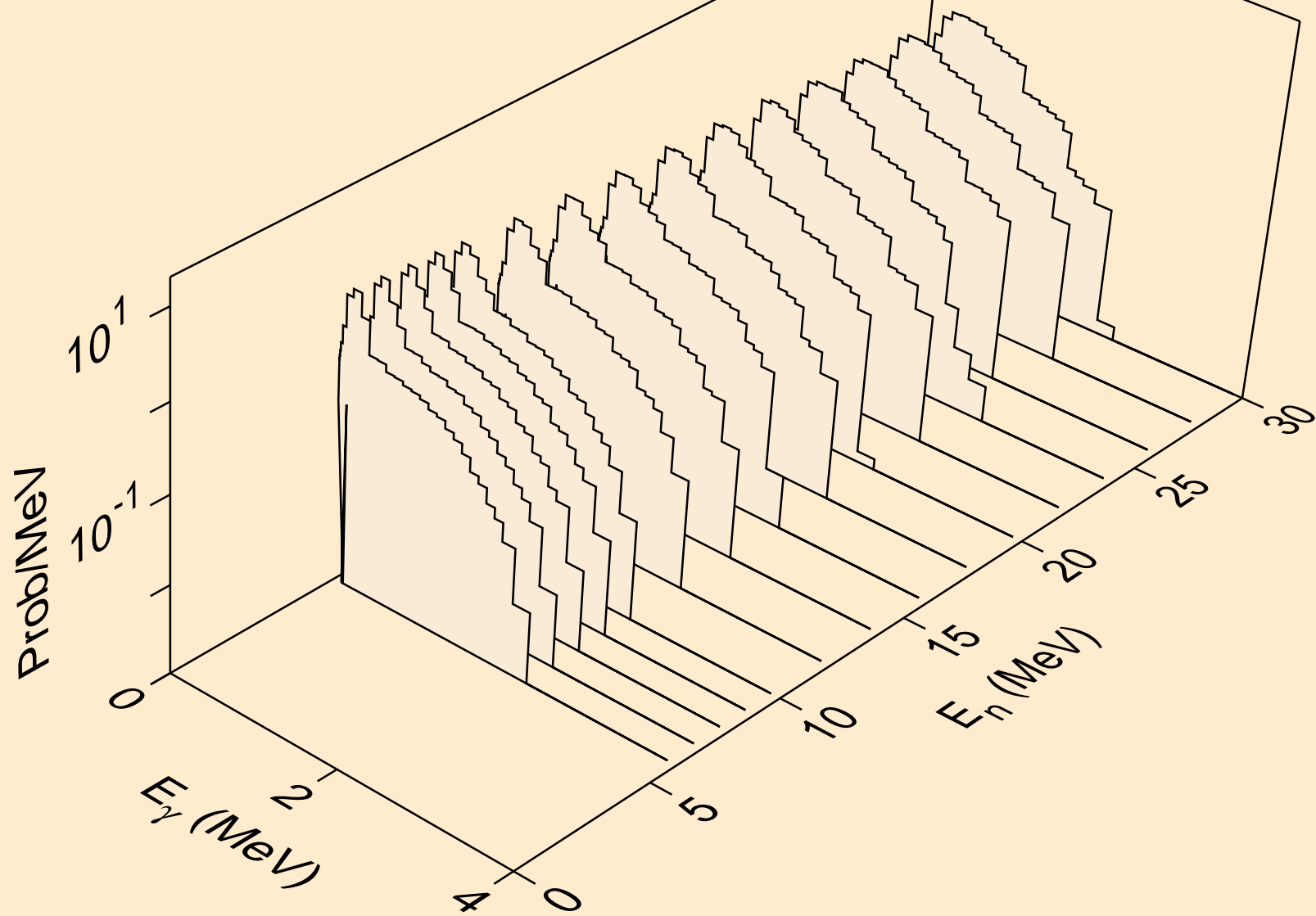



DB263 TRITON ACER TENDL-2021 LIBRARY; T=0.K  
Photon emission for (n,d)

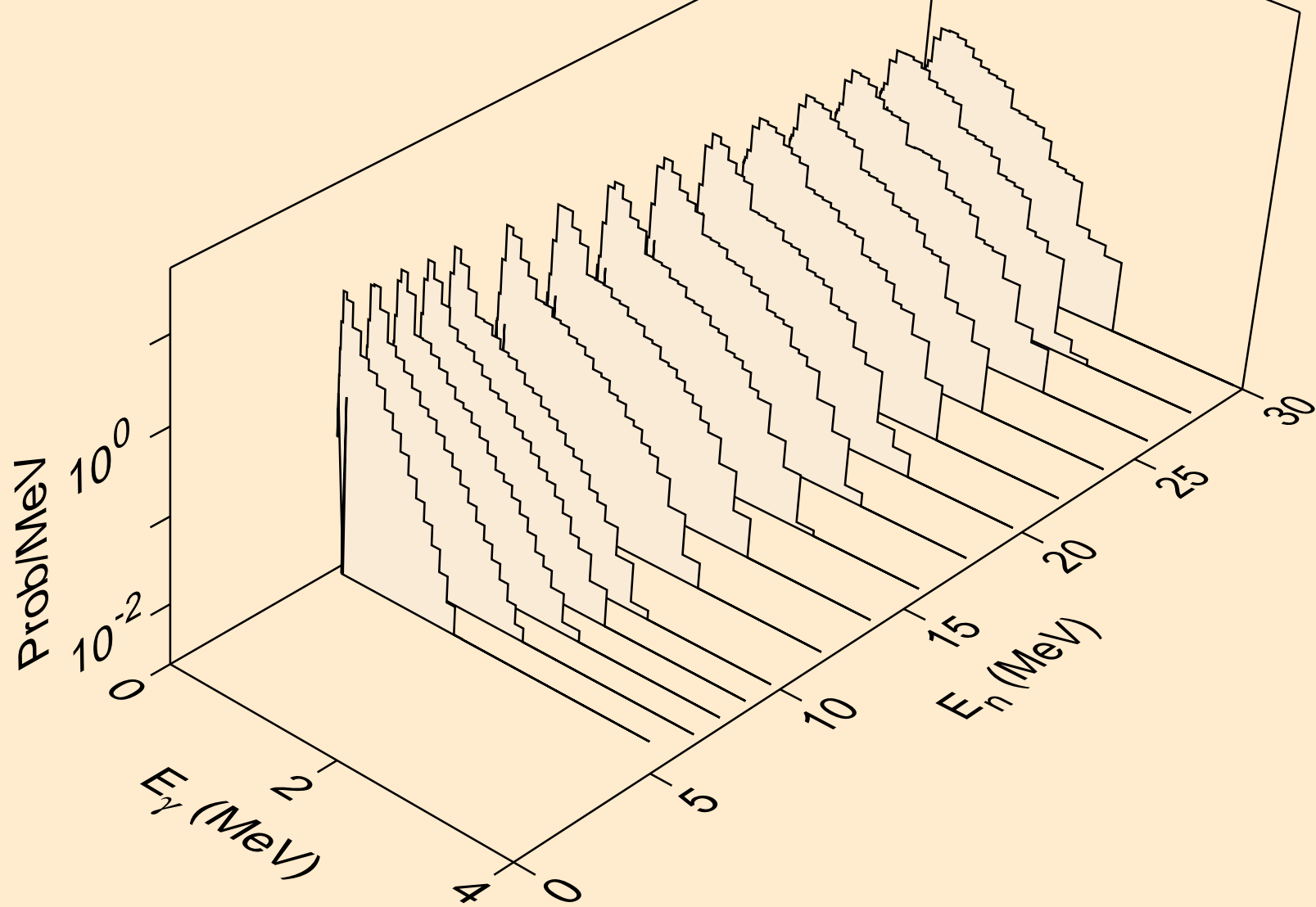

DB263 TRITON ACER TENDL-2021 LIBRARY; T=0.K  
Photon emission for inelastic

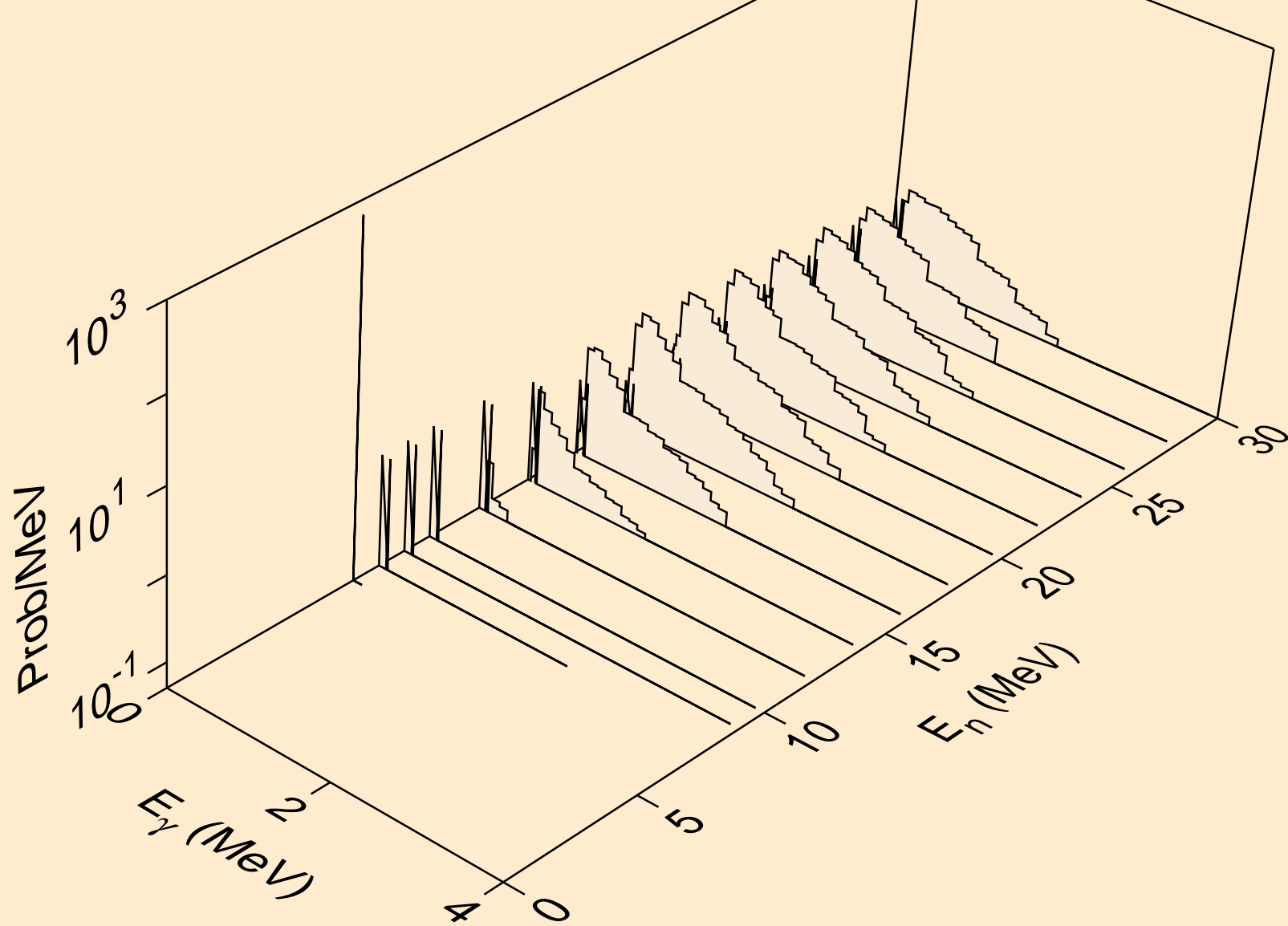

DB263 TRITON ACER TENDL-2021 LIBRARY; T=0.K  
Photon emission for (n,he3)

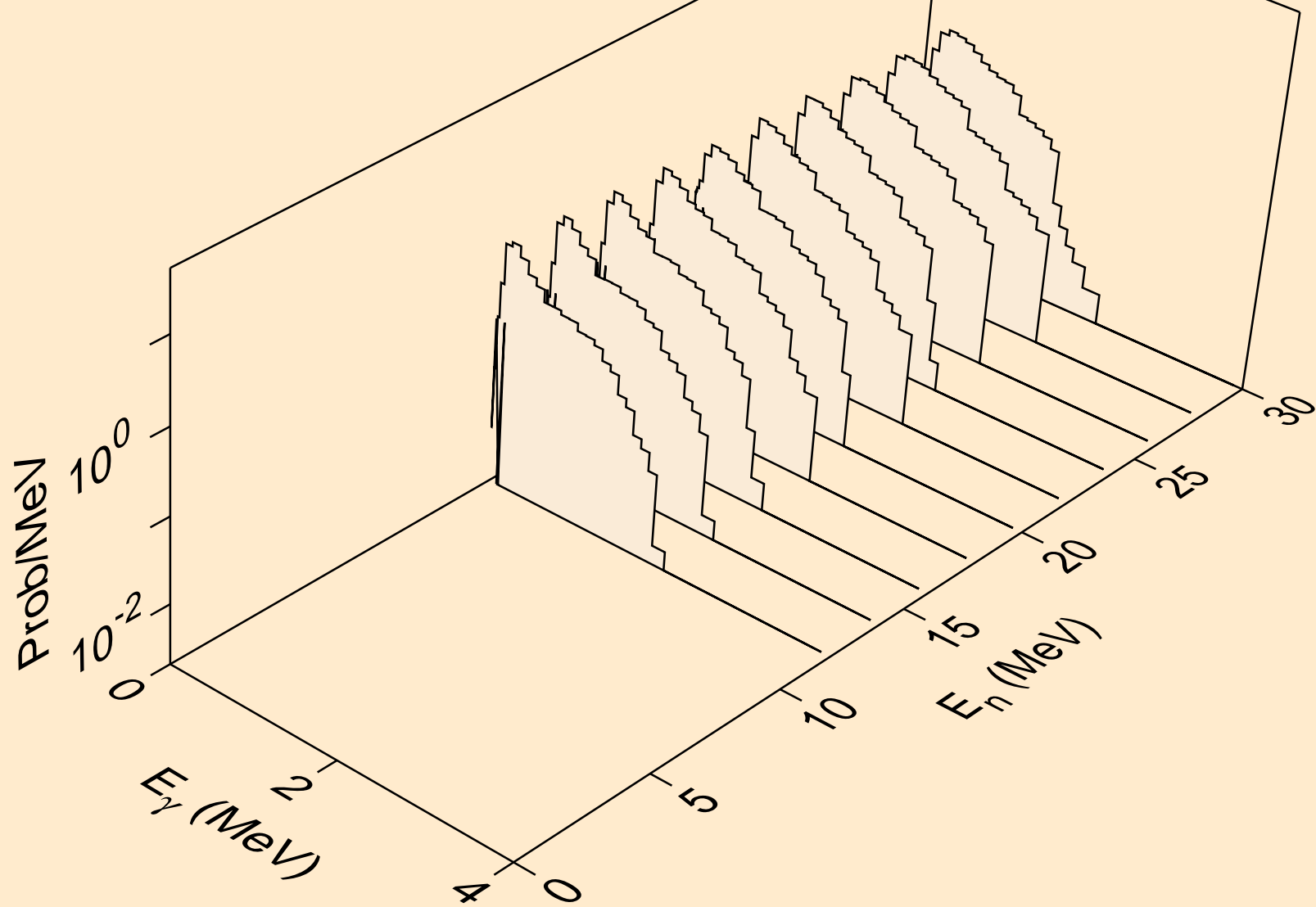

DB263 TRITON ACER TENDL-2021 LIBRARY; T=0.K  
Photon emission for (n,a)

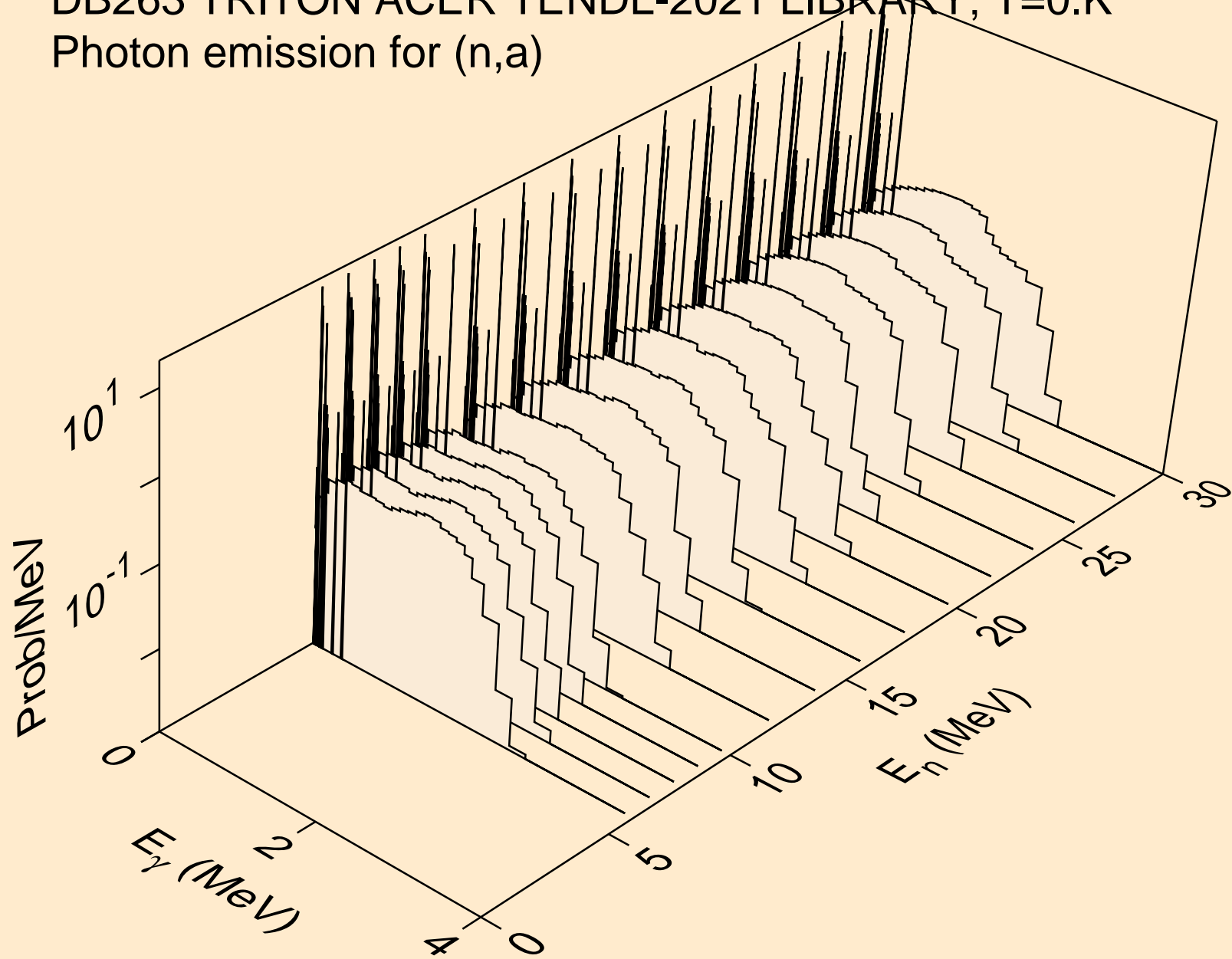

DB263 TRITON ACER TENDL-2021 LIBRARY; T=0.K  
Photon emission for (n,2p)

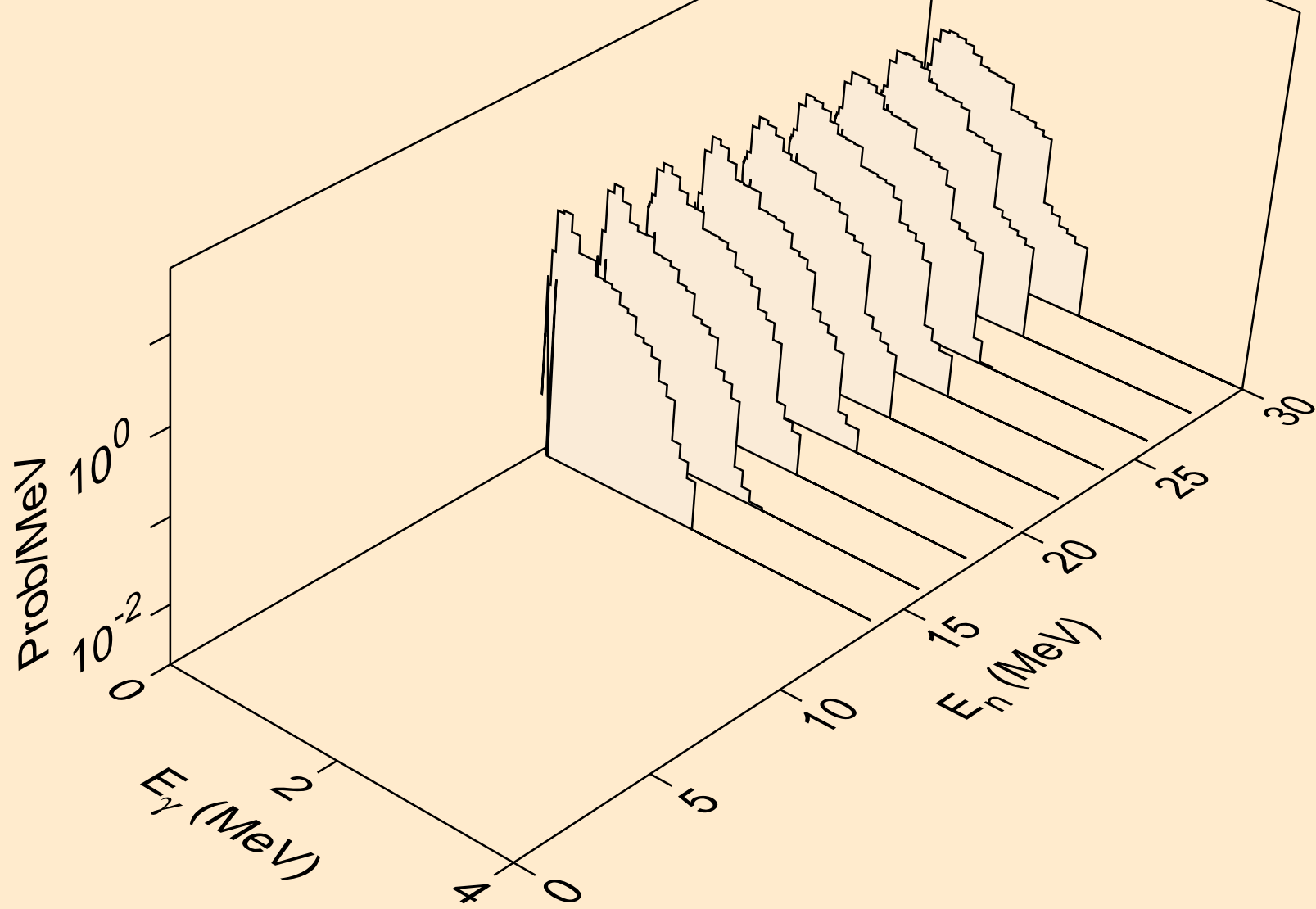

DB263 TRITON ACER TENDL-2021 LIBRARY; T=0.K  
Photon emission for (n,pd)

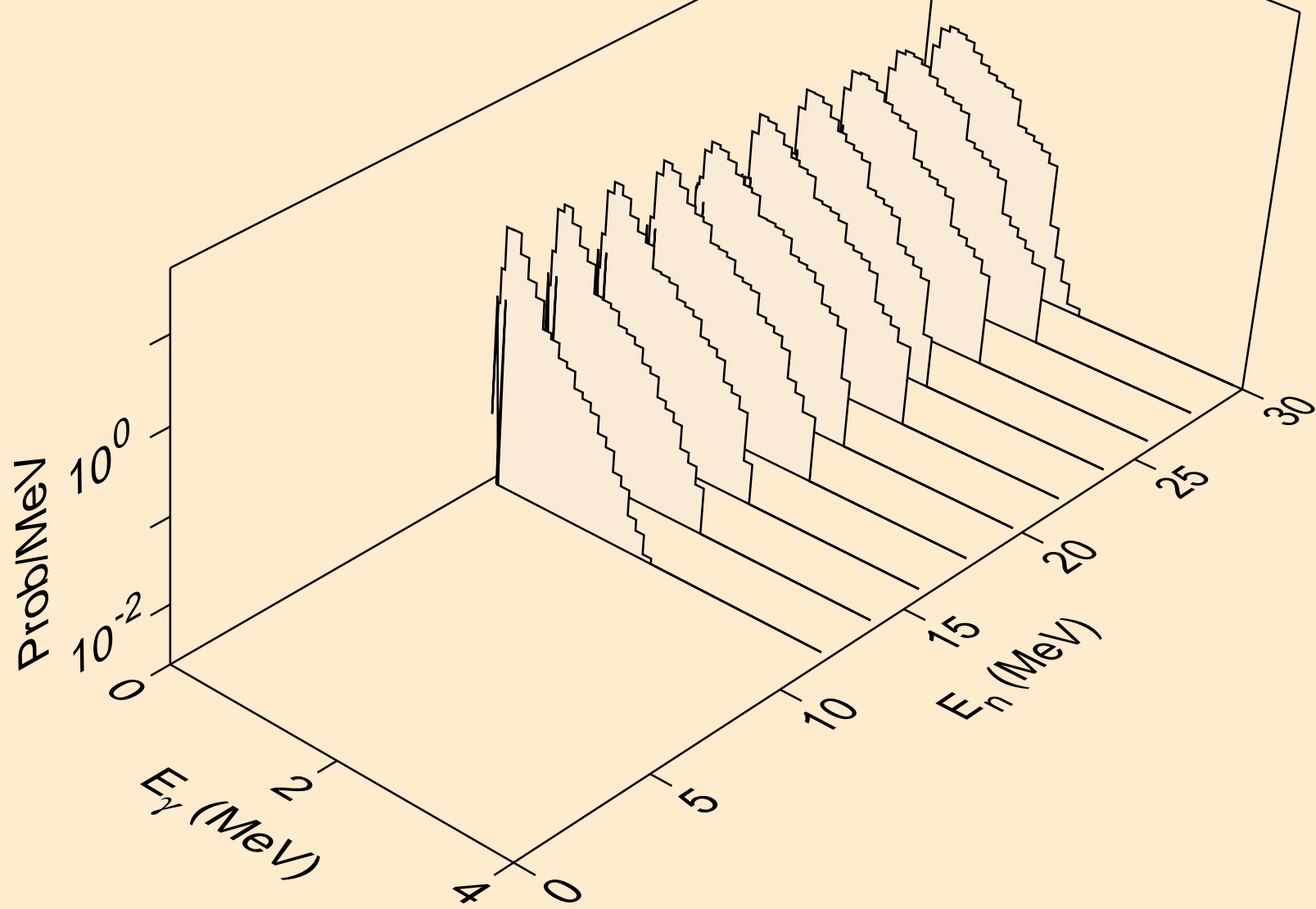

DB263 TRITON ACER TENDL-2021 LIBRARY; T=0.K  
Photon emission for (n,da)

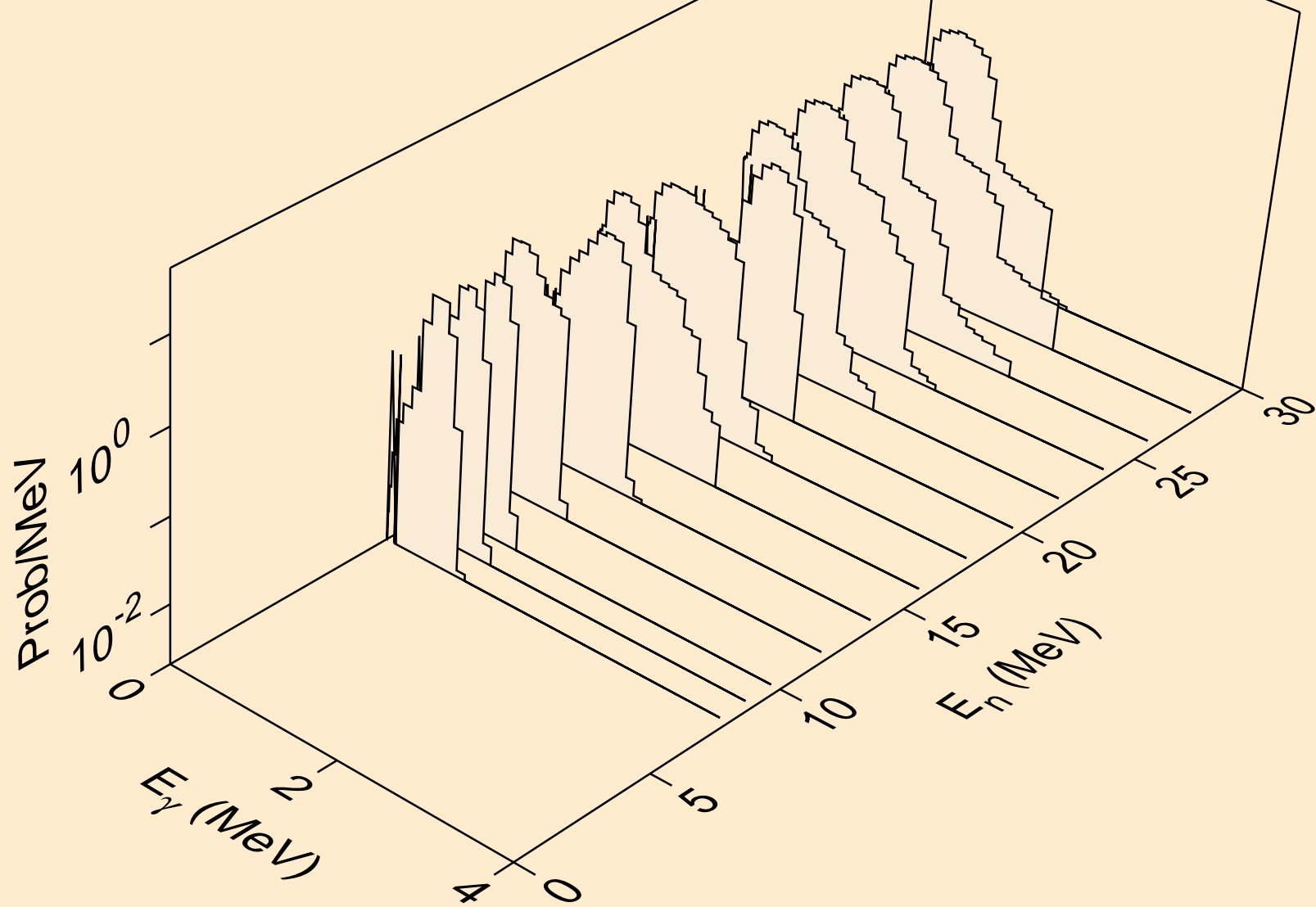

DB263 TRITON ACER TENDL-2021 LIBRARY; T=0.K  
Particle heating contributions

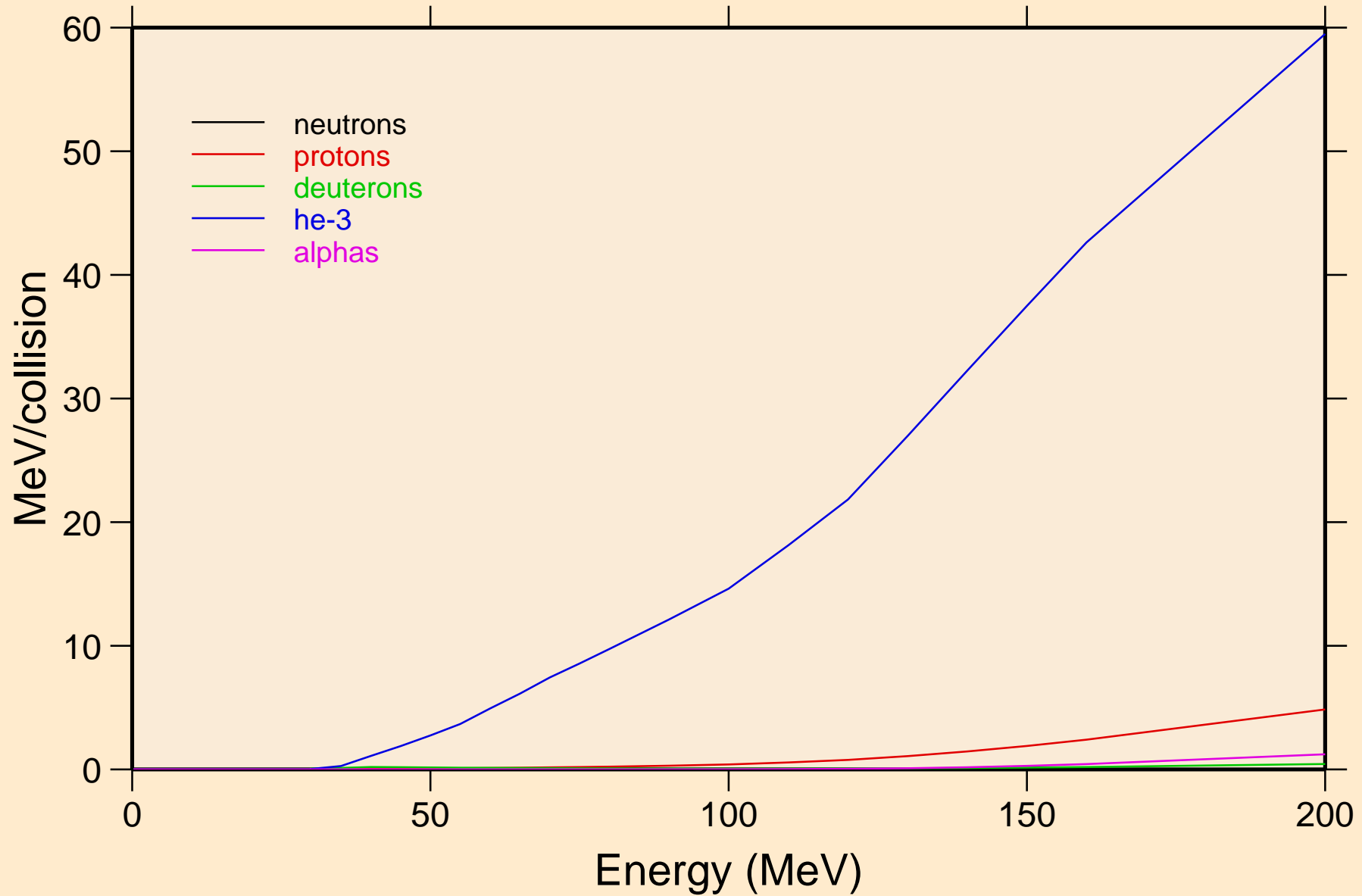



DB263 TRITON ACER TENDL-2021 LIBRARY; T=0.K  
Recoil Heating

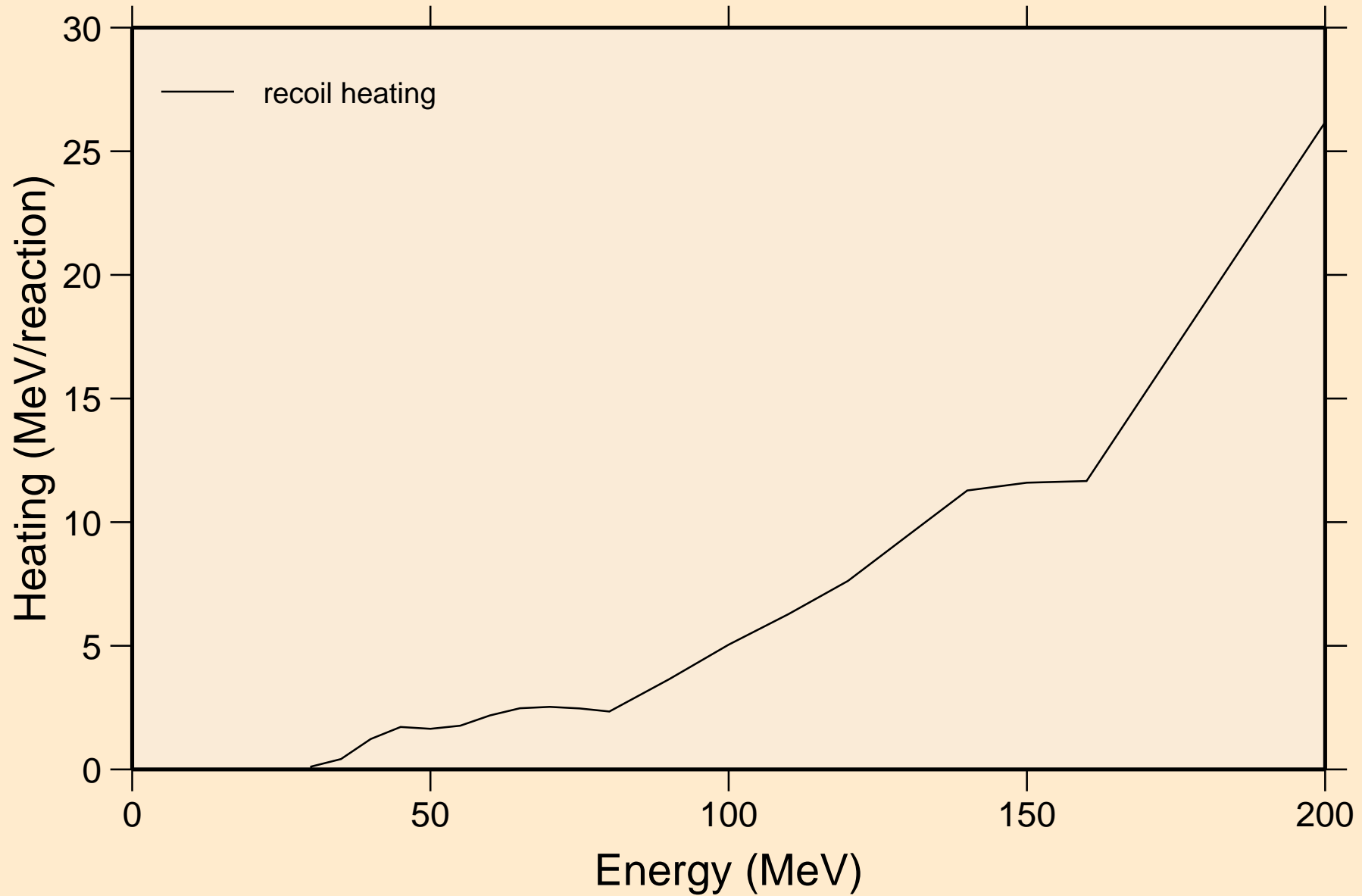

DB263 TRITON ACER TENDL-2021 LIBRARY; T=0.K  
Particle production cross sections

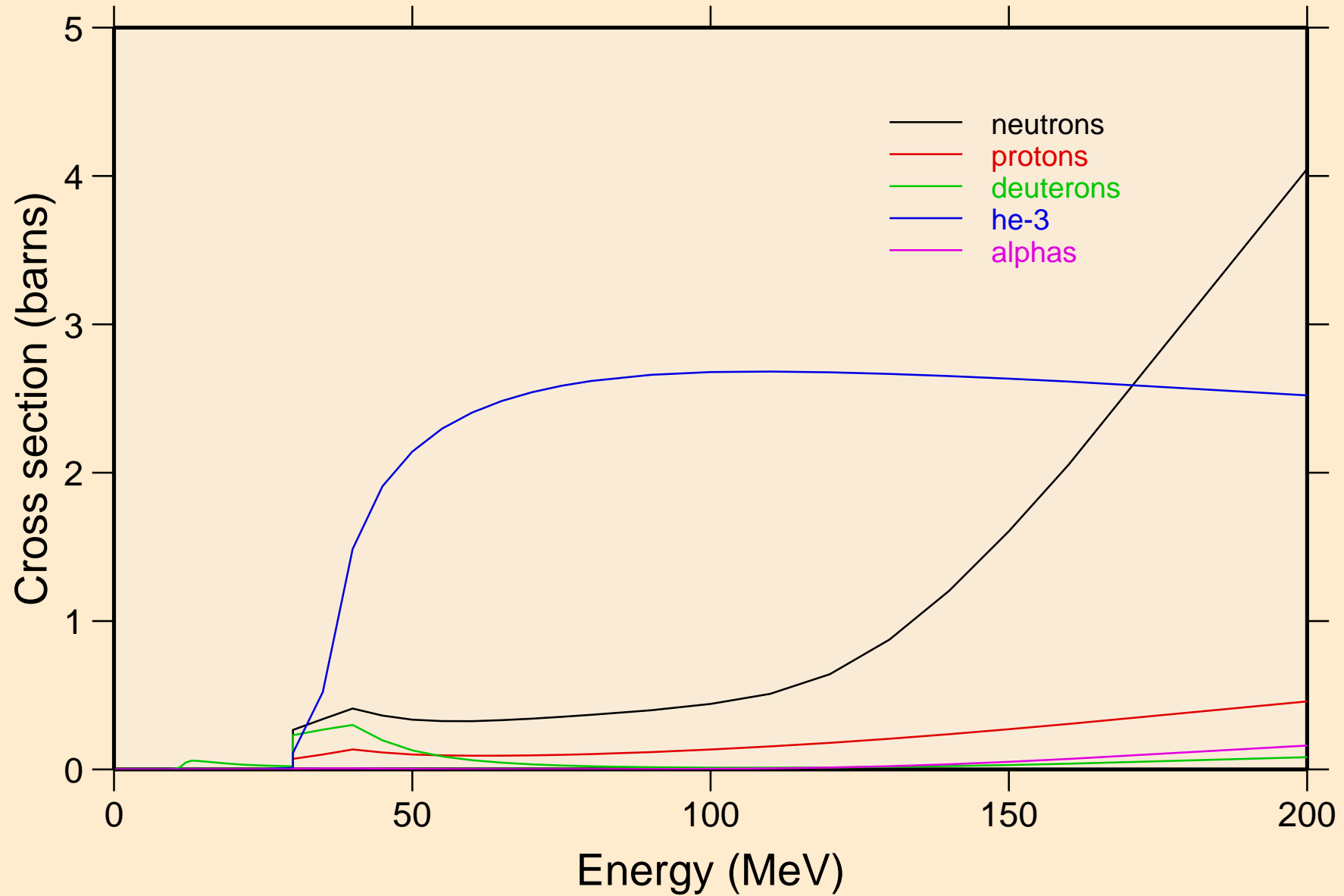

DB263 TRITON ACER TENDL-2021 LIBRARY; T=0.K  
neutrons from (t,n)

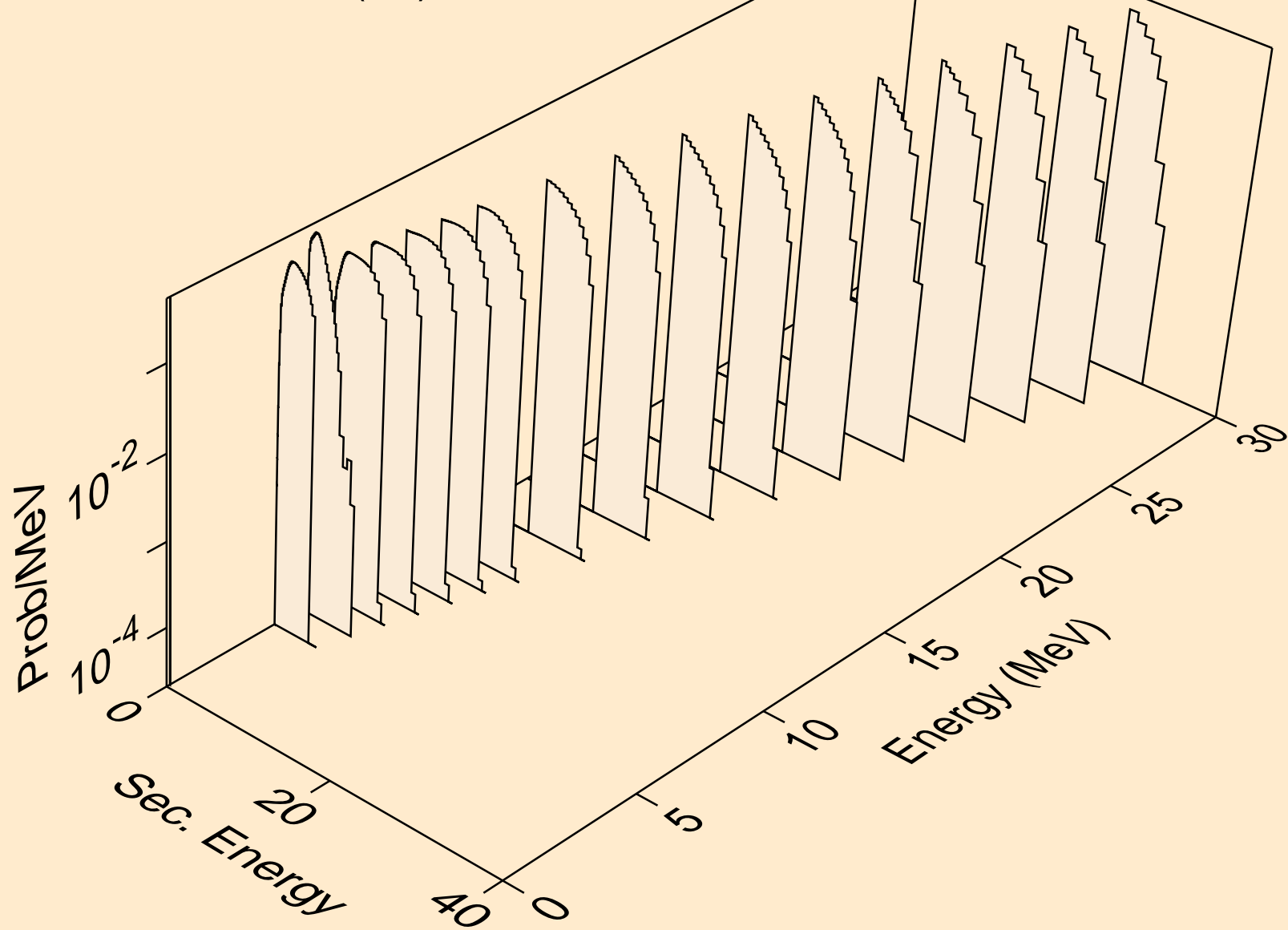

DB263 TRITON ACER TENDL-2021 LIBRARY; T=0.K  
neutrons from (t,x)

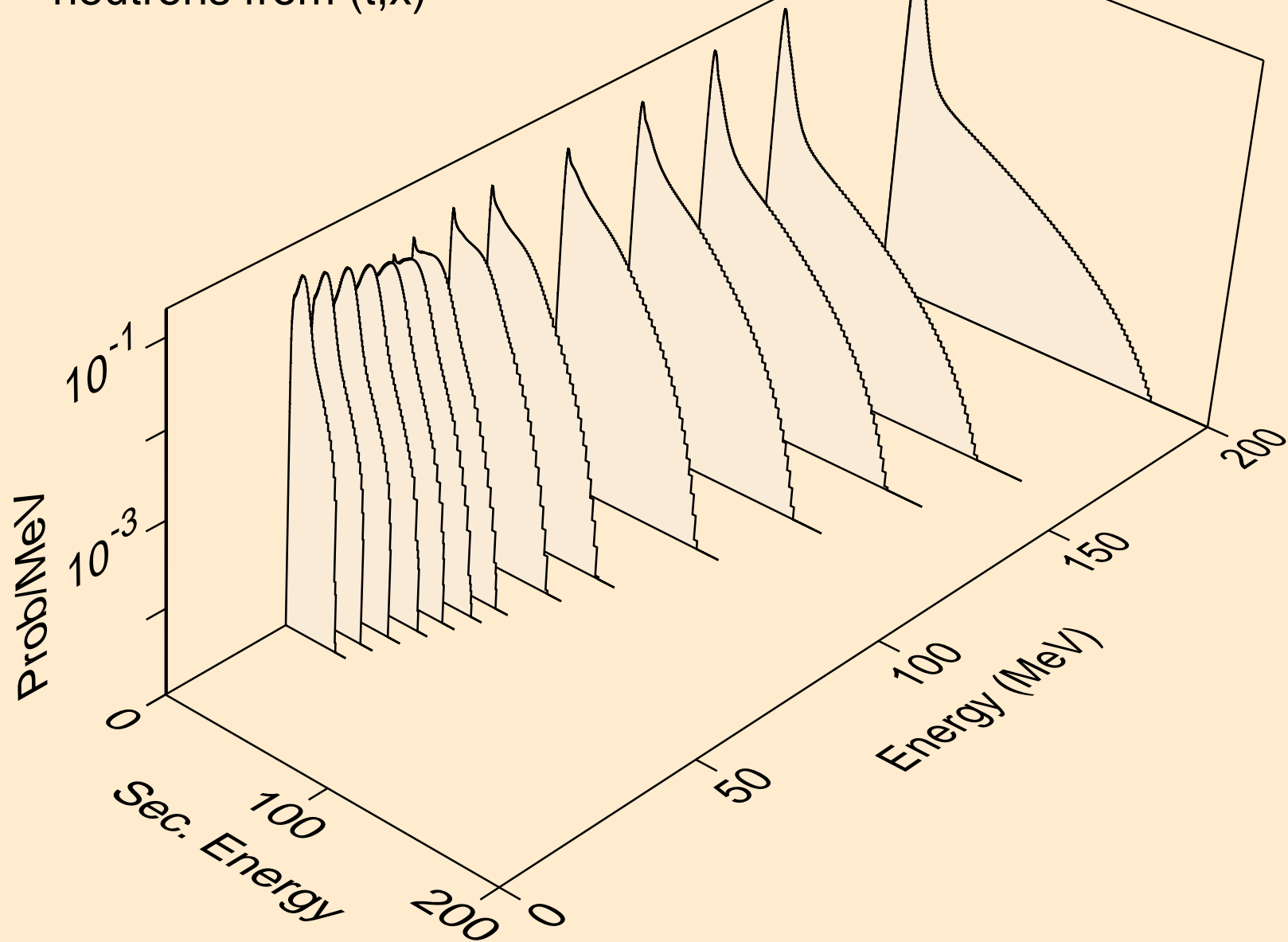

DB263 TRITON ACER TENDL-2021 LIBRARY; T=0.K  
neutrons from (t,2n)

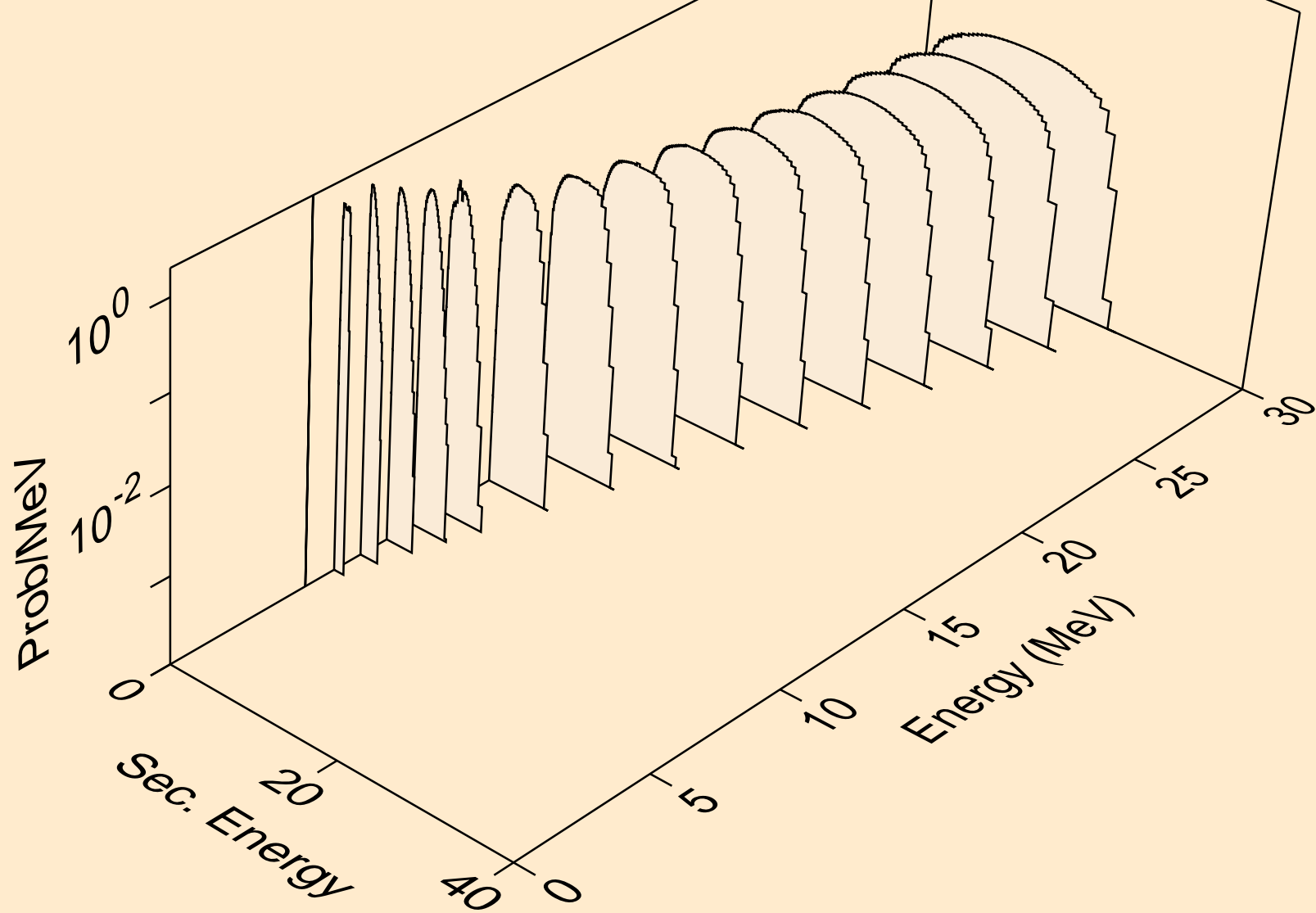

DB263 TRITON ACER TENDL-2021 LIBRARY; T=0.K  
neutrons from (t,3n)

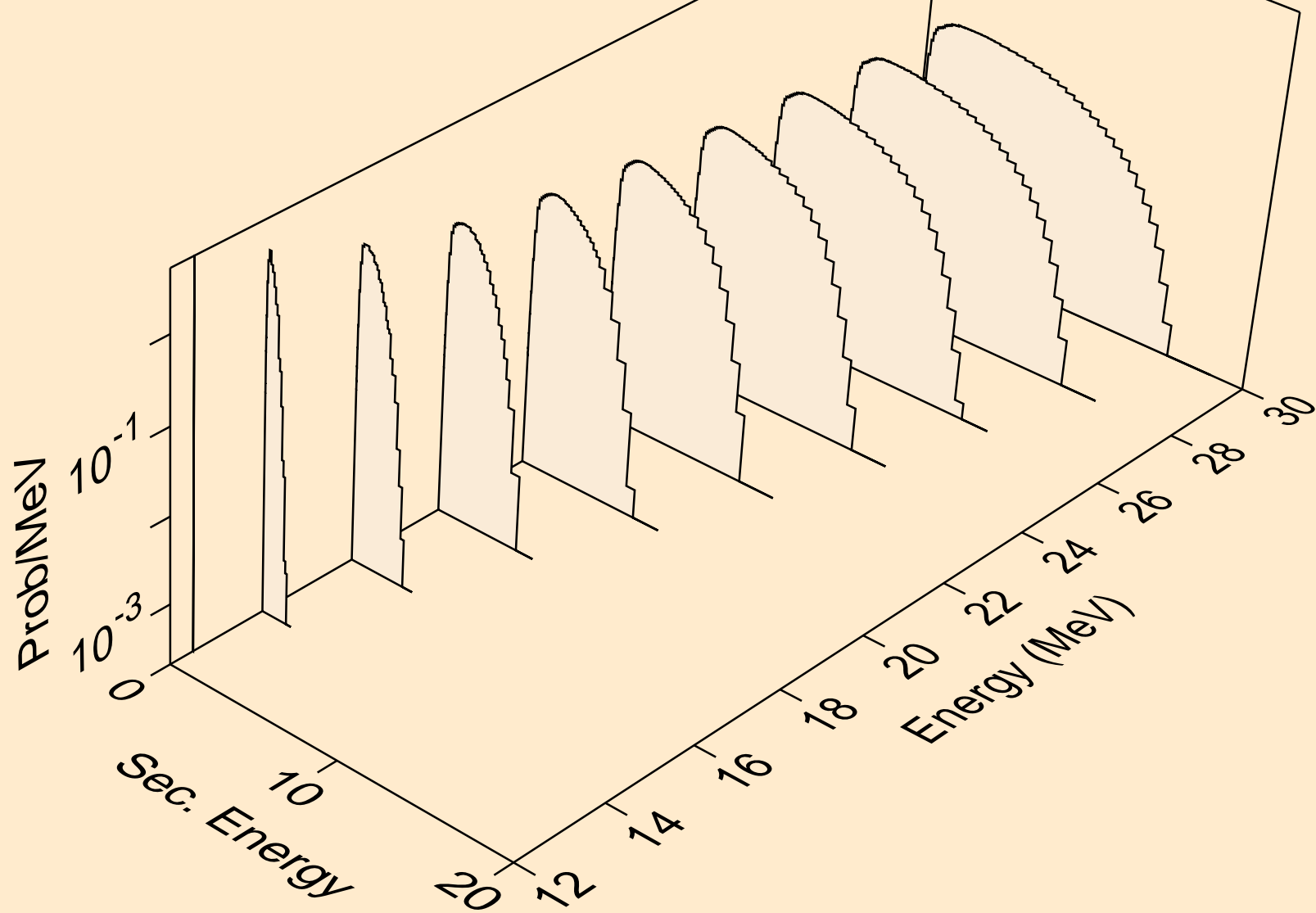

DB263 TRITON ACER TENDL-2021 LIBRARY; T=0.K  
neutrons from (t,n\*)a

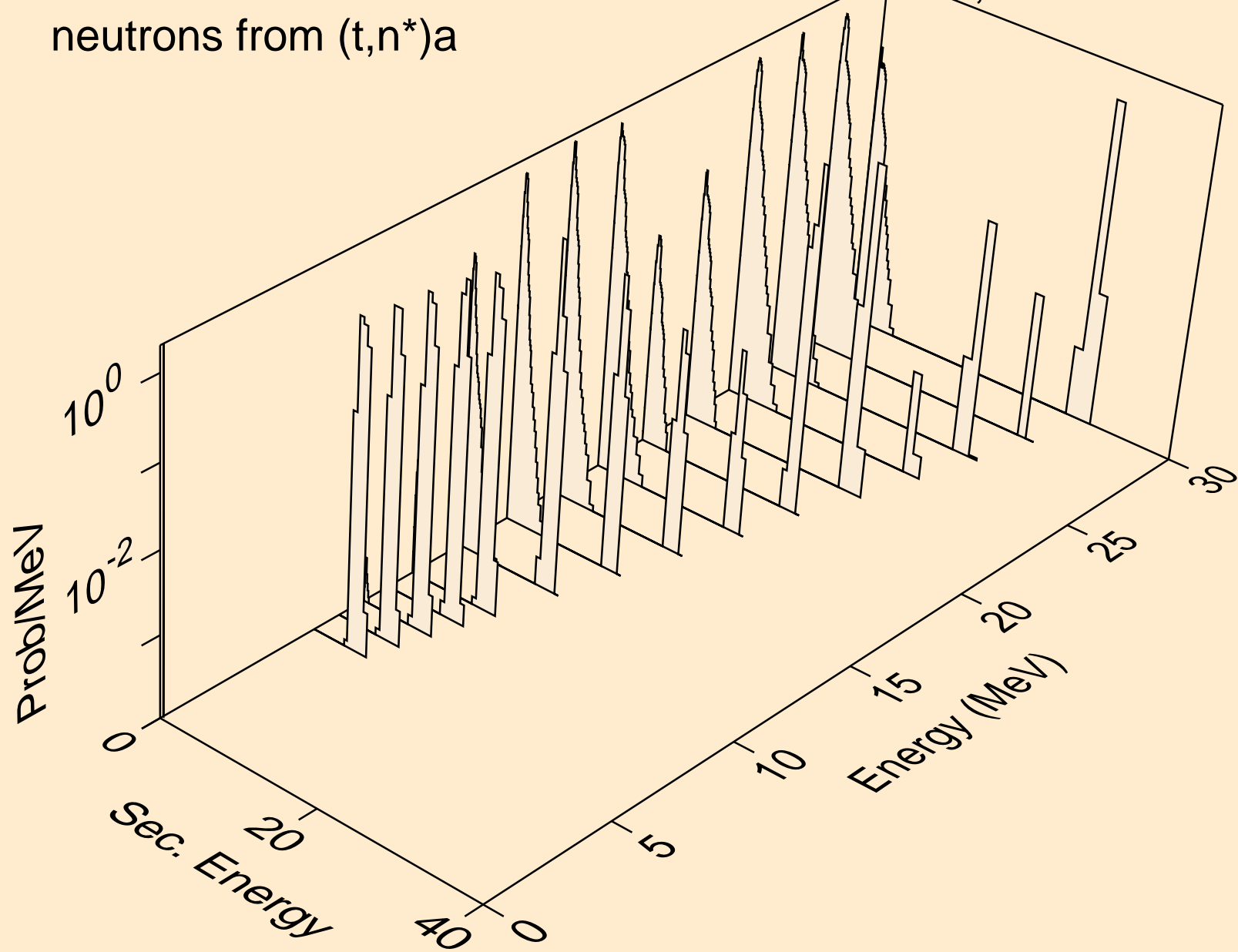

DB263 TRITON ACER TENDL-2021 LIBRARY; T=0.K  
neutrons from (t,n\*)p

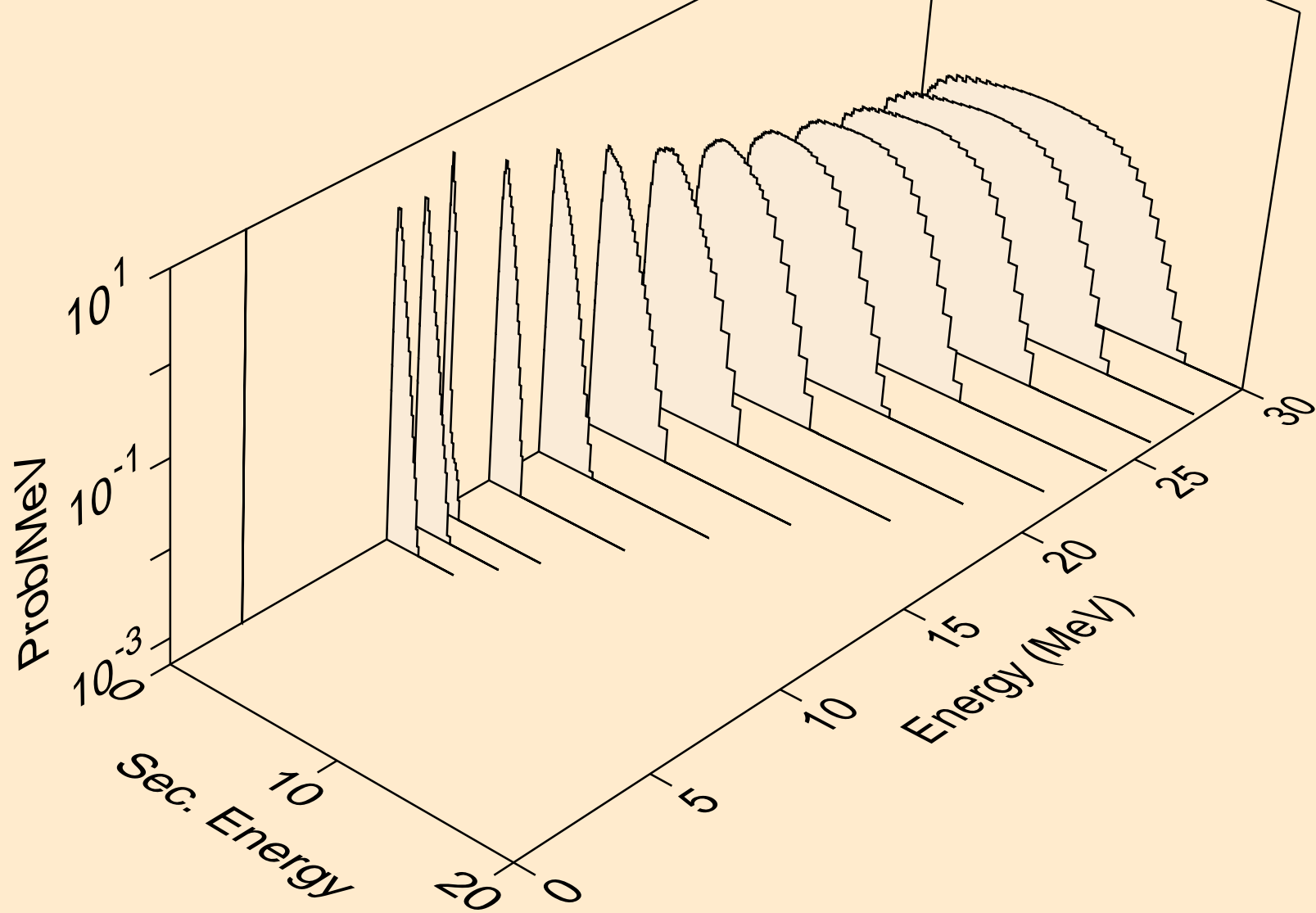



DB263 TRITON ACER TENDL-2021 LIBRARY; T=0.K  
neutrons from (t,n\*)d

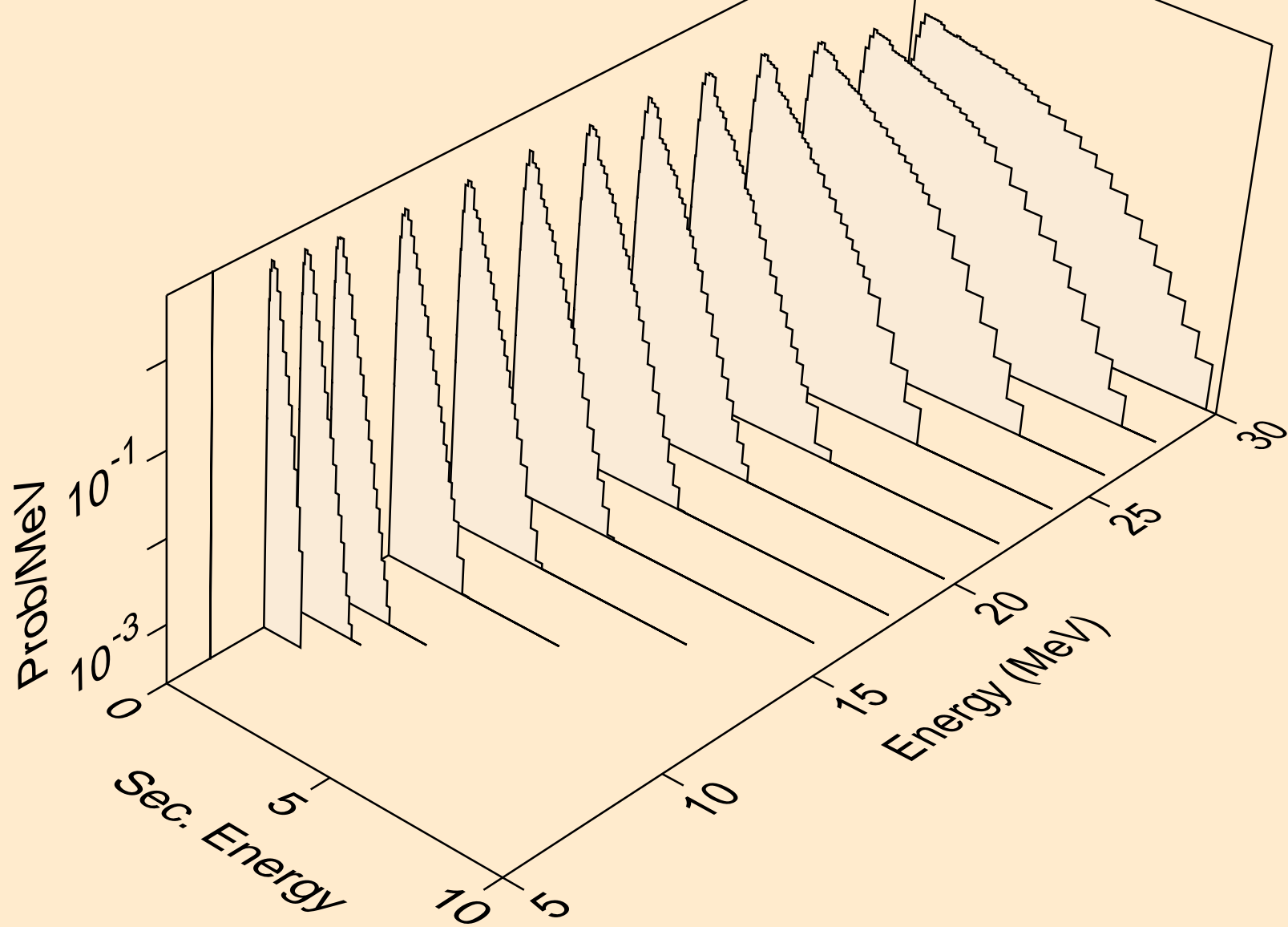

DB263 TRITON ACER TENDL-2021 LIBRARY; T=0.K  
neutrons from (t,n\*)t

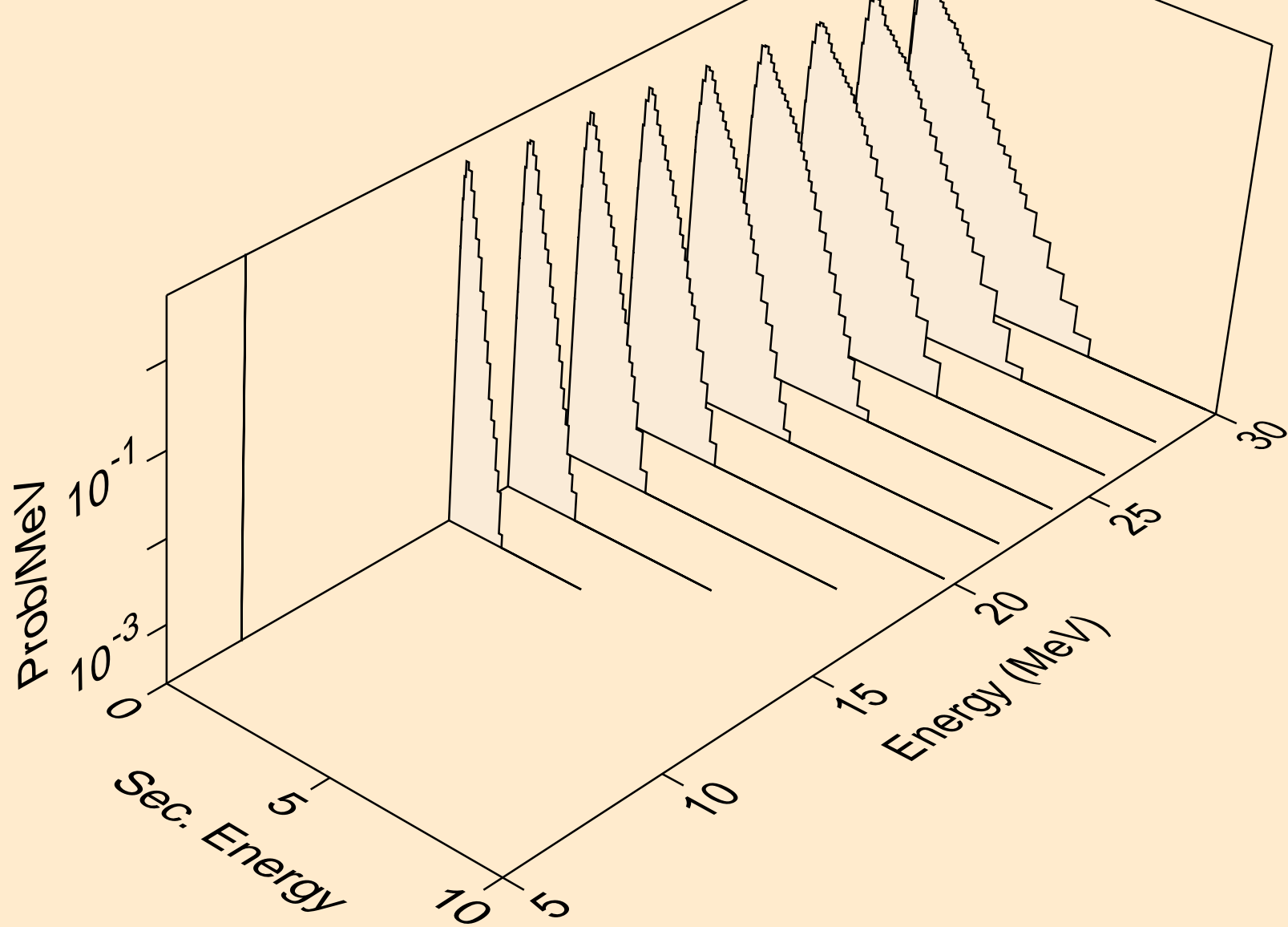

DB263 TRITON ACER TENDL-2021 LIBRARY; T=0.K  
neutrons from (t,n\*)he3

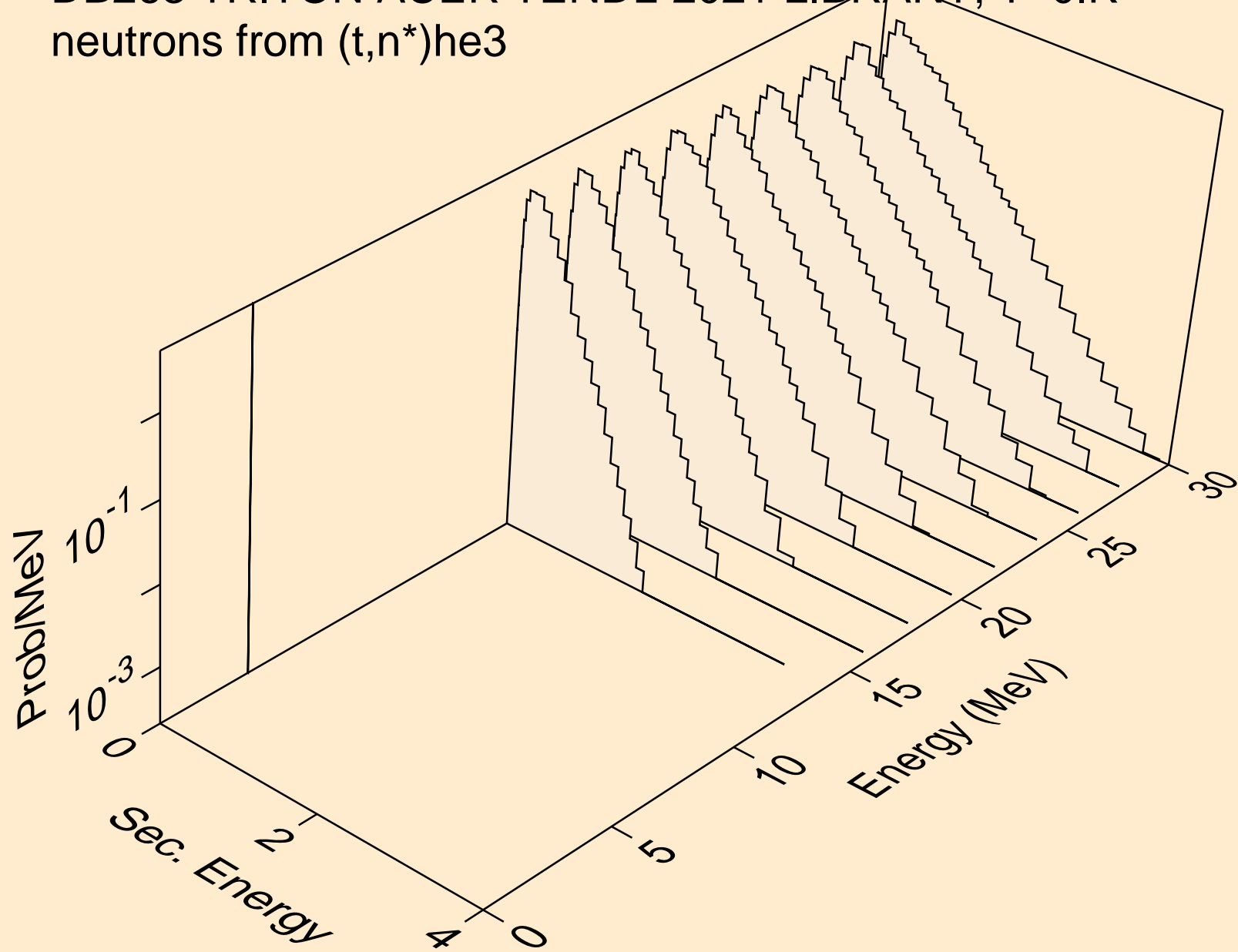

DB263 TRITON ACER TENDL-2021 LIBRARY; T=0.K  
neutrons from (t,n\*)t2a

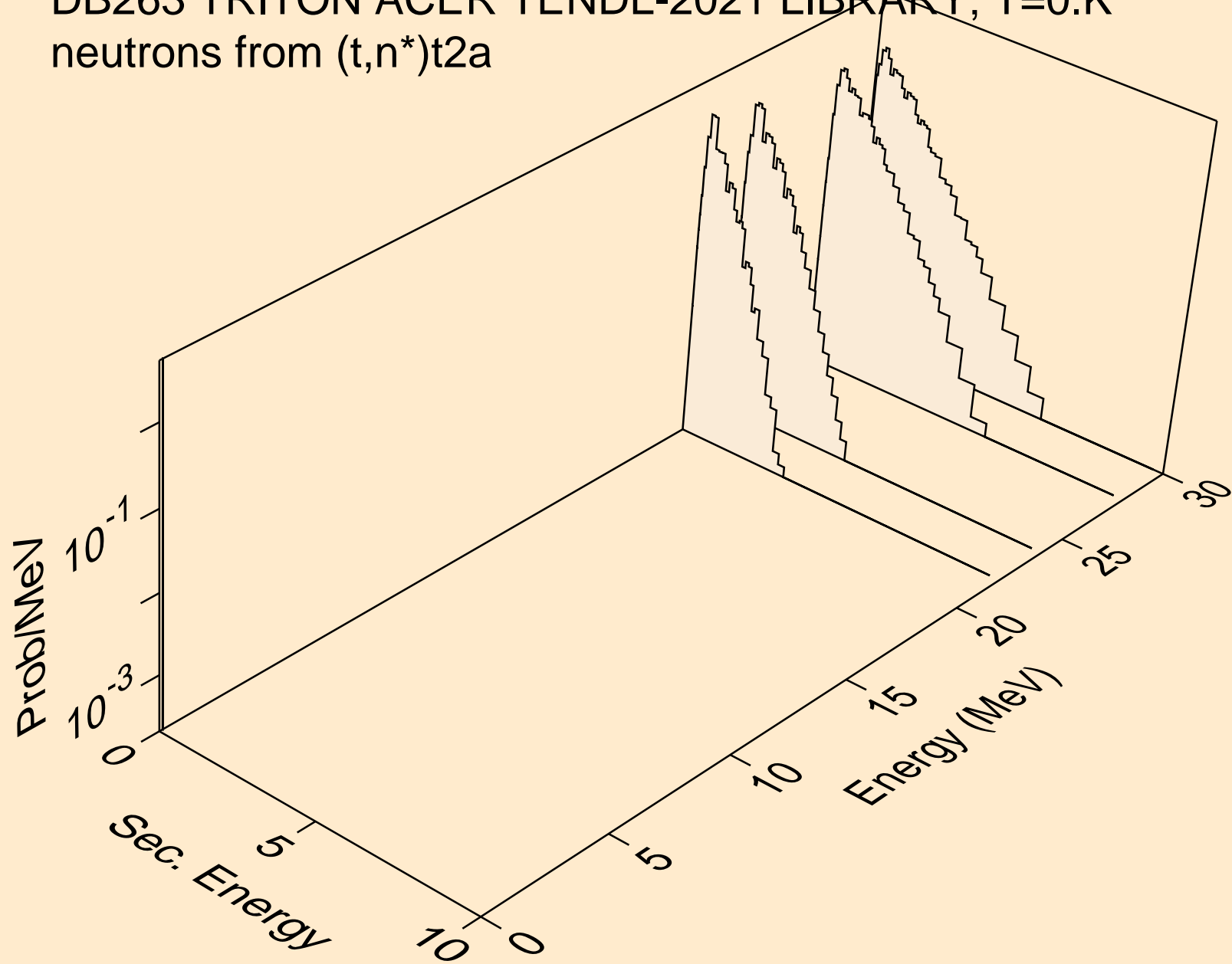

DB263 TRITON ACER TENDL-2021 LIBRARY; T=0.K  
neutrons from (t,4n)

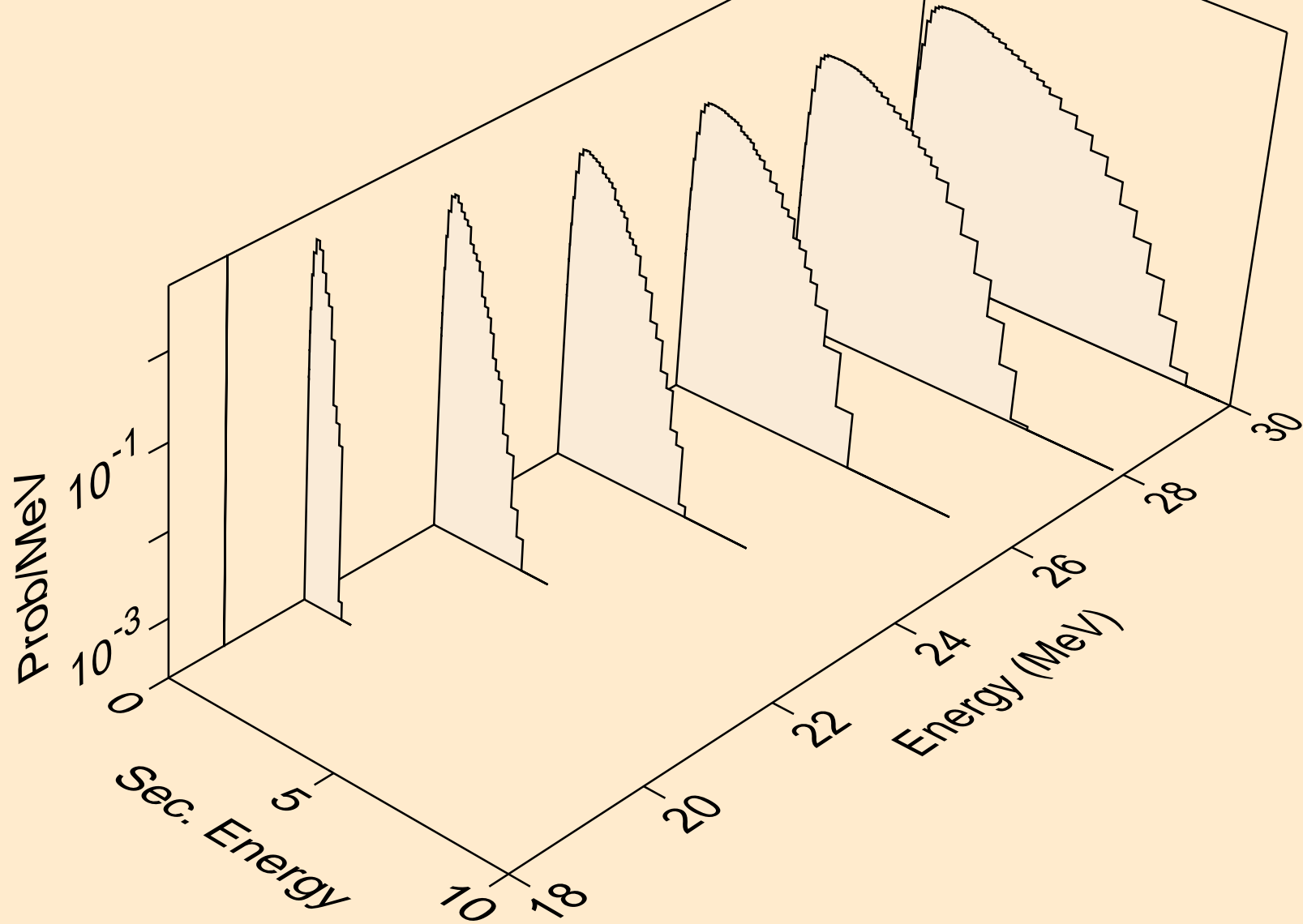

DB263 TRITON ACER TENDL-2021 LIBRARY; T=0.K  
neutrons from (t,2np)

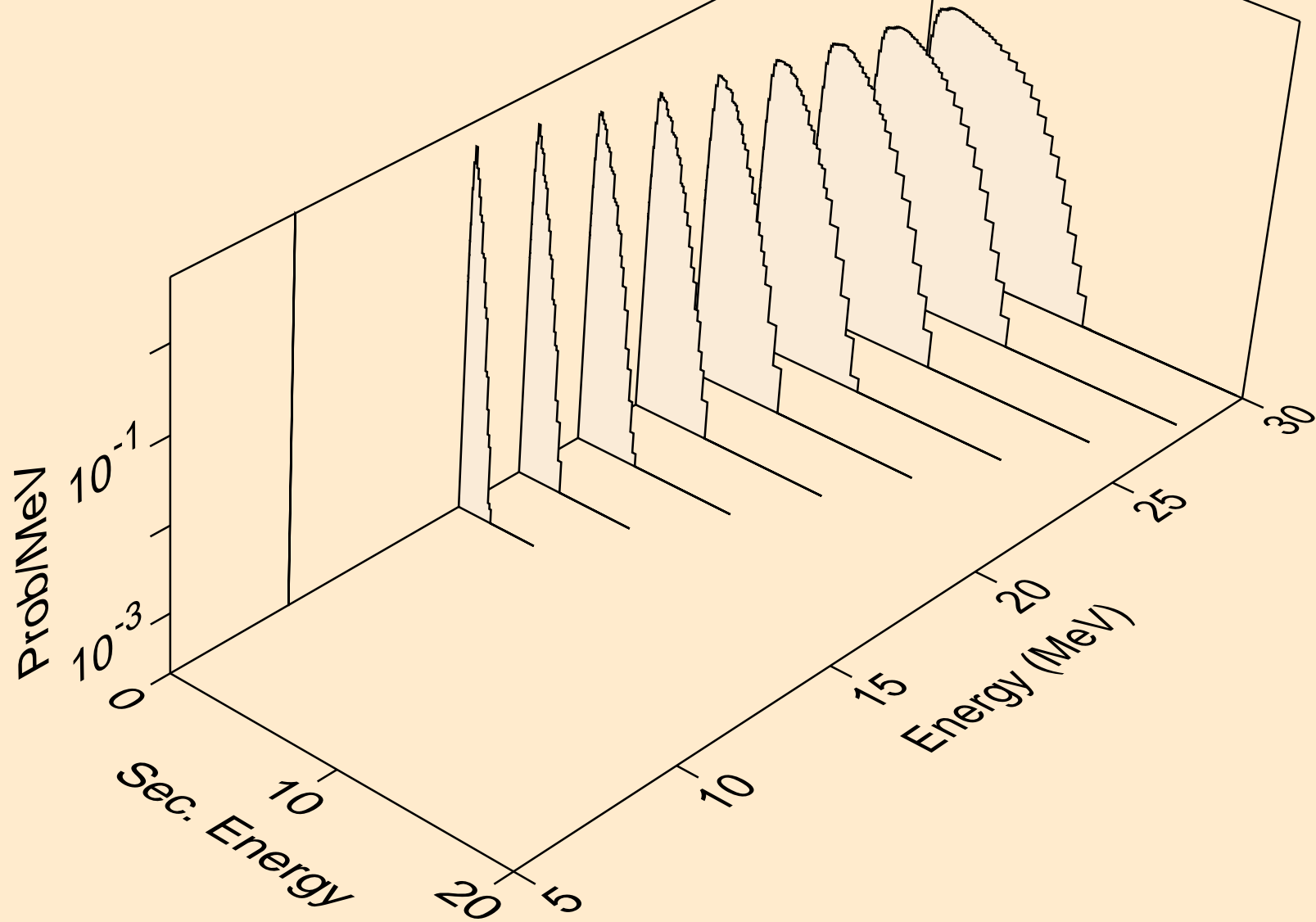

DB263 TRITON ACER TENDL-2021 LIBRARY; T=0.K  
neutrons from (t,3np)

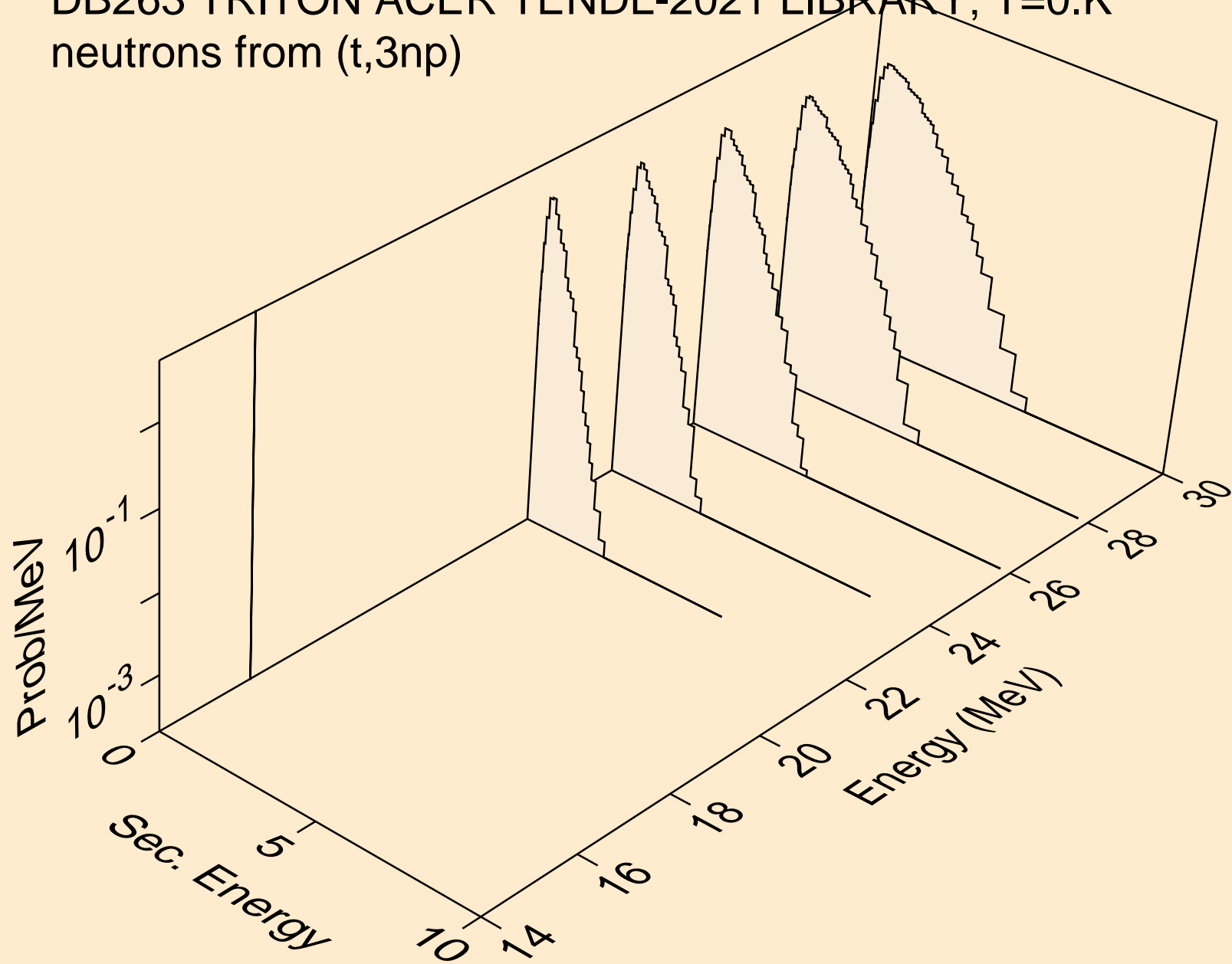

DB263 TRITON ACER TENDL-2021 LIBRARY; T=0.K  
neutrons from (t,2np)

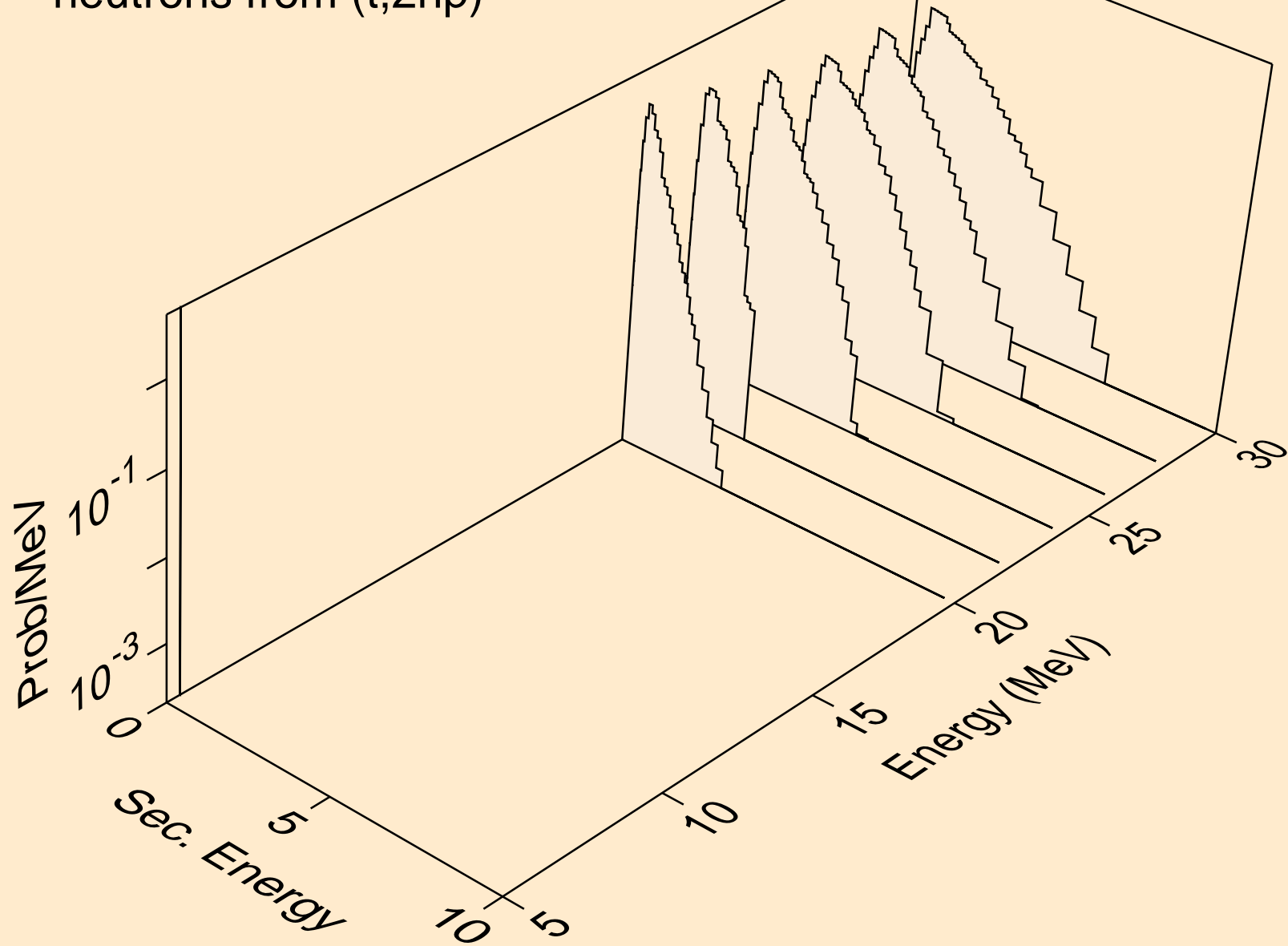



DB263 TRITON ACER TENDL-2021 LIBRARY; T=0.K  
protons from (t,x)

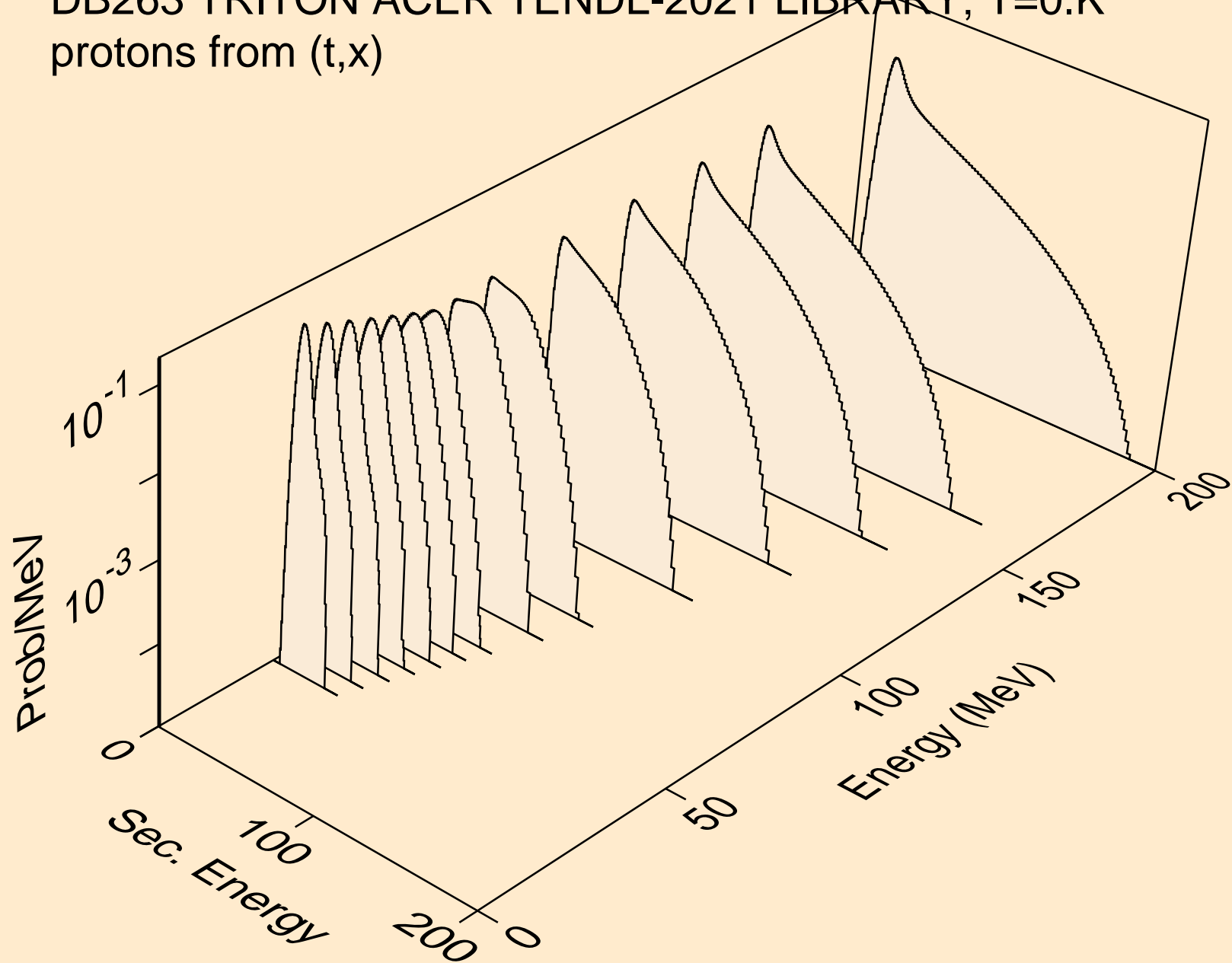

DB263 TRITON ACER TENDL-2021 LIBRARY; T=0.K  
protons from (t,n\*)p

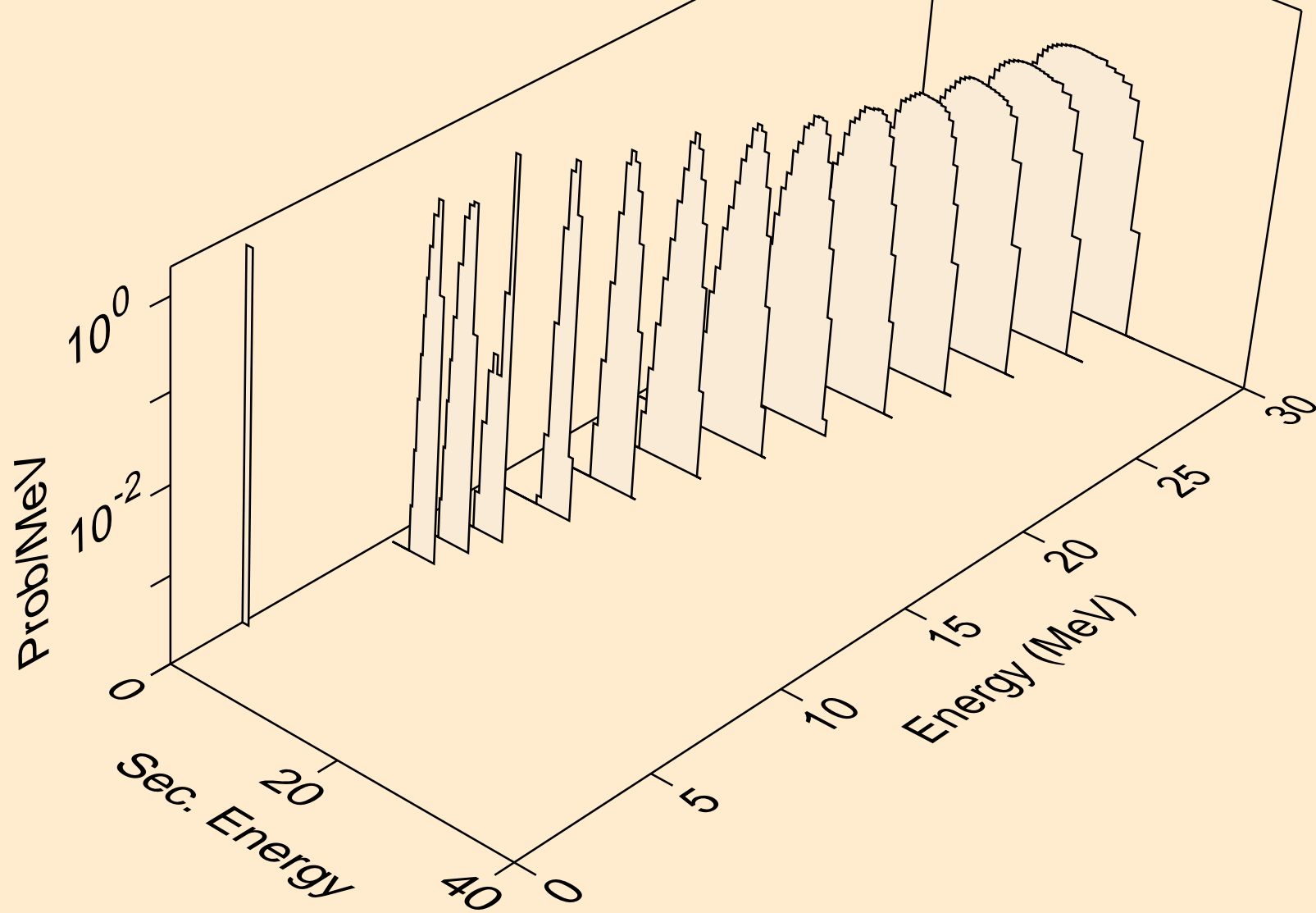

DB263 TRITON ACER TENDL-2021 LIBRARY; T=0.K  
protons from (t,2np)

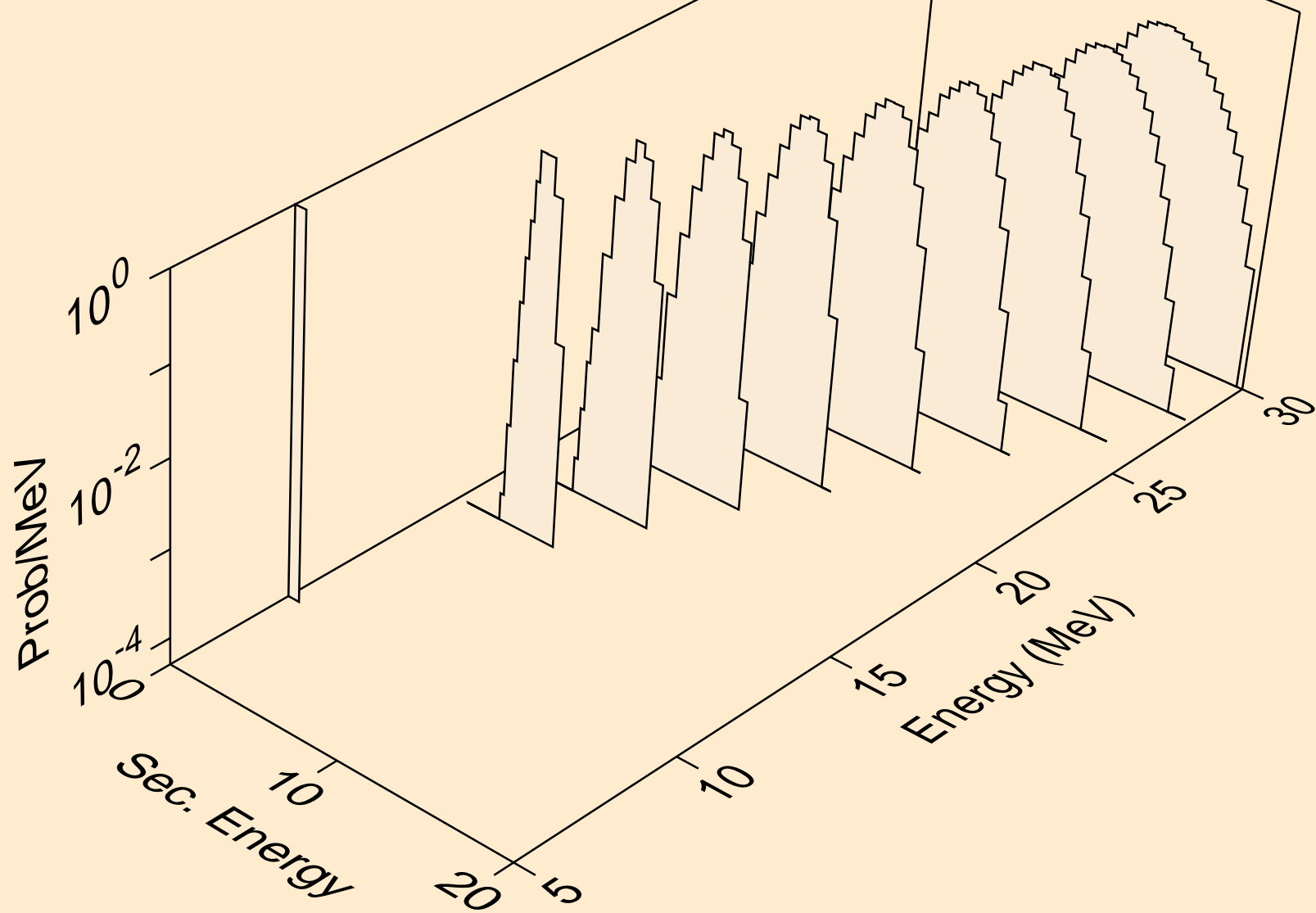

DB263 TRITON ACER TENDL-2021 LIBRARY; T=0.K  
protons from (t,3np)

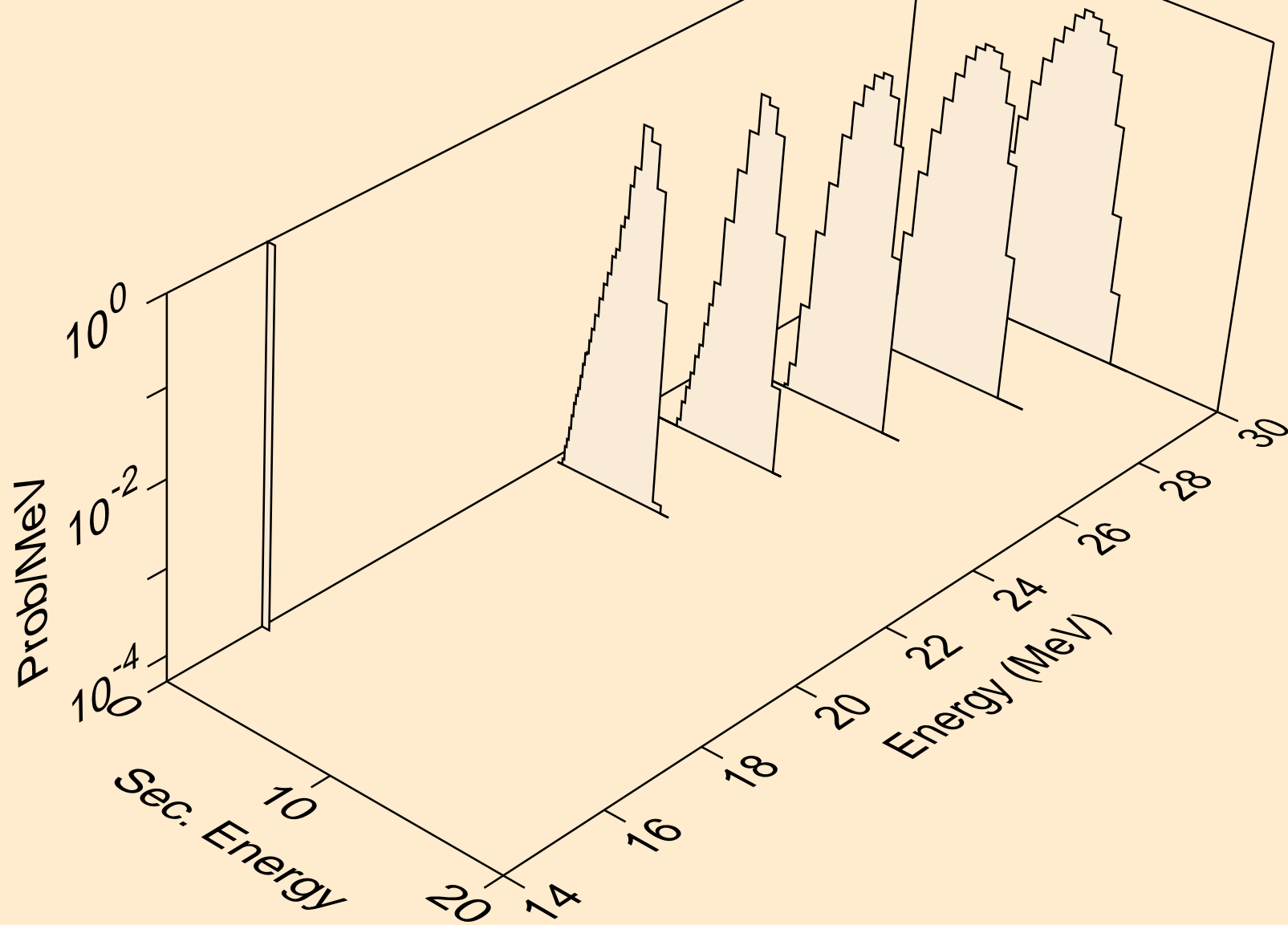

DB263 TRITON ACER TENDL-2021 LIBRARY; T=0.K  
protons from (t,2np)

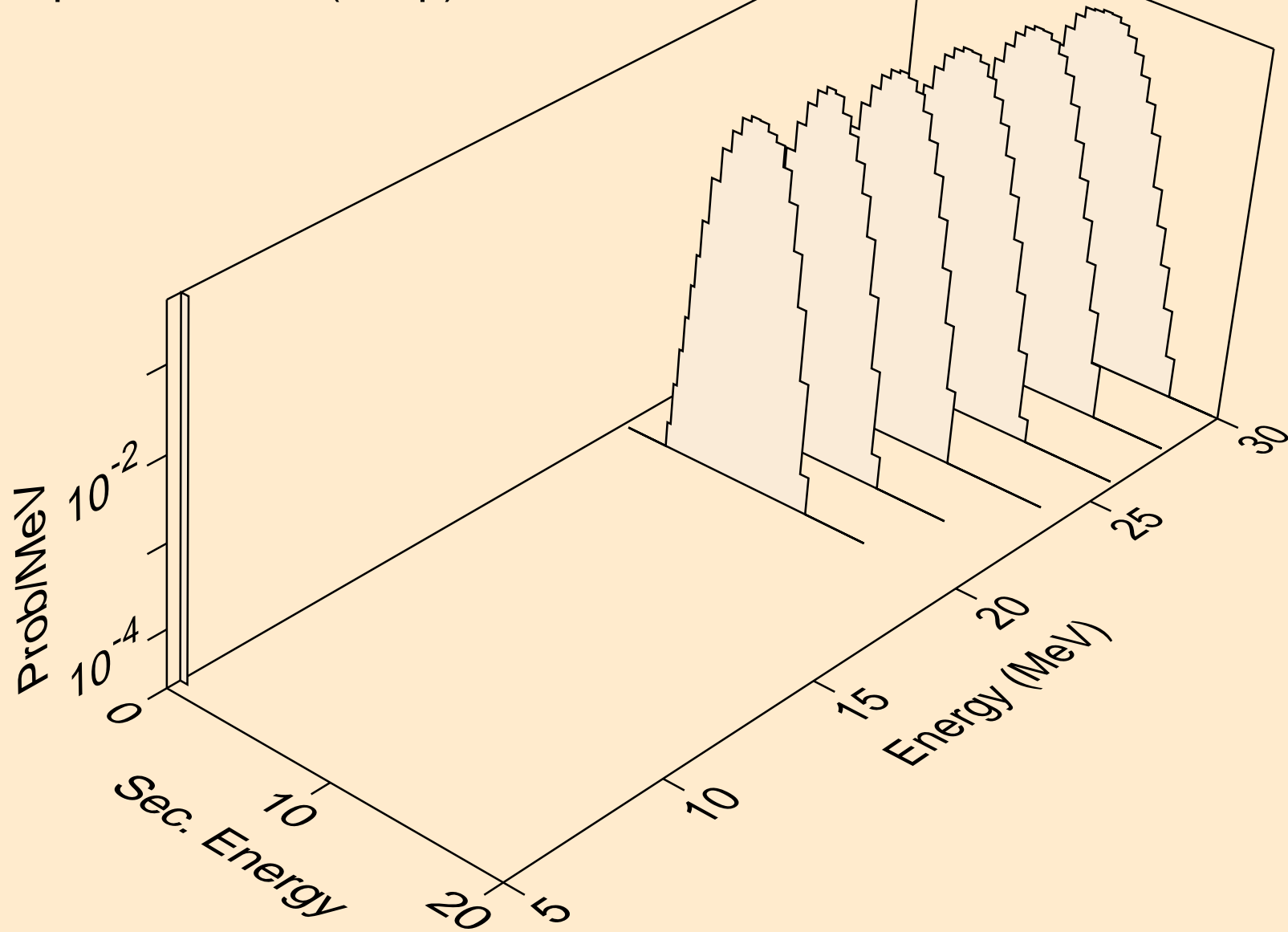

DB263 TRITON ACER TENDL-2021 LIBRARY; T=0.K  
protons from (t,p)

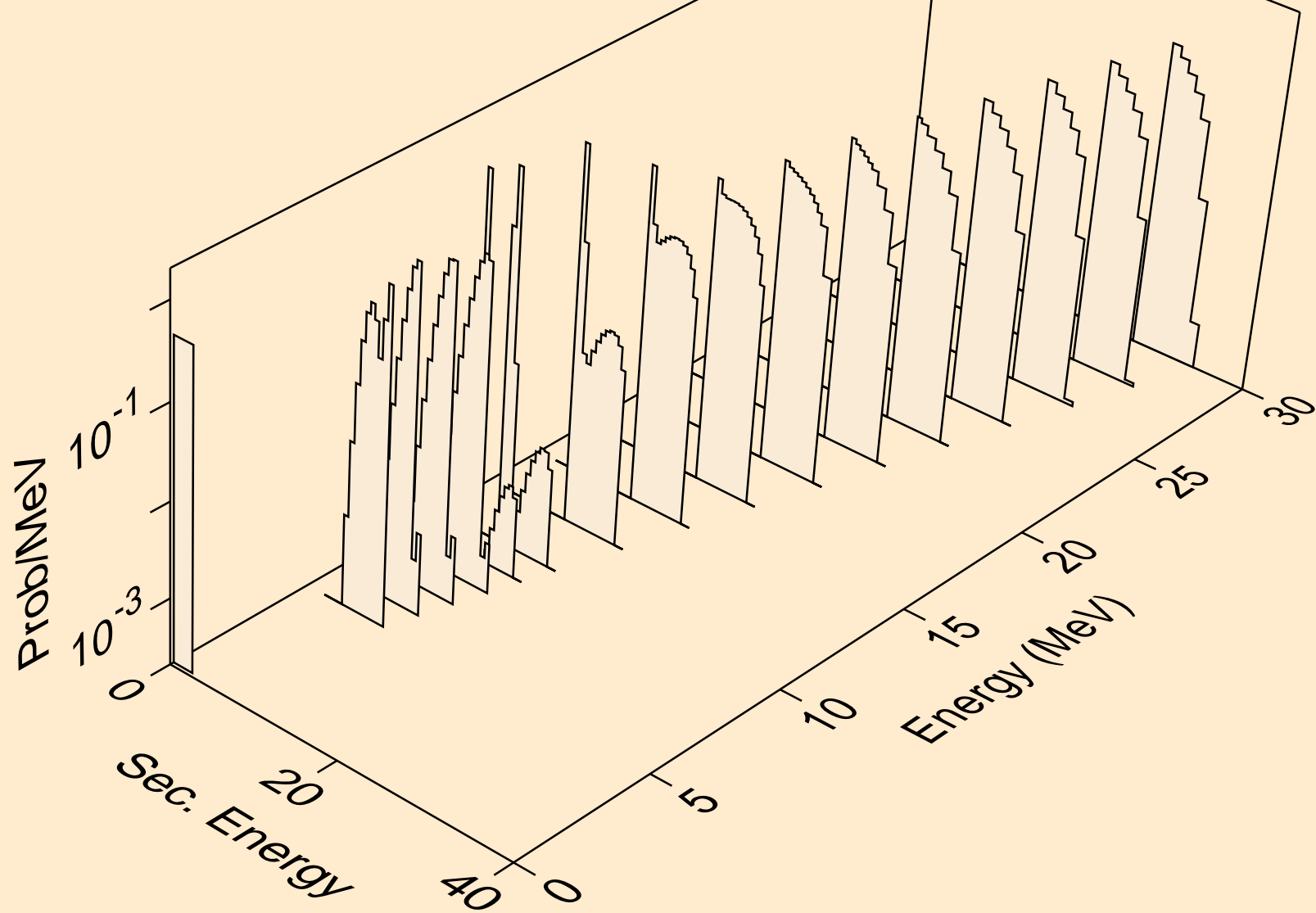

DB263 TRITON ACER TENDL-2021 LIBRARY; T=0.K  
protons from (t,2p)

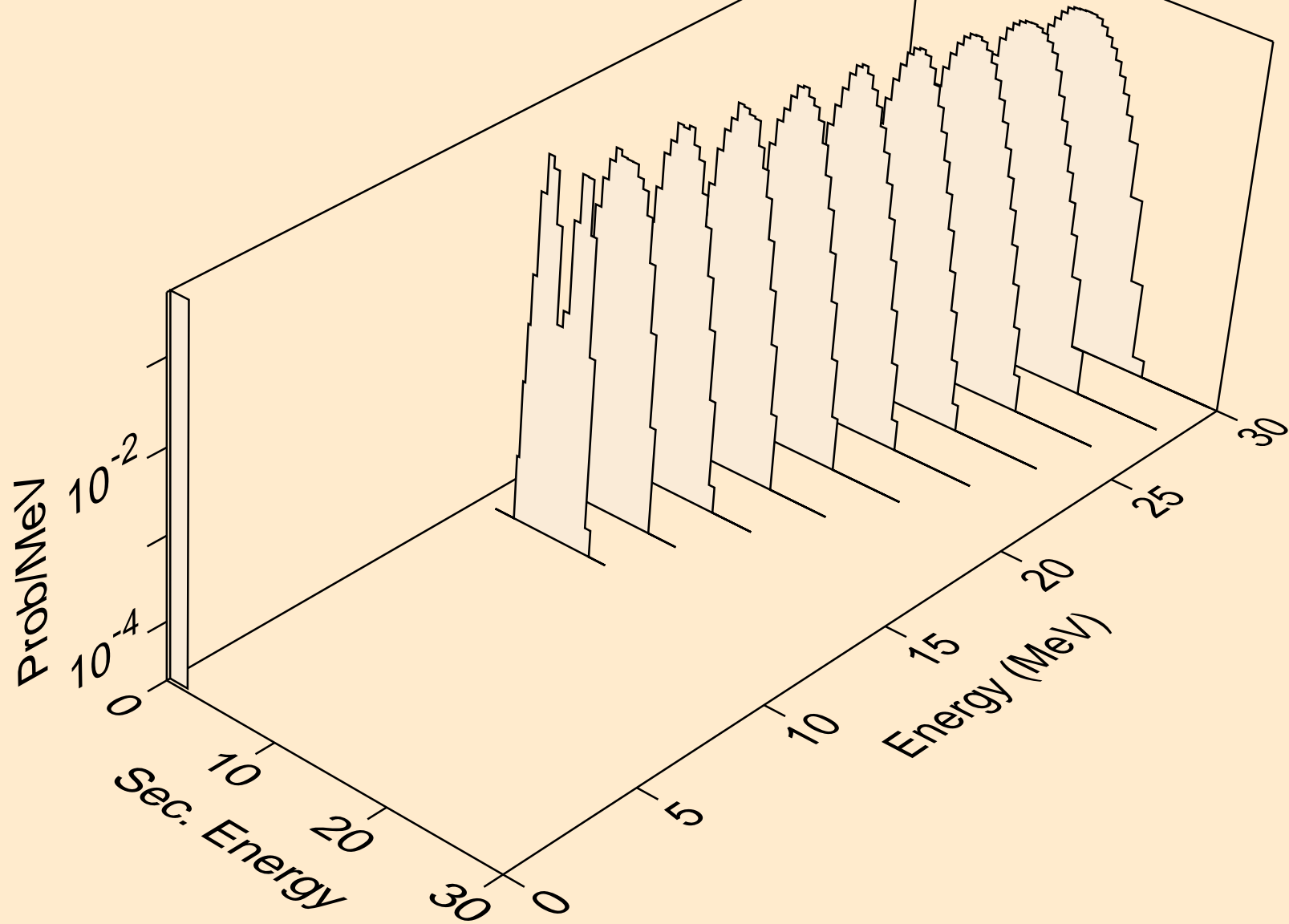

DB263 TRITON ACER TENDL-2021 LIBRARY; T=0.K  
protons from (t,pd)

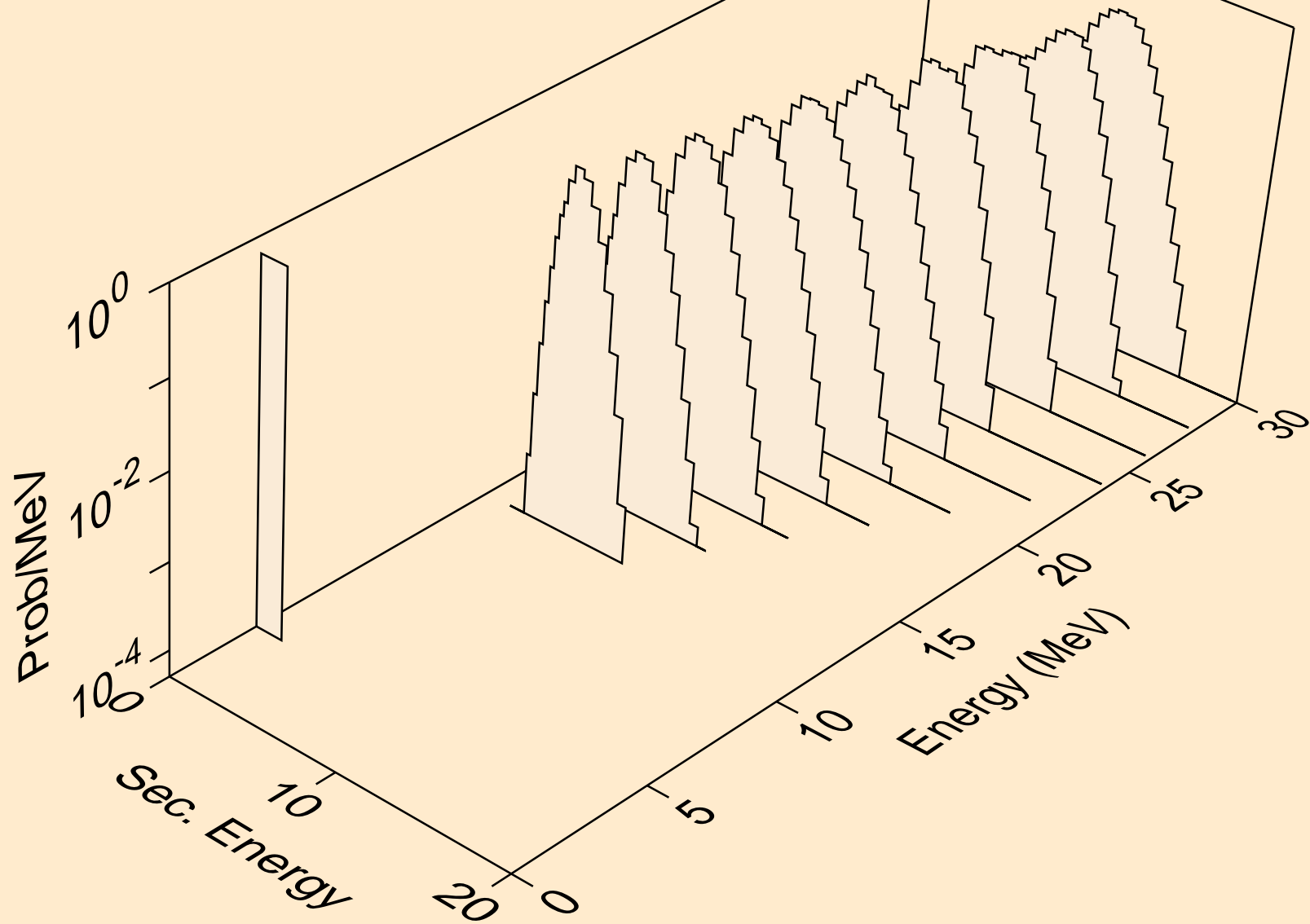



DB263 TRITON ACER TENDL-2021 LIBRARY; T=0.K  
deuterons from (t,x)

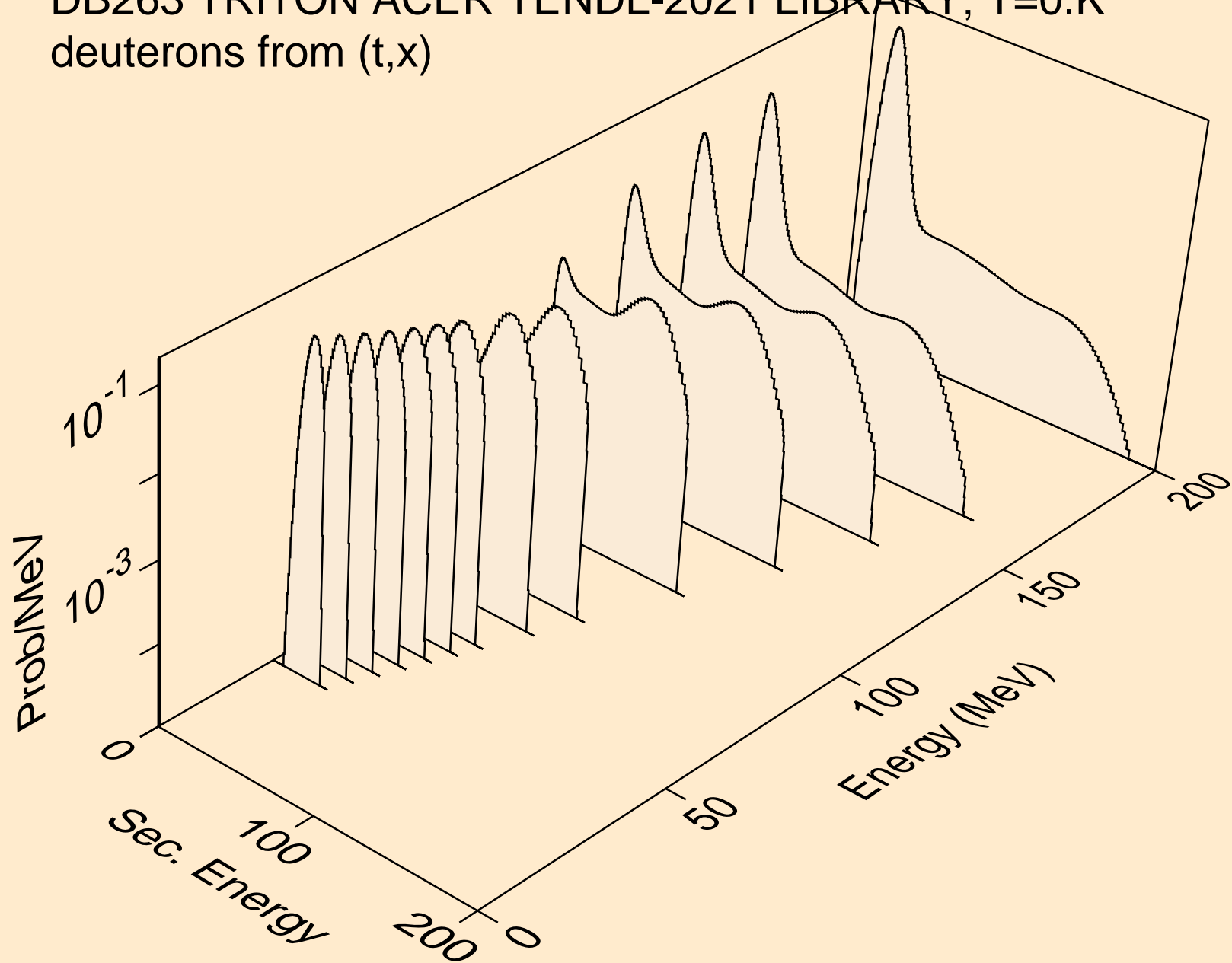

DB263 TRITON ACER TENDL-2021 LIBRARY; T=0.K  
deuterons from (t,n\*)d

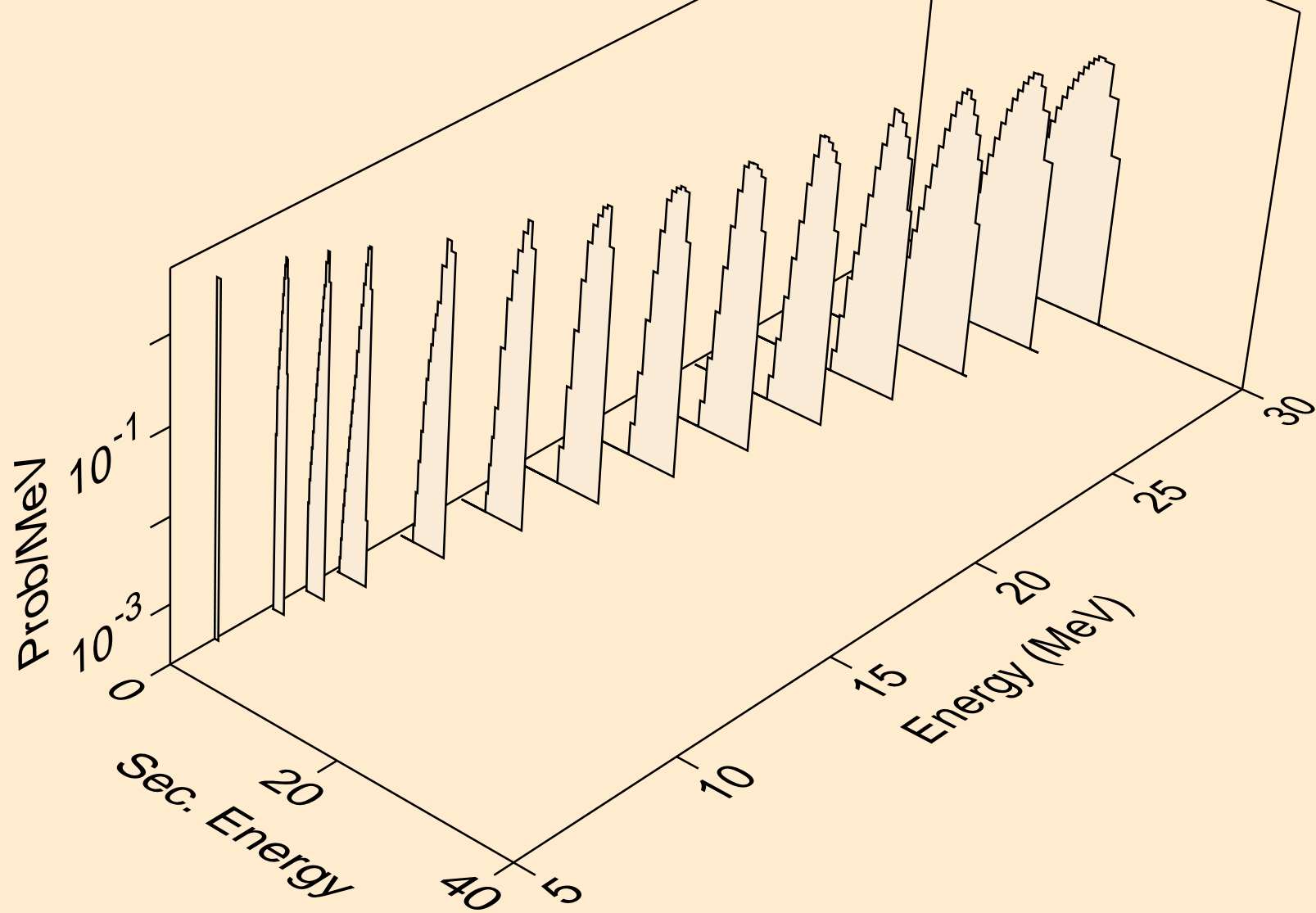

DB263 TRITON ACER TENDL-2021 LIBRARY; T=0.K  
deuterons from (t,d)

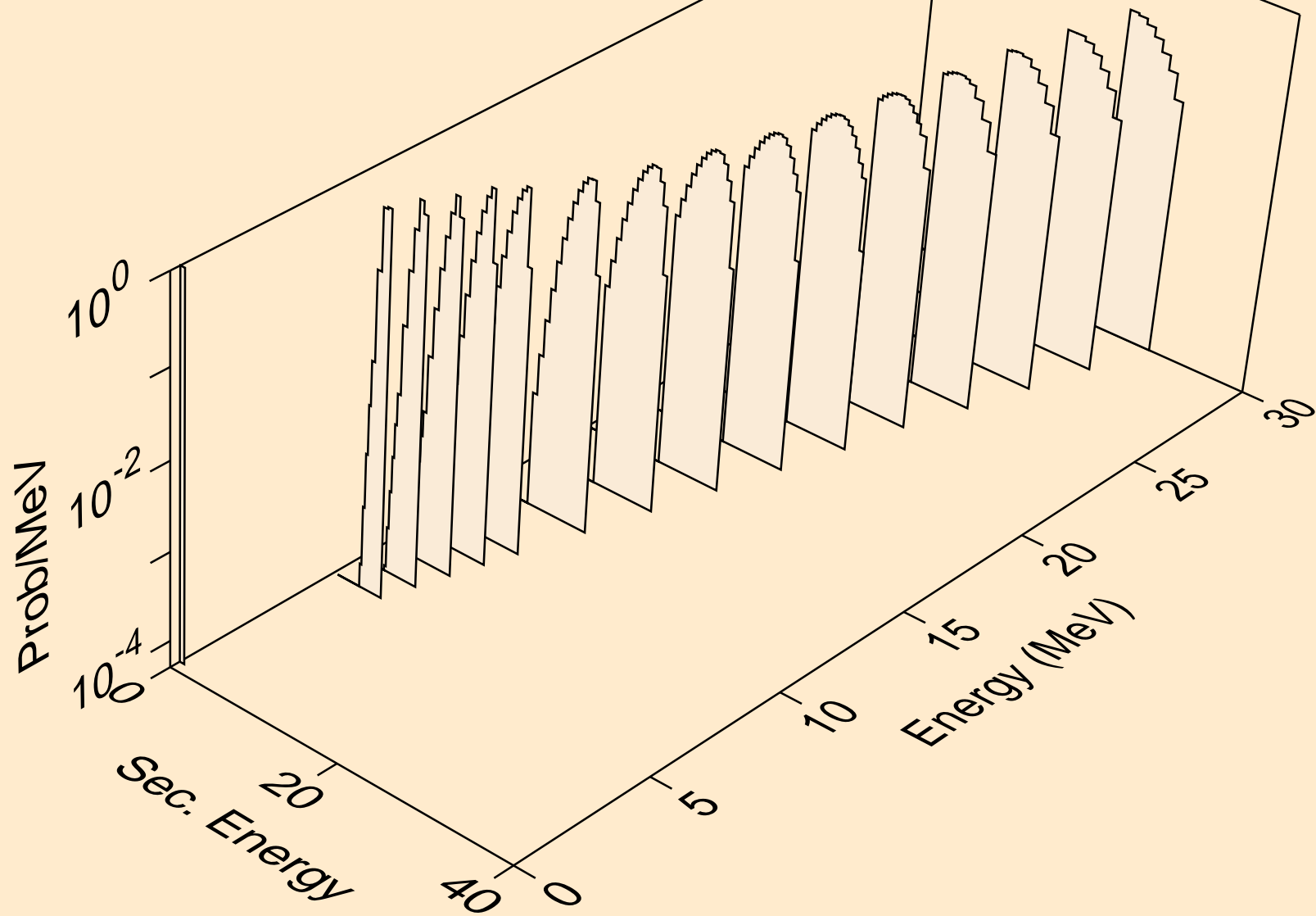

DB263 TRITON ACER TENDL-2021 LIBRARY; T=0.K  
deuterons from (t,pd)

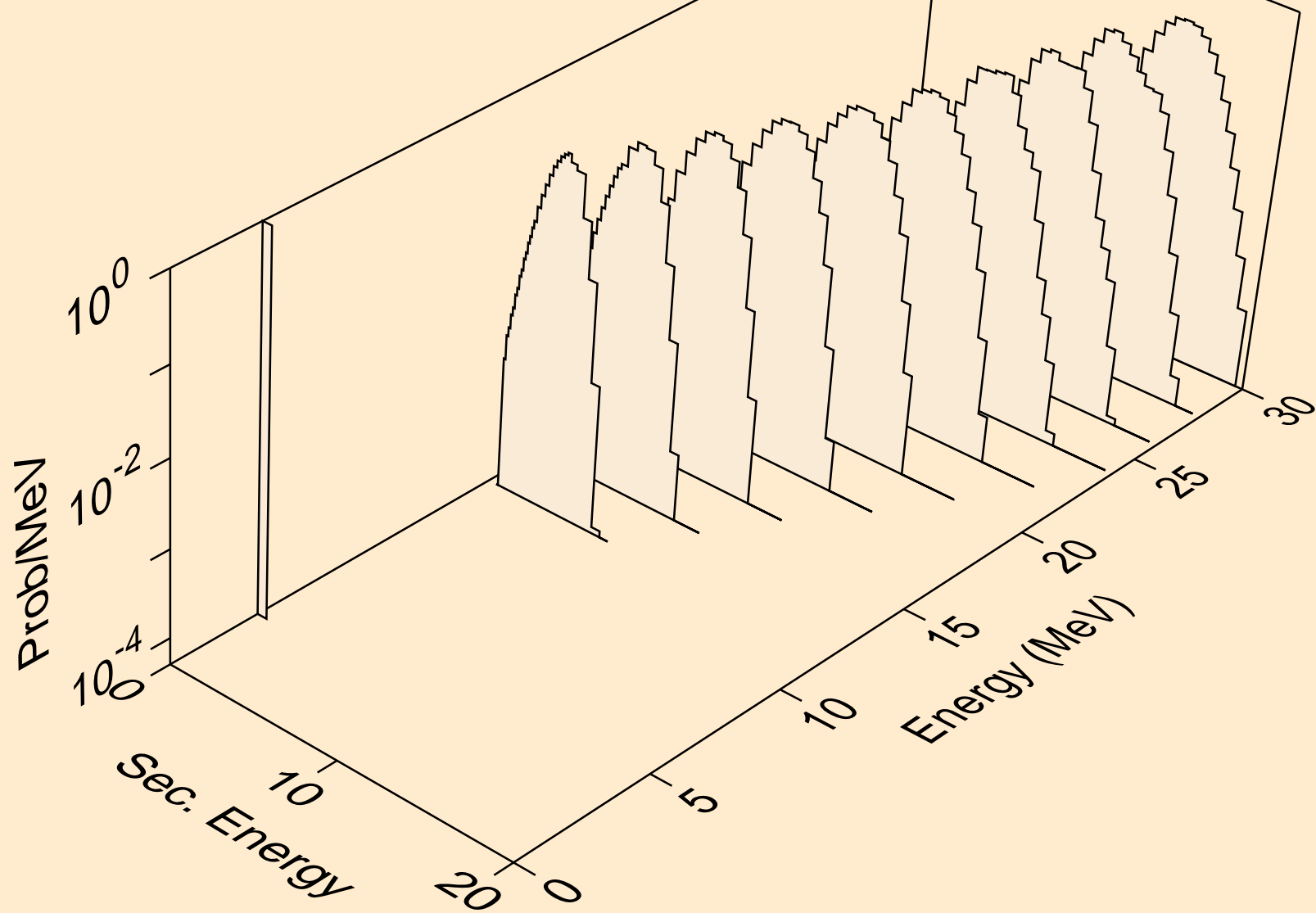

DB263 TRITON ACER TENDL-2021 LIBRARY; T=0.K  
deuterons from (t,da)

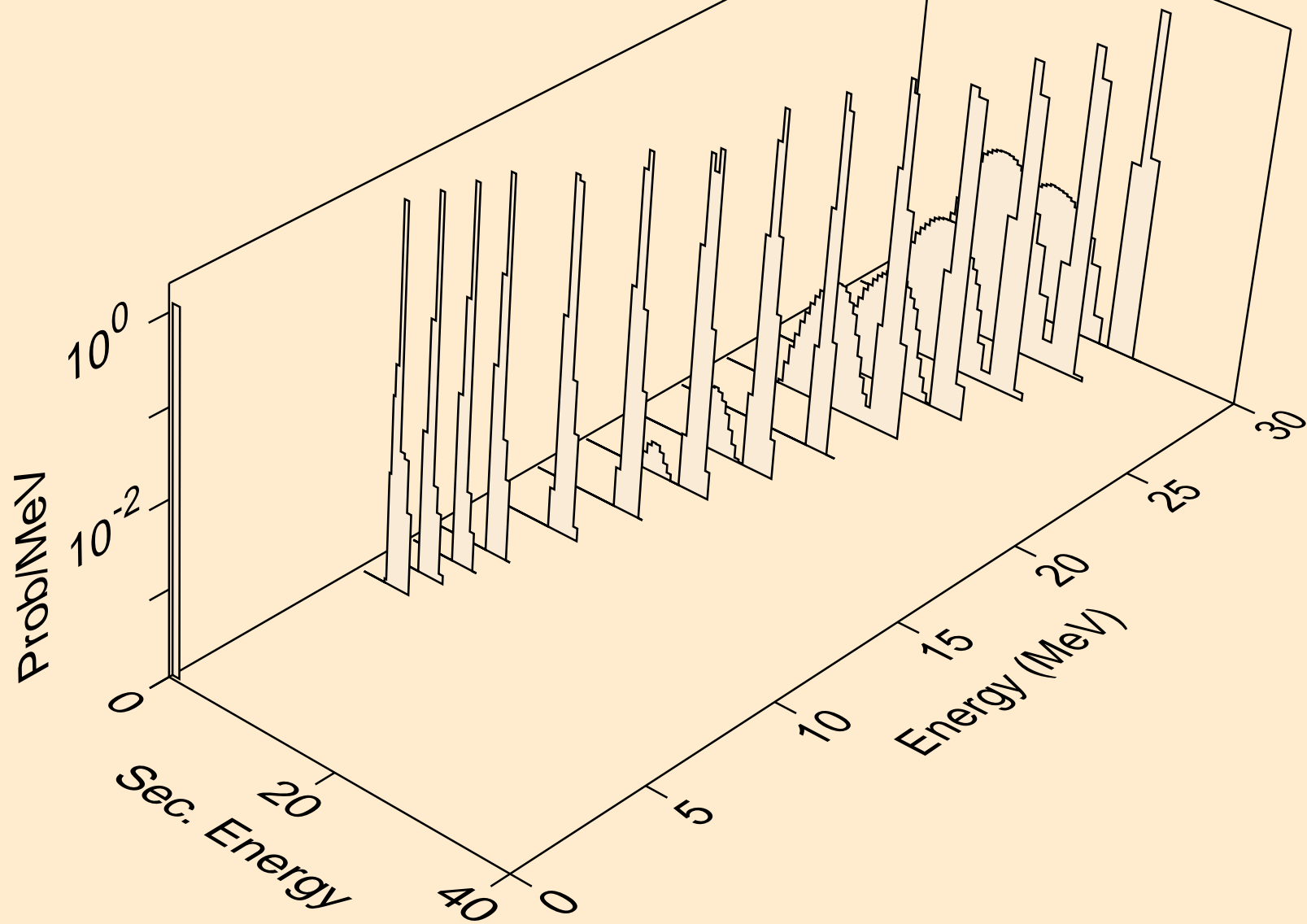

DB263 TRITON ACER TENDL-2021 LIBRARY; T=0.K  
he3s from (t,x)

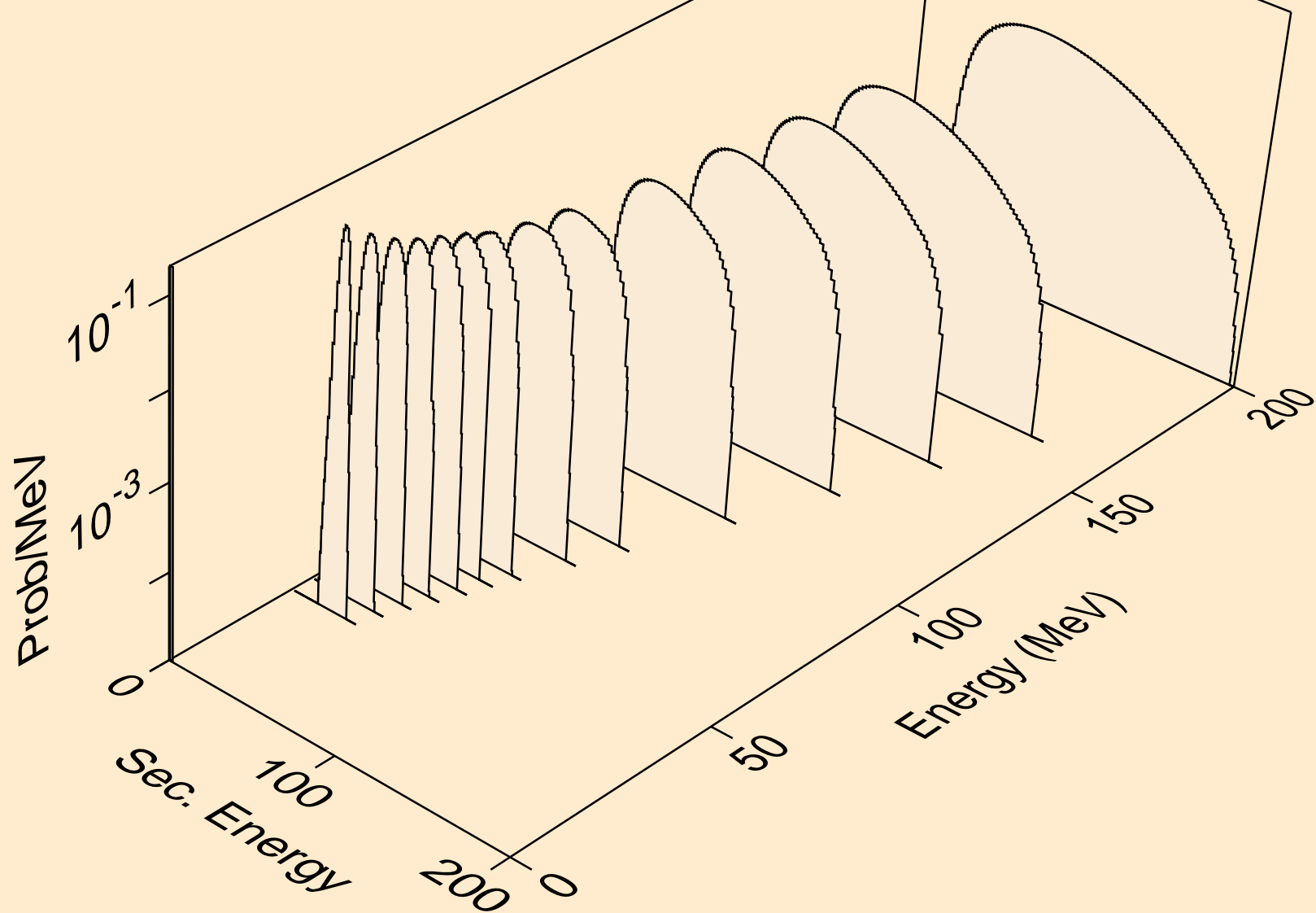

DB263 TRITON ACER TENDL-2021 LIBRARY; T=0.K  
he3s from (t,n\*)he3

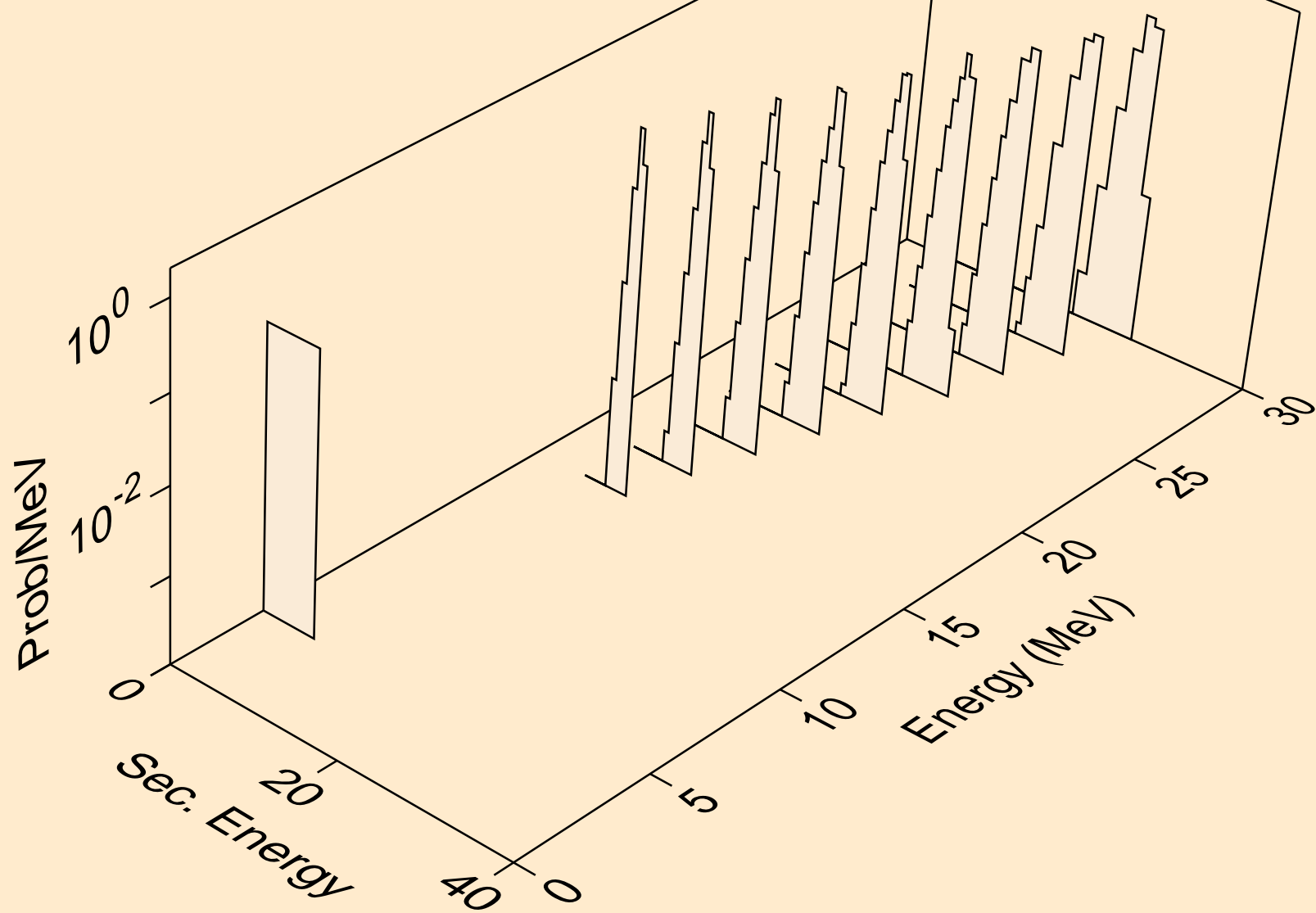

DB263 TRITON ACER TENDL-2021 LIBRARY; T=0.K  
he3s from (t,he3)

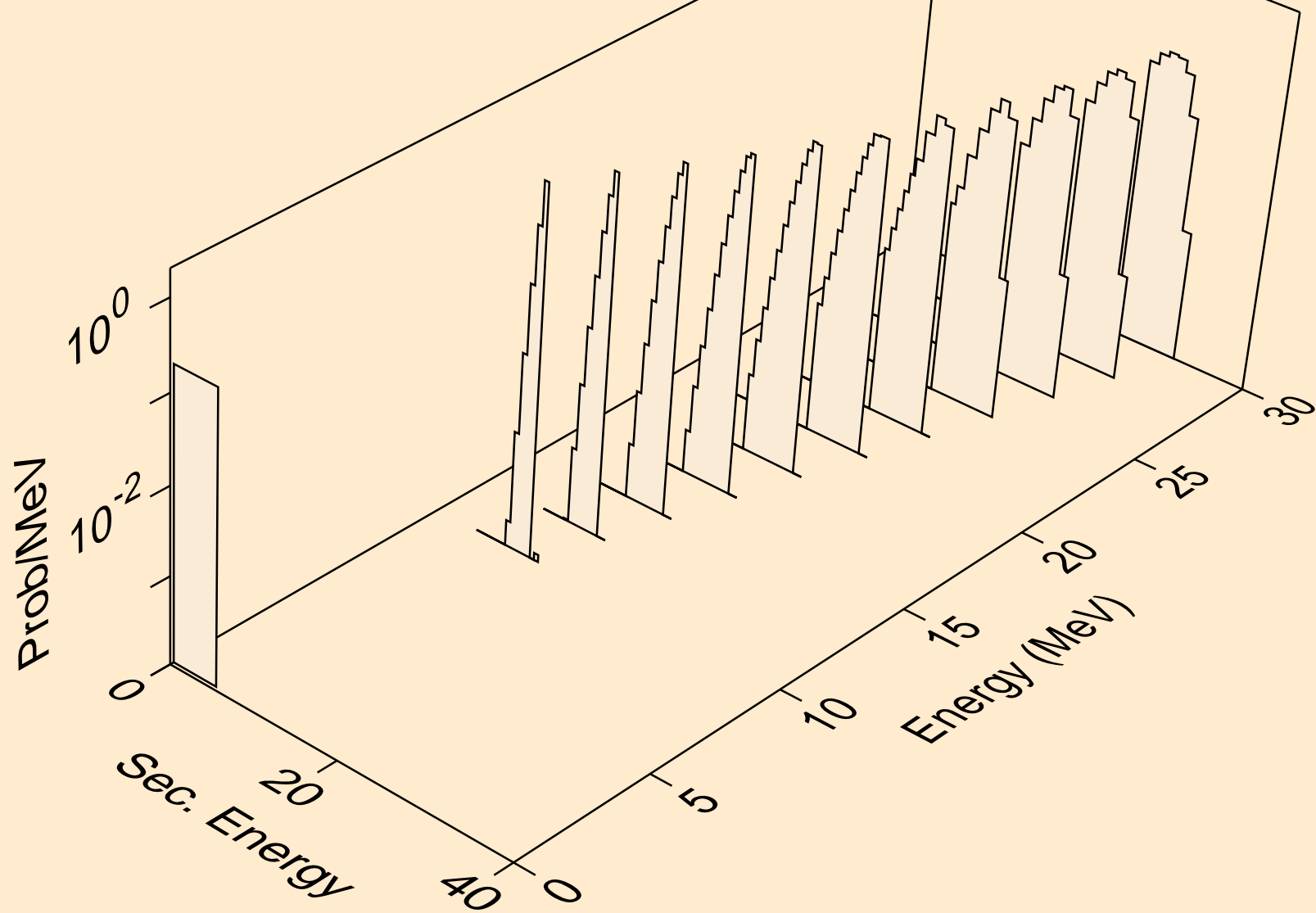



DB263 TRITON ACER TENDL-2021 LIBRARY; T=0.K  
alphas from (t,x)

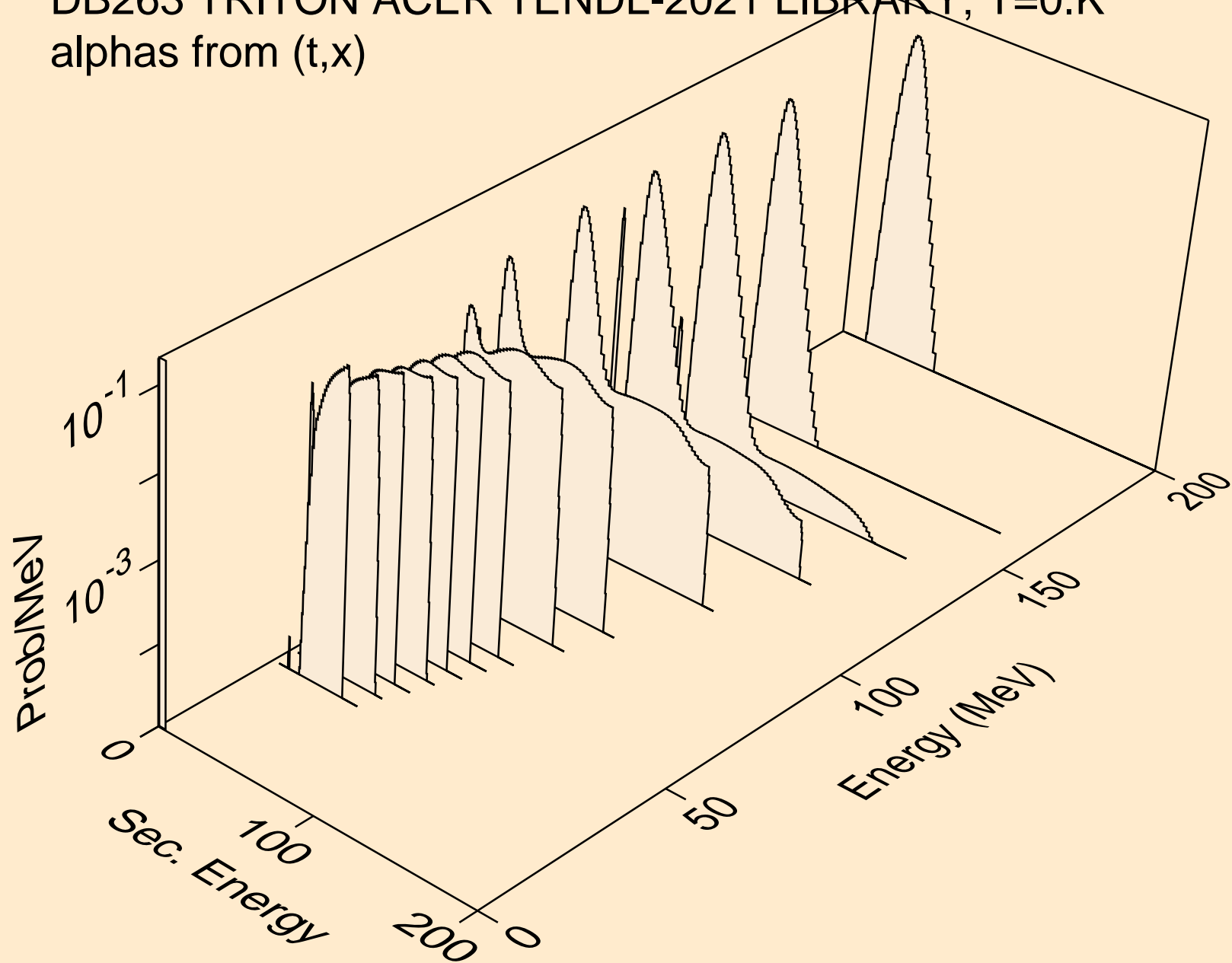

DB263 TRITON ACER TENDL-2021 LIBRARY; T=0.K  
alphas from (t,n\*)a

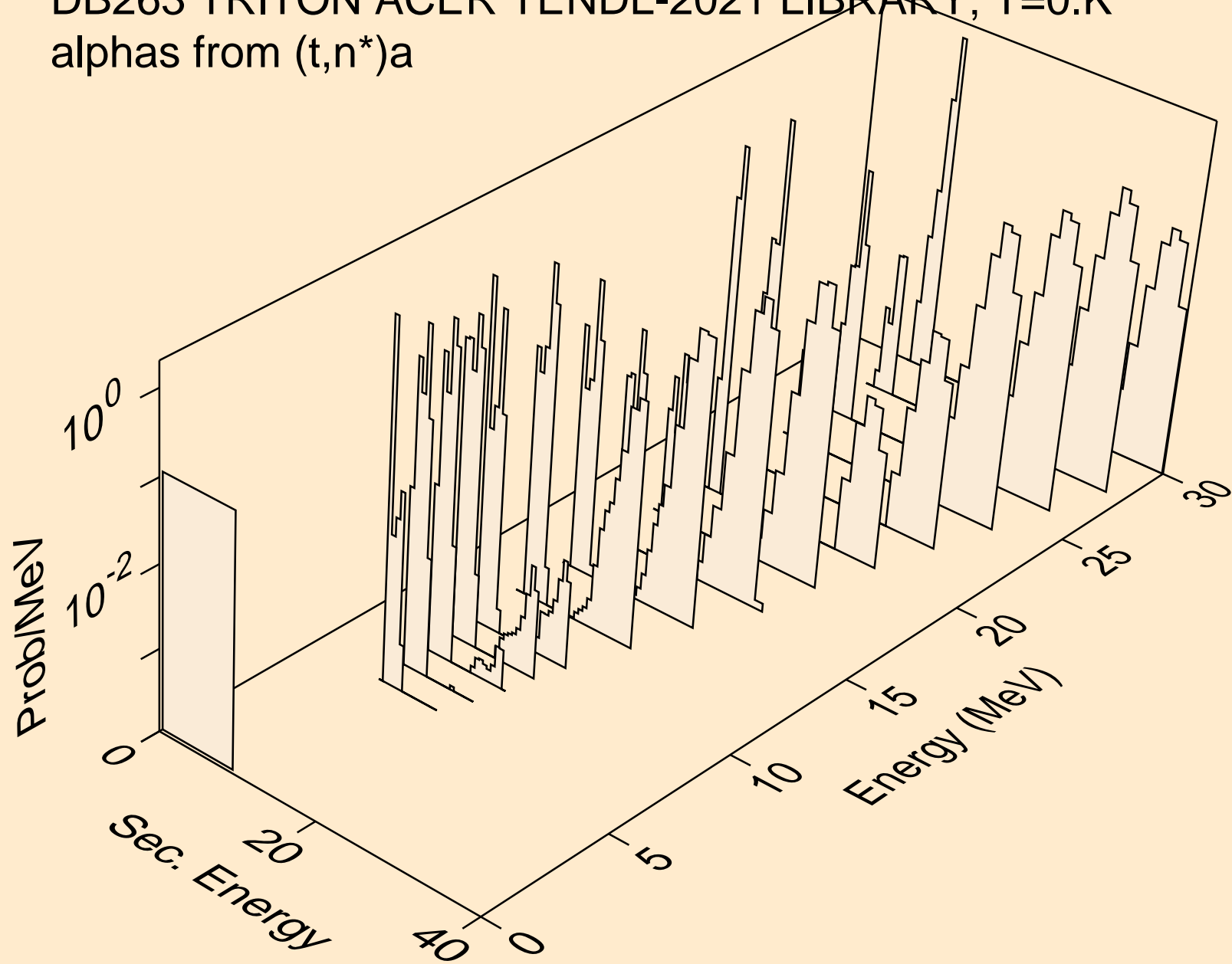

DB263 TRITON ACER TENDL-2021 LIBRARY; T=0.K  
alphas from (t,n\*)t2a

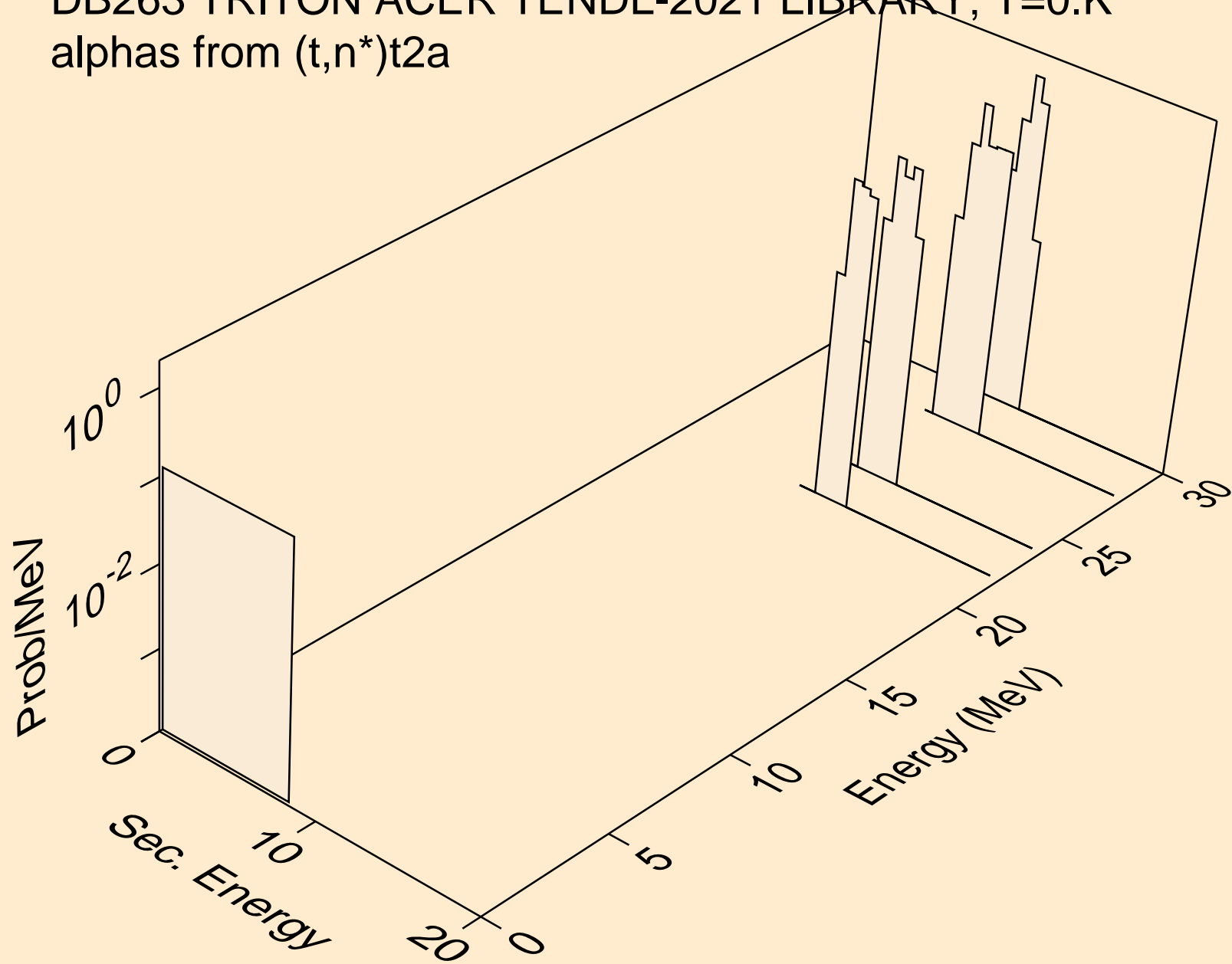

DB263 TRITON ACER TENDL-2021 LIBRARY; T=0.K  
alphas from (t,a)

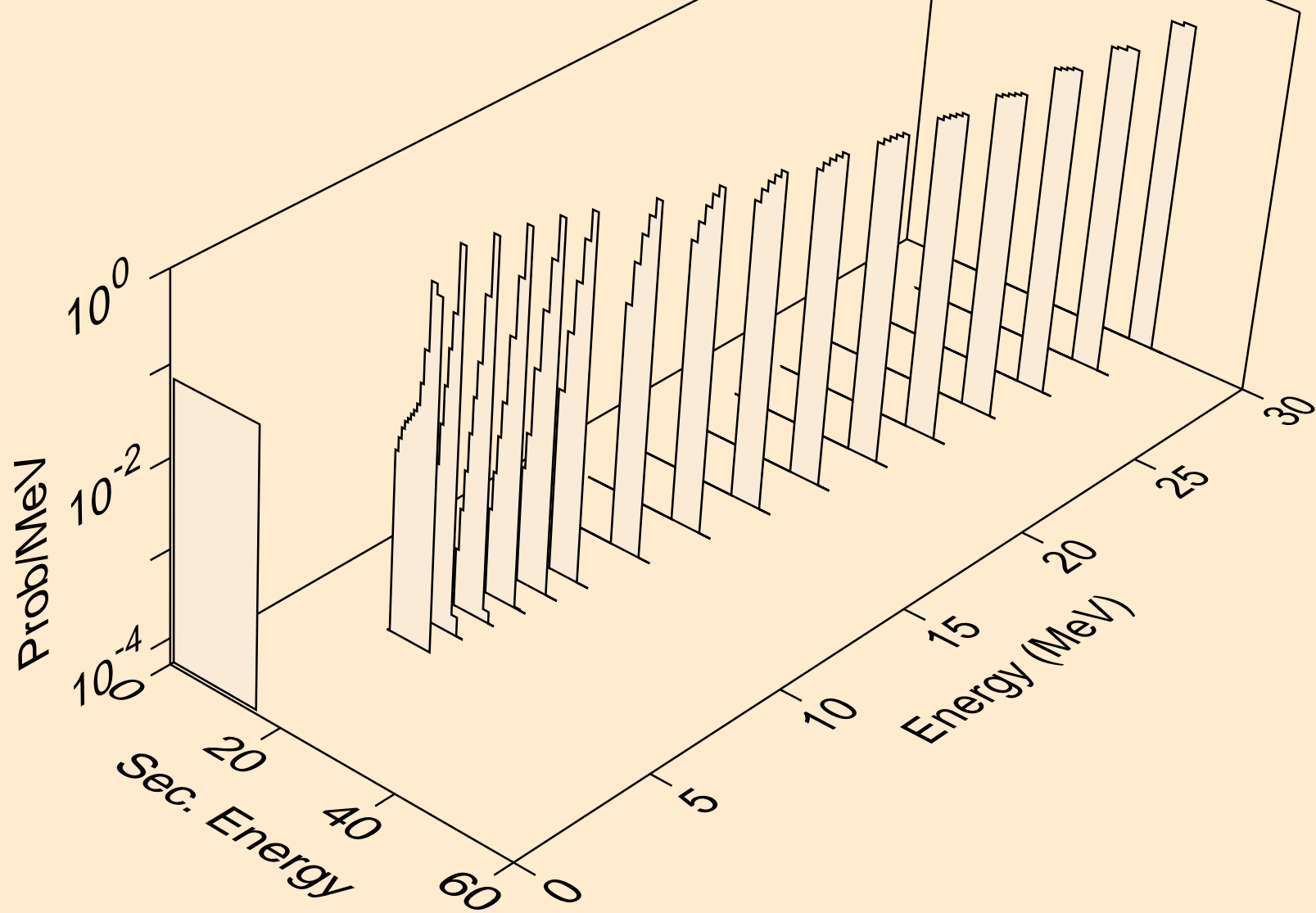

DB263 TRITON ACER TENDL-2021 LIBRARY; T=0.K  
alphas from (t,da)

