

EU153 TRITON ACER TENDL-2023 LIBRARY; T=0.K

Principal cross sections

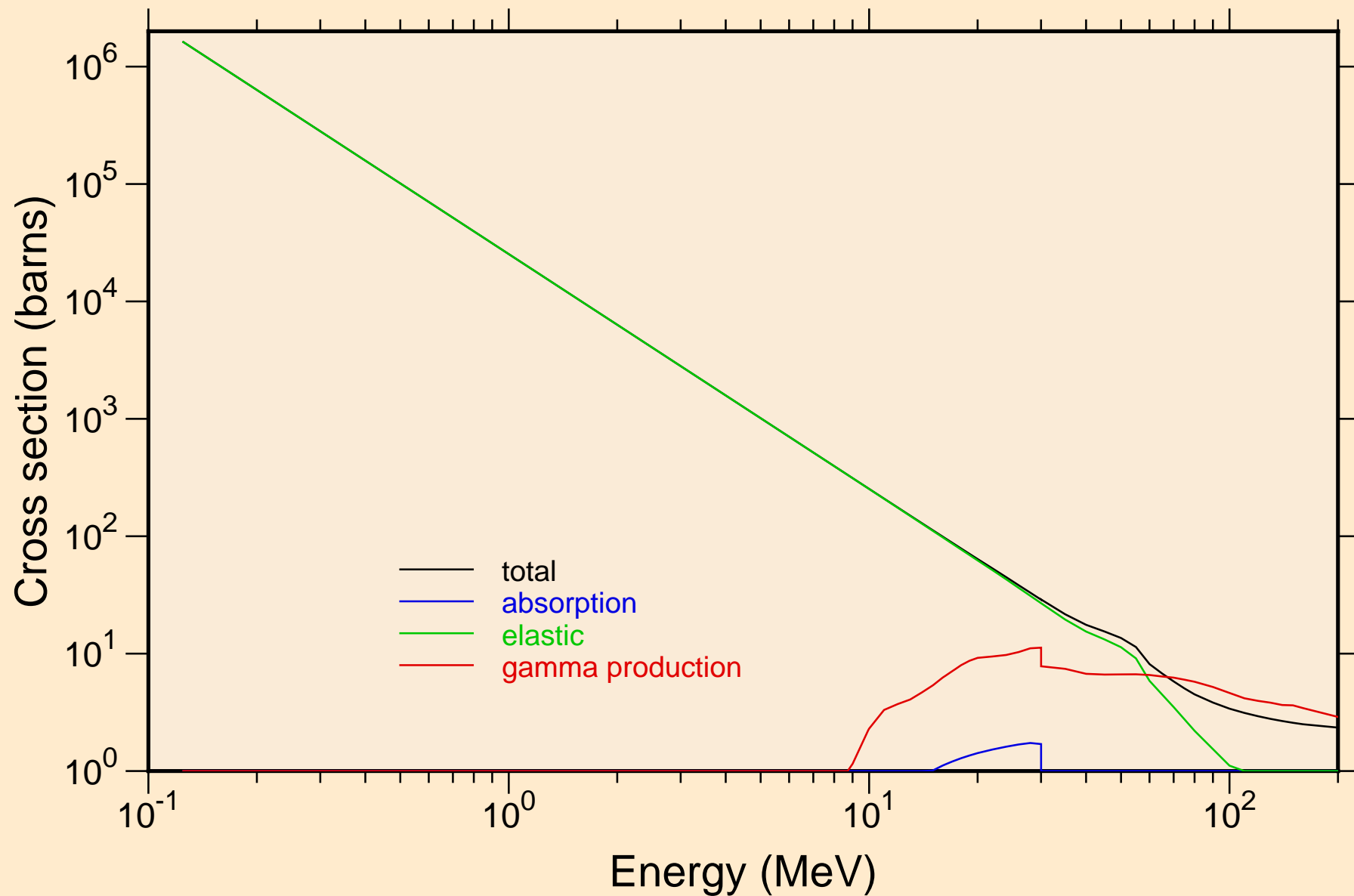

EU153 TRITON ACER TENDL-2023 LIBRARY; T=0.K
Heating

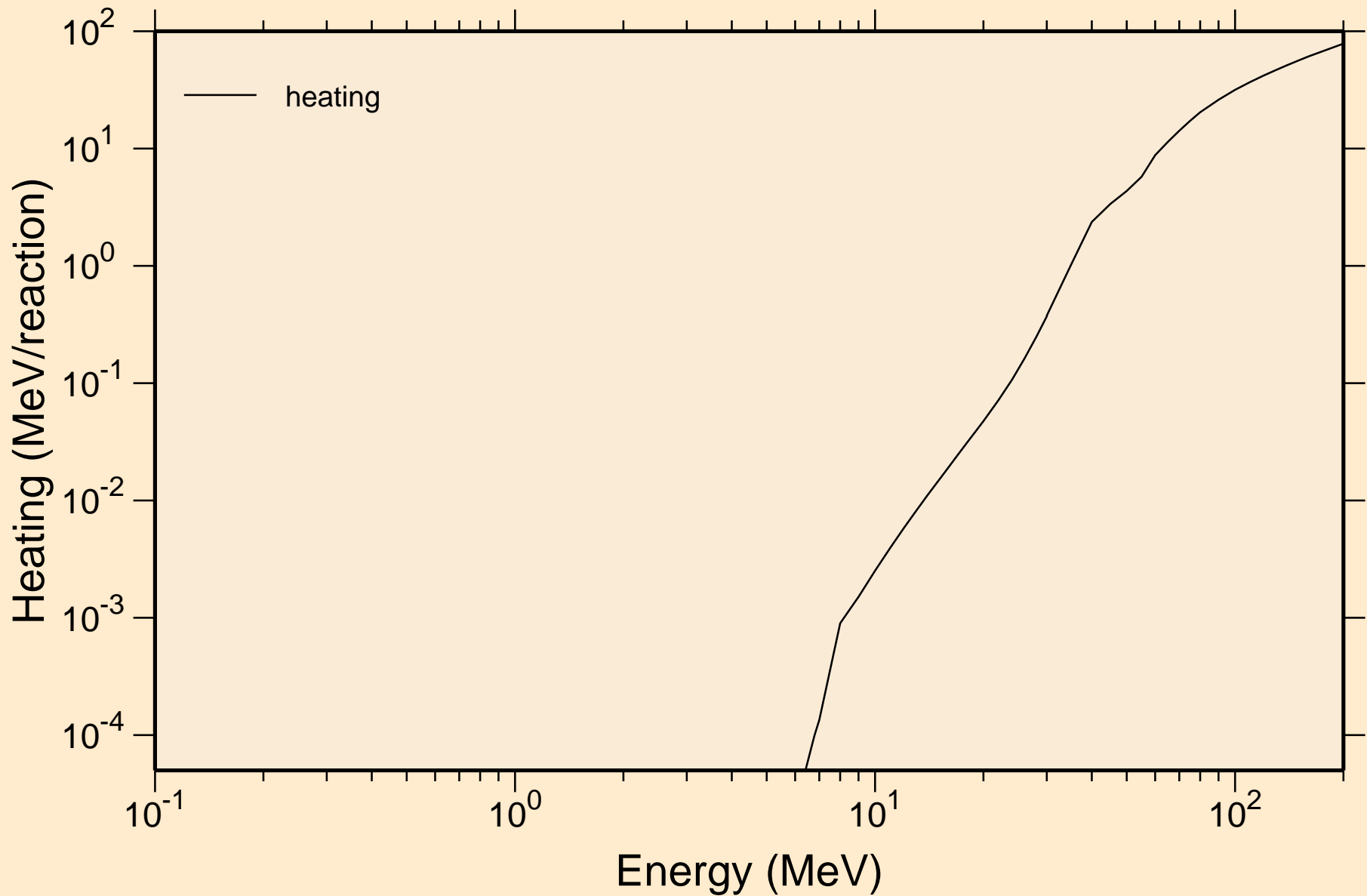

EU153 TRITON ACER TENDL-2023 LIBRARY; T=0.K

Principal cross sections

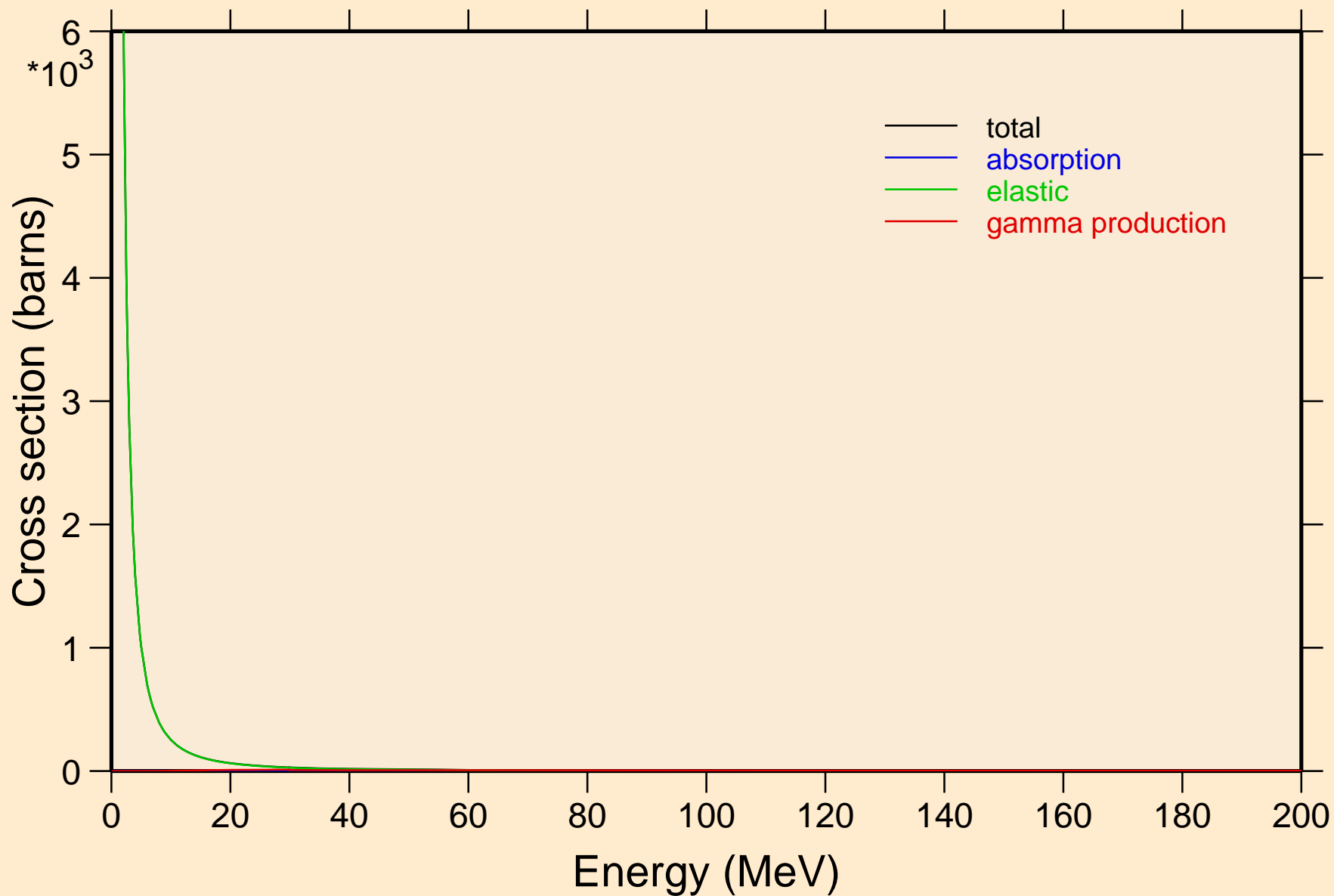

EU153 TRITON ACER TENDL-2023 LIBRARY; T=0.K

Heating

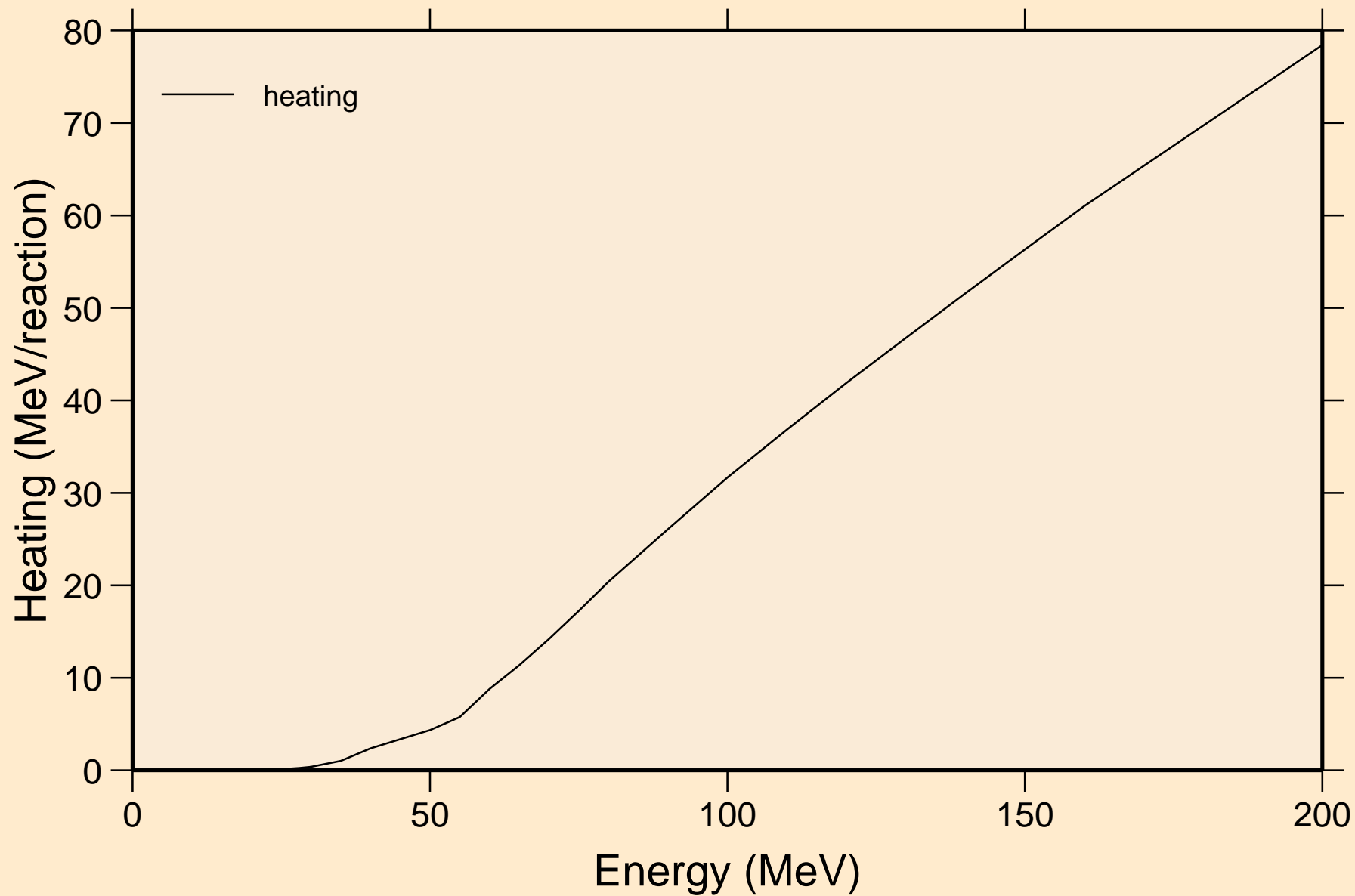

EU153 TRITON ACER TENDL-2023 LIBRARY; T=0.K
Threshold reactions

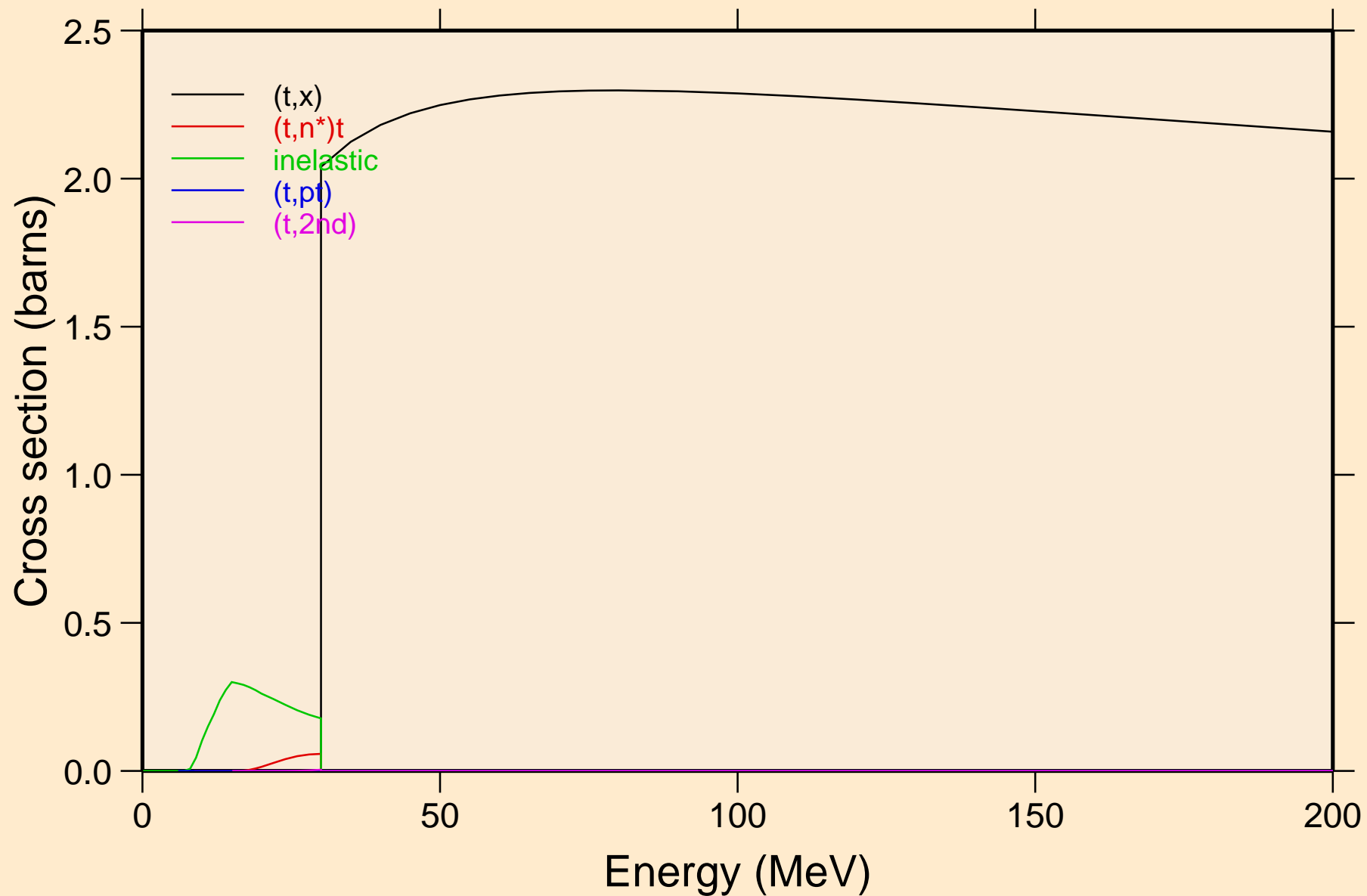

EU153 TRITON ACER TENDL-2023 LIBRARY; T=0.K
Threshold reactions

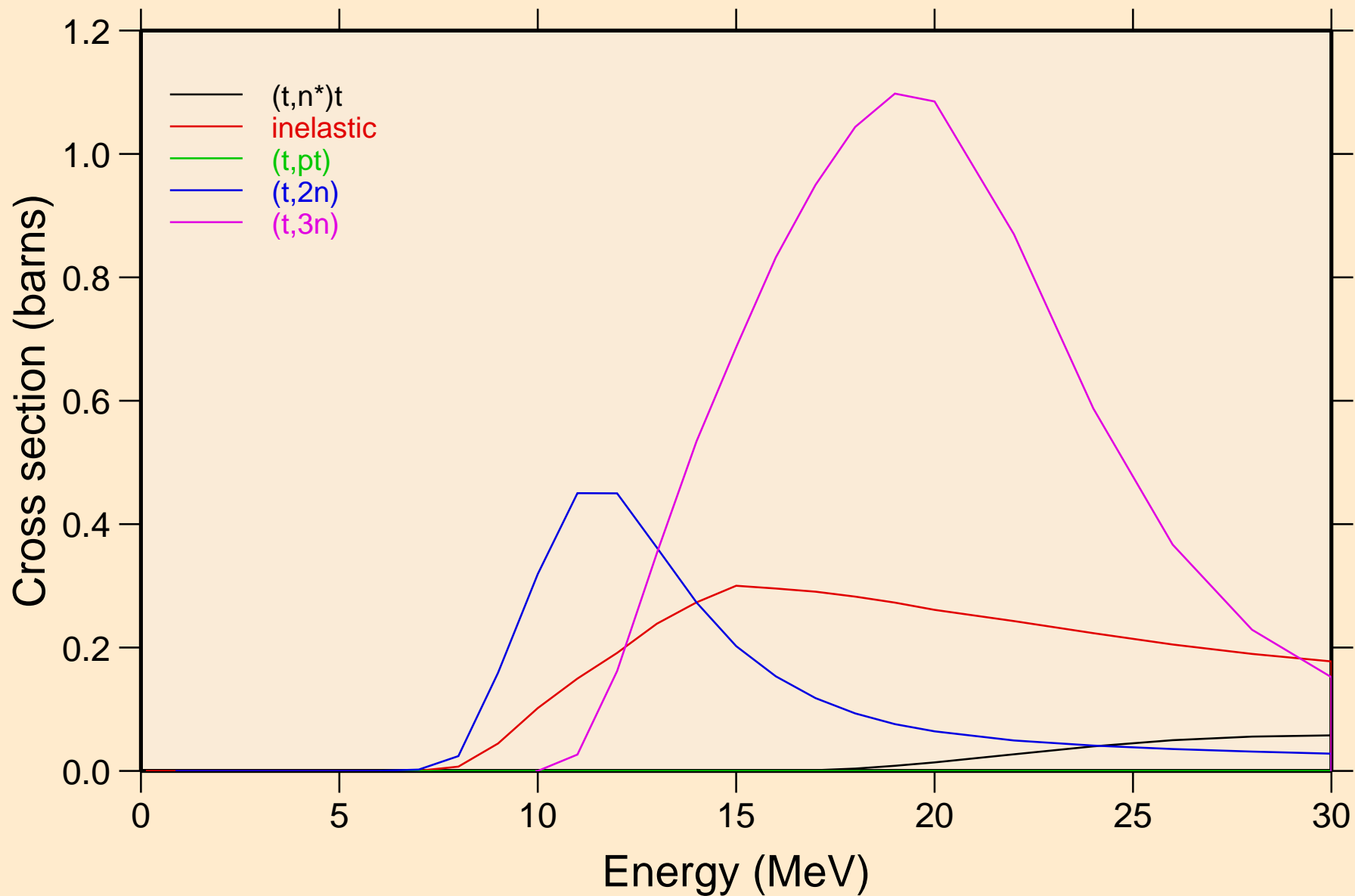

EU153 TRITON ACER TENDL-2023 LIBRARY; T=0.K

Threshold reactions

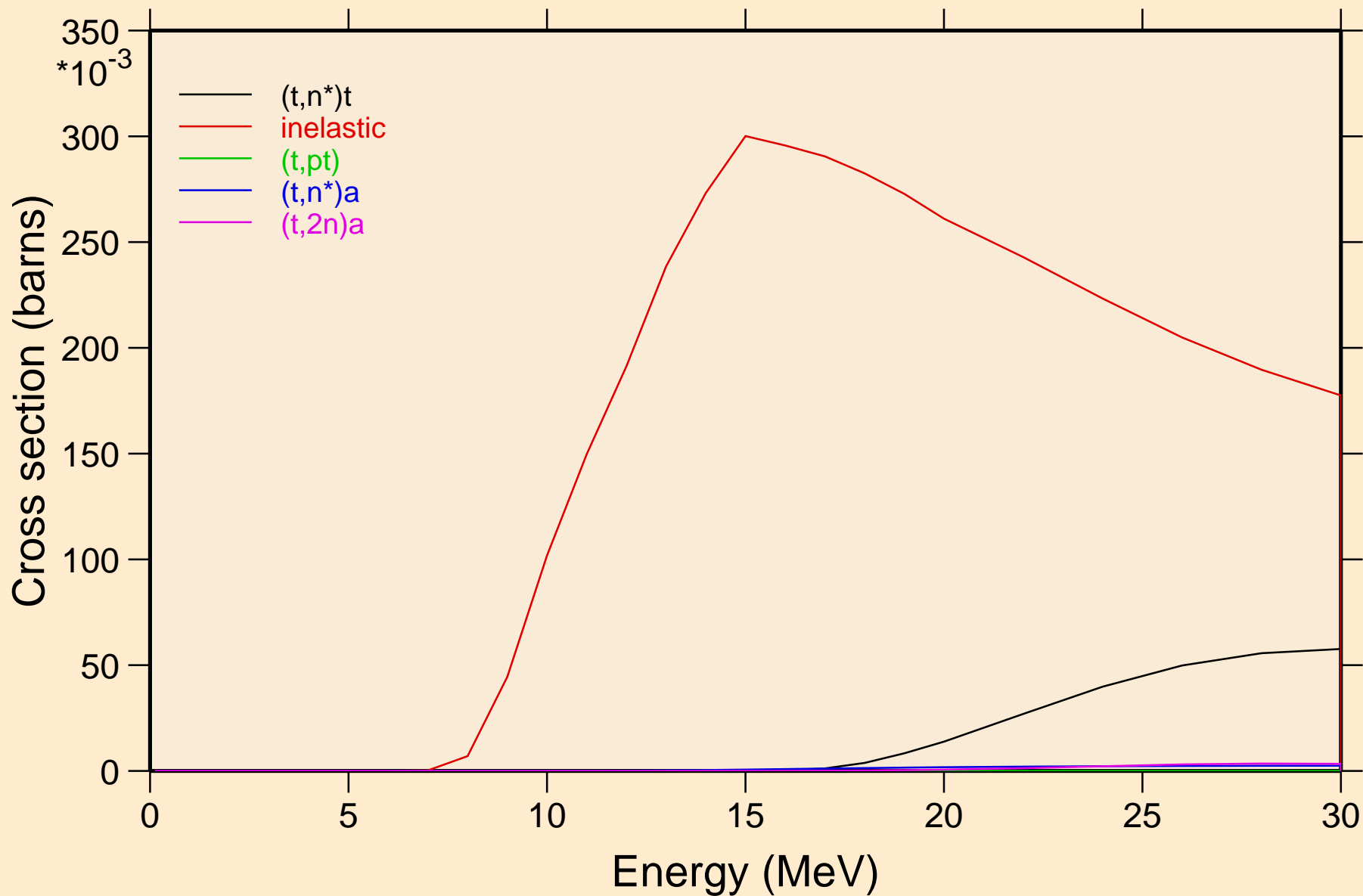

EU153 TRITON ACER TENDL-2023 LIBRARY; T=0.K

Threshold reactions

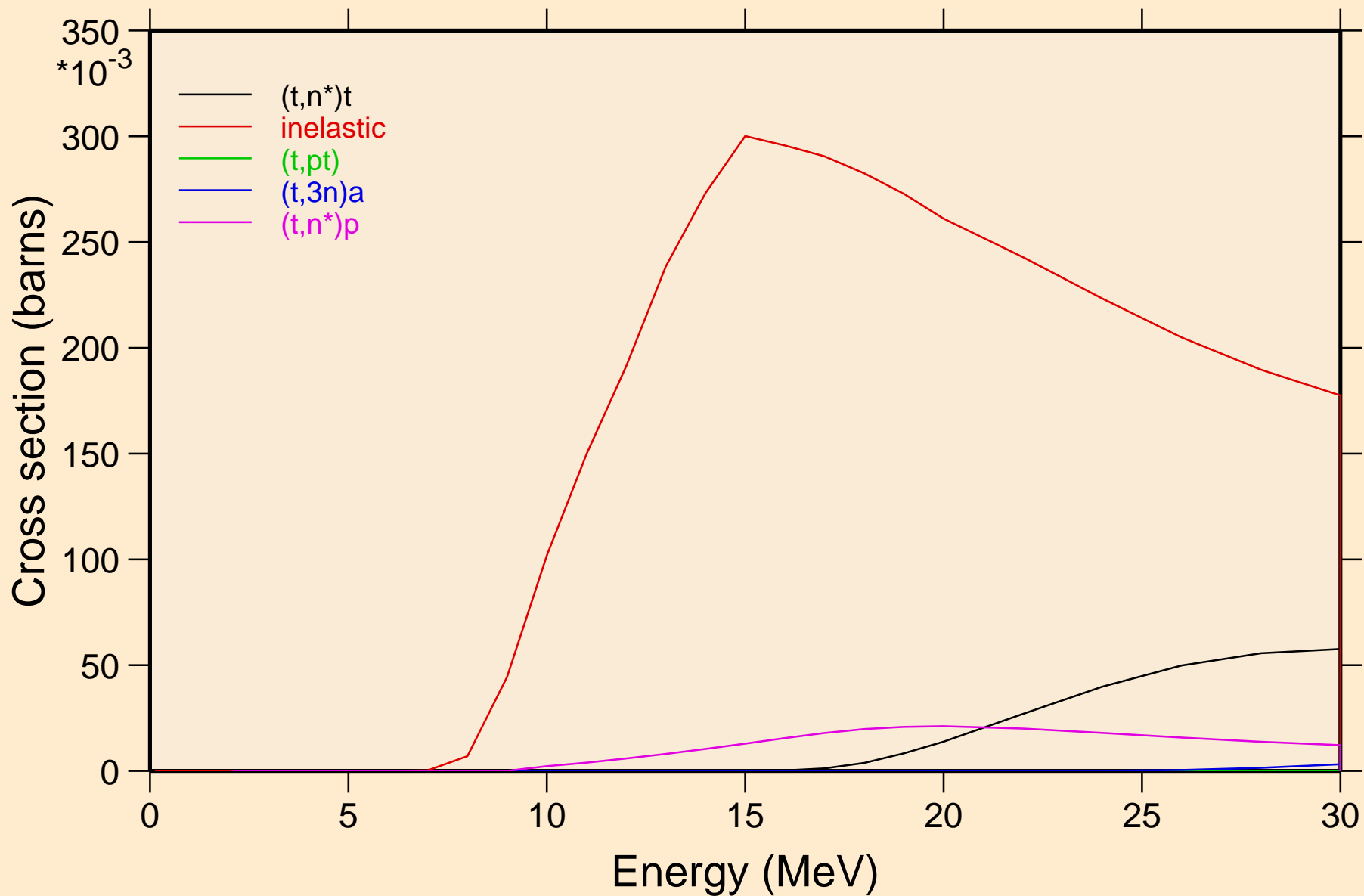

EU153 TRITON ACER TENDL-2023 LIBRARY; T=0.K

Threshold reactions

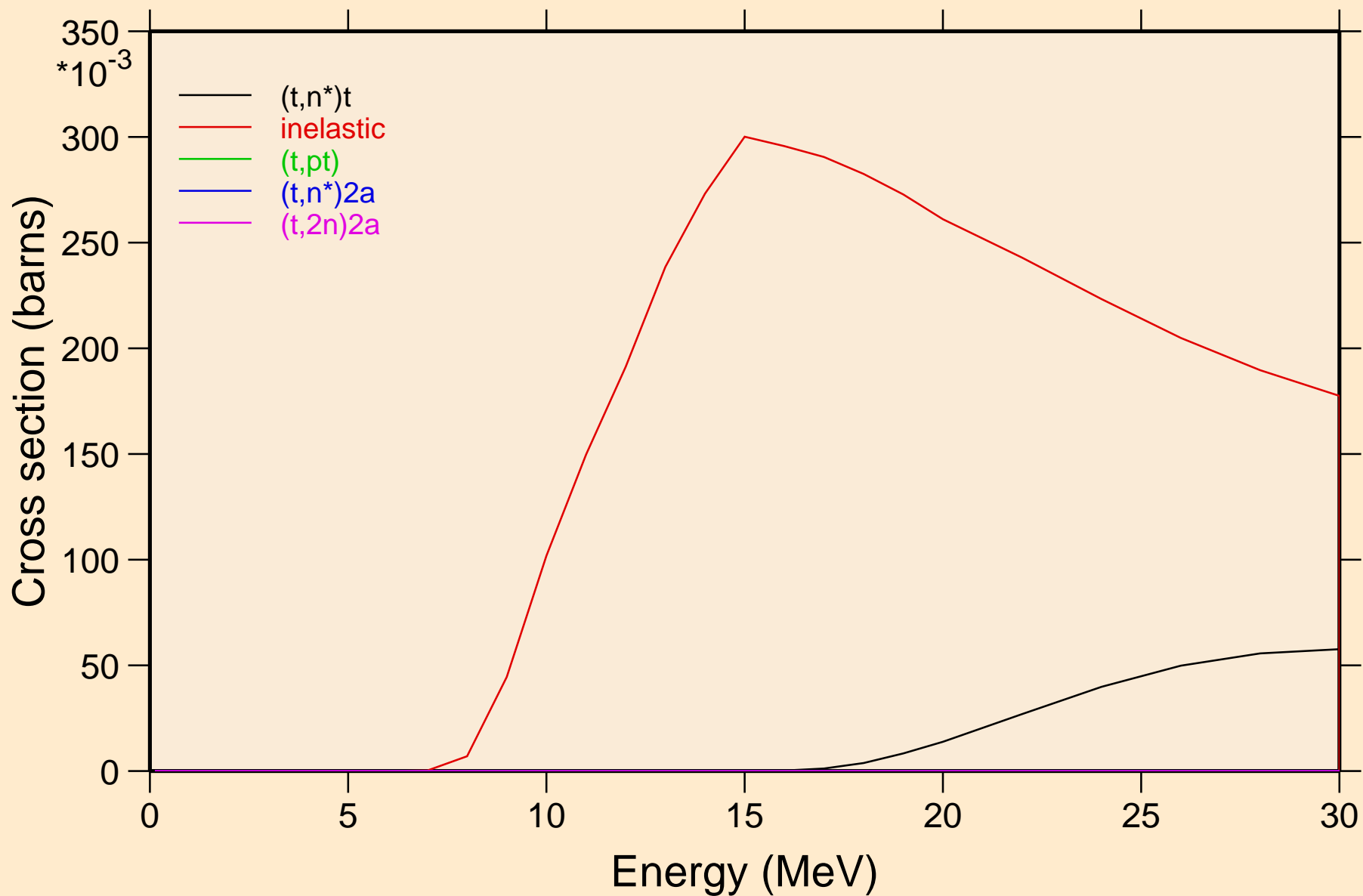

EU153 TRITON ACER TENDL-2023 LIBRARY; T=0.K

Threshold reactions

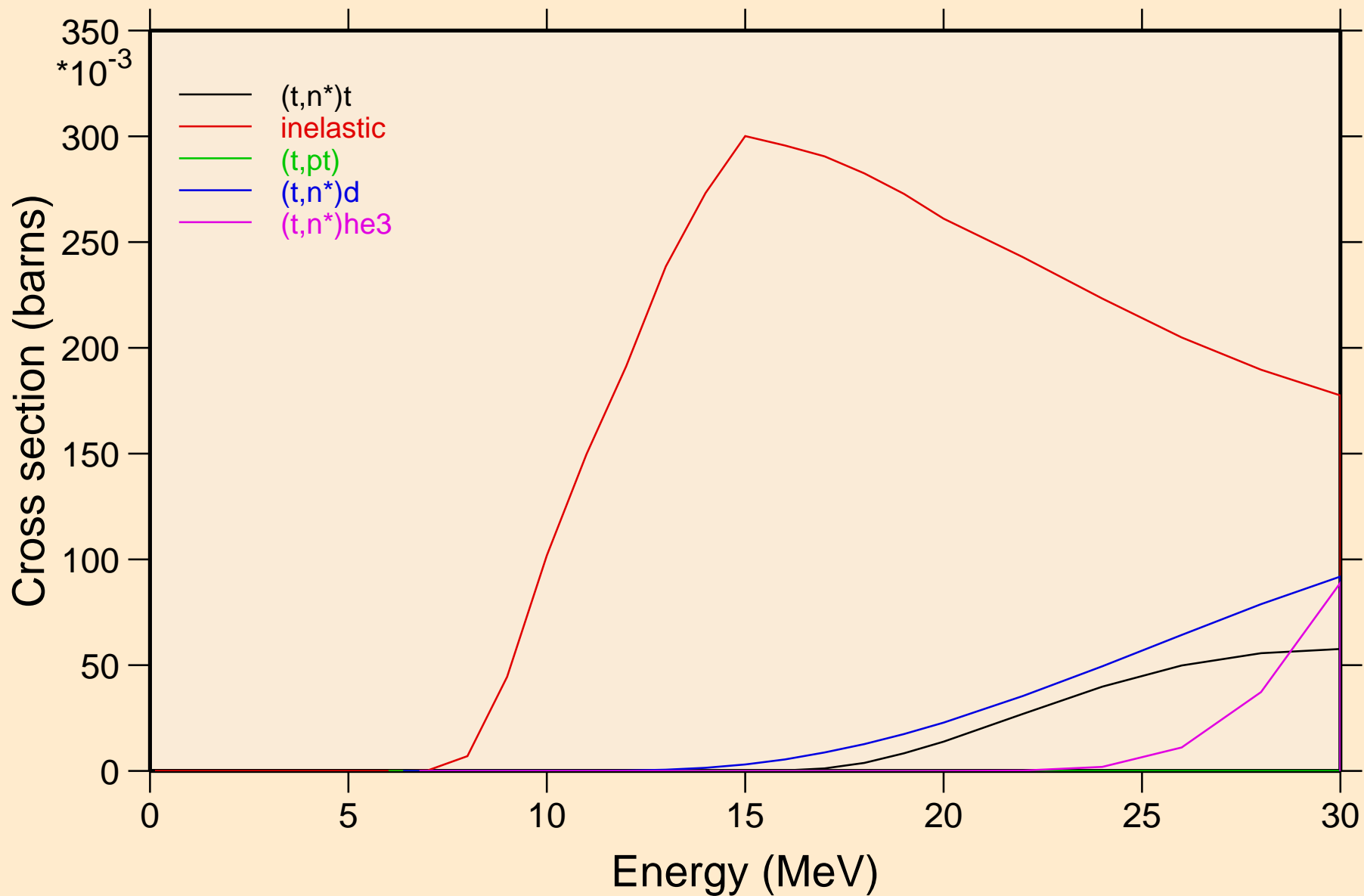

EU153 TRITON ACER TENDL-2023 LIBRARY; T=0.K

Threshold reactions

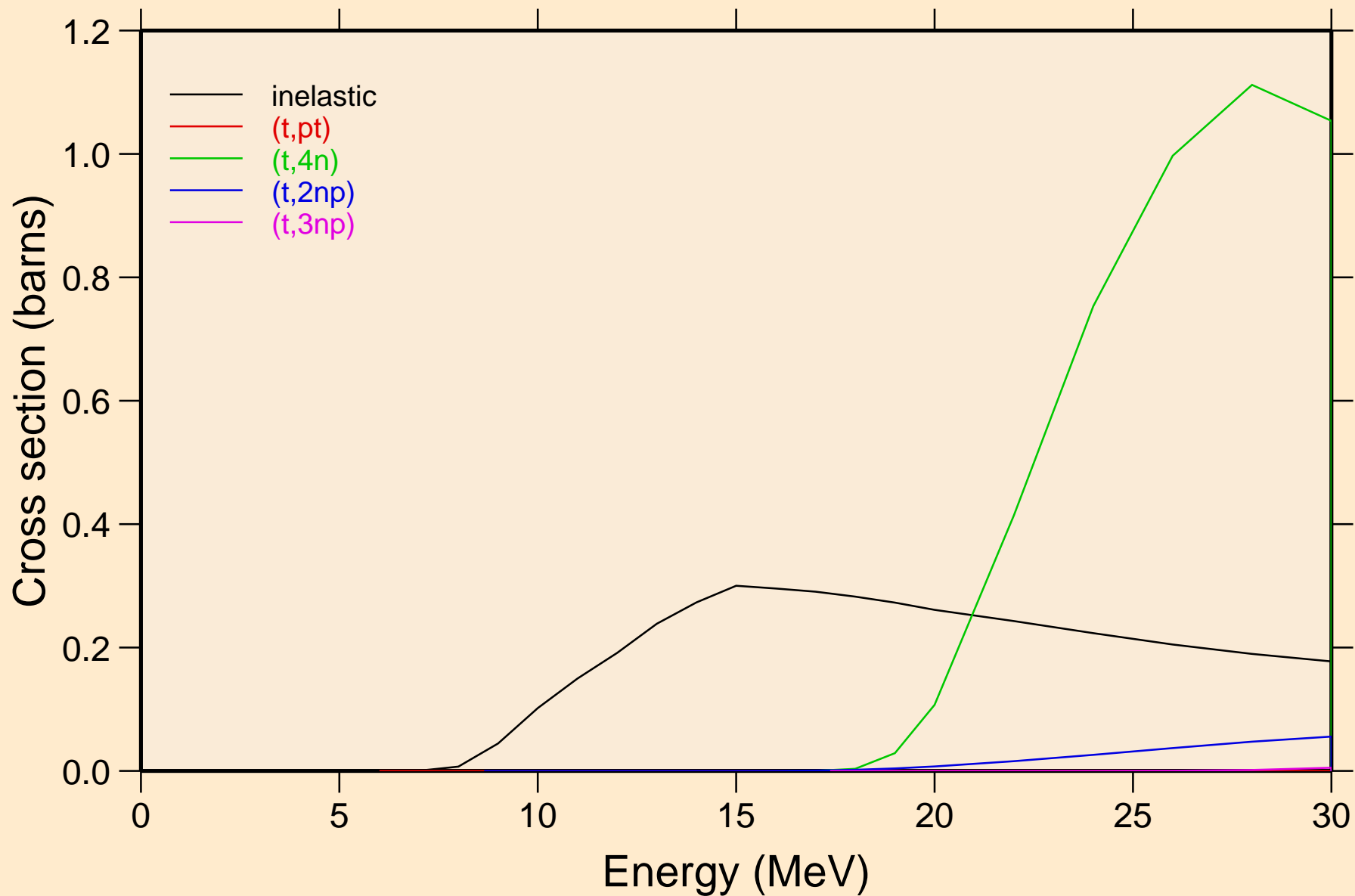

EU153 TRITON ACER TENDL-2023 LIBRARY; T=0.K
Threshold reactions

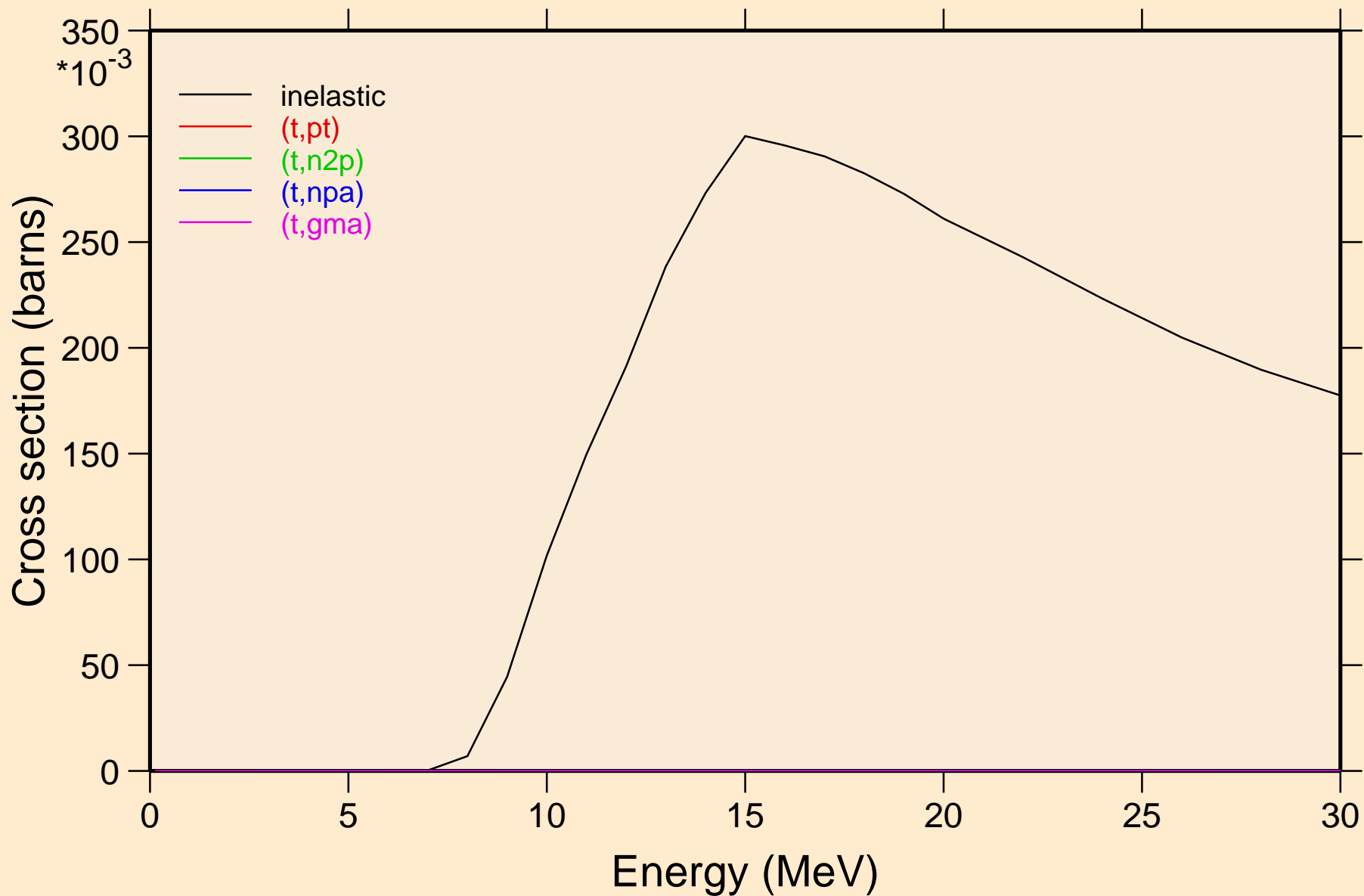

EU153 TRITON ACER TENDL-2023 LIBRARY; T=0.K

Threshold reactions

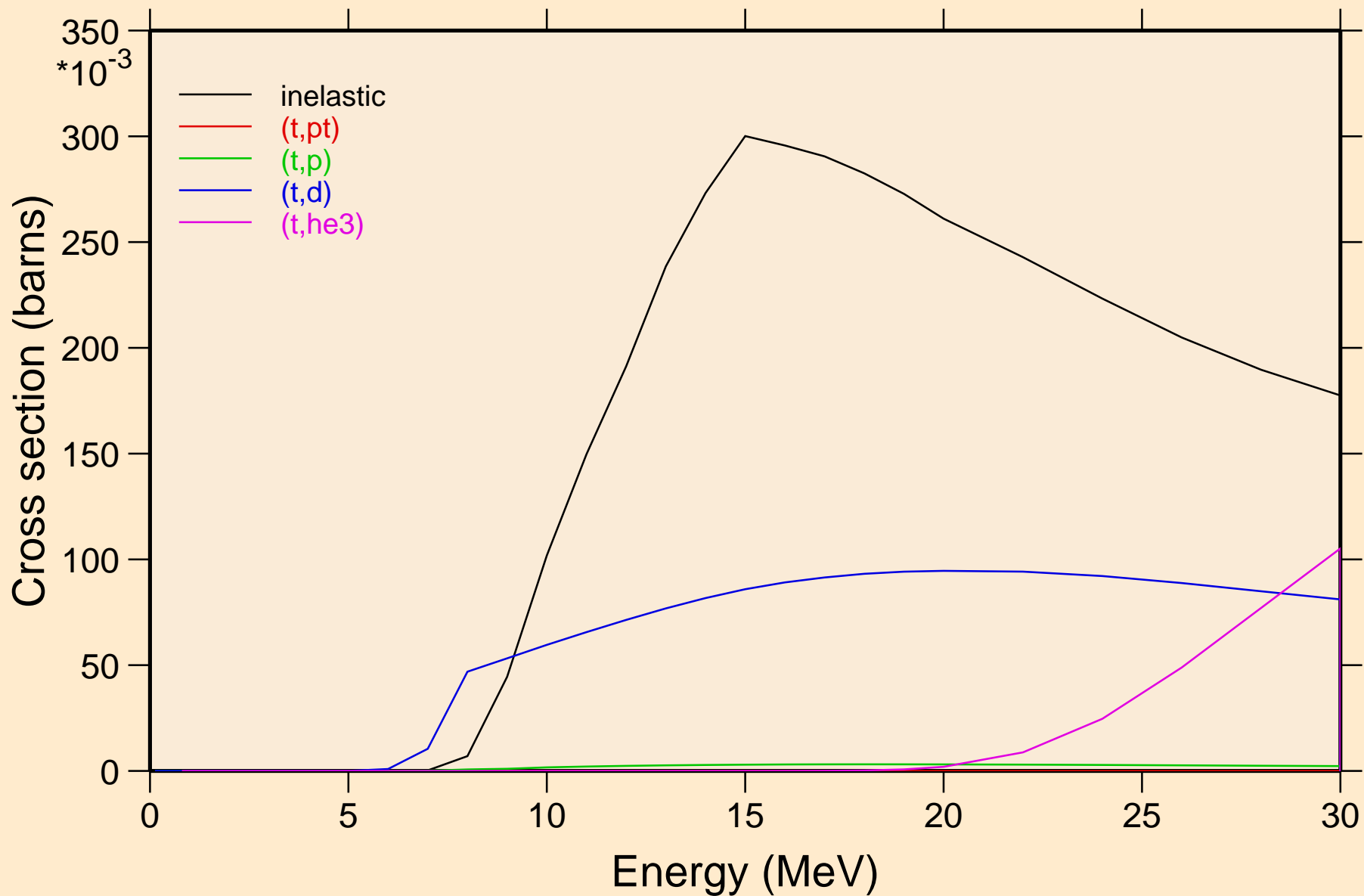

EU153 TRITON ACER TENDL-2023 LIBRARY; T=0.K
Threshold reactions

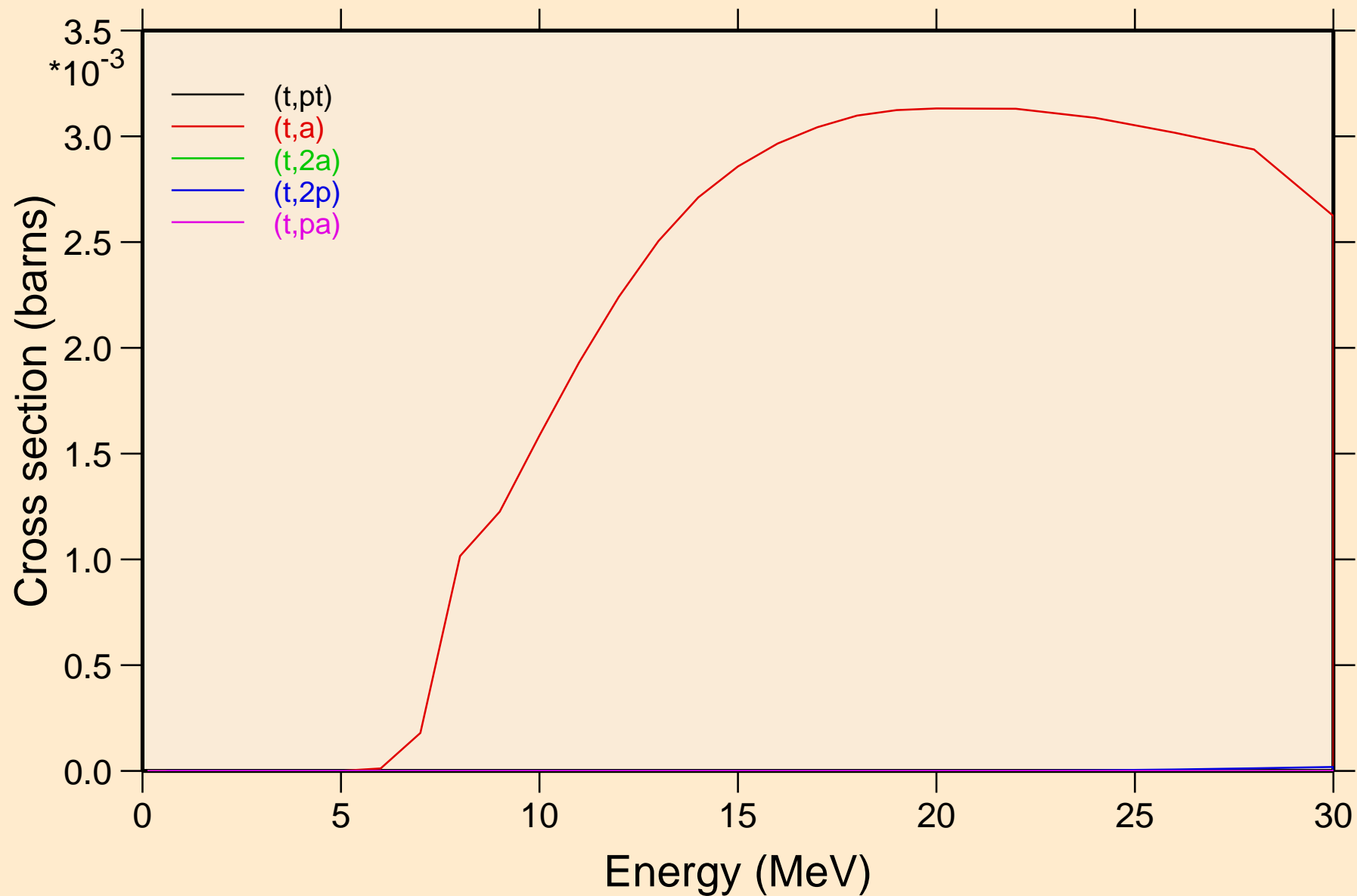

EU153 TRITON ACER TENDL-2023 LIBRARY; T=0.K
Threshold reactions

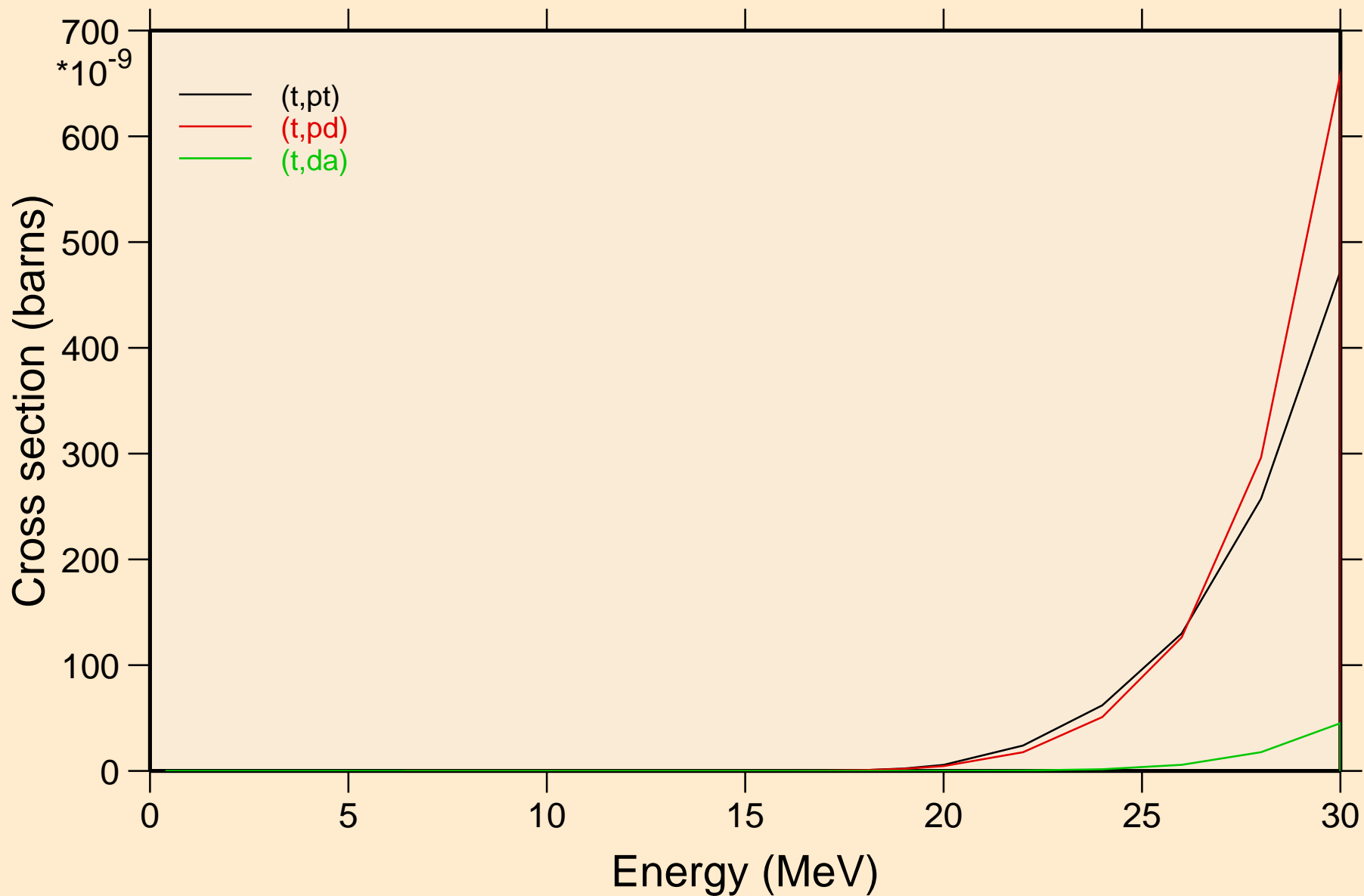

EU153 TRITON ACER TENDL-2023 LIBRARY; T=0.K
angular distribution for elastic

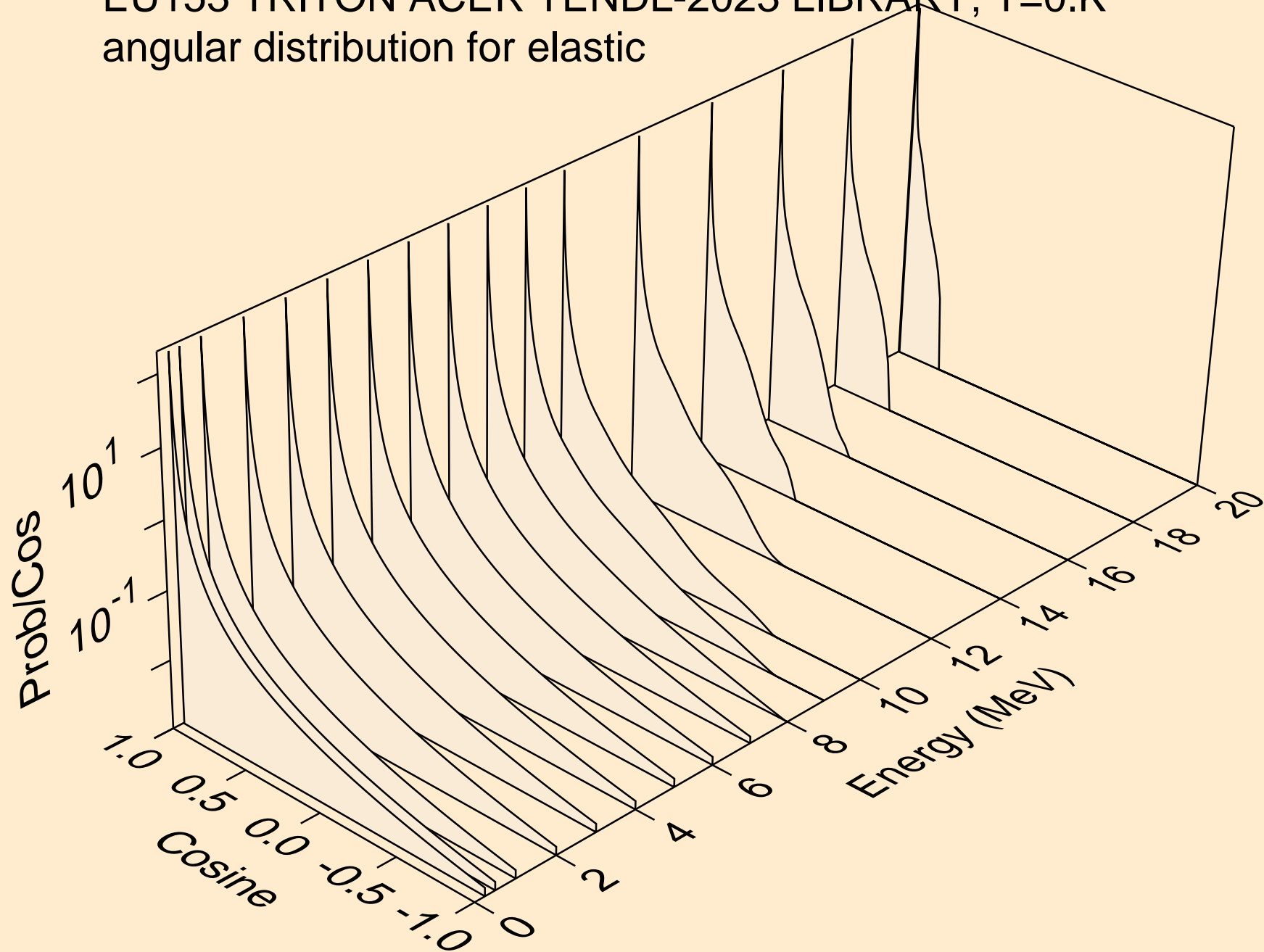

EU153 TRITON ACER TENDL-2023 LIBRARY; T=0.K
angular distribution for elastic

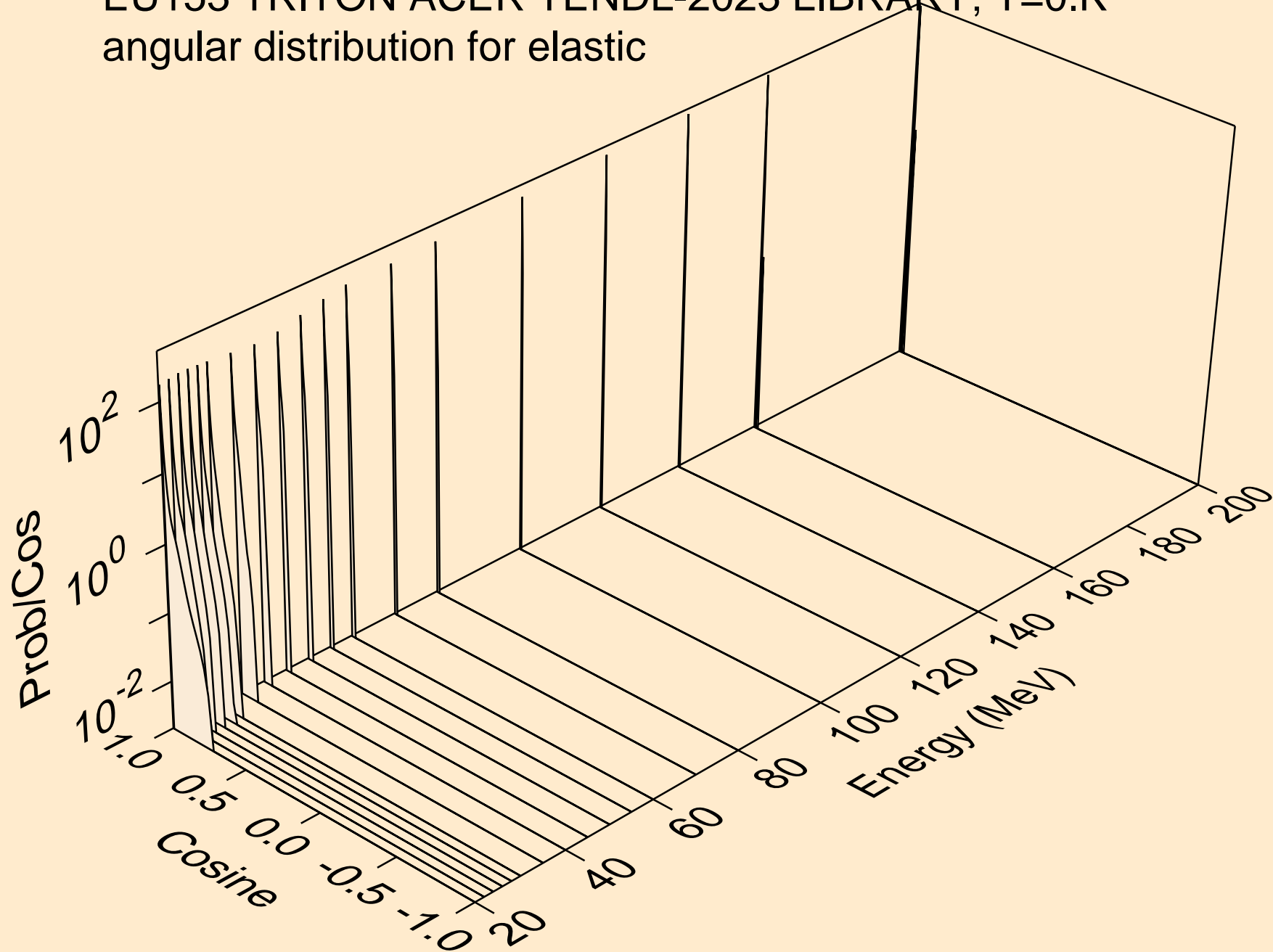

EU153 TRITON ACER TENDL-2023 LIBRARY; T=0.K
Triton emission for (t,x)

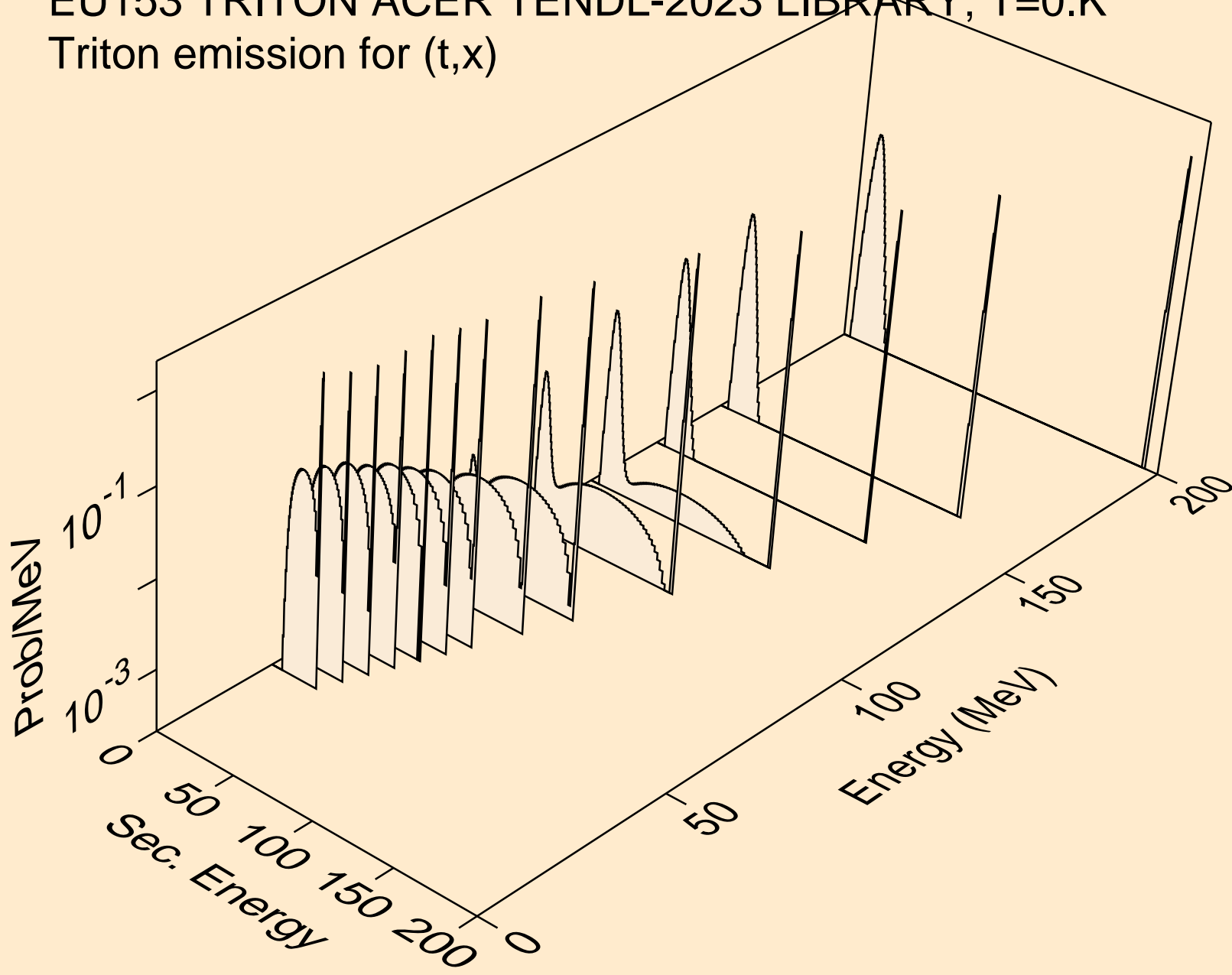

EU153 TRITON ACER TENDL-2023 LIBRARY; T=0.K
Triton emission for (t,n*)t

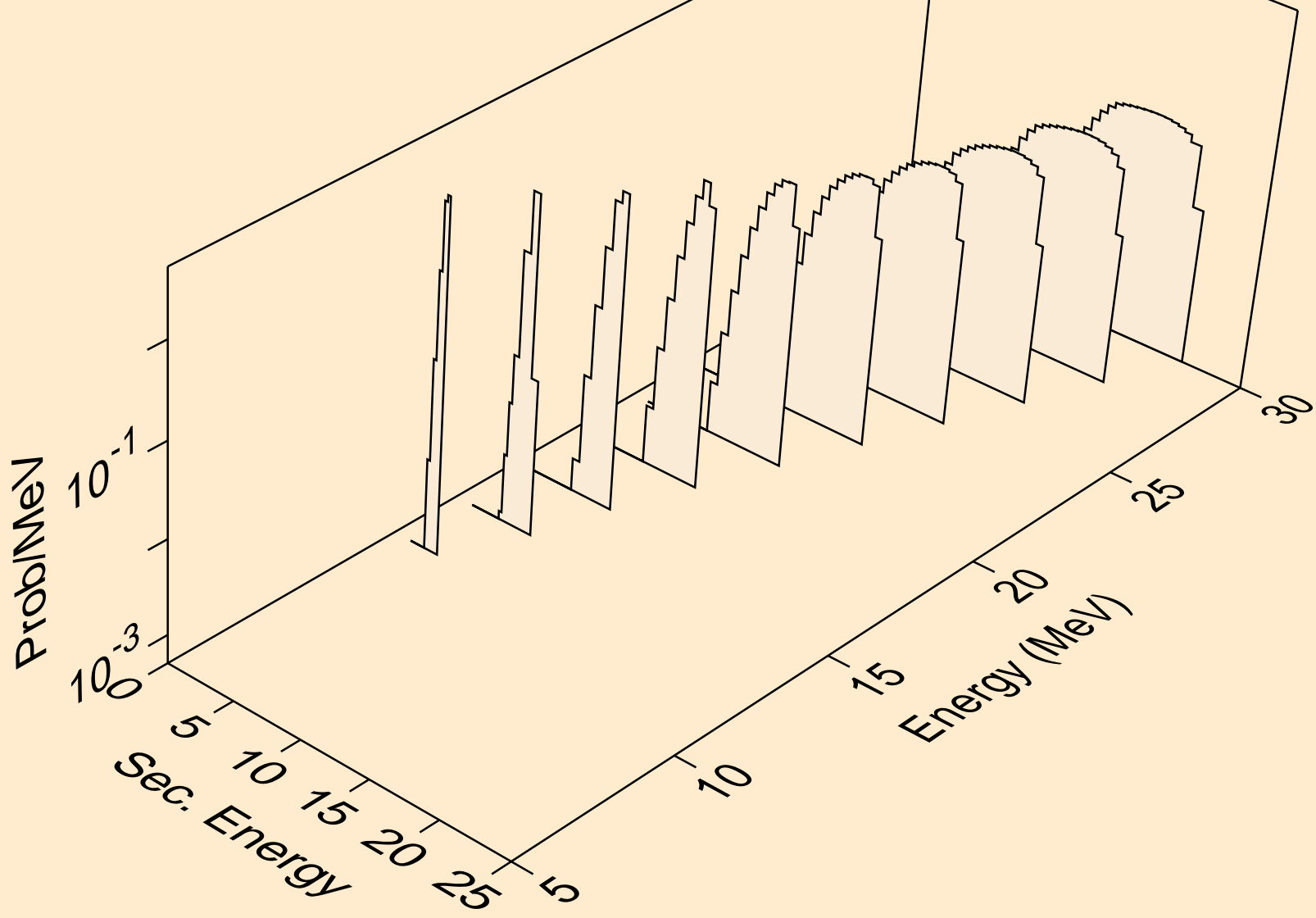

EU153 TRITON ACER TENDL-2023 LIBRARY; T=0.K
Triton emission for inelastic

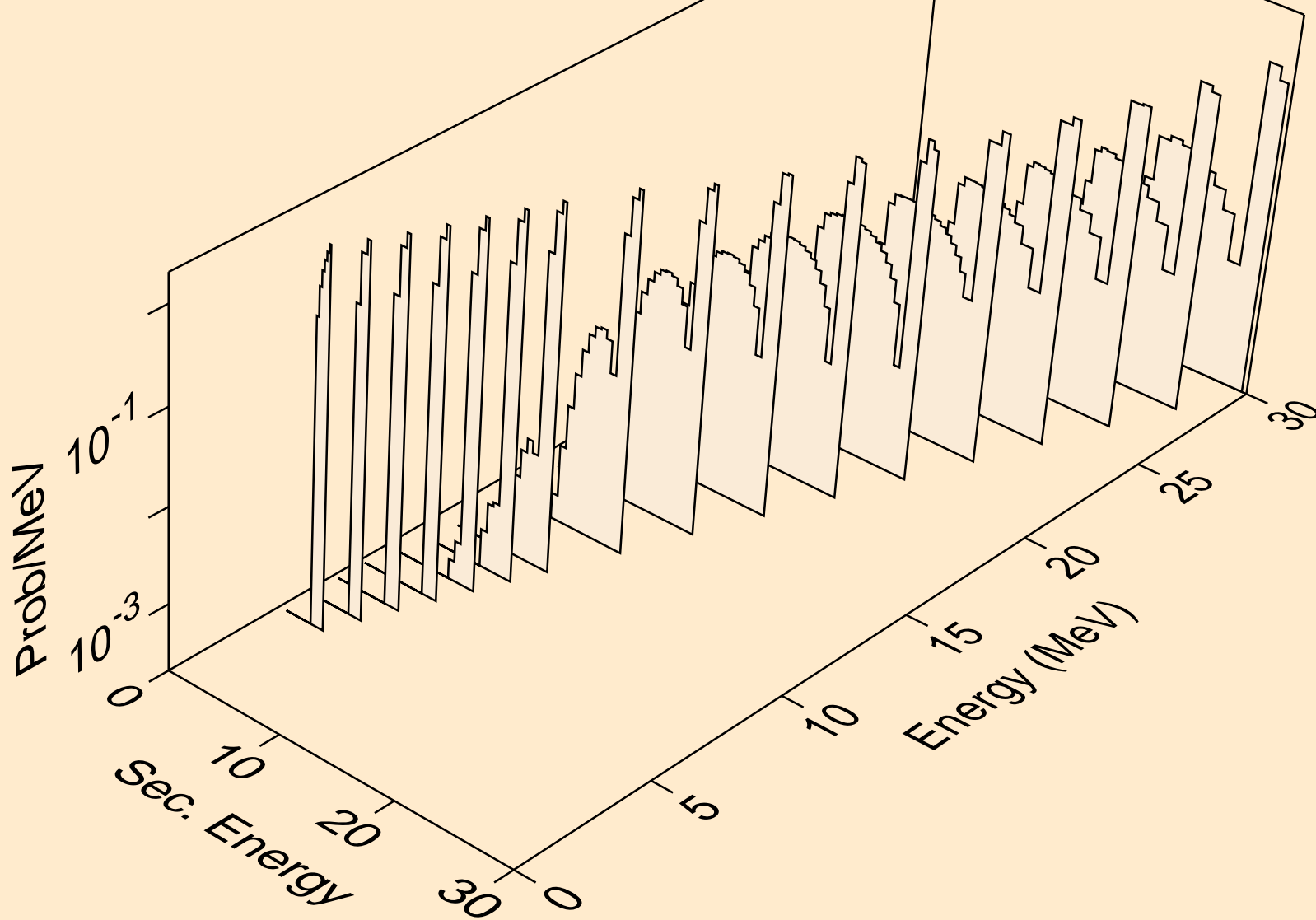

EU153 TRITON ACER TENDL-2023 LIBRARY; T=0.K
Triton emission for (t,pt)

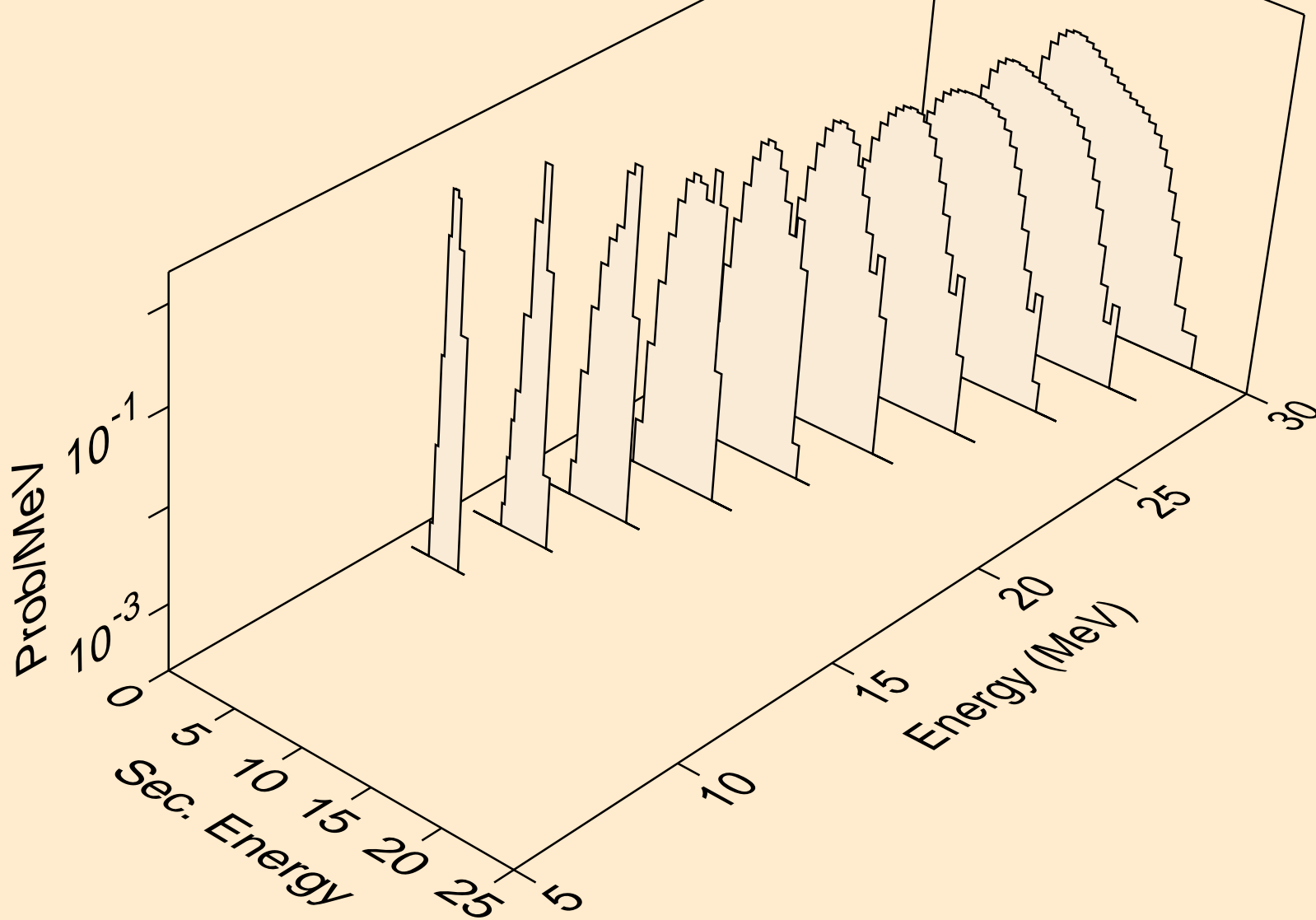

EU153 TRITON ACER TENDL-2023 LIBRARY; T=0.K
Photon emission for (z,n)

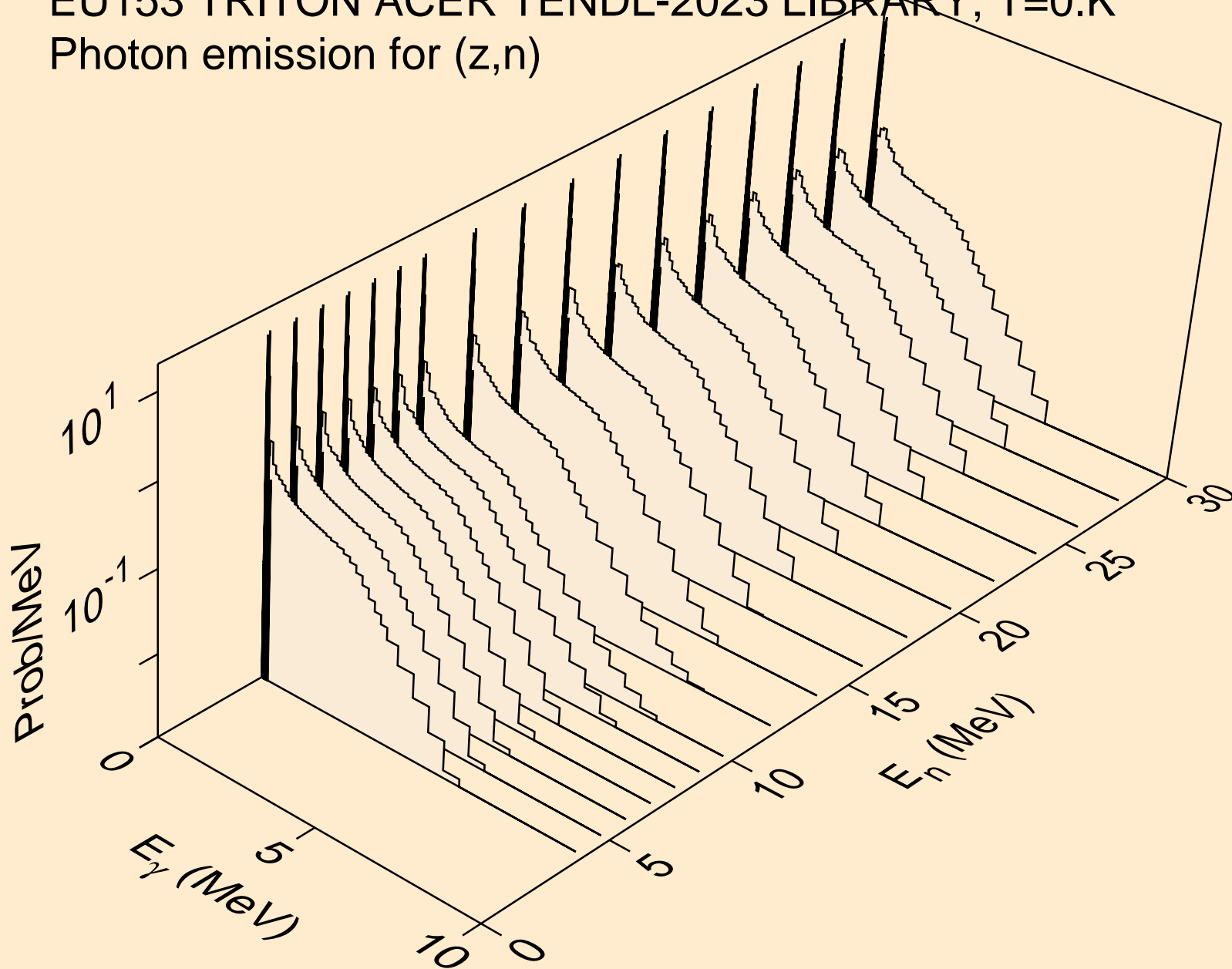

EU153 TRITON ACER TENDL-2023 LIBRARY; T=0.K
Photon emission for (z,x)

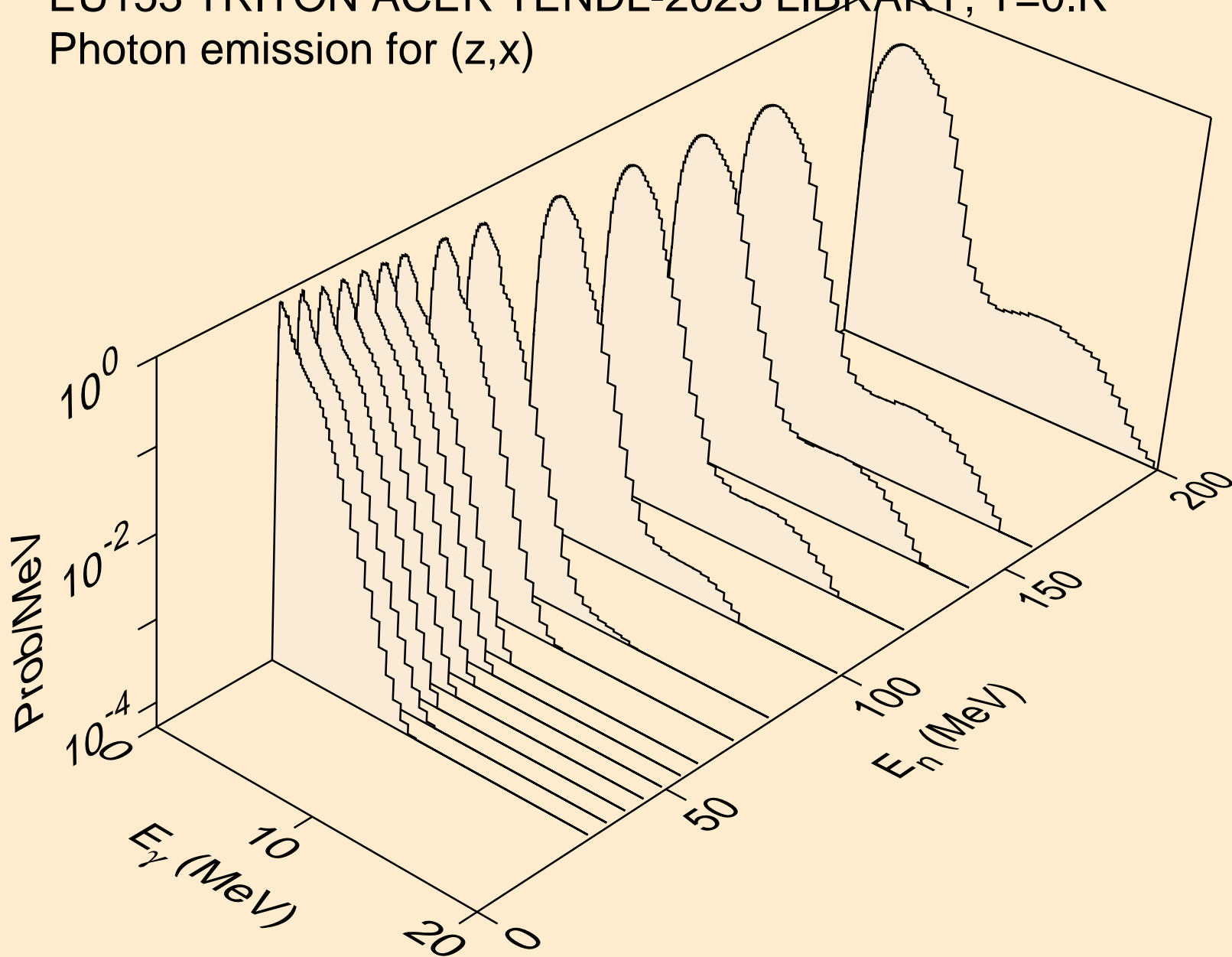

EU153 TRITON ACER TENDL-2023 LIBRARY; T=0.K
Photon emission for (n,2nd)

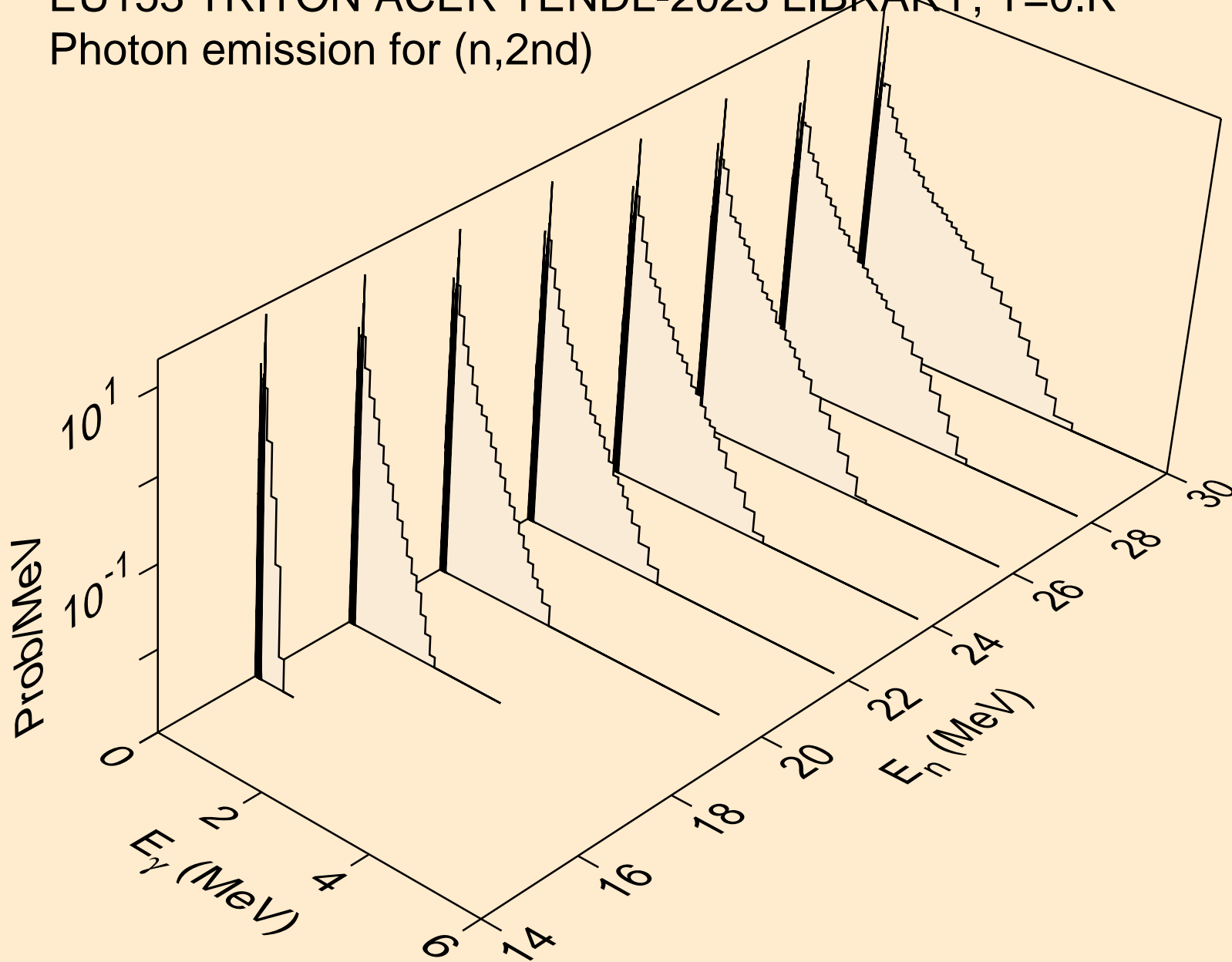

EU153 TRITON ACER TENDL-2023 LIBRARY; T=0.K
Photon emission for (n,2n)

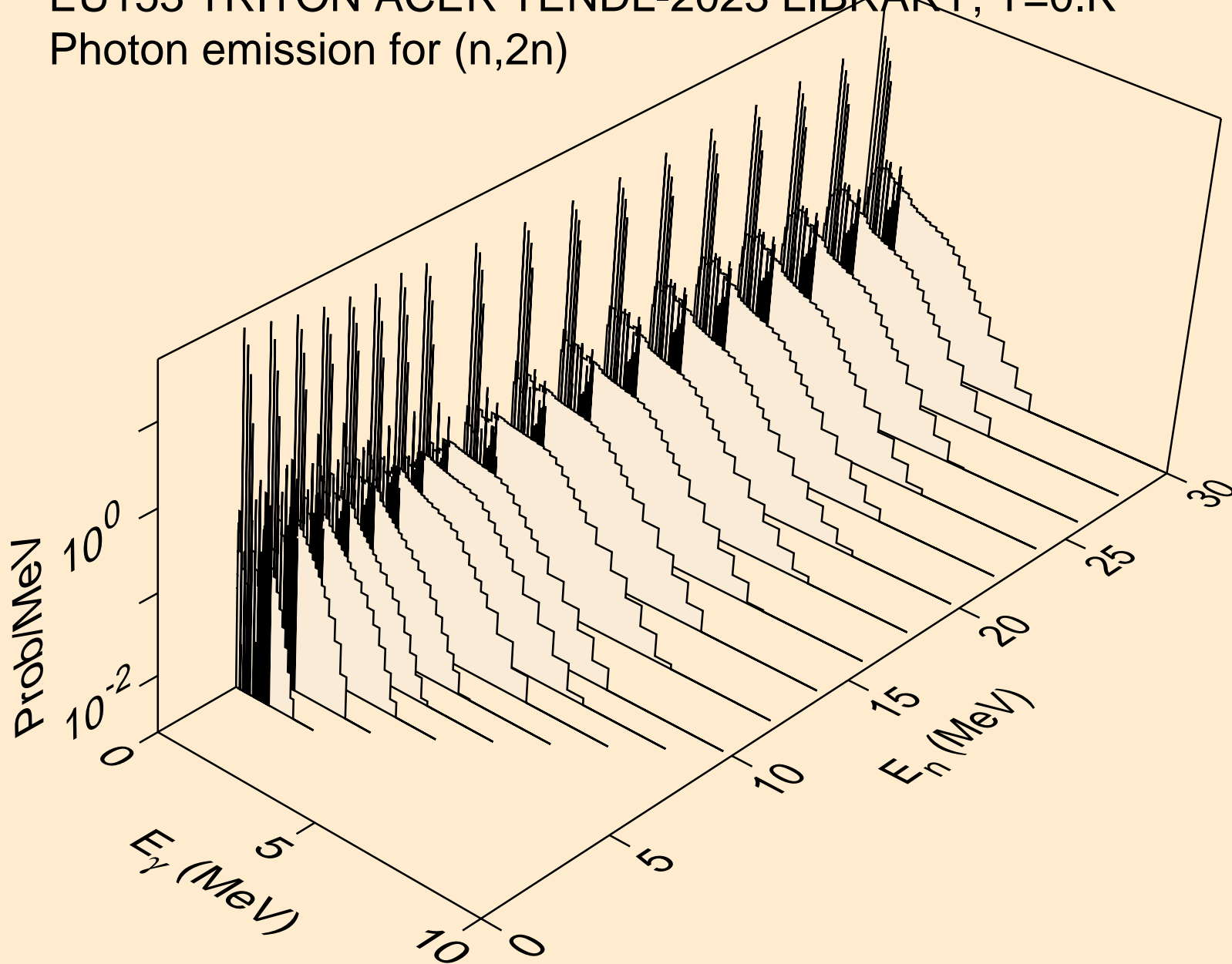

EU153 TRITON ACER TENDL-2023 LIBRARY; T=0.K
Photon emission for (n,3n)

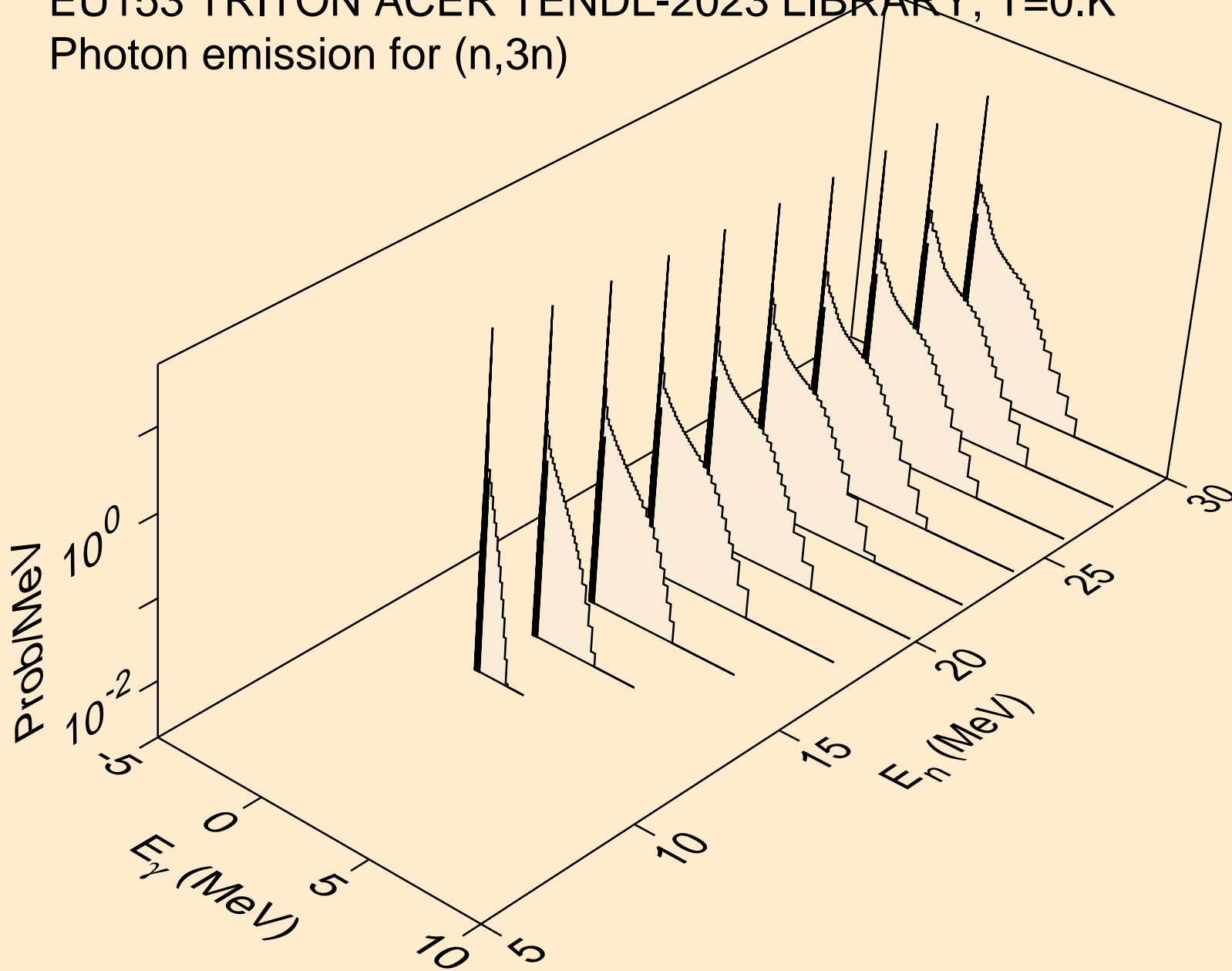

EU153 TRITON ACER TENDL-2023 LIBRARY; T=0.K
Photon emission for (n,n*)a

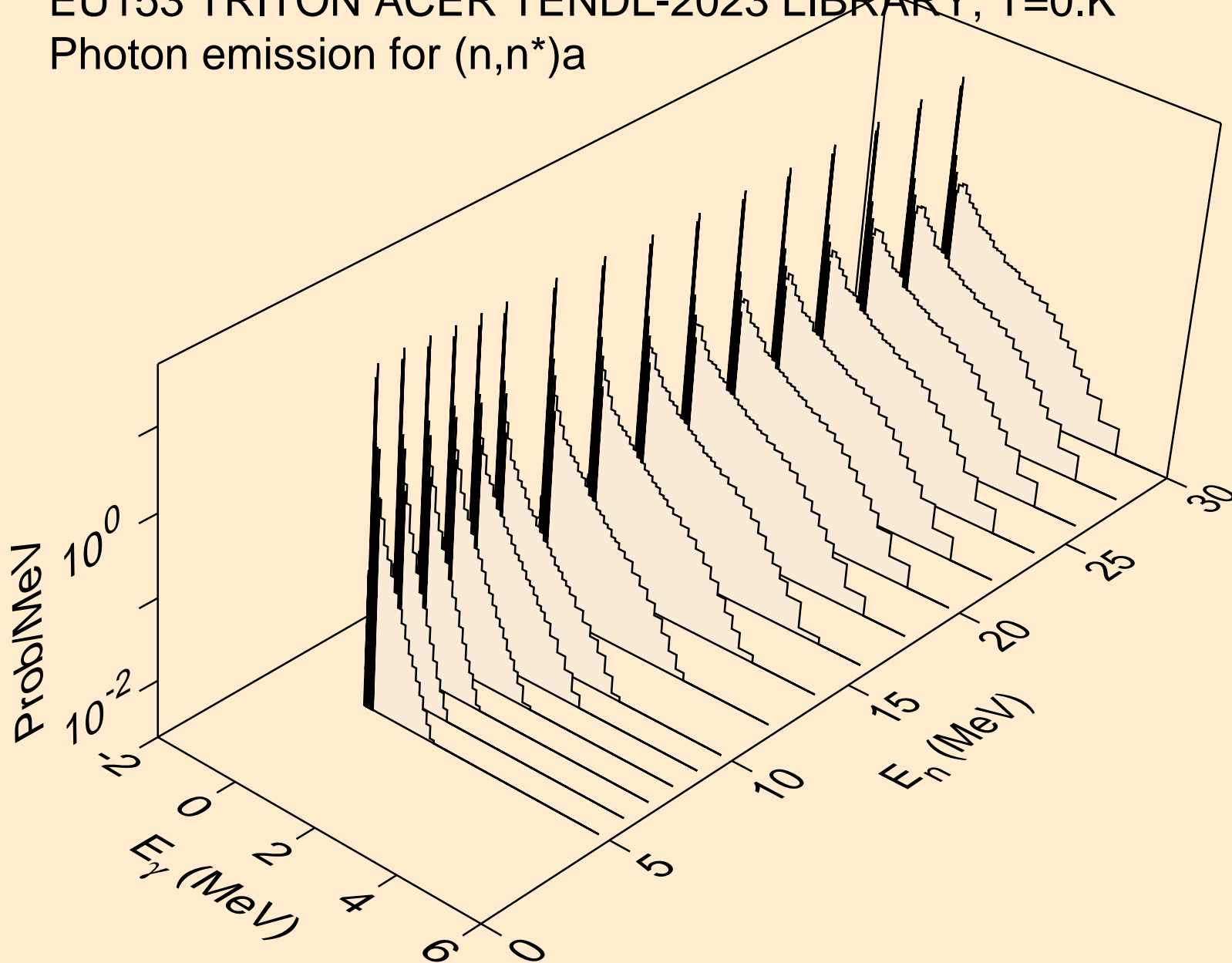

EU153 TRITON ACER TENDL-2023 LIBRARY; T=0.K
Photon emission for (n,2n)a

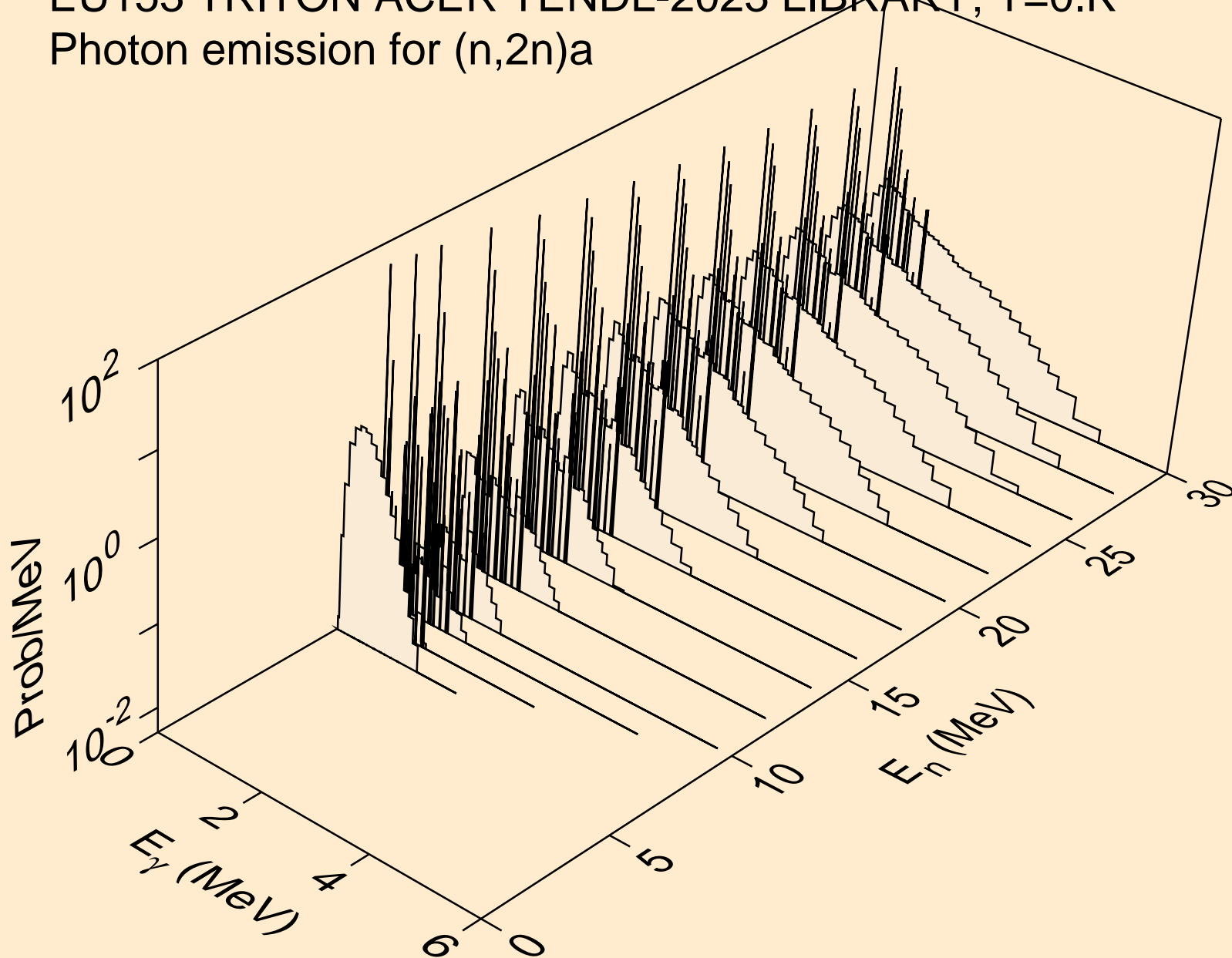

EU153 TRITON ACER TENDL-2023 LIBRARY; T=0.K
Photon emission for (n,3n) α

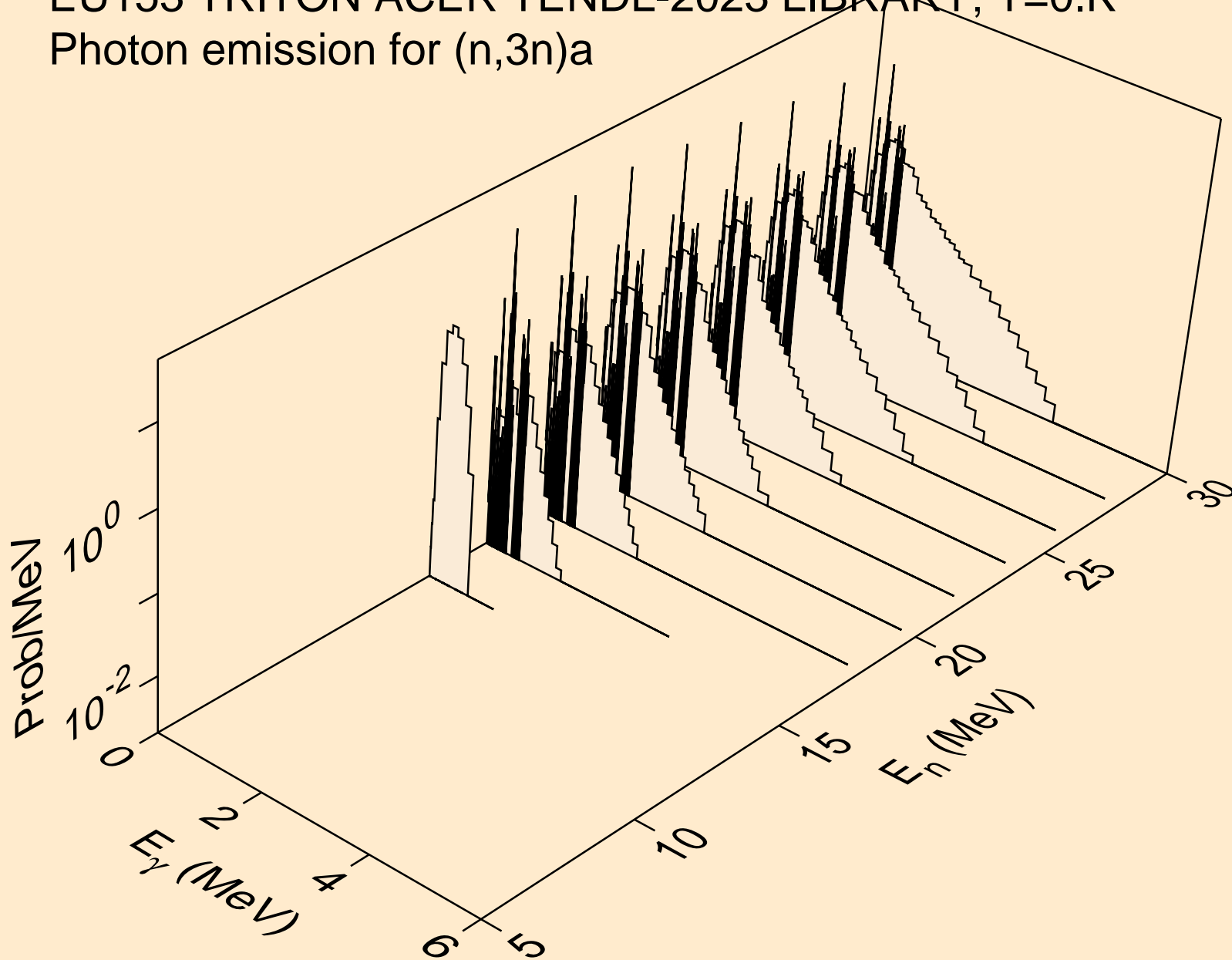

EU153 TRITON ACER TENDL-2023 LIBRARY; T=0.K
Photon emission for (n,n*)p

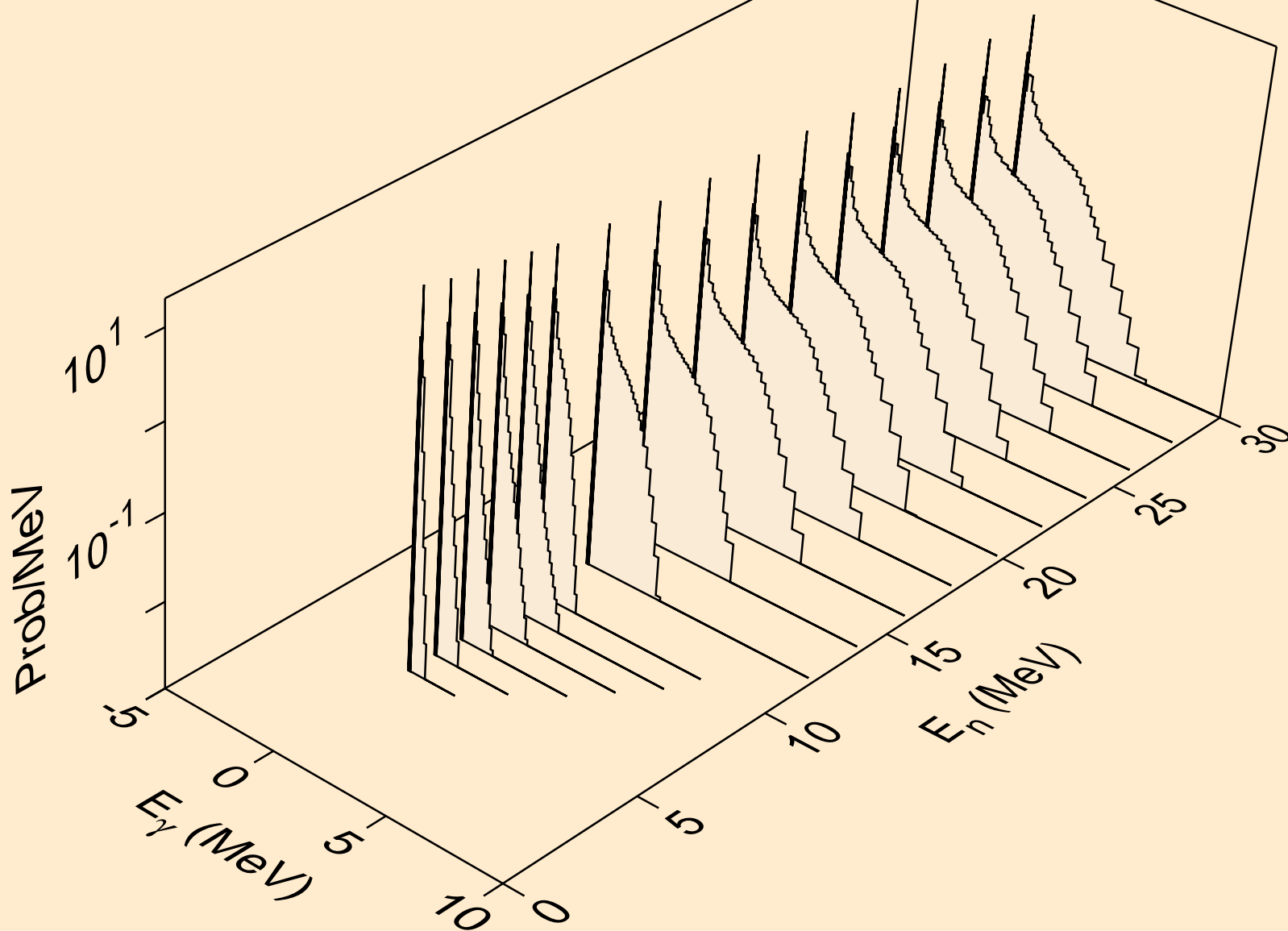

EU153 TRITON ACER TENDL-2023 LIBRARY; T=0.K
Photon emission for (n,n*)2a

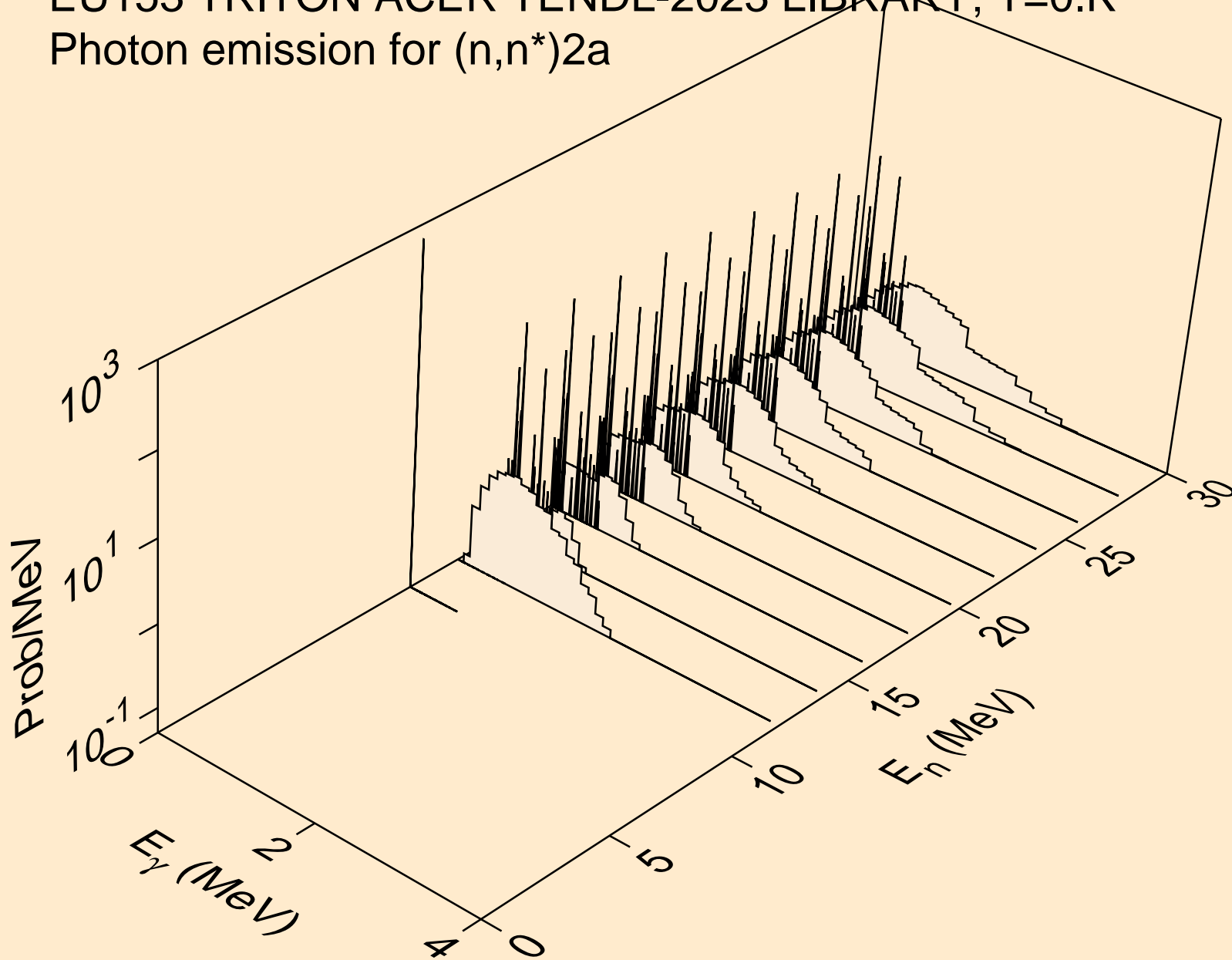

EU153 TRITON ACER TENDL-2023 LIBRARY; T=0.K
Photon emission for (n,2n)2a

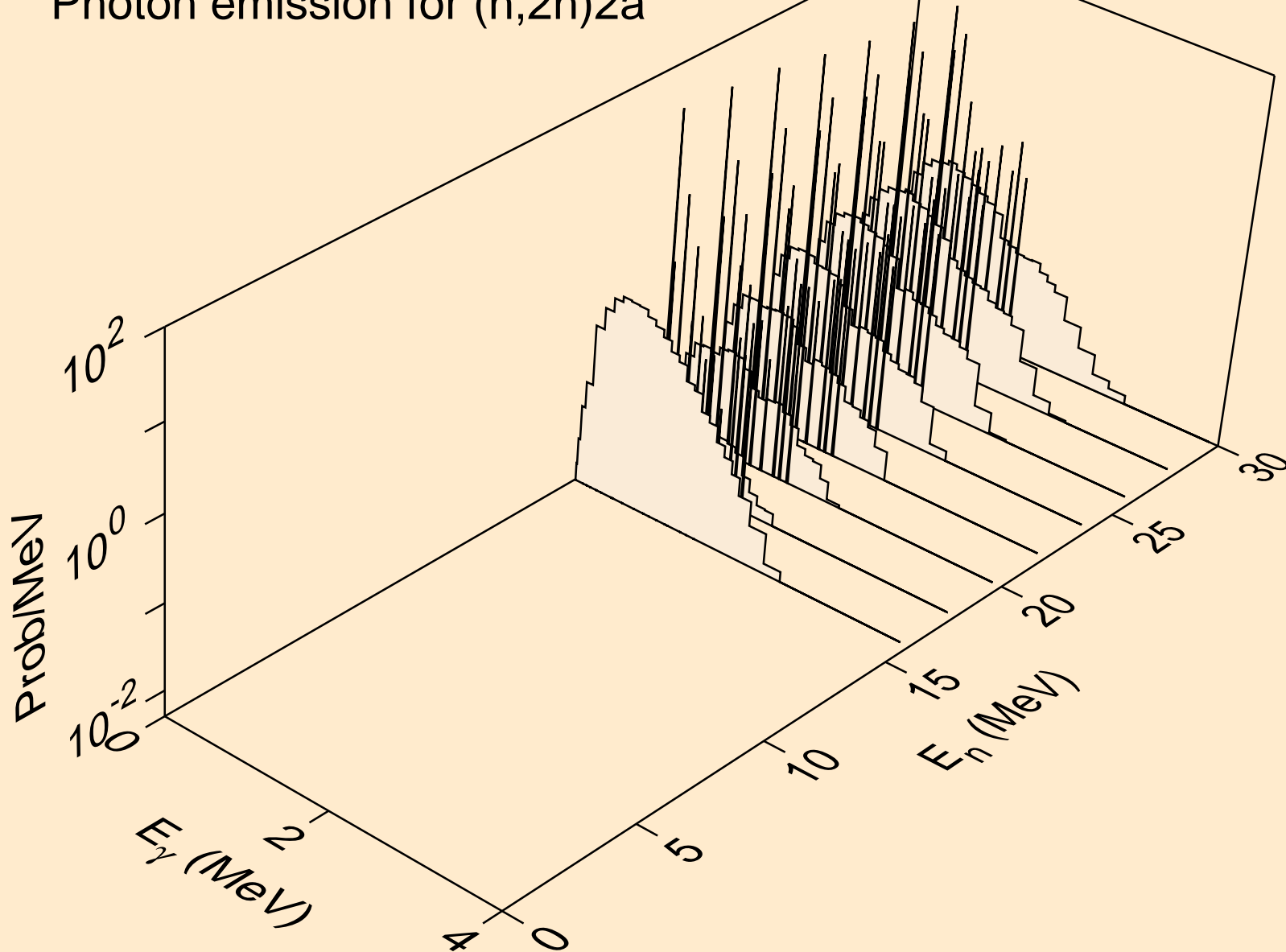

EU153 TRITON ACER TENDL-2023 LIBRARY; T=0.K
Photon emission for (n,n*)d

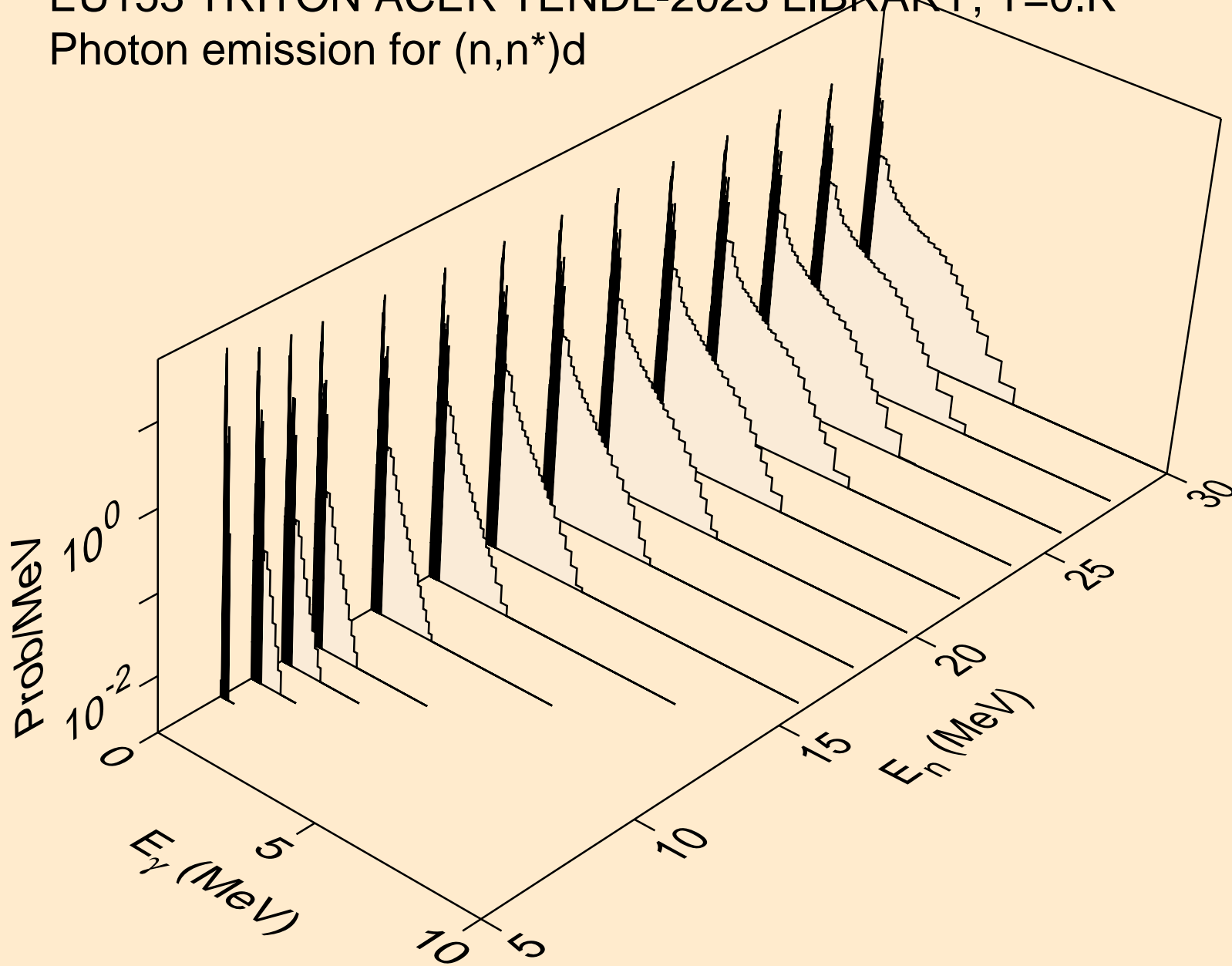

EU153 TRITON ACER TENDL-2023 LIBRARY; T=0.K
Photon emission for (n,n*)t

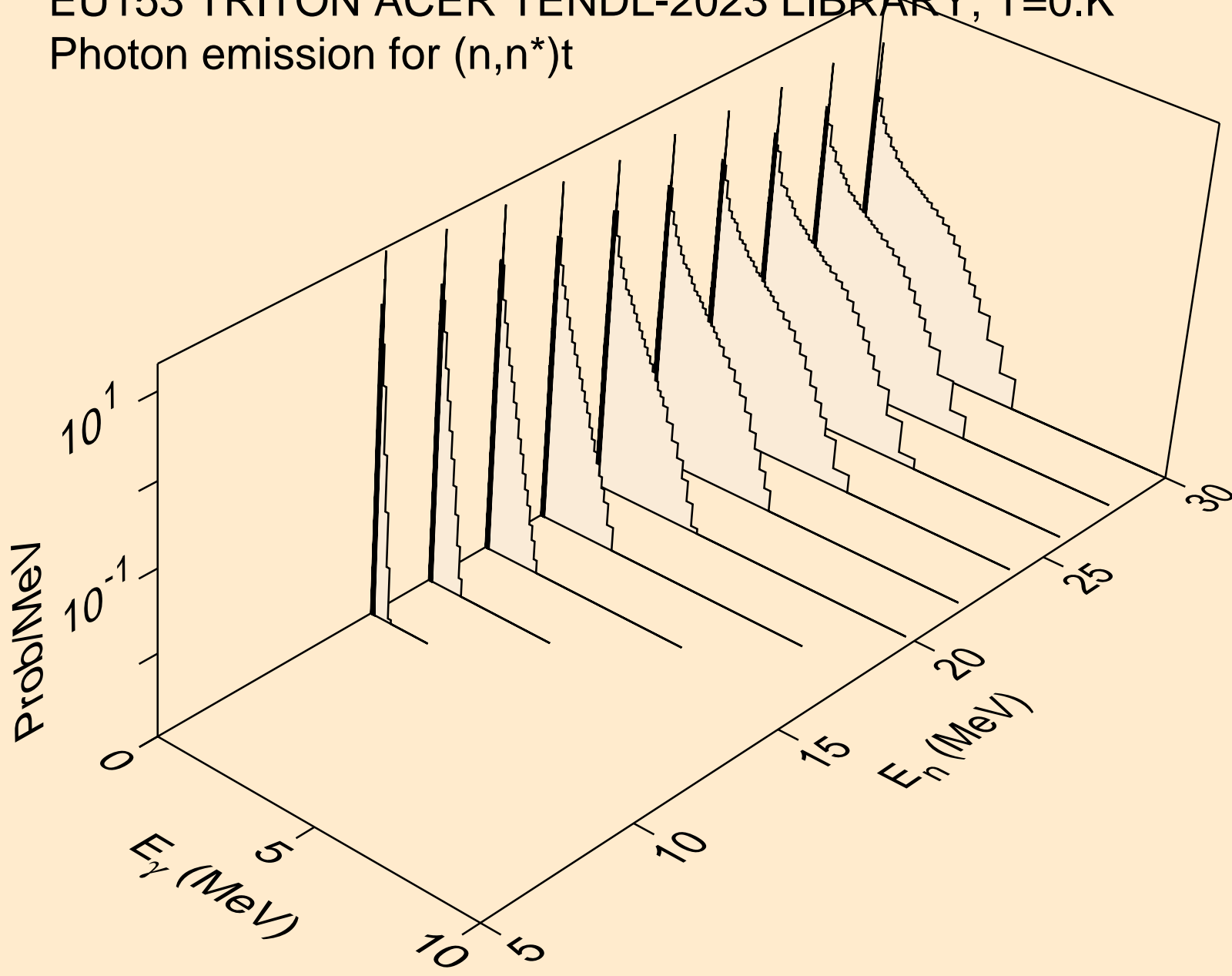

EU153 TRITON ACER TENDL-2023 LIBRARY; T=0.K
Photon emission for (n,n*)he3

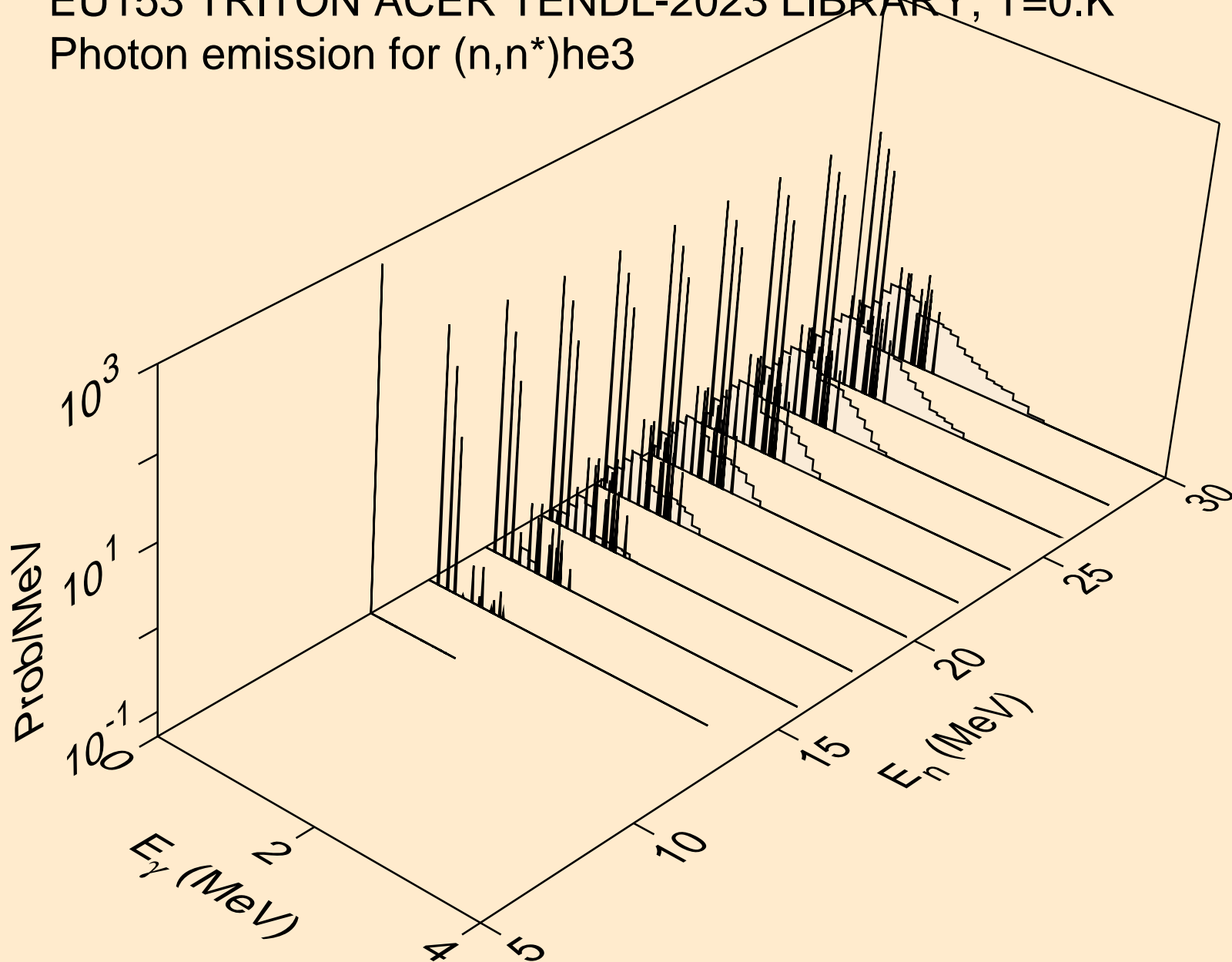

EU153 TRITON ACER TENDL-2023 LIBRARY; T=0.K
Photon emission for (n,4n)

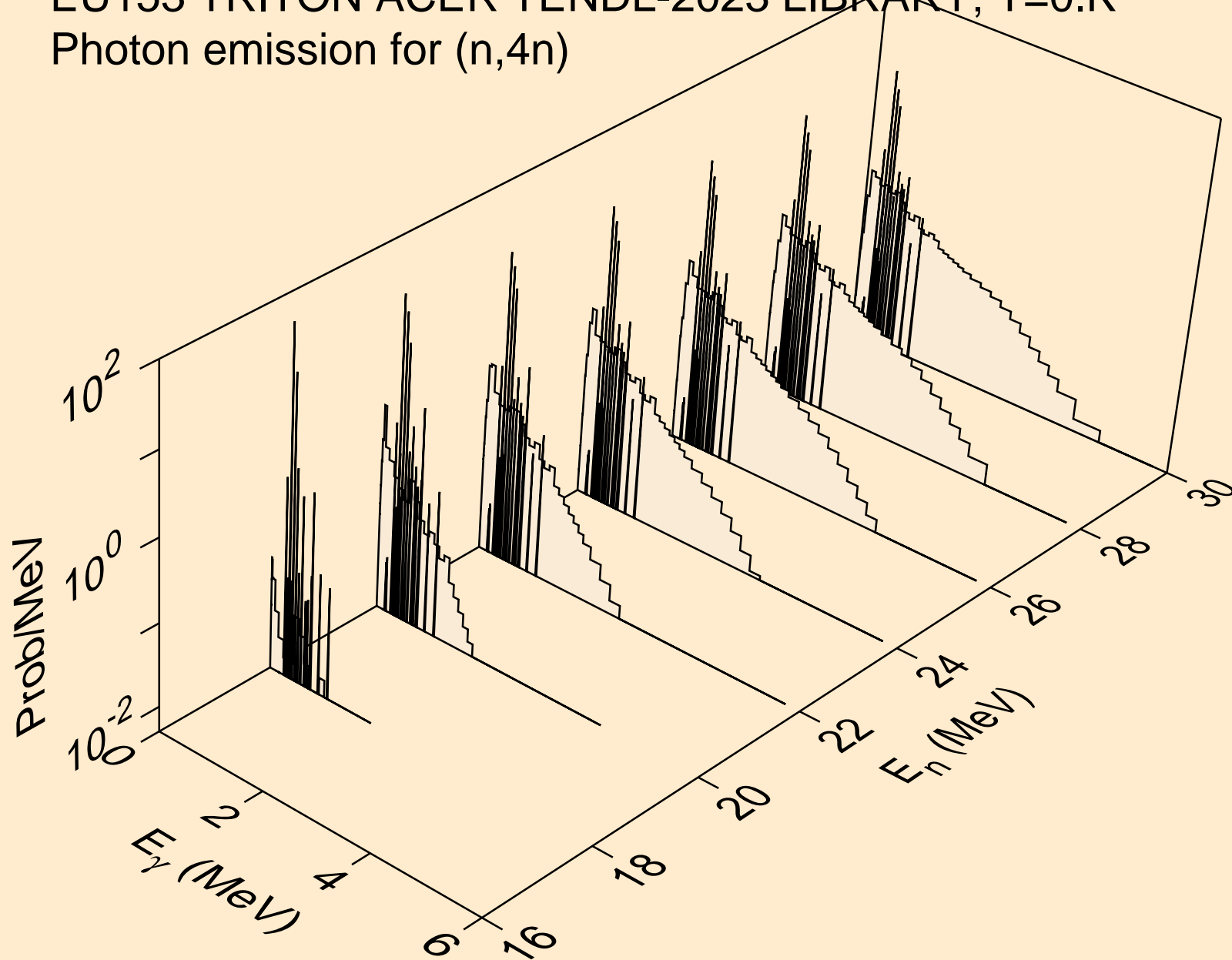

EU153 TRITON ACER TENDL-2023 LIBRARY; T=0.K
Photon emission for (n,2np)

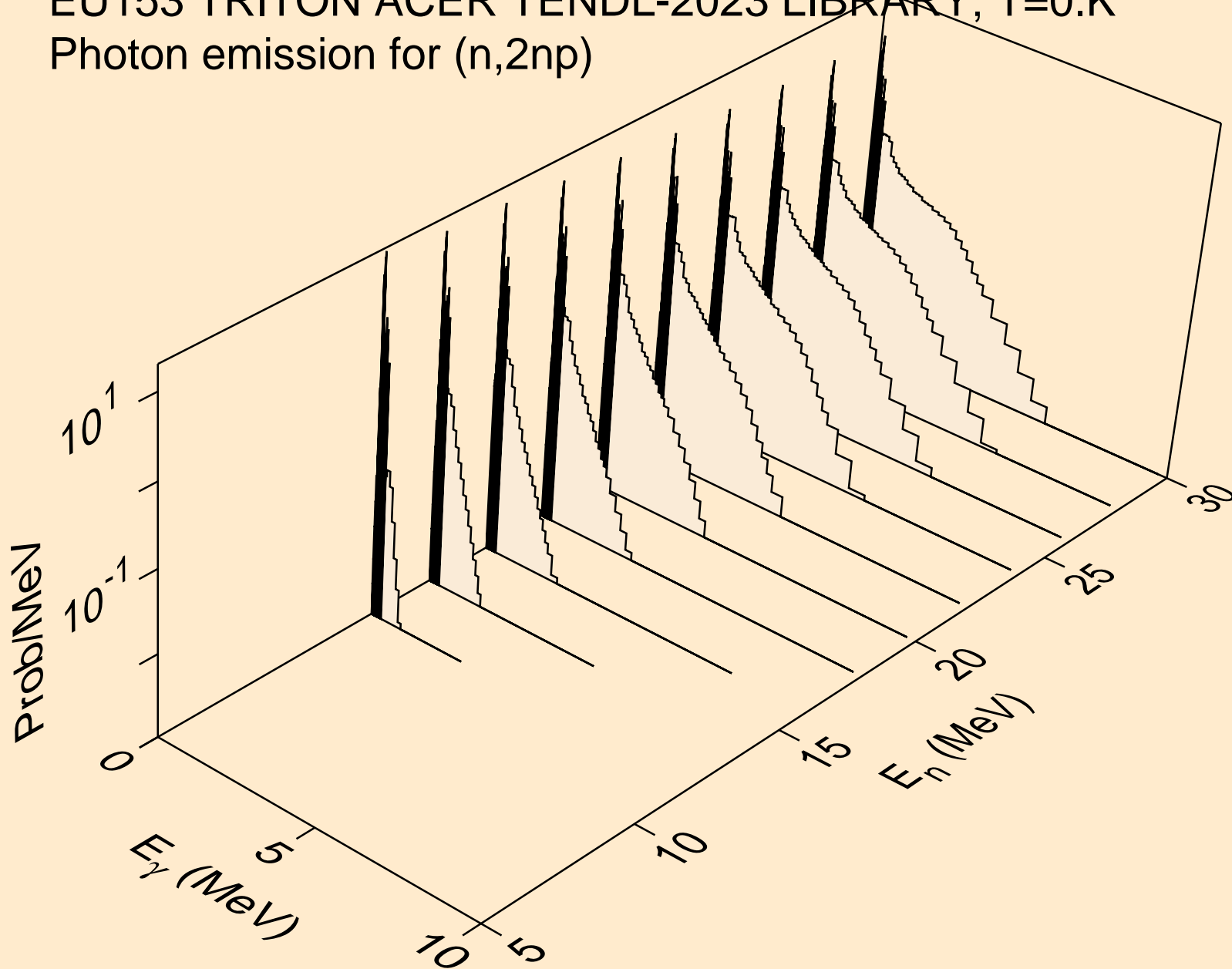

EU153 TRITON ACER TENDL-2023 LIBRARY; T=0.K
Photon emission for (n,3np)

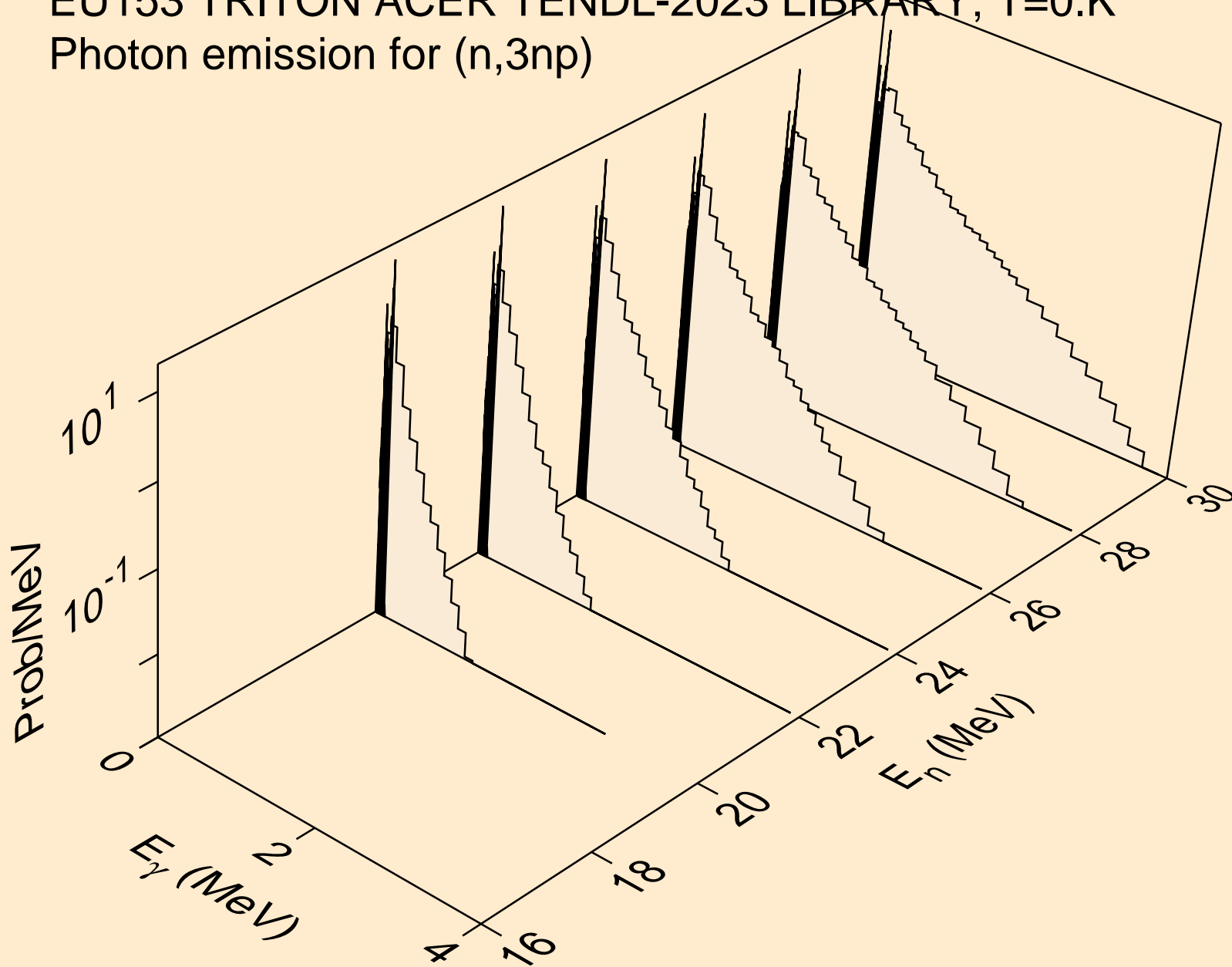

EU153 TRITON ACER TENDL-2023 LIBRARY; T=0.K
Photon emission for (n,n2p)

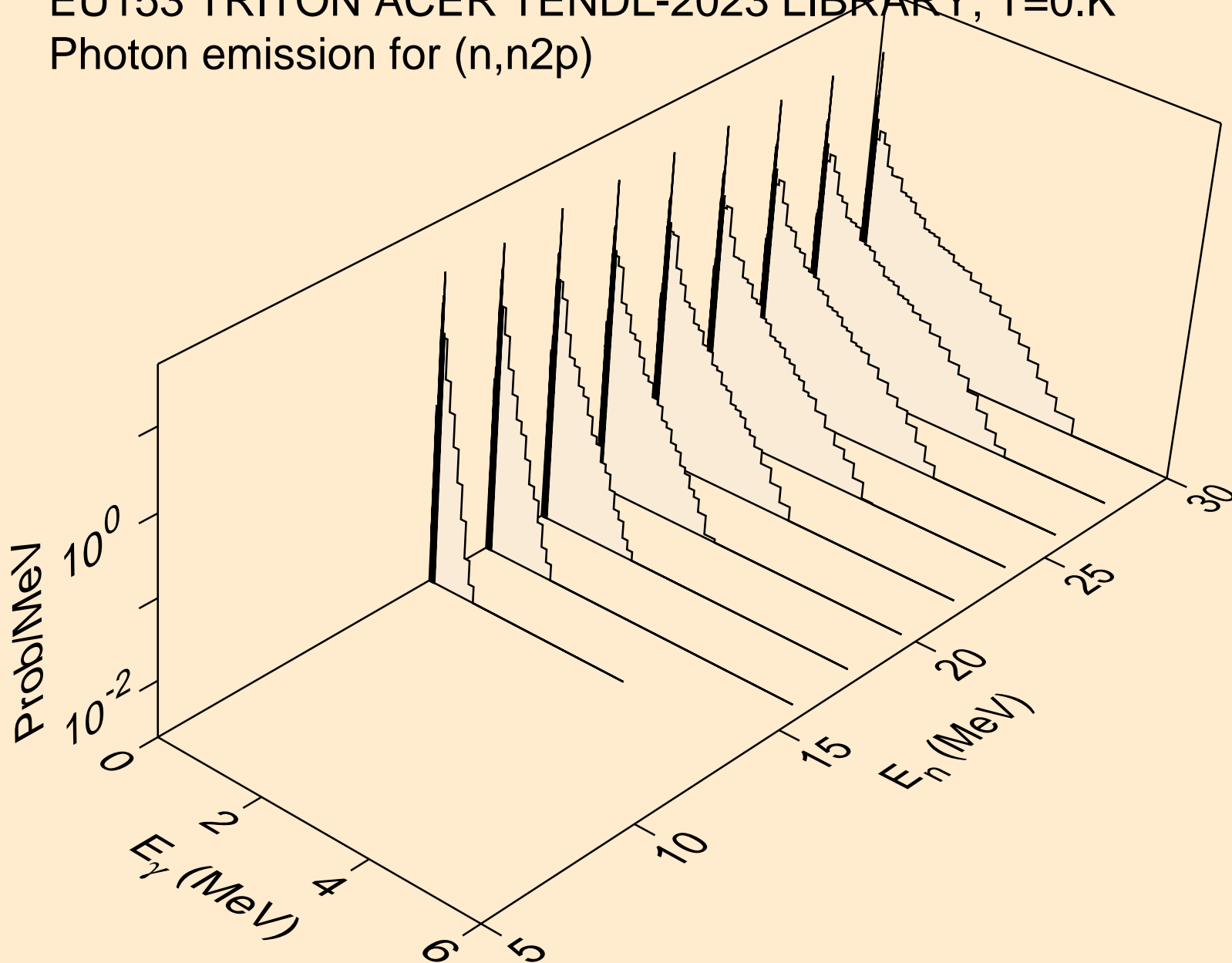

EU153 TRITON ACER TENDL-2023 LIBRARY; T=0.K
Photon emission for (n,npa)

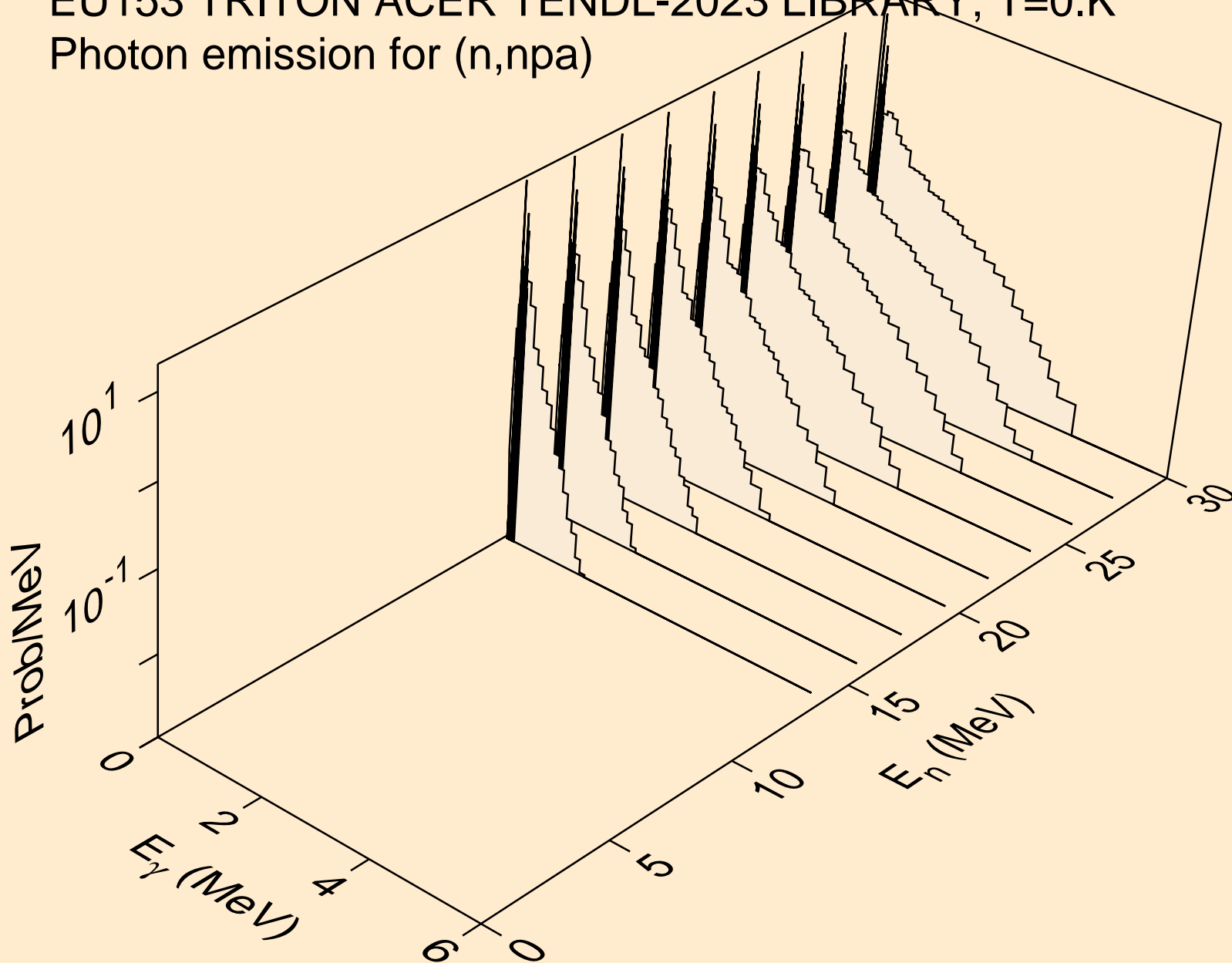

EU153 TRITON ACER TENDL-2023 LIBRARY; T=0.K
Photon emission for (n,gma)

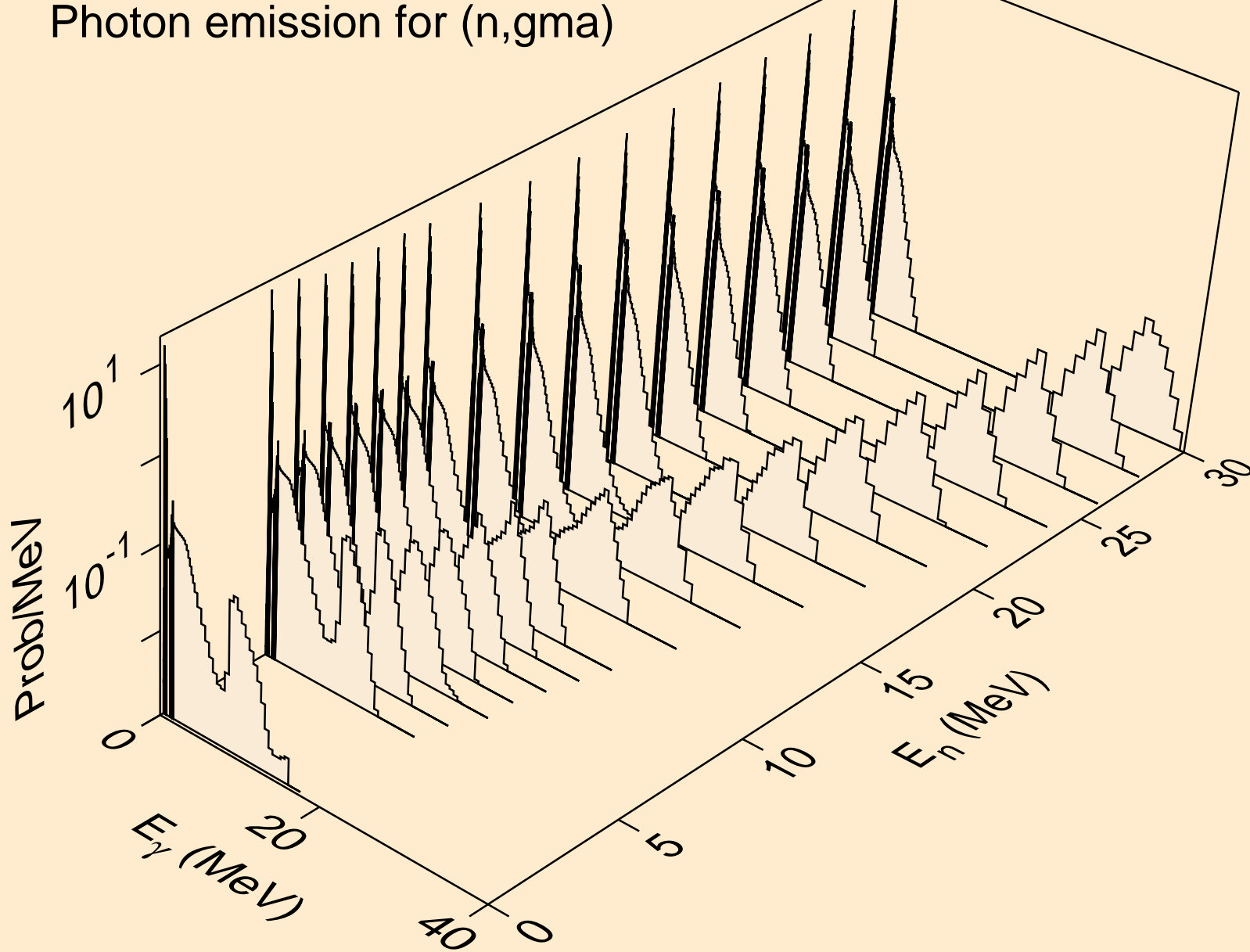

EU153 TRITON ACER TENDL-2023 LIBRARY; T=0.K
Photon emission for (n,p)

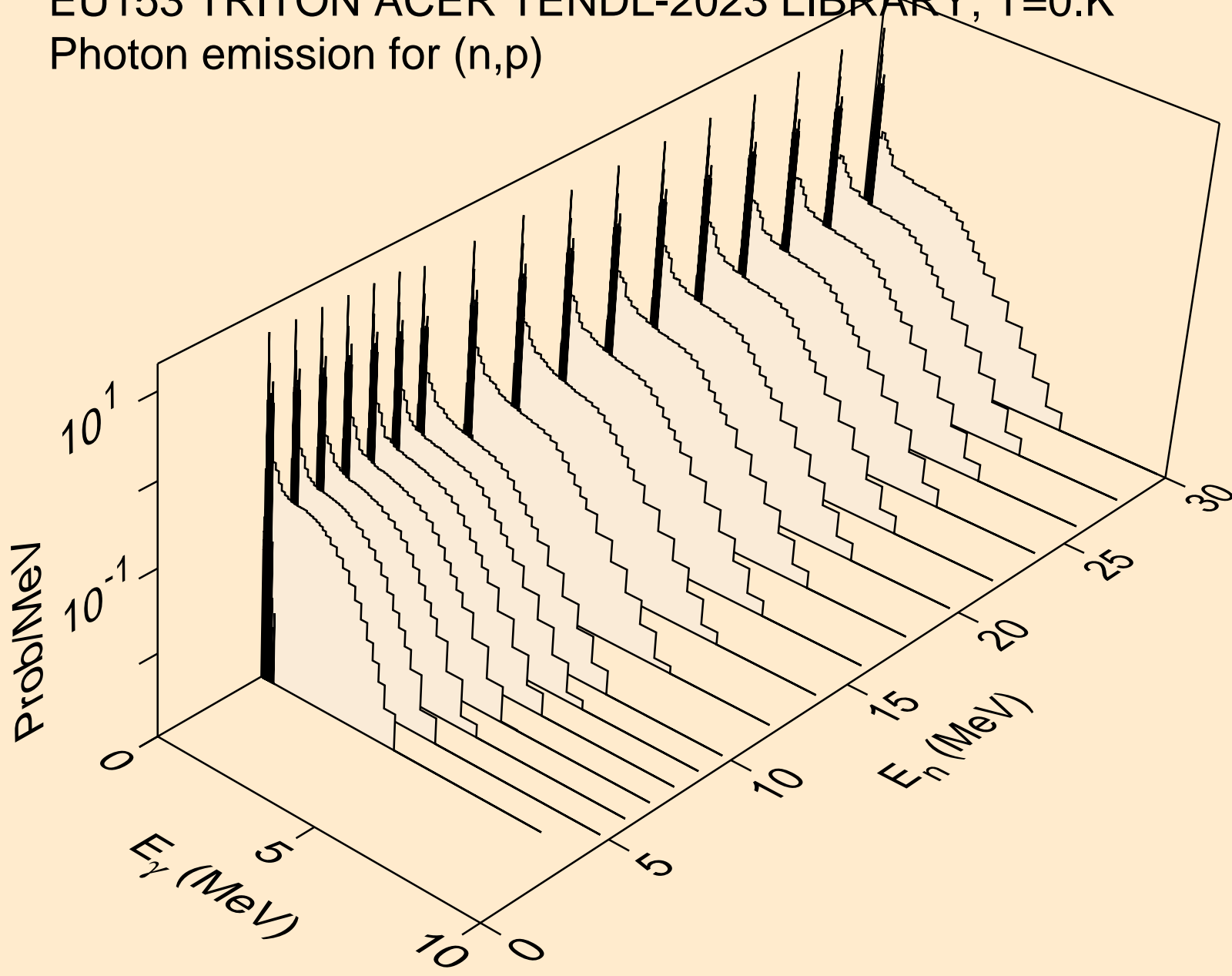

EU153 TRITON ACER TENDL-2023 LIBRARY; T=0.K
Photon emission for (n,d)

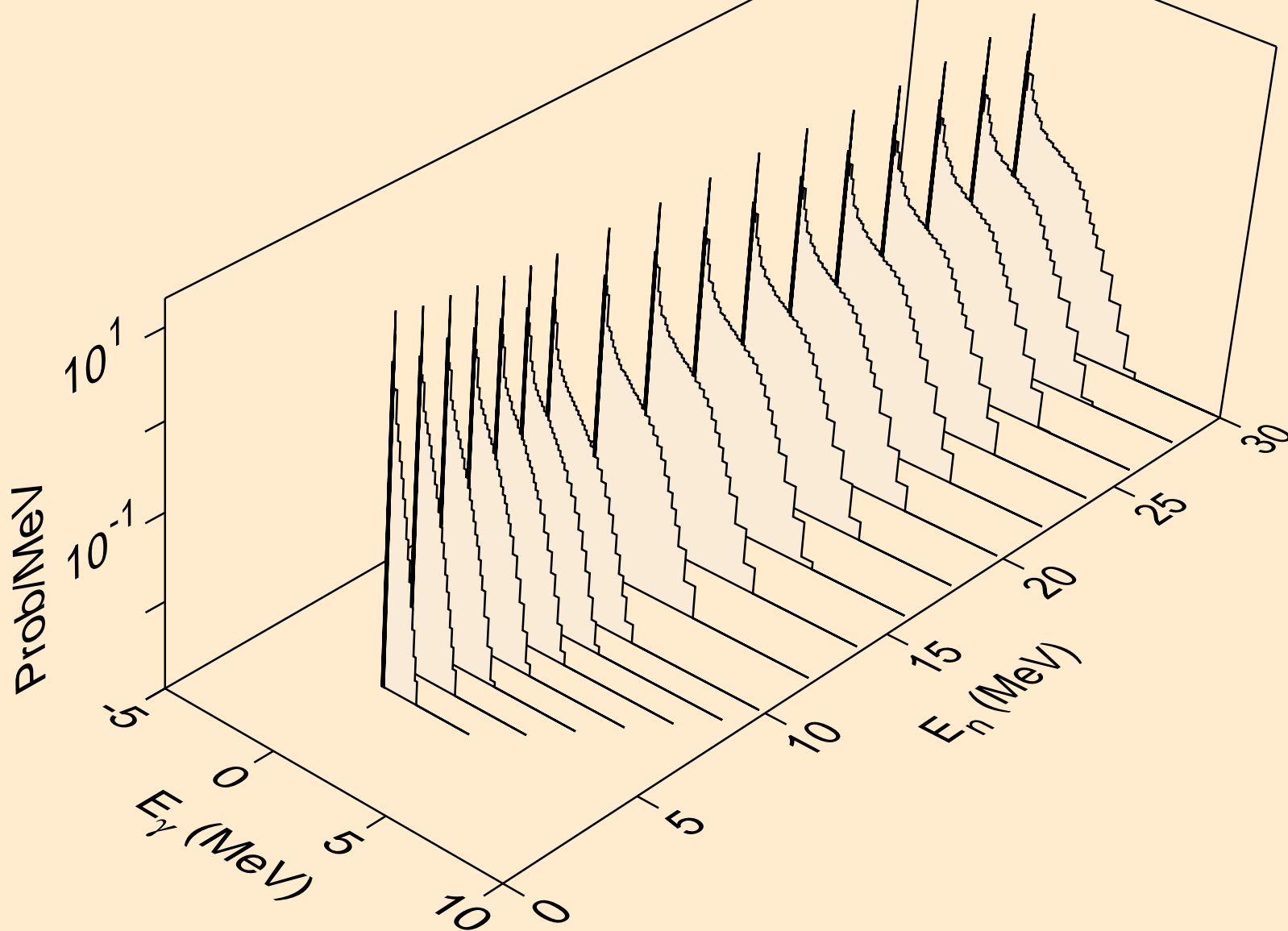

EU153 TRITON ACER TENDL-2023 LIBRARY; T=0.K
Photon emission for inelastic

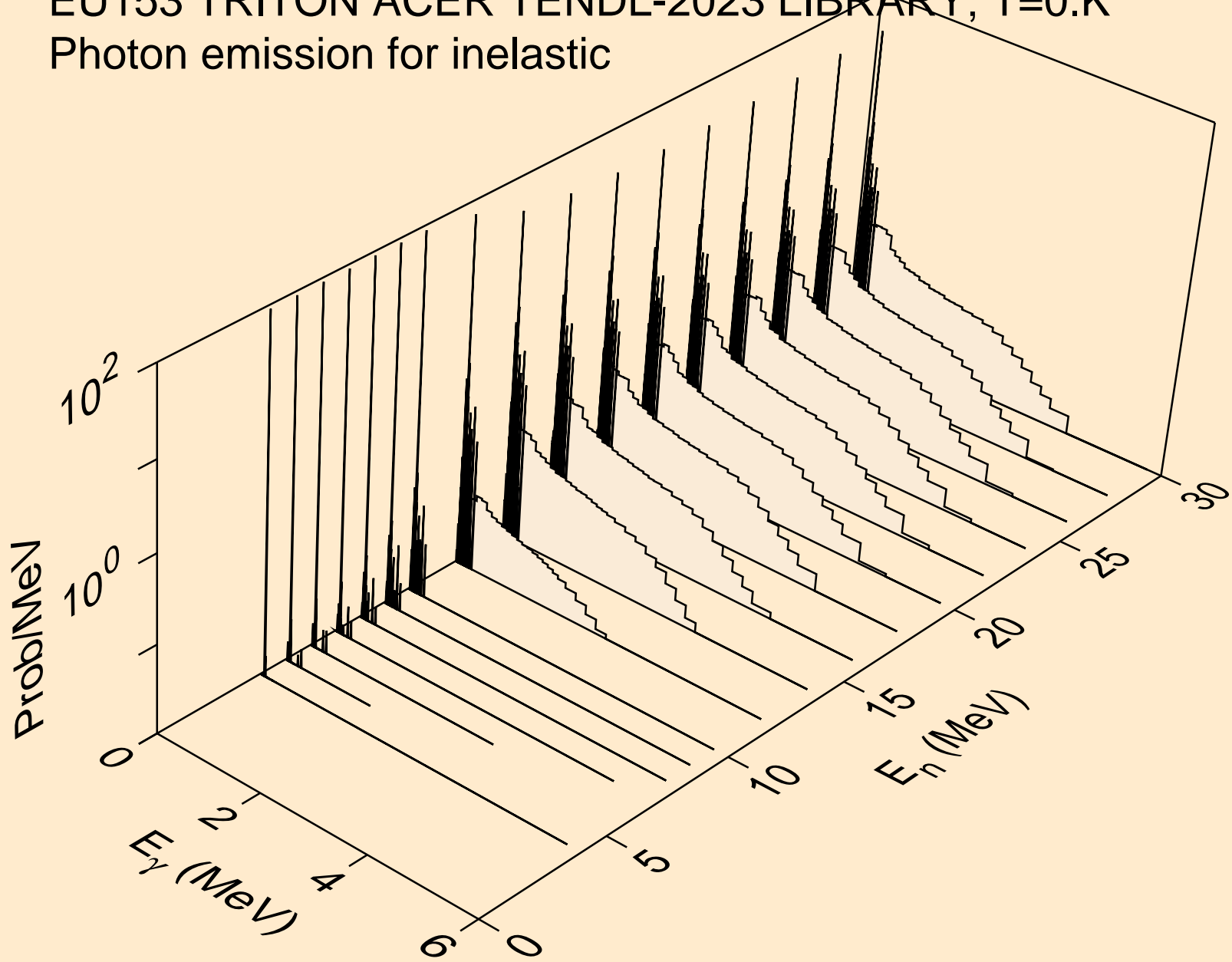

EU153 TRITON ACER TENDL-2023 LIBRARY; T=0.K
Photon emission for (n,he3)

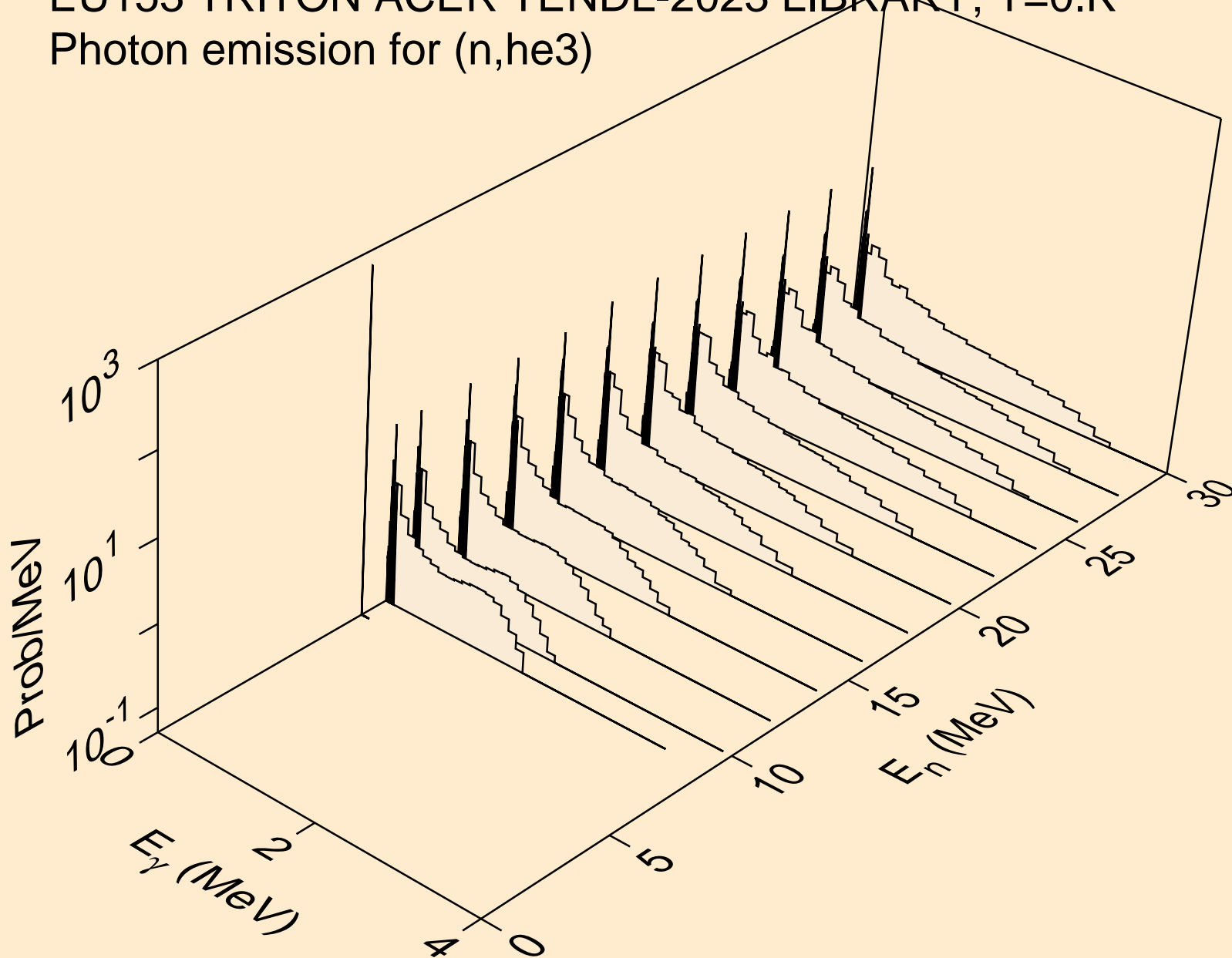

EU153 TRITON ACER TENDL-2023 LIBRARY; T=0.K
Photon emission for (n,a)

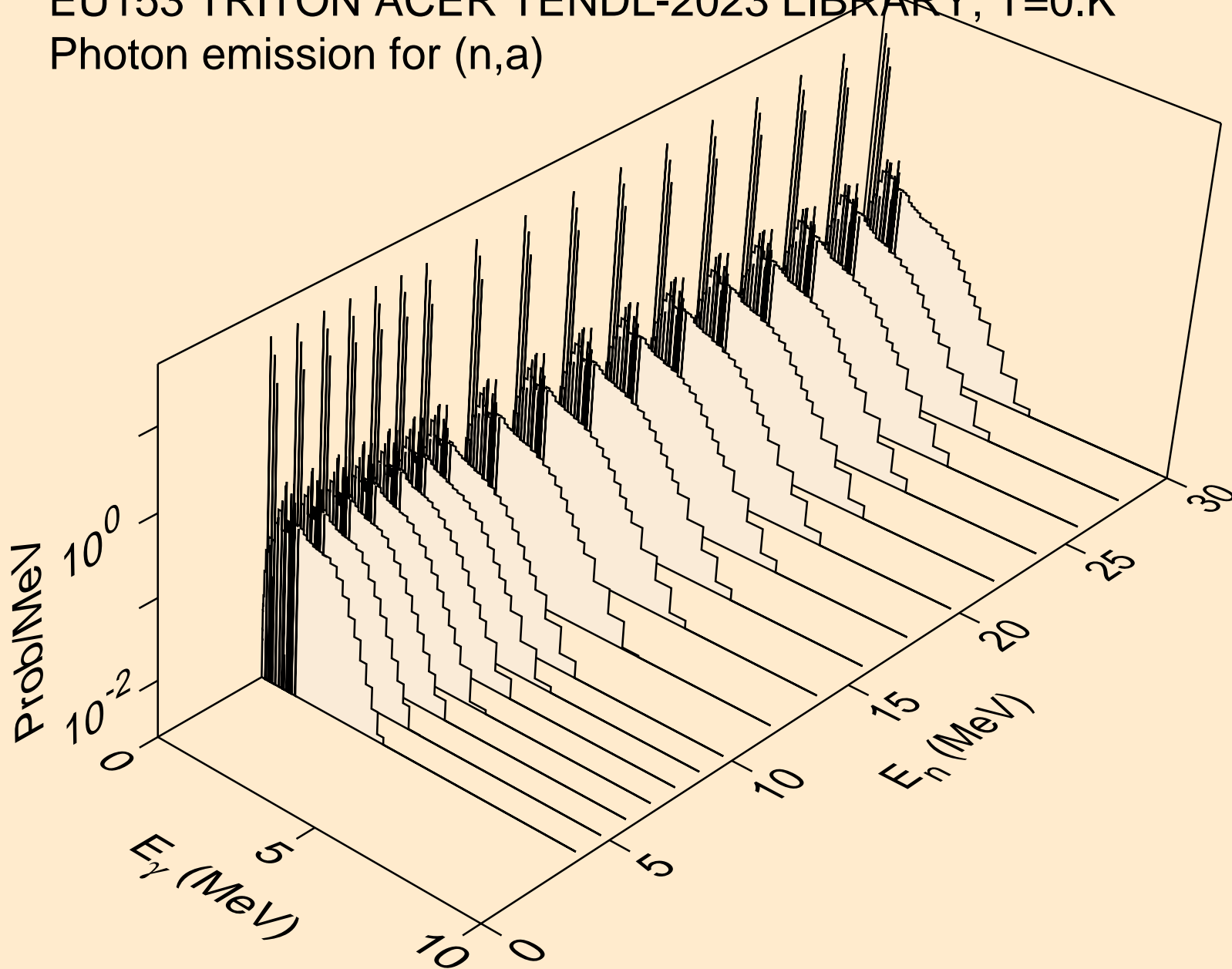

EU153 TRITON ACER TENDL-2023 LIBRARY; T=0.K
Photon emission for (n,2a)

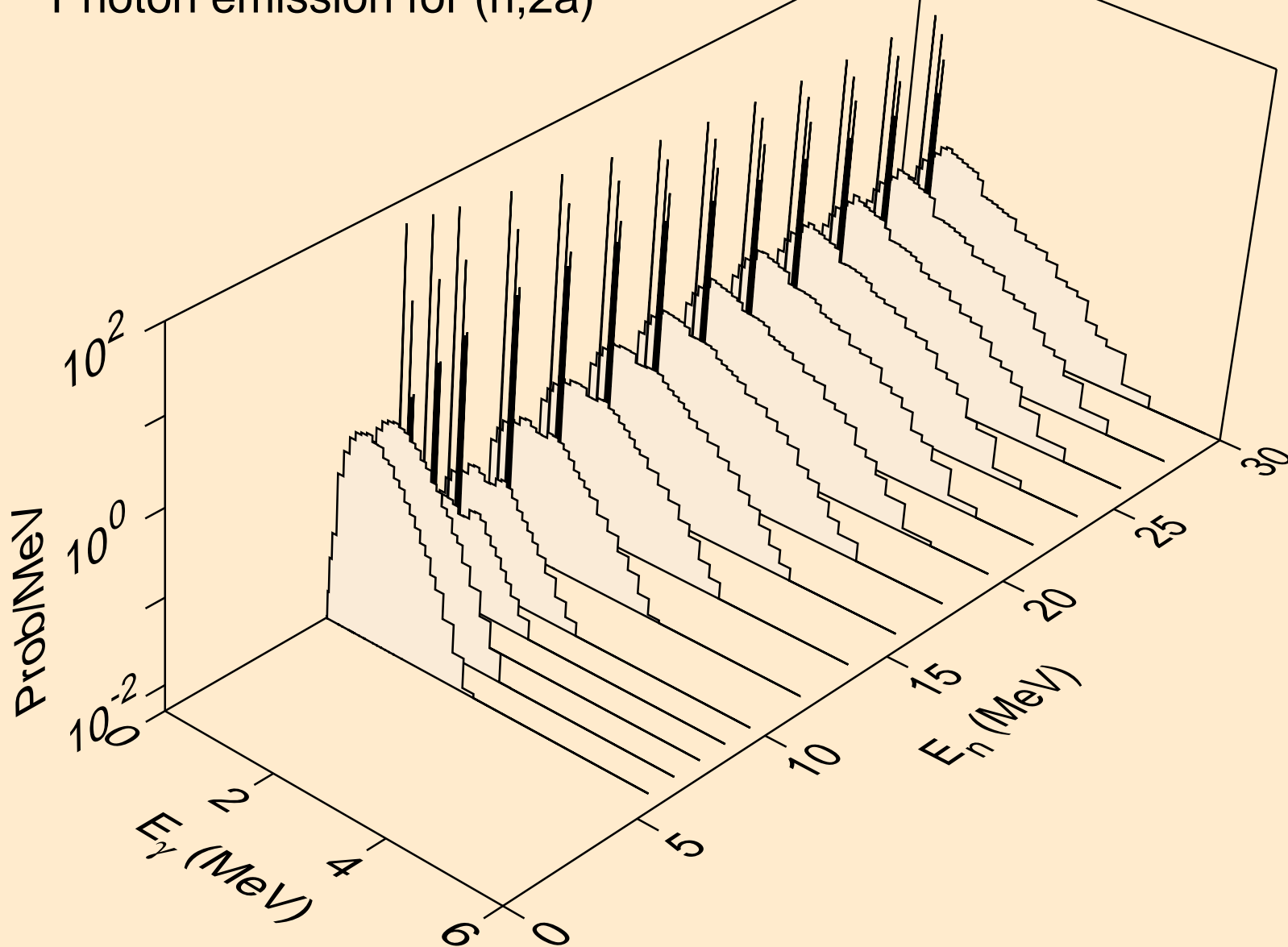

EU153 TRITON ACER TENDL-2023 LIBRARY; T=0.K
Photon emission for (n,2p)

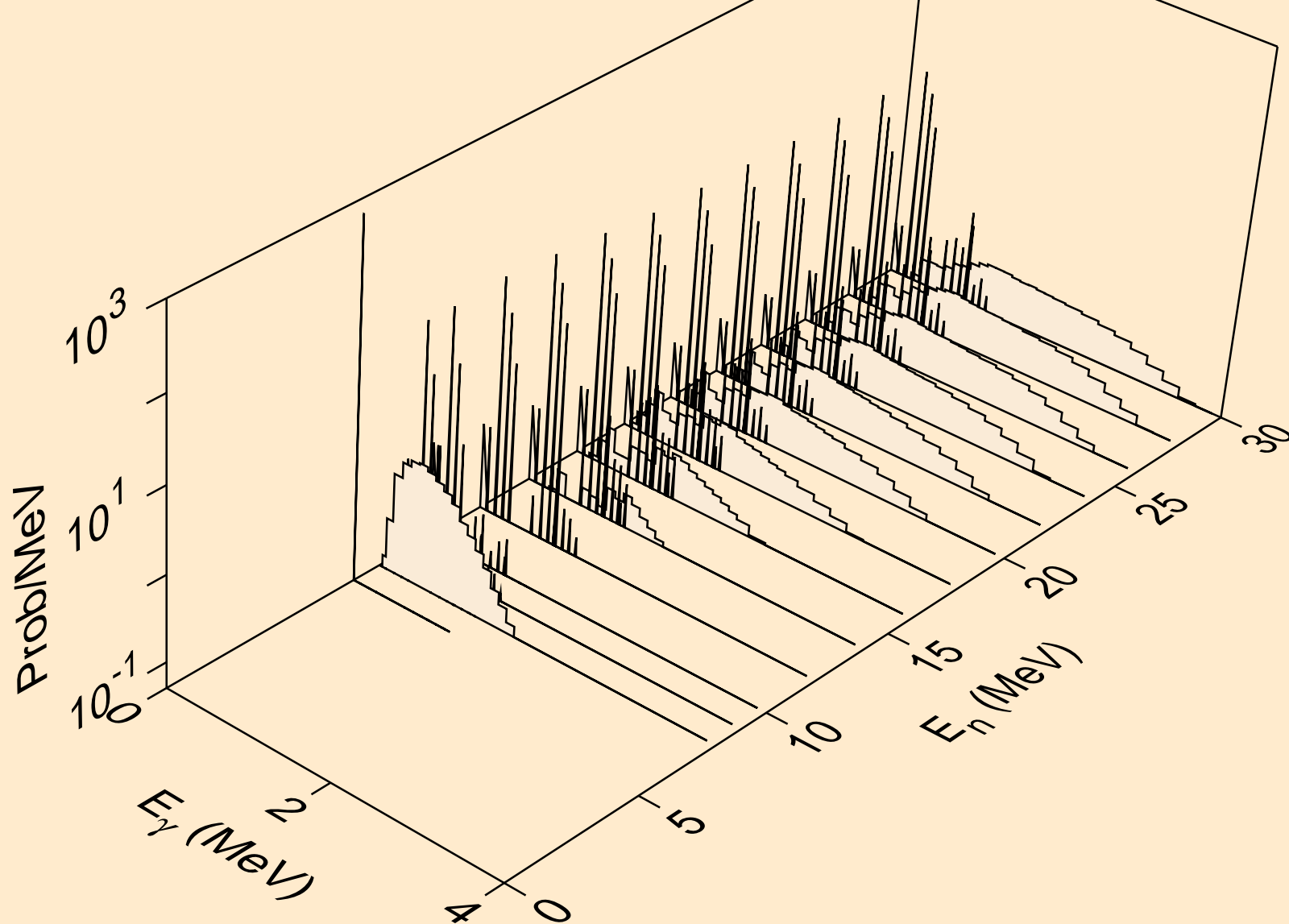

EU153 TRITON ACER TENDL-2023 LIBRARY; T=0.K
Photon emission for (n,pa)

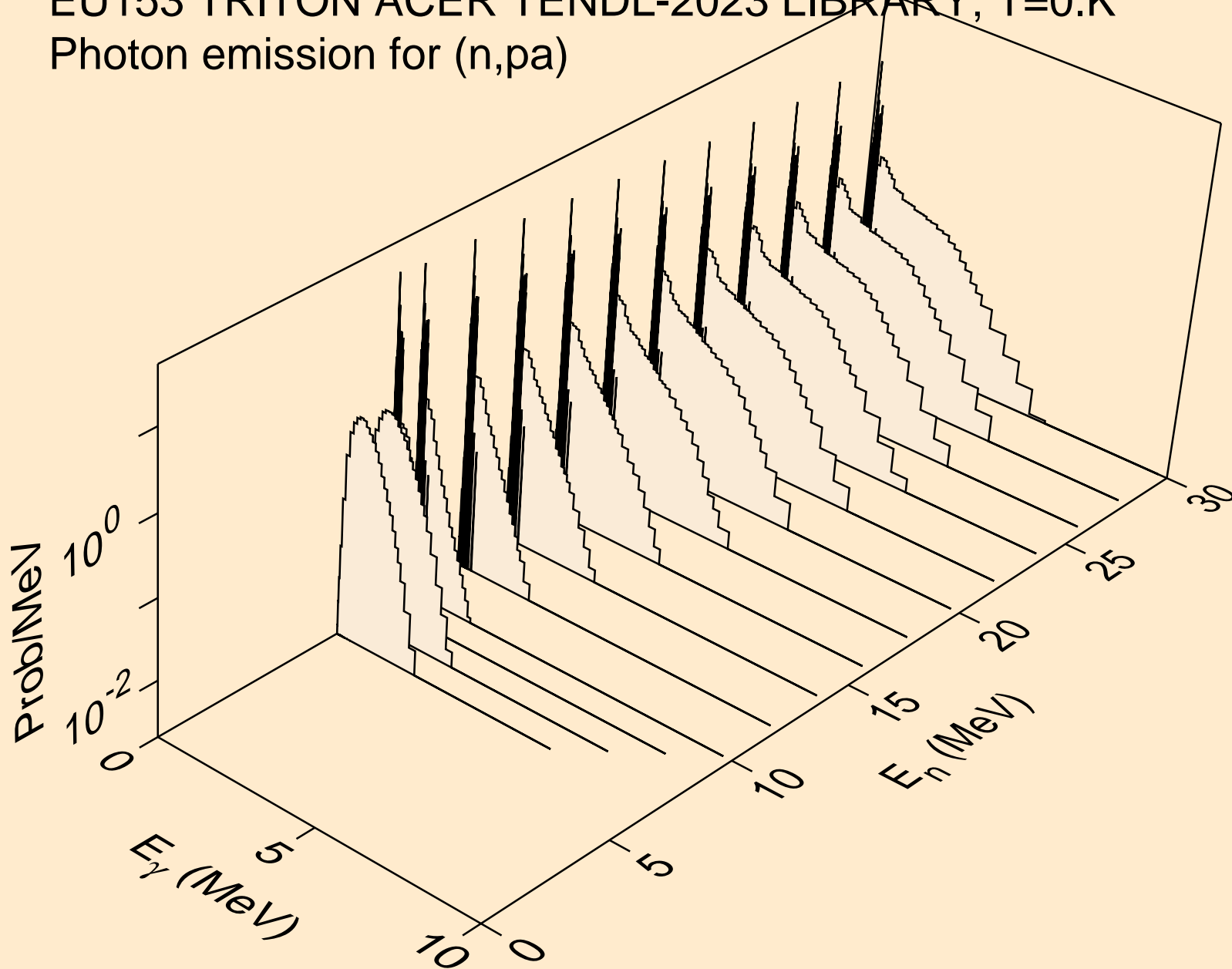

EU153 TRITON ACER TENDL-2023 LIBRARY; T=0.K
Photon emission for (n,pd)

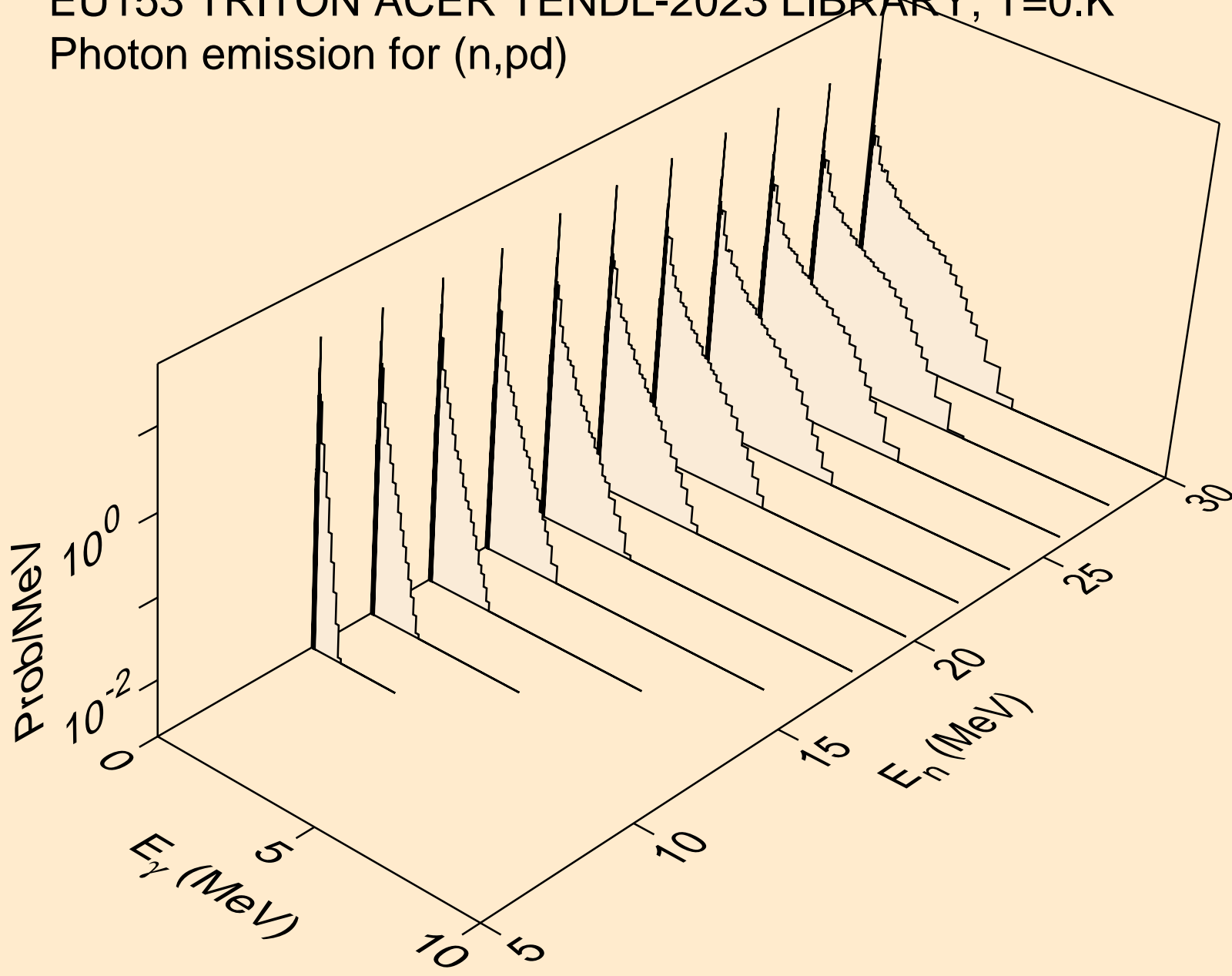

EU153 TRITON ACER TENDL-2023 LIBRARY; T=0.K
Photon emission for (n,pt)

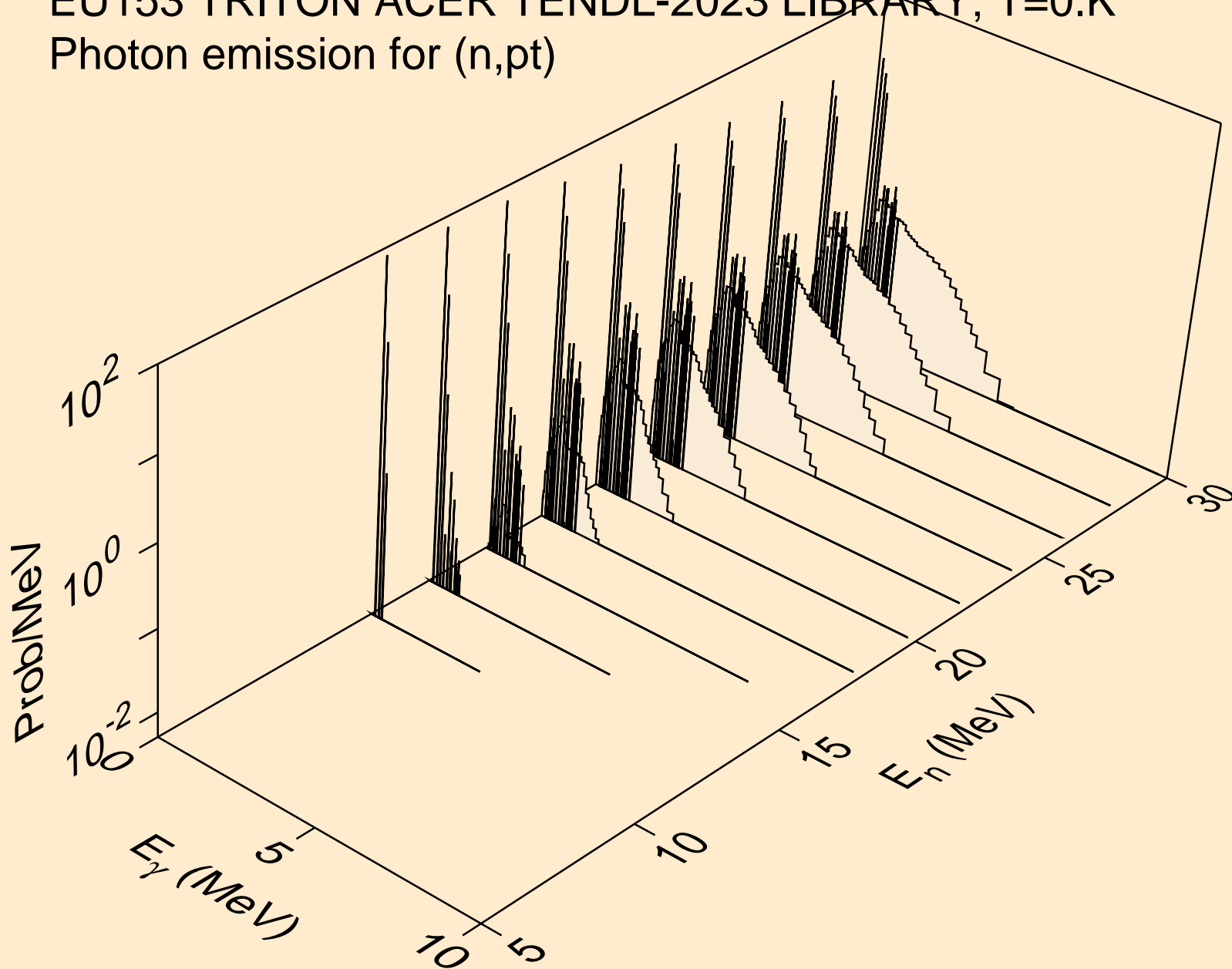

EU153 TRITON ACER TENDL-2023 LIBRARY; T=0.K
Photon emission for (n,da)

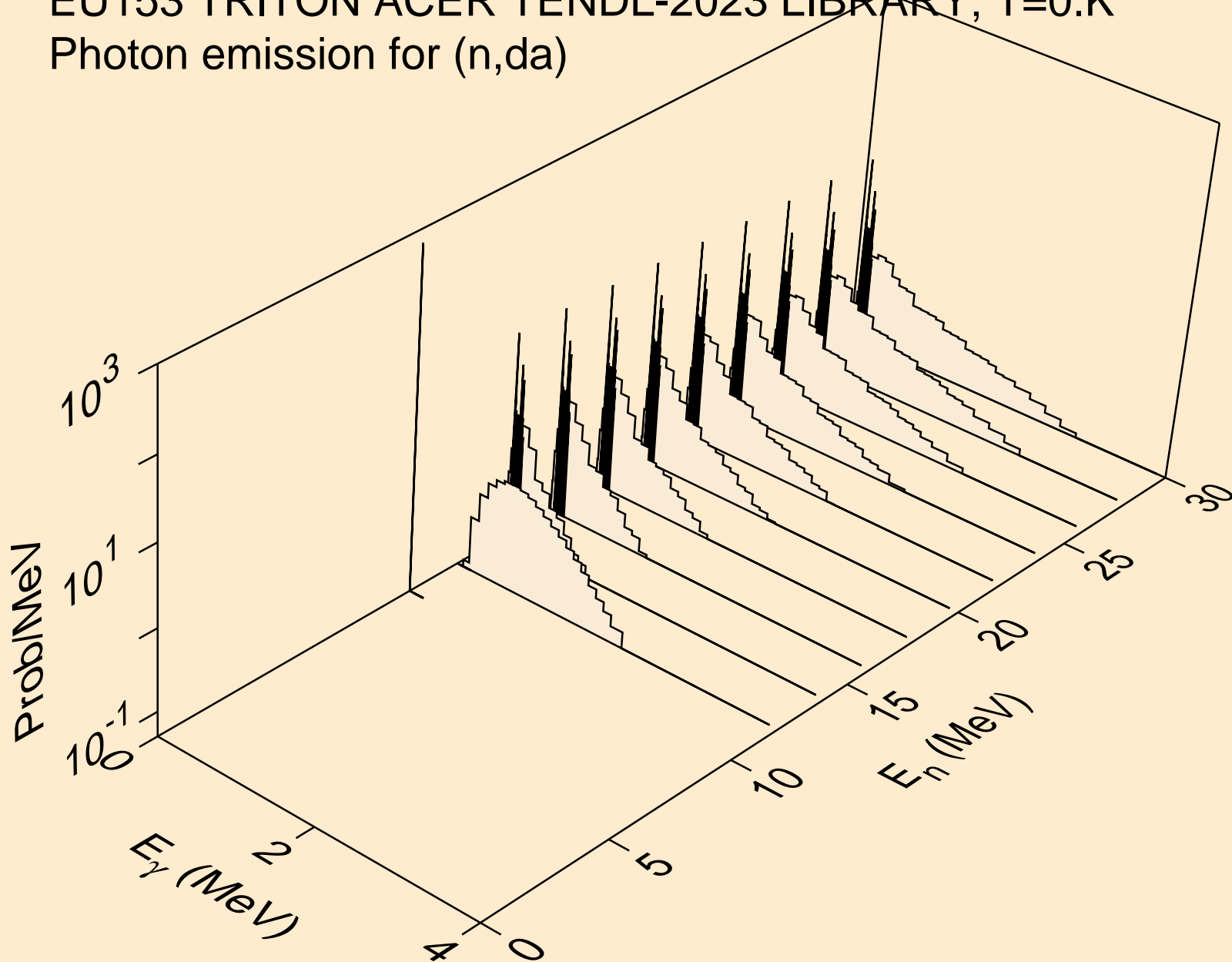

EU153 TRITON ACER TENDL-2023 LIBRARY; T=0.K

Particle heating contributions

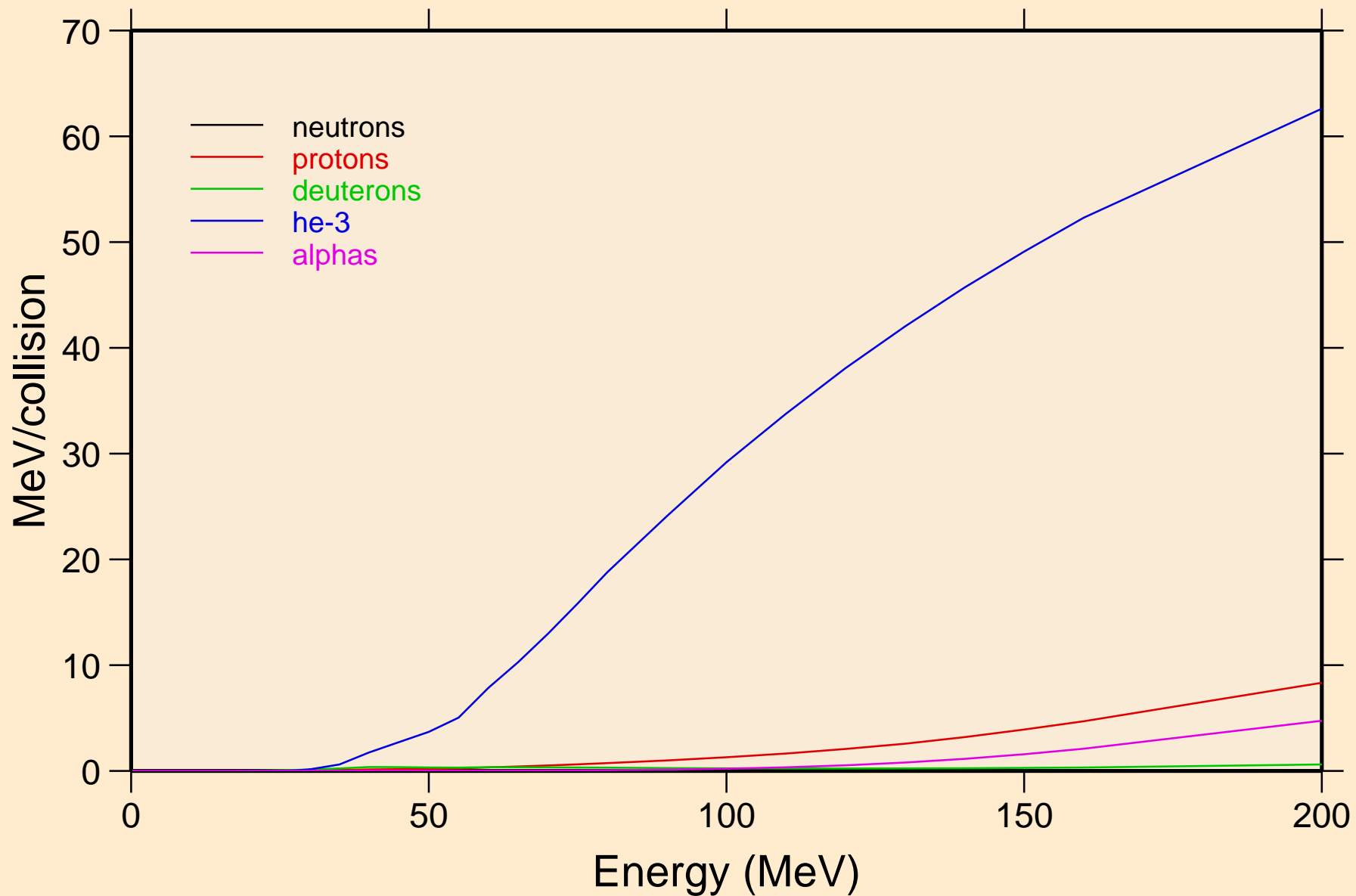

EU153 TRITON ACER TENDL-2023 LIBRARY; T=0.K
Recoil Heating

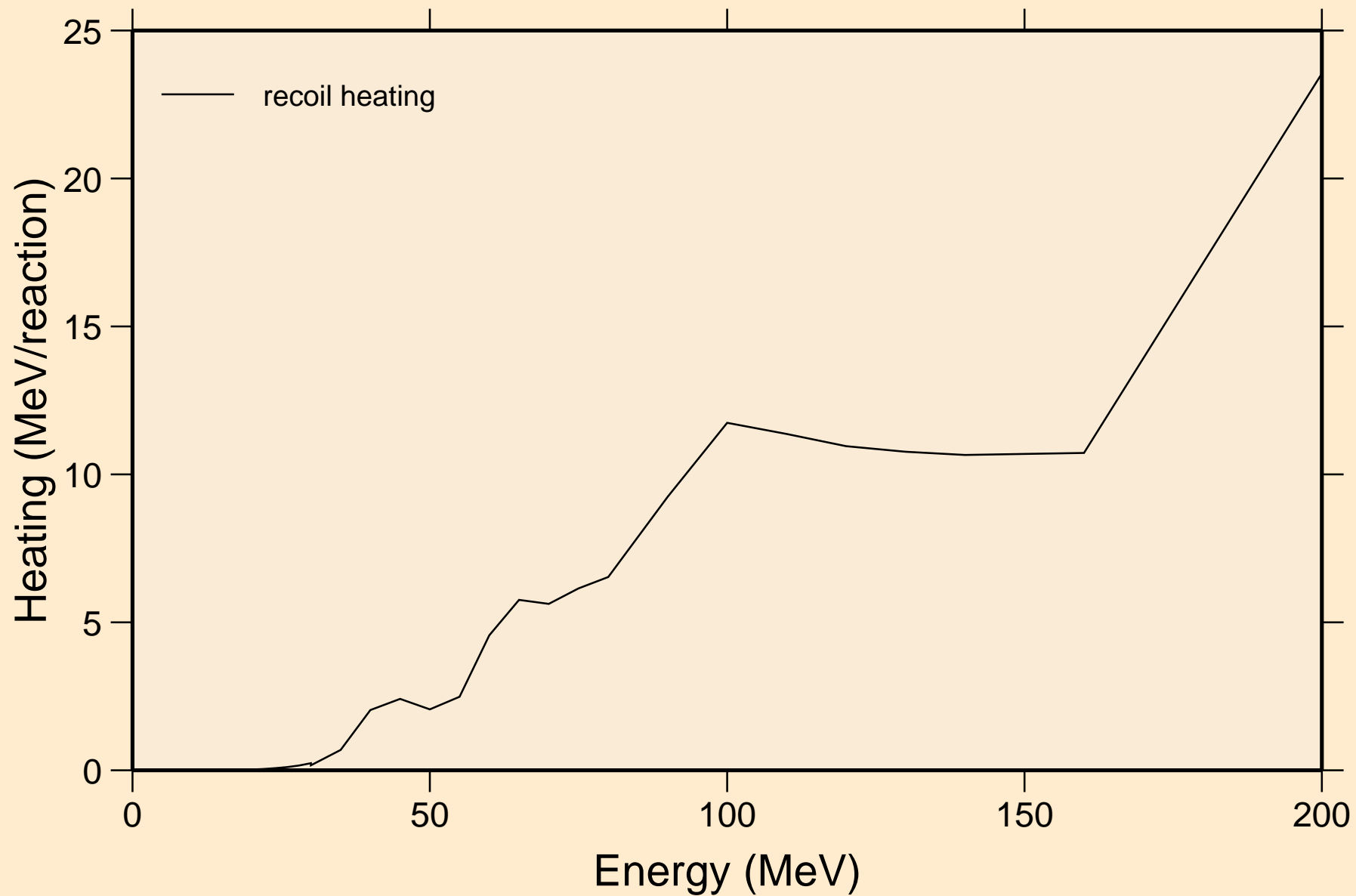

EU153 TRITON ACER TENDL-2023 LIBRARY; T=0.K

Particle production cross sections

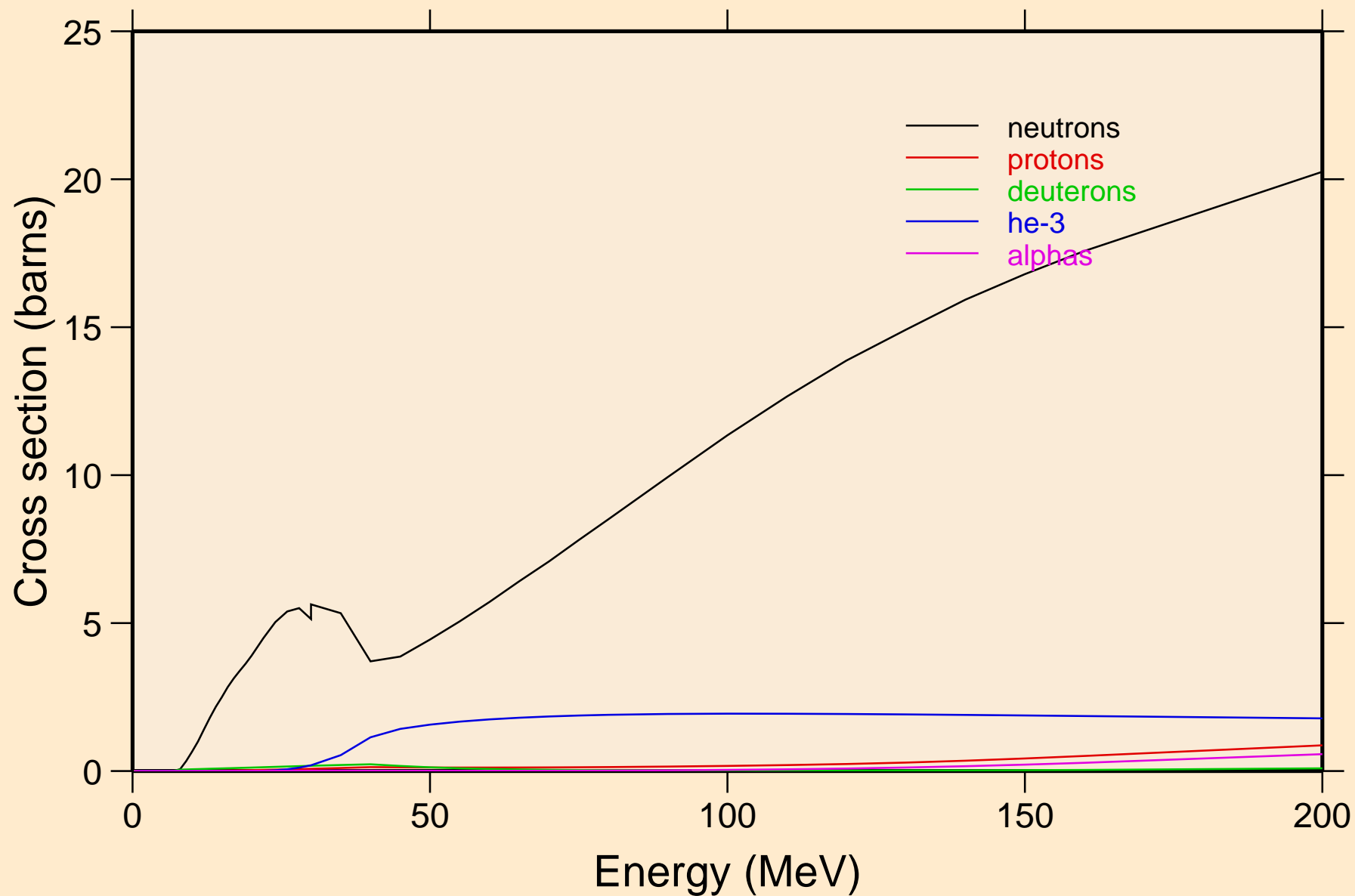

EU153 TRITON ACER TENDL-2023 LIBRARY; T=0.K
neutrons from (t,n)

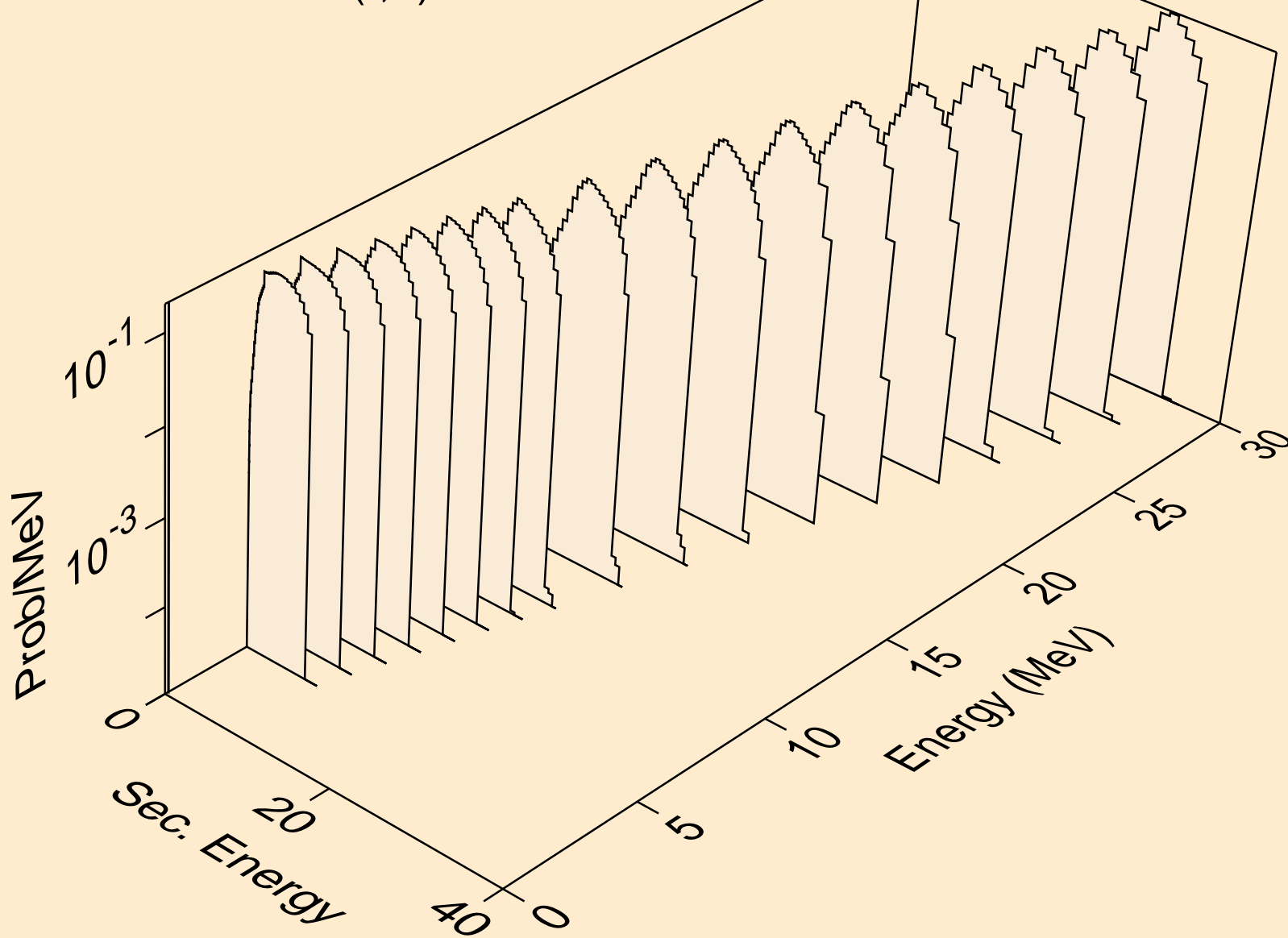

EU153 TRITON ACER TENDL-2023 LIBRARY; T=0.K
neutrons from (t,x)

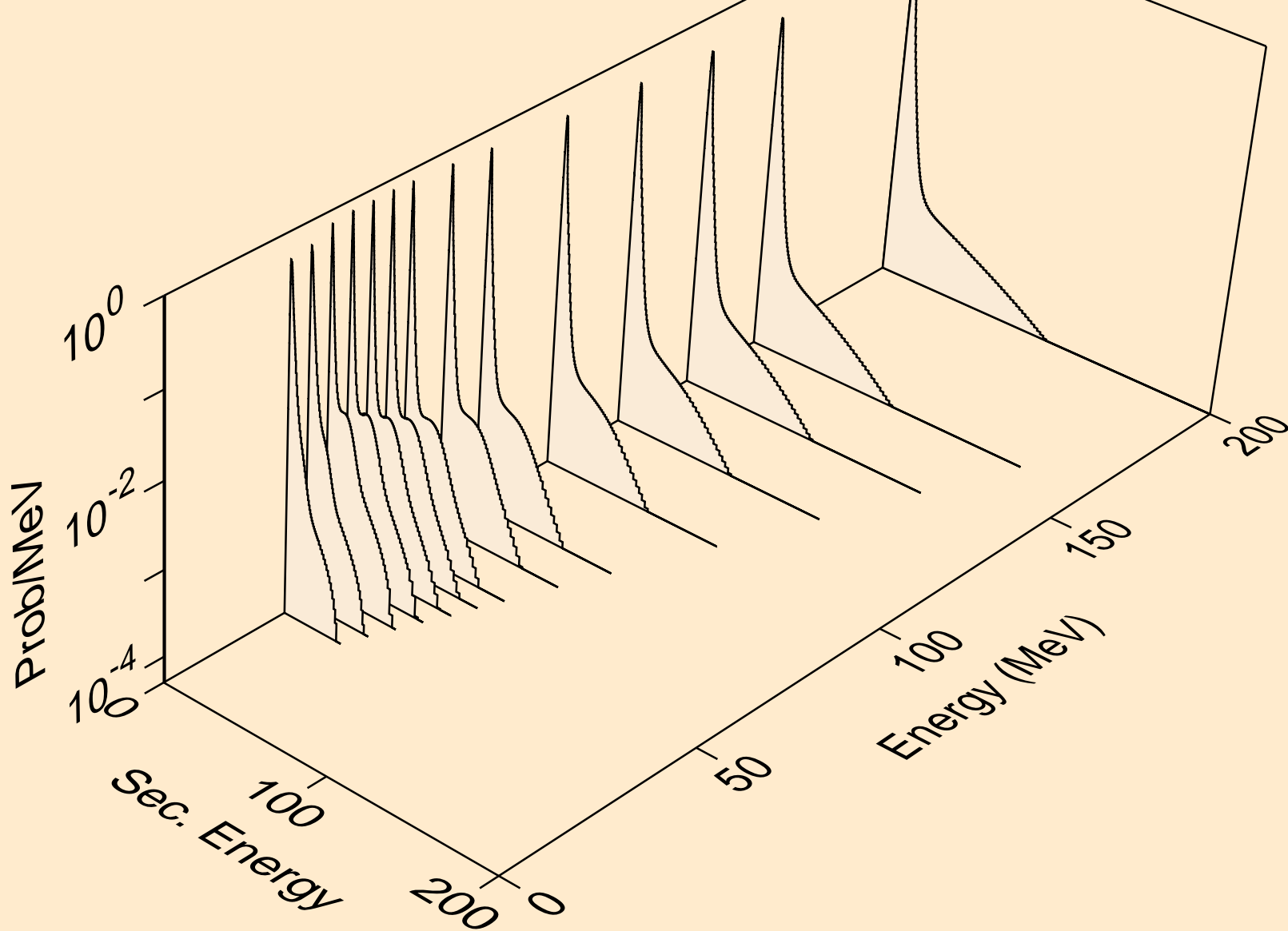

EU153 TRITON ACER TENDL-2023 LIBRARY; T=0.K
neutrons from (t,2nd)

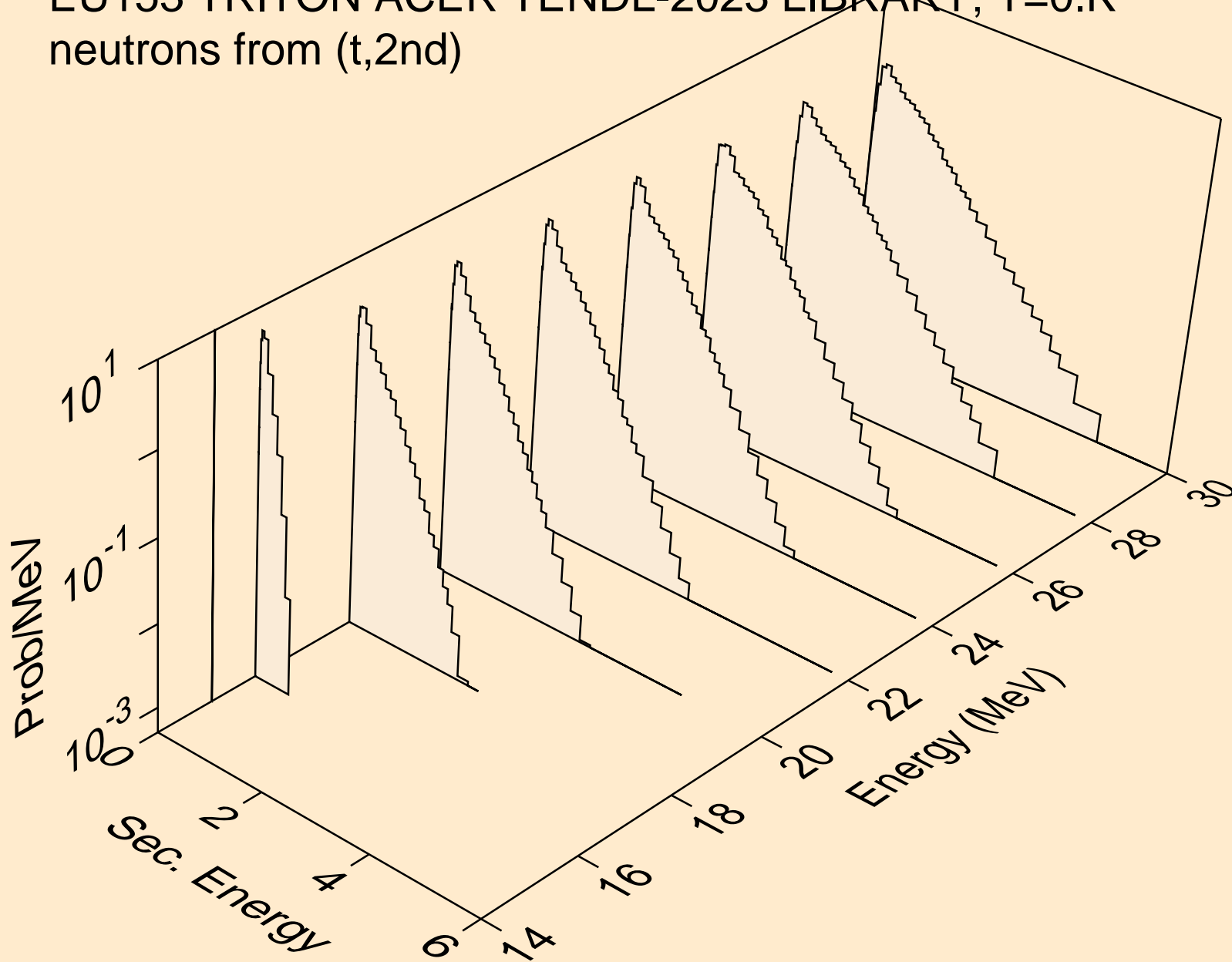

EU153 TRITON ACER TENDL-2023 LIBRARY; T=0.K
neutrons from (t,2n)

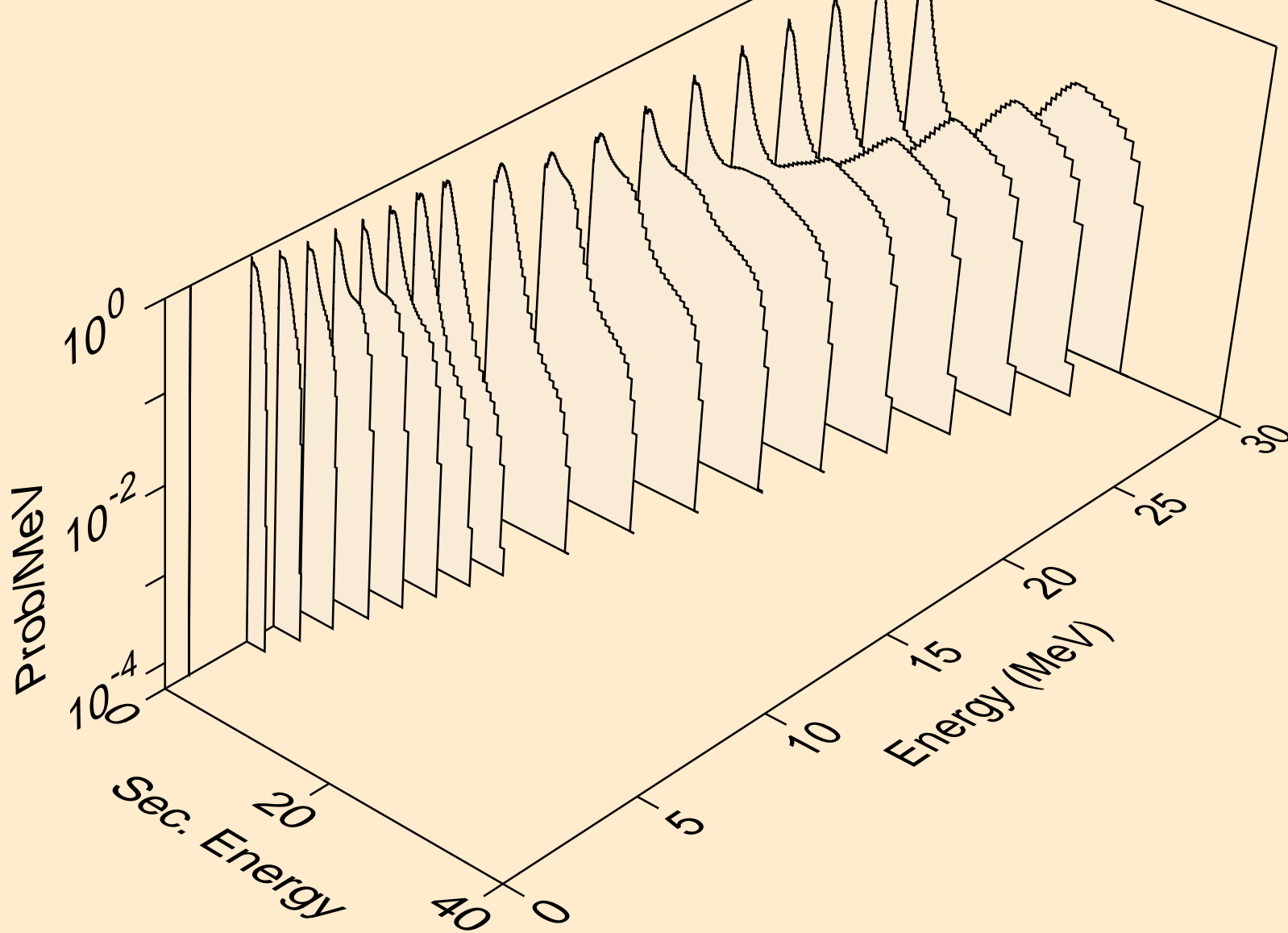

EU153 TRITON ACER TENDL-2023 LIBRARY; T=0.K
neutrons from (t,3n)

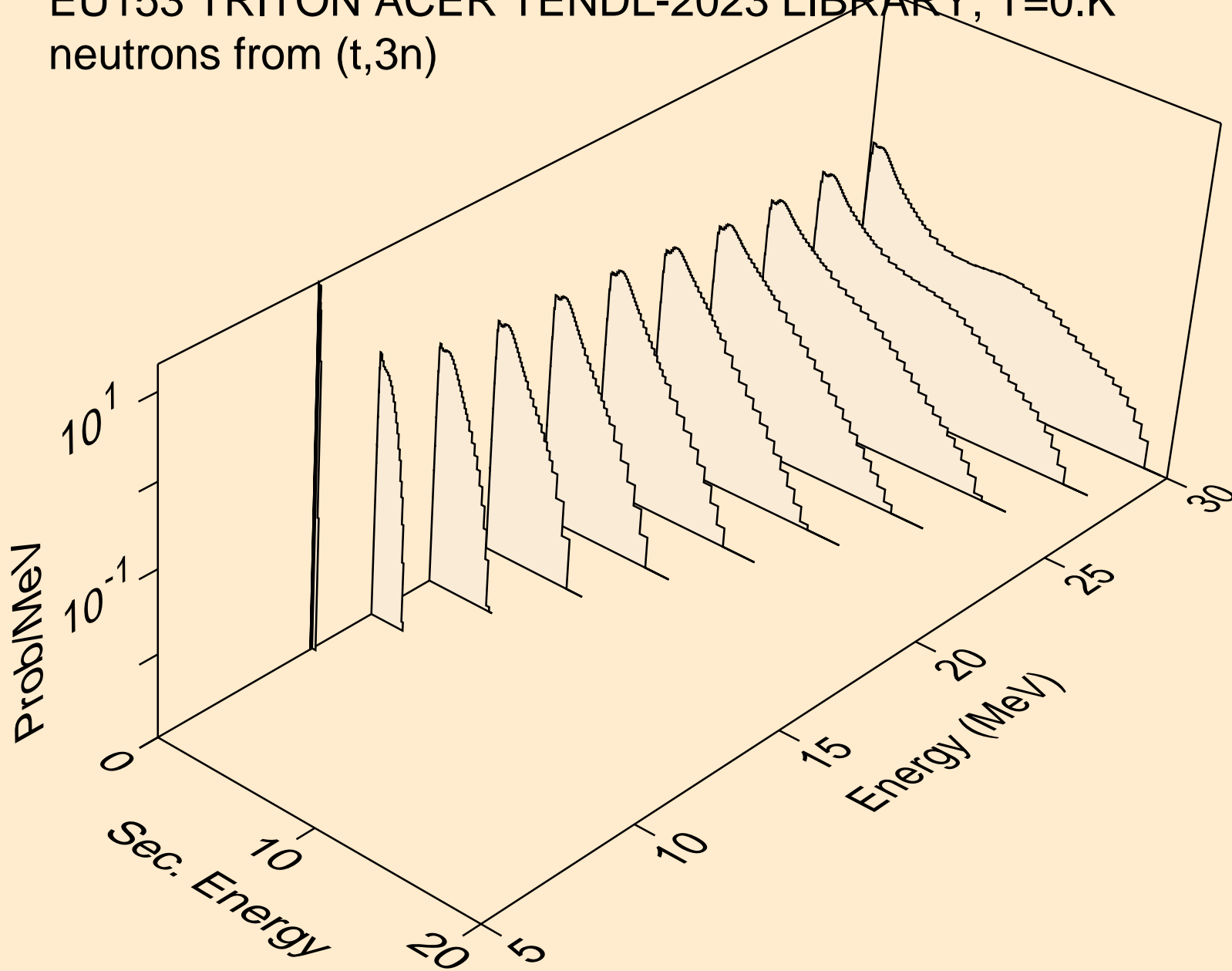

EU153 TRITON ACER TENDL-2023 LIBRARY; T=0.K
neutrons from (t,n*)a

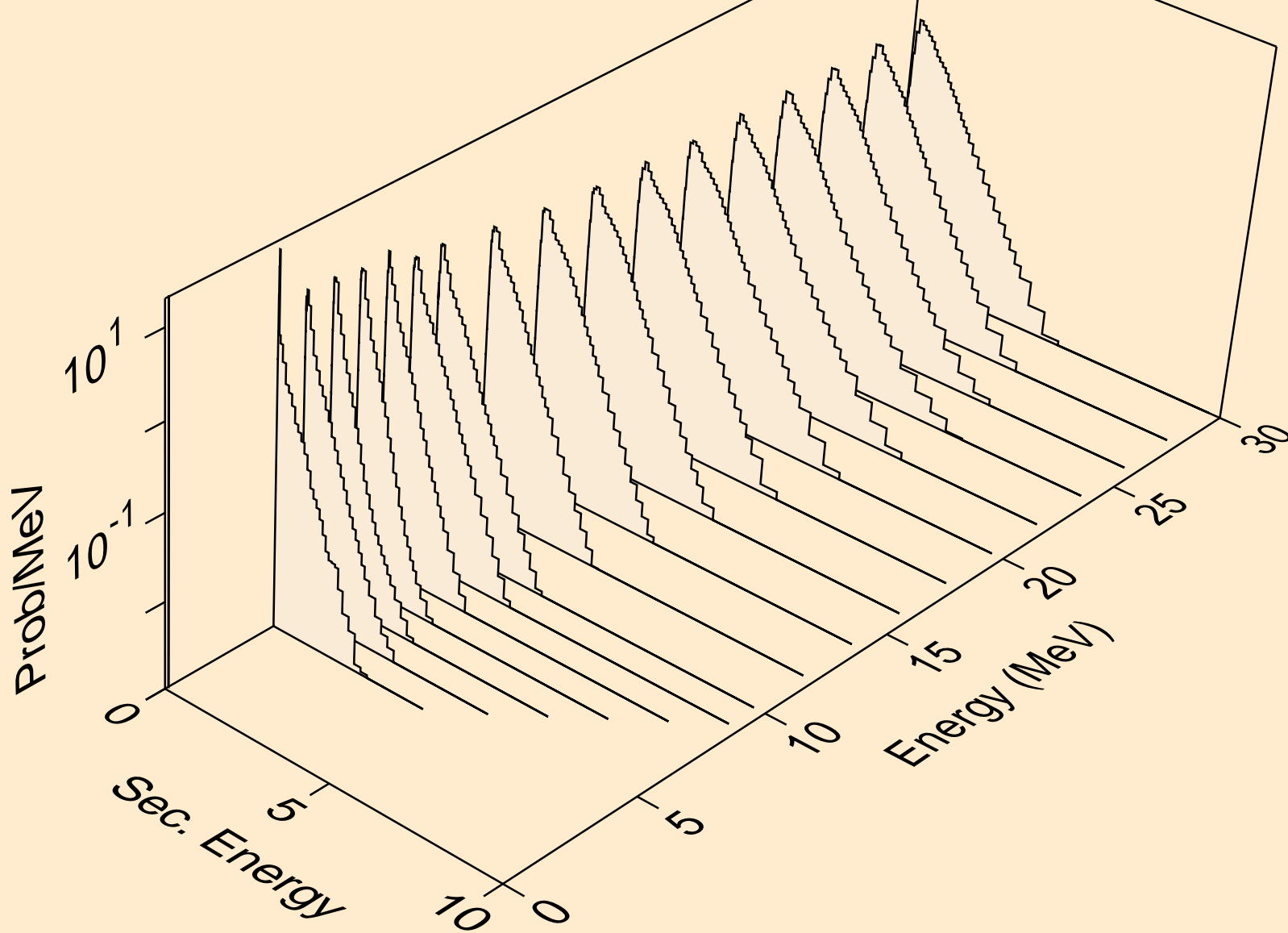

EU153 TRITON ACER TENDL-2023 LIBRARY; T=0.K
neutrons from (t,2n)a

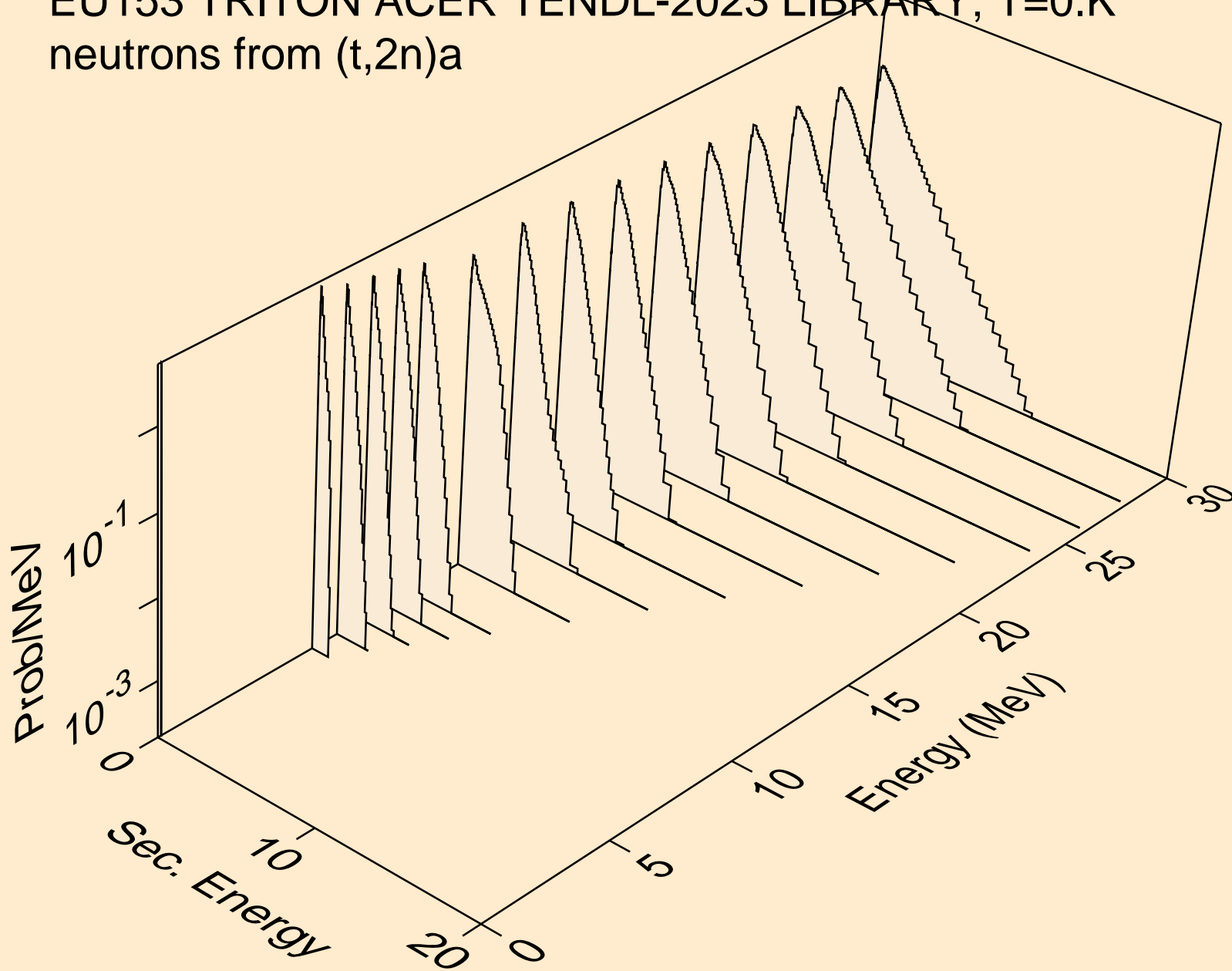

EU153 TRITON ACER TENDL-2023 LIBRARY; T=0.K
neutrons from (t,3n)a

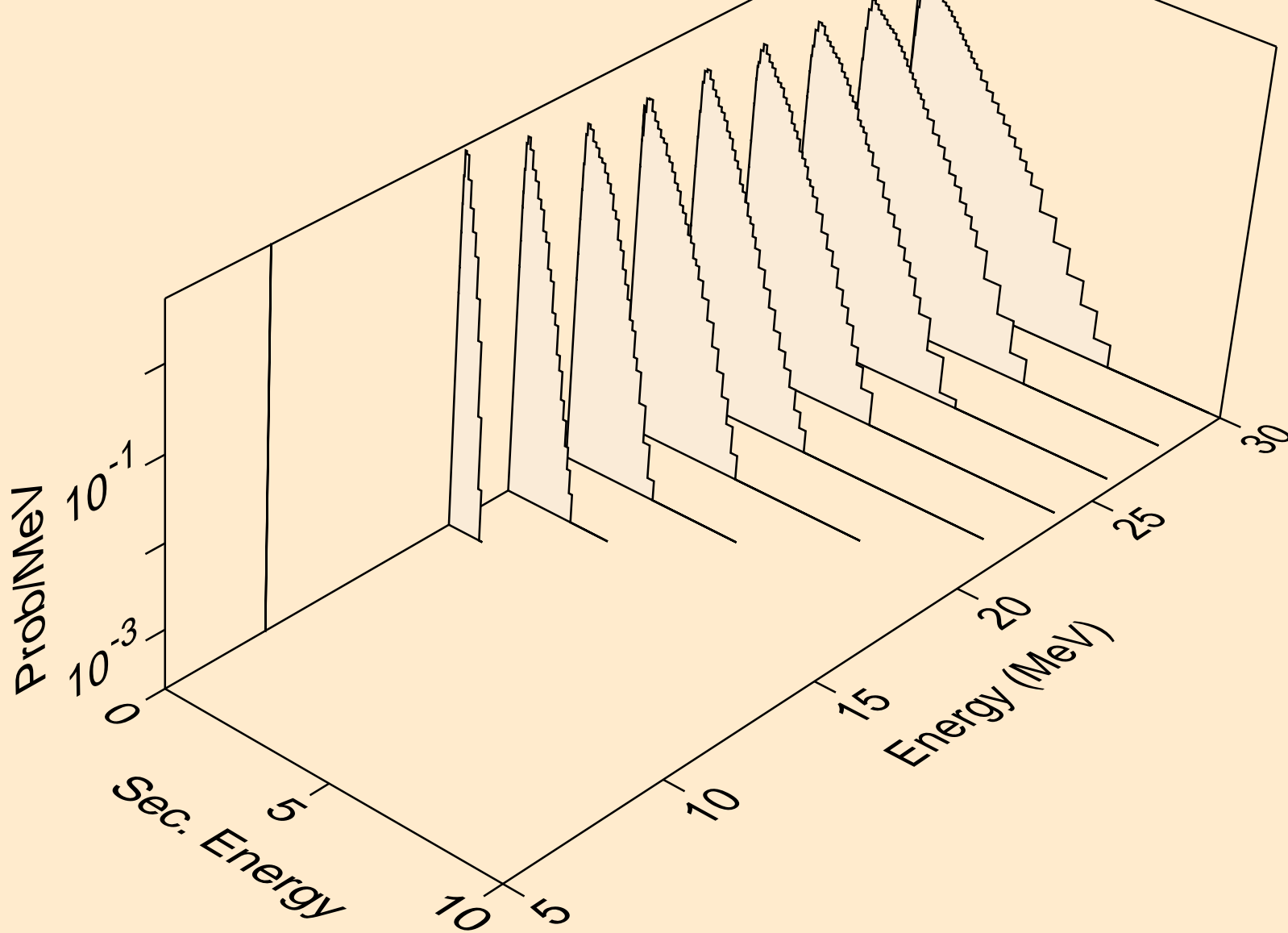

EU153 TRITON ACER TENDL-2023 LIBRARY; T=0.K
neutrons from (t,n*)p

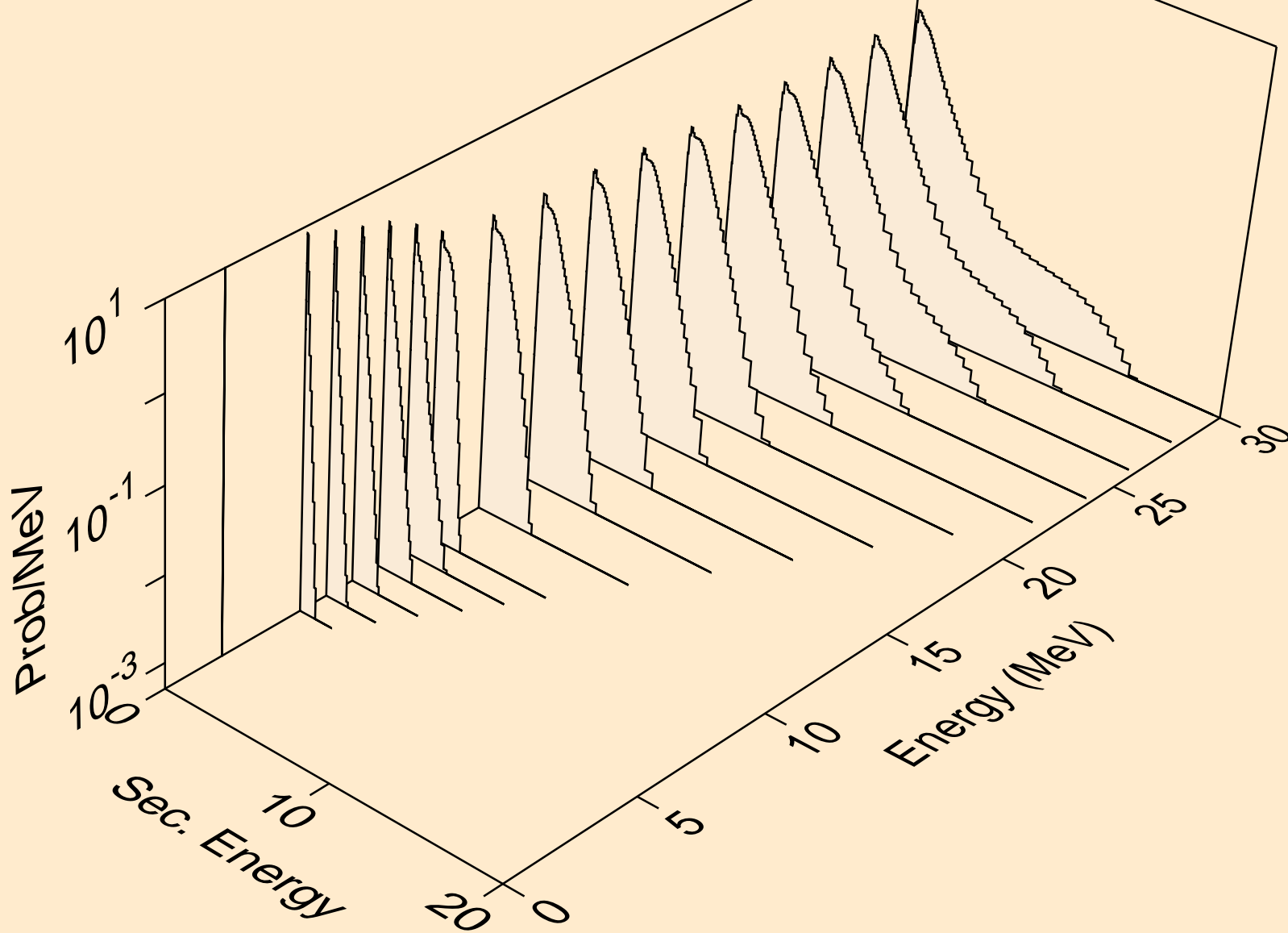

EU153 TRITON ACER TENDL-2023 LIBRARY; T=0.K
neutrons from (t,n*)2a

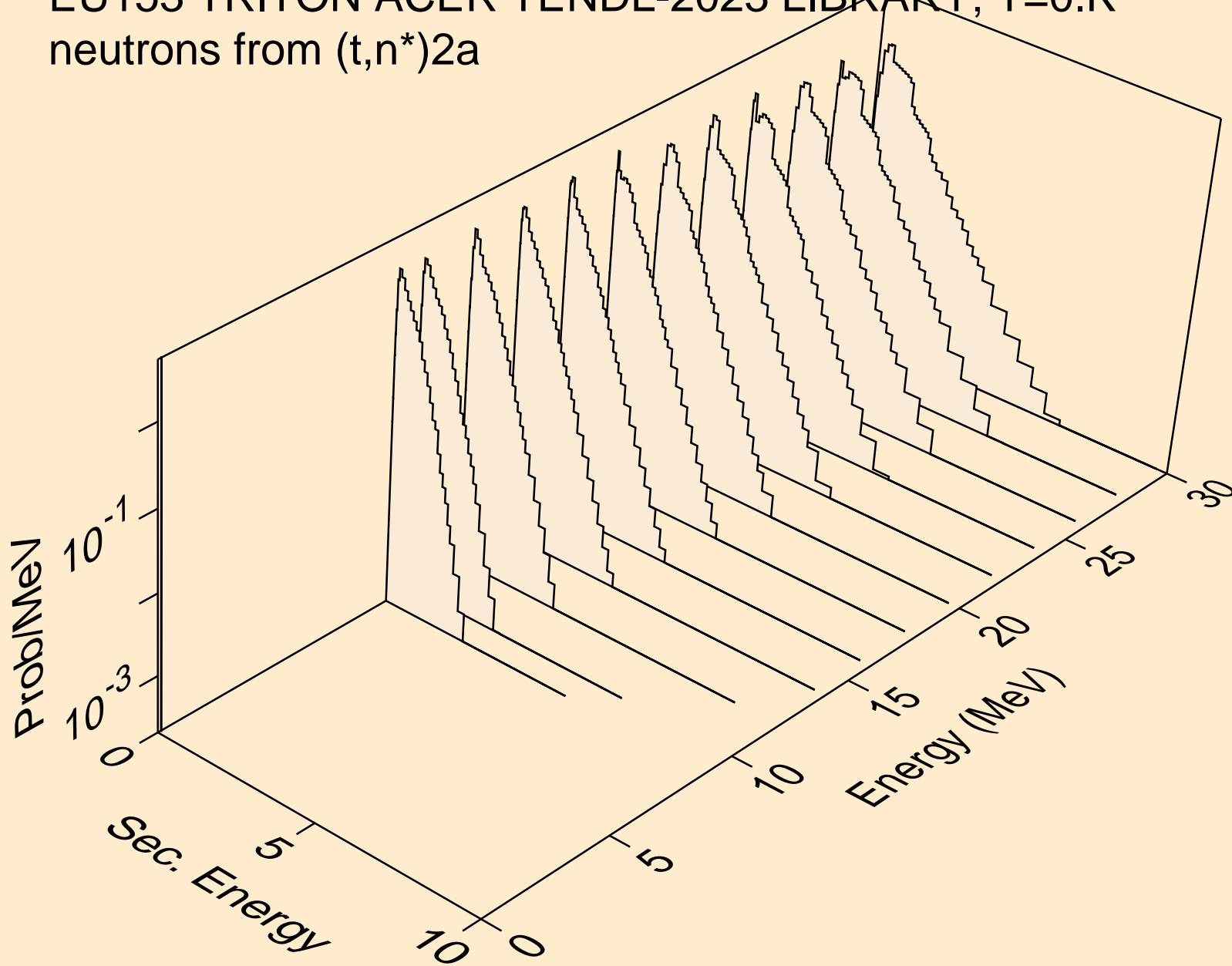

EU153 TRITON ACER TENDL-2023 LIBRARY; T=0.K
neutrons from (t,2n)2a

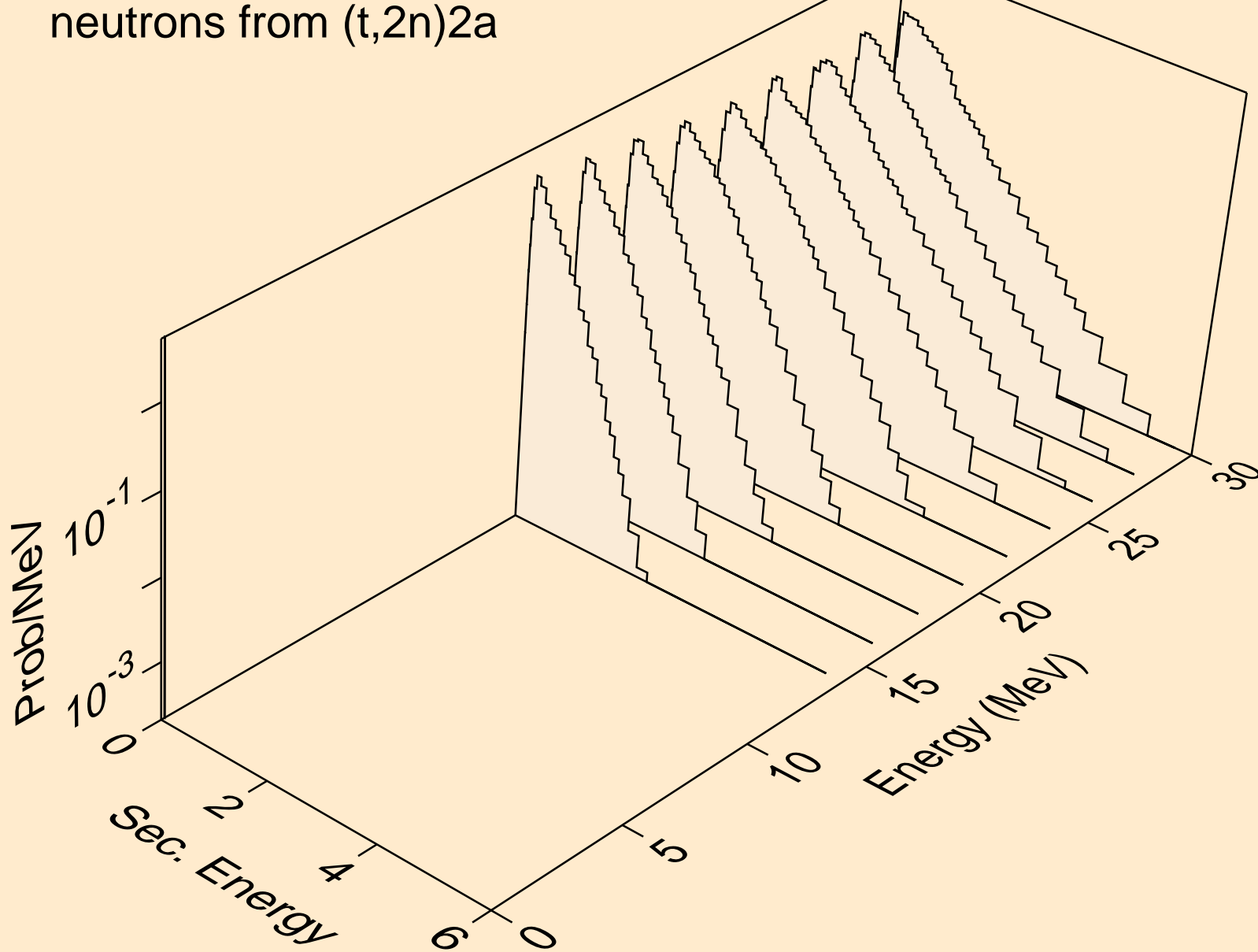

EU153 TRITON ACER TENDL-2023 LIBRARY; T=0.K
neutrons from (t,n*)d

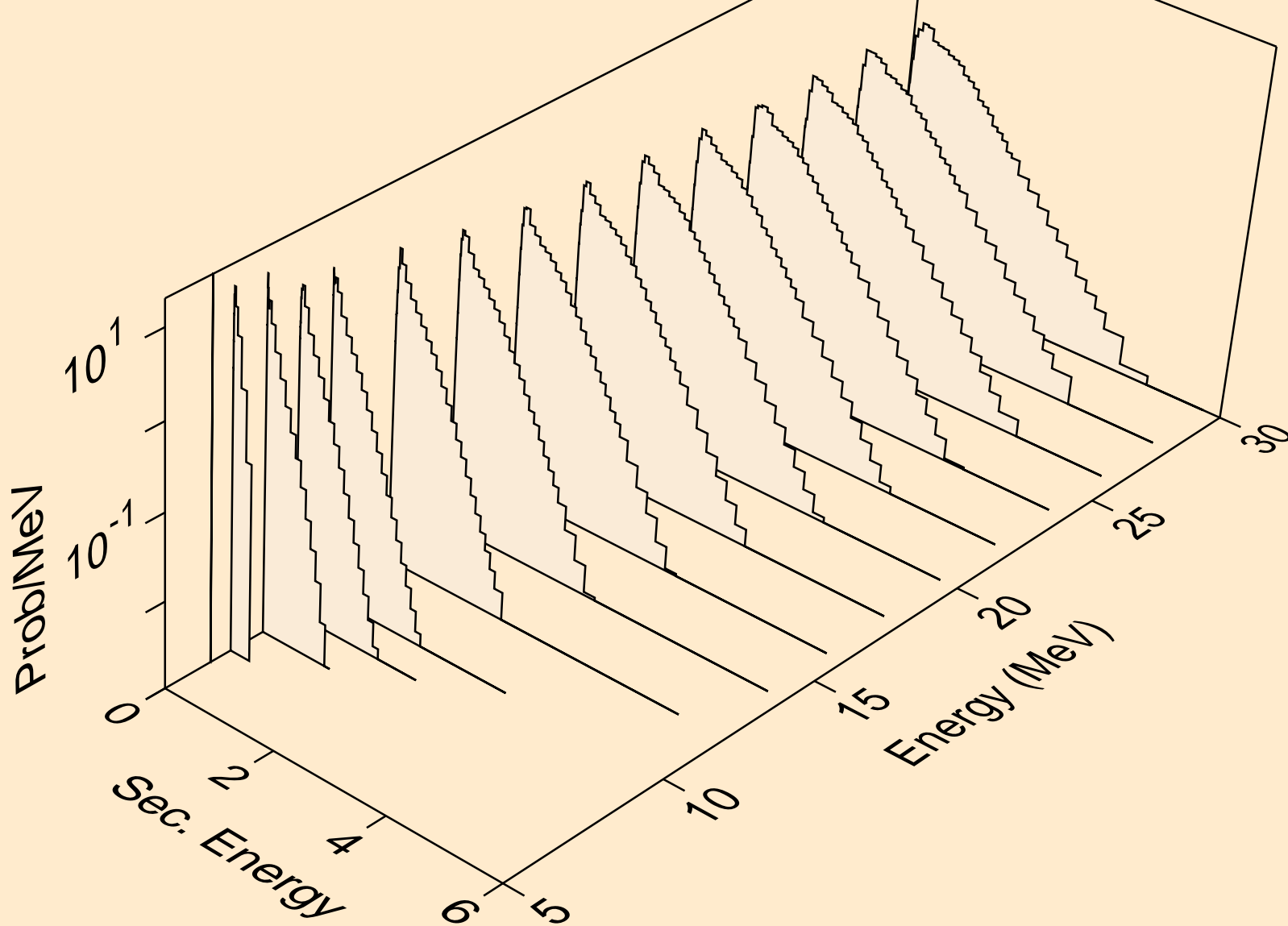

EU153 TRITON ACER TENDL-2023 LIBRARY; T=0.K
neutrons from (t,n*)t

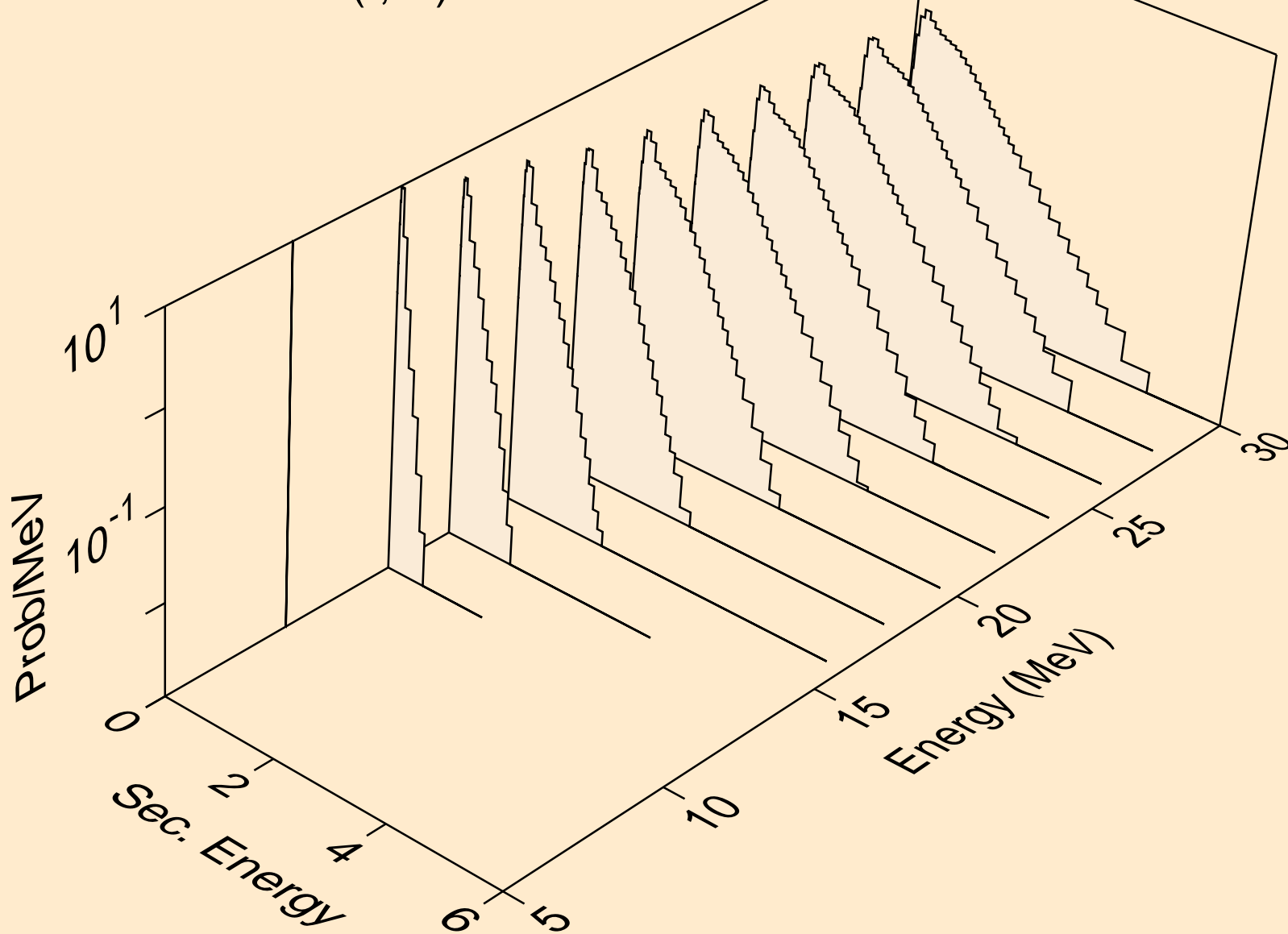

EU153 TRITON ACER TENDL-2023 LIBRARY; T=0.K
neutrons from (t,n*)he3

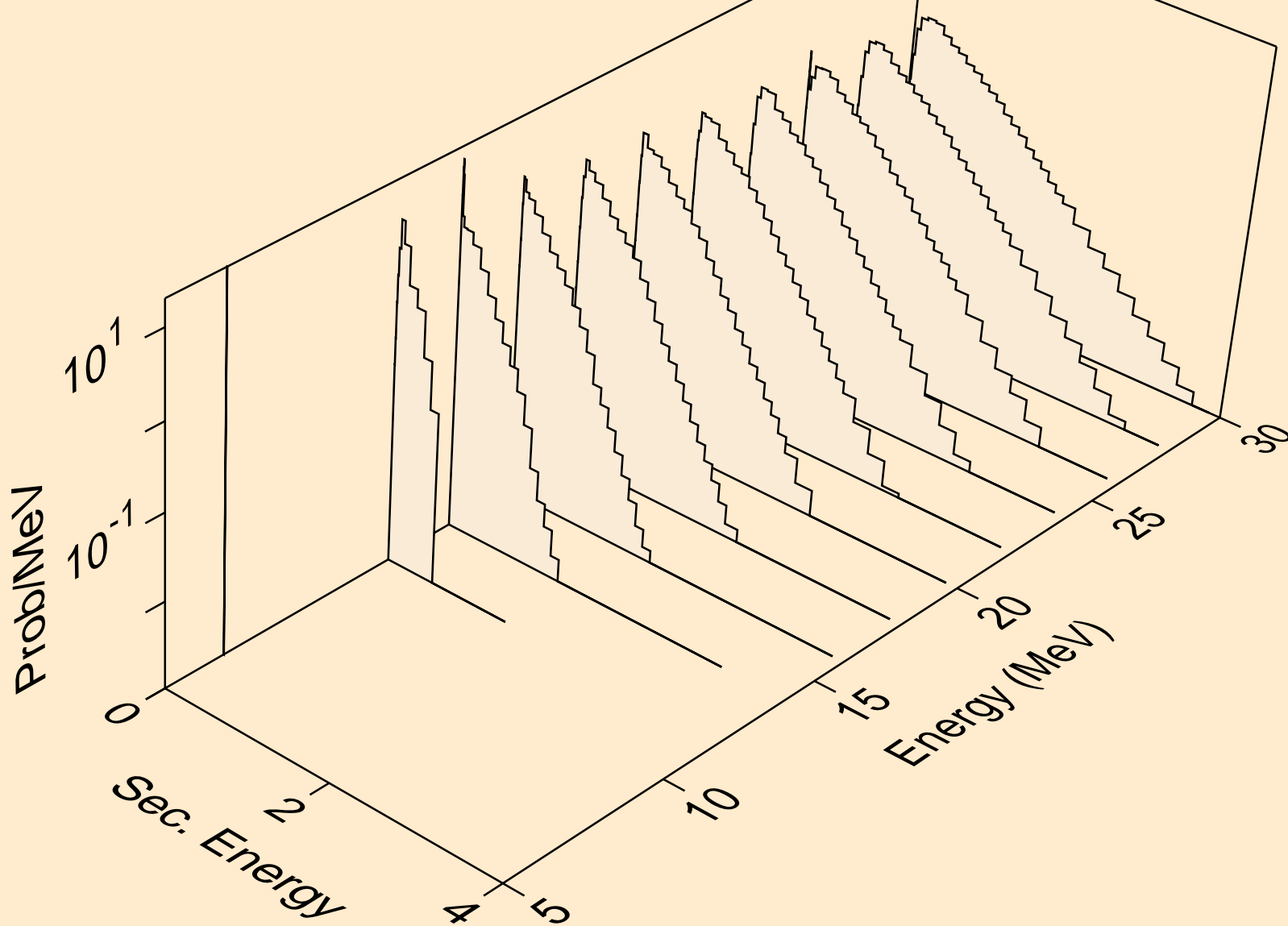

EU153 TRITON ACER TENDL-2023 LIBRARY; T=0.K
neutrons from (t,4n)

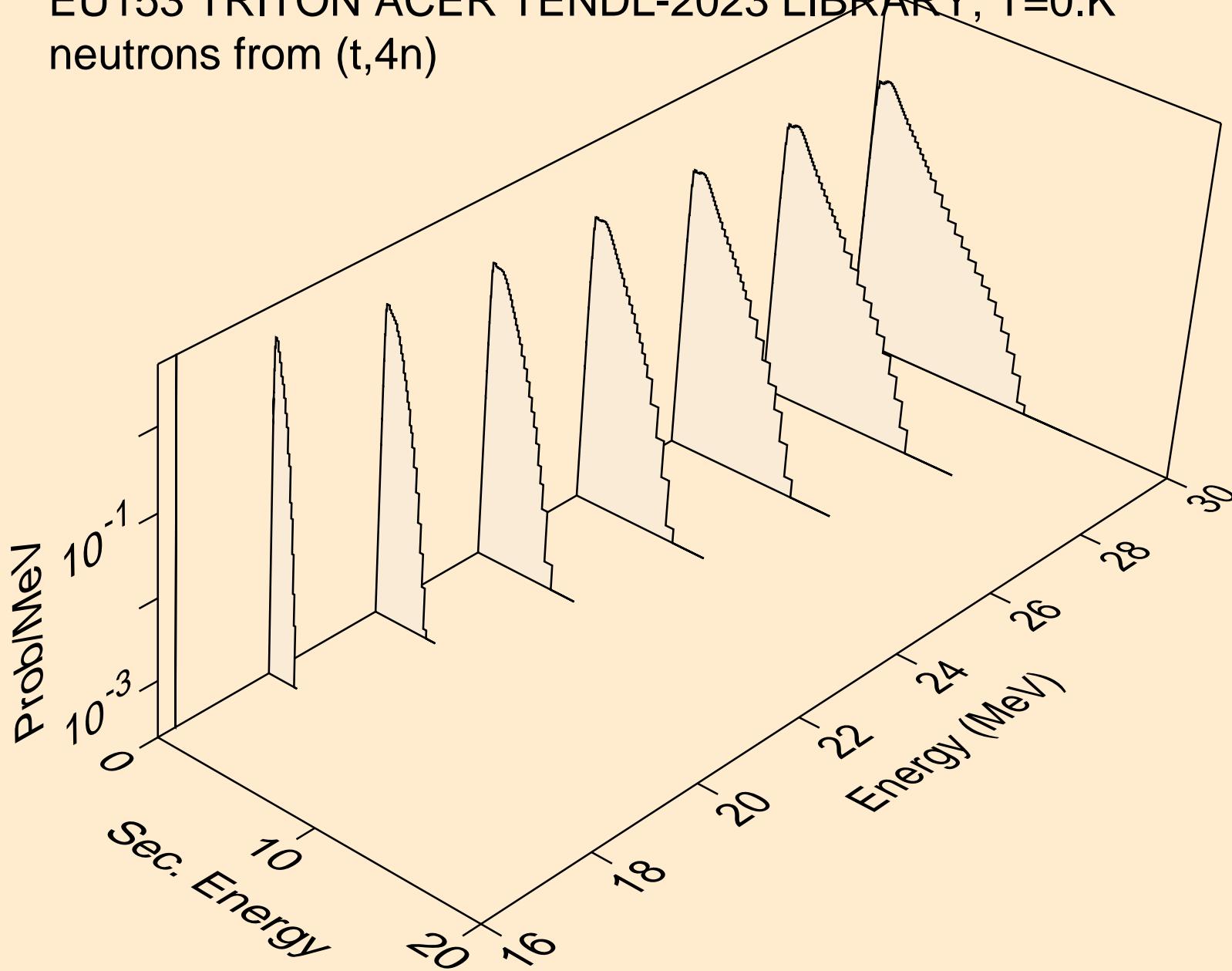

EU153 TRITON ACER TENDL-2023 LIBRARY; T=0.K
neutrons from (t,2np)

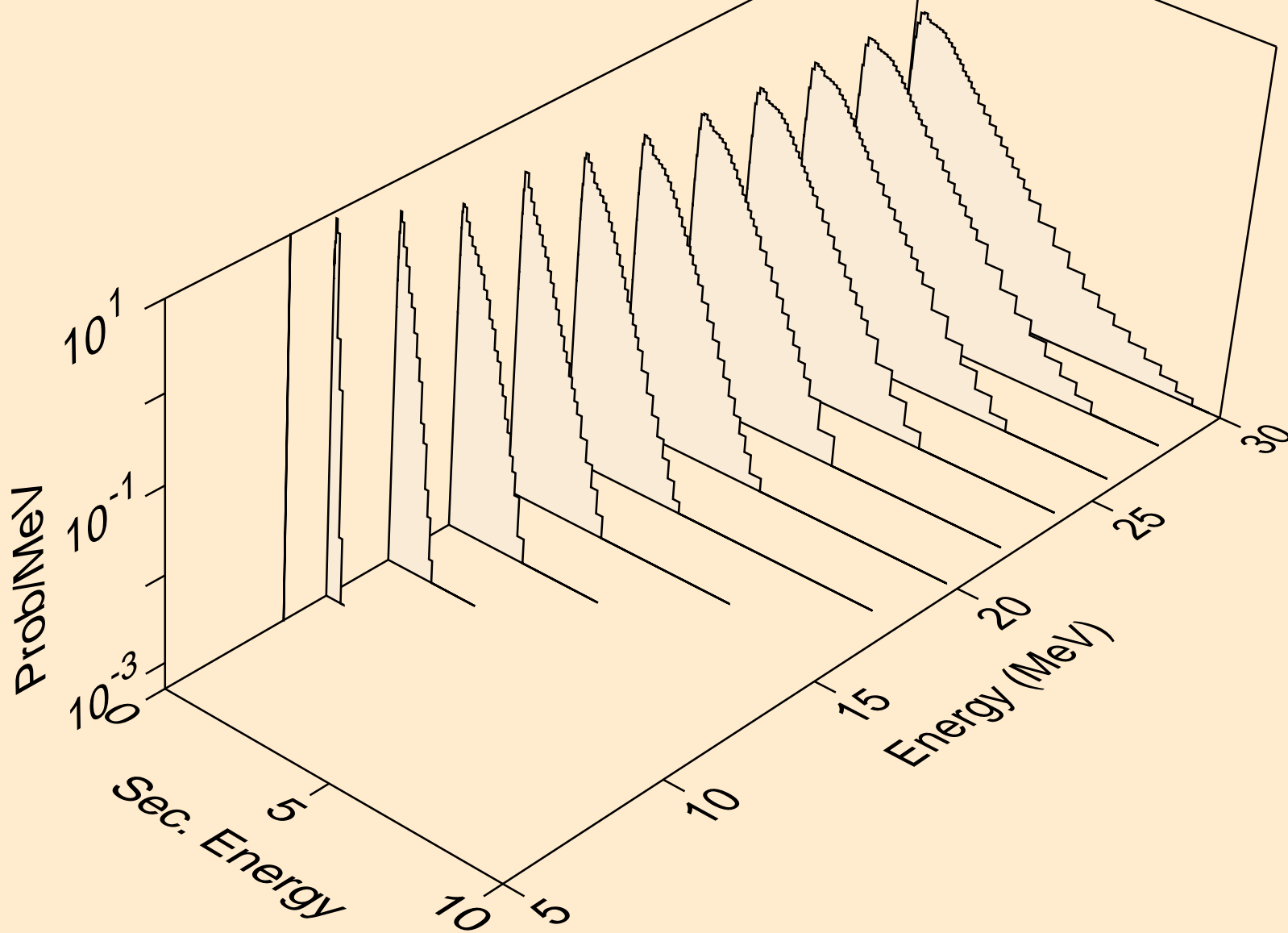

EU153 TRITON ACER TENDL-2023 LIBRARY; T=0.K
neutrons from (t,3np)

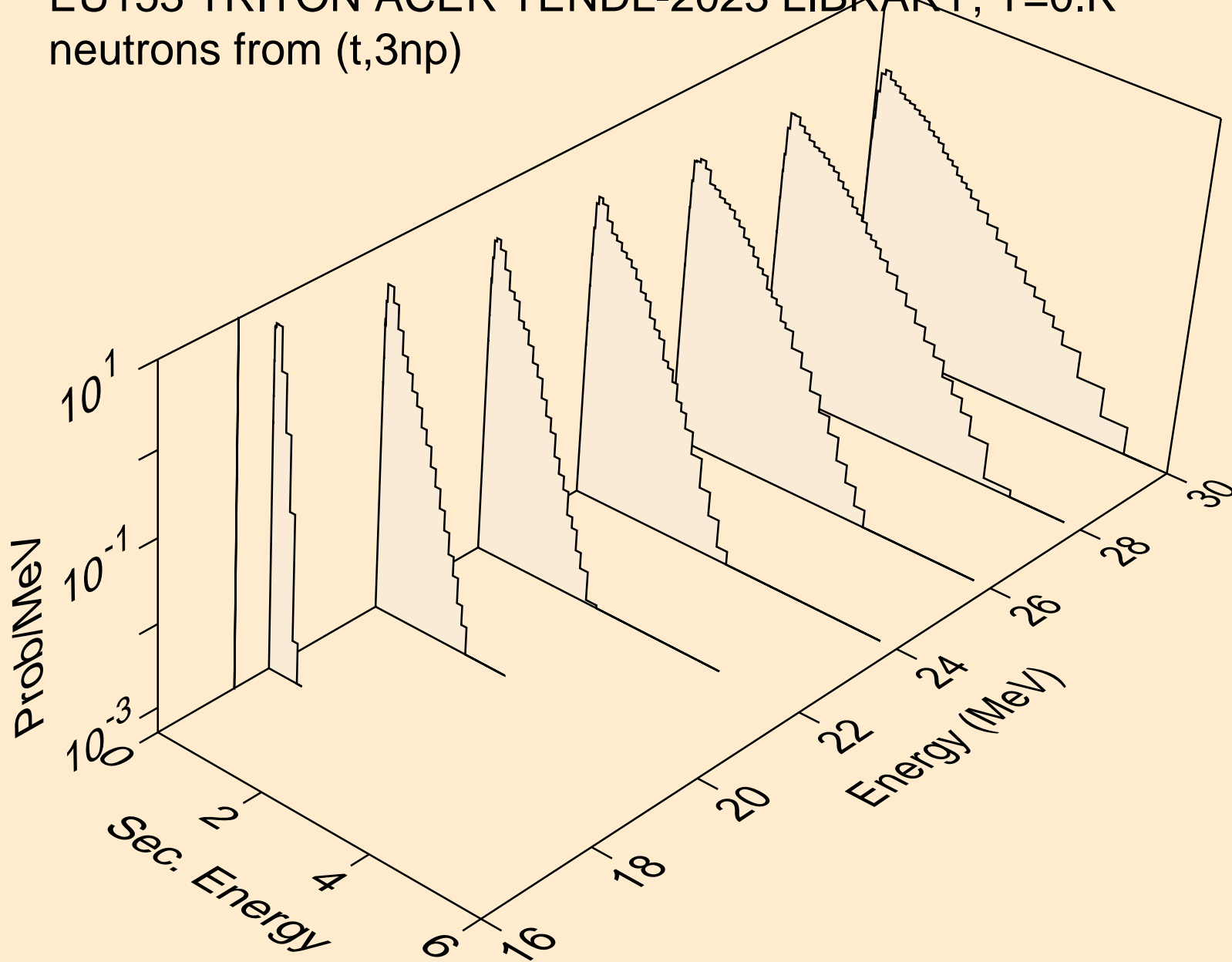

EU153 TRITON ACER TENDL-2023 LIBRARY; T=0.K
neutrons from (t,n2p)

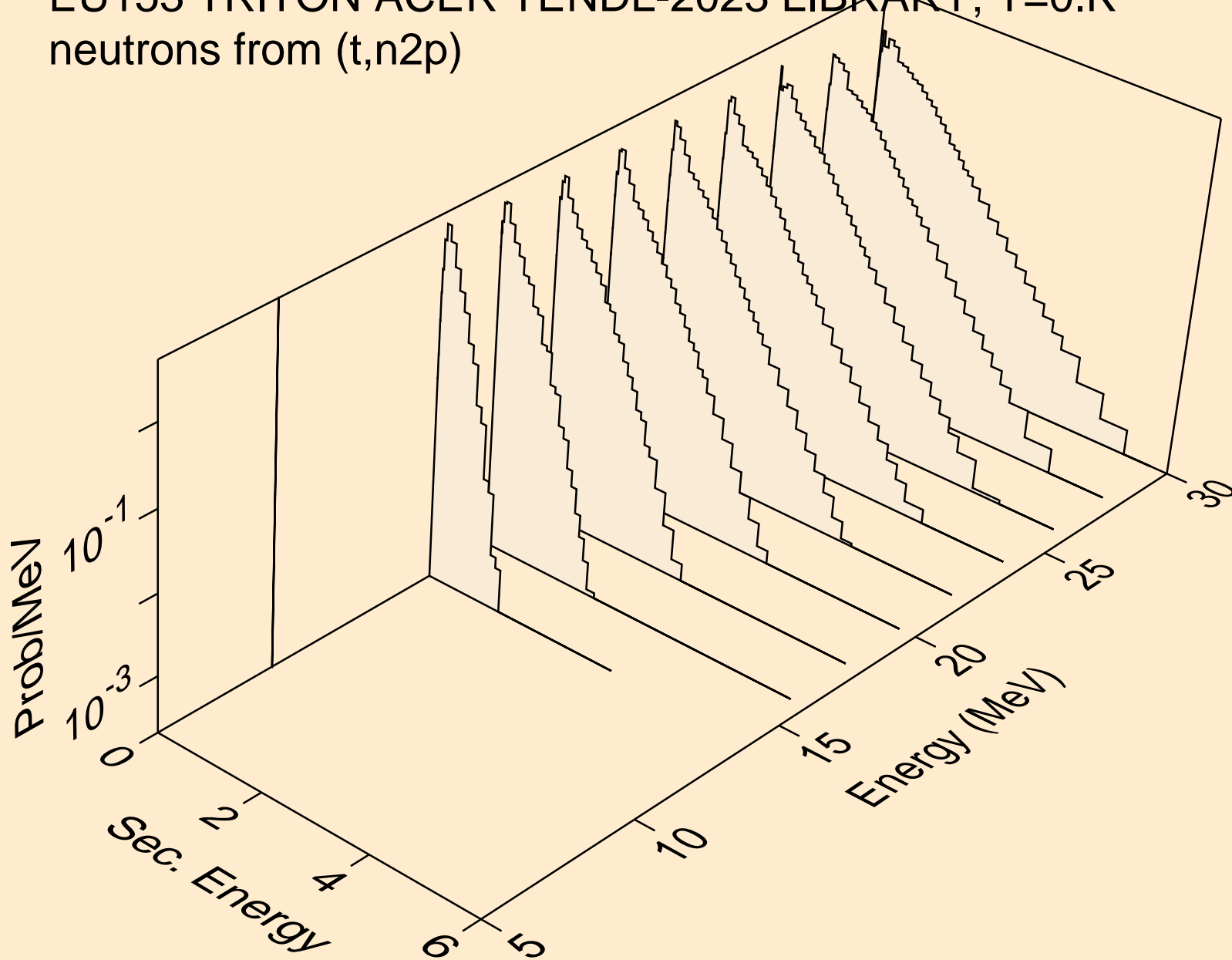

EU153 TRITON ACER TENDL-2023 LIBRARY; T=0.K
neutrons from (t,npa)

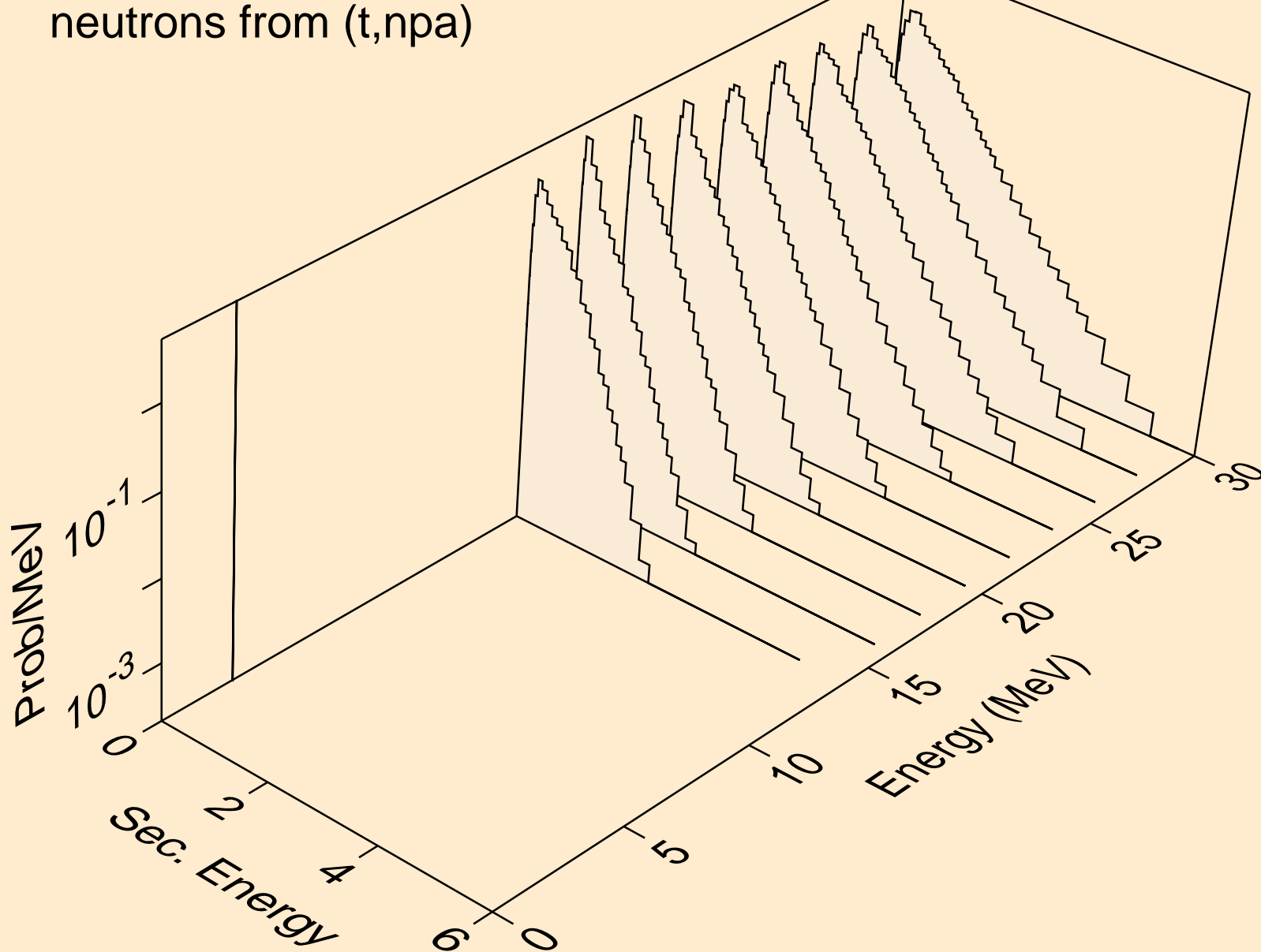

EU153 TRITON ACER TENDL-2023 LIBRARY; T=0.K
protons from (t,x)

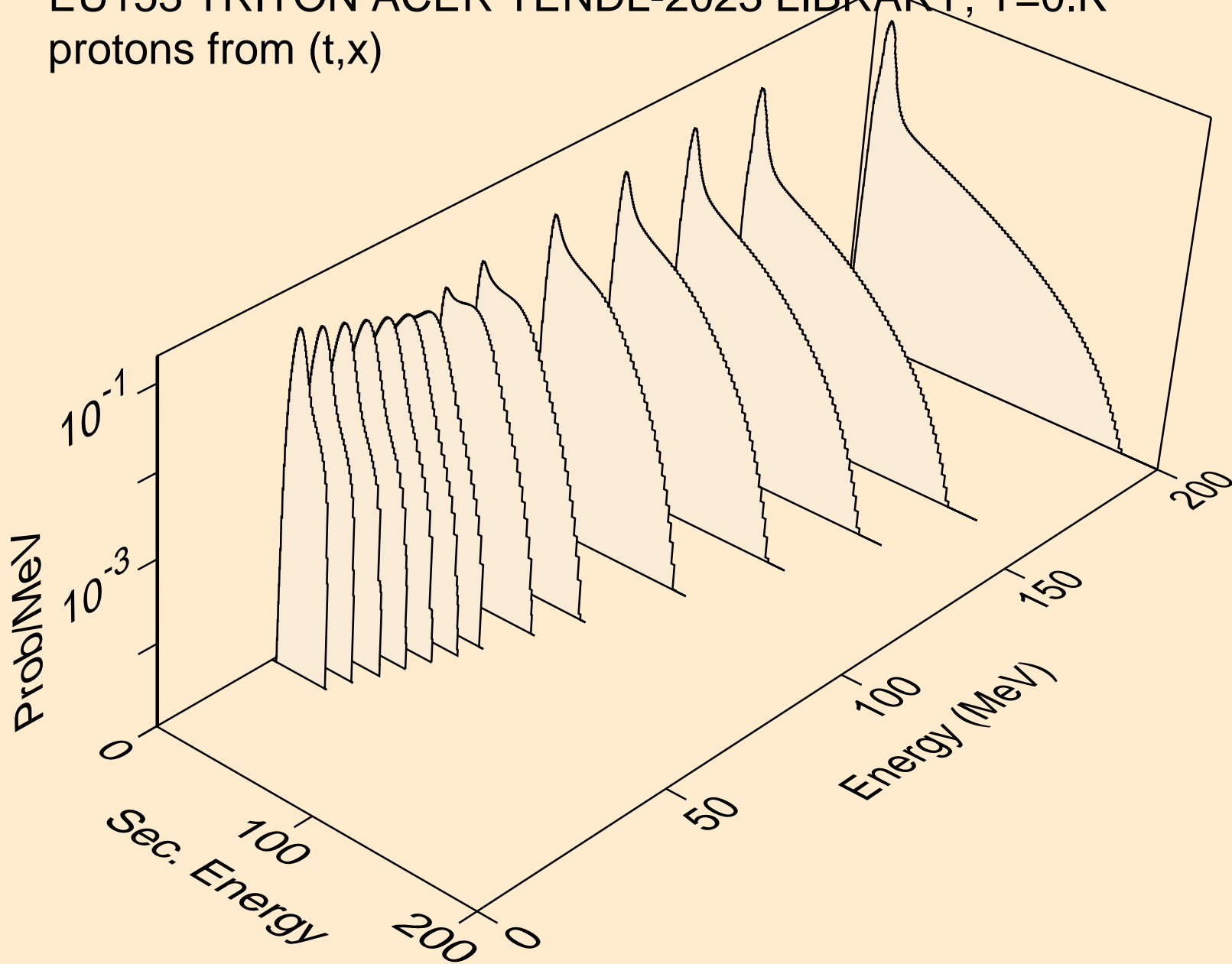

EU153 TRITON ACER TENDL-2023 LIBRARY; T=0.K
protons from (t,n*)p

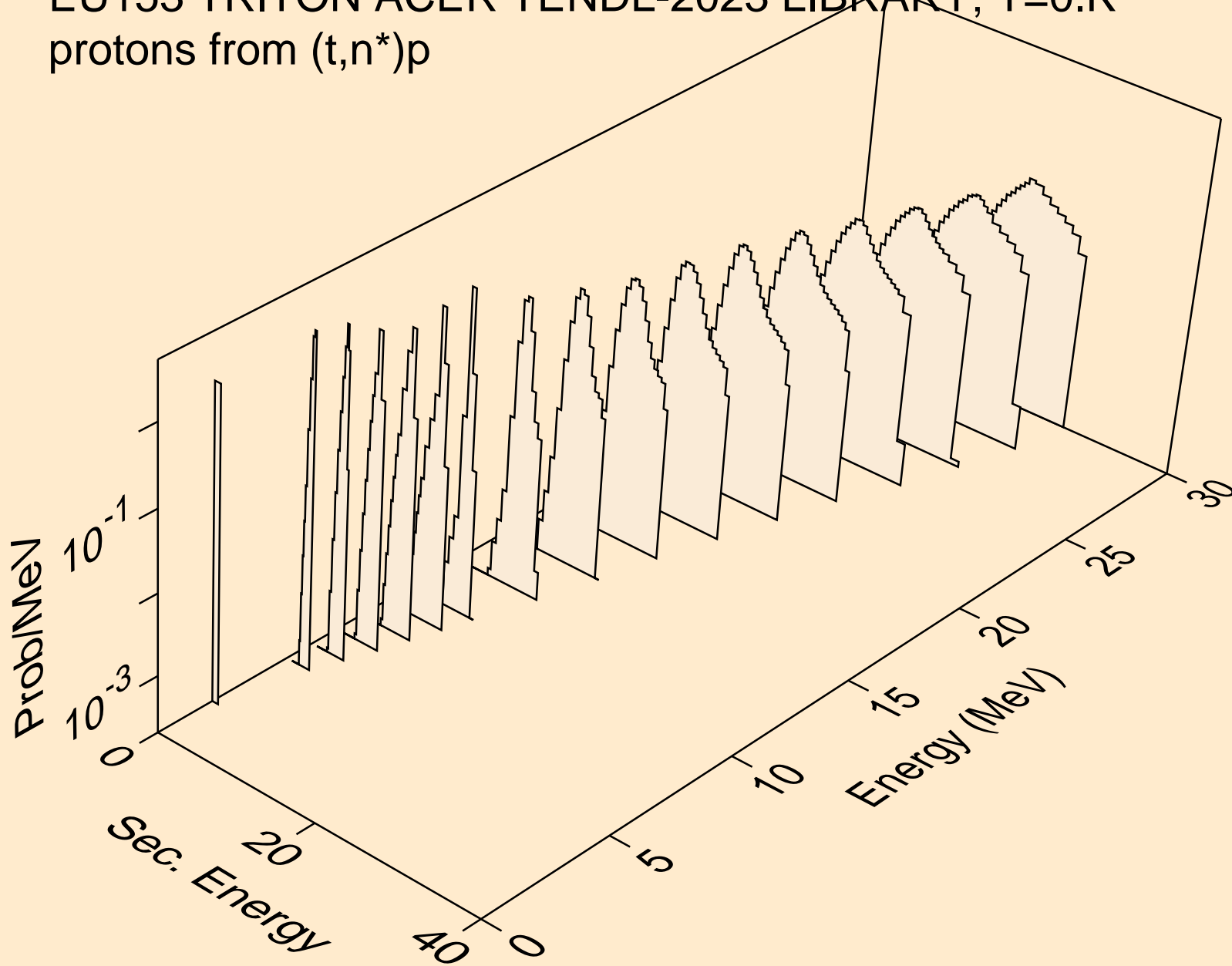

EU153 TRITON ACER TENDL-2023 LIBRARY; T=0.K
protons from (t,2np)

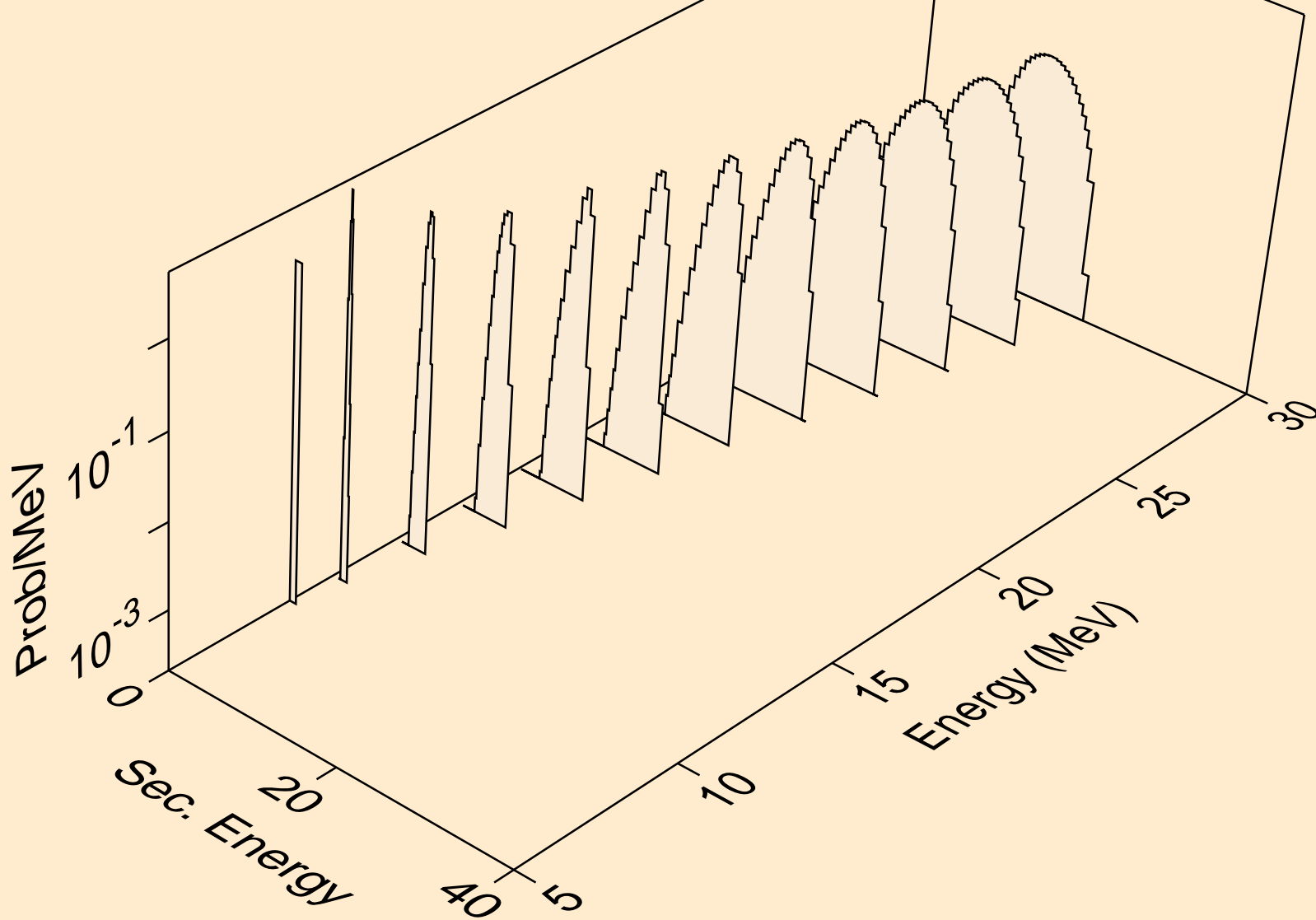

EU153 TRITON ACER TENDL-2023 LIBRARY; T=0.K
protons from (t,3np)

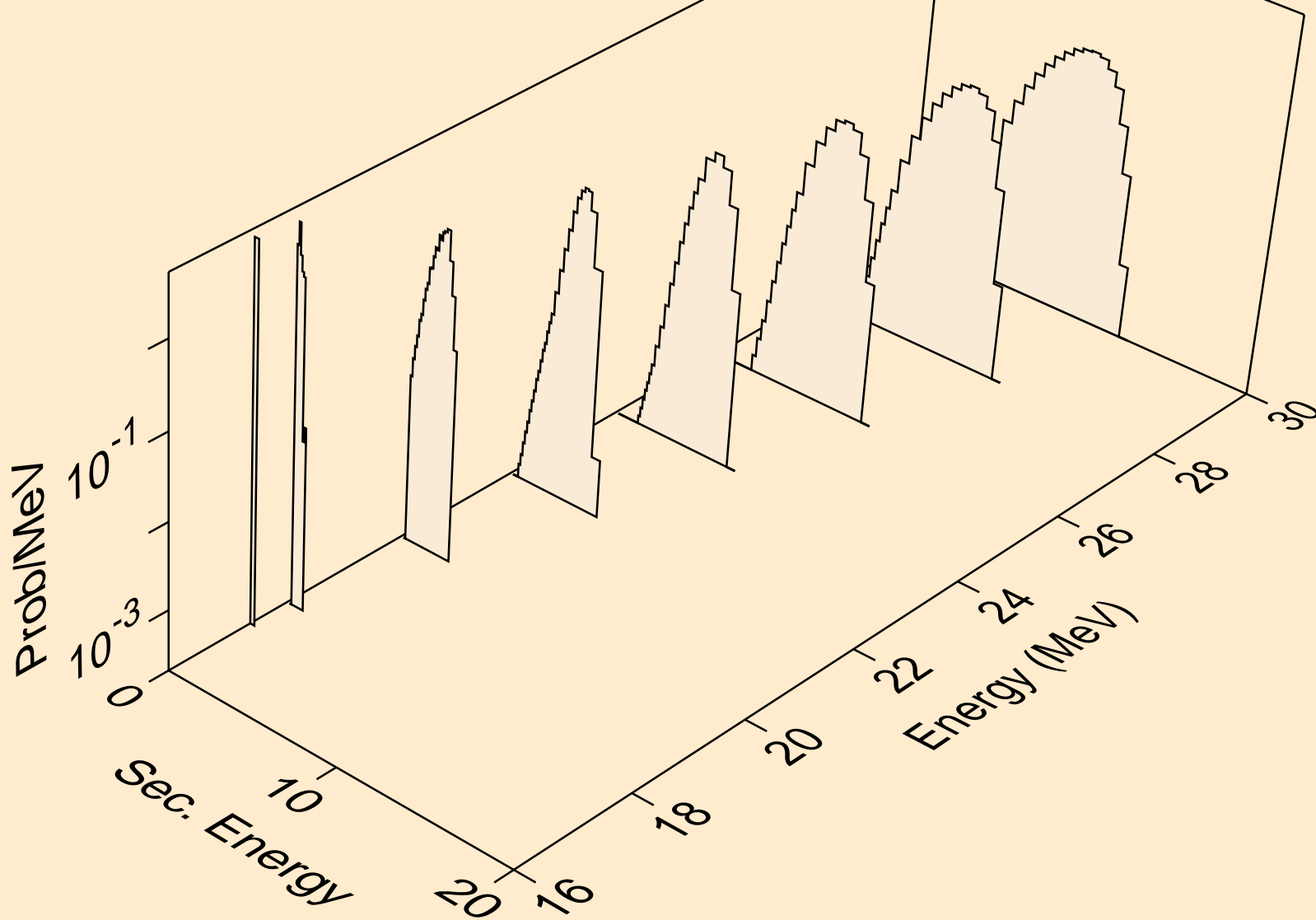

EU153 TRITON ACER TENDL-2023 LIBRARY; T=0.K
protons from (t,n2p)

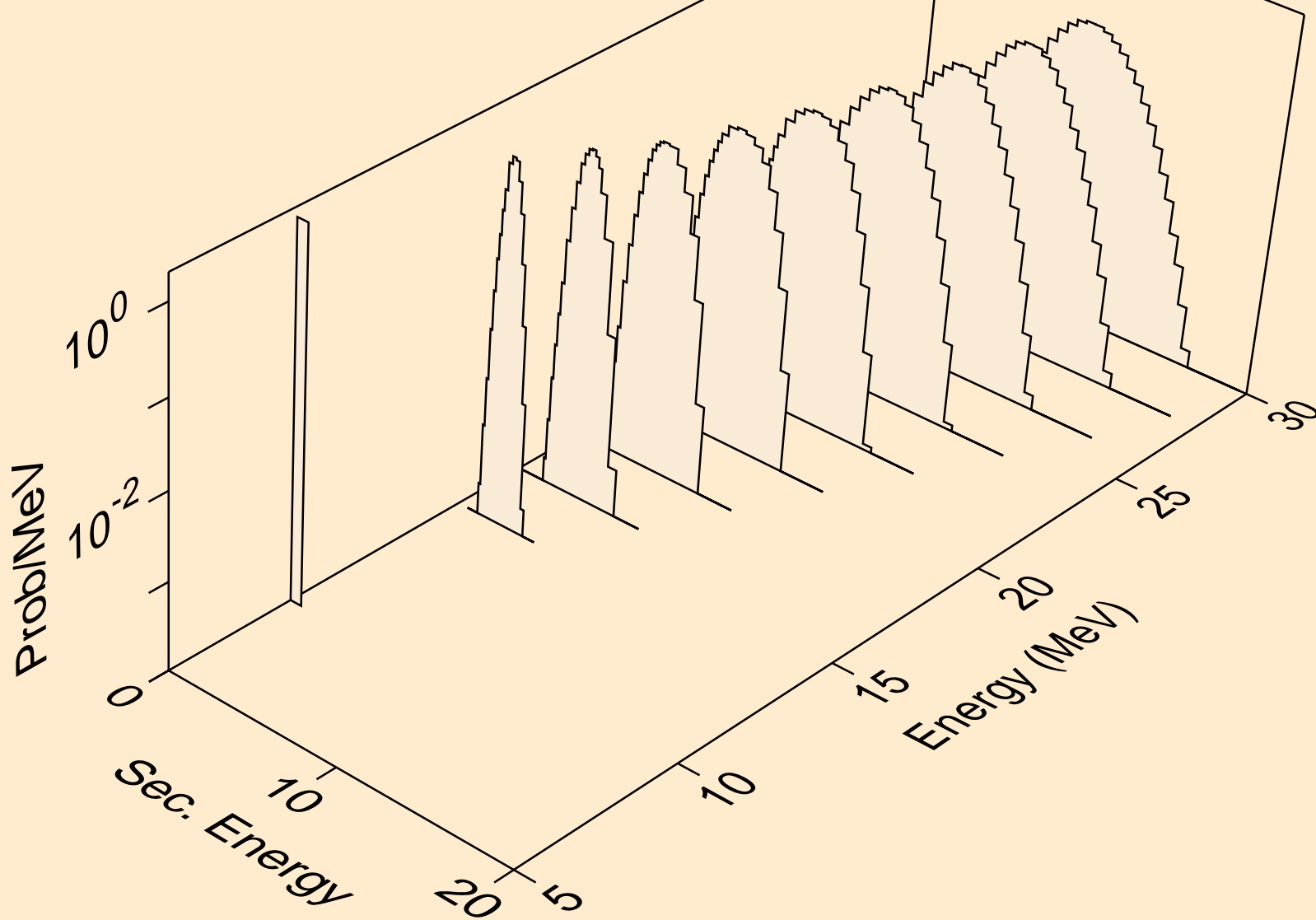

EU153 TRITON ACER TENDL-2023 LIBRARY; T=0.K
protons from (t,npa)

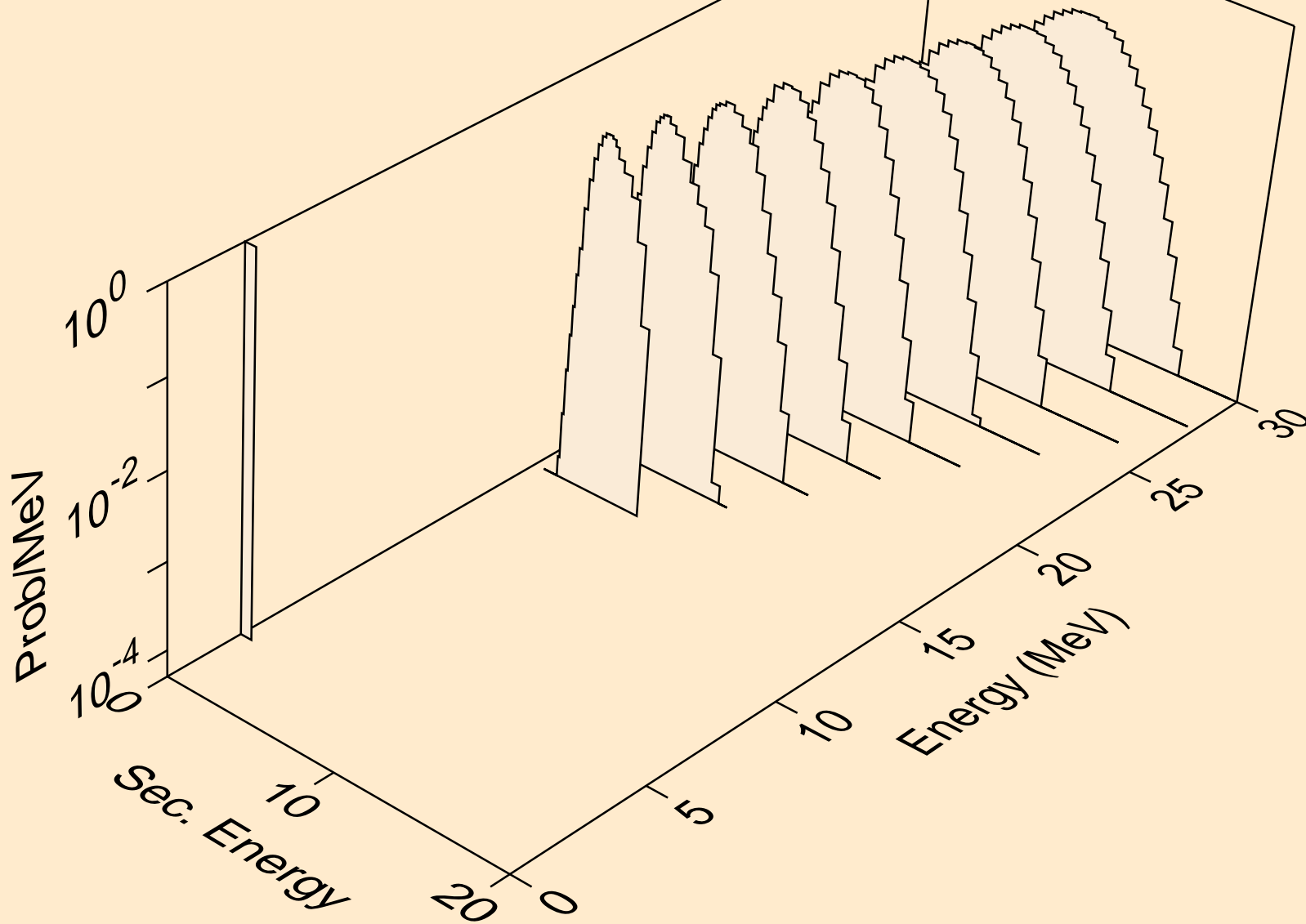

EU153 TRITON ACER TENDL-2023 LIBRARY; T=0.K
protons from (t,p)

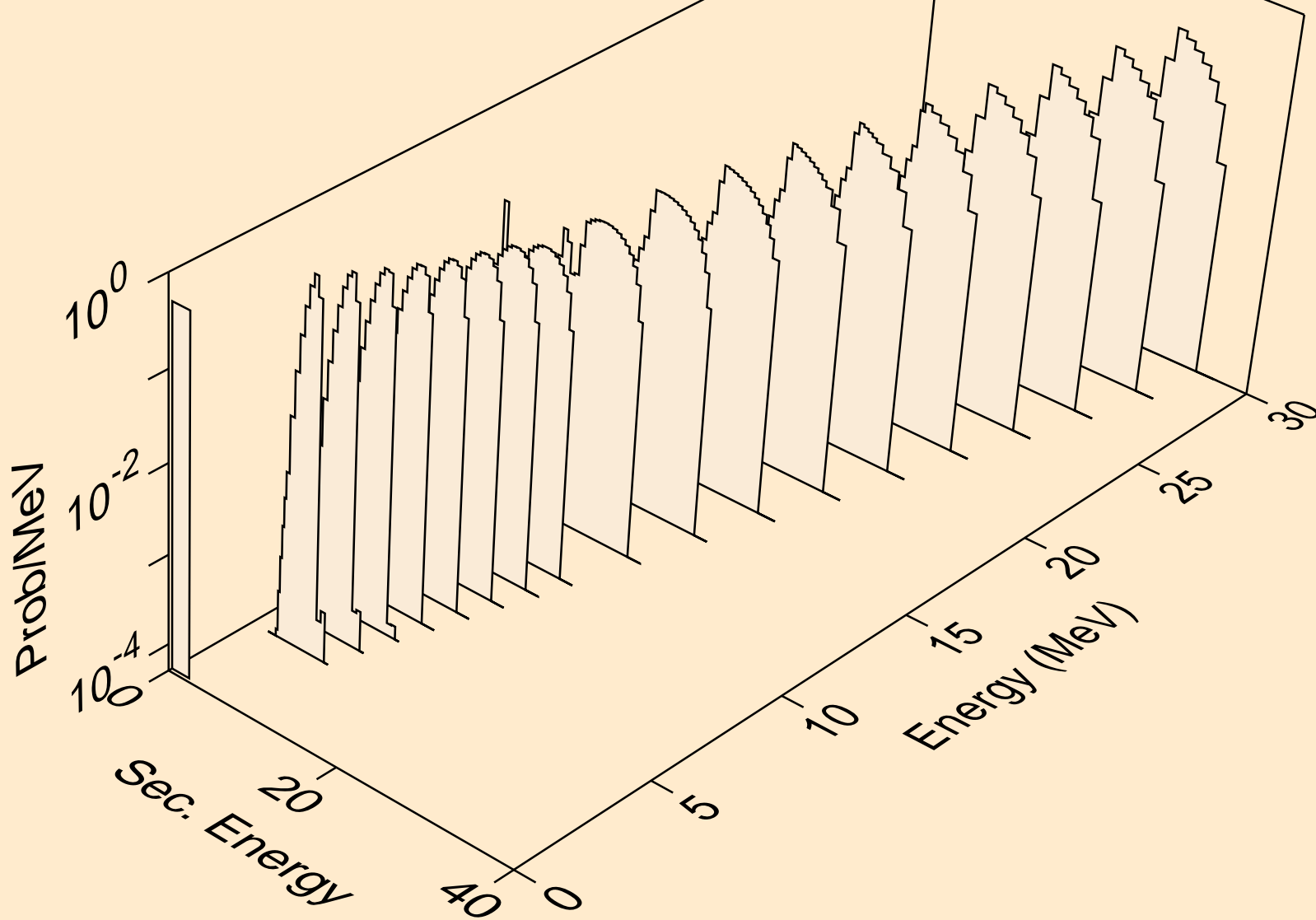

EU153 TRITON ACER TENDL-2023 LIBRARY; T=0.K
protons from (t,2p)

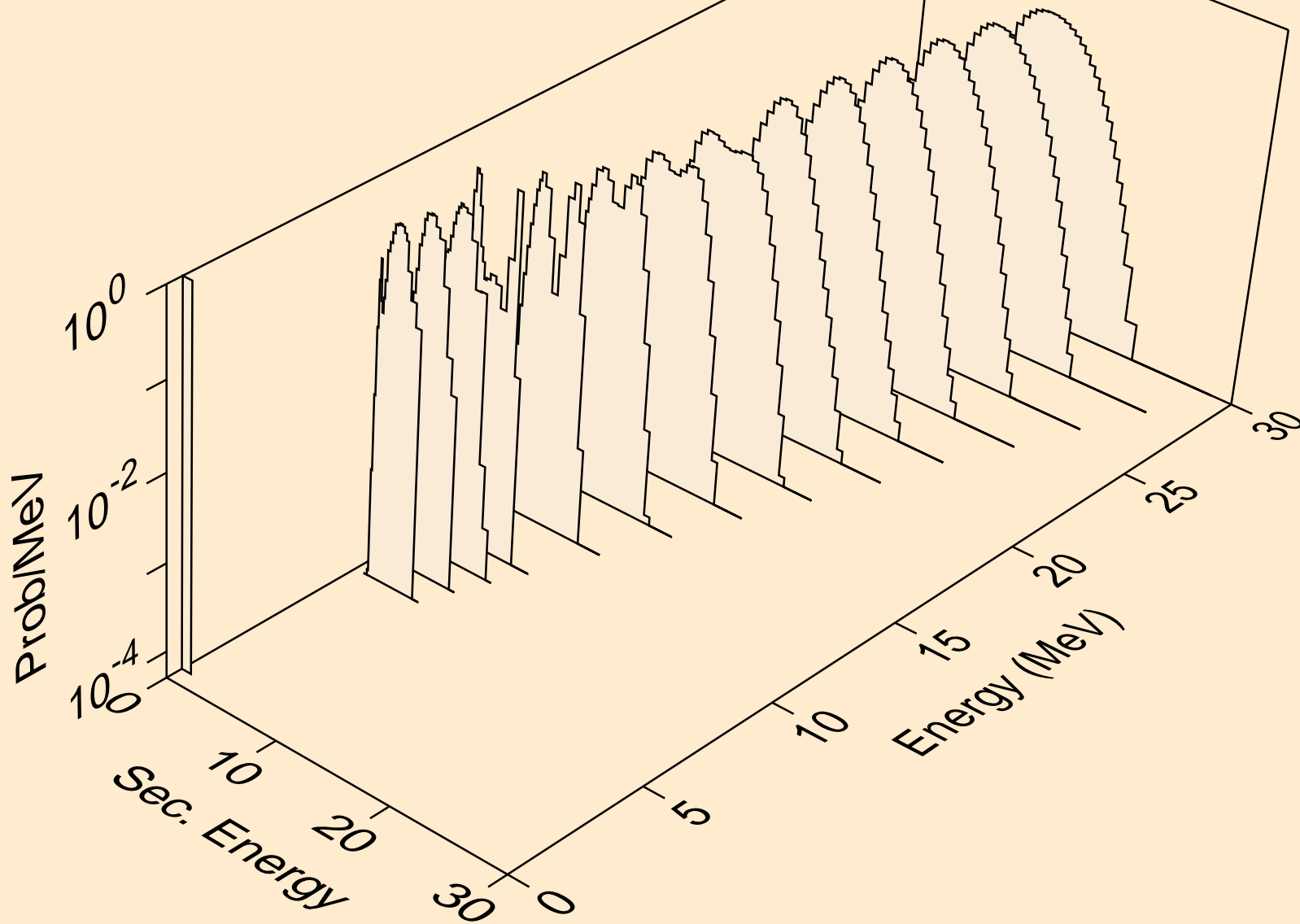

EU153 TRITON ACER TENDL-2023 LIBRARY; T=0.K
protons from (t,pa)

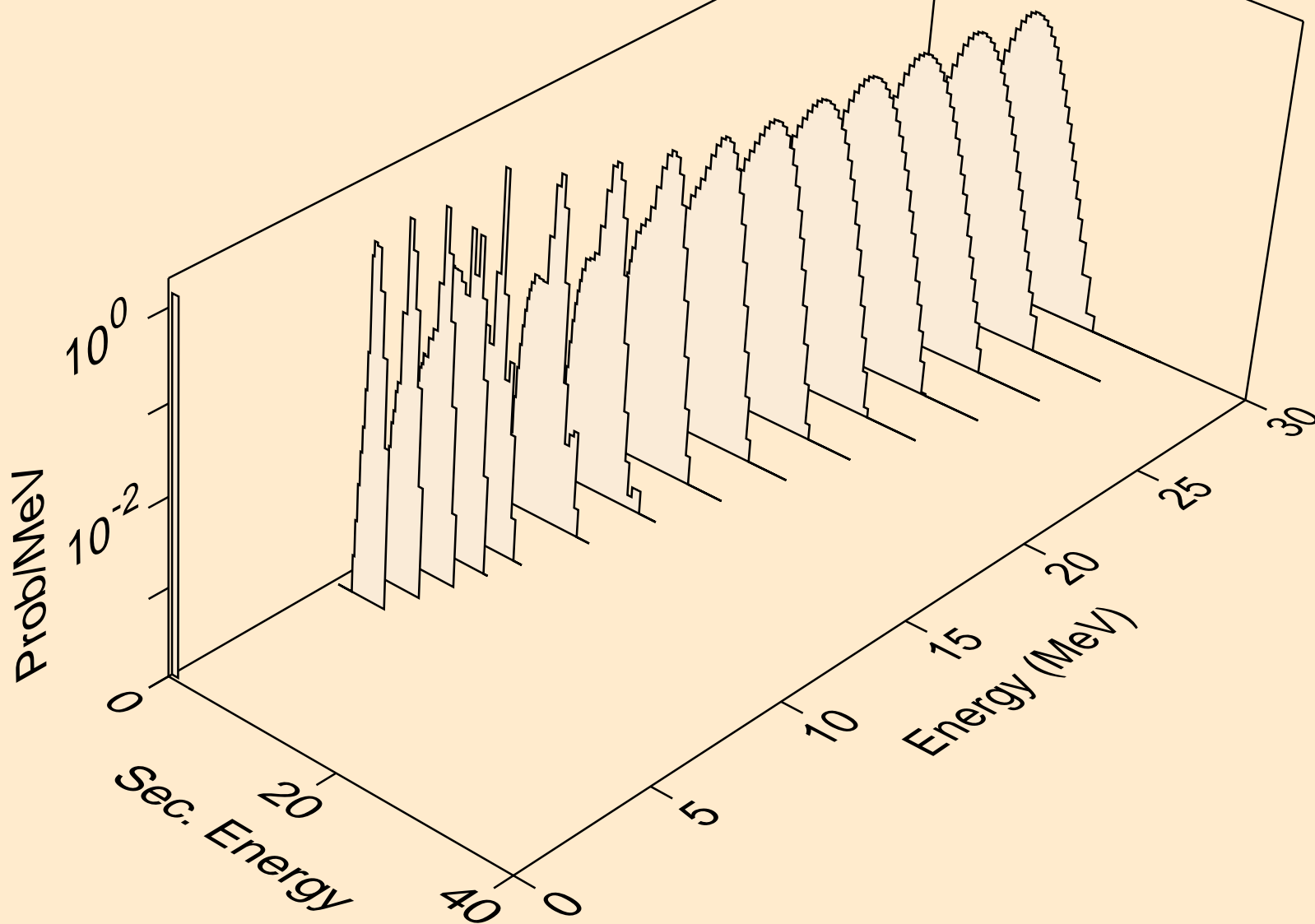

EU153 TRITON ACER TENDL-2023 LIBRARY; T=0.K
protons from (t,pd)

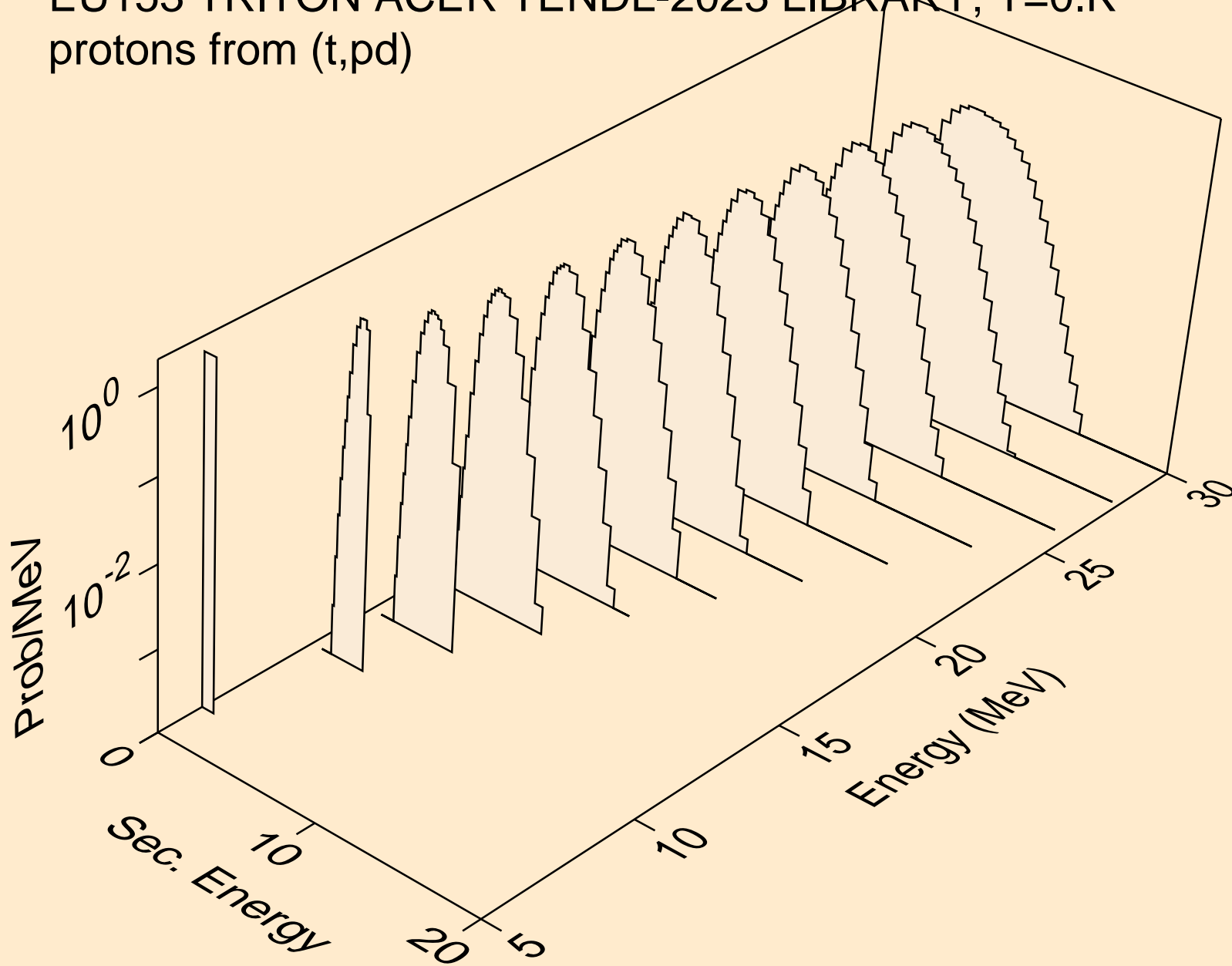

EU153 TRITON ACER TENDL-2023 LIBRARY; T=0.K
protons from (t,pt)

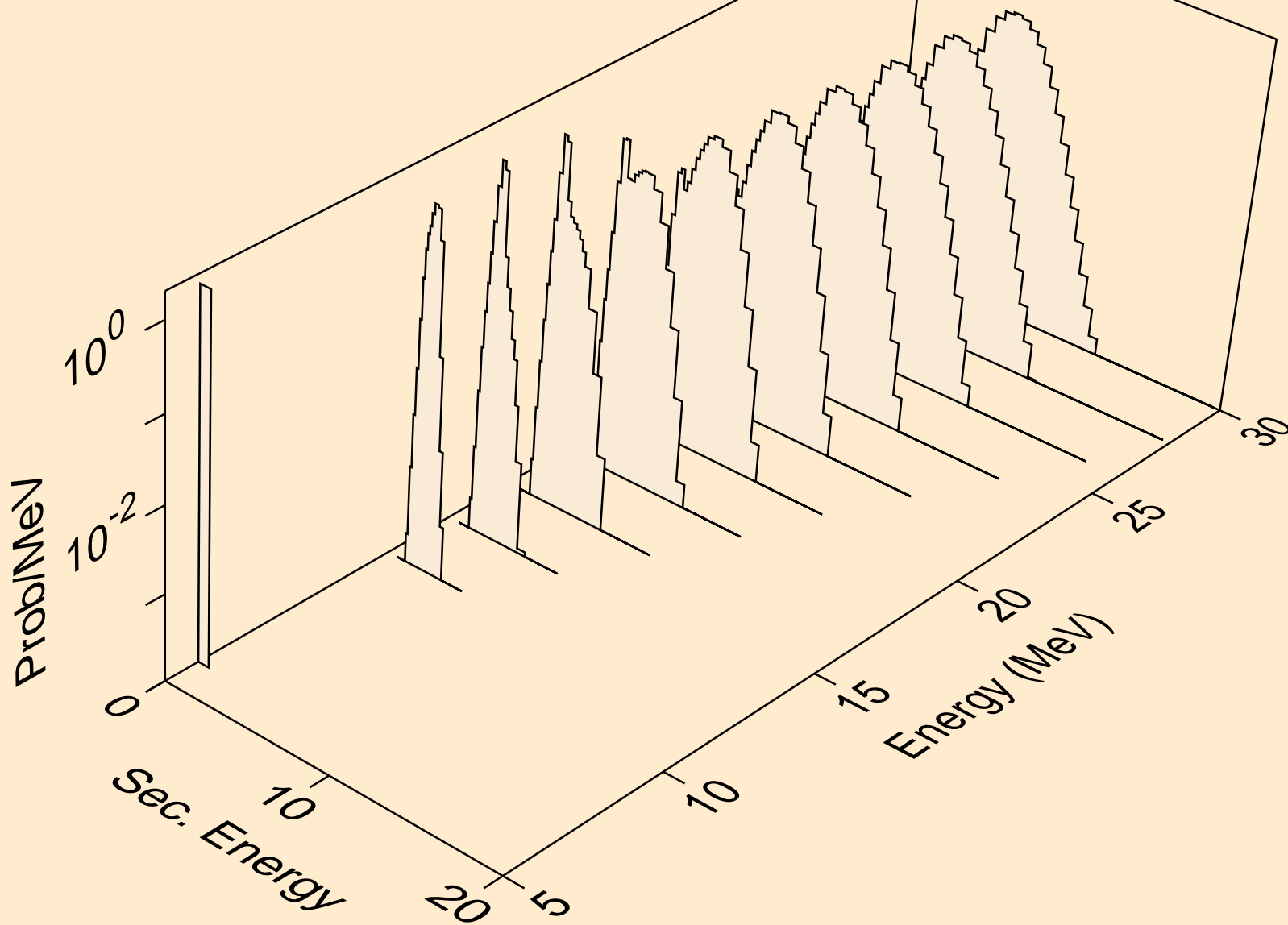

EU153 TRITON ACER TENDL-2023 LIBRARY; T=0.K
deuterons from (t,x)

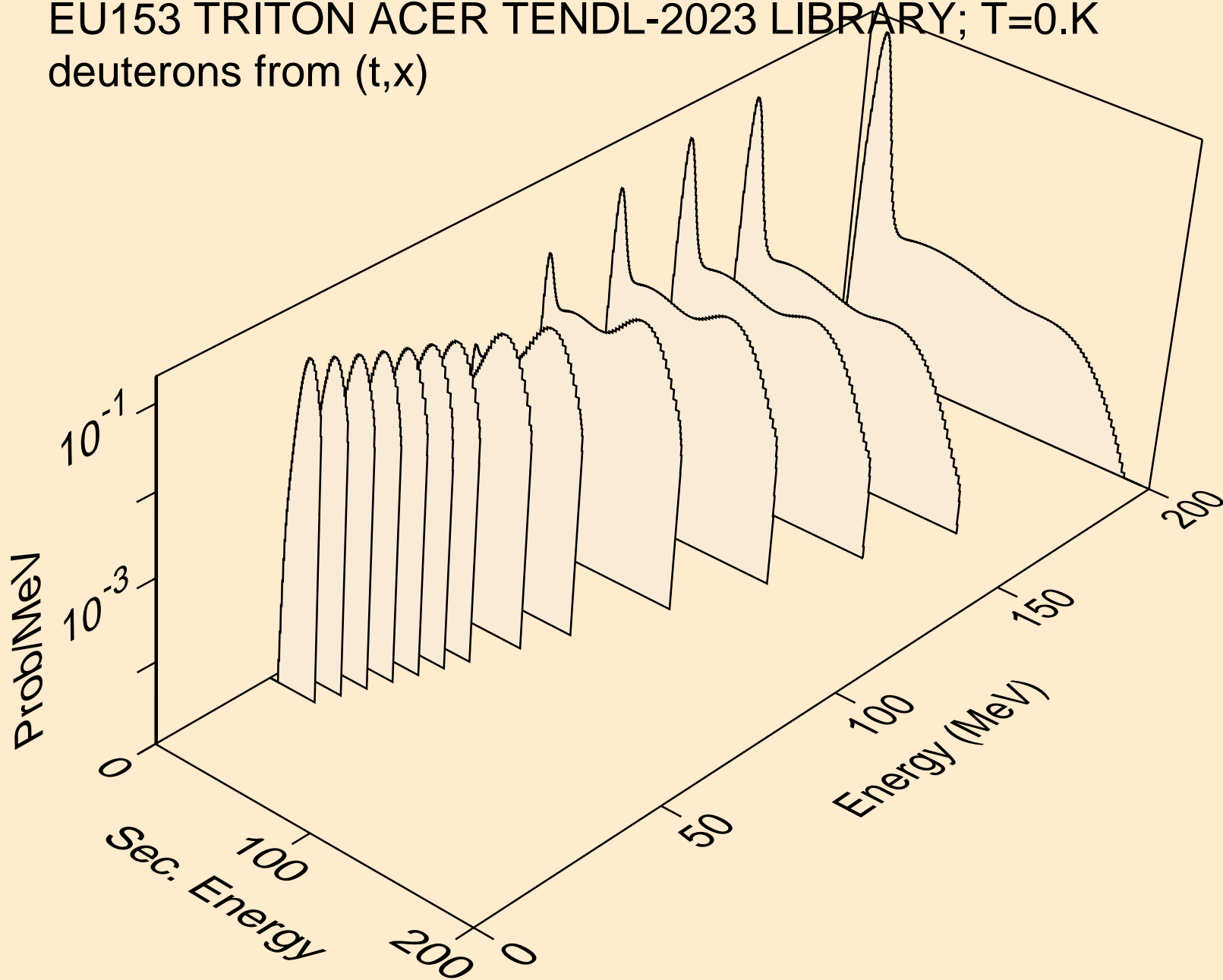

EU153 TRITON ACER TENDL-2023 LIBRARY; T=0.K
deuterons from (t,2nd)

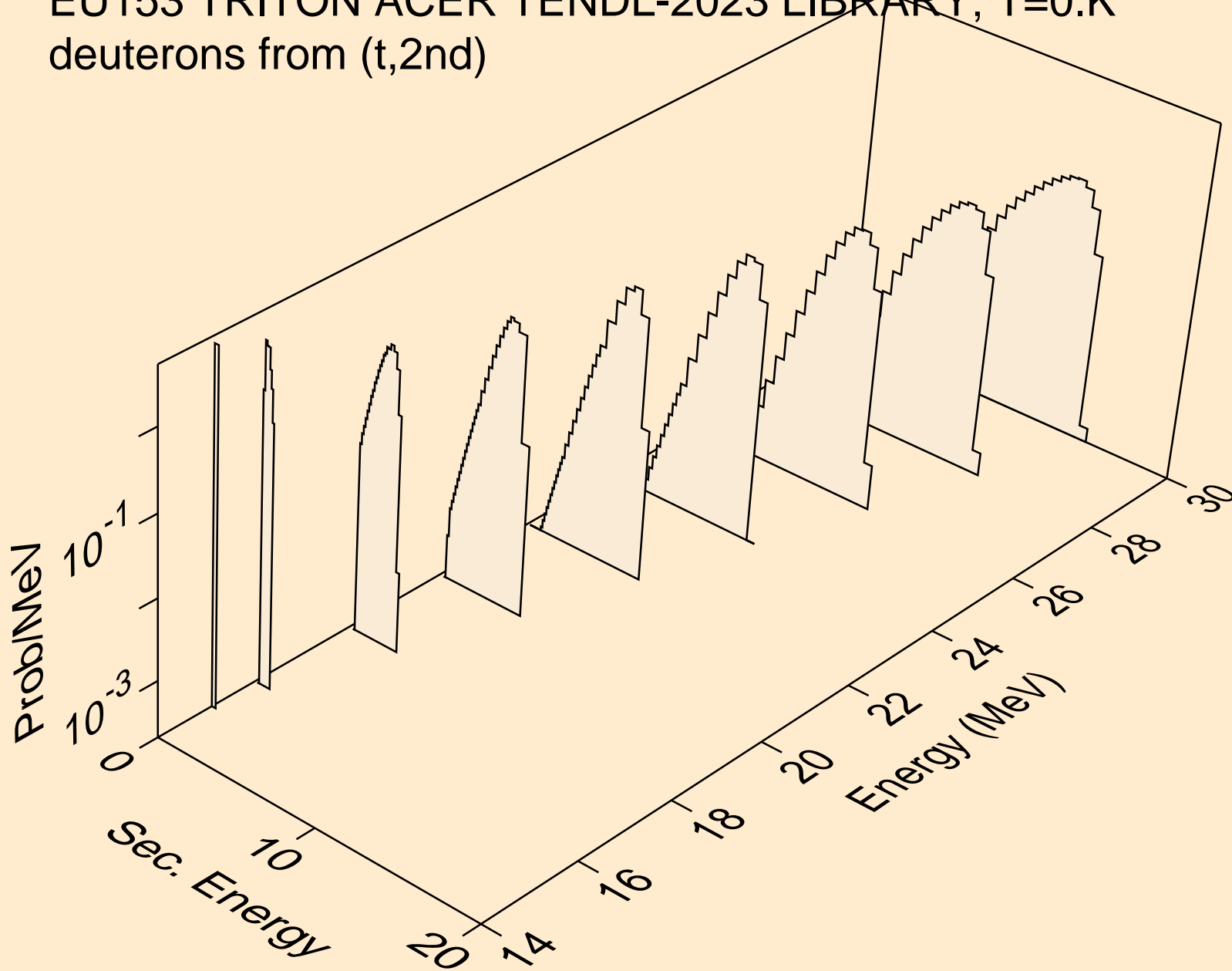

EU153 TRITON ACER TENDL-2023 LIBRARY; T=0.K
deuterons from (t,n*)d

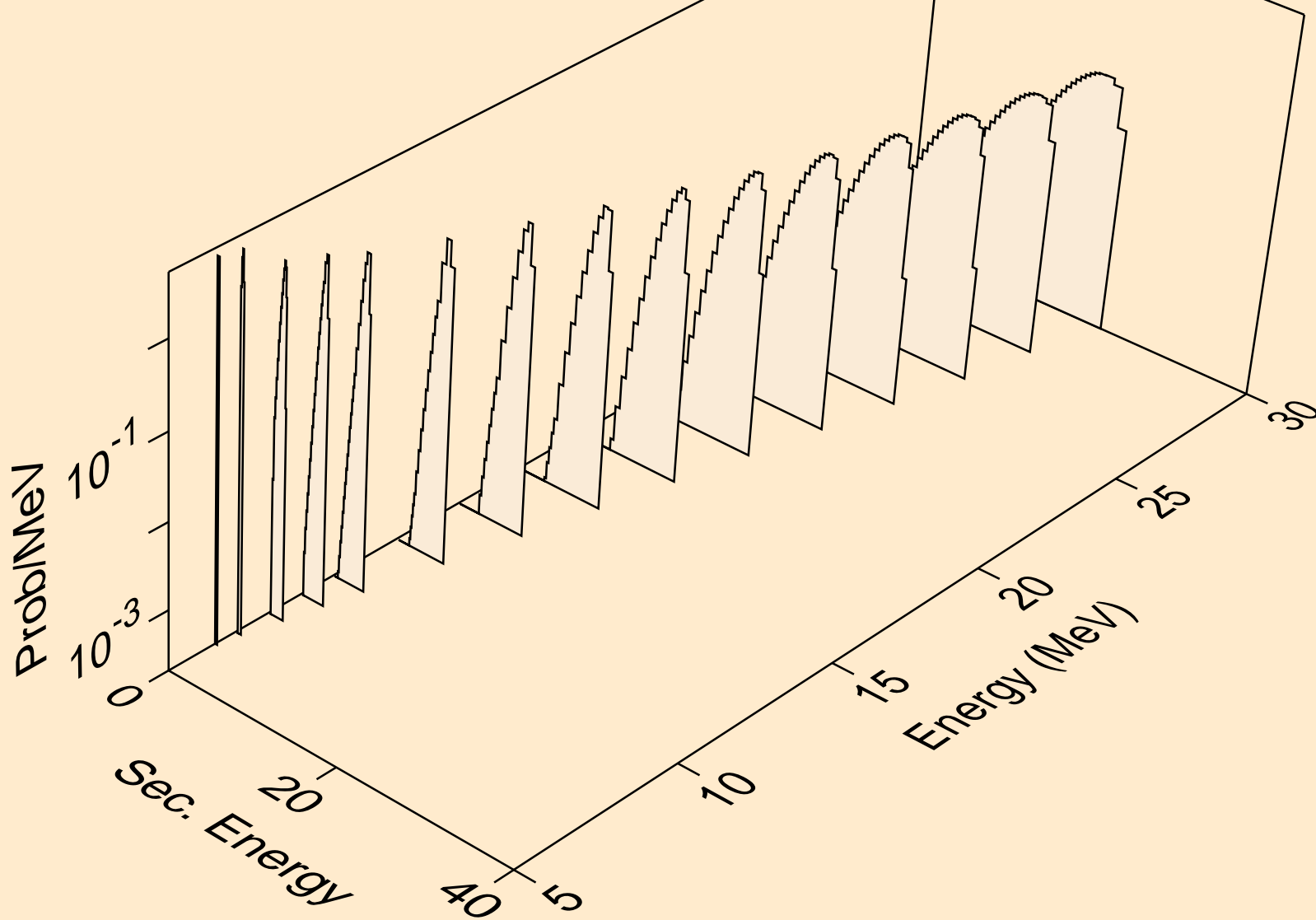

EU153 TRITON ACER TENDL-2023 LIBRARY; T=0.K
deuterons from (t,d)

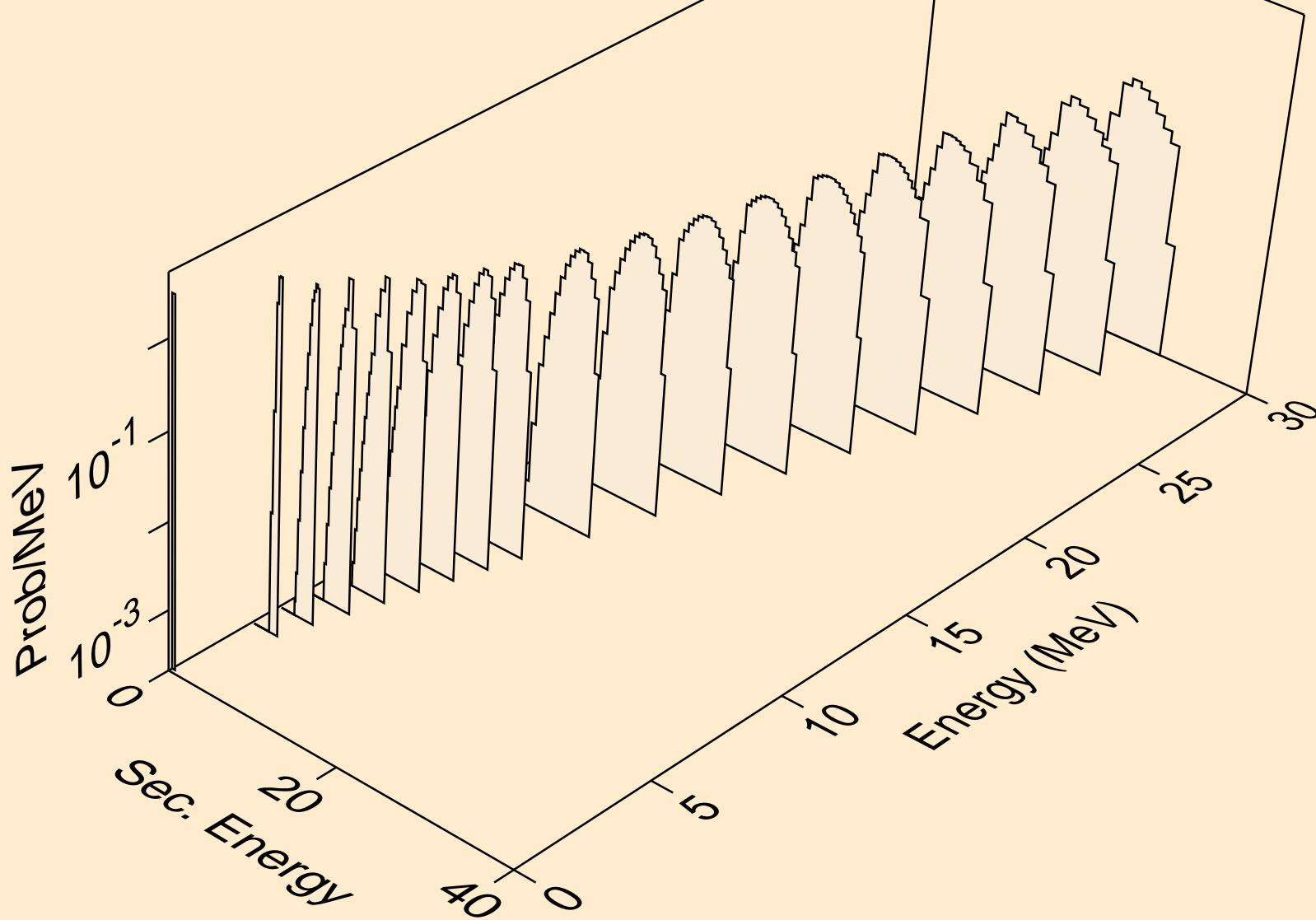

EU153 TRITON ACER TENDL-2023 LIBRARY; T=0.K
deuterons from (t,pd)

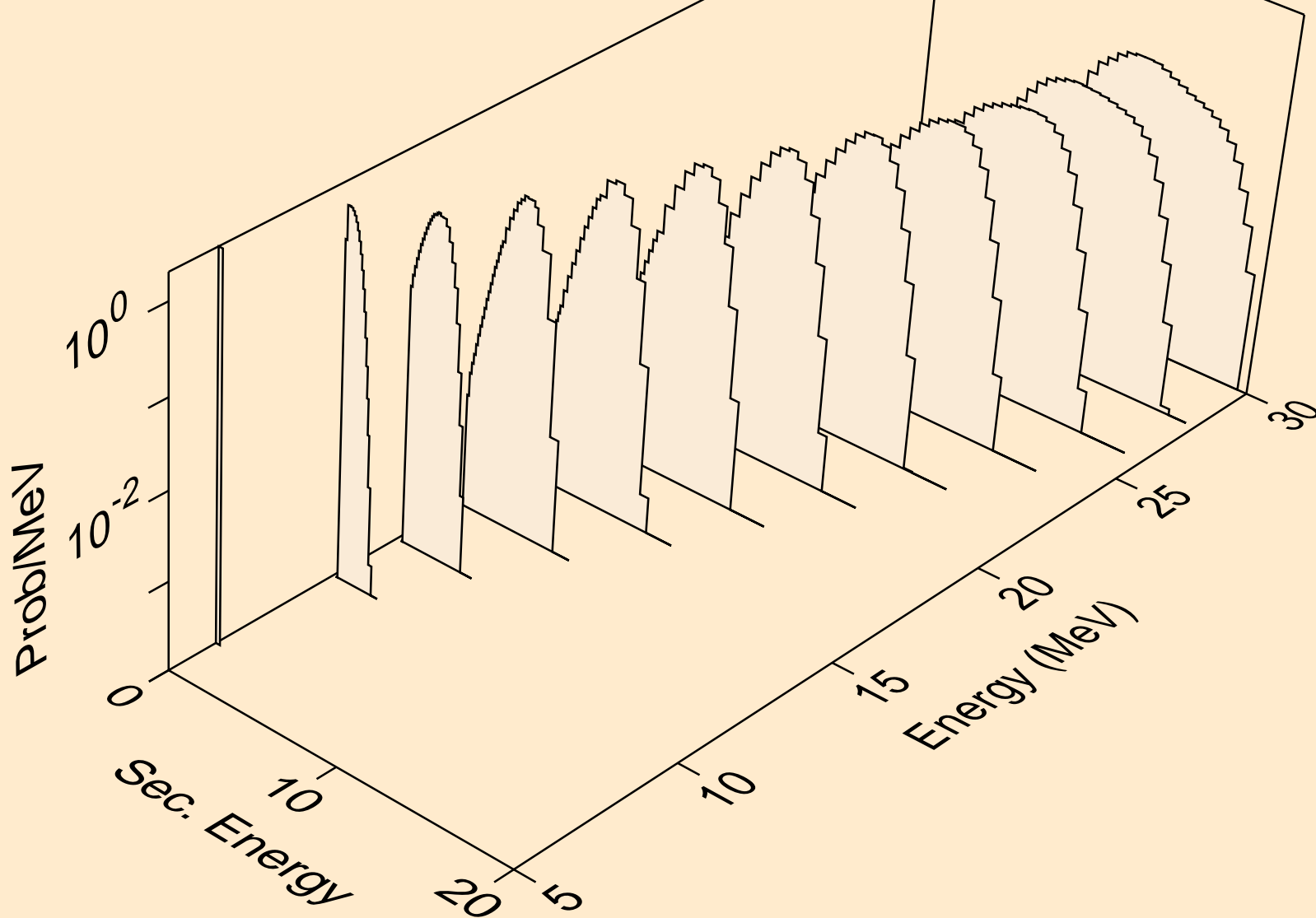

EU153 TRITON ACER TENDL-2023 LIBRARY; T=0.K
deuterons from (t,da)

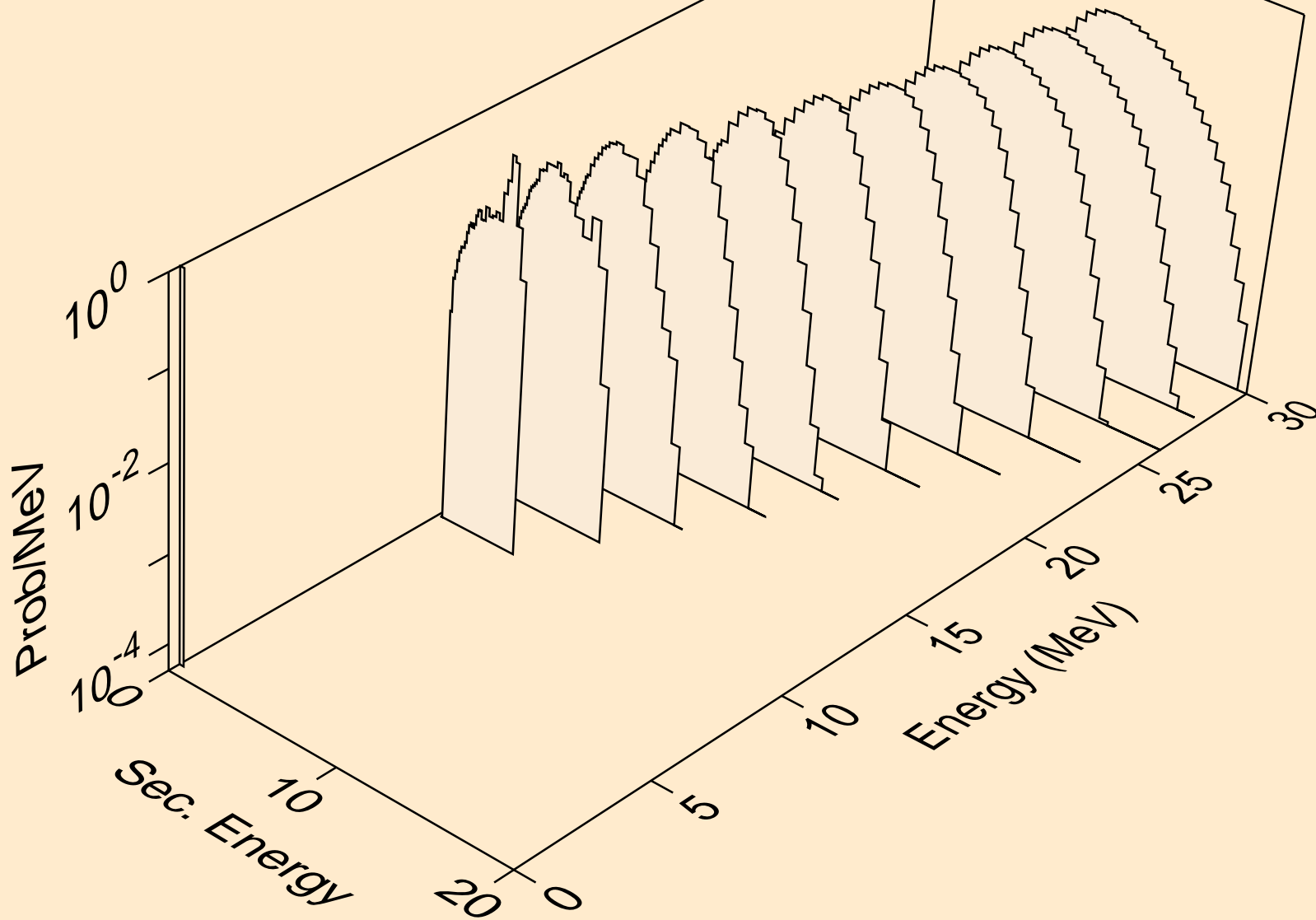

EU153 TRITON ACER TENDL-2023 LIBRARY; T=0.K
he3s from (t,x)

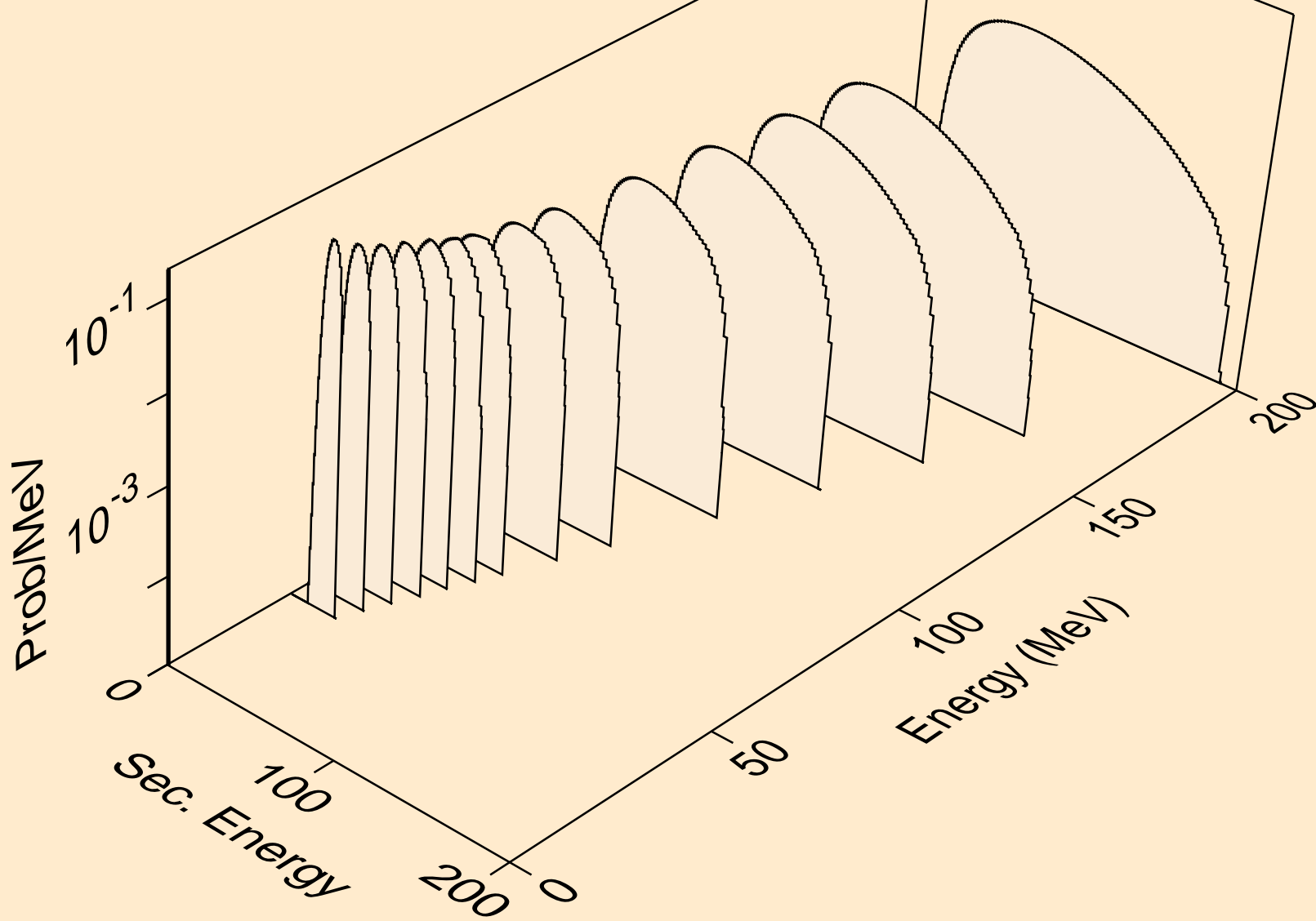

EU153 TRITON ACER TENDL-2023 LIBRARY; T=0.K
he3s from (t,n*)he3

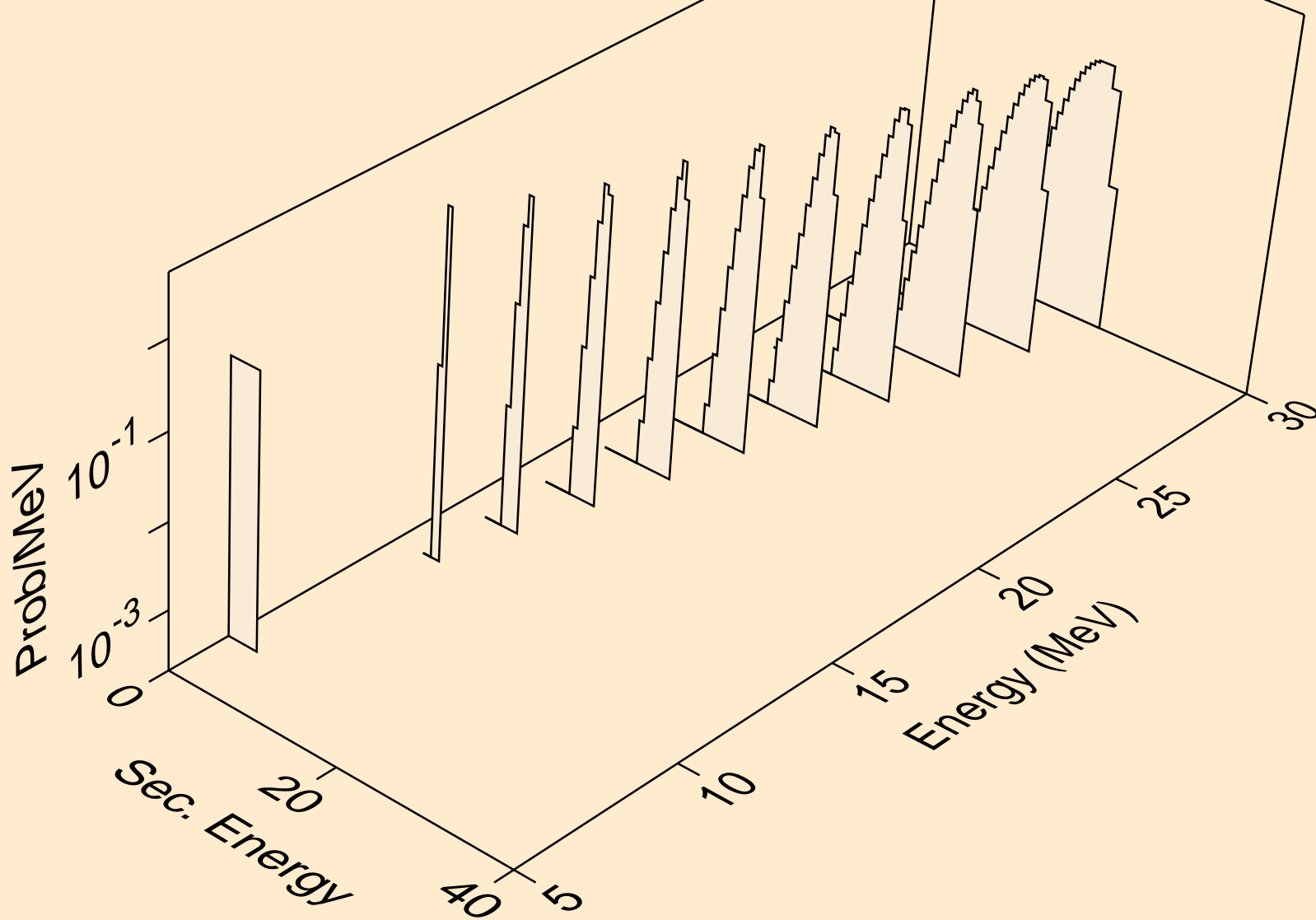

EU153 TRITON ACER TENDL-2023 LIBRARY; T=0.K
he3s from (t,he3)

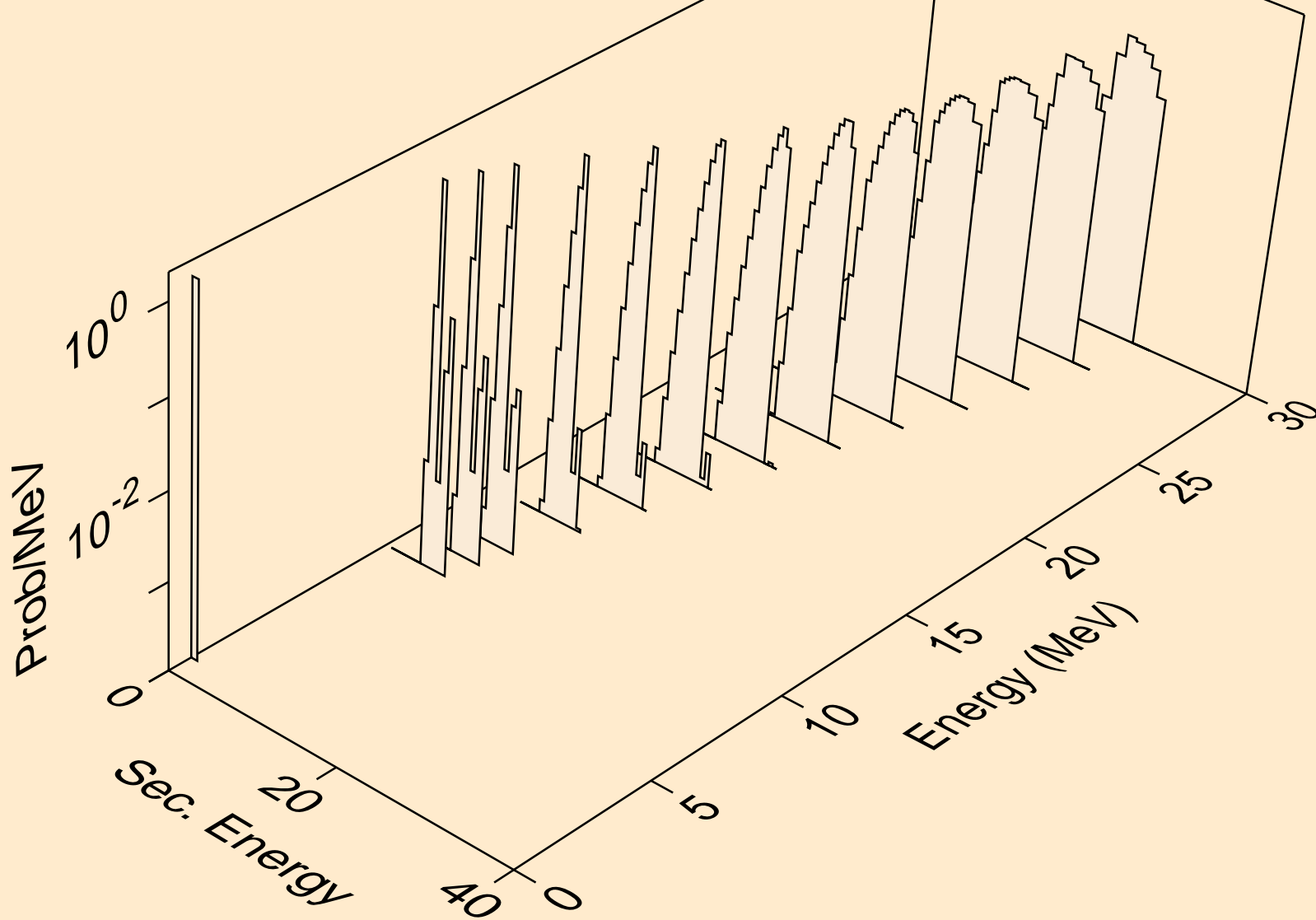

EU153 TRITON ACER TENDL-2023 LIBRARY; T=0.K
alphas from (t,x)

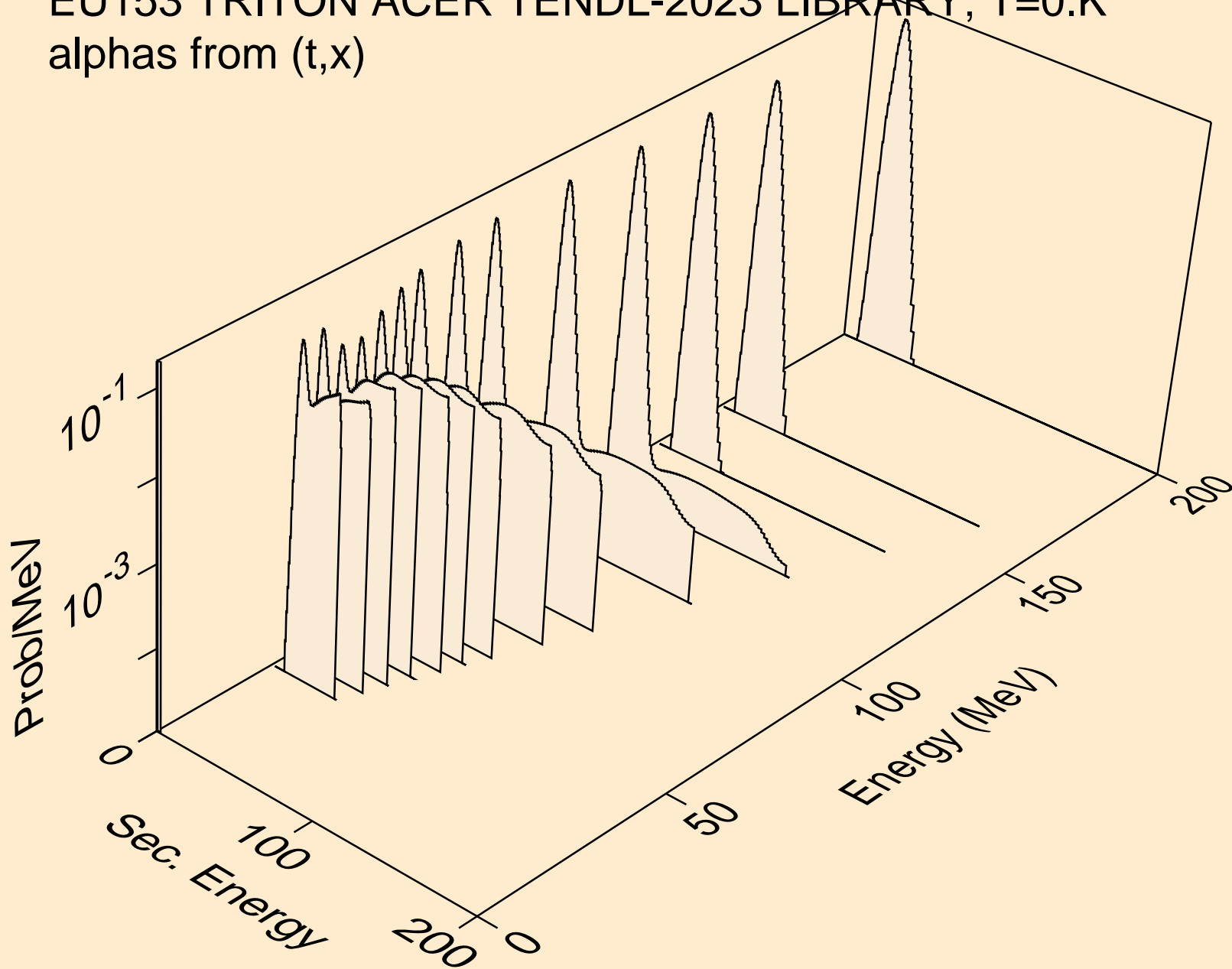

EU153 TRITON ACER TENDL-2023 LIBRARY; T=0.K
alphas from (t,n*)a

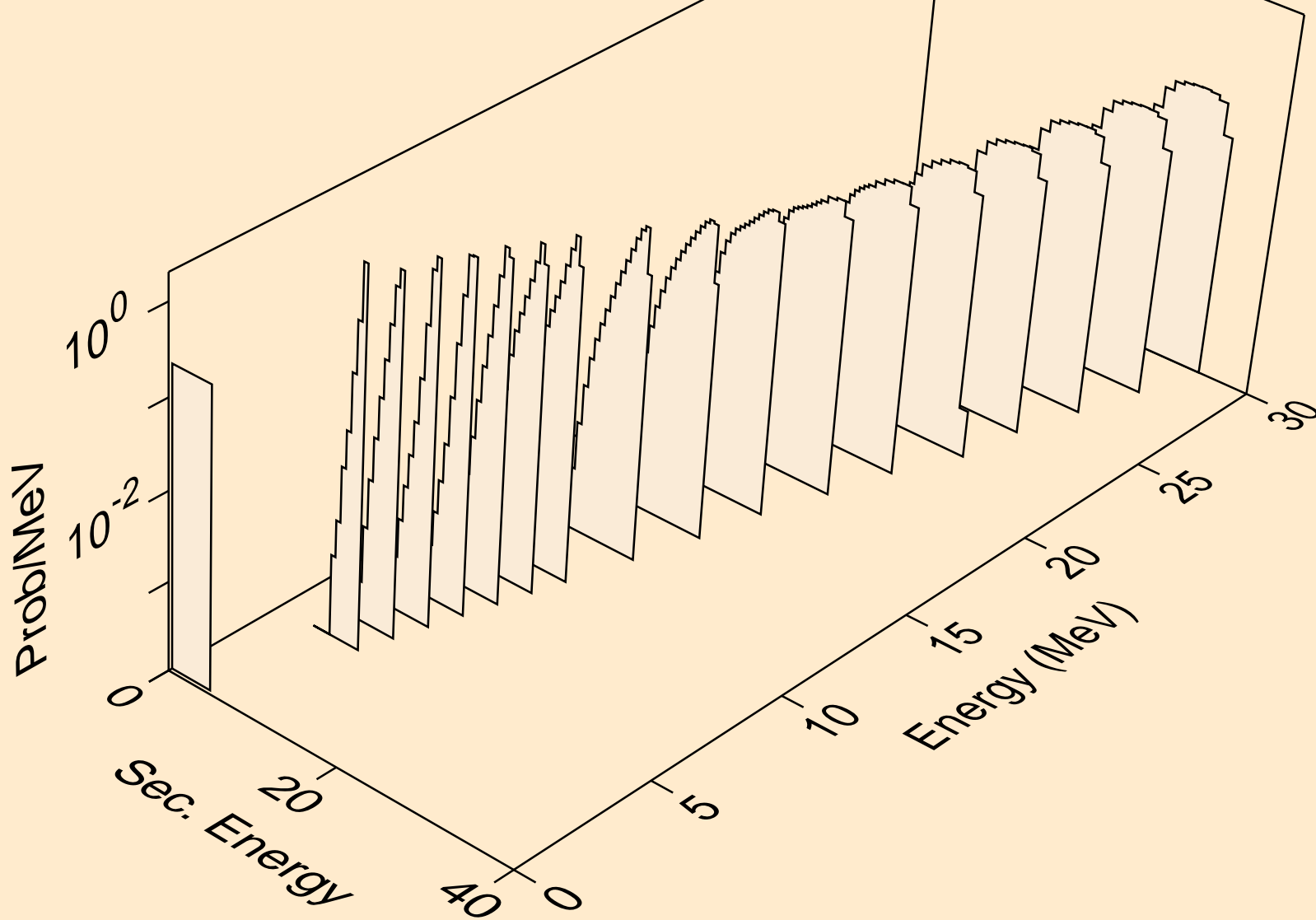

EU153 TRITON ACER TENDL-2023 LIBRARY; T=0.K
alphas from (t,2n)a

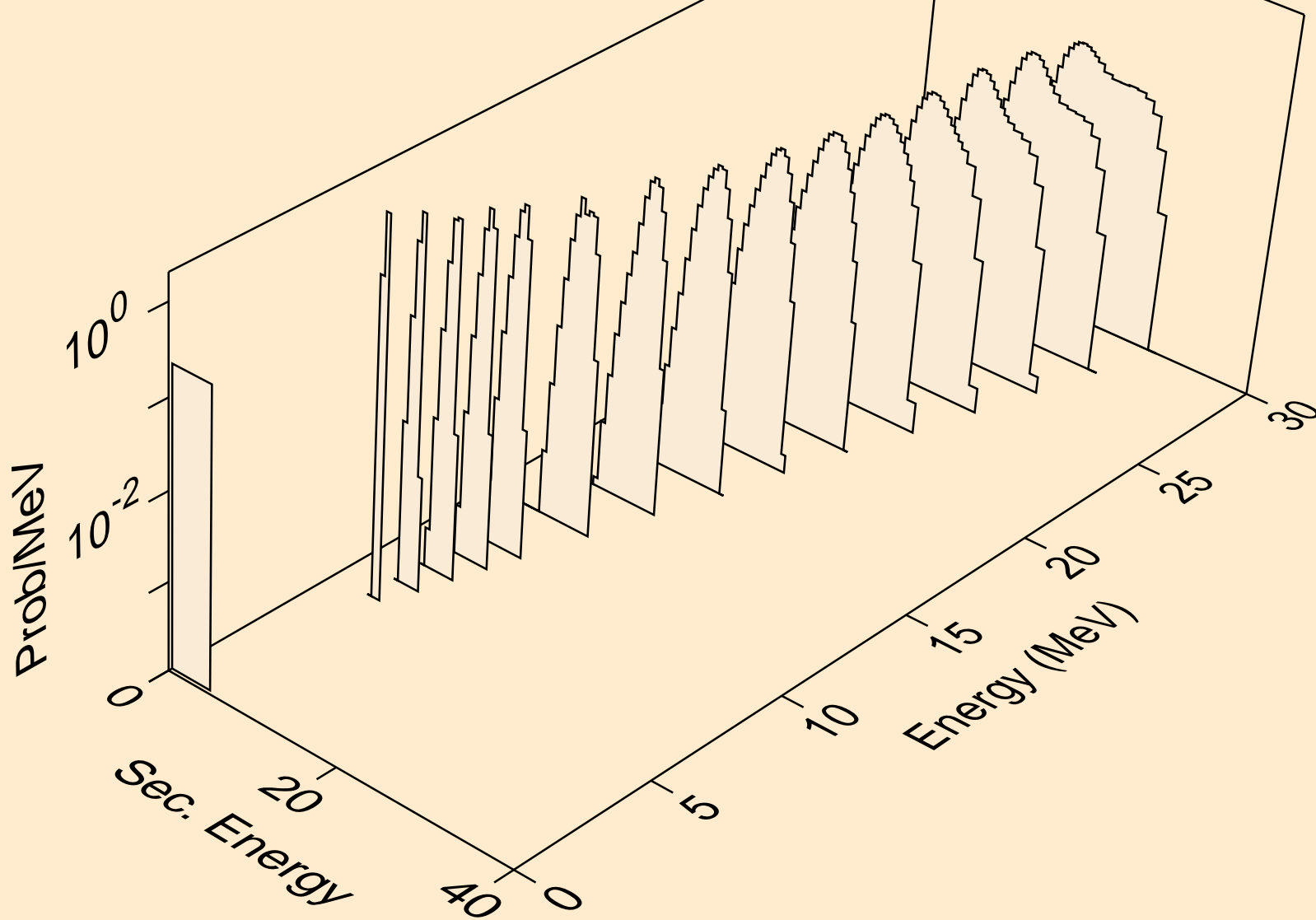

EU153 TRITON ACER TENDL-2023 LIBRARY; T=0.K
alphas from (t,3n)a

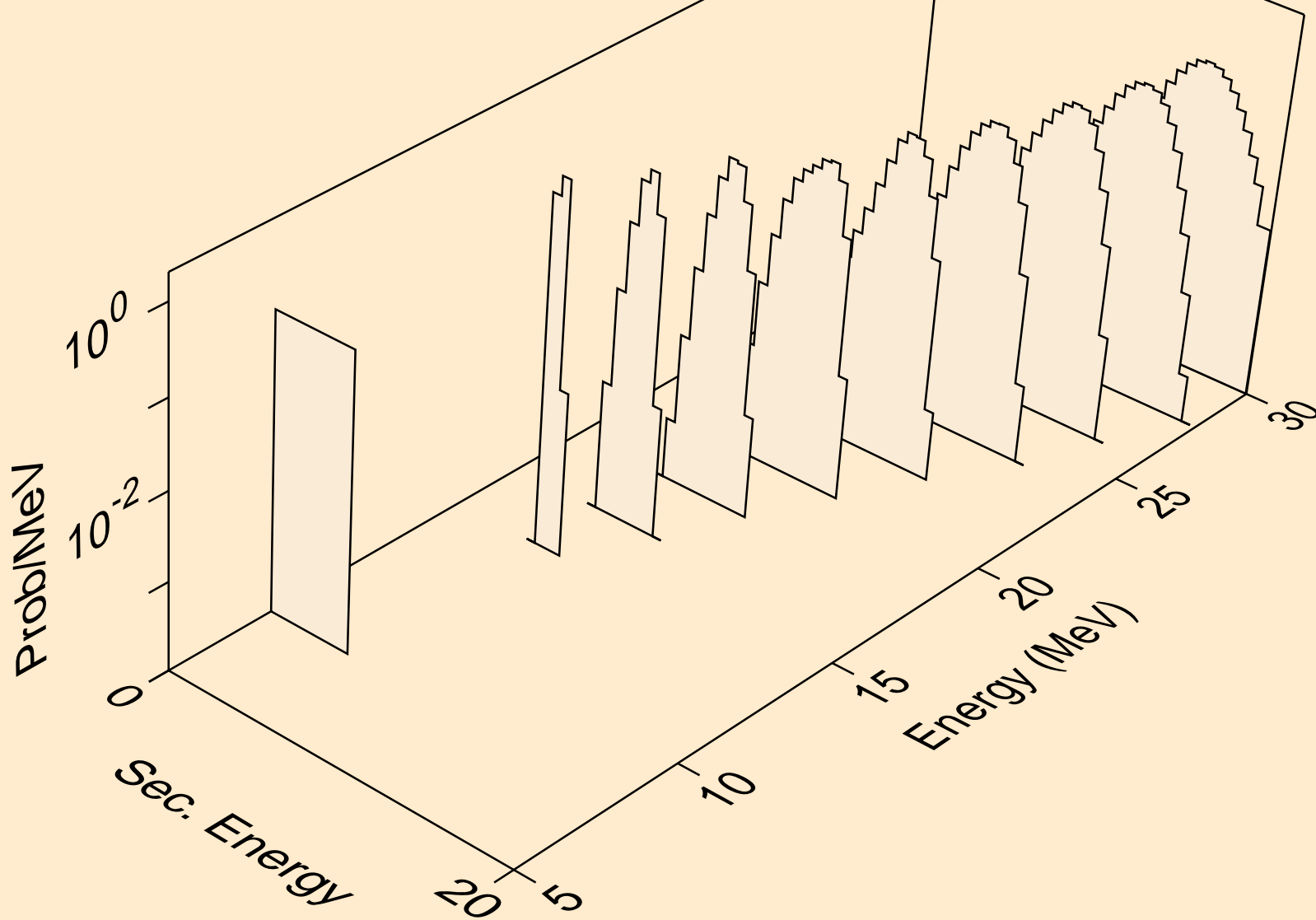

EU153 TRITON ACER TENDL-2023 LIBRARY; T=0.K
alphas from (t,n*)2a

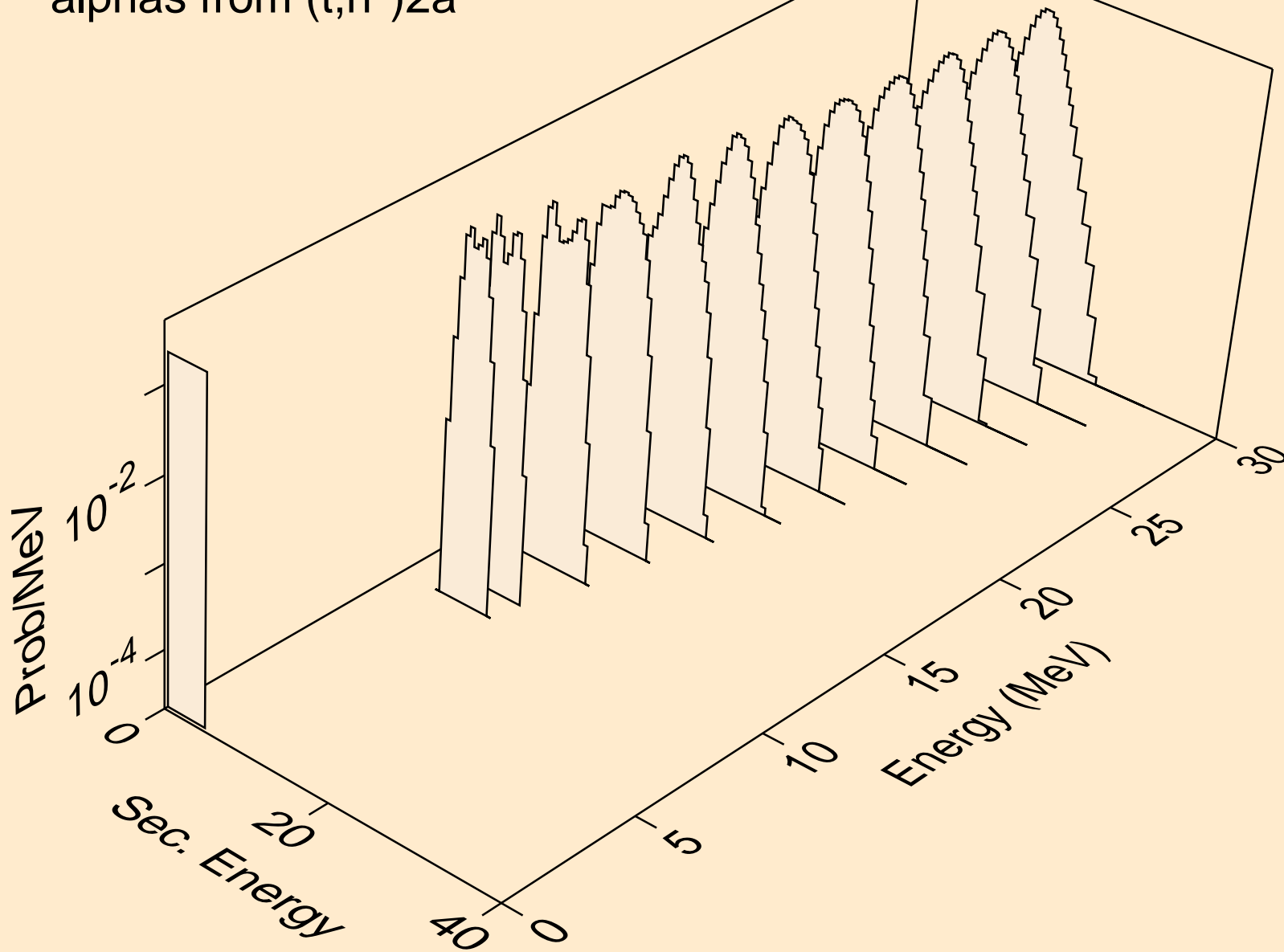

EU153 TRITON ACER TENDL-2023 LIBRARY; T=0.K
alphas from (t,2n)2a

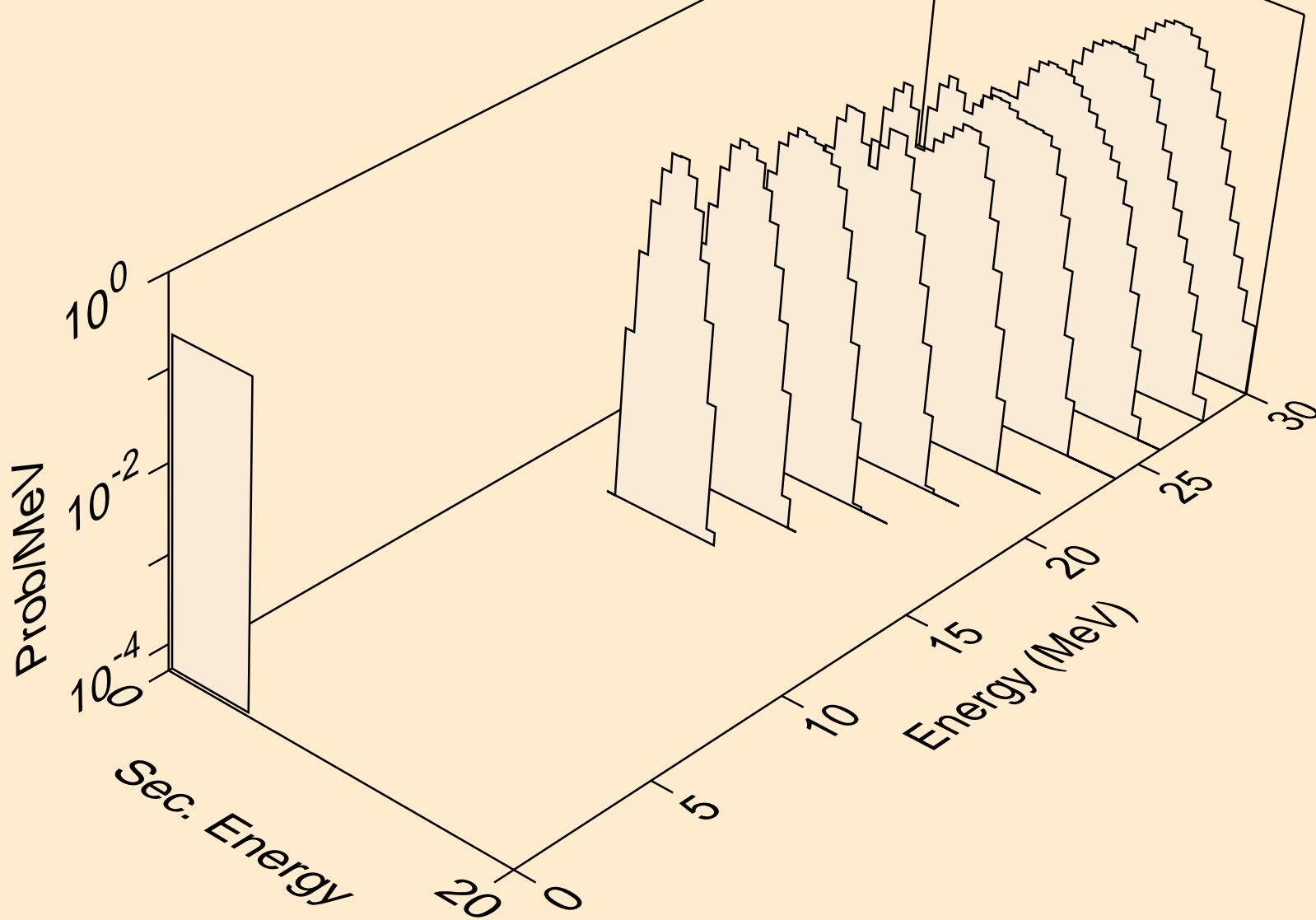

EU153 TRITON ACER TENDL-2023 LIBRARY; T=0.K
alphas from (t,npa)

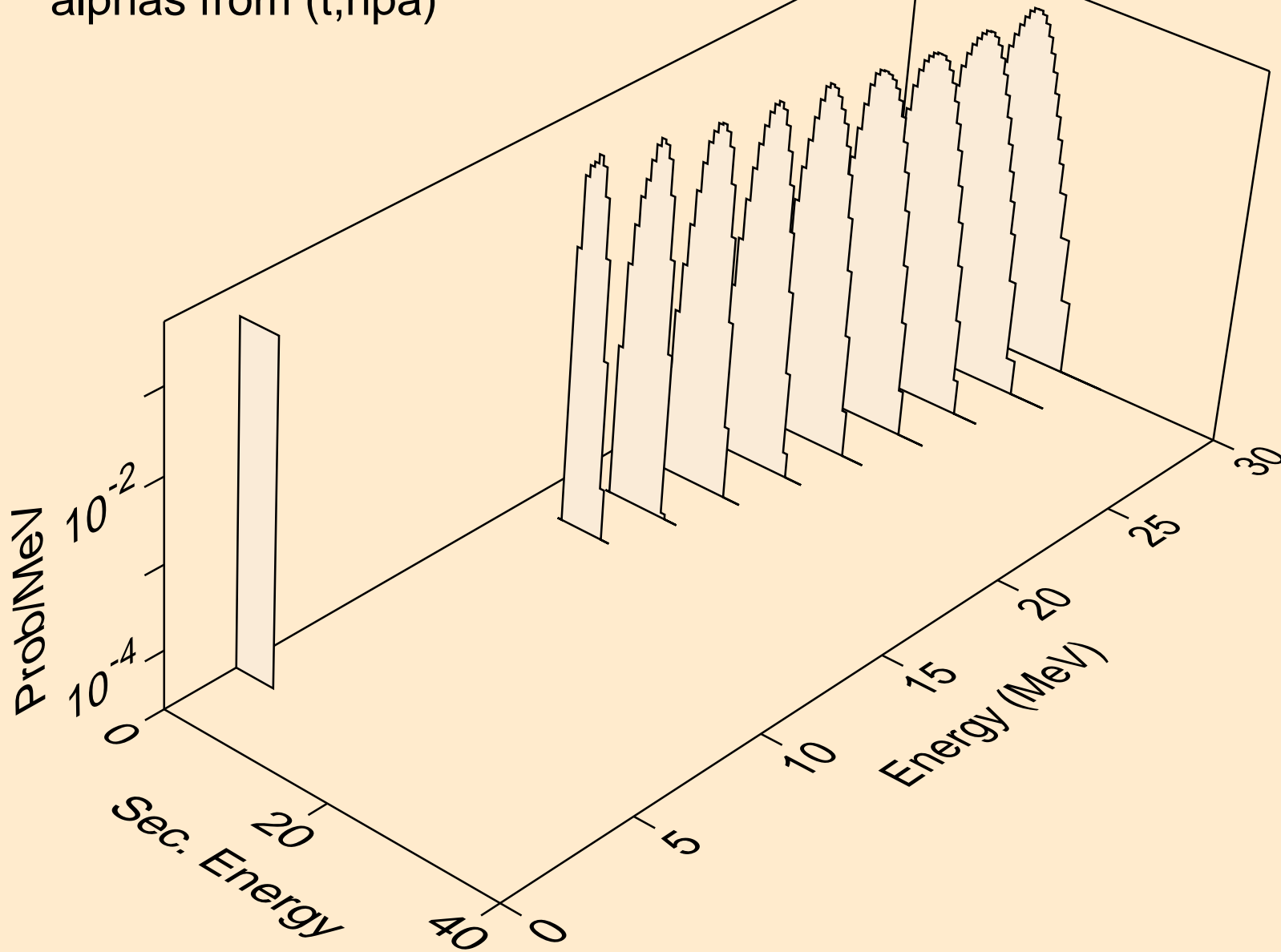

EU153 TRITON ACER TENDL-2023 LIBRARY; T=0.K
alphas from (t,a)

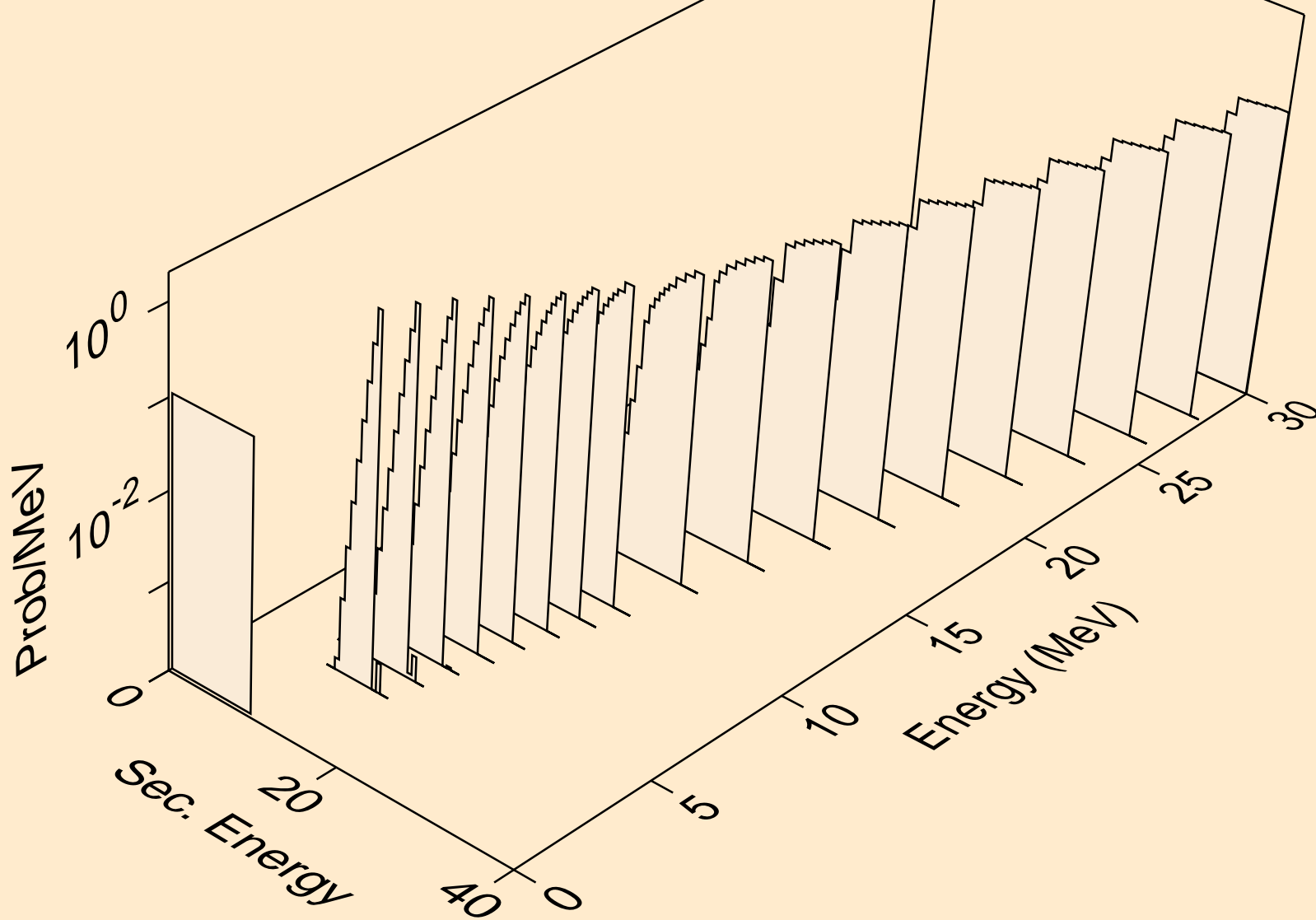

EU153 TRITON ACER TENDL-2023 LIBRARY; T=0.K
alphas from (t,2a)

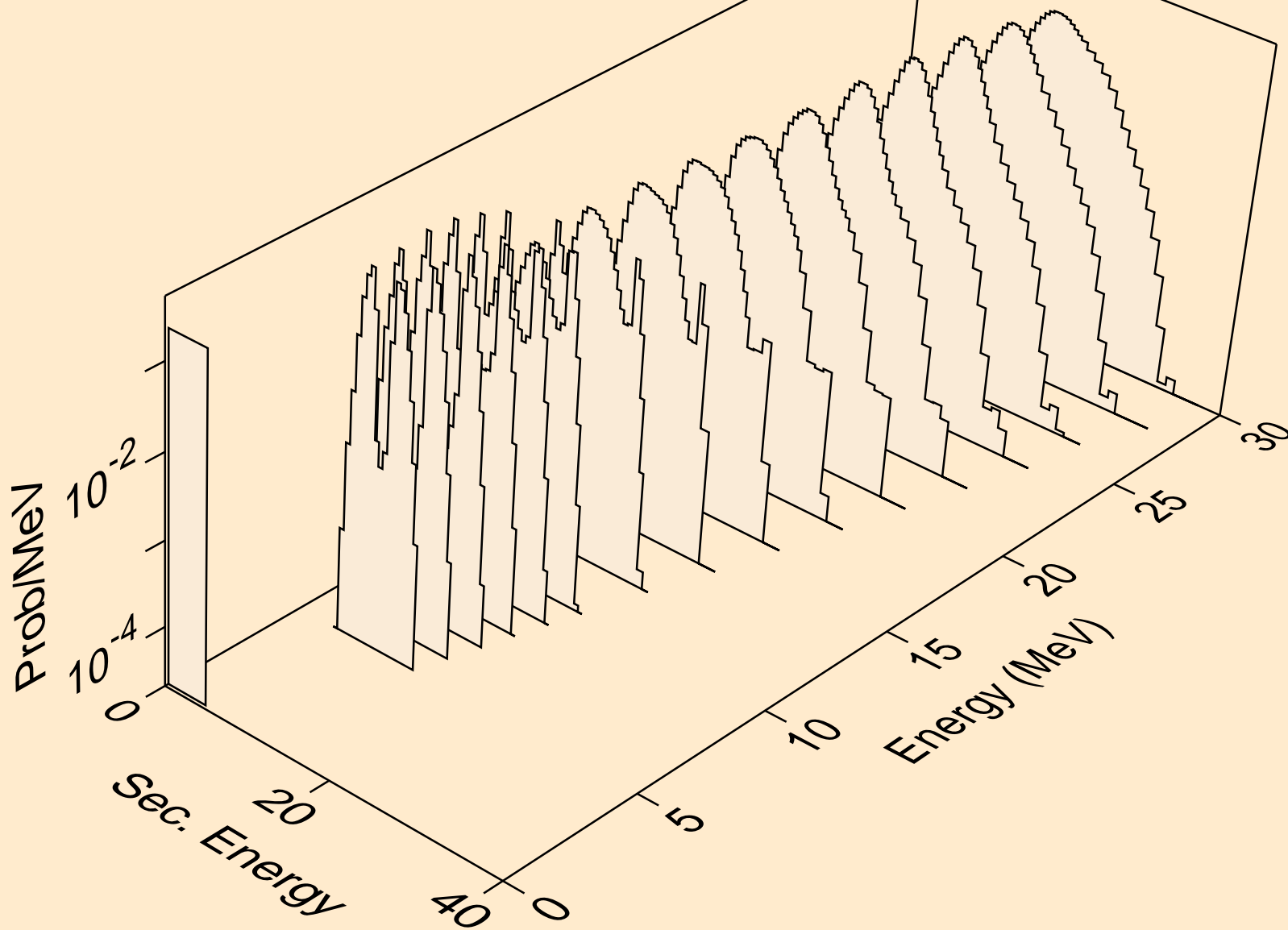

EU153 TRITON ACER TENDL-2023 LIBRARY; T=0.K
alphas from (t,pa)

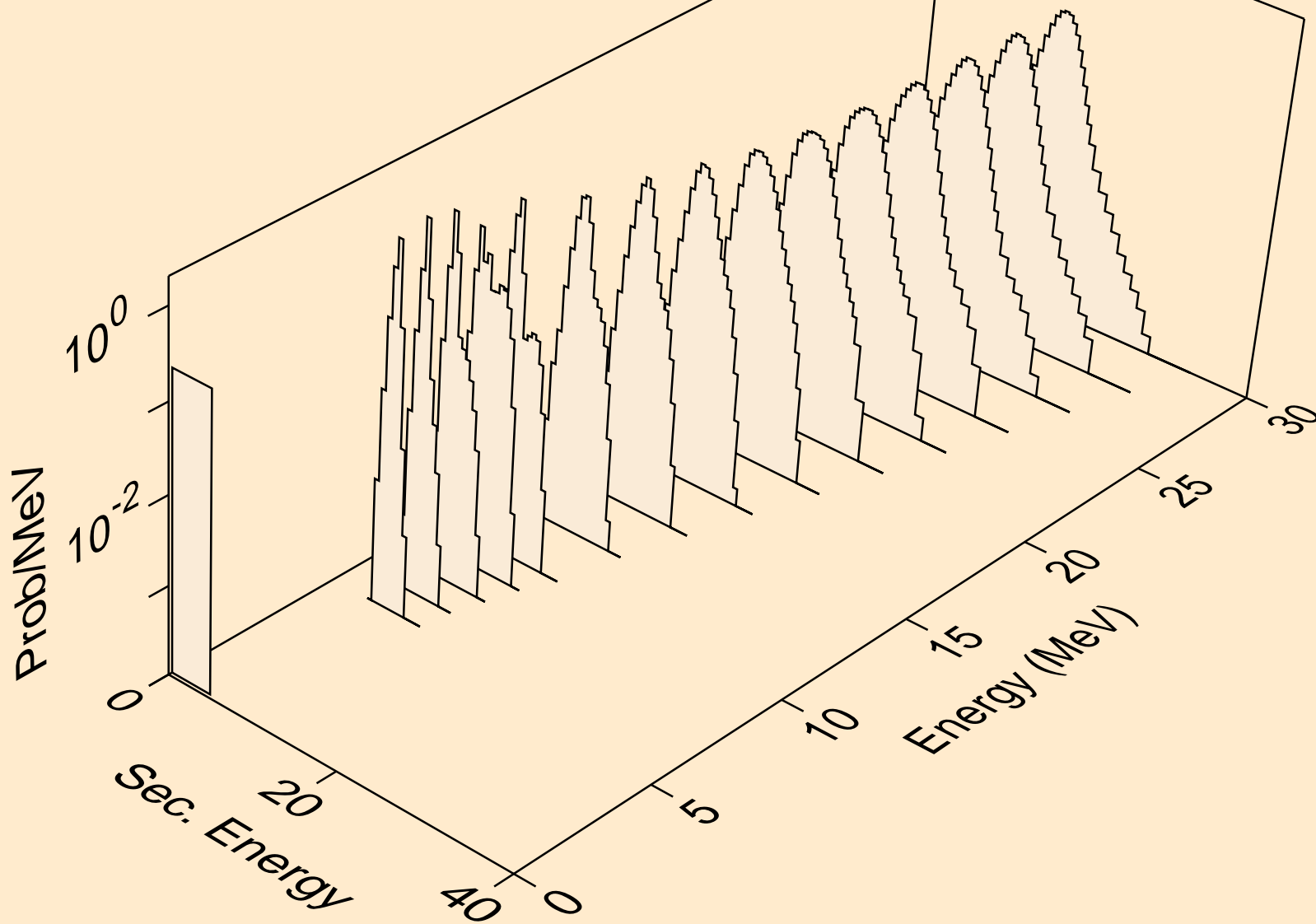

EU153 TRITON ACER TENDL-2023 LIBRARY; T=0.K
alphas from (t,da)

