

HF161 TRITON ACER TENDL-2021 LIBRARY; T=0.K  
Principal cross sections

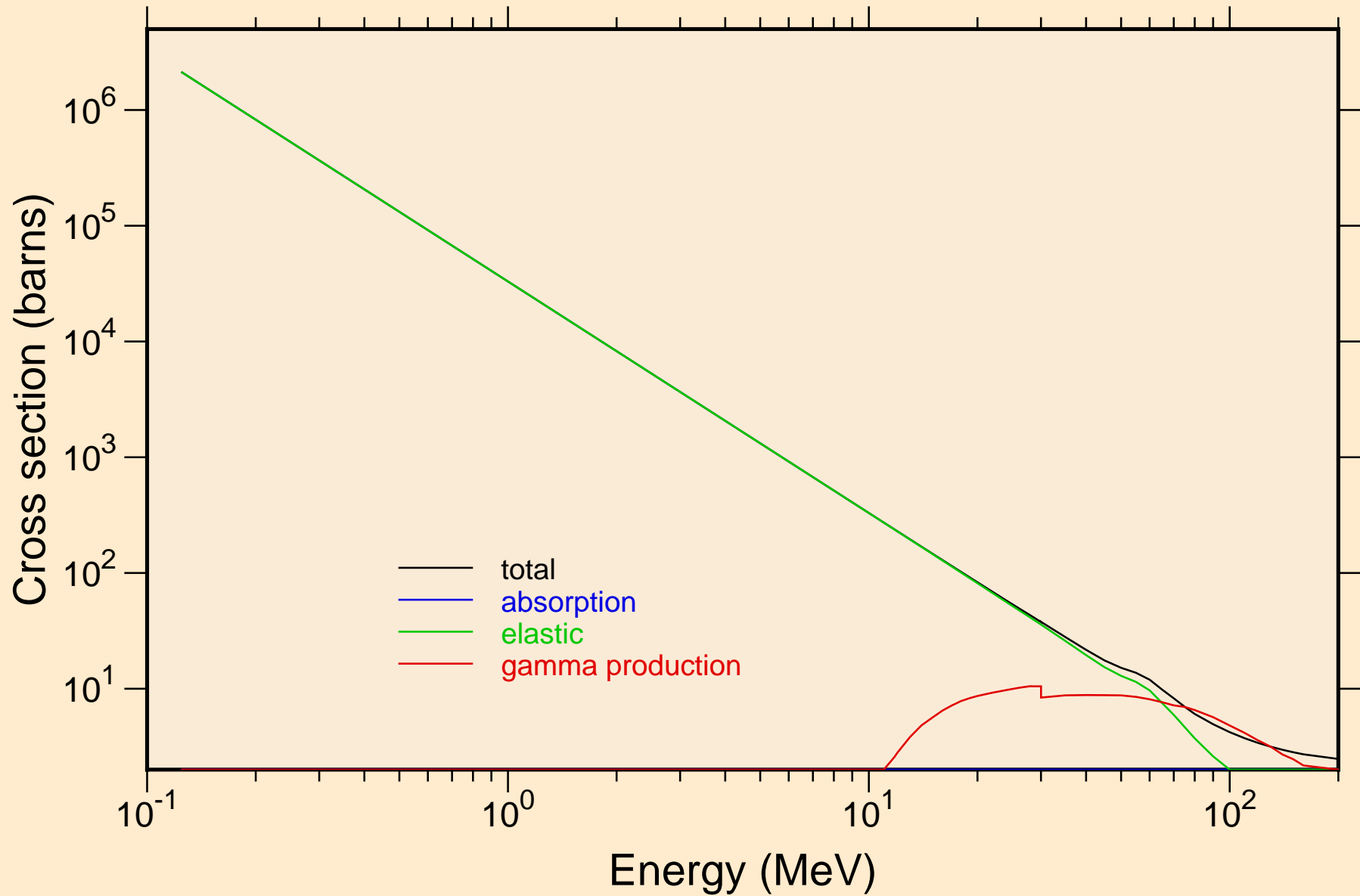

HF161 TRITON ACER TENDL-2021 LIBRARY; T=0.K  
Heating

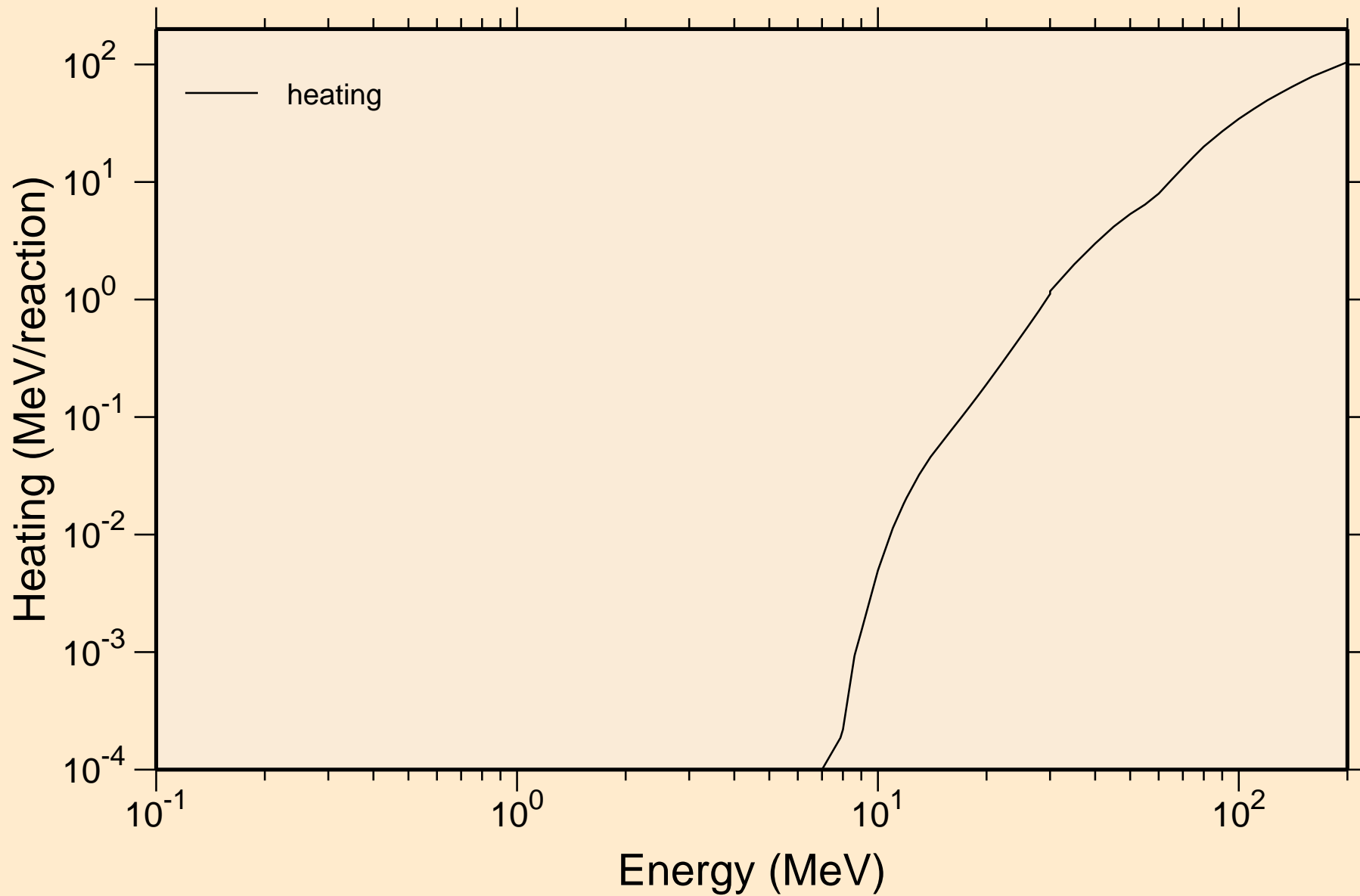

# HF161 TRITON ACER TENDL-2021 LIBRARY; T=0.K

## Principal cross sections

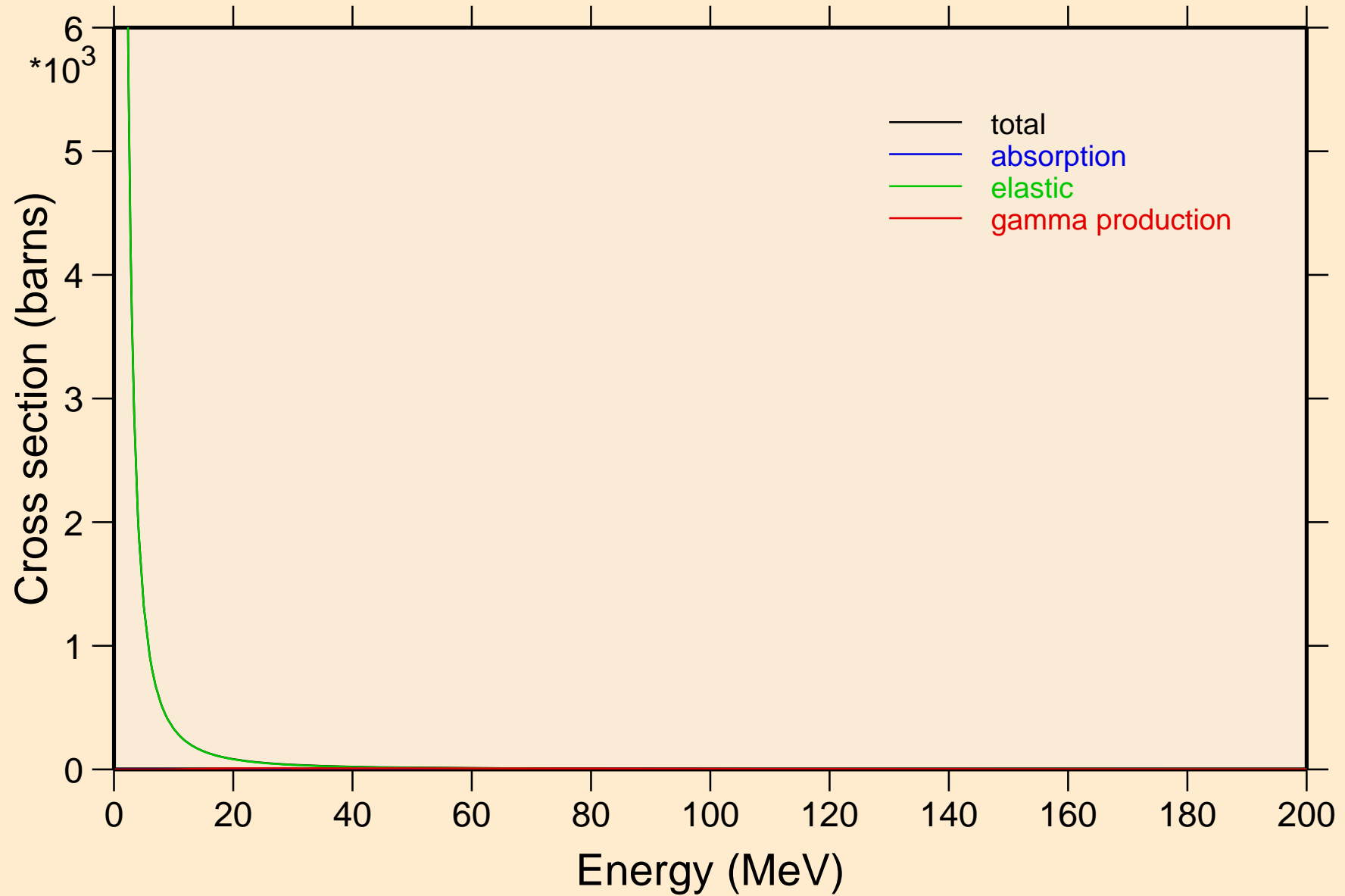

HF161 TRITON ACER TENDL-2021 LIBRARY; T=0.K

Heating

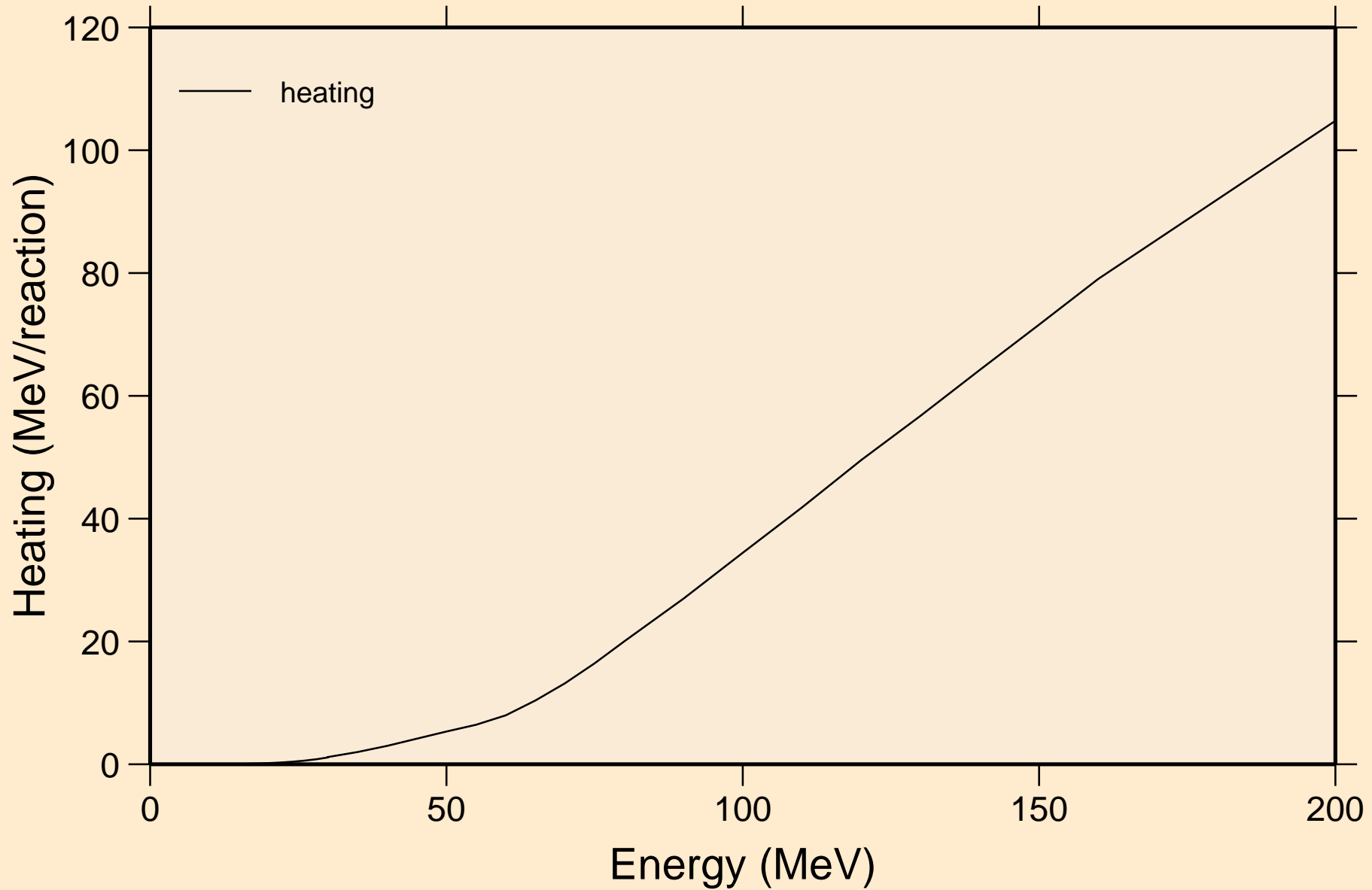

HF161 TRITON ACER TENDL-2021 LIBRARY; T=0.K  
Threshold reactions

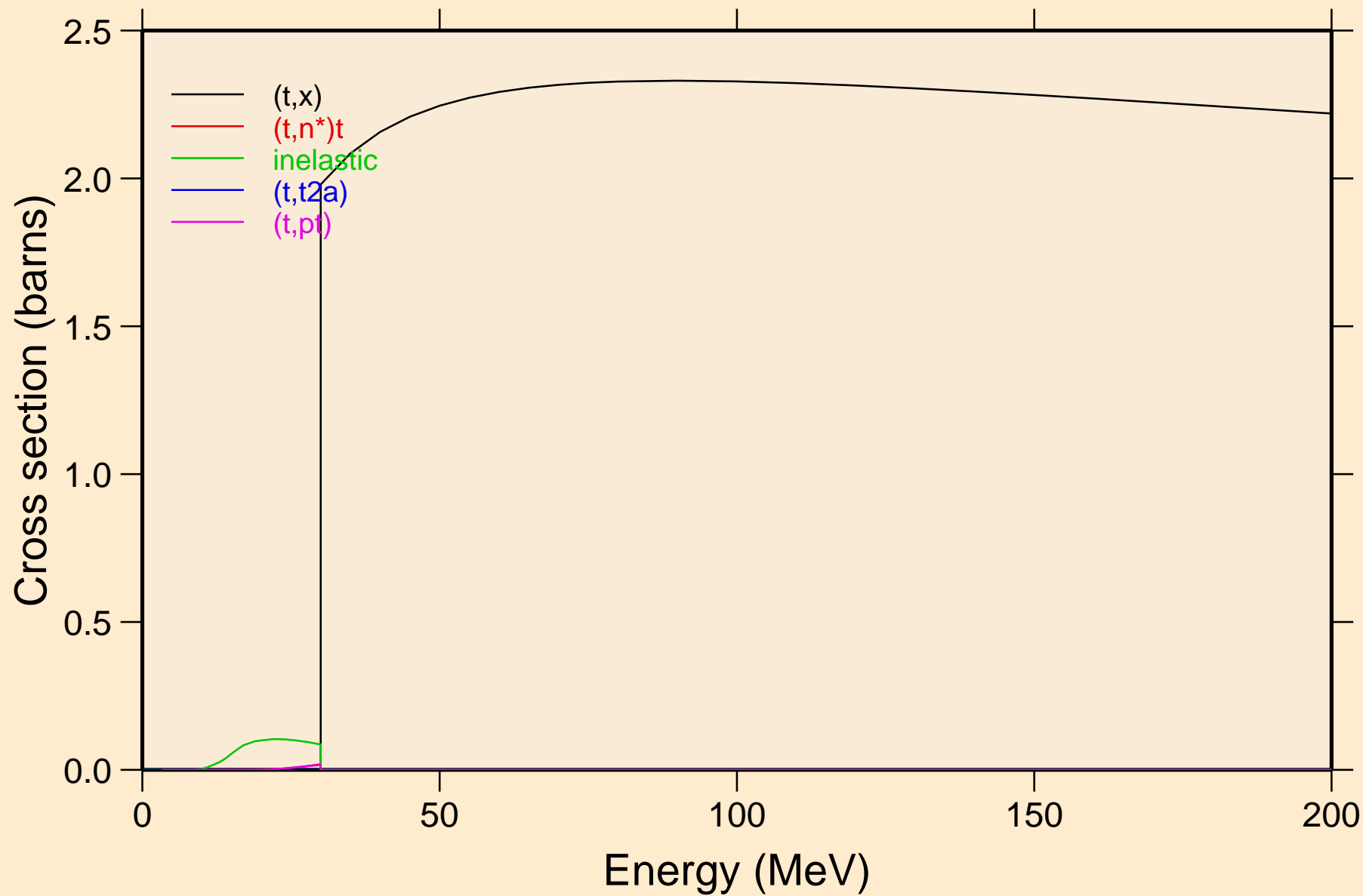

HF161 TRITON ACER TENDL-2021 LIBRARY; T=0.K  
Threshold reactions

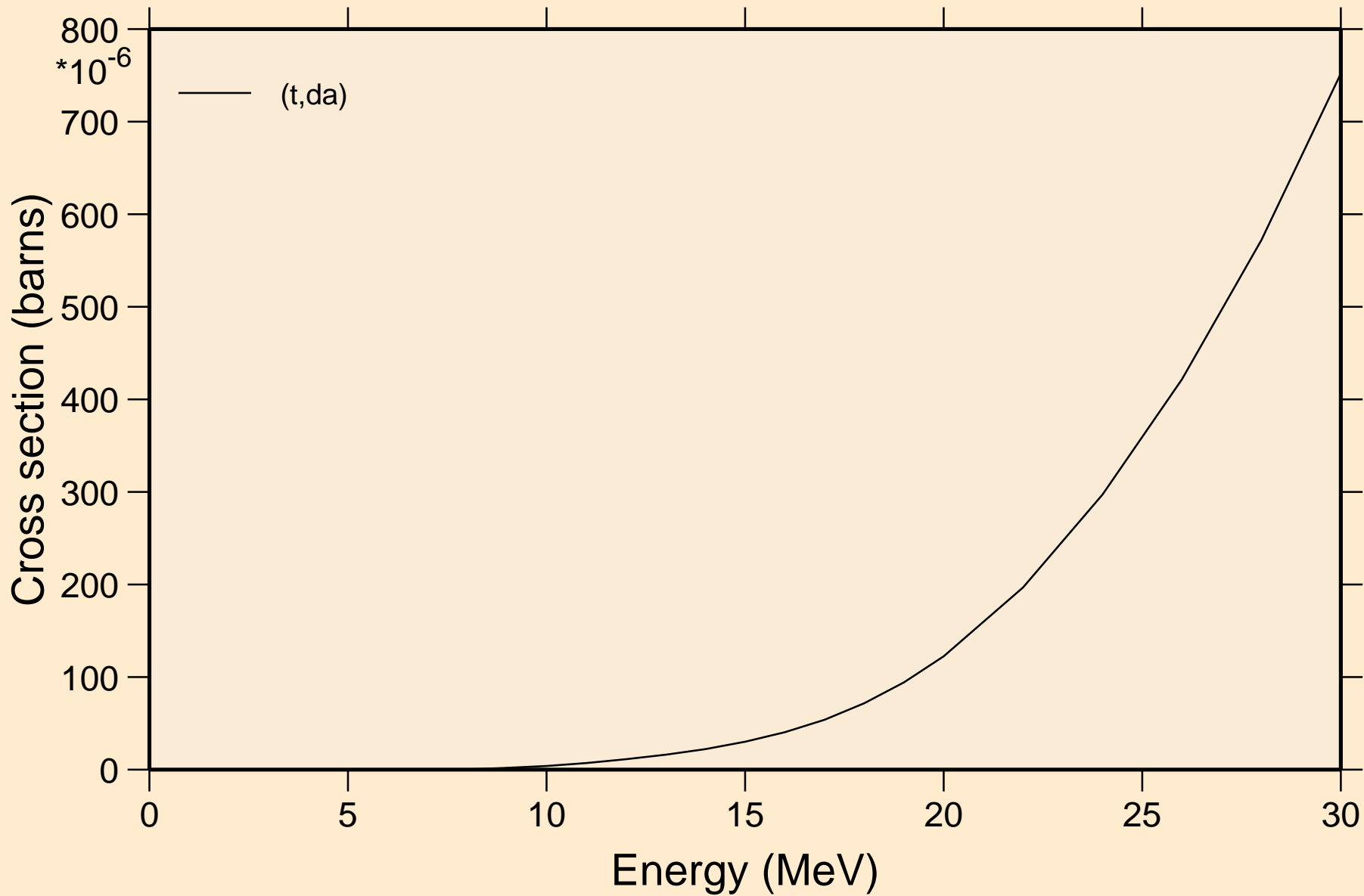

HF161 TRITON ACER TENDL-2021 LIBRARY; T=0.K  
angular distribution for elastic

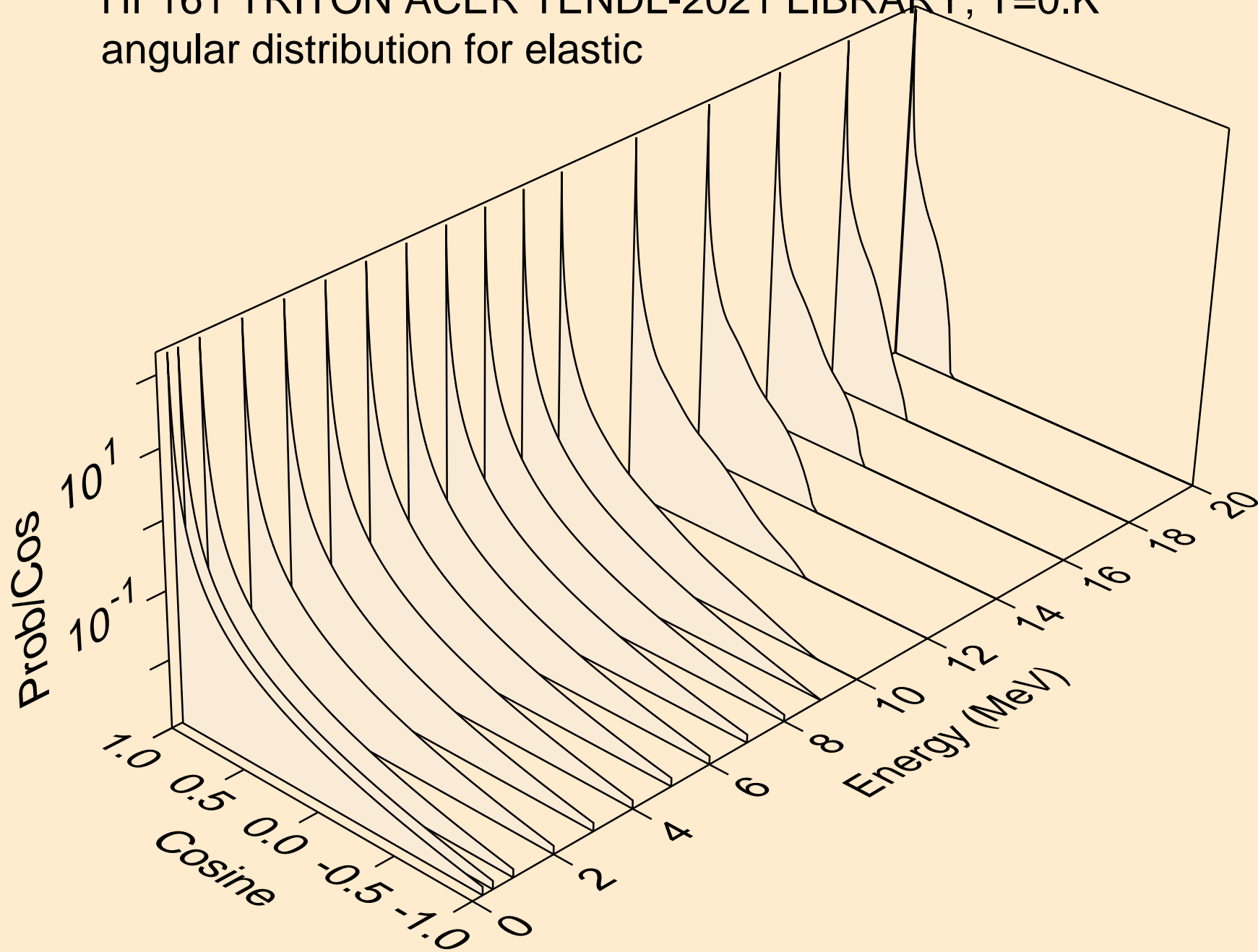

HF161 TRITON ACER TENDL-2021 LIBRARY; T=0.K  
angular distribution for elastic

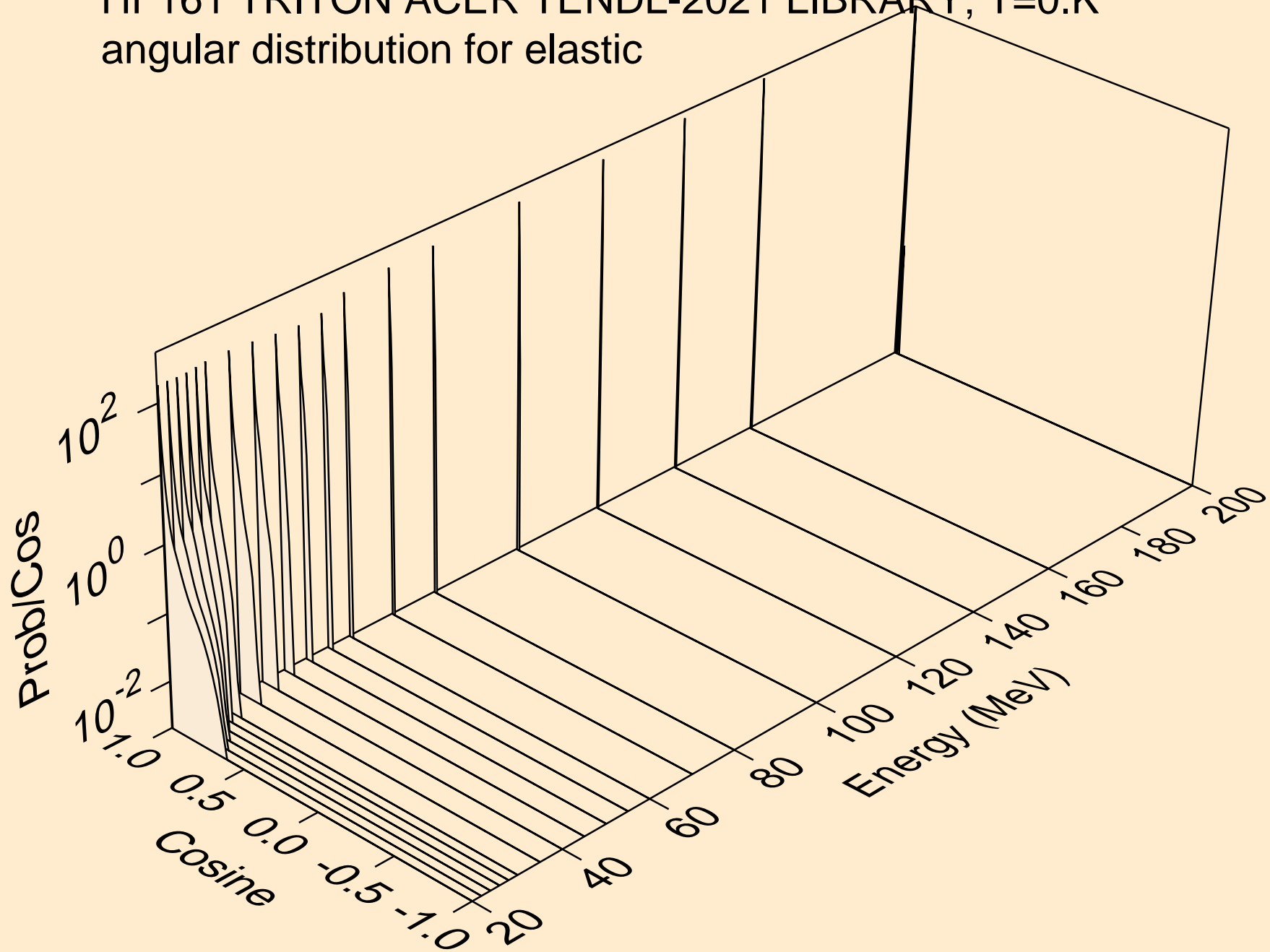



HF161 TRITON ACER TENDL-2021 LIBRARY; T=0.K  
Triton emission for (t,x)

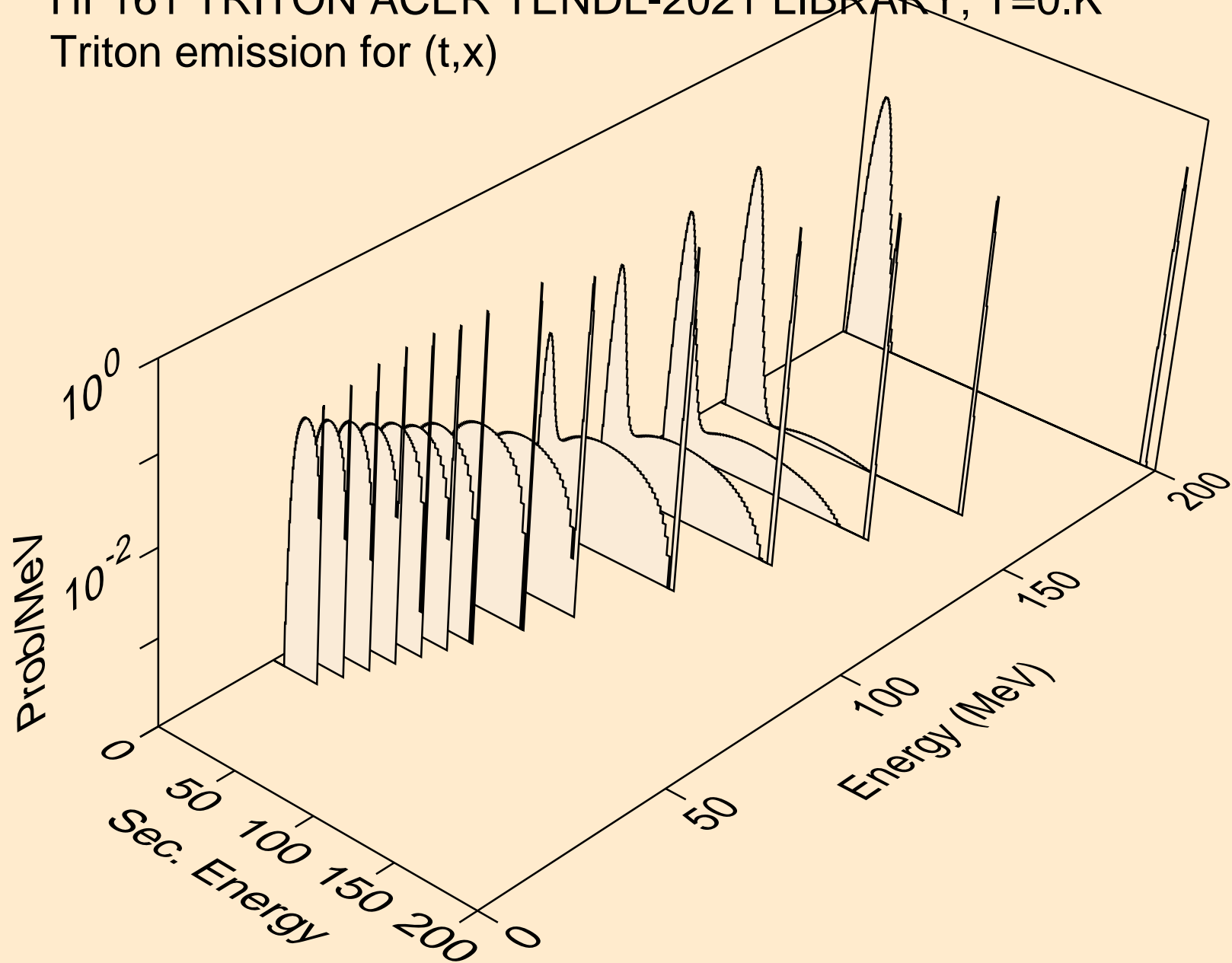

HF161 TRITON ACER TENDL-2021 LIBRARY; T=0.K  
Triton emission for (t,n\*)t

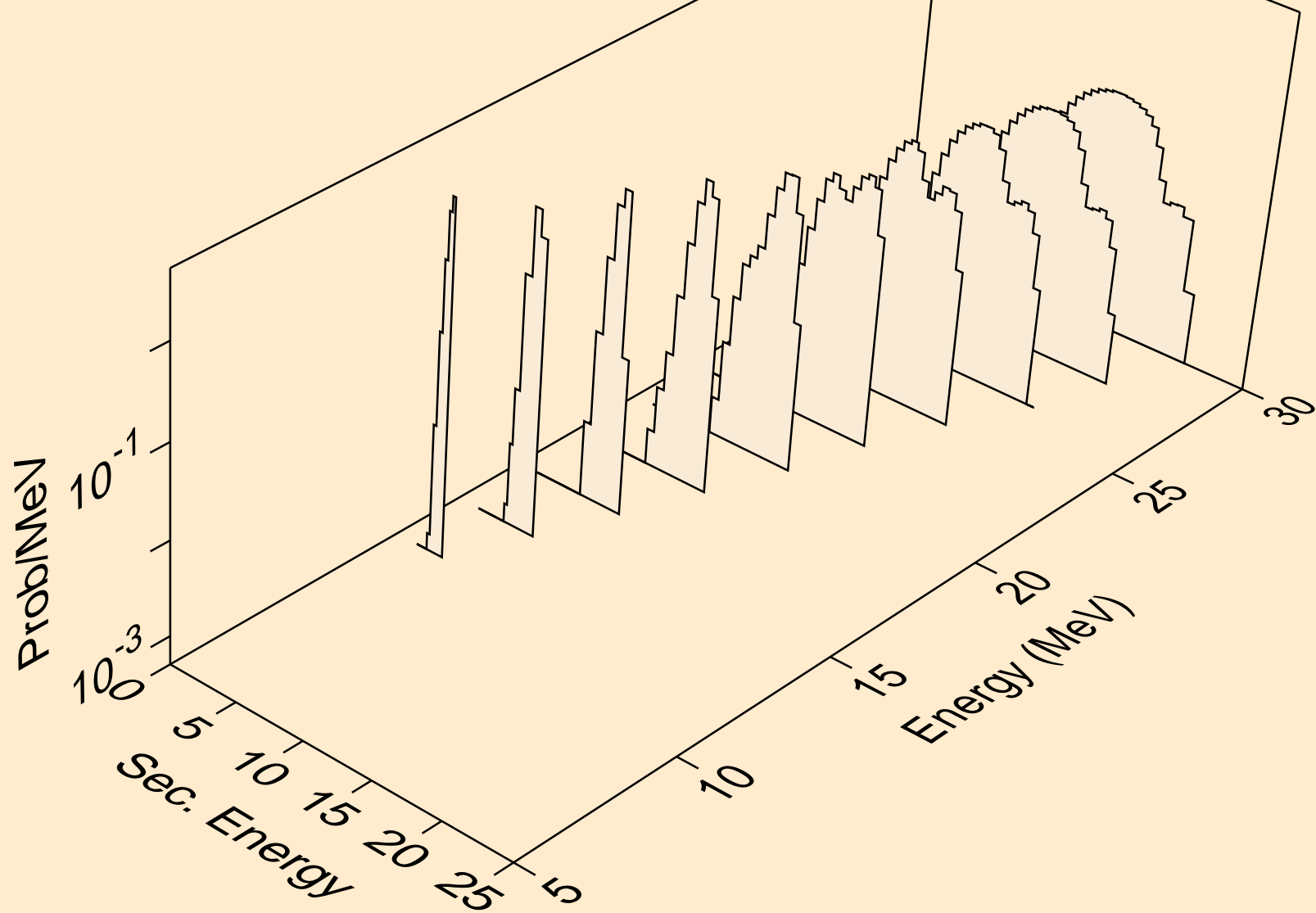

HF161 TRITON ACER TENDL-2021 LIBRARY; T=0.K  
Triton emission for inelastic

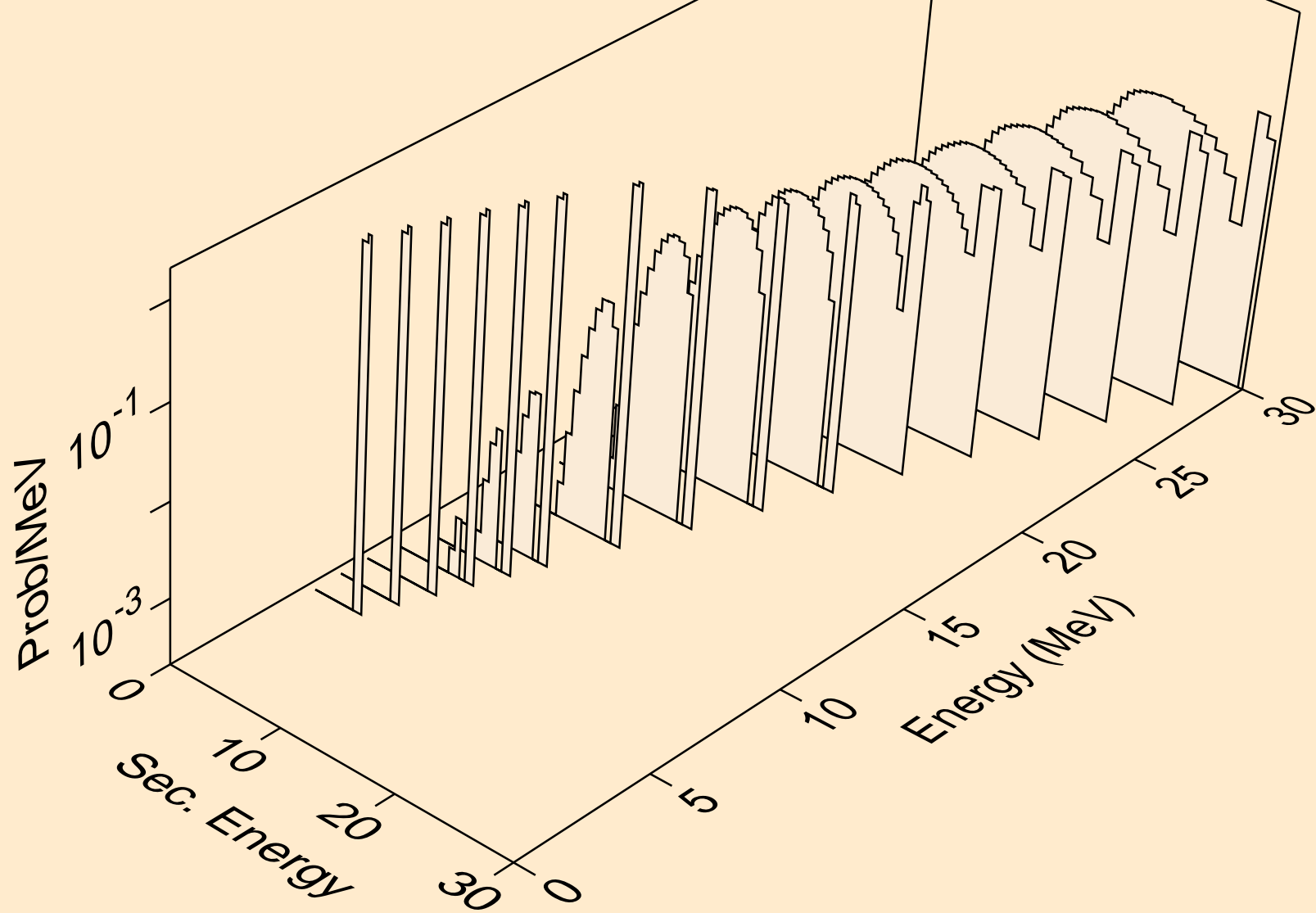

HF161 TRITON ACER TENDL-2021 LIBRARY; T=0.K  
Triton emission for (t,t2a)

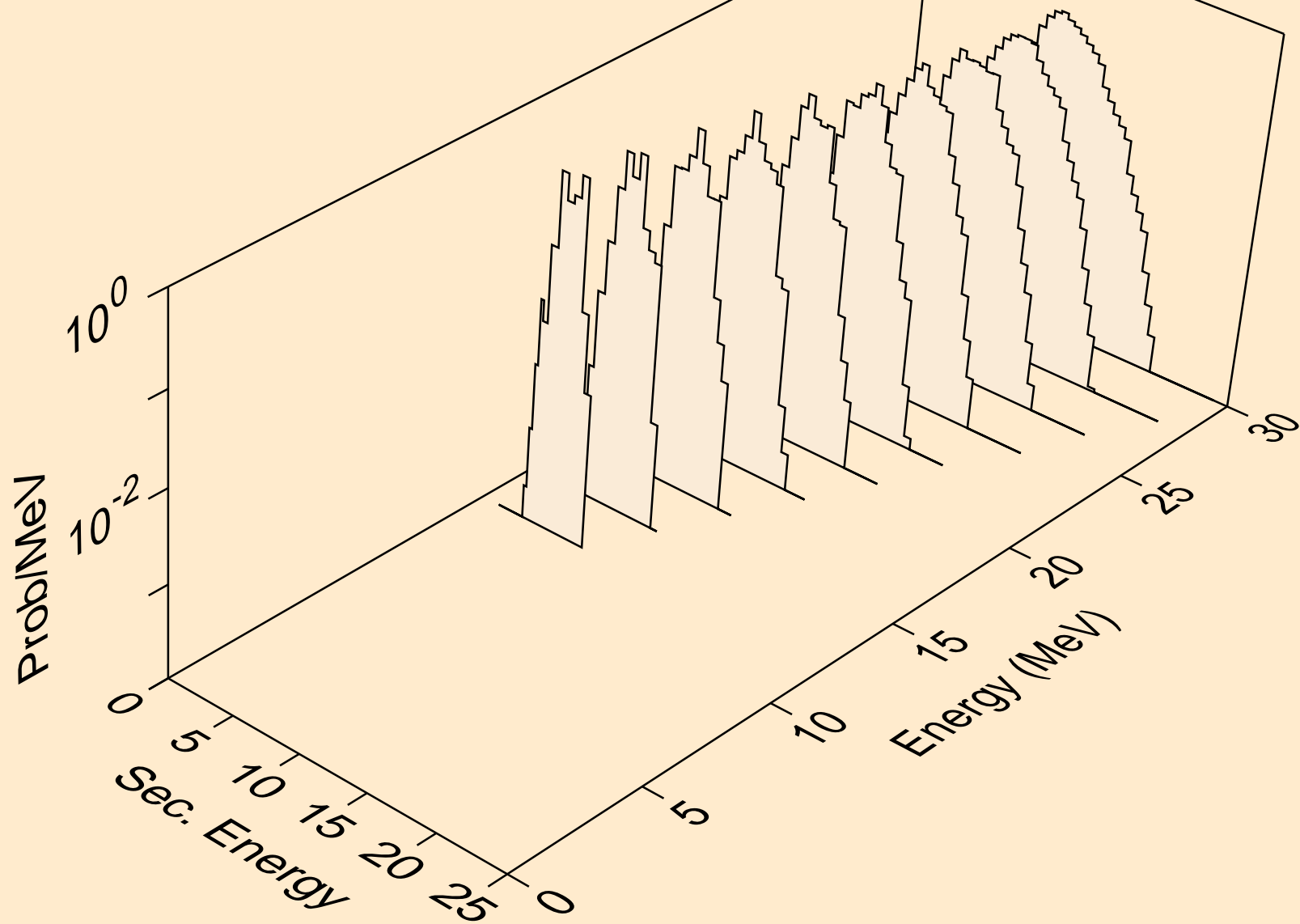

HF161 TRITON ACER TENDL-2021 LIBRARY; T=0.K  
Triton emission for (t,pt)

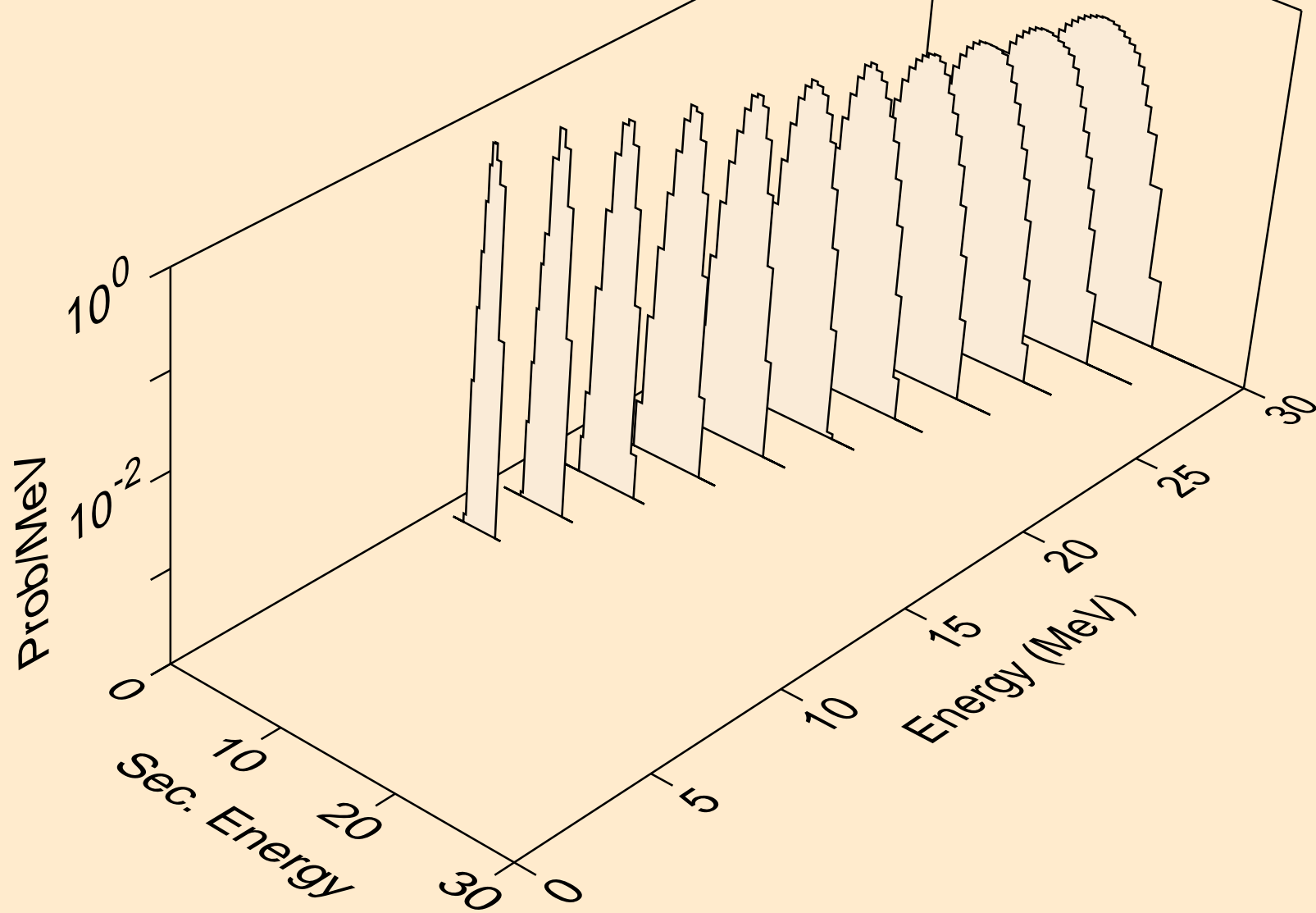

HF161 TRITON ACER TENDL-2021 LIBRARY; T=0.K  
Photon emission for (z,n)

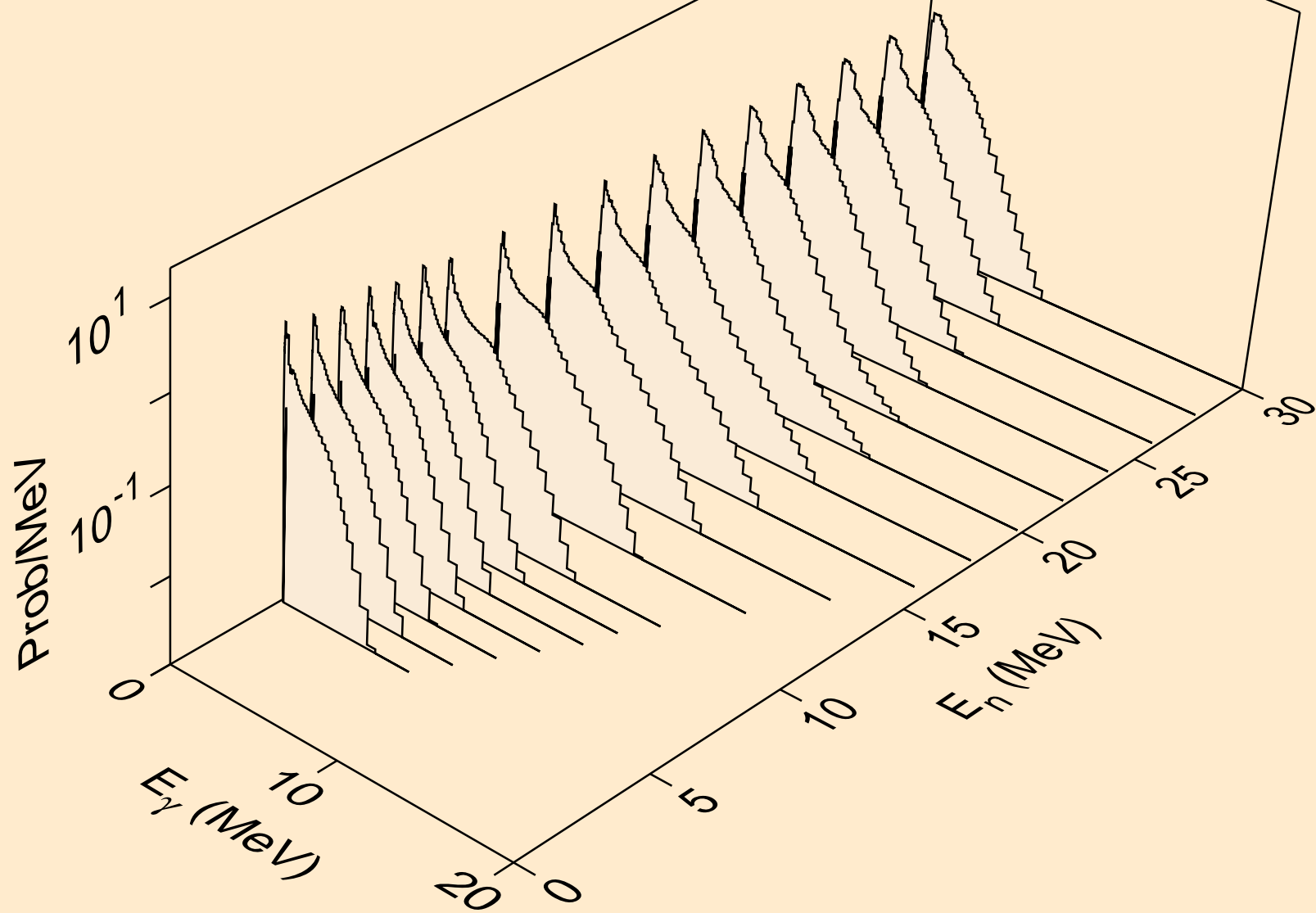

HF161 TRITON ACER TENDL-2021 LIBRARY; T=0.K  
Photon emission for (n,x)

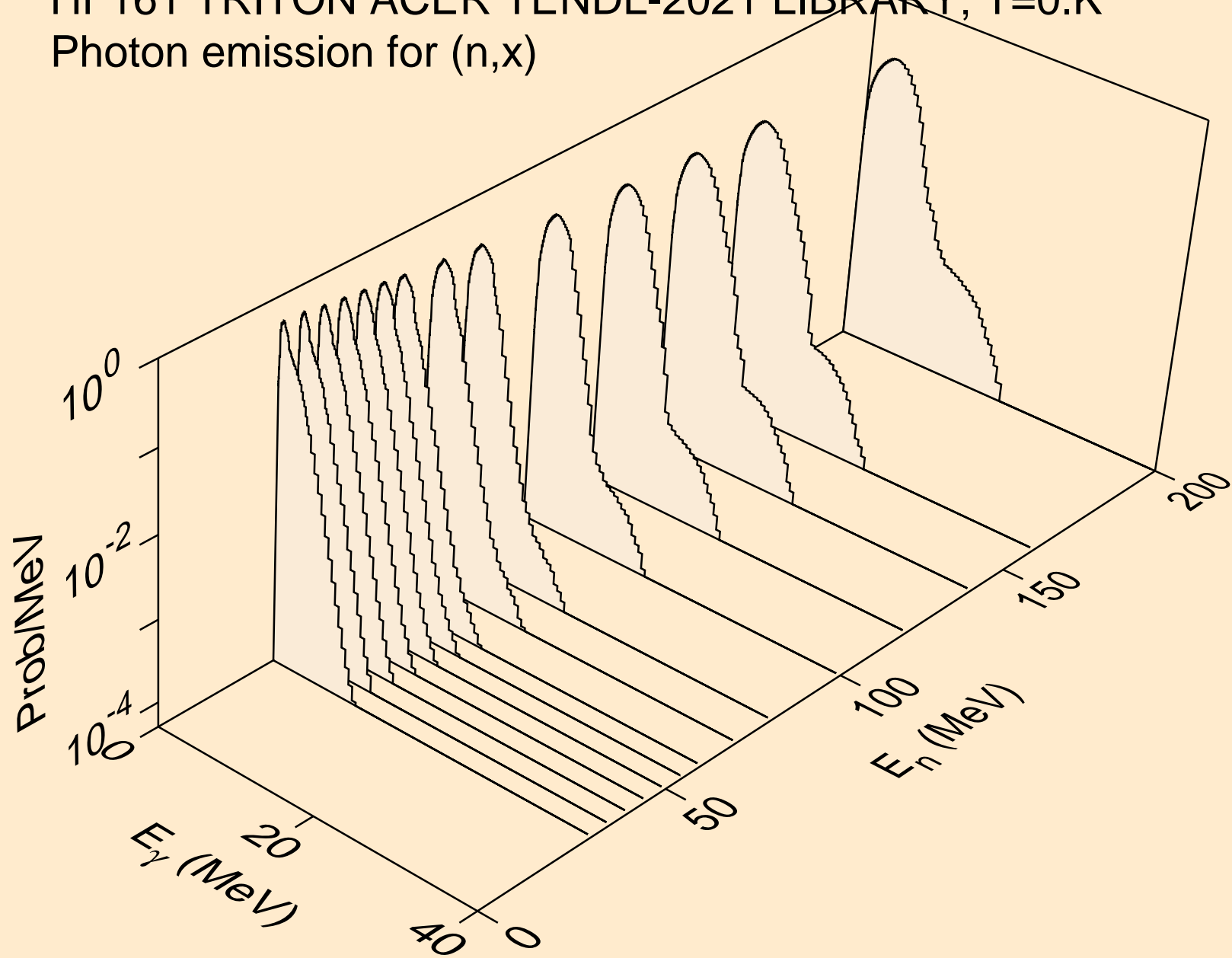

HF161 TRITON ACER TENDL-2021 LIBRARY; T=0.K  
Photon emission for (n,2nd)

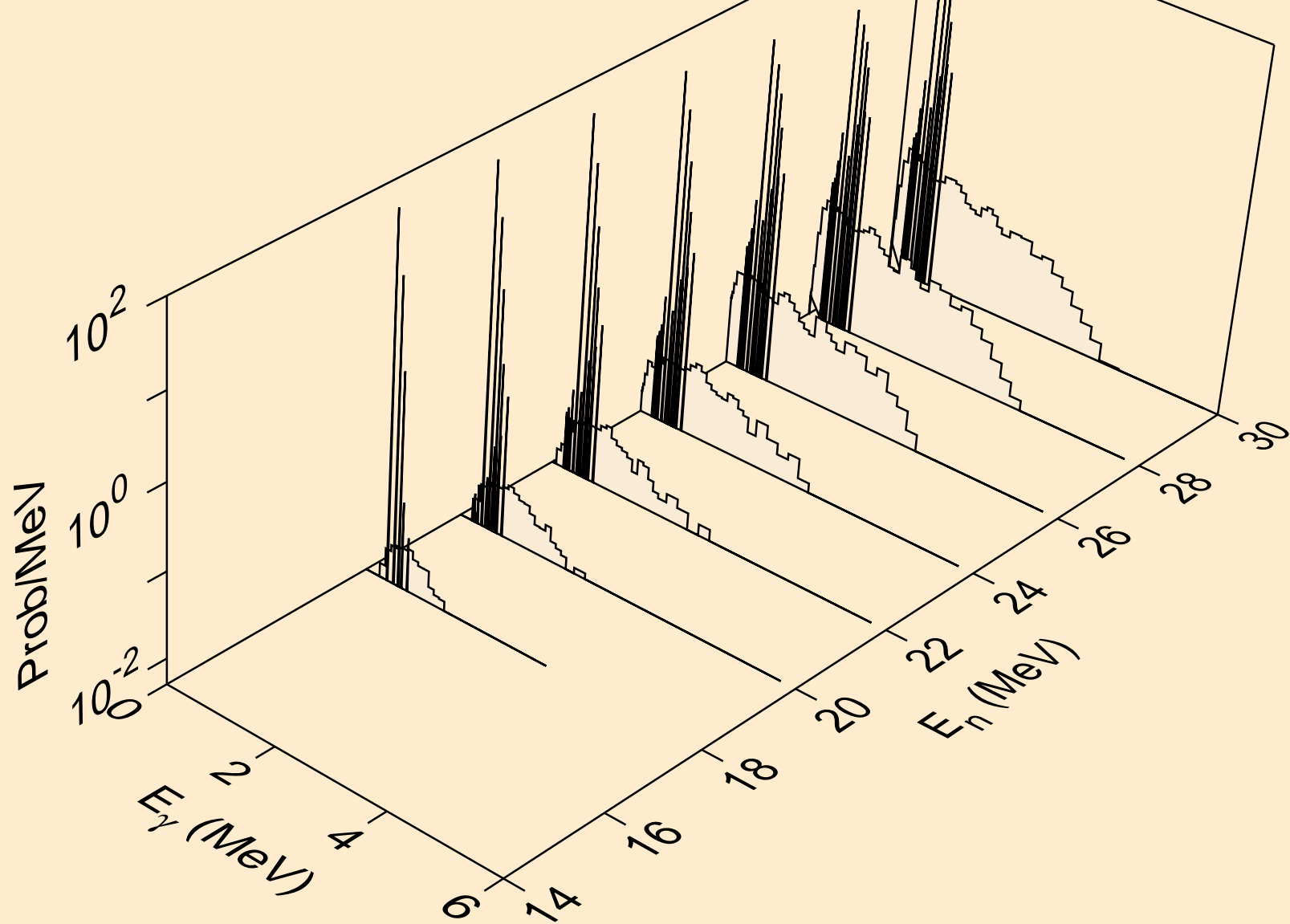



HF161 TRITON ACER TENDL-2021 LIBRARY; T=0.K  
Photon emission for (n,2n)

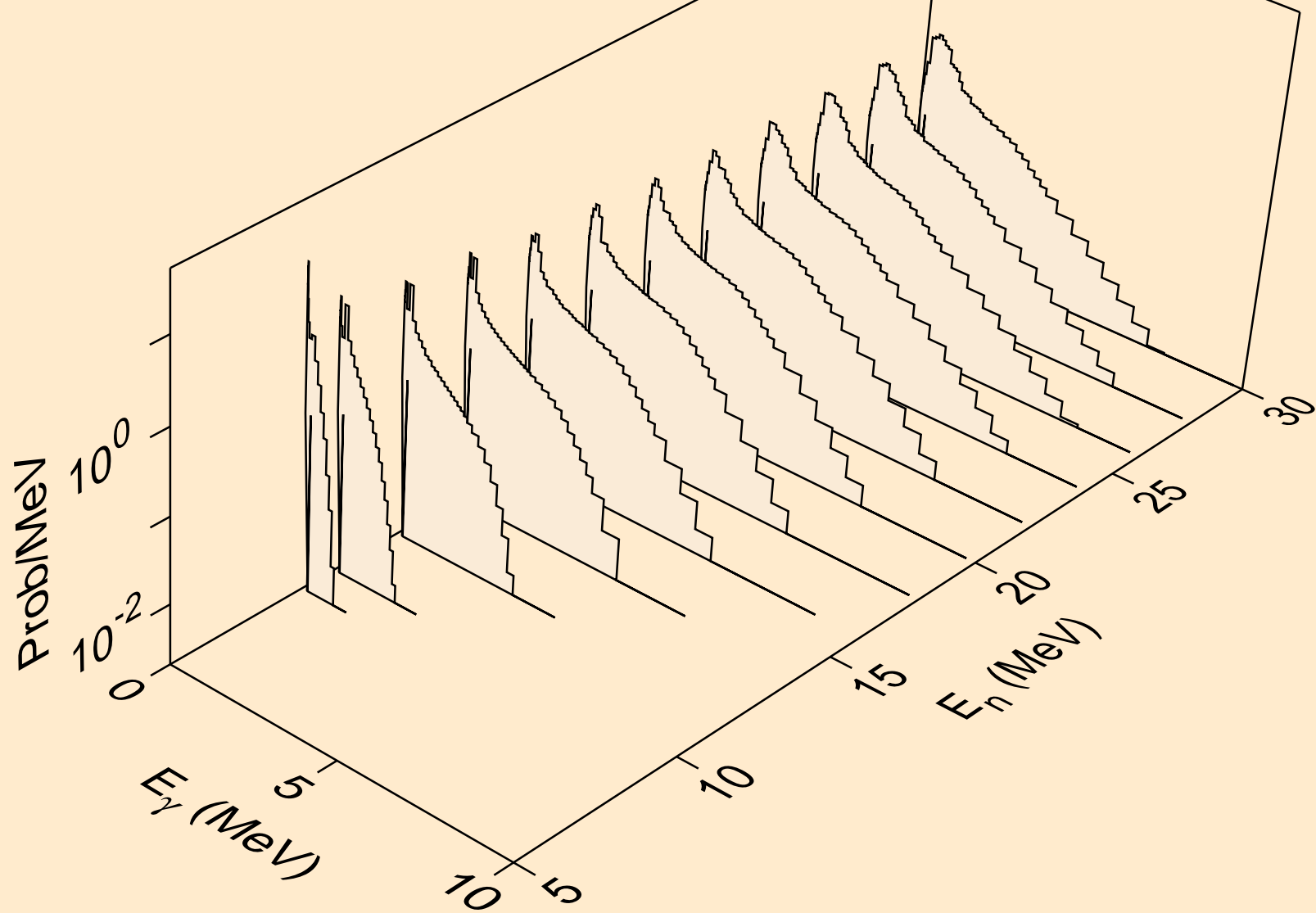

HF161 TRITON ACER TENDL-2021 LIBRARY; T=0.K  
Photon emission for (n,3n)

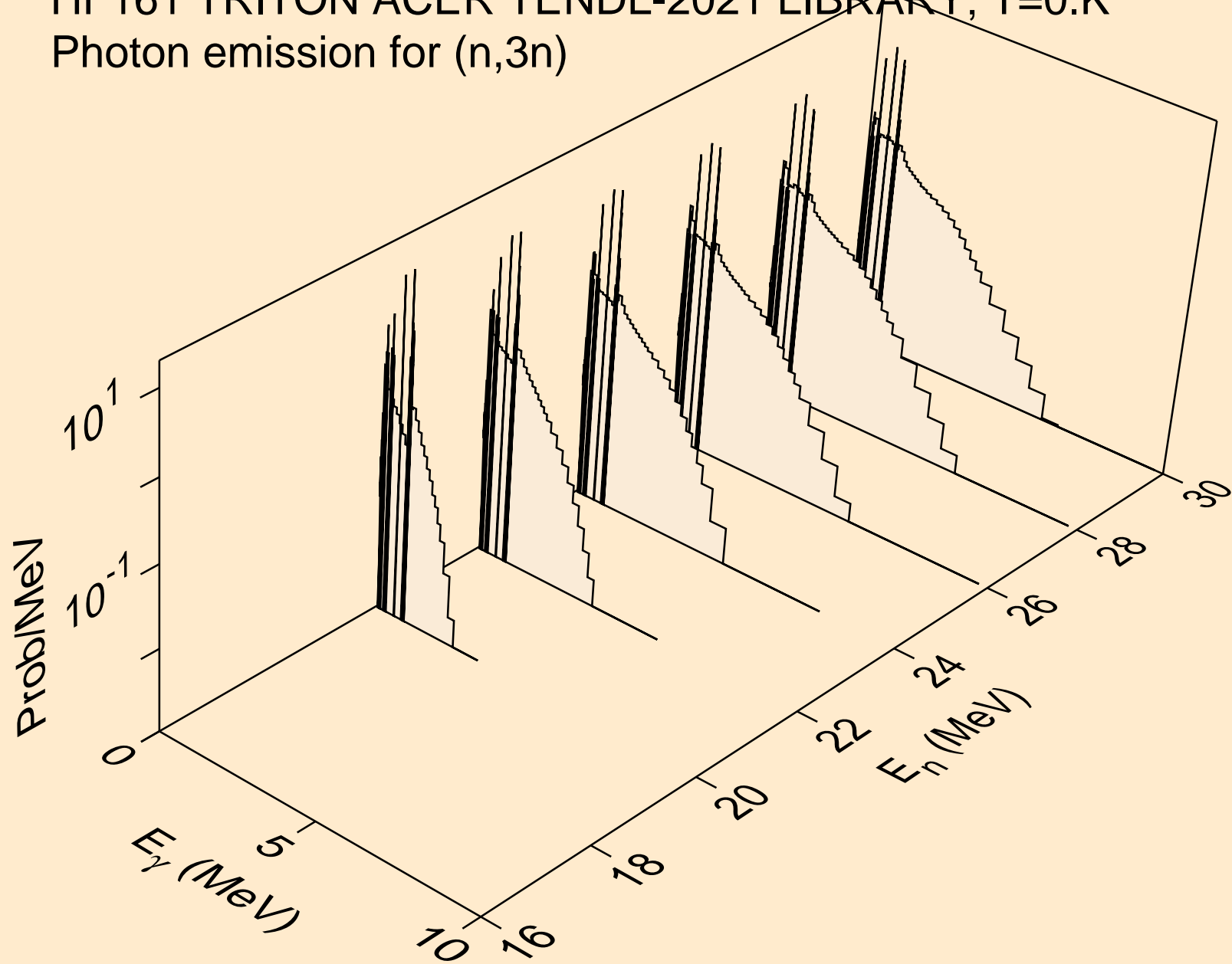

HF161 TRITON ACER TENDL-2021 LIBRARY; T=0.K  
Photon emission for (n,n\*)a

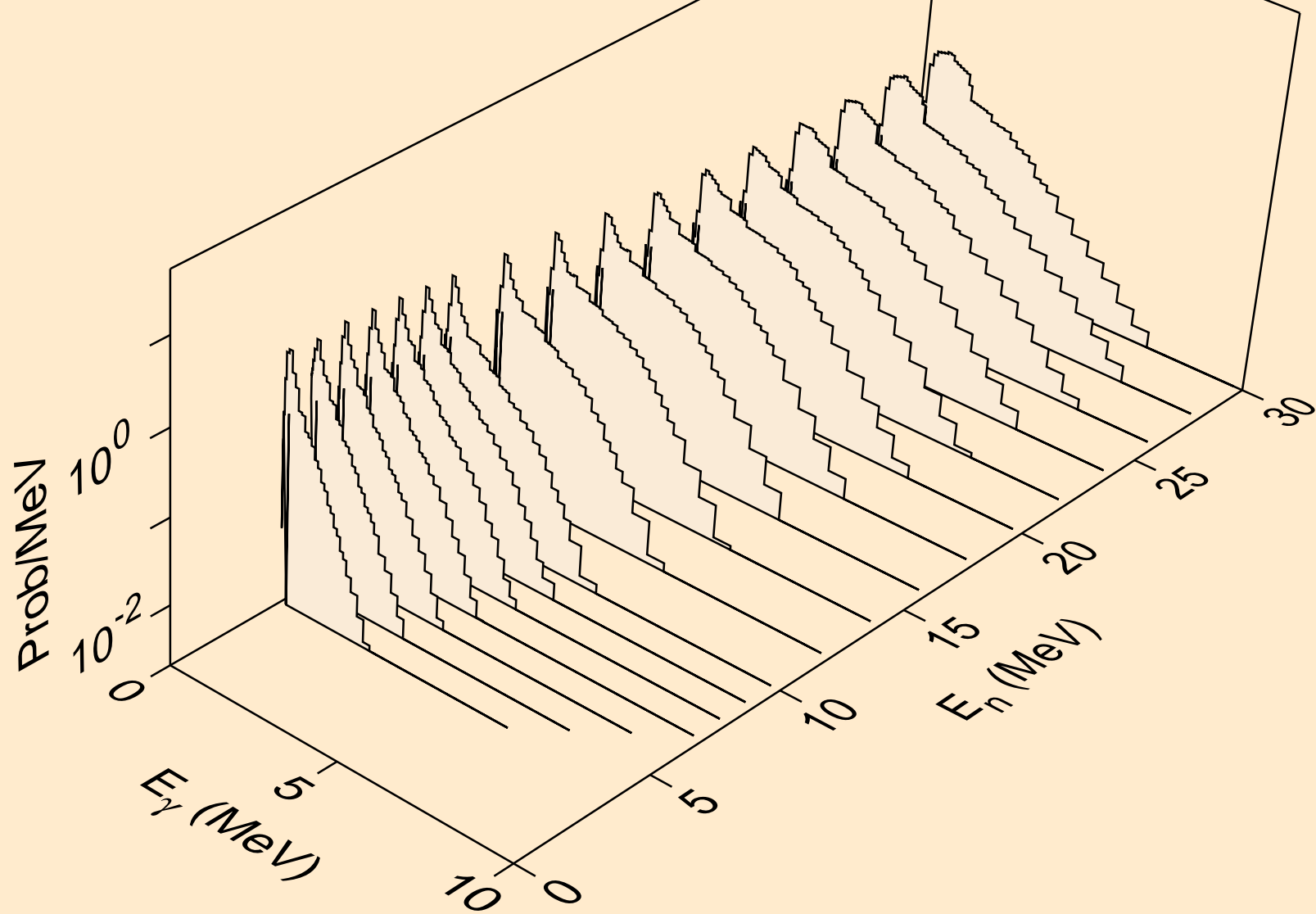

HF161 TRITON ACER TENDL-2021 LIBRARY; T=0.K  
Photon emission for (n,n\*)3a

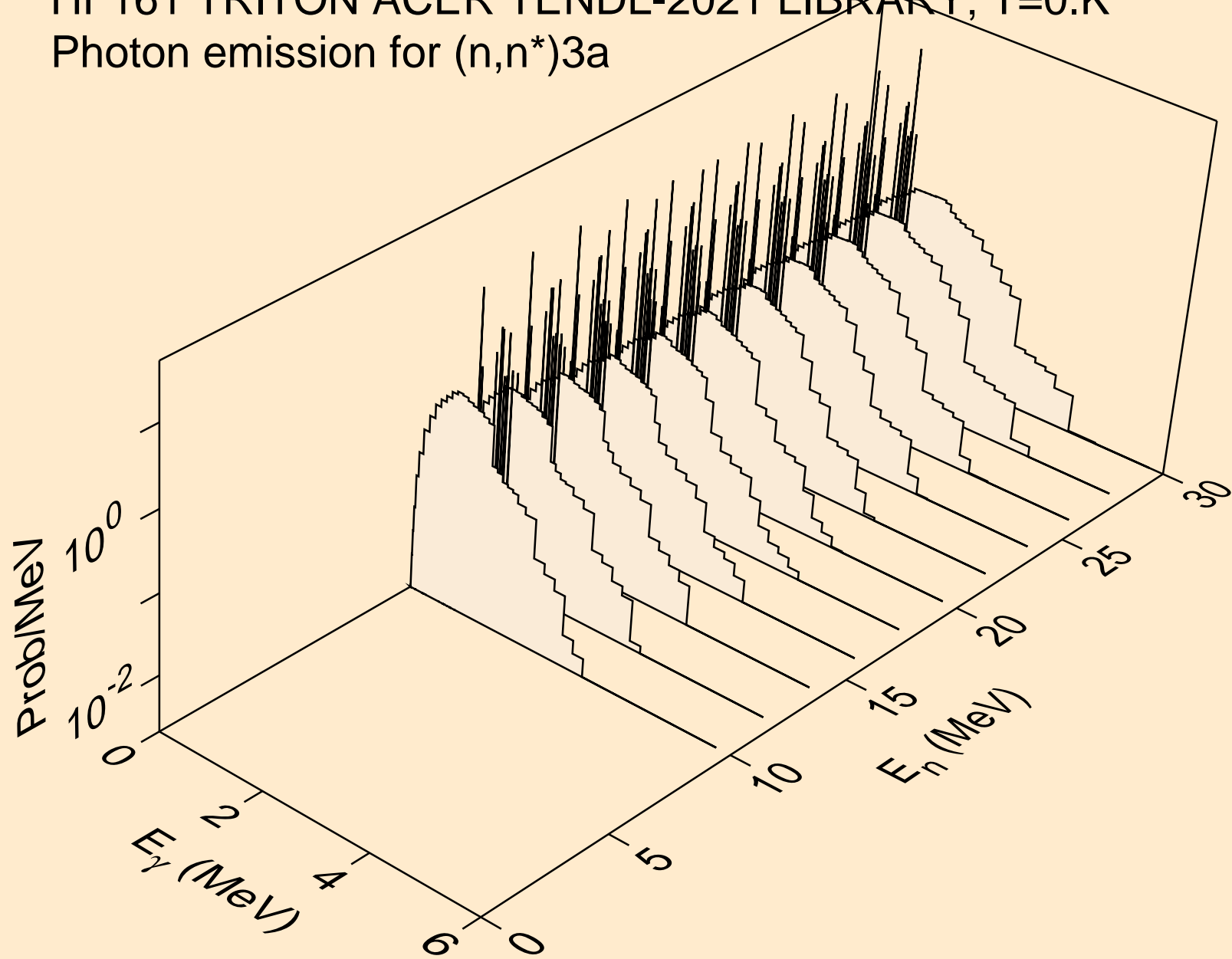

HF161 TRITON ACER TENDL-2021 LIBRARY; T=0.K  
Photon emission for (n,2n)a

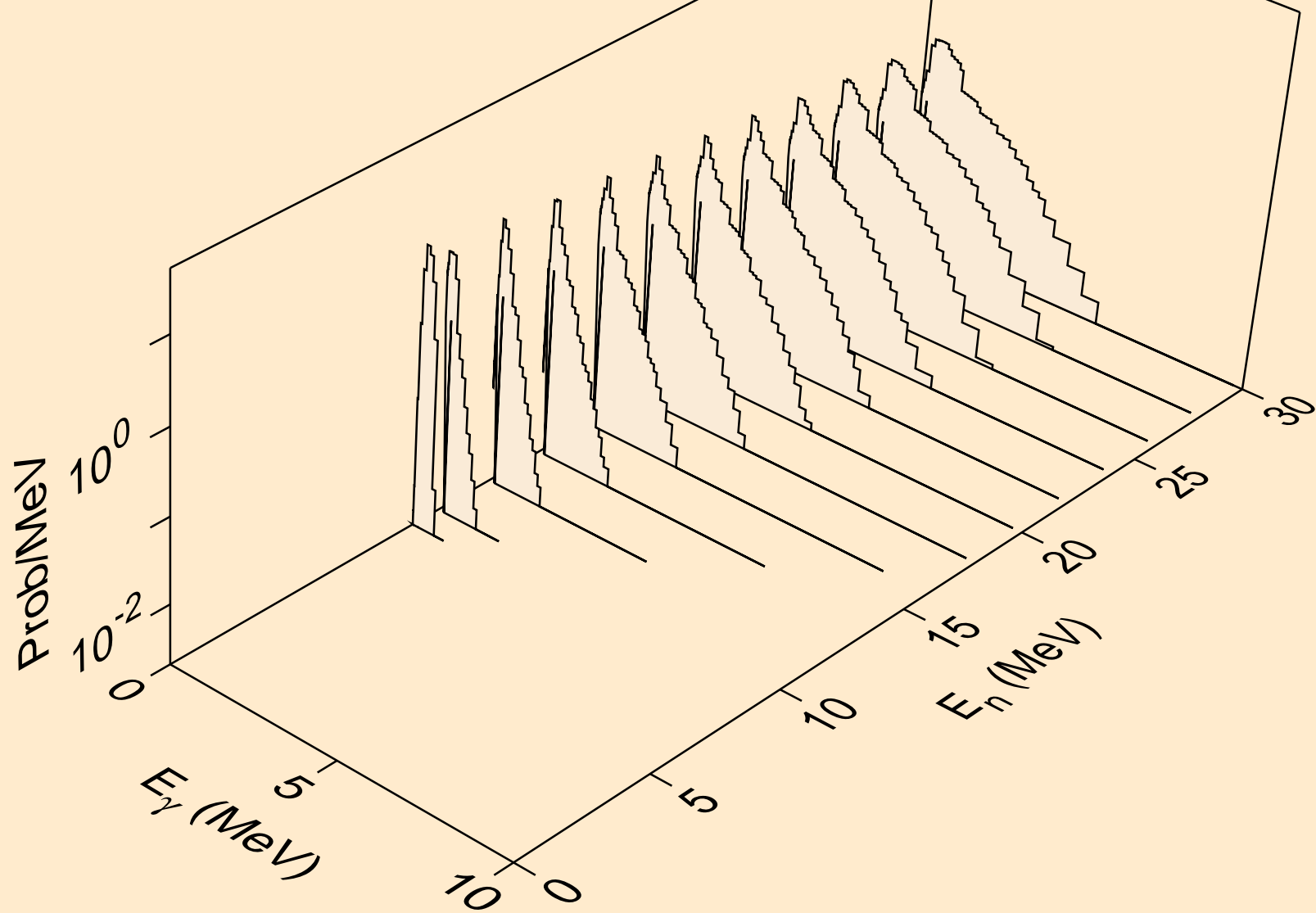

HF161 TRITON ACER TENDL-2021 LIBRARY; T=0.K  
Photon emission for (n,3n)a

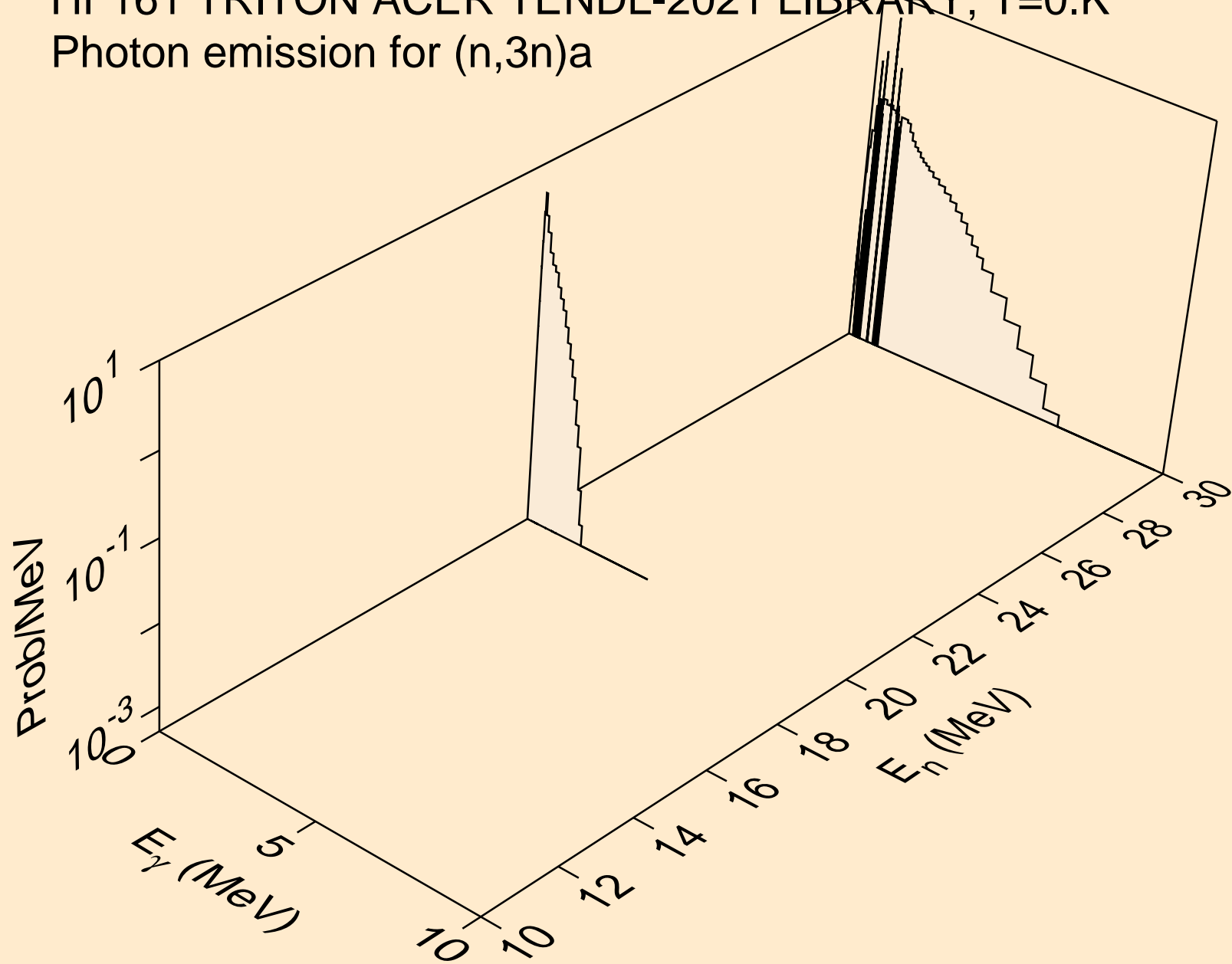

HF161 TRITON ACER TENDL-2021 LIBRARY; T=0.K  
Photon emission for (n,n\*)p

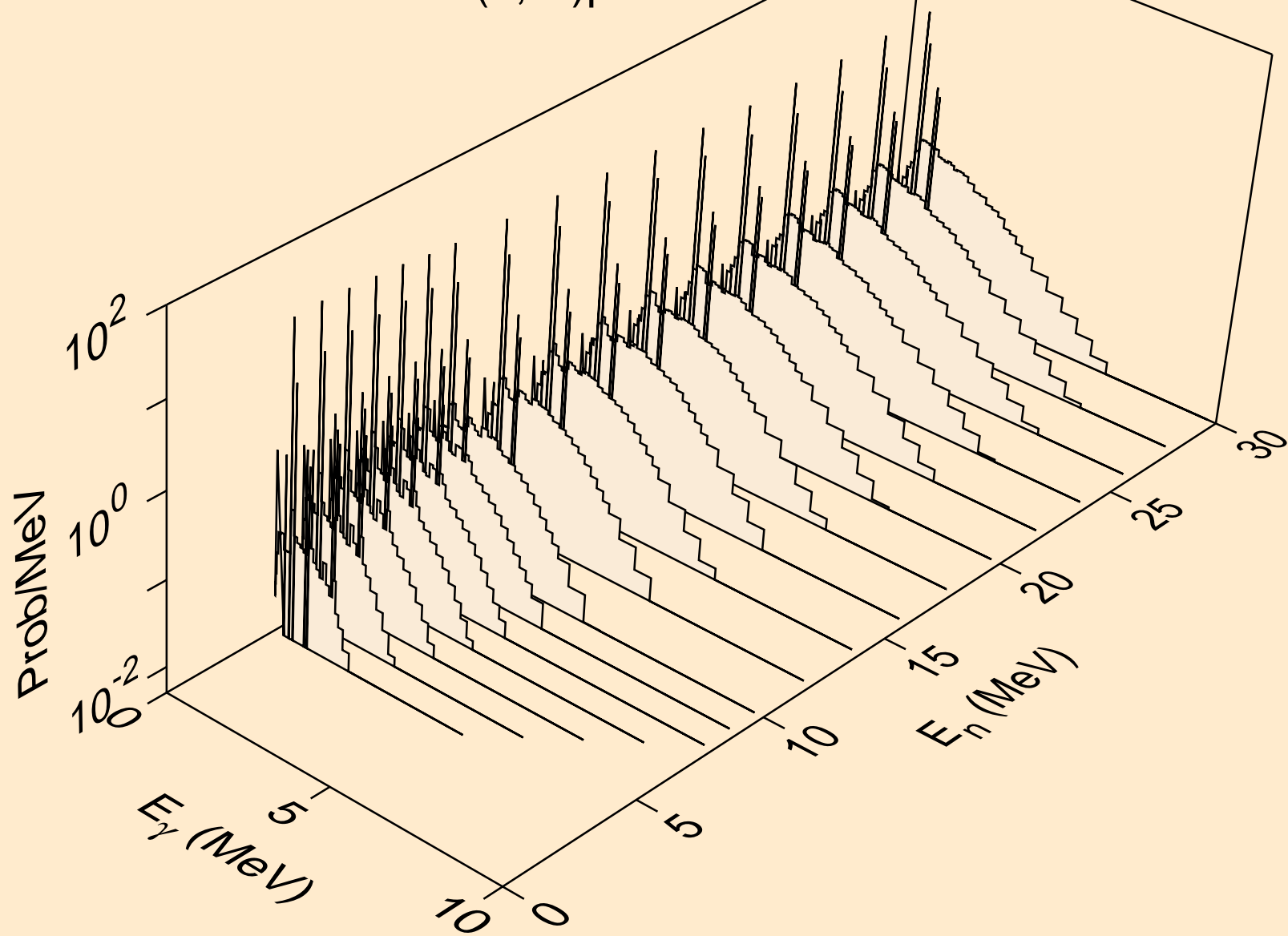

HF161 TRITON ACER TENDL-2021 LIBRARY; T=0.K  
Photon emission for (n,n\*)2a

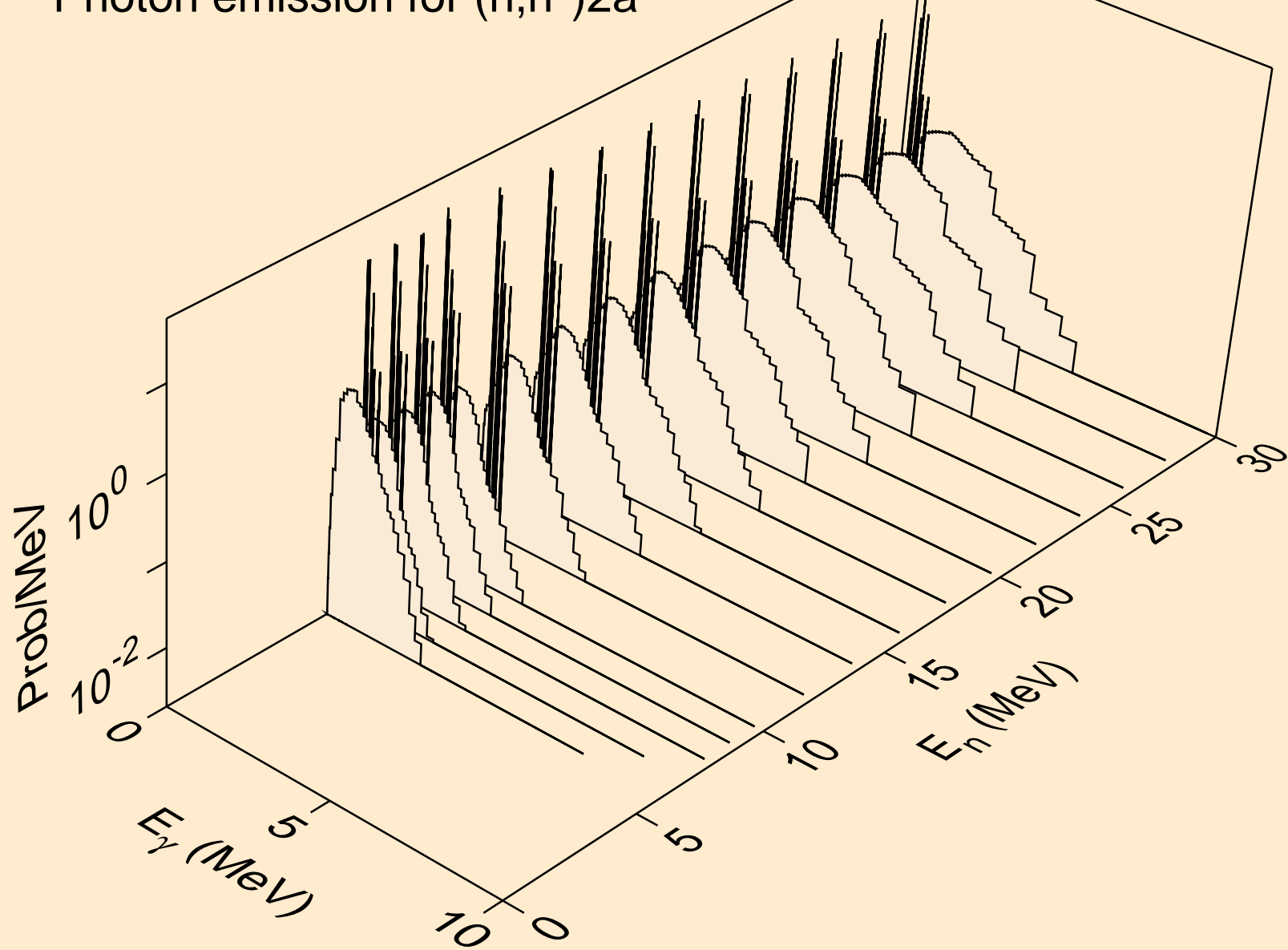



HF161 TRITON ACER TENDL-2021 LIBRARY; T=0.K  
Photon emission for (n,2n)2a

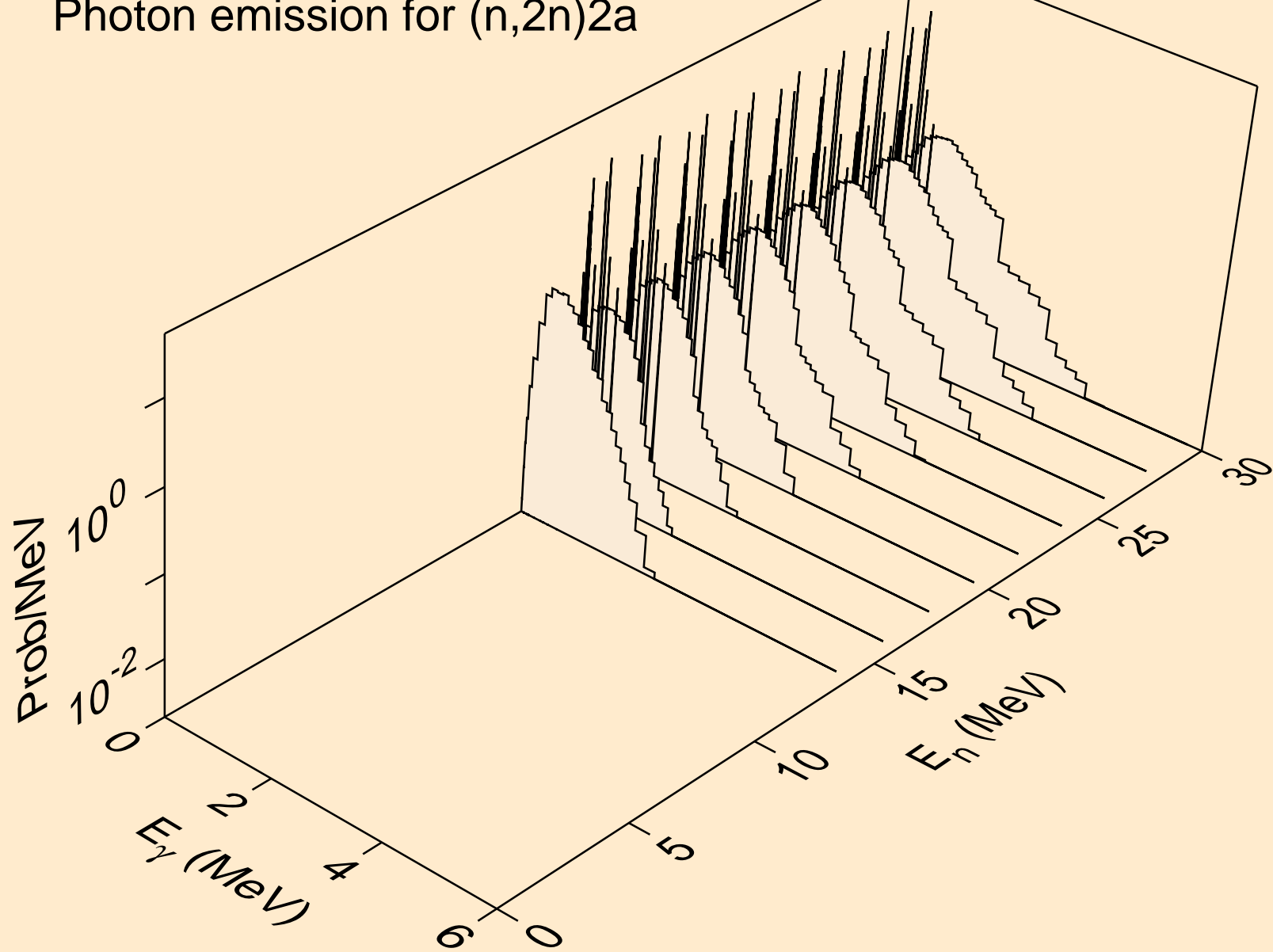

HF161 TRITON ACER TENDL-2021 LIBRARY; T=0.K  
Photon emission for (n,n\*)d

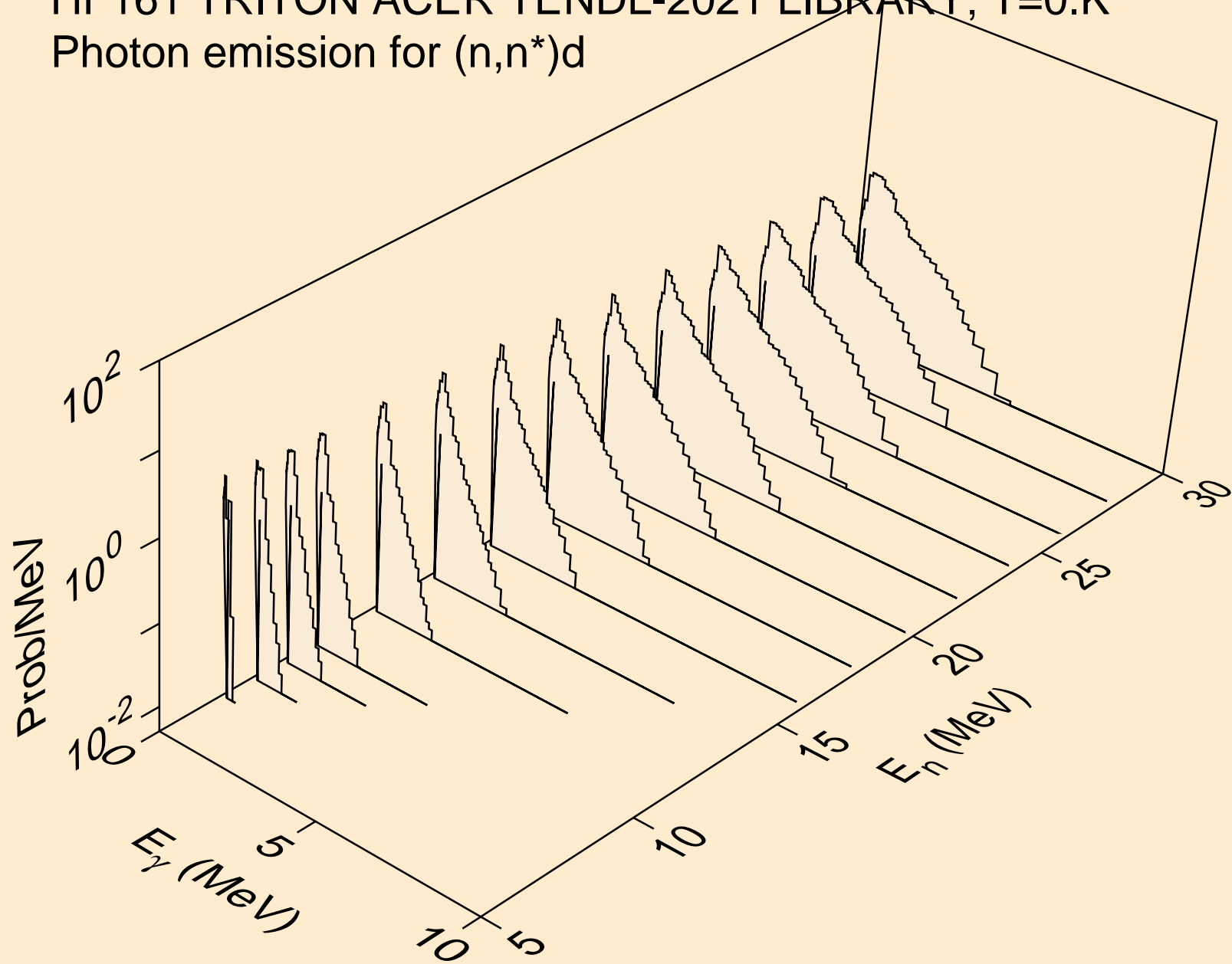

HF161 TRITON ACER TENDL-2021 LIBRARY; T=0.K  
Photon emission for (n,n\*)t

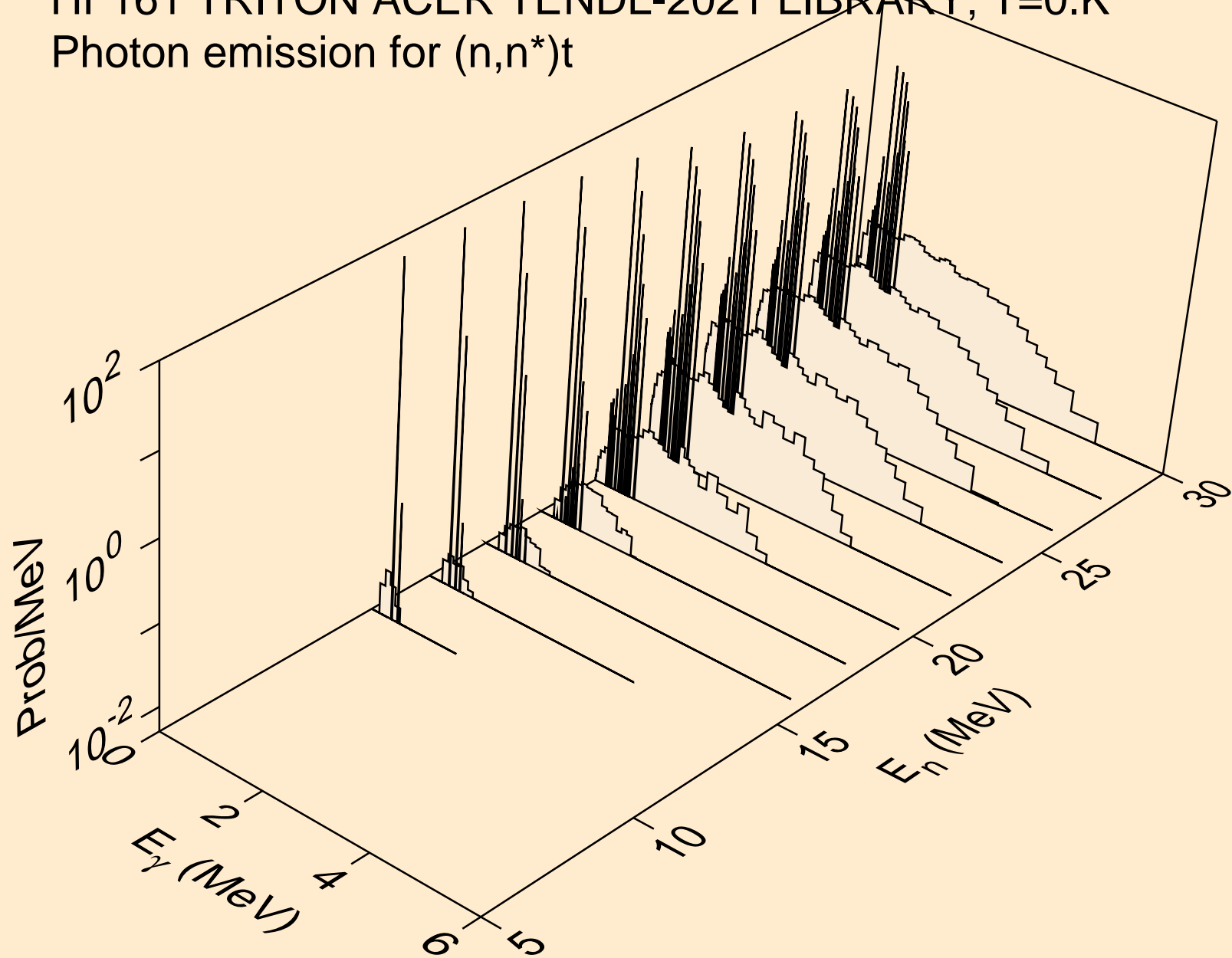

HF161 TRITON ACER TENDL-2021 LIBRARY; T=0.K  
Photon emission for (n,n\*)he3

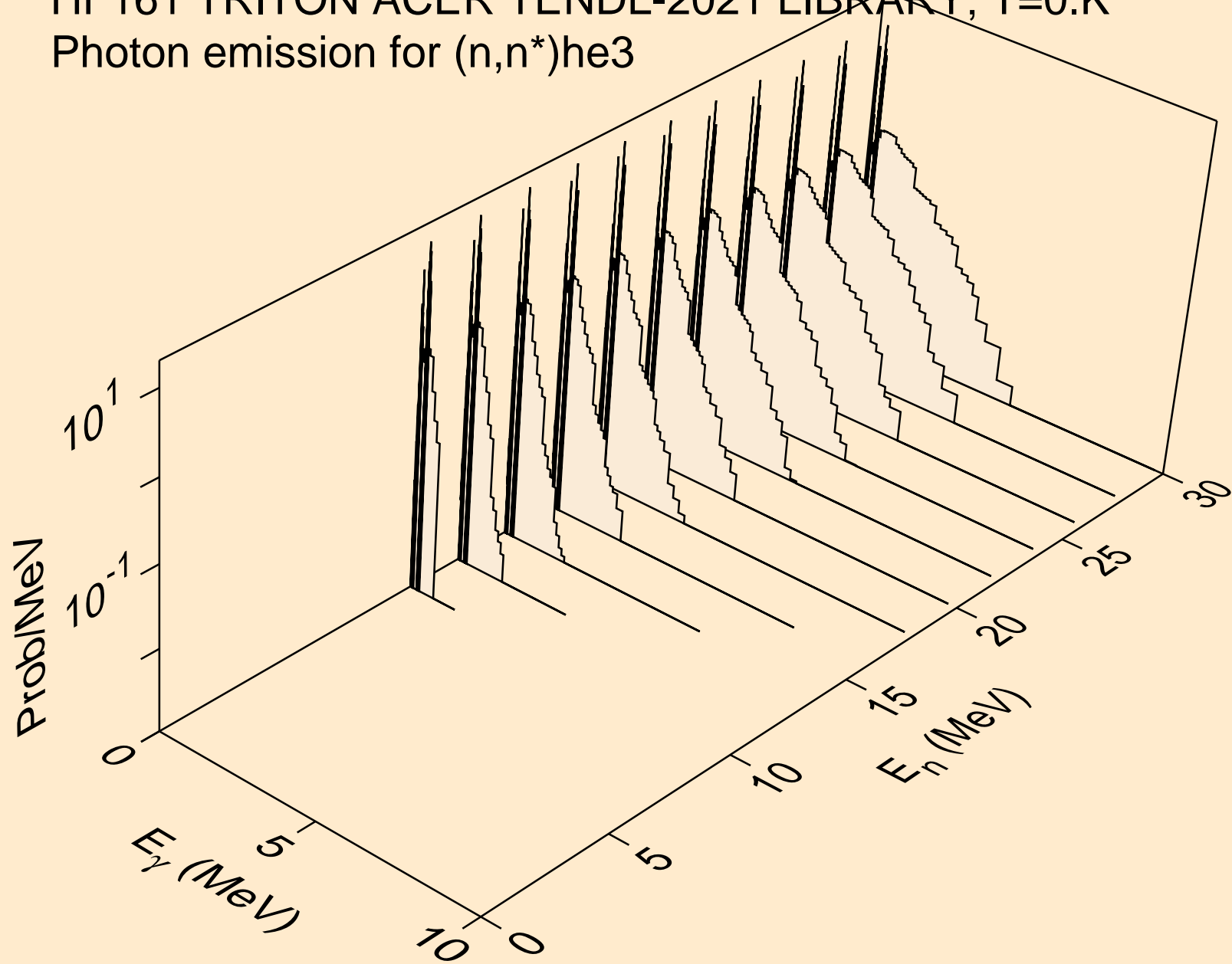

HF161 TRITON ACER TENDL-2021 LIBRARY; T=0.K  
Photon emission for (n,4n)

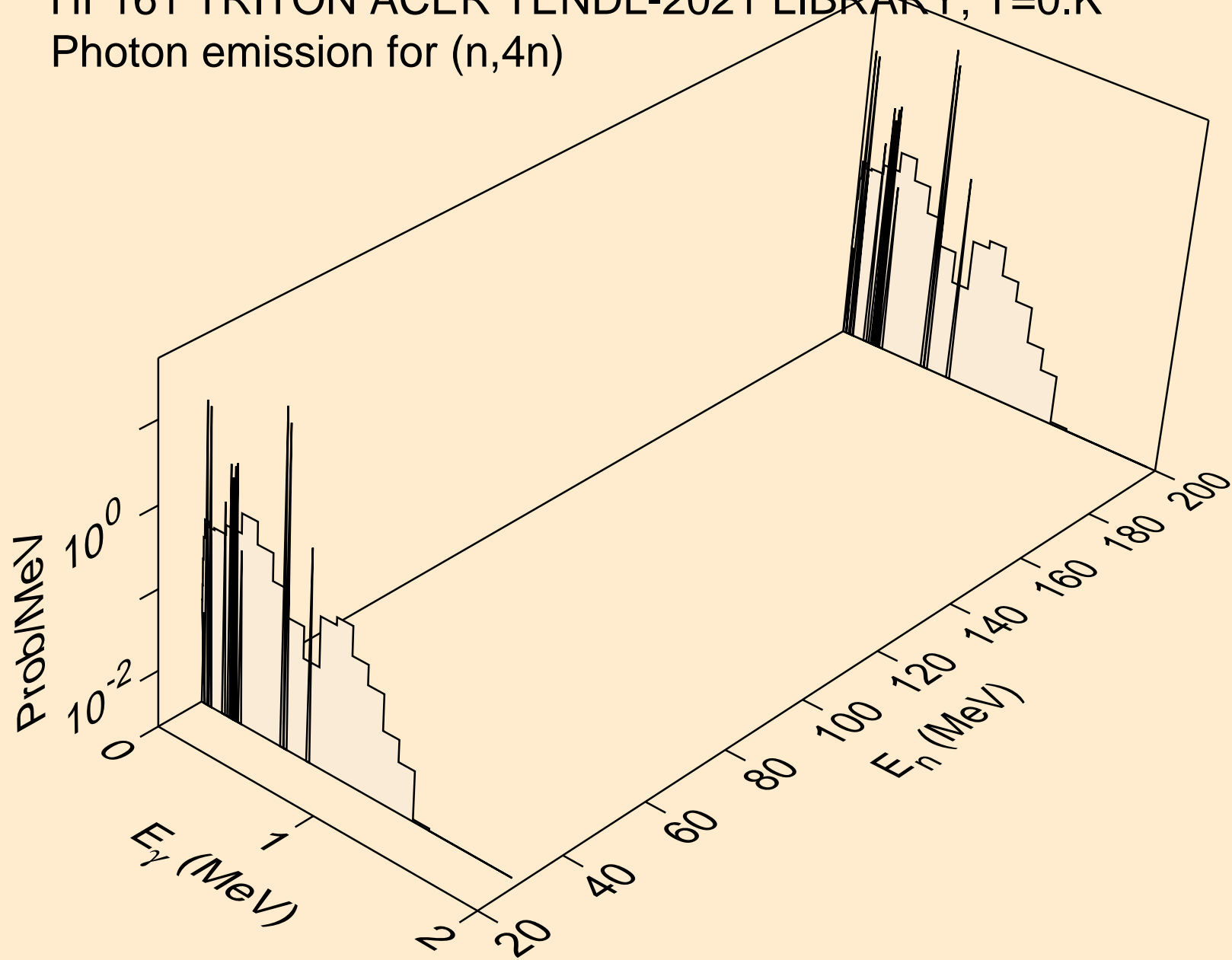

HF161 TRITON ACER TENDL-2021 LIBRARY; T=0.K  
Photon emission for (n,2np)

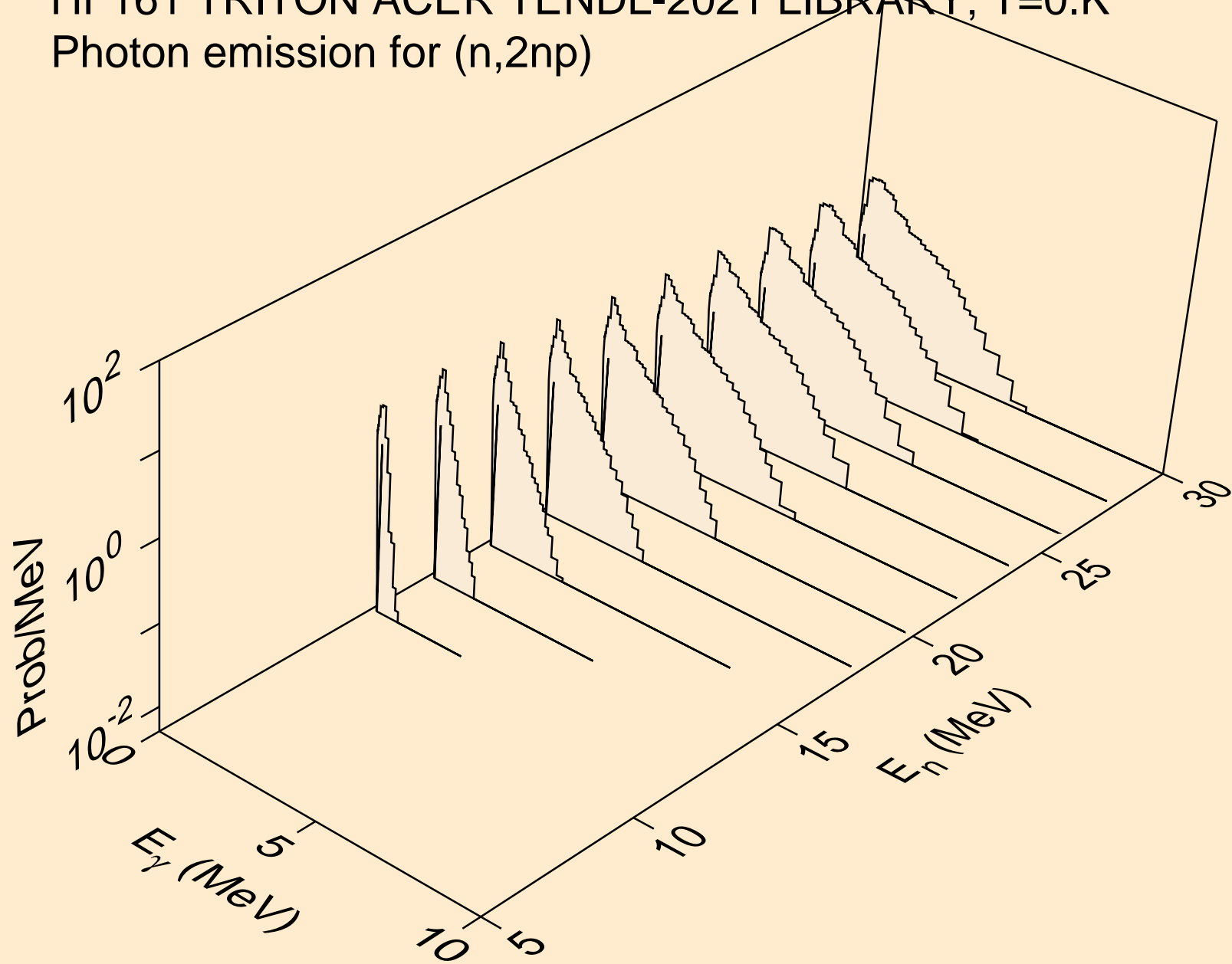

HF161 TRITON ACER TENDL-2021 LIBRARY; T=0.K  
Photon emission for (n,3np)

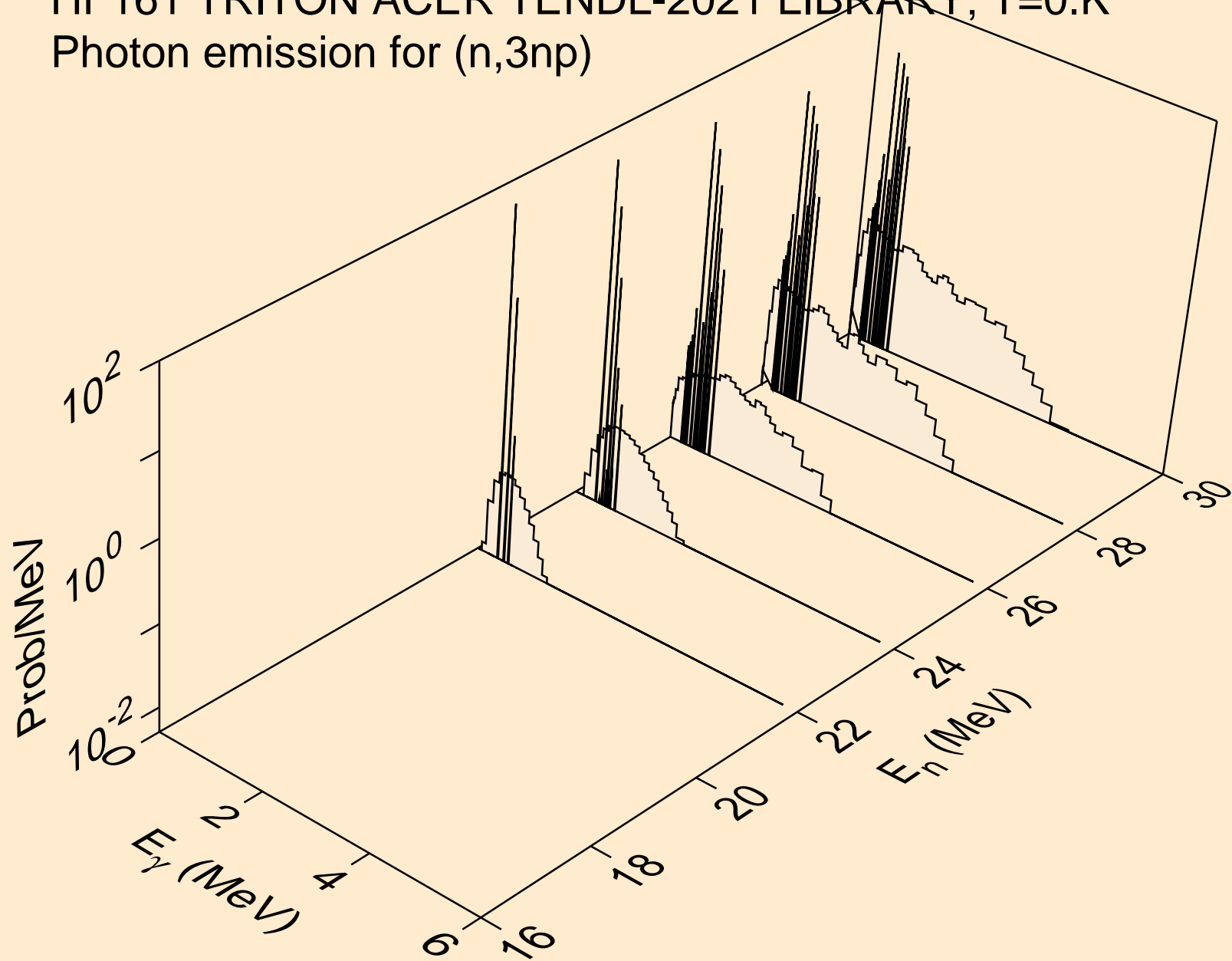

HF161 TRITON ACER TENDL-2021 LIBRARY; T=0.K  
Photon emission for (n,2np)

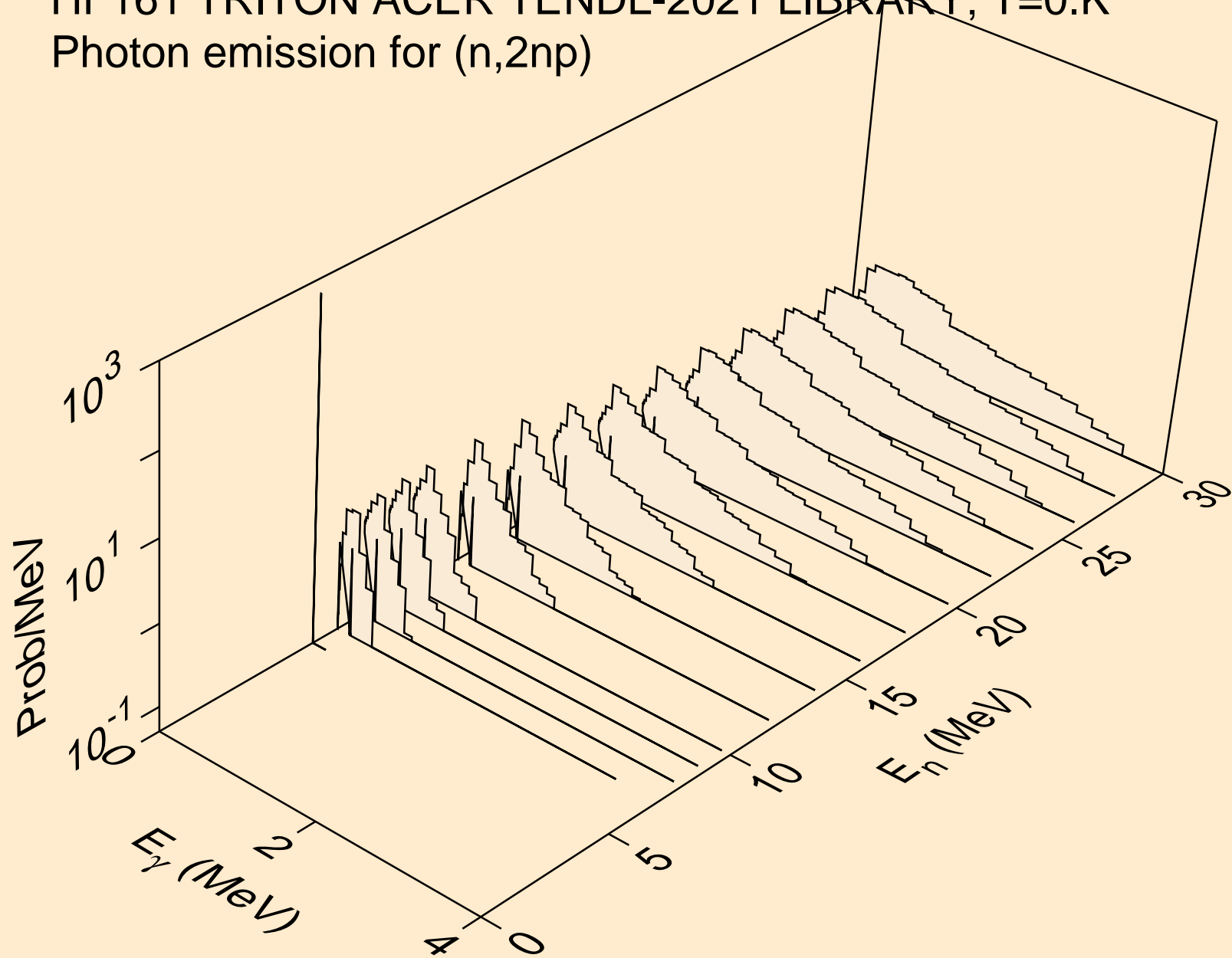



HF161 TRITON ACER TENDL-2021 LIBRARY; T=0.K  
Photon emission for (n,npa)

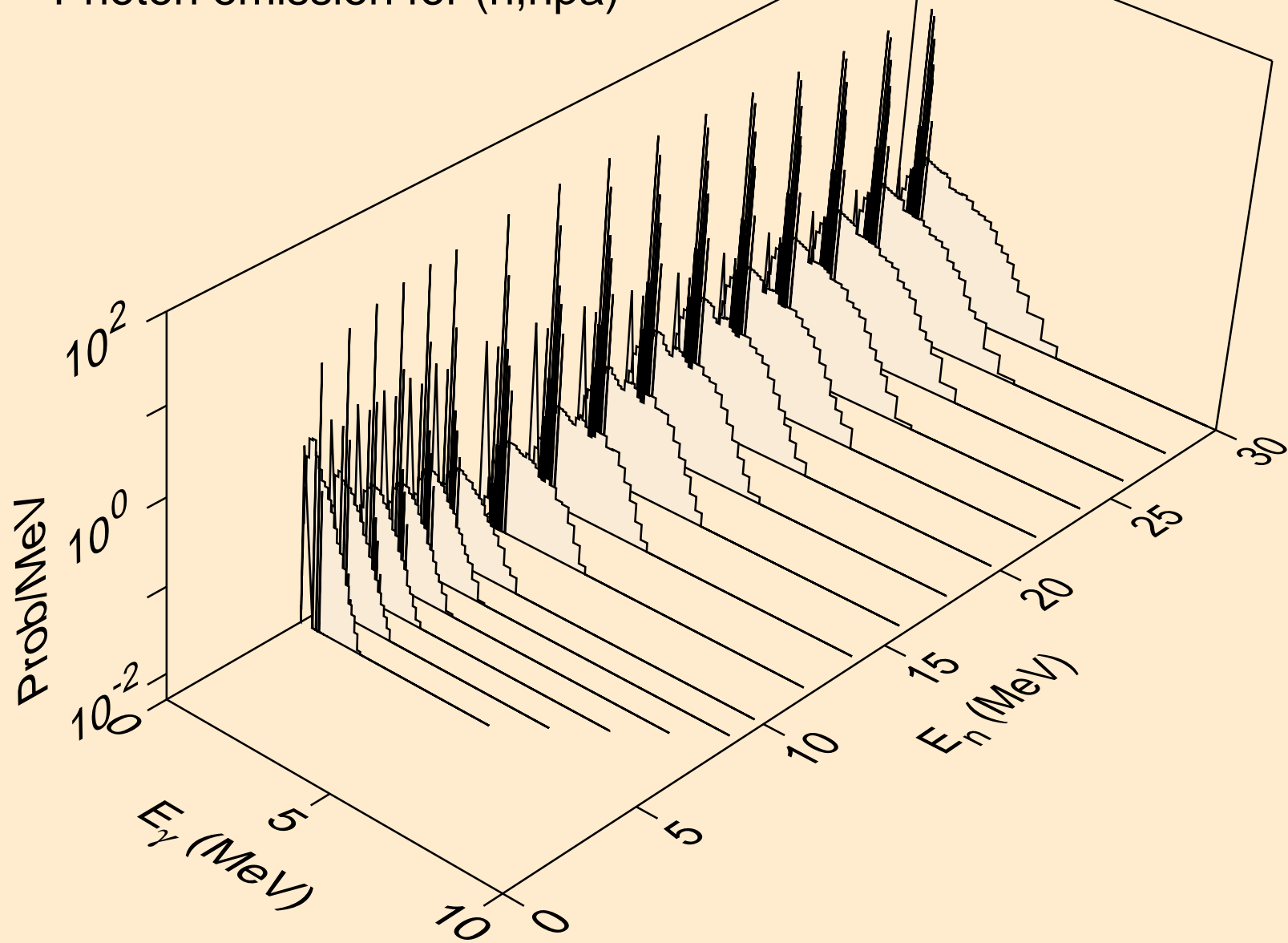

HF161 TRITON ACER TENDL-2021 LIBRARY; T=0.K  
Photon emission for (n,gma)

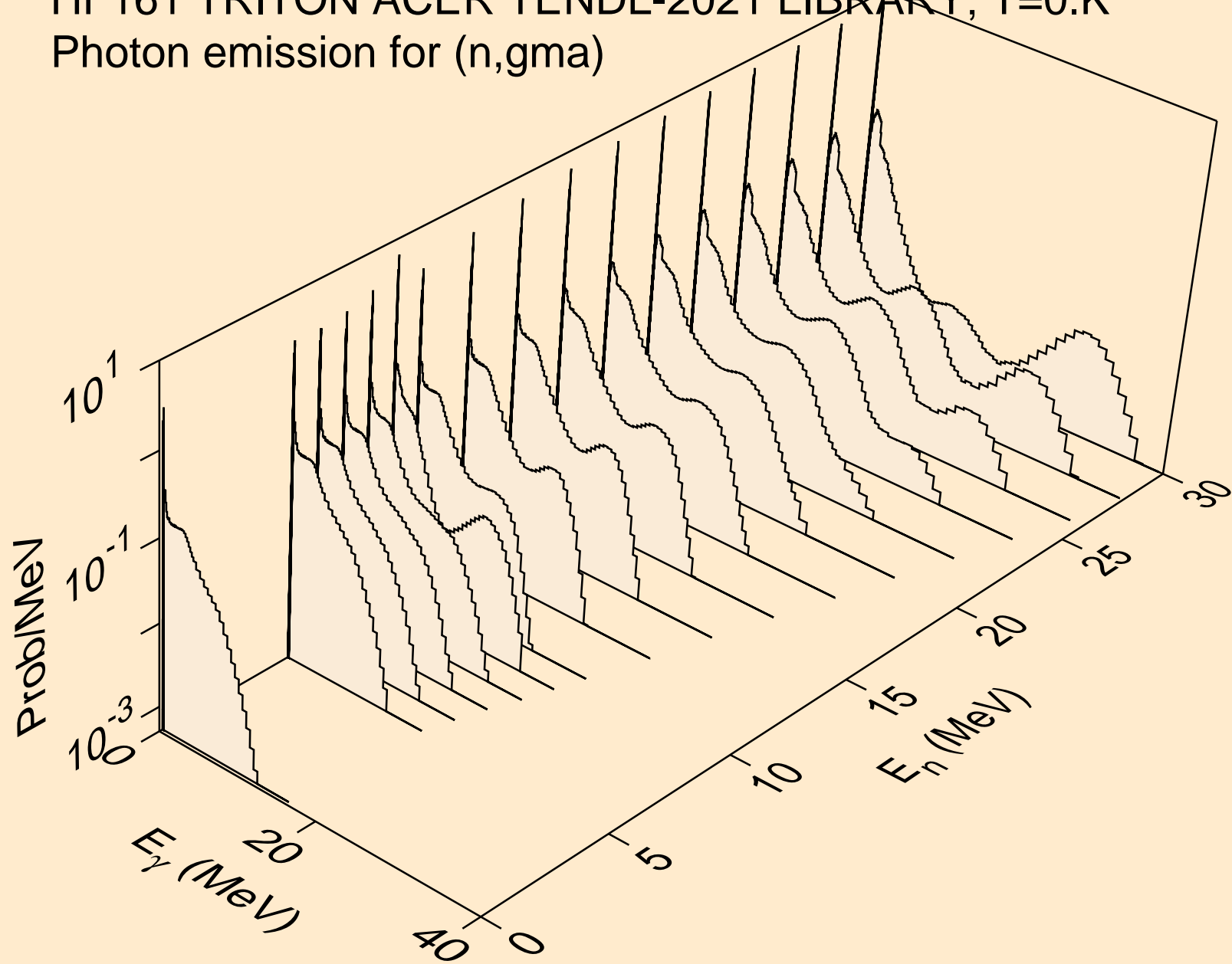

HF161 TRITON ACER TENDL-2021 LIBRARY; T=0.K  
Photon emission for (n,p)

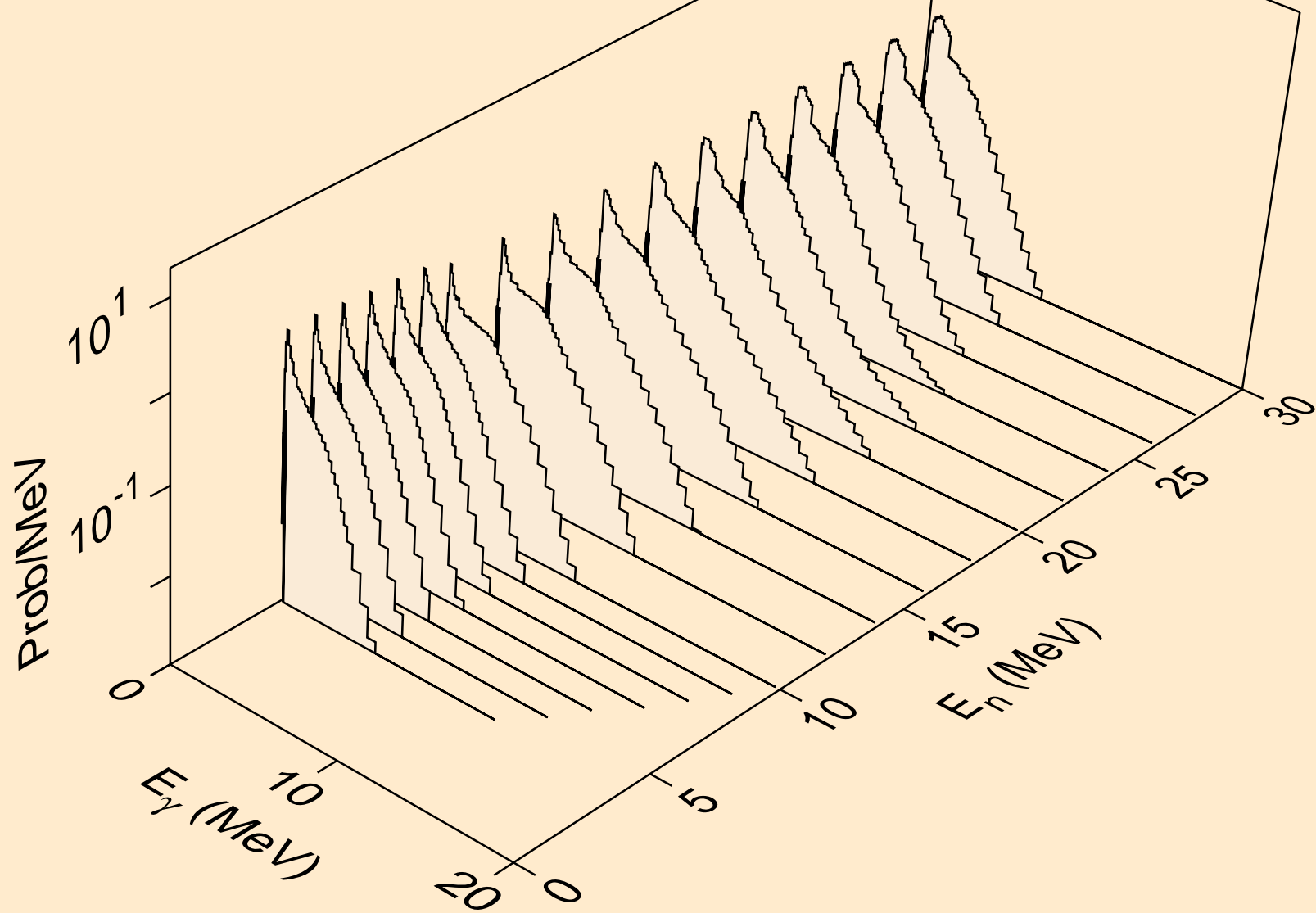

HF161 TRITON ACER TENDL-2021 LIBRARY; T=0.K  
Photon emission for (n,d)

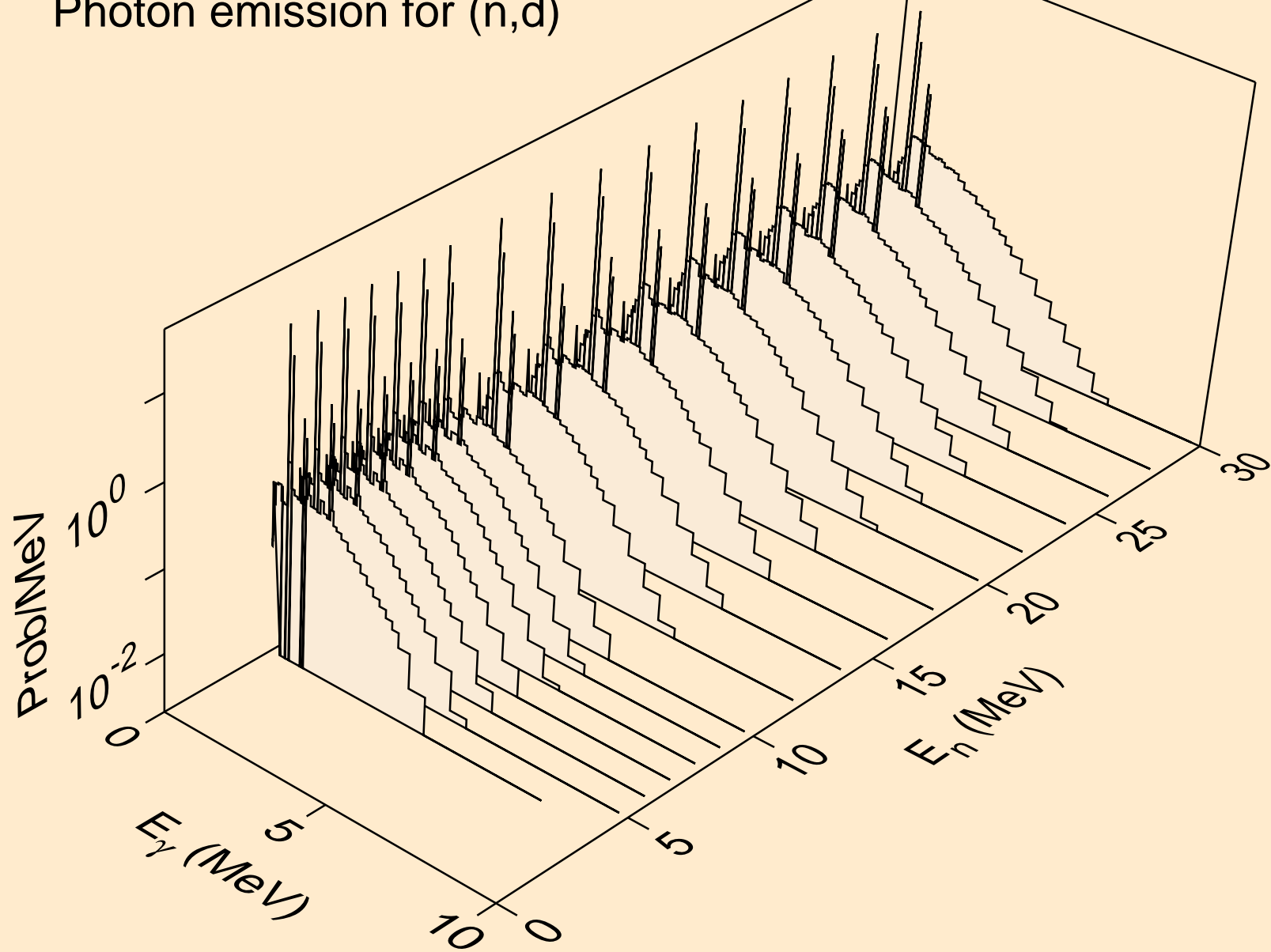

HF161 TRITON ACER TENDL-2021 LIBRARY; T=0.K  
Photon emission for inelastic

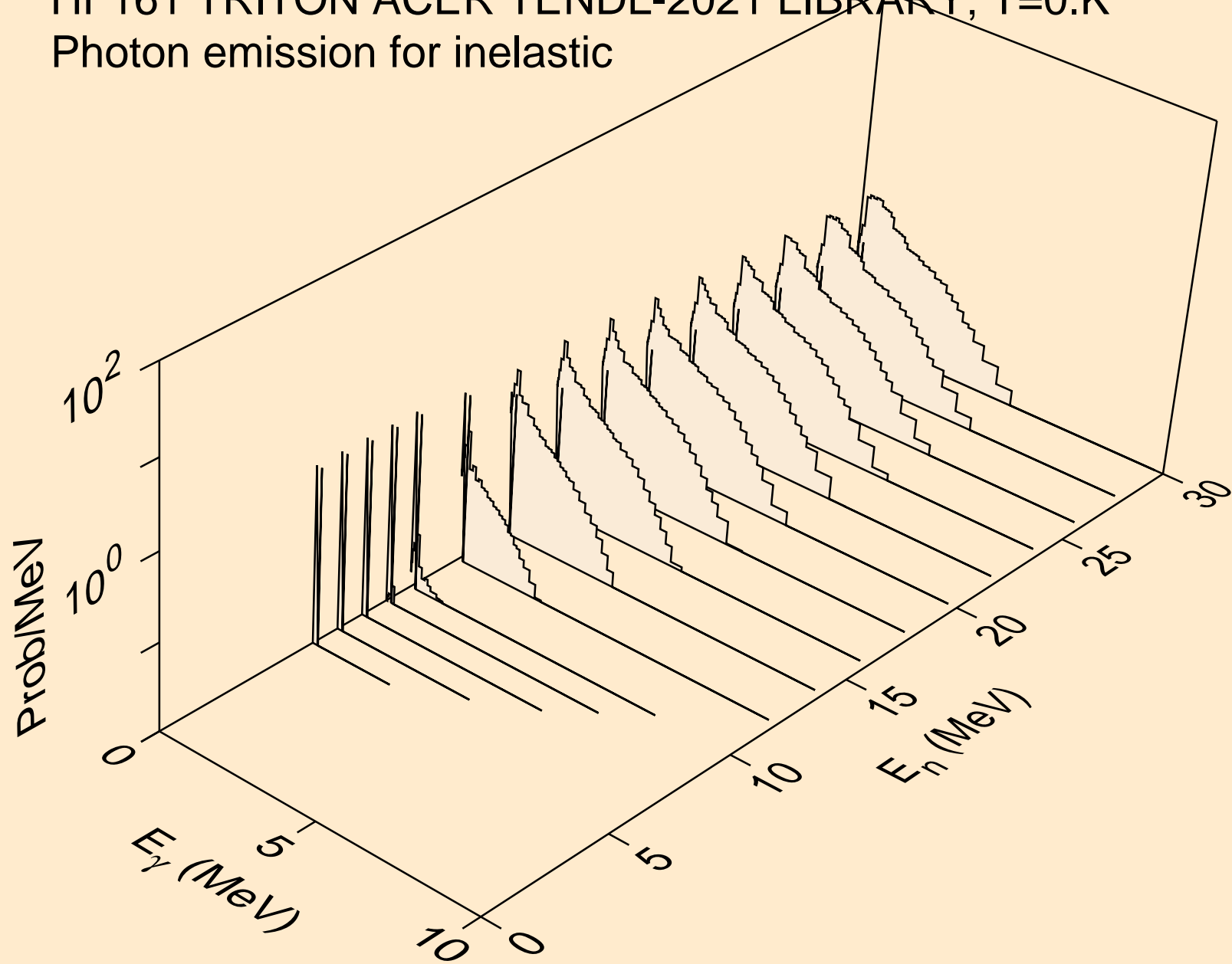

HF161 TRITON ACER TENDL-2021 LIBRARY; T=0.K  
Photon emission for (n,he3)

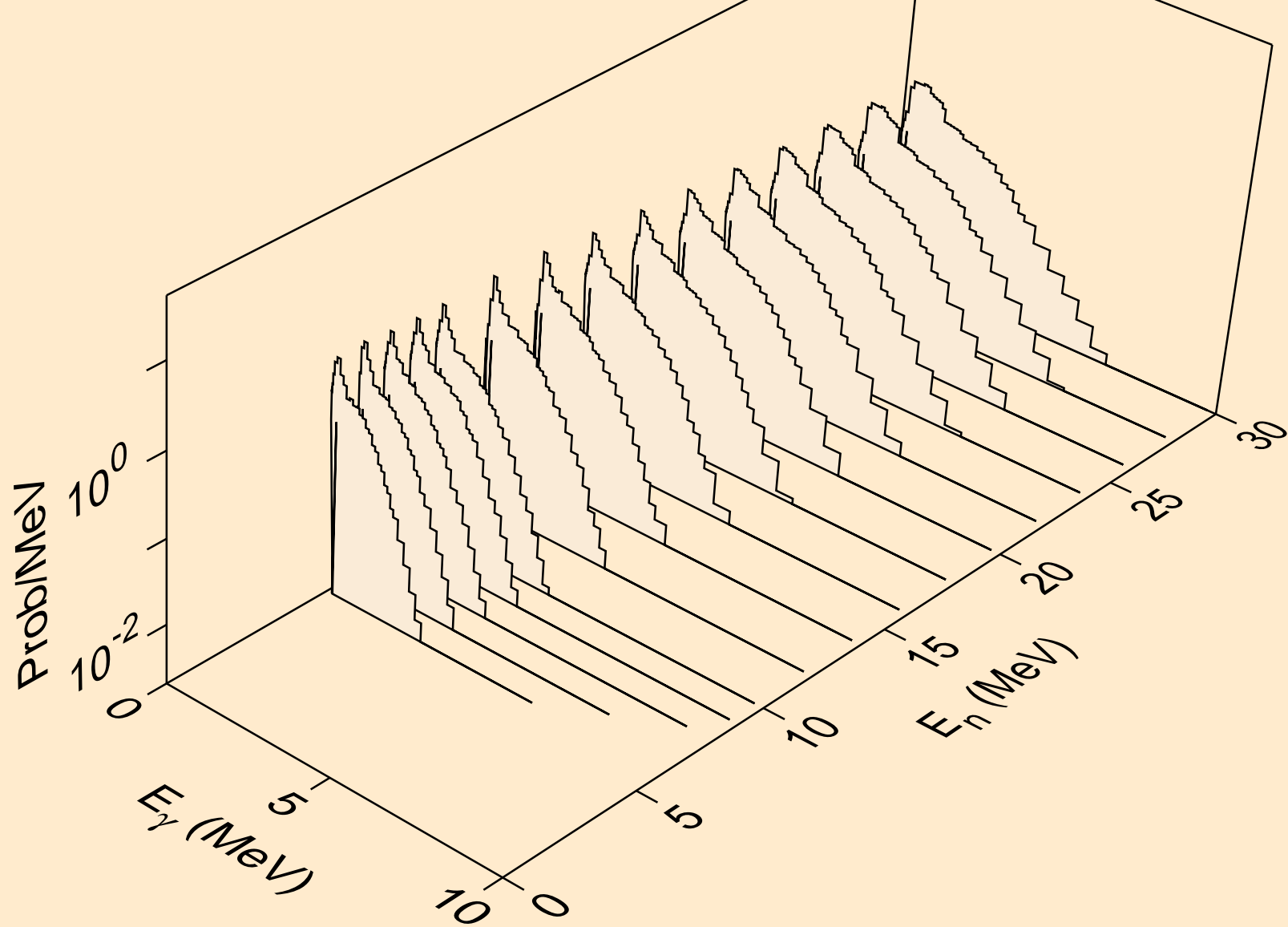

HF161 TRITON ACER TENDL-2021 LIBRARY; T=0.K  
Photon emission for (n,a)

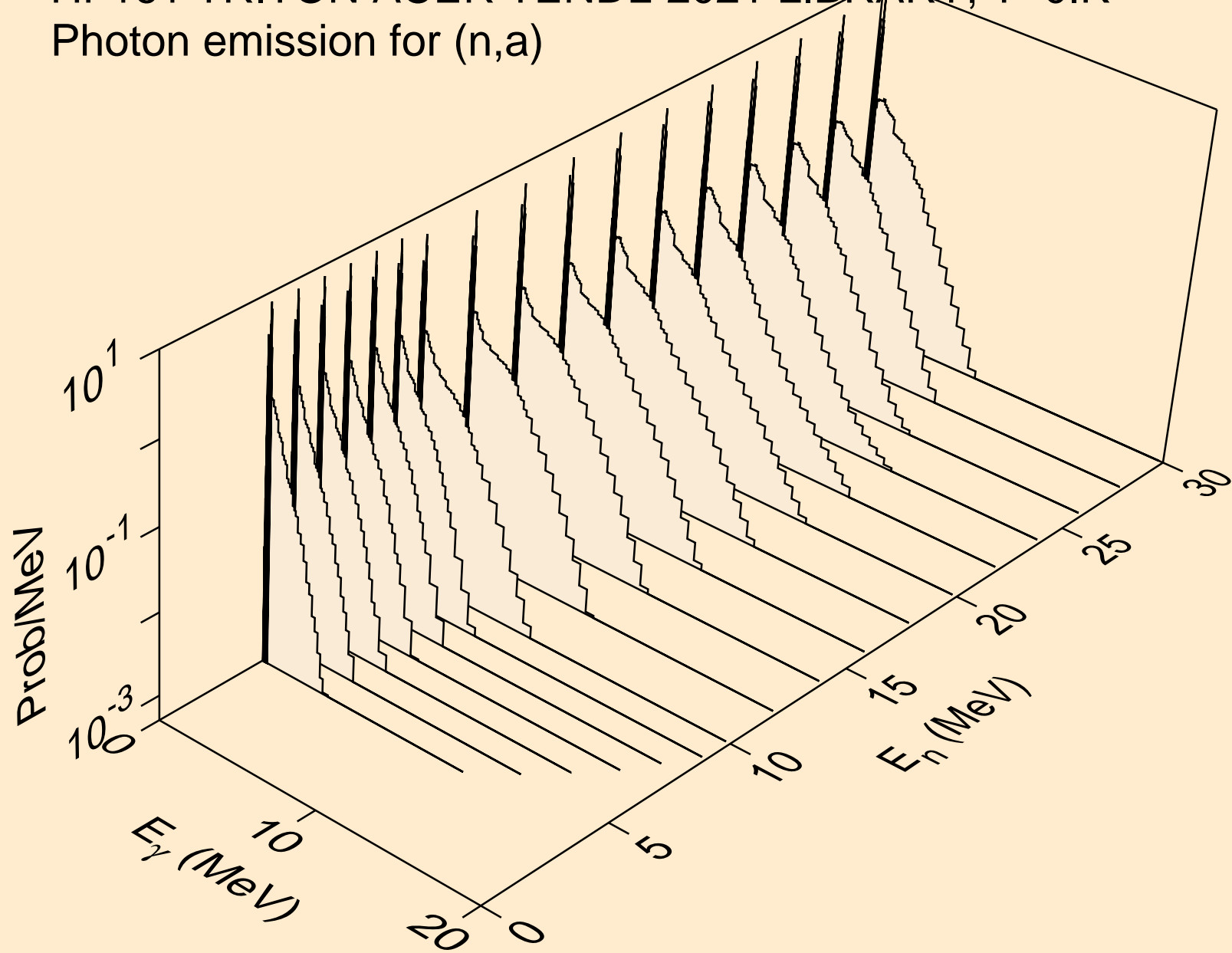

HF161 TRITON ACER TENDL-2021 LIBRARY; T=0.K  
Photon emission for (n,2a)

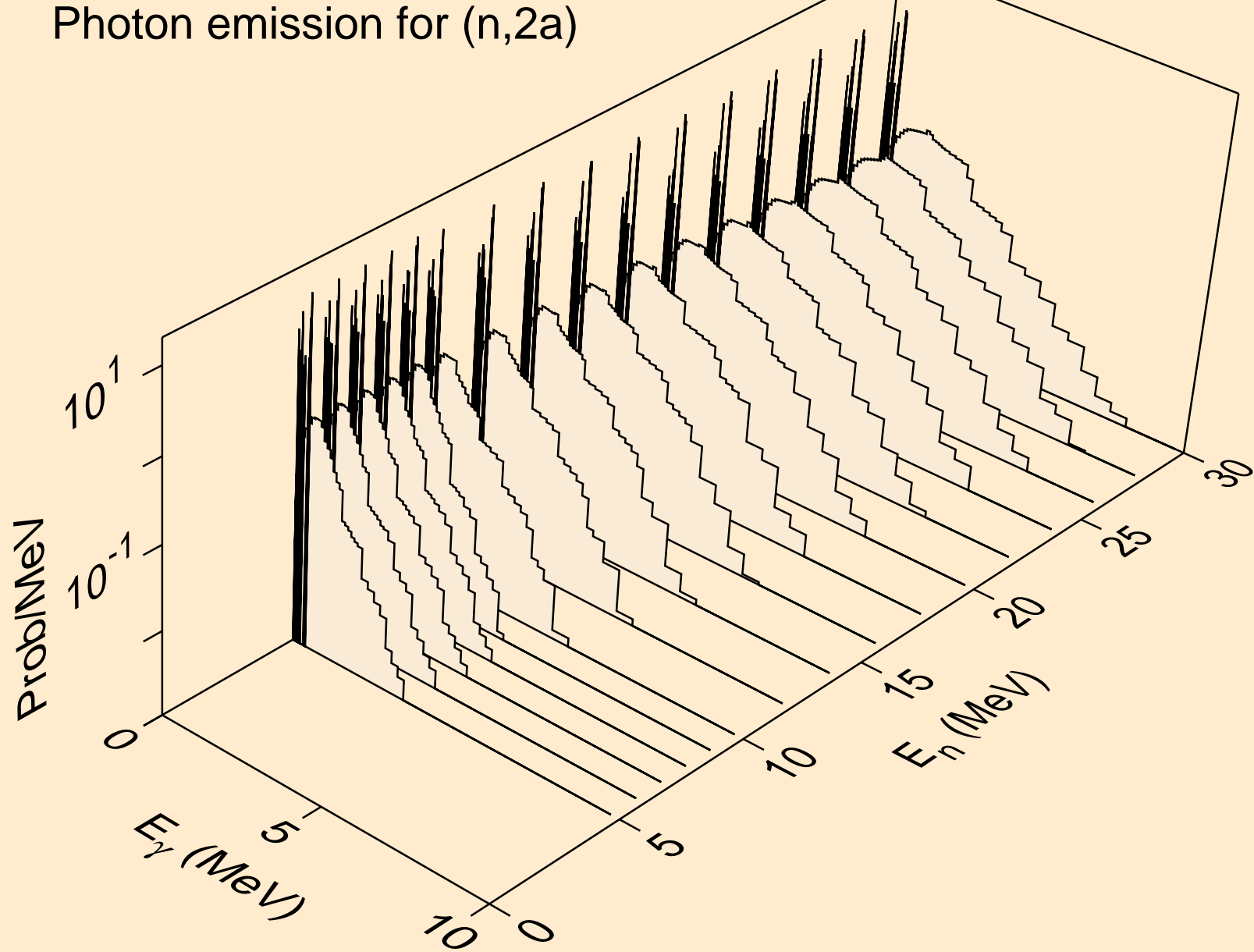



HF161 TRITON ACER TENDL-2021 LIBRARY; T=0.K  
Photon emission for (n,3a)

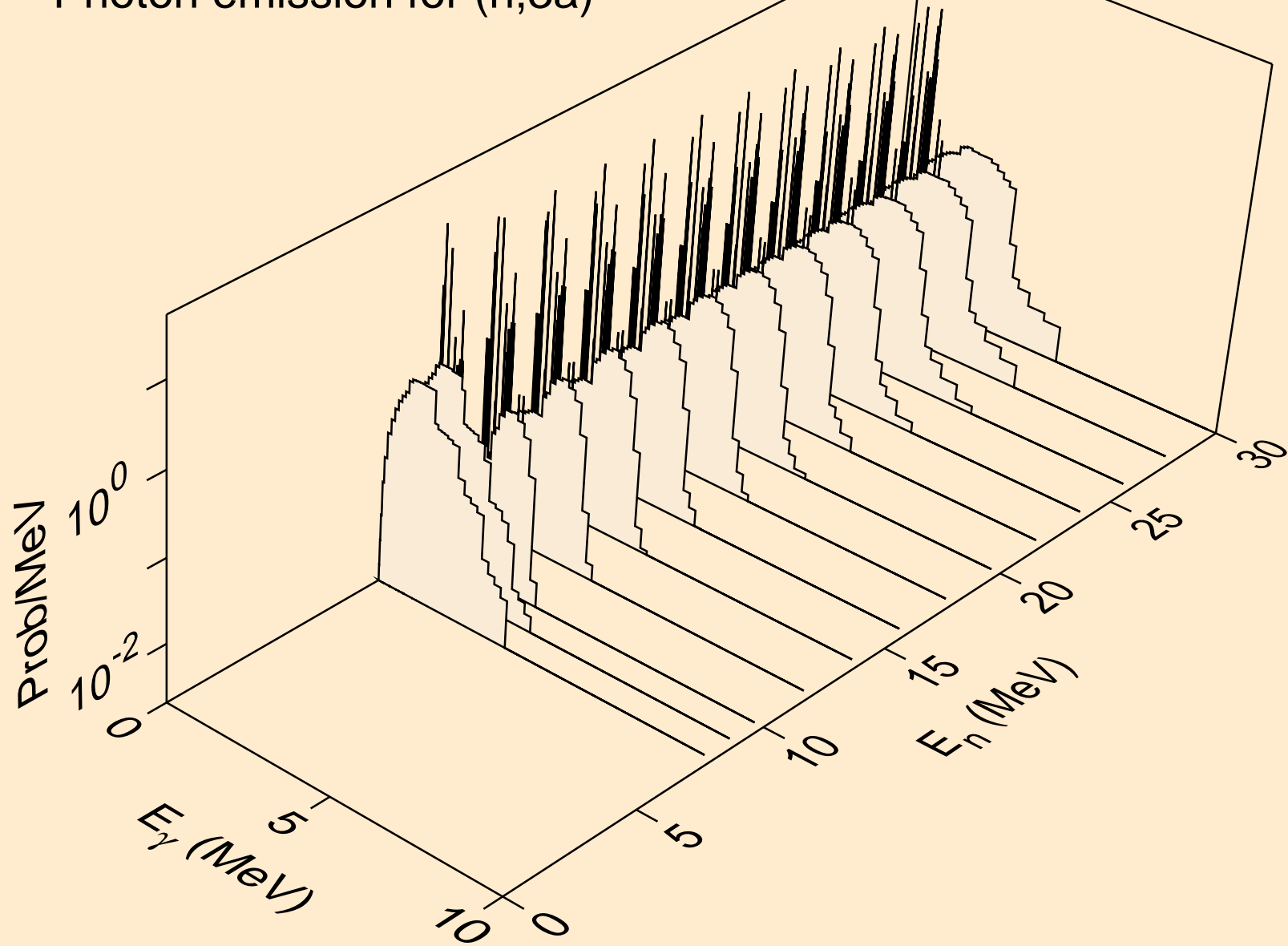

HF161 TRITON ACER TENDL-2021 LIBRARY; T=0.K  
Photon emission for (n,2p)

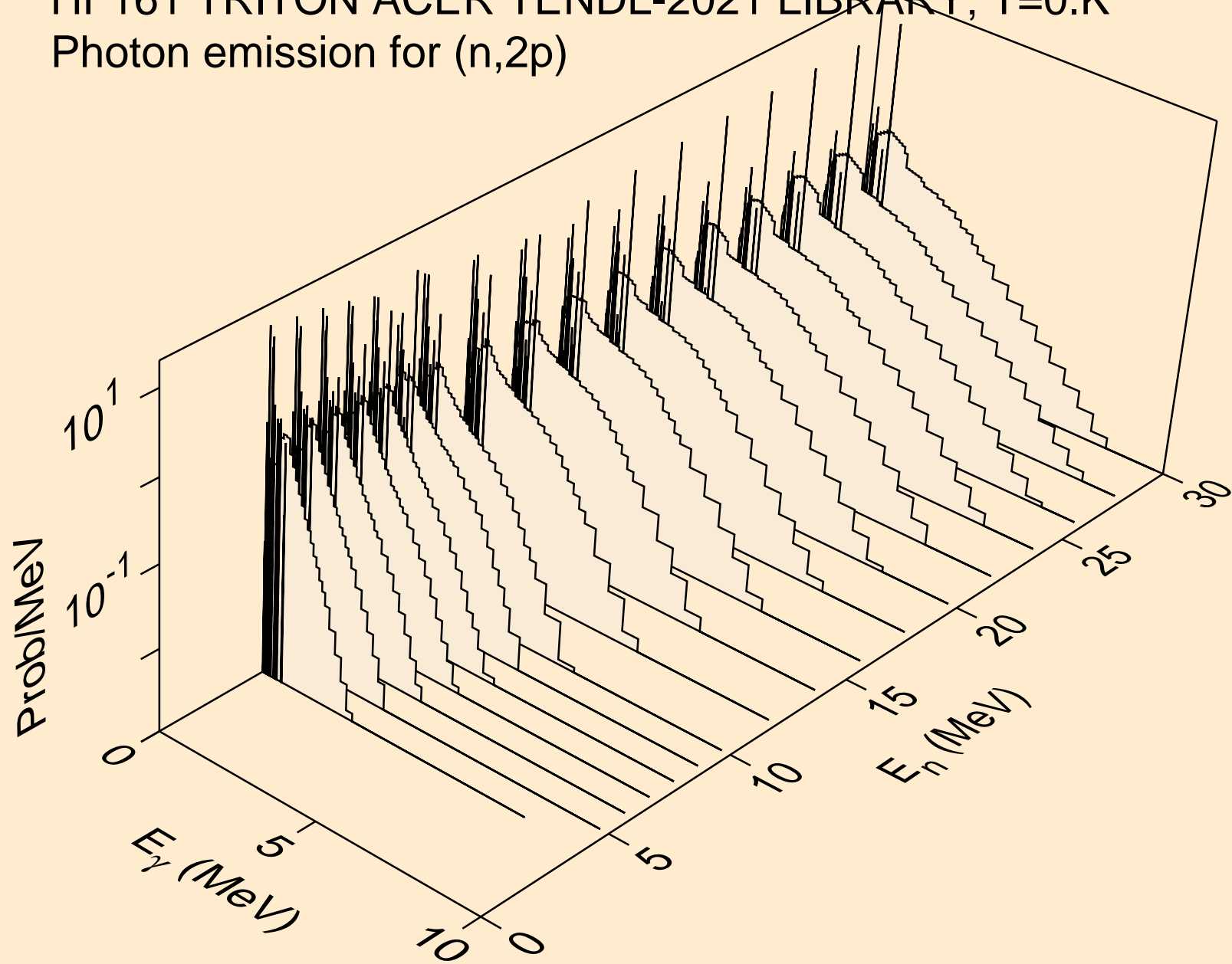

HF161 TRITON ACER TENDL-2021 LIBRARY; T=0.K  
Photon emission for (n,pa)

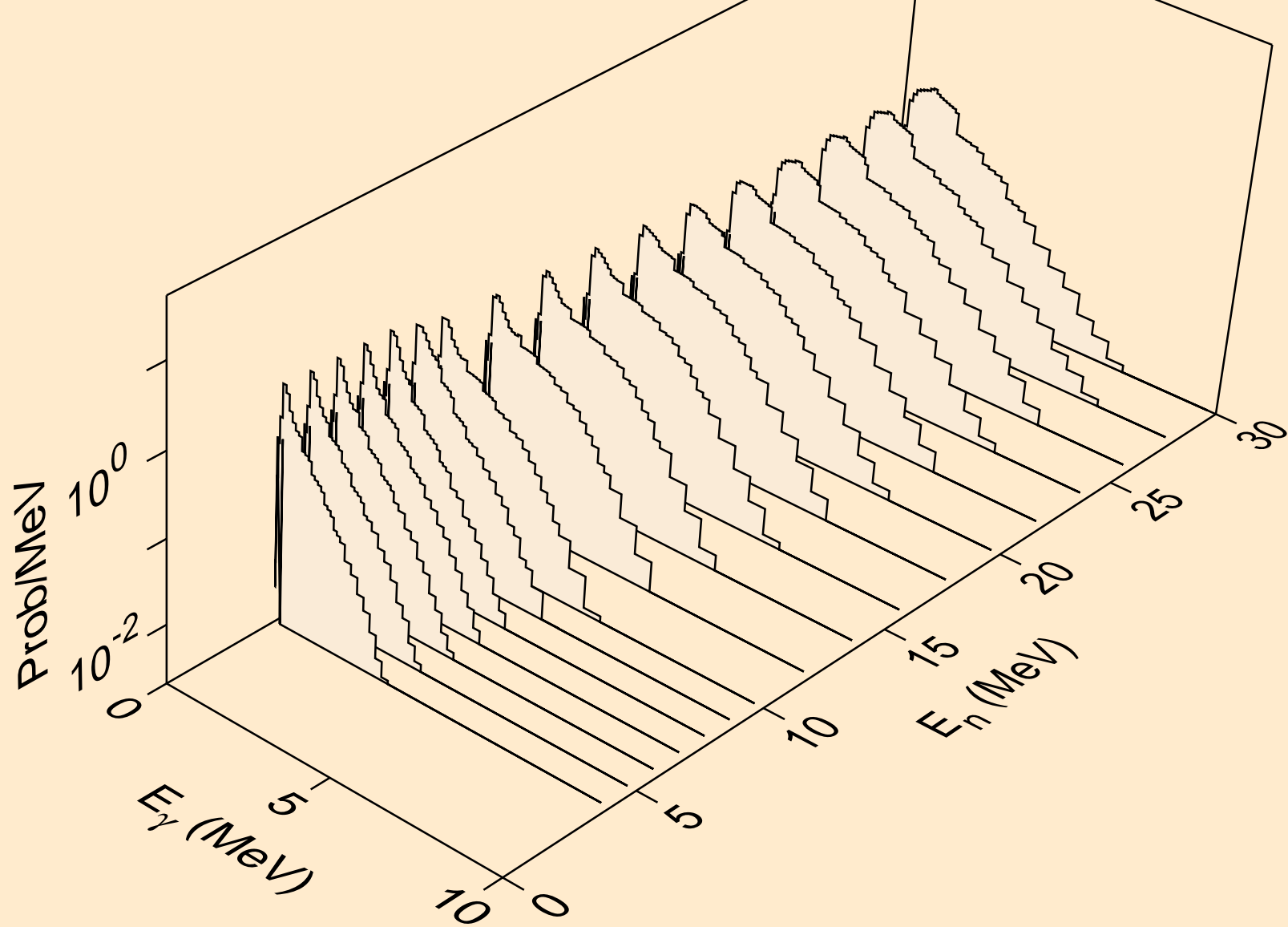

HF161 TRITON ACER TENDL-2021 LIBRARY; T=0.K  
Photon emission for (n,t2a)

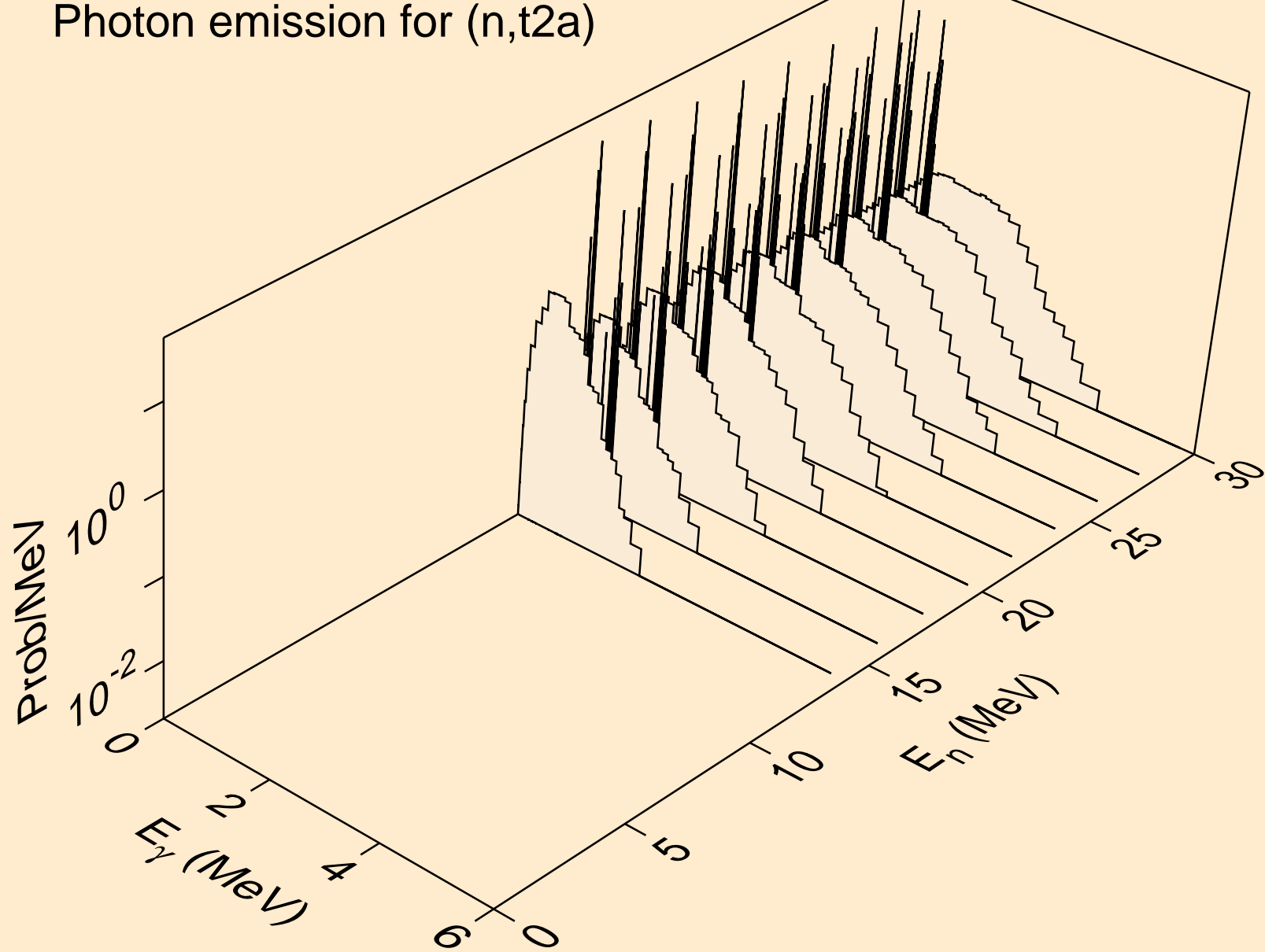

HF161 TRITON ACER TENDL-2021 LIBRARY; T=0.K  
Photon emission for (n,d2a)

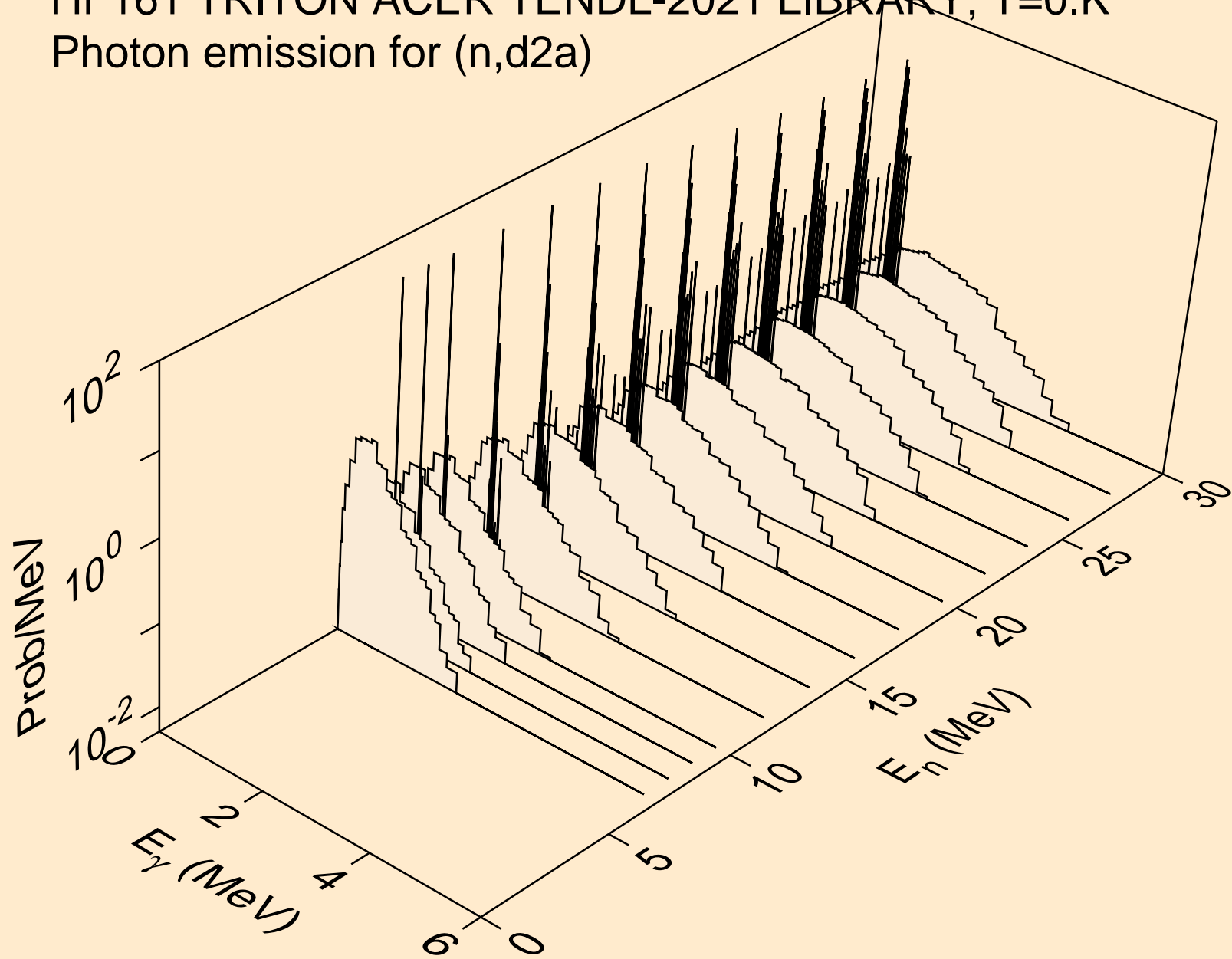

HF161 TRITON ACER TENDL-2021 LIBRARY; T=0.K  
Photon emission for (n,pd)

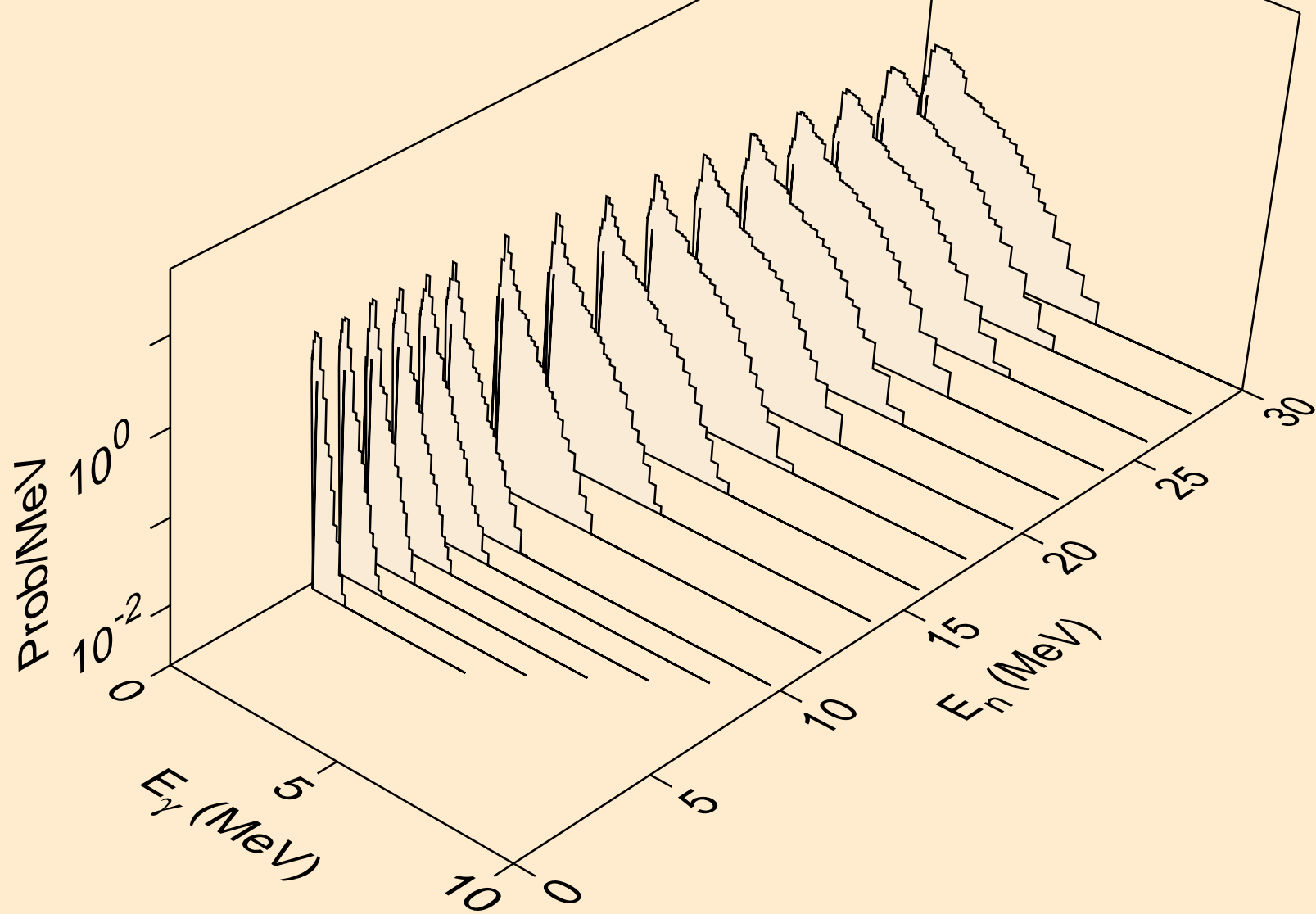

HF161 TRITON ACER TENDL-2021 LIBRARY; T=0.K  
Photon emission for (n,pt)

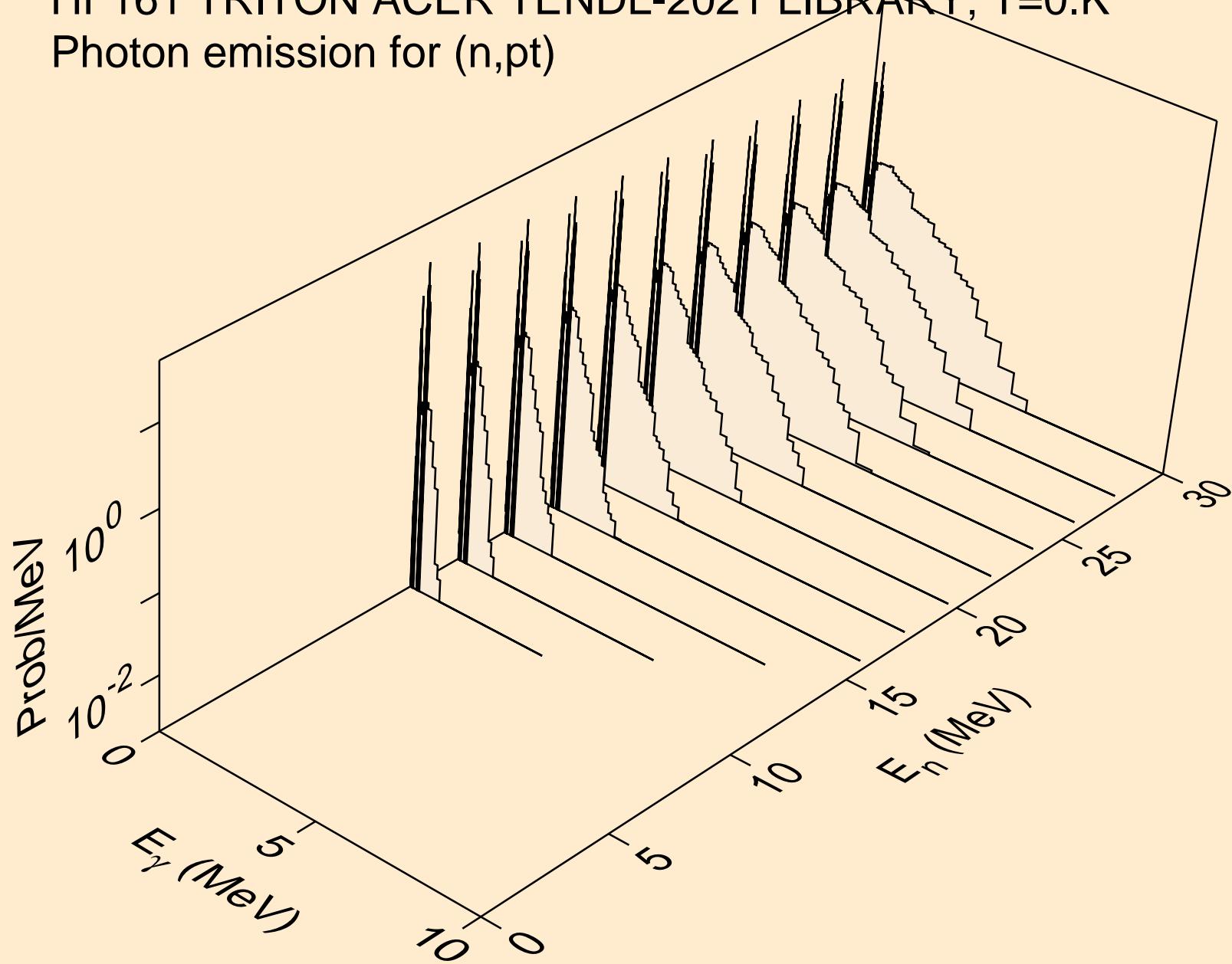

HF161 TRITON ACER TENDL-2021 LIBRARY; T=0.K  
Photon emission for (n,da)

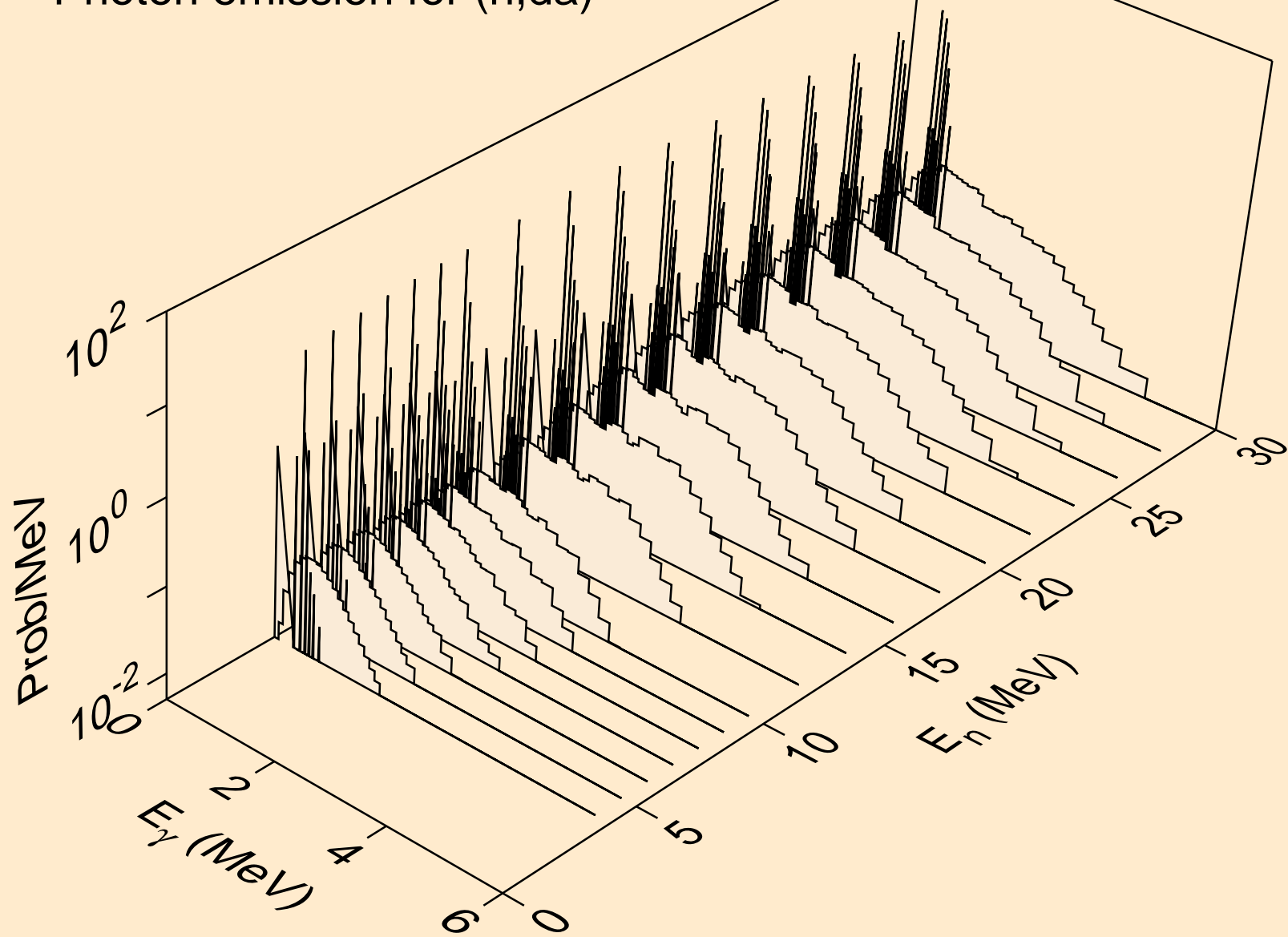



# HF161 TRITON ACER TENDL-2021 LIBRARY; T=0.K

## Particle heating contributions

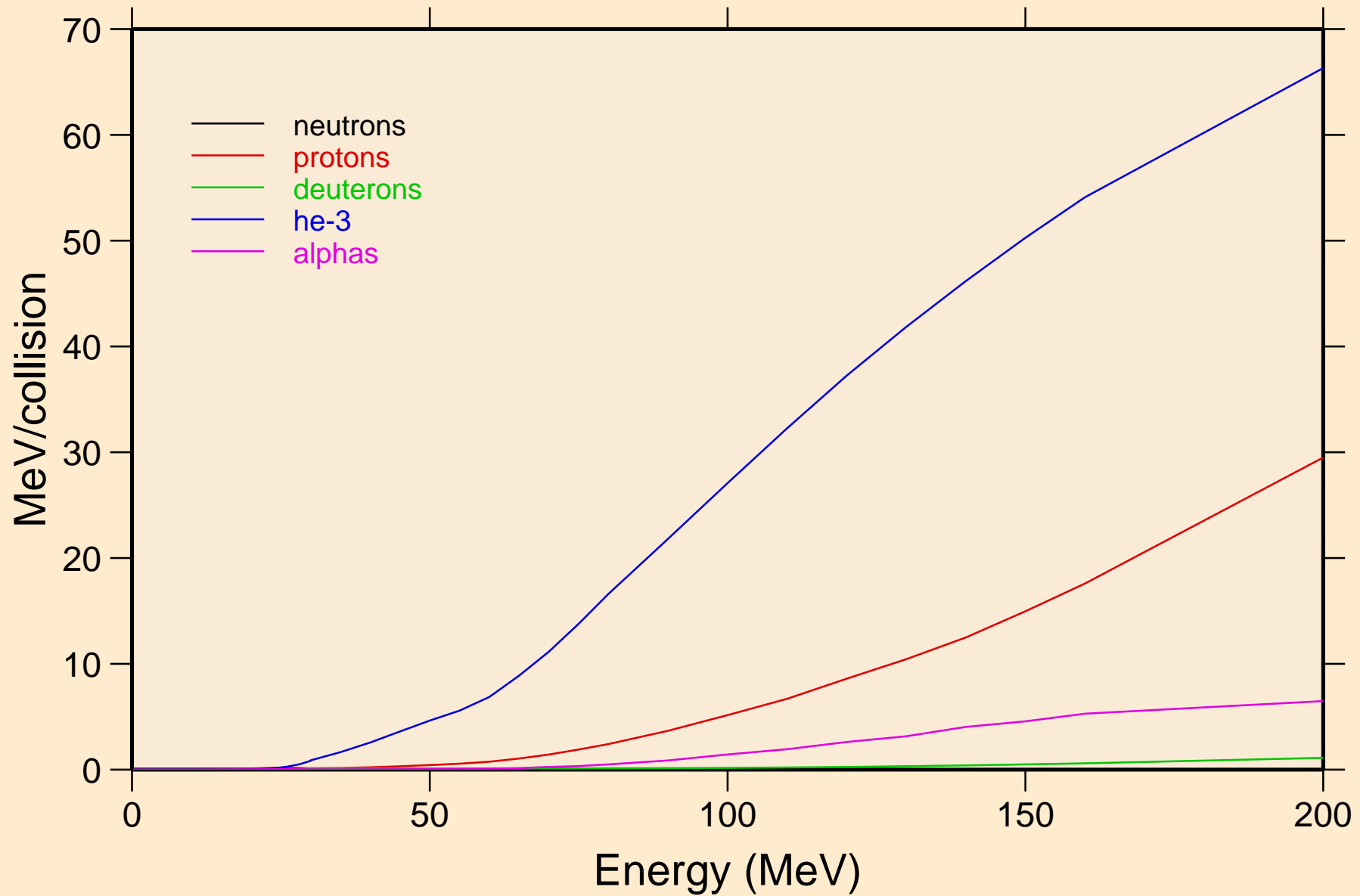

HF161 TRITON ACER TENDL-2021 LIBRARY; T=0.K  
Recoil Heating

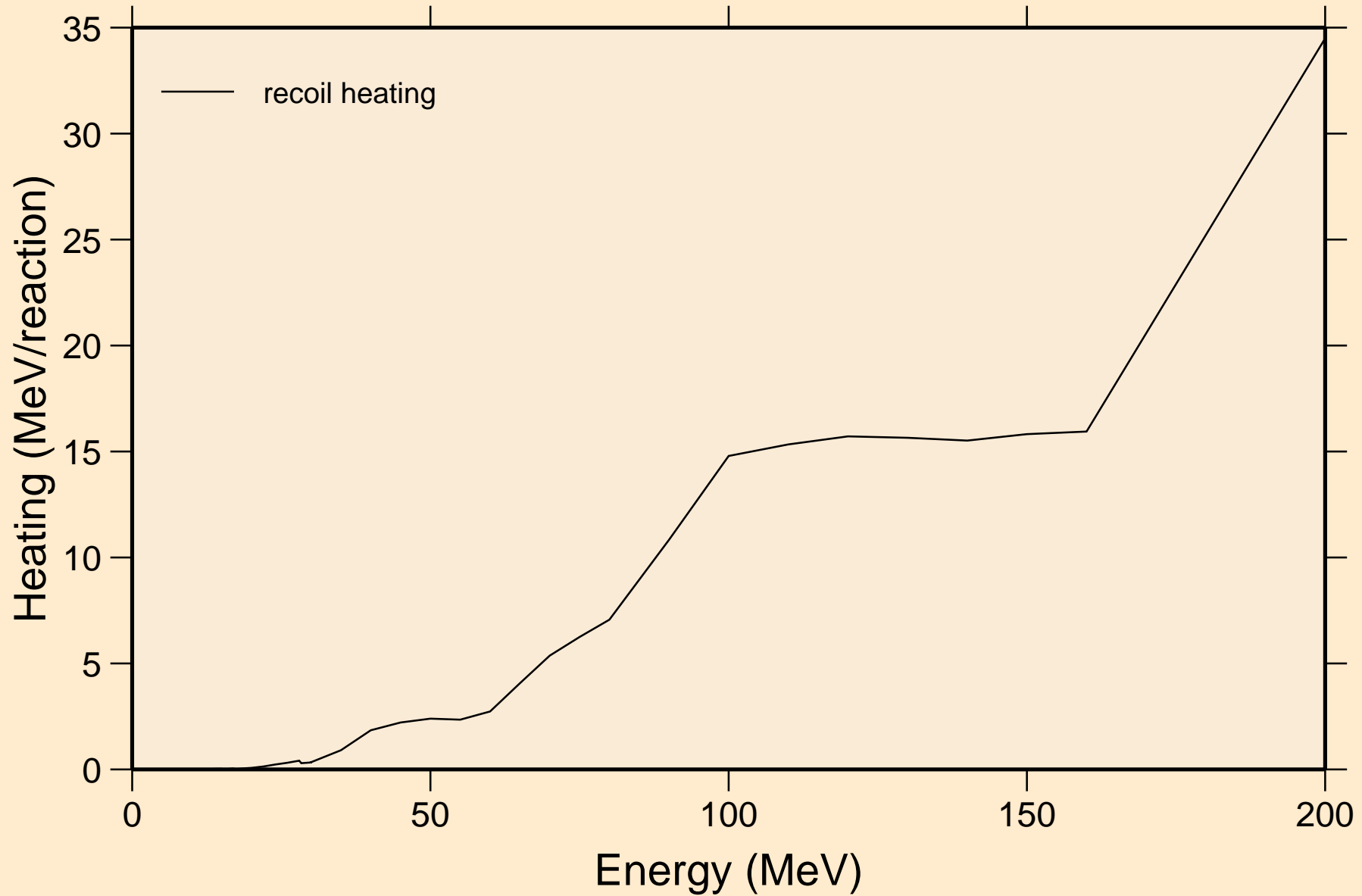

HF161 TRITON ACER TENDL-2021 LIBRARY; T=0.K  
Particle production cross sections

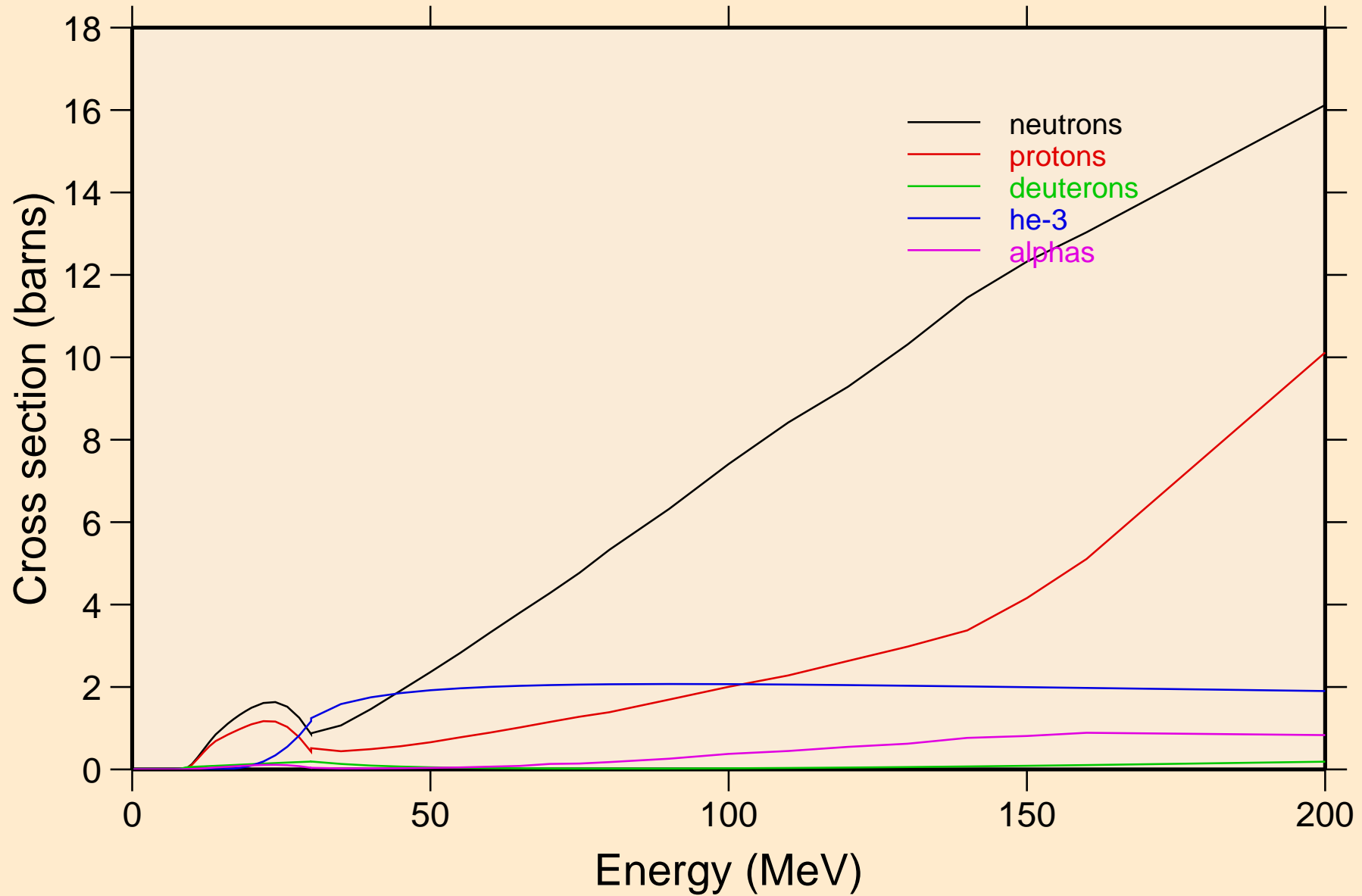

HF161 TRITON ACER TENDL-2021 LIBRARY; T=0.K  
neutrons from (t,n)

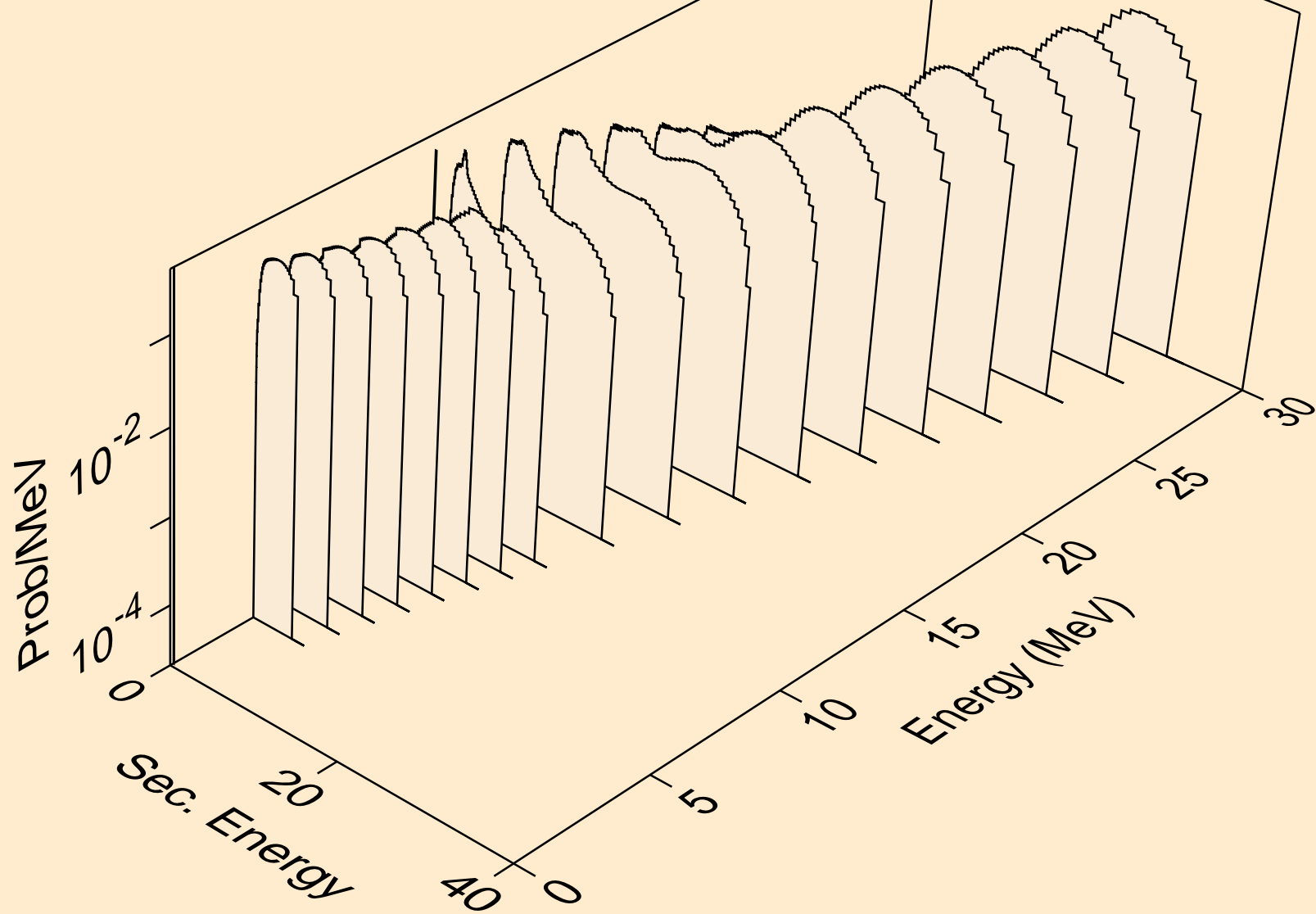

HF161 TRITON ACER TENDL-2021 LIBRARY; T=0.K  
neutrons from (t,x)

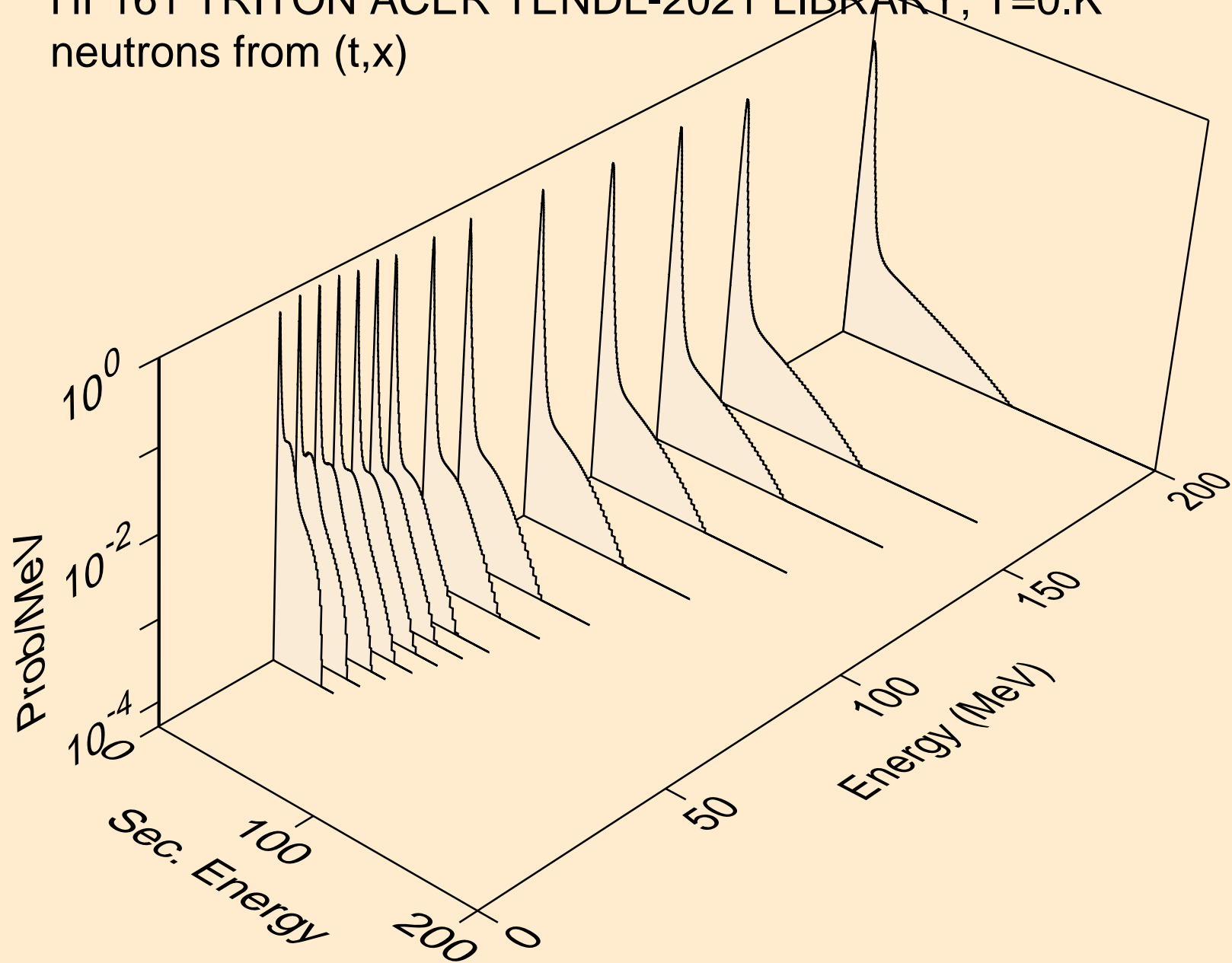

HF161 TRITON ACER TENDL-2021 LIBRARY; T=0.K  
neutrons from (t,2nd)

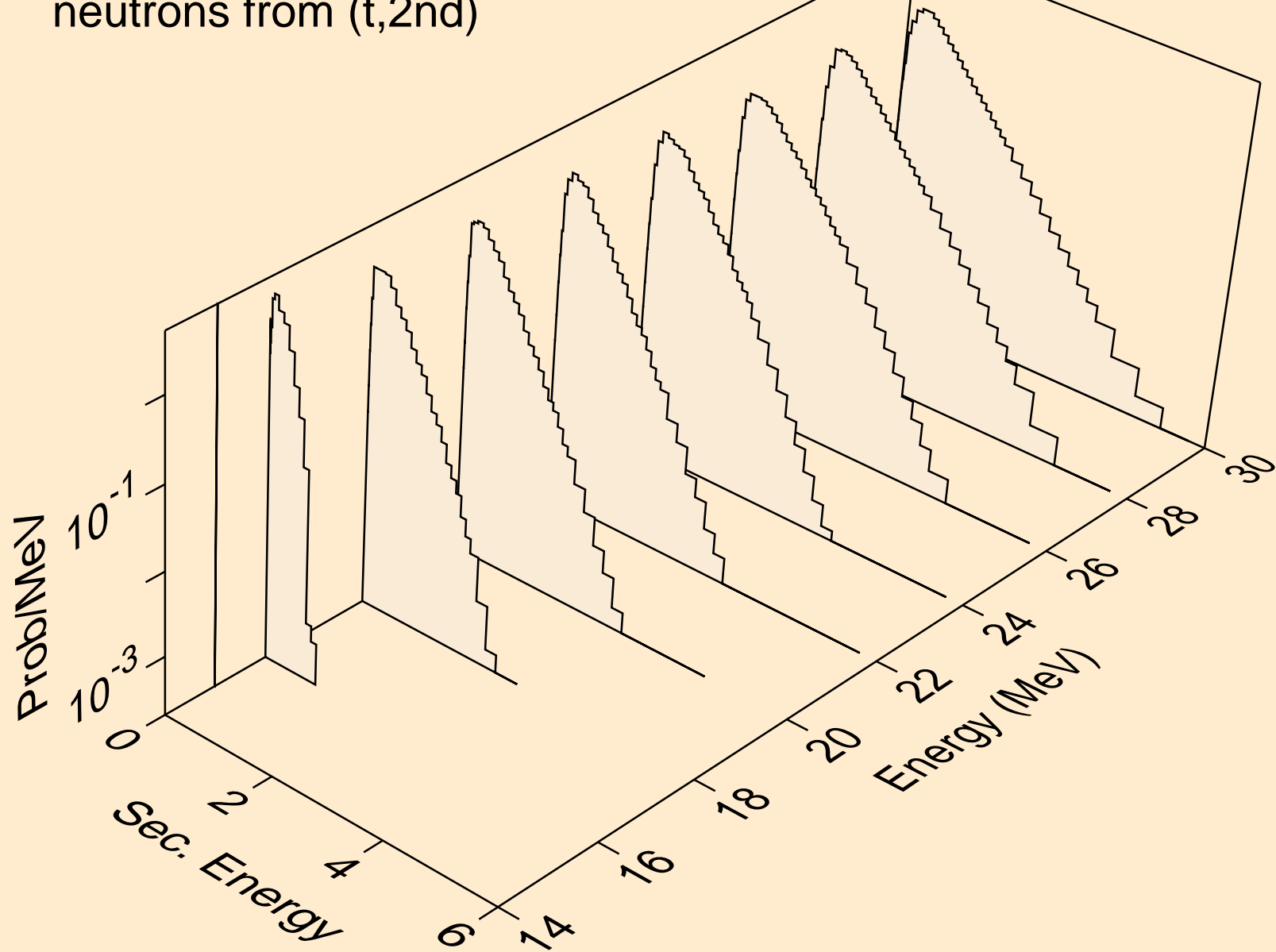

HF161 TRITON ACER TENDL-2021 LIBRARY; T=0.K  
neutrons from (t,2n)

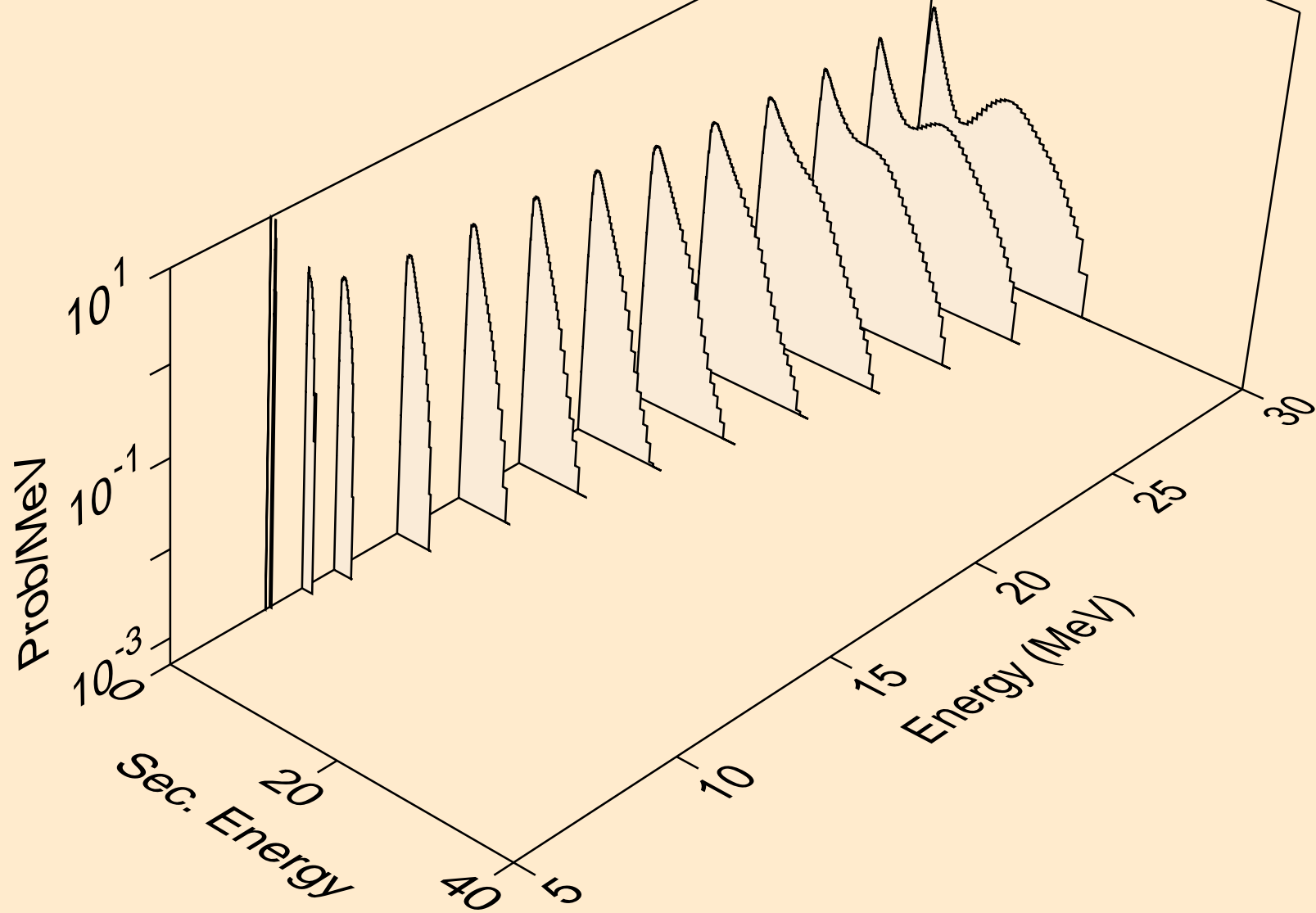

HF161 TRITON ACER TENDL-2021 LIBRARY; T=0.K  
neutrons from (t,3n)

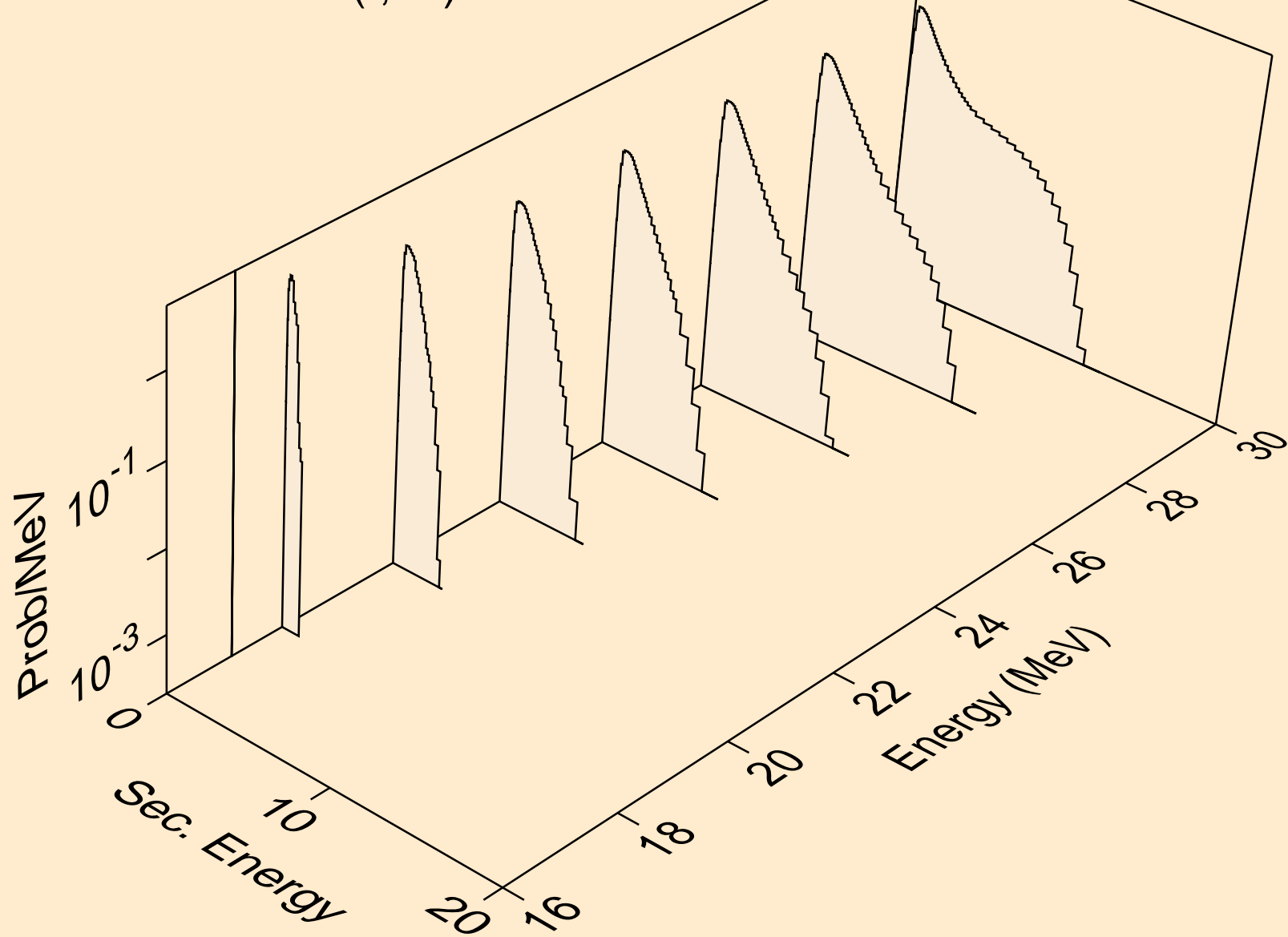



HF161 TRITON ACER TENDL-2021 LIBRARY; T=0.K  
neutrons from (t,n\*)a

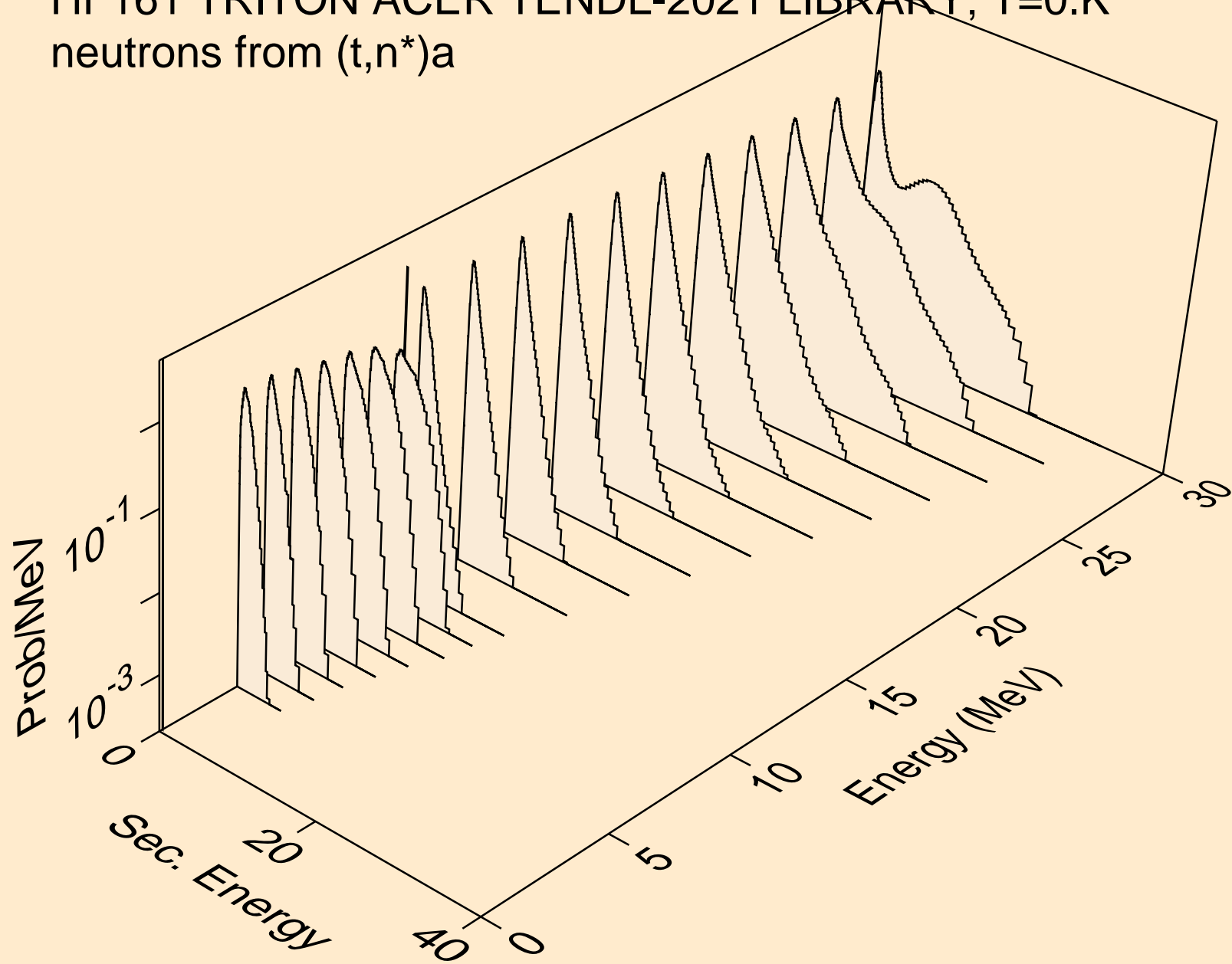

HF161 TRITON ACER TENDL-2021 LIBRARY; T=0.K  
neutrons from (t,n\*)3a

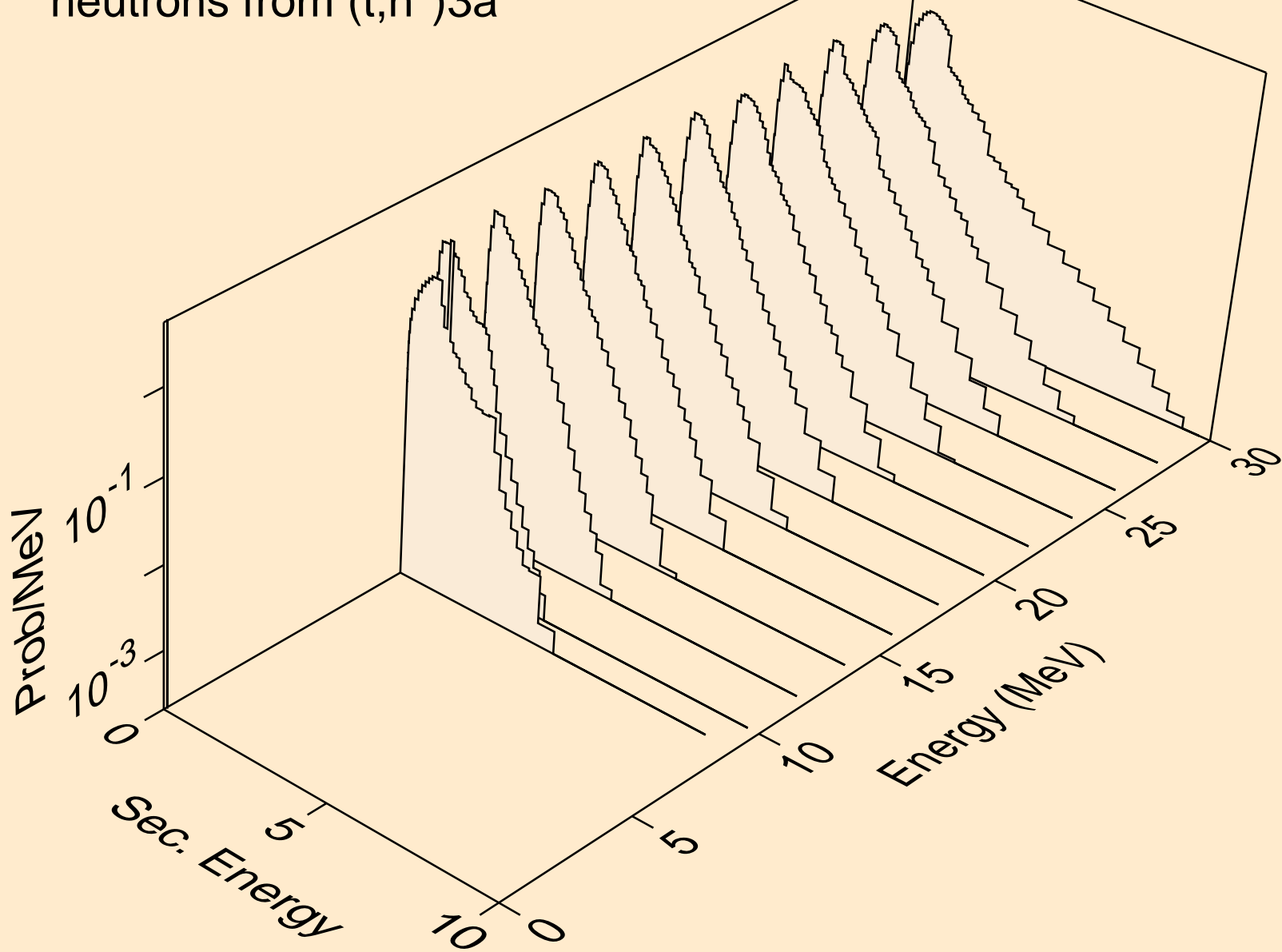

HF161 TRITON ACER TENDL-2021 LIBRARY; T=0.K  
neutrons from (t,2n)a

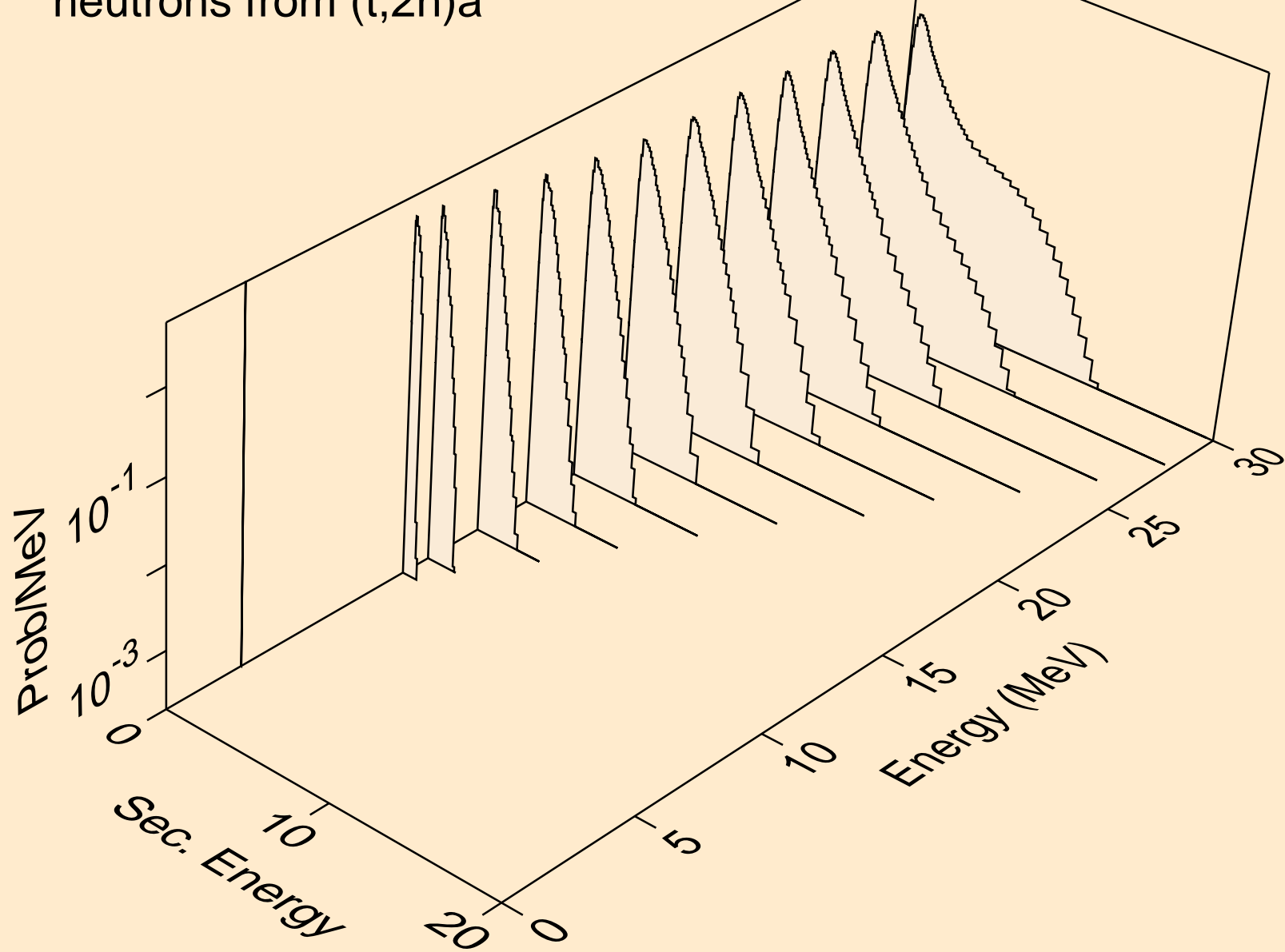

HF161 TRITON ACER TENDL-2021 LIBRARY; T=0.K  
neutrons from (t,3n)a

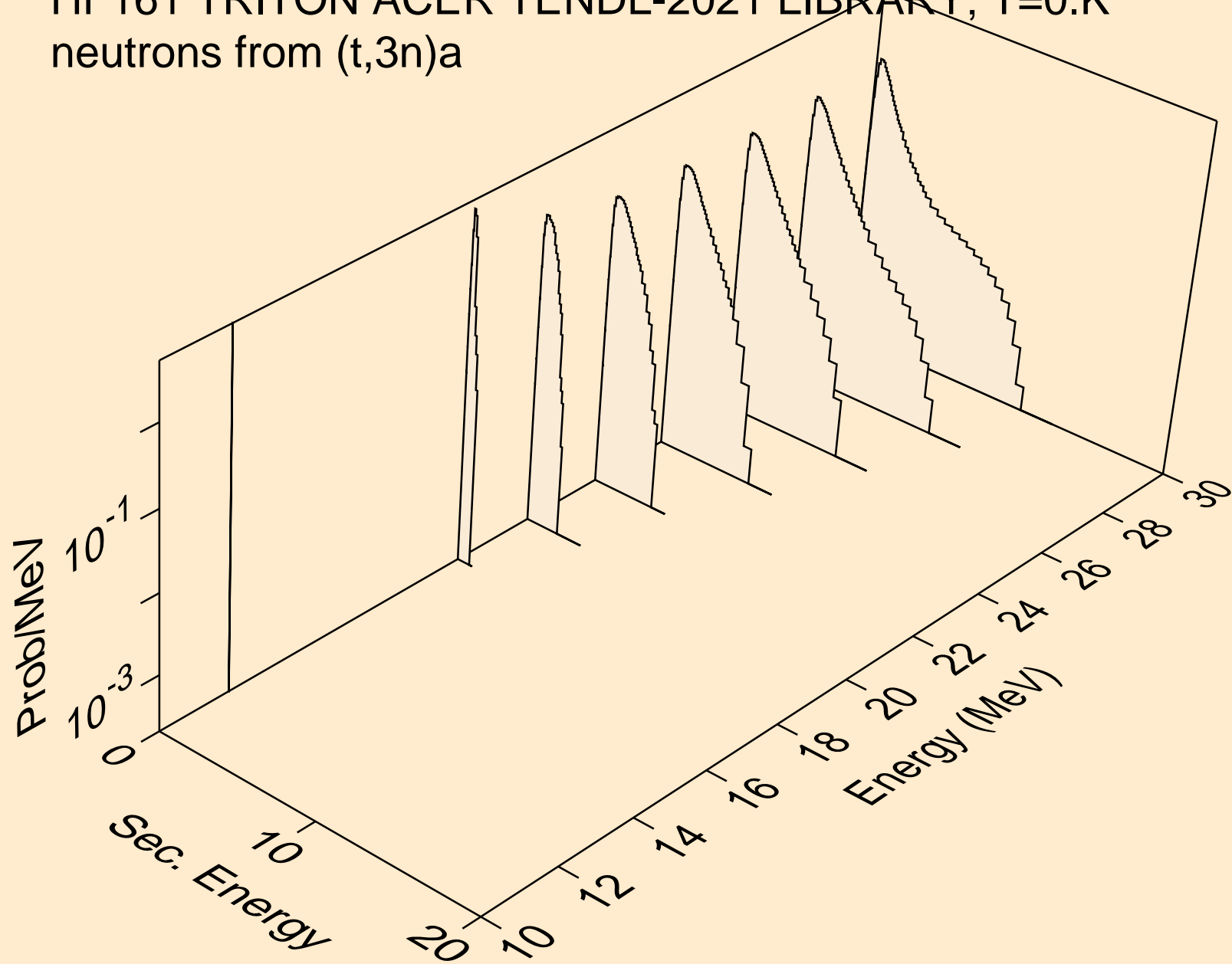

HF161 TRITON ACER TENDL-2021 LIBRARY; T=0.K  
neutrons from (t,n\*)p

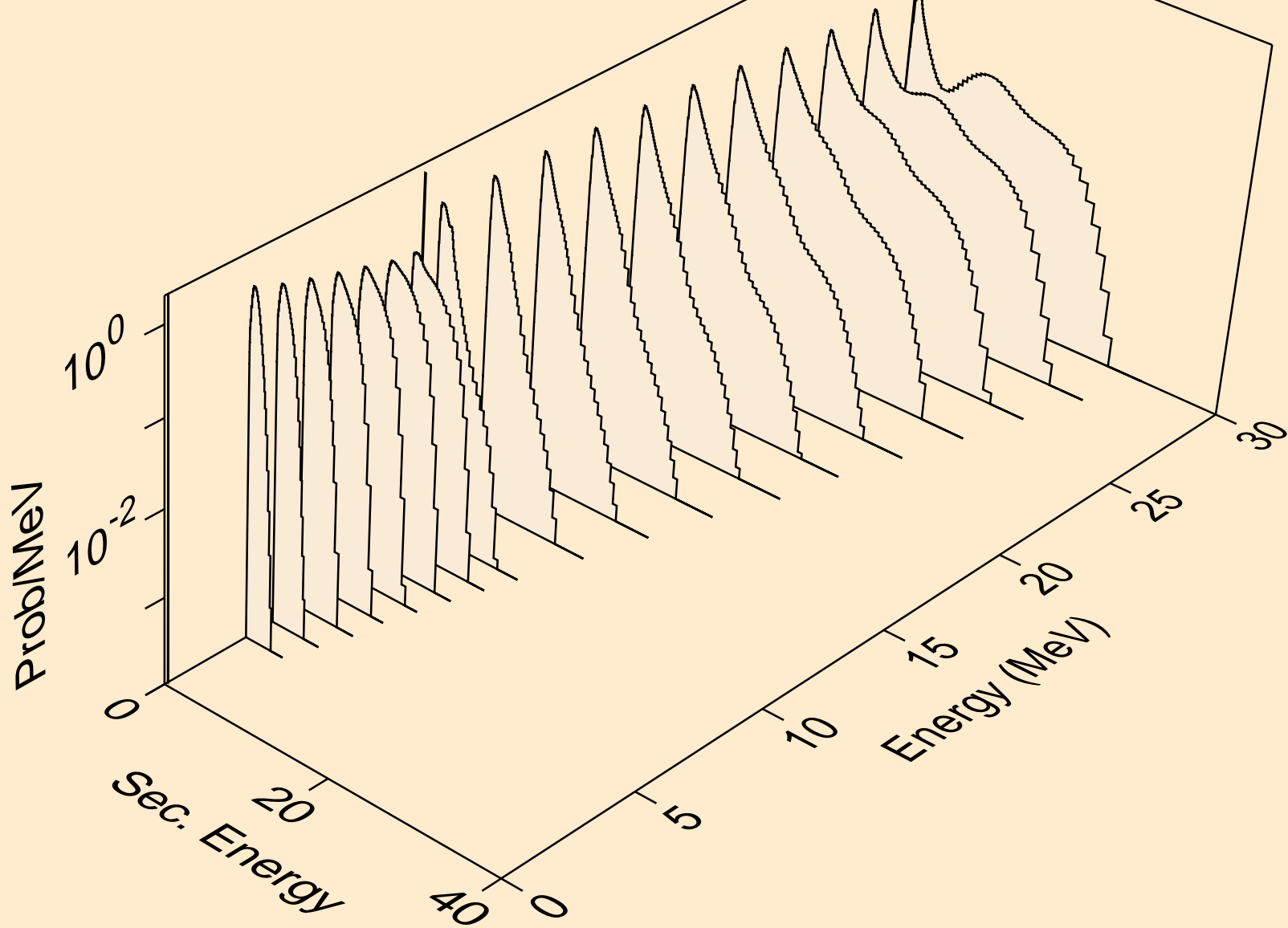

HF161 TRITON ACER TENDL-2021 LIBRARY; T=0.K  
neutrons from (t,n\*)2a

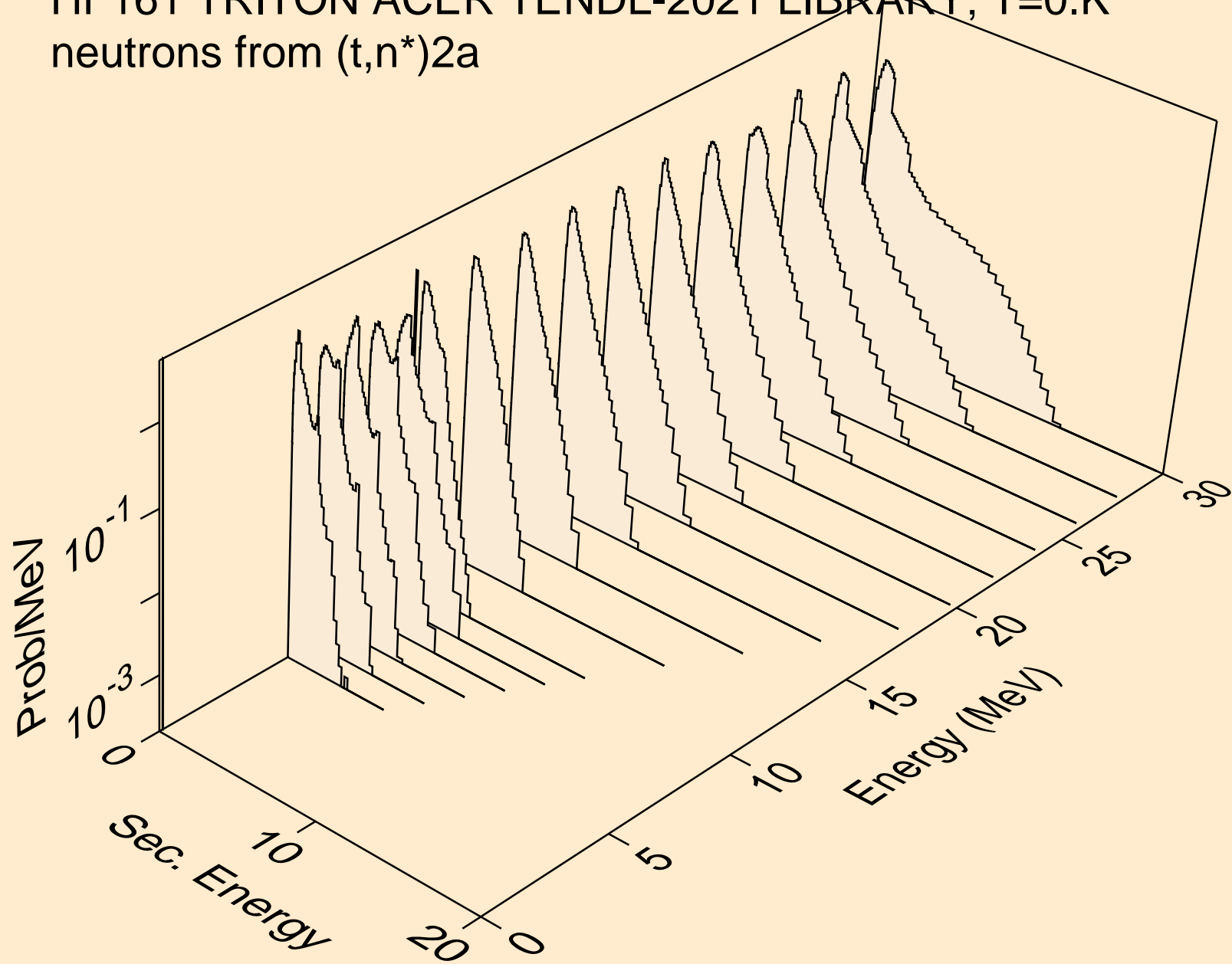

HF161 TRITON ACER TENDL-2021 LIBRARY; T=0.K  
neutrons from (t,2n)2a

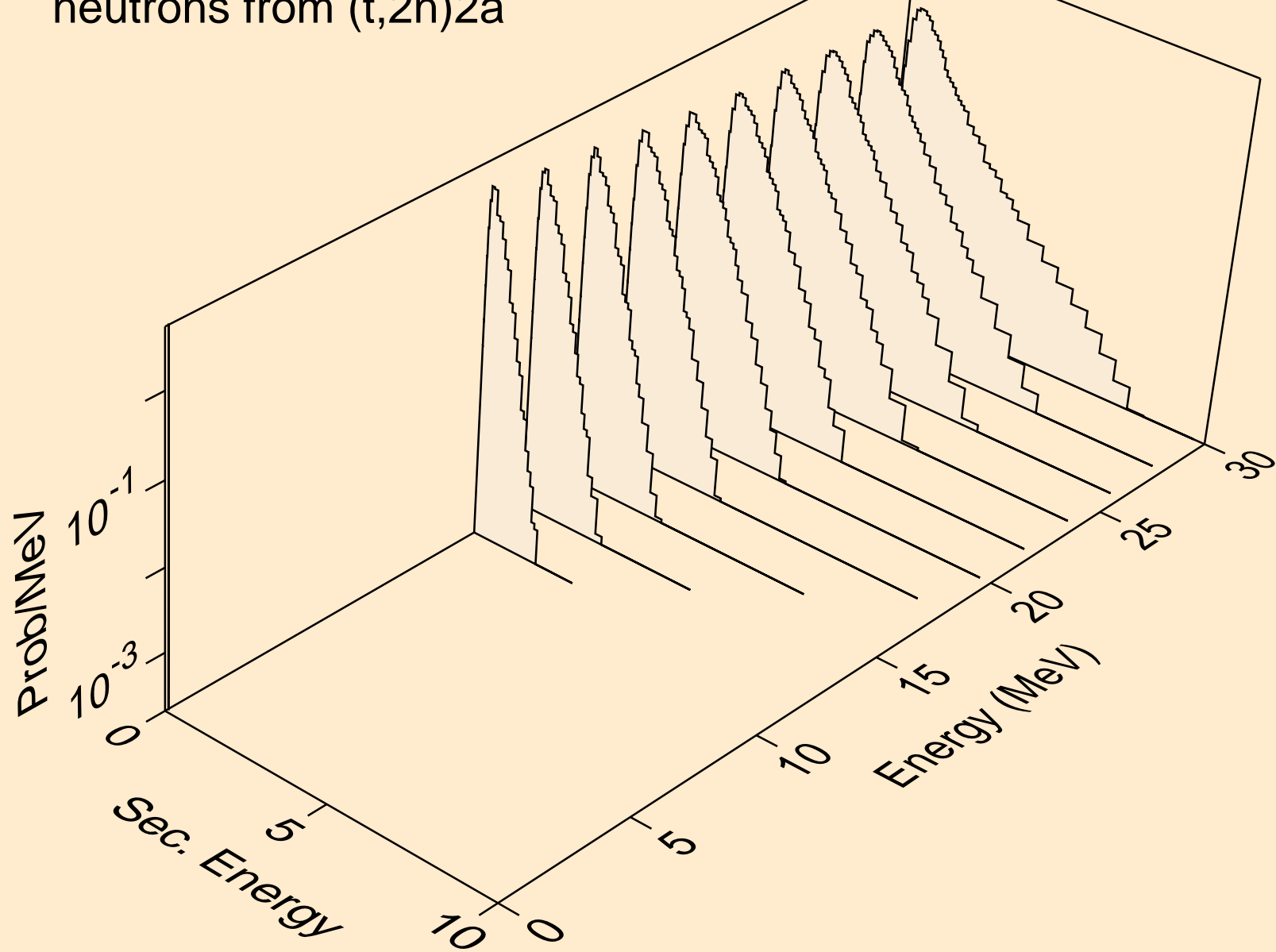

HF161 TRITON ACER TENDL-2021 LIBRARY; T=0.K  
neutrons from (t,n\*)d

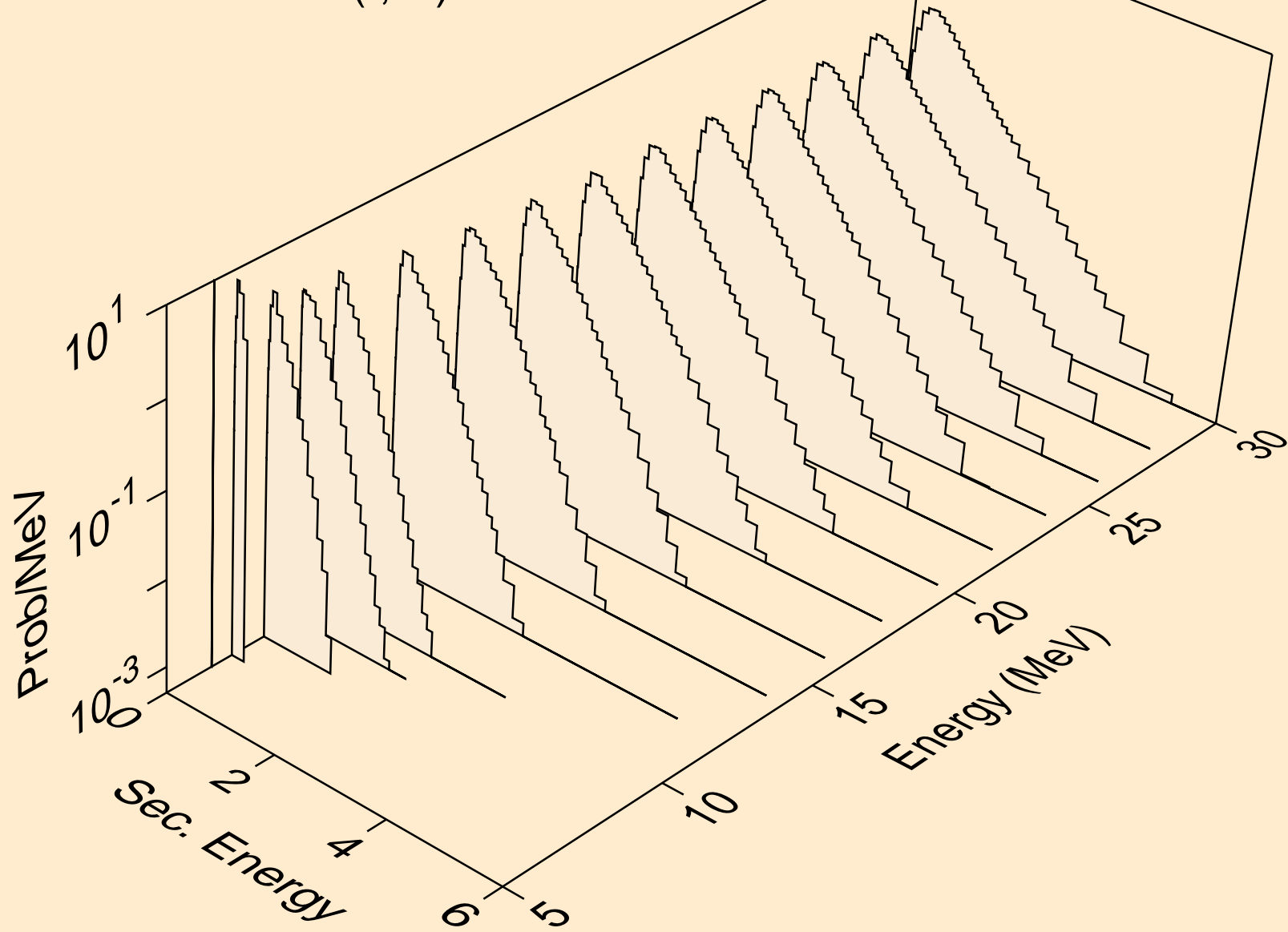



HF161 TRITON ACER TENDL-2021 LIBRARY; T=0.K  
neutrons from (t,n\*)t

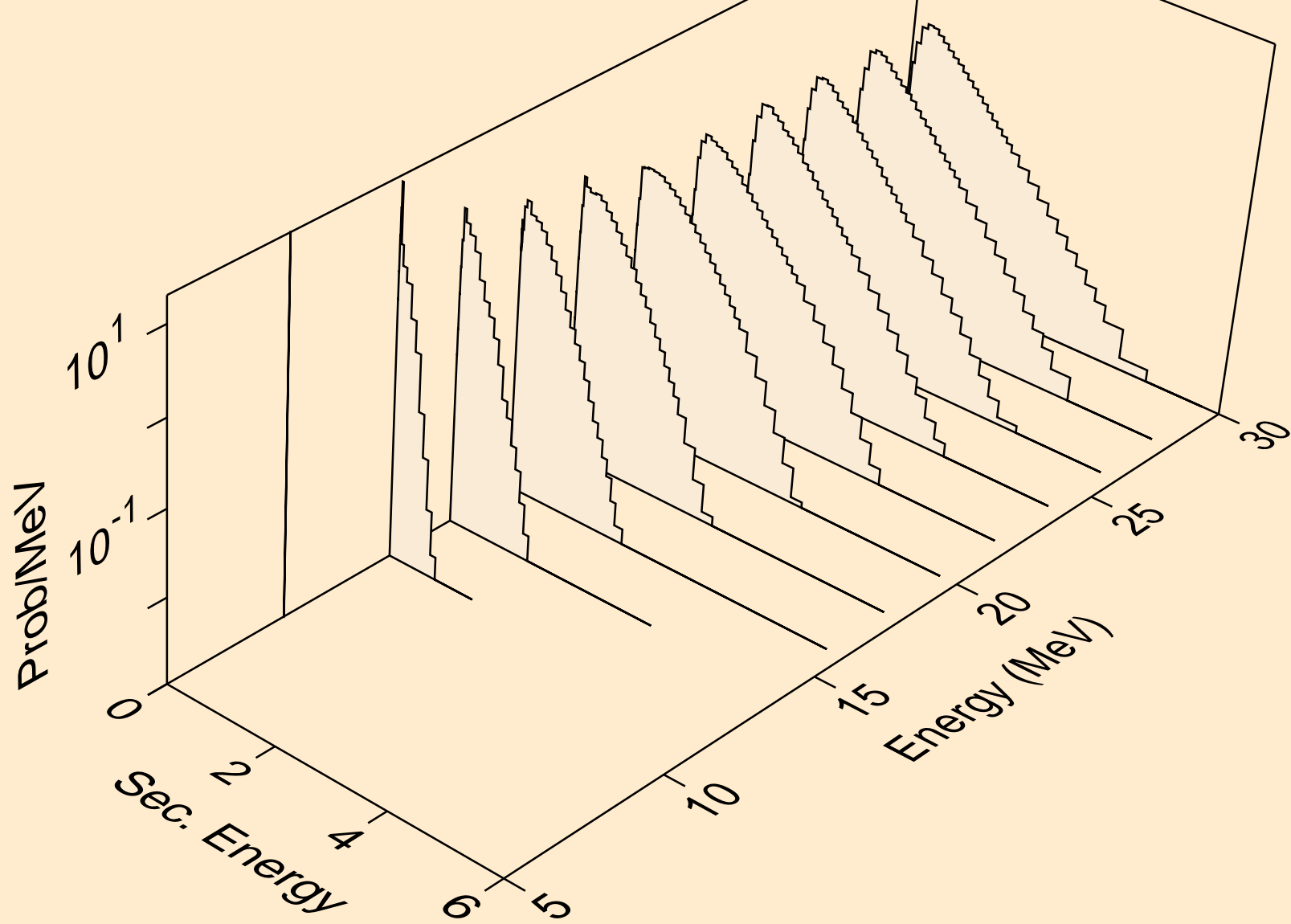

HF161 TRITON ACER TENDL-2021 LIBRARY; T=0.K  
neutrons from (t,n\*)he3

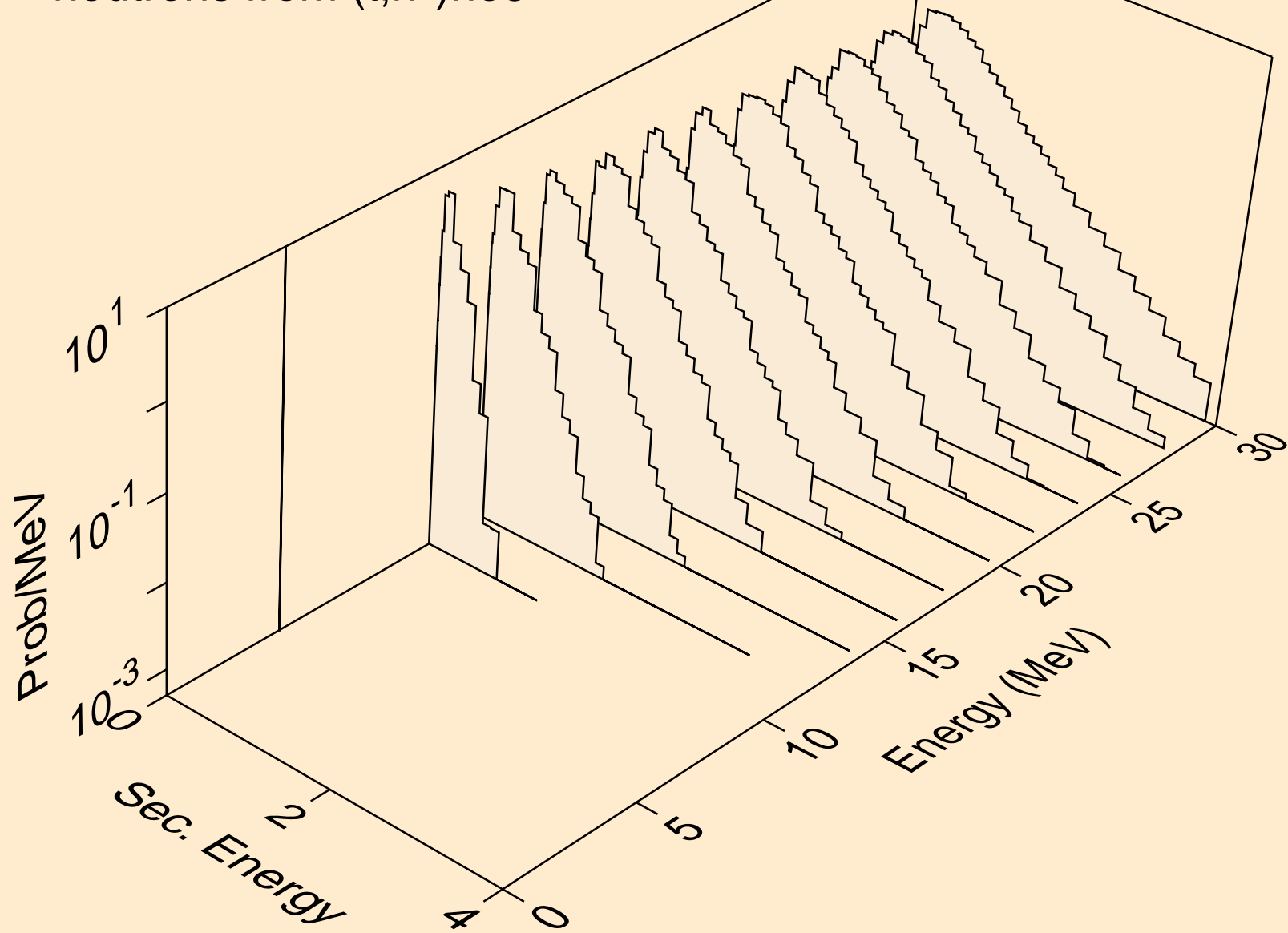

HF161 TRITON ACER TENDL-2021 LIBRARY; T=0.K  
neutrons from (t,4n)

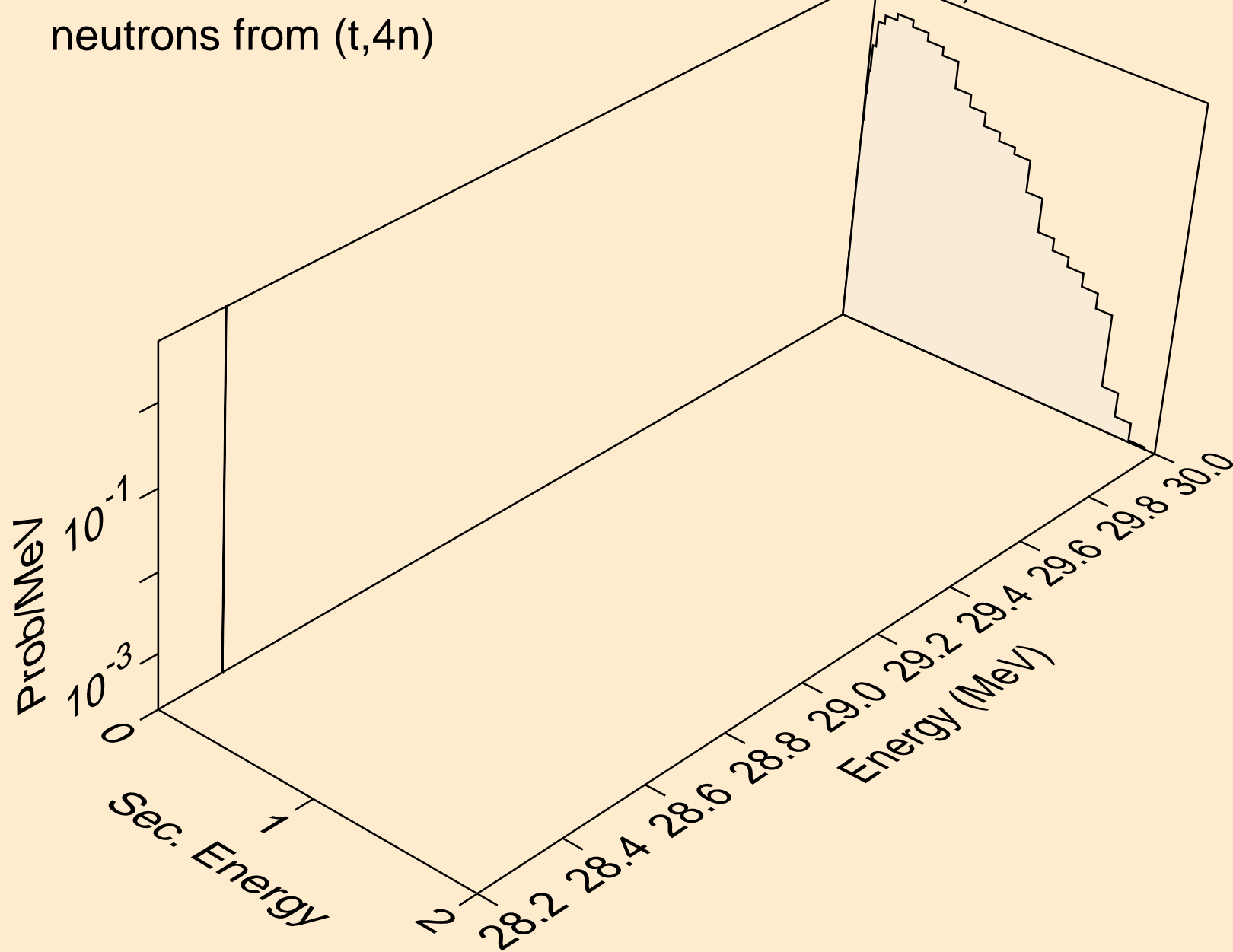

HF161 TRITON ACER TENDL-2021 LIBRARY; T=0.K  
neutrons from (t,2np)

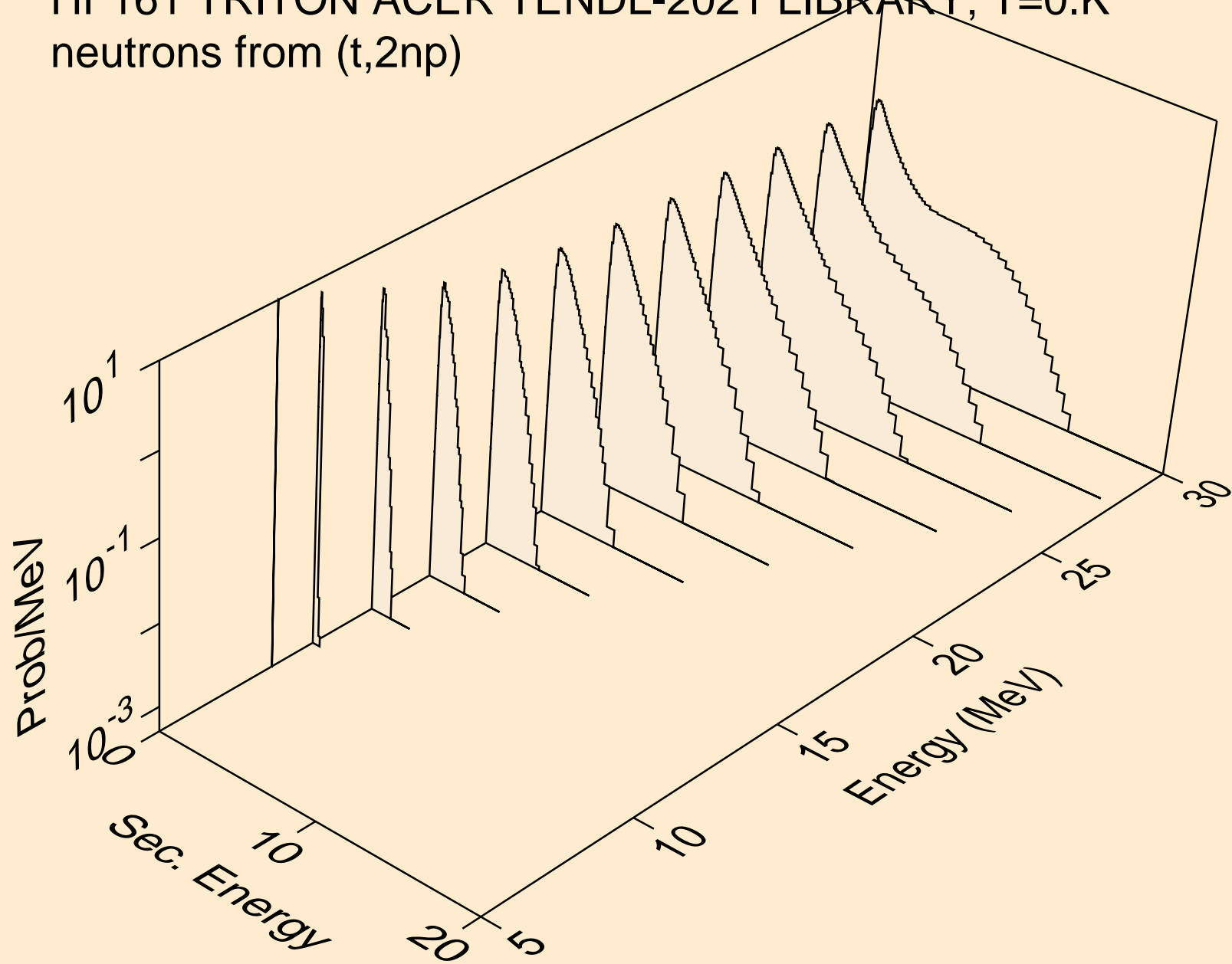

HF161 TRITON ACER TENDL-2021 LIBRARY; T=0.K  
neutrons from (t,3np)

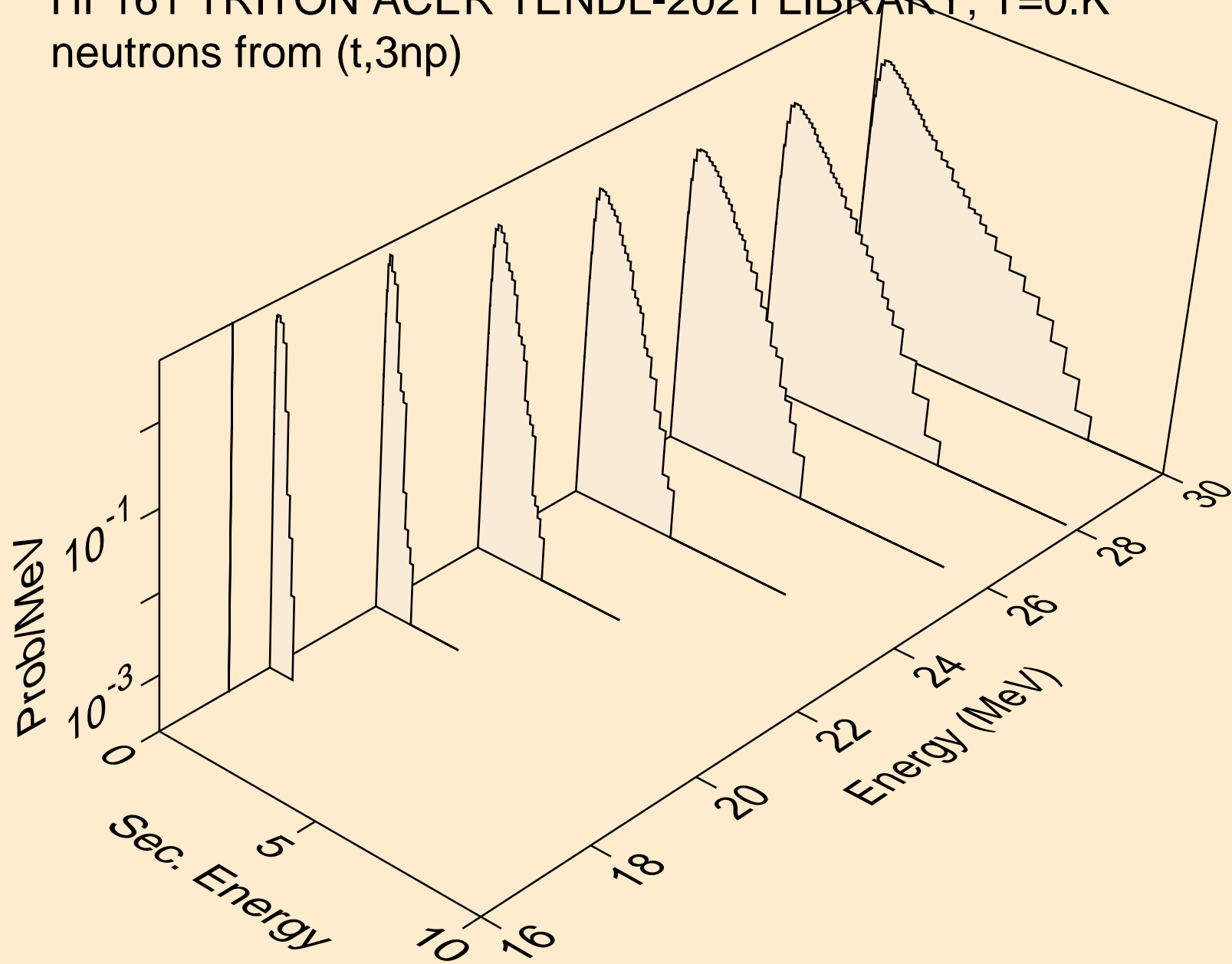

HF161 TRITON ACER TENDL-2021 LIBRARY; T=0.K  
neutrons from (t,2np)

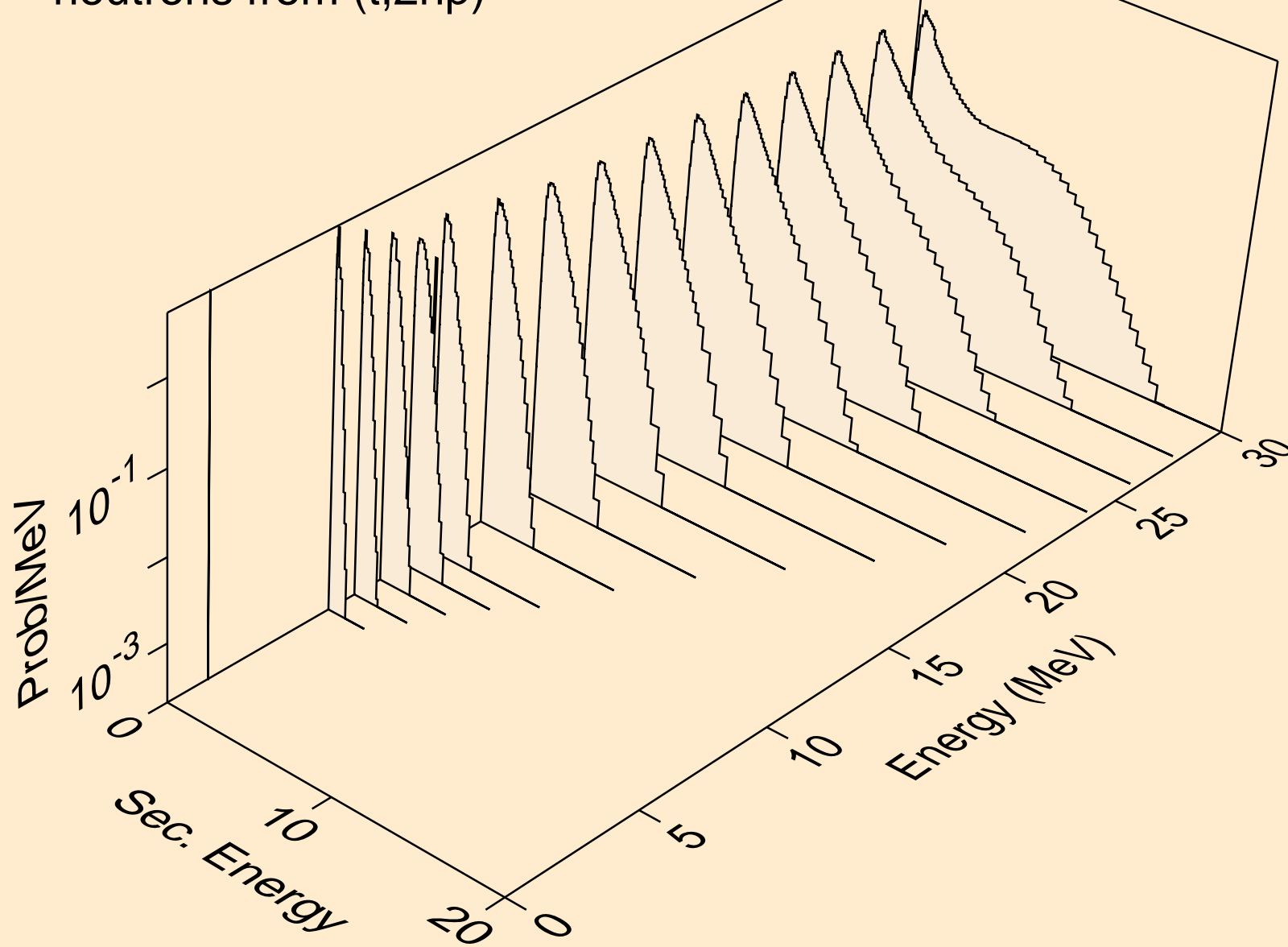

HF161 TRITON ACER TENDL-2021 LIBRARY; T=0.K  
neutrons from (t,npa)

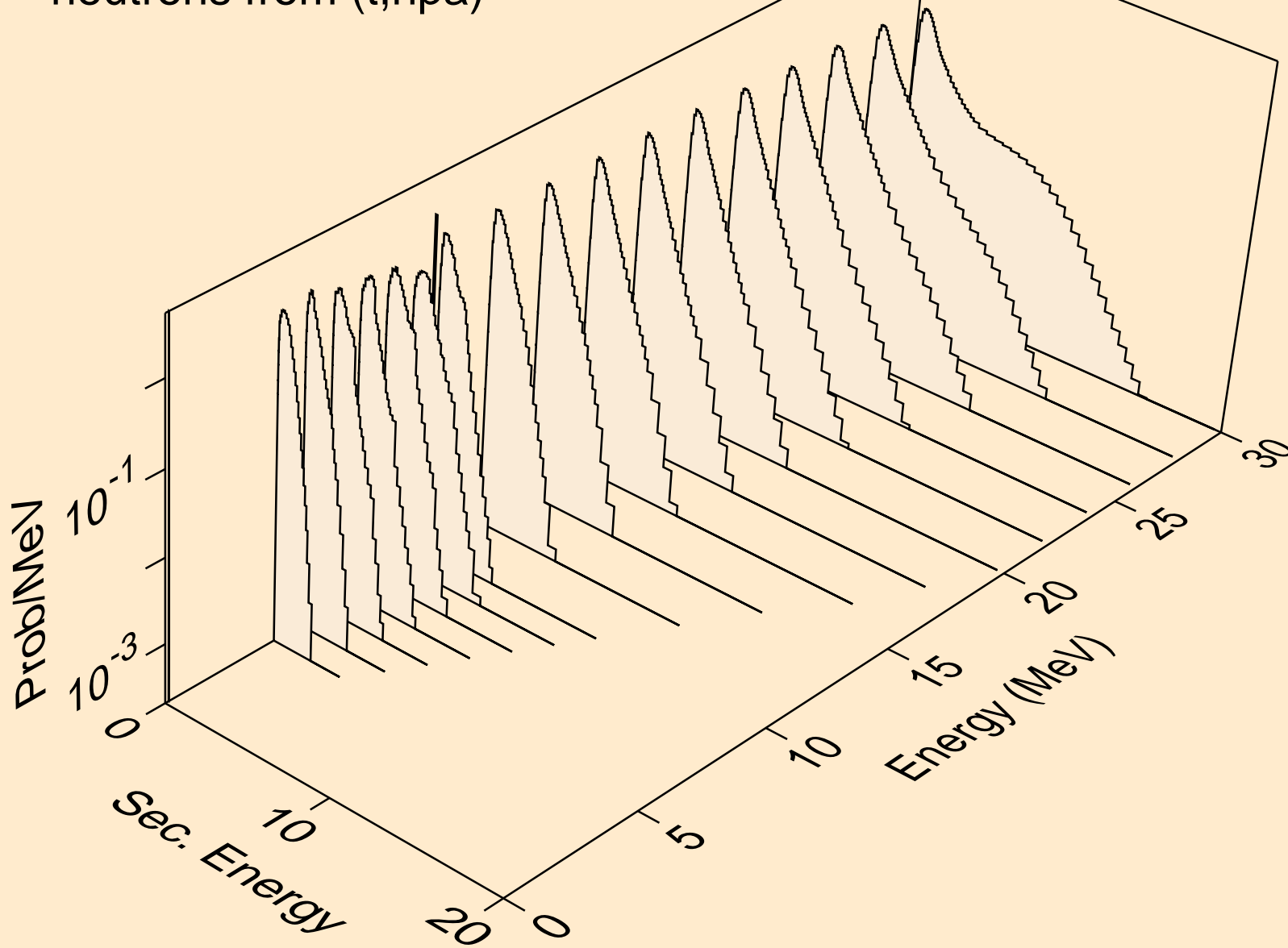

HF161 TRITON ACER TENDL-2021 LIBRARY; T=0.K  
protons from (t,x)

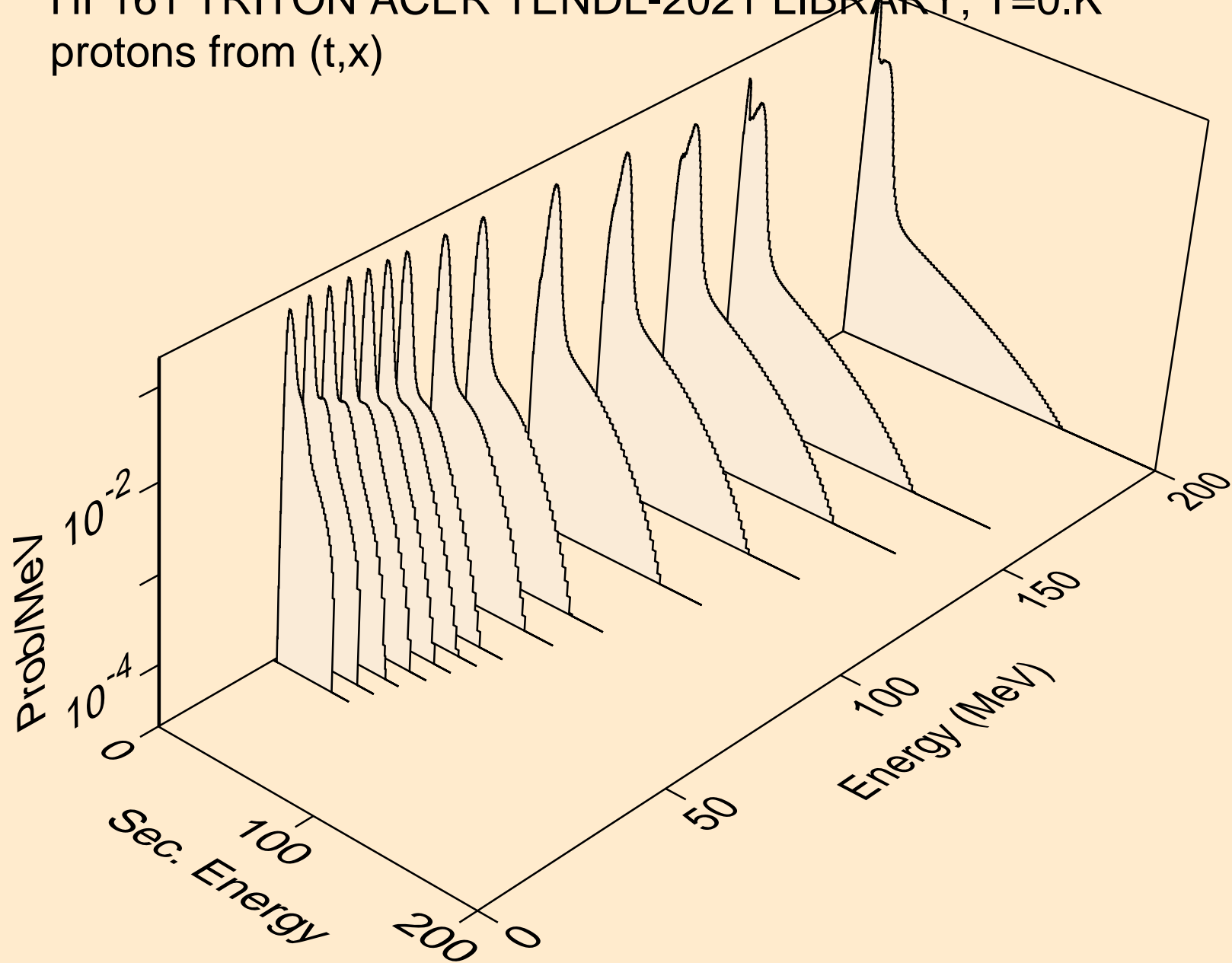



HF161 TRITON ACER TENDL-2021 LIBRARY; T=0.K  
protons from (t,n\*)p

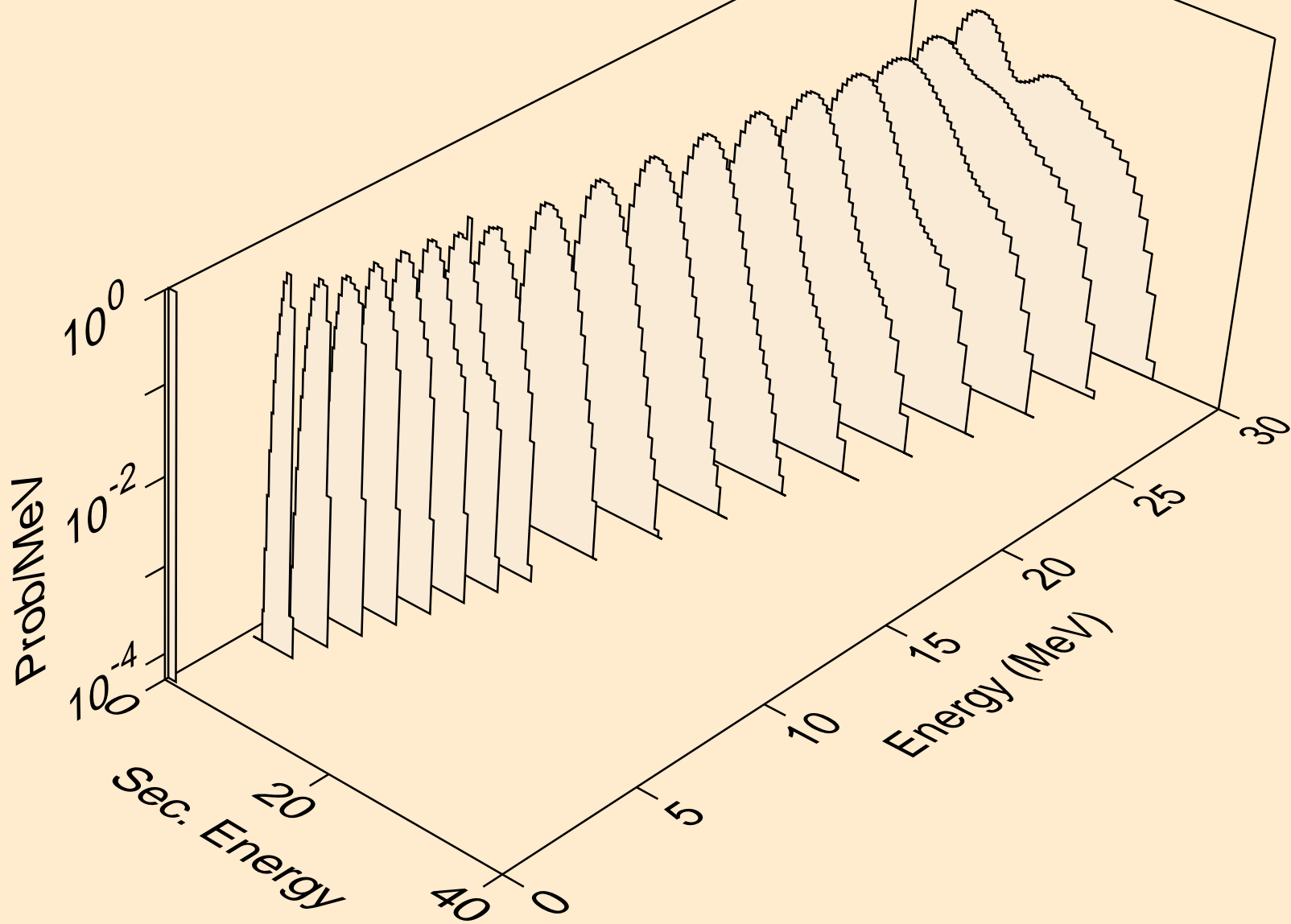

HF161 TRITON ACER TENDL-2021 LIBRARY; T=0.K  
protons from (t,2np)

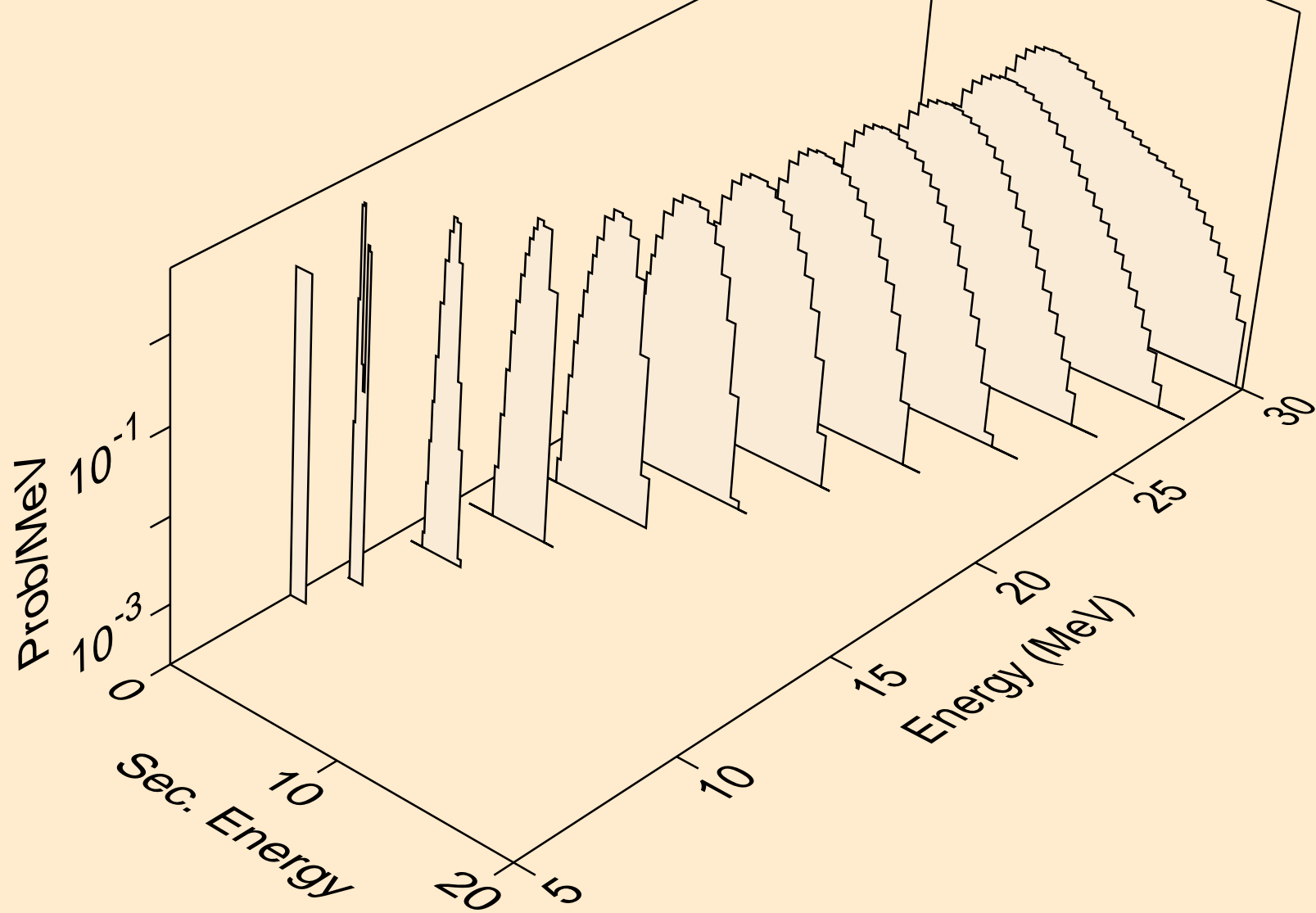

HF161 TRITON ACER TENDL-2021 LIBRARY; T=0.K  
protons from (t,3np)

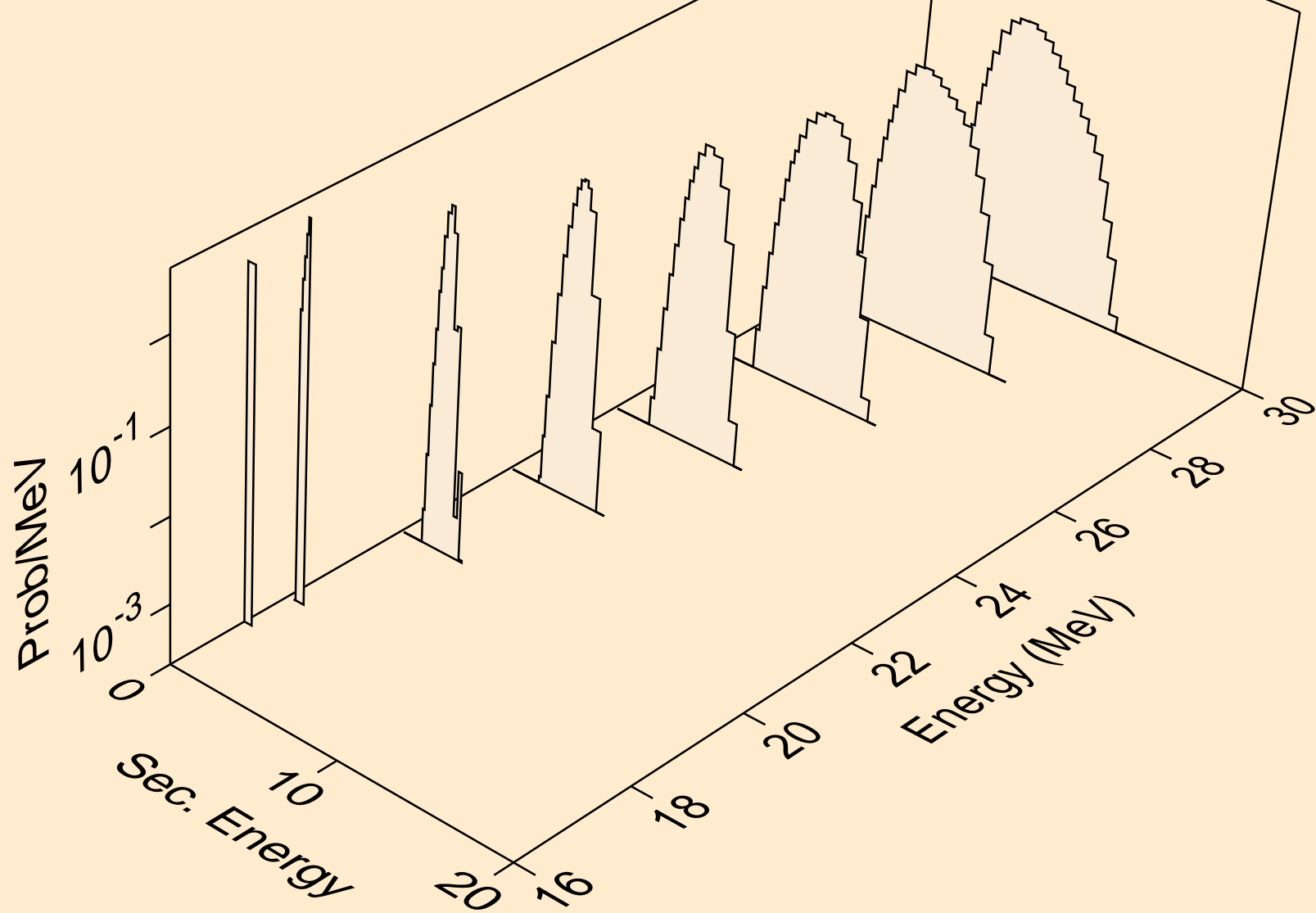

HF161 TRITON ACER TENDL-2021 LIBRARY; T=0.K  
protons from (t,2np)

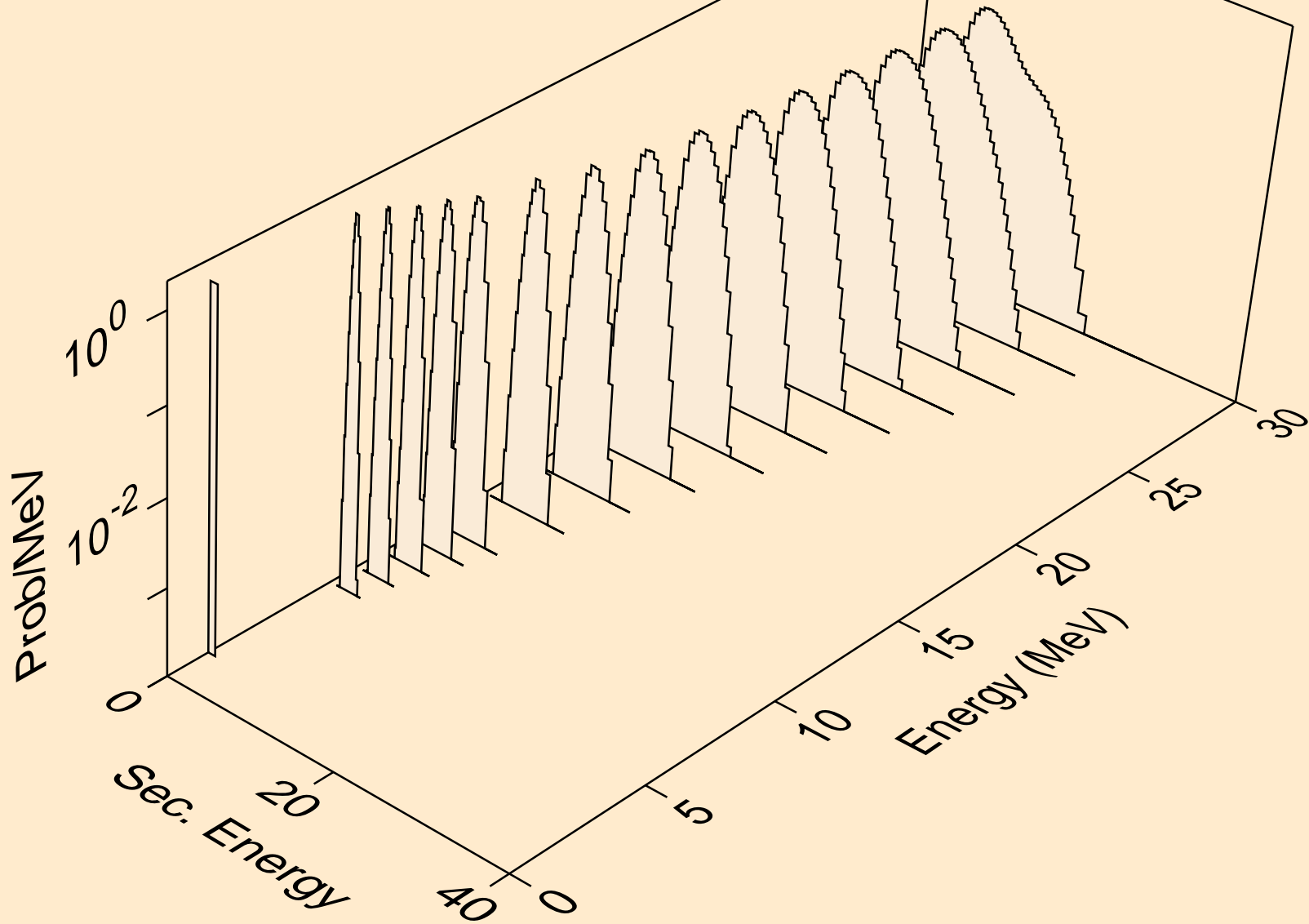

HF161 TRITON ACER TENDL-2021 LIBRARY; T=0.K  
protons from (t,npa)

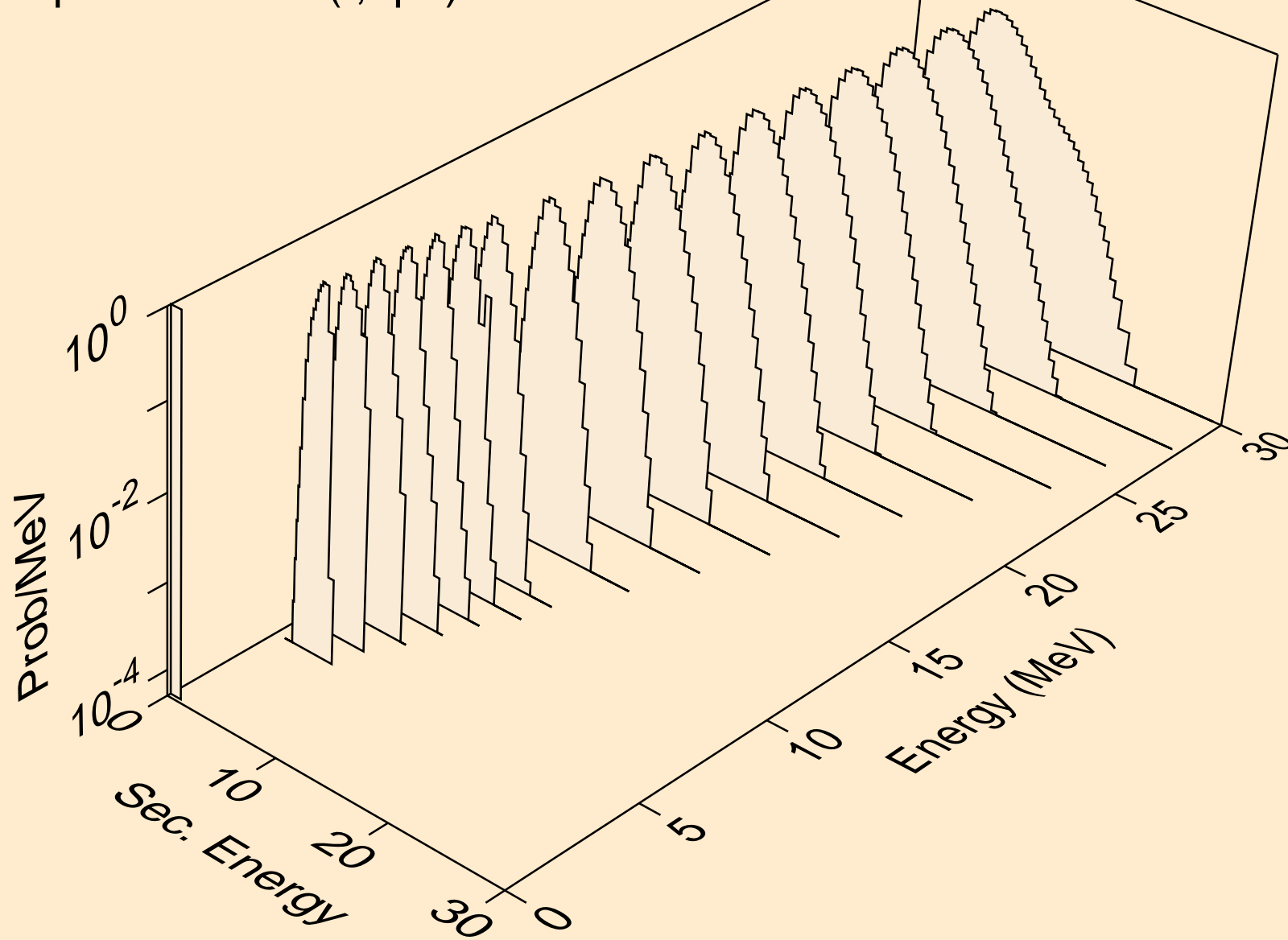

HF161 TRITON ACER TENDL-2021 LIBRARY; T=0.K  
protons from (t,p)

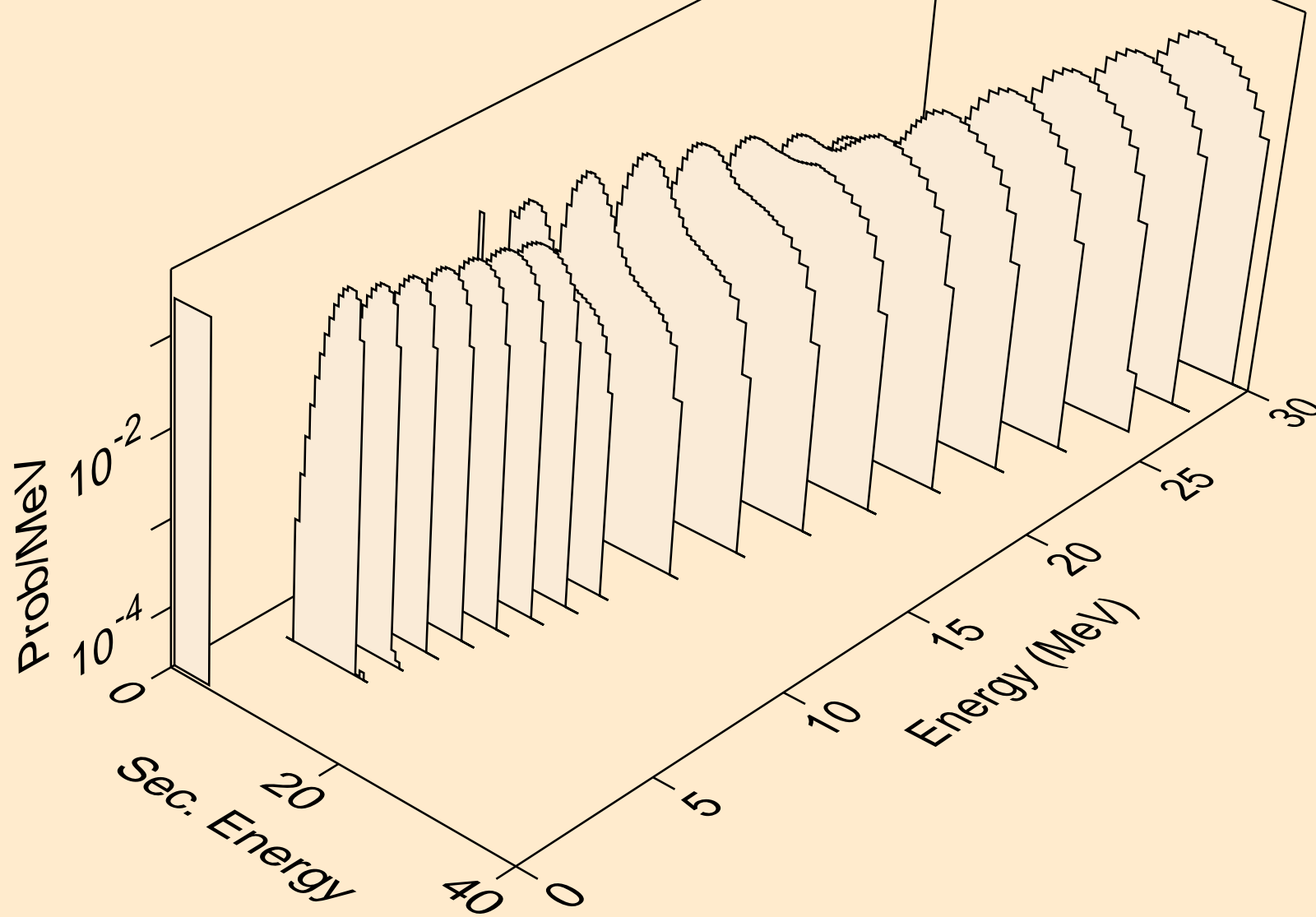

HF161 TRITON ACER TENDL-2021 LIBRARY; T=0.K  
protons from (t,2p)

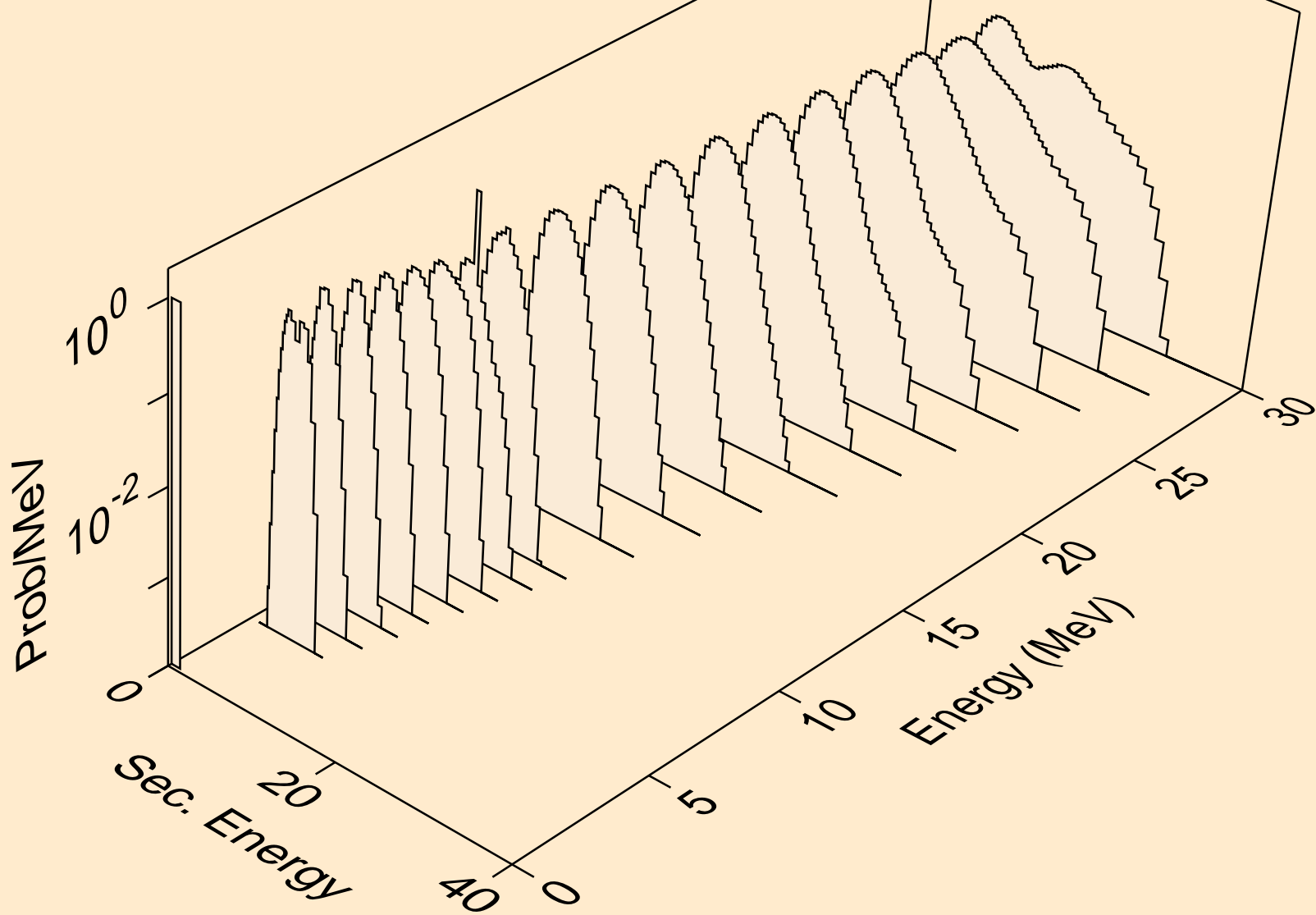

HF161 TRITON ACER TENDL-2021 LIBRARY; T=0.K  
protons from (t,pa)

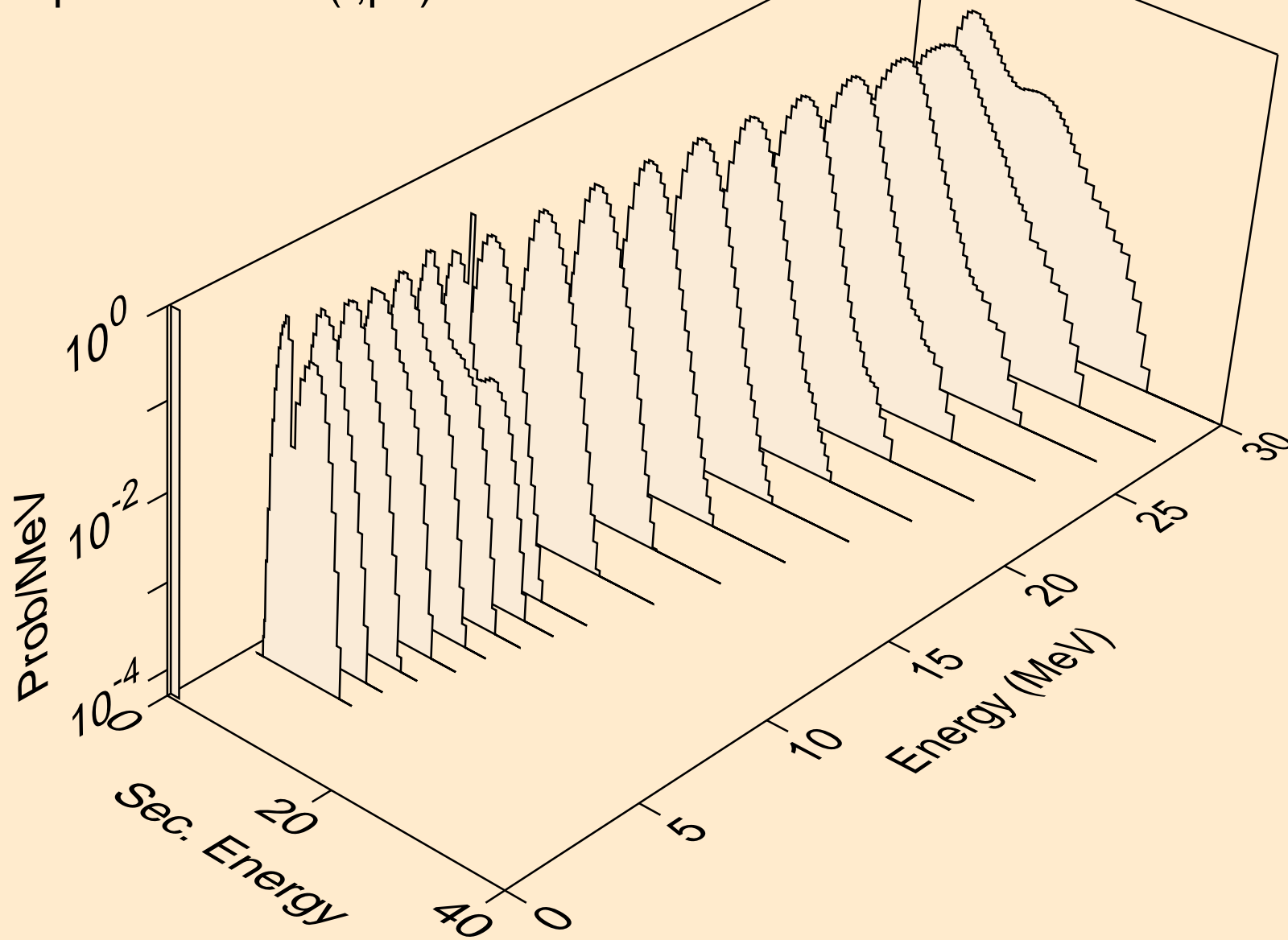



HF161 TRITON ACER TENDL-2021 LIBRARY; T=0.K  
protons from (t,pd)

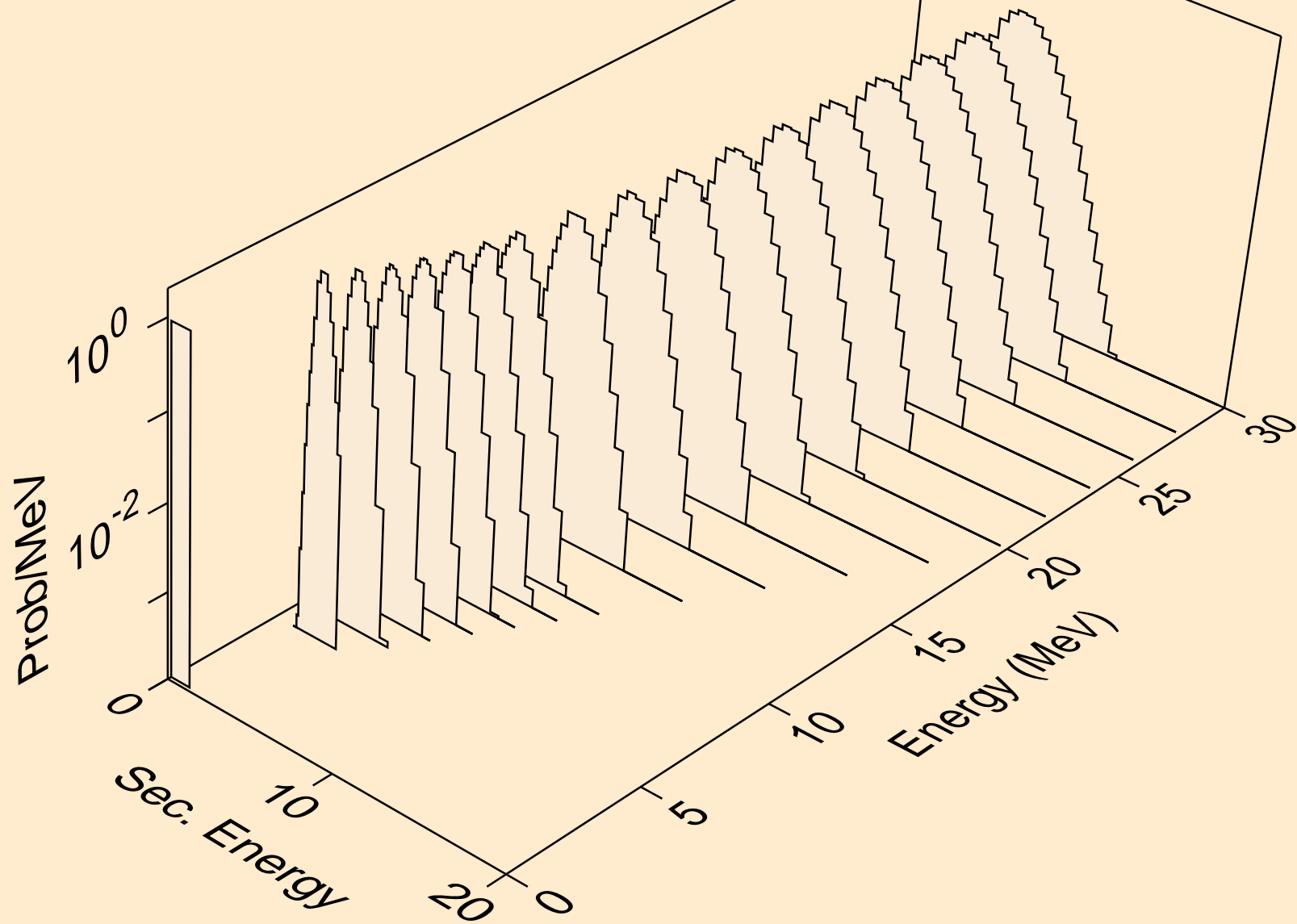

HF161 TRITON ACER TENDL-2021 LIBRARY; T=0.K  
protons from (t,pt)

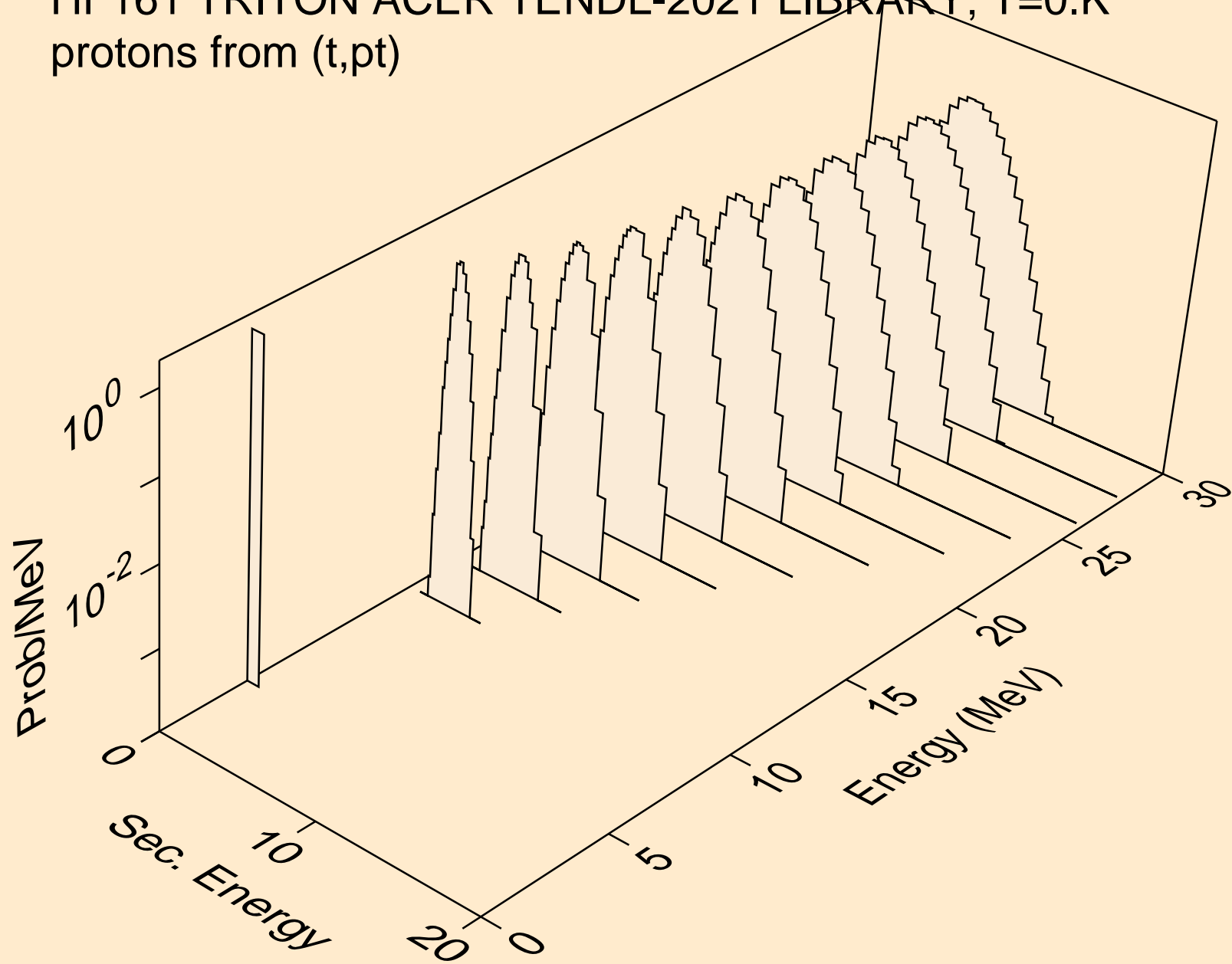

HF161 TRITON ACER TENDL-2021 LIBRARY; T=0.K  
deuterons from (t,x)

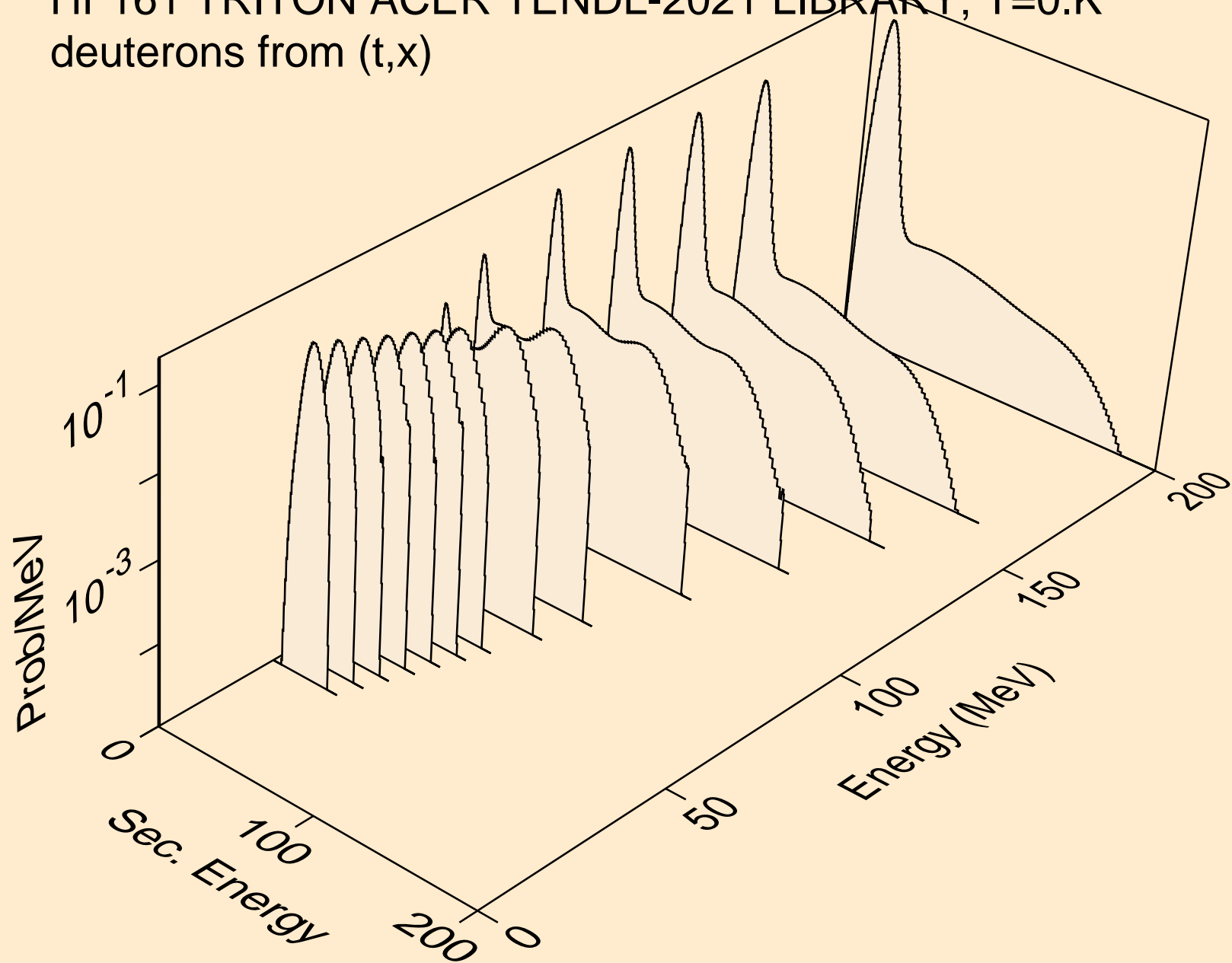

HF161 TRITON ACER TENDL-2021 LIBRARY; T=0.K  
deuterons from (t,2nd)

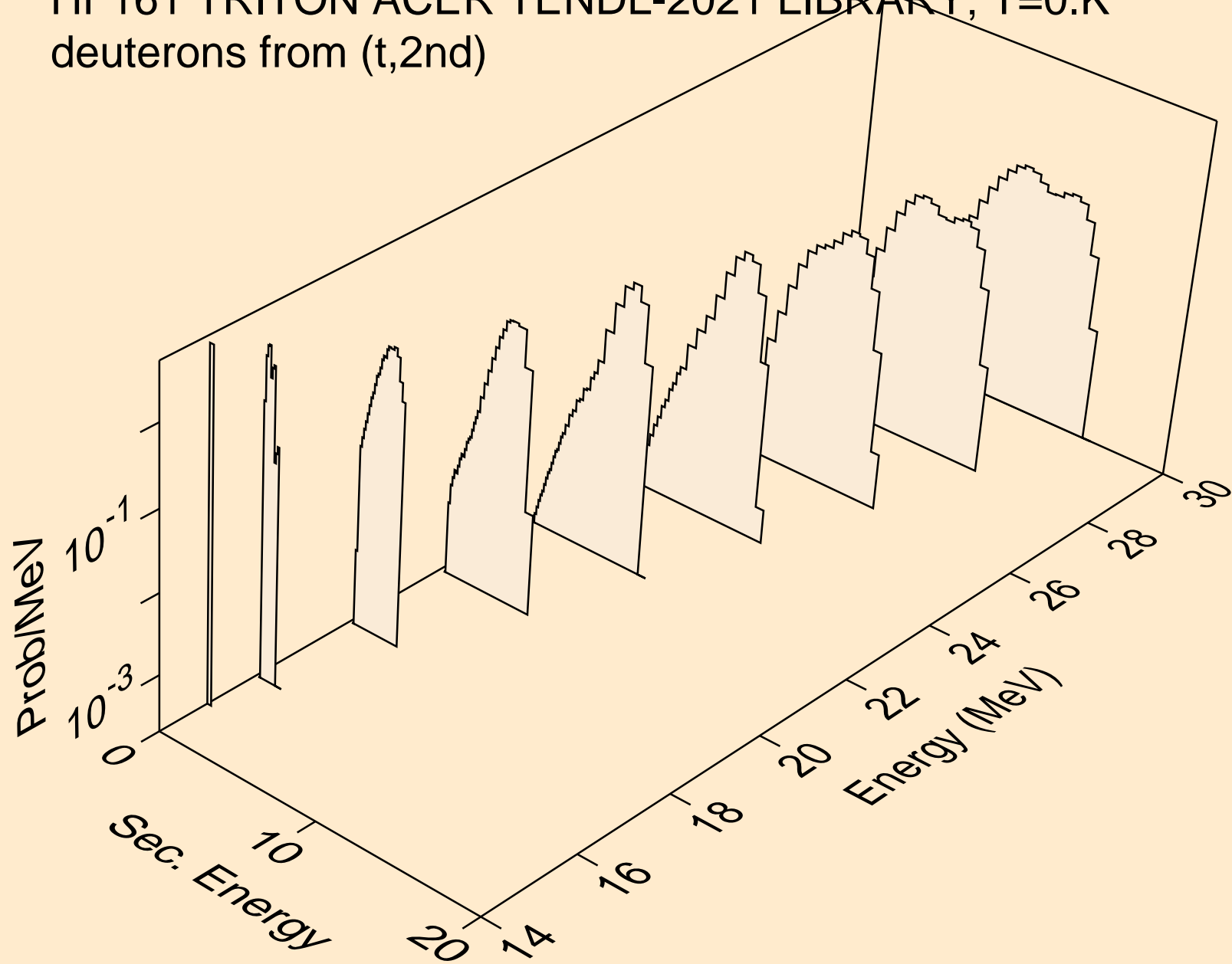

HF161 TRITON ACER TENDL-2021 LIBRARY; T=0.K  
deuterons from (t,n\*)d

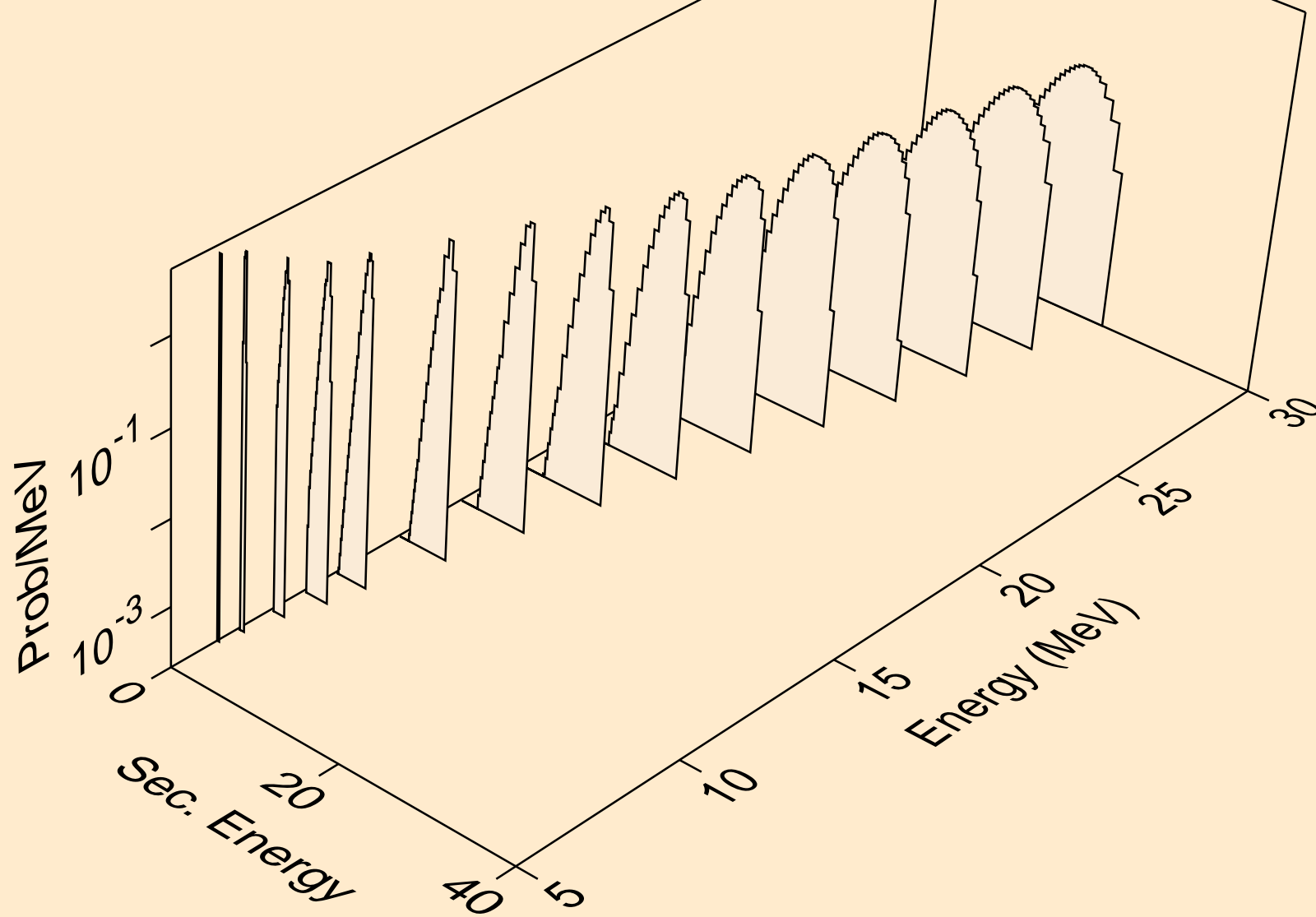

HF161 TRITON ACER TENDL-2021 LIBRARY; T=0.K  
deuterons from (t,d)

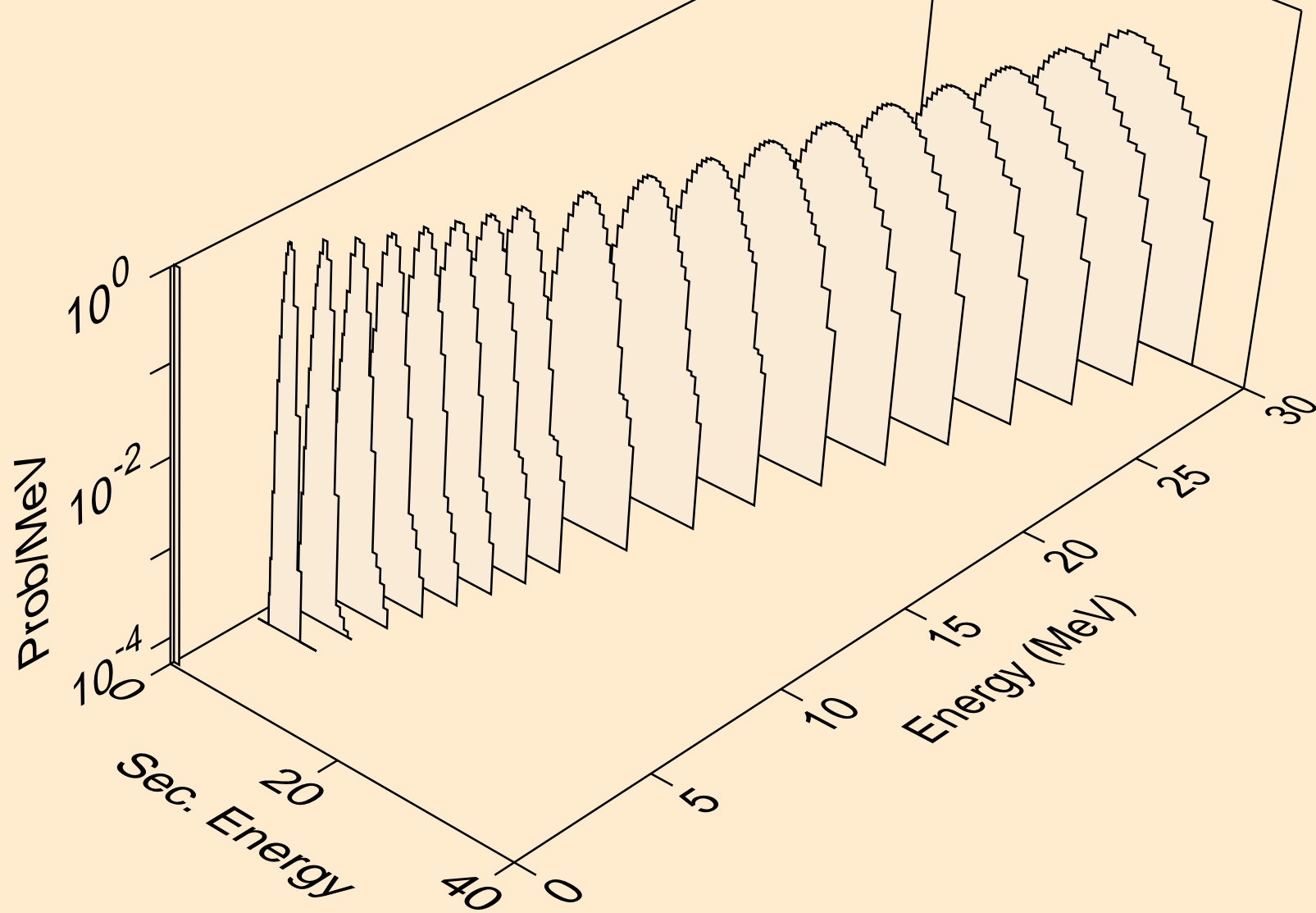

HF161 TRITON ACER TENDL-2021 LIBRARY; T=0.K  
deuterons from (t,d2a)

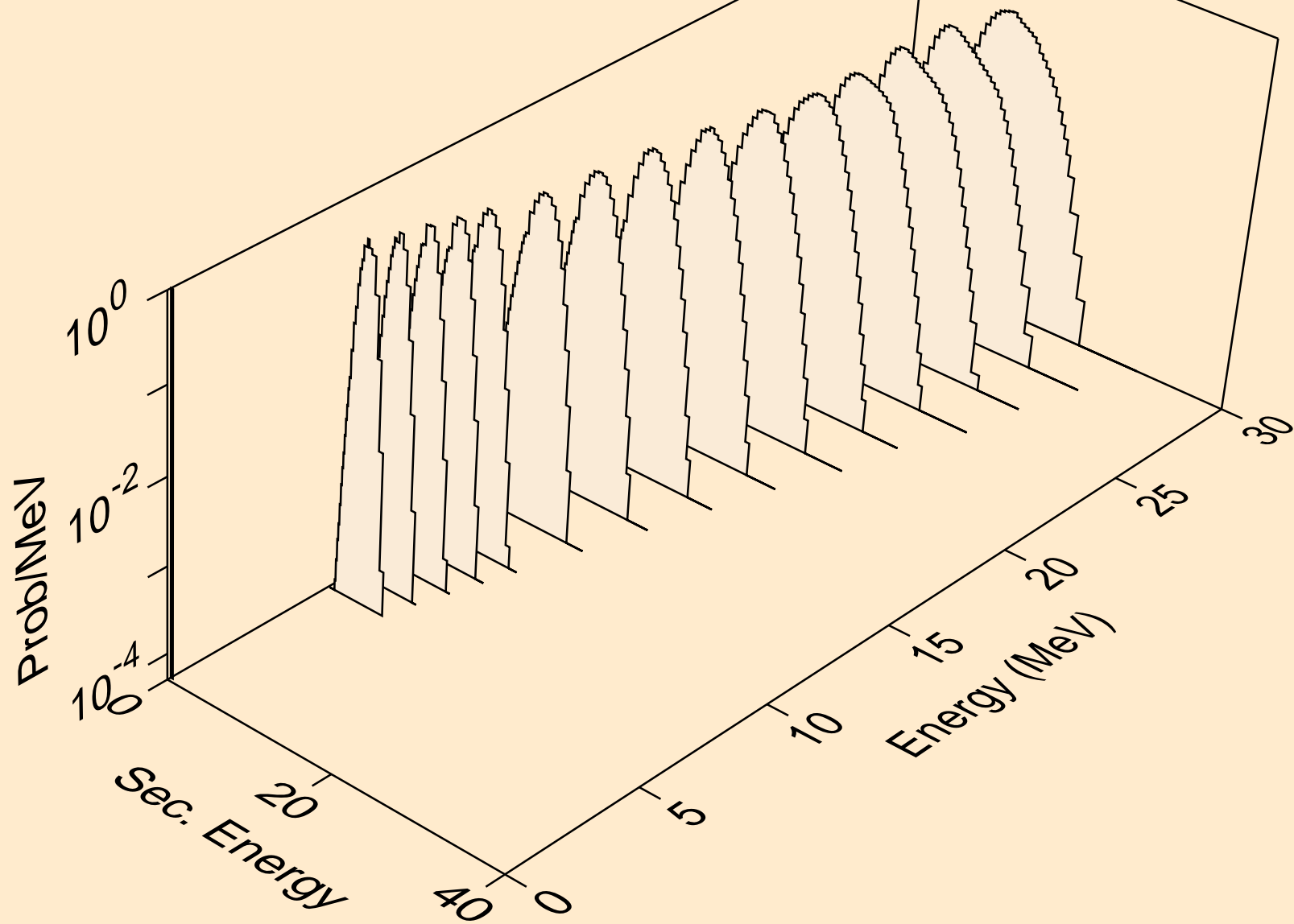

HF161 TRITON ACER TENDL-2021 LIBRARY; T=0.K  
deuterons from (t,pd)

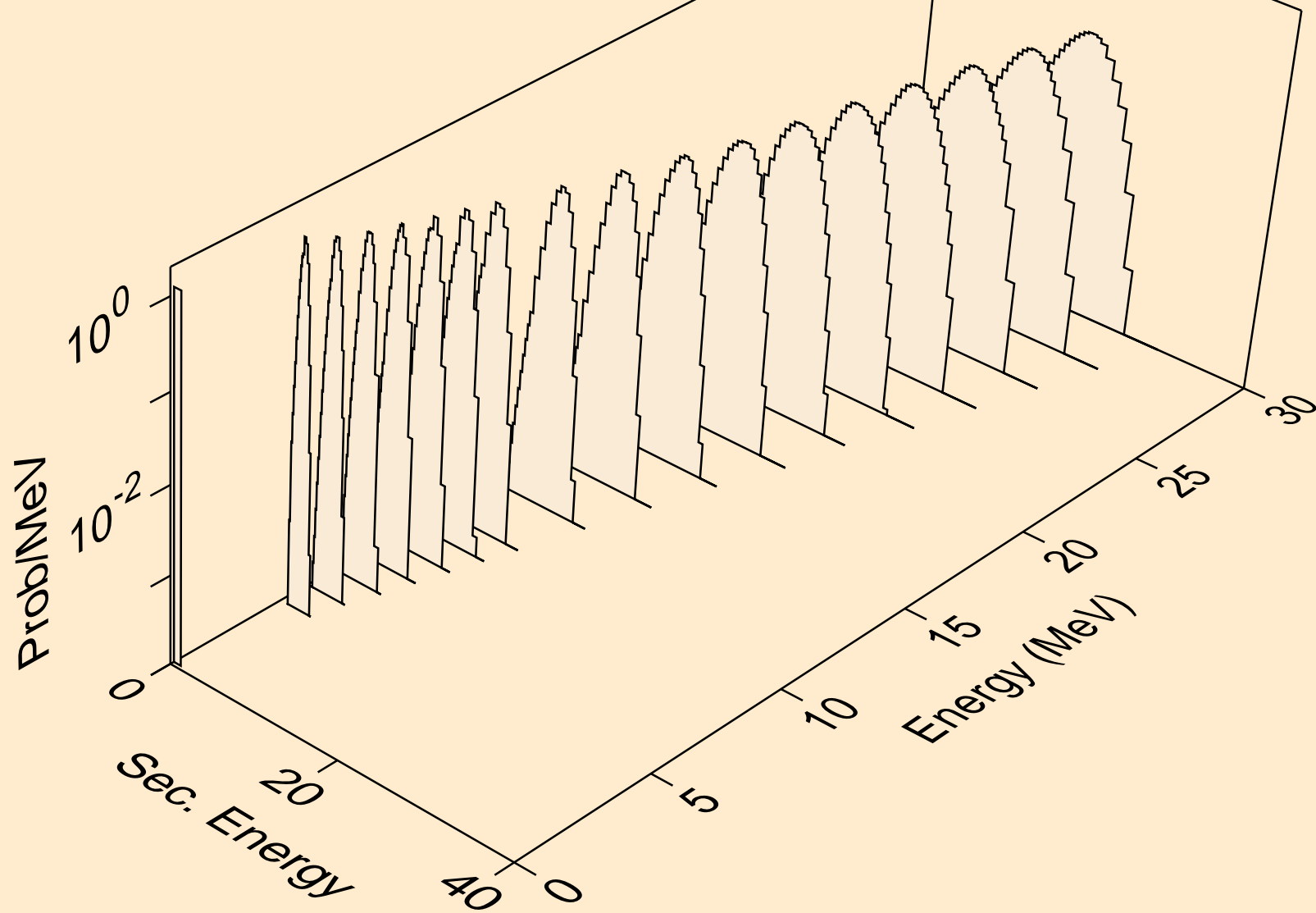



HF161 TRITON ACER TENDL-2021 LIBRARY; T=0.K  
deuterons from (t,da)

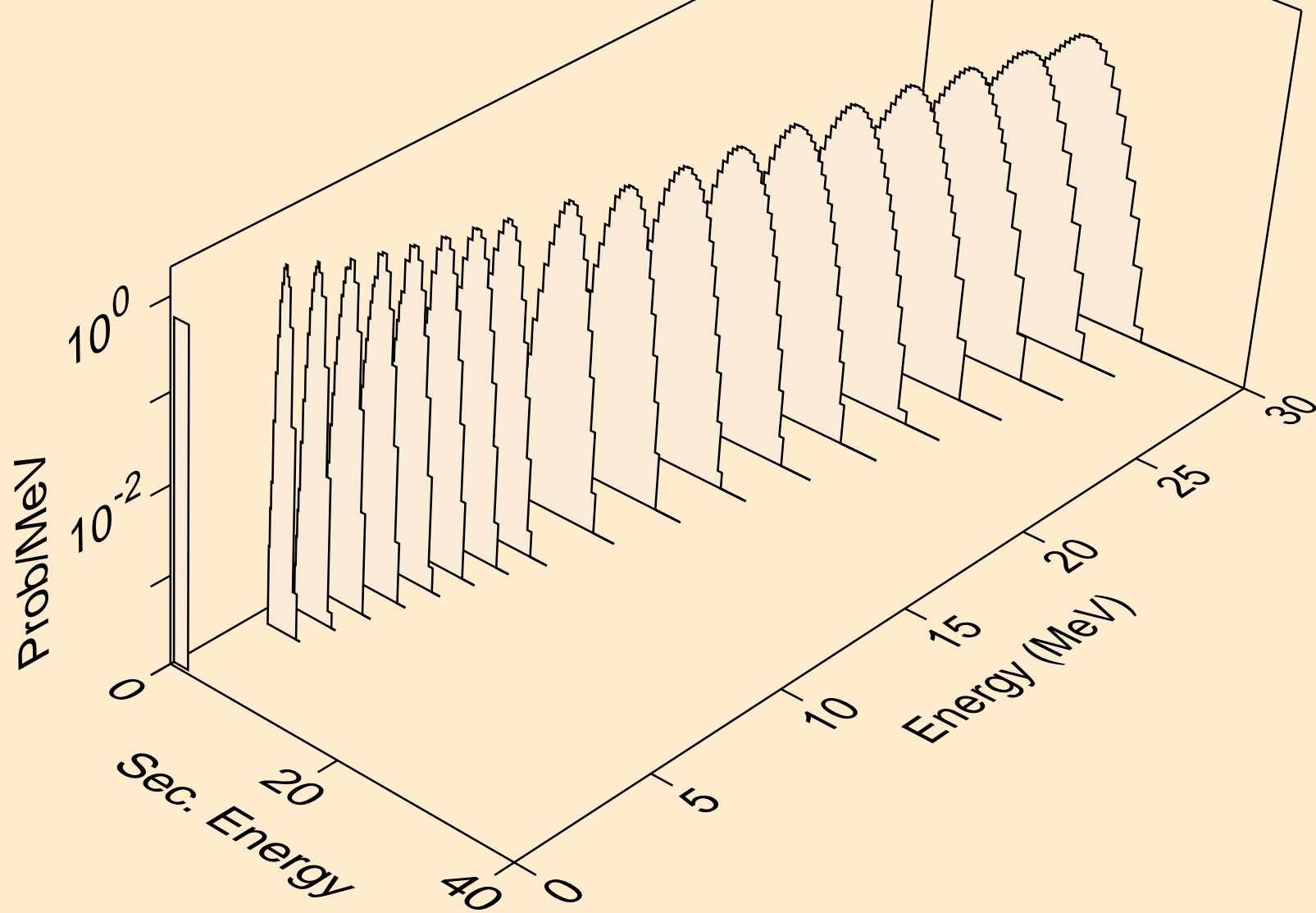

HF161 TRITON ACER TENDL-2021 LIBRARY; T=0.K  
he3s from (t,x)

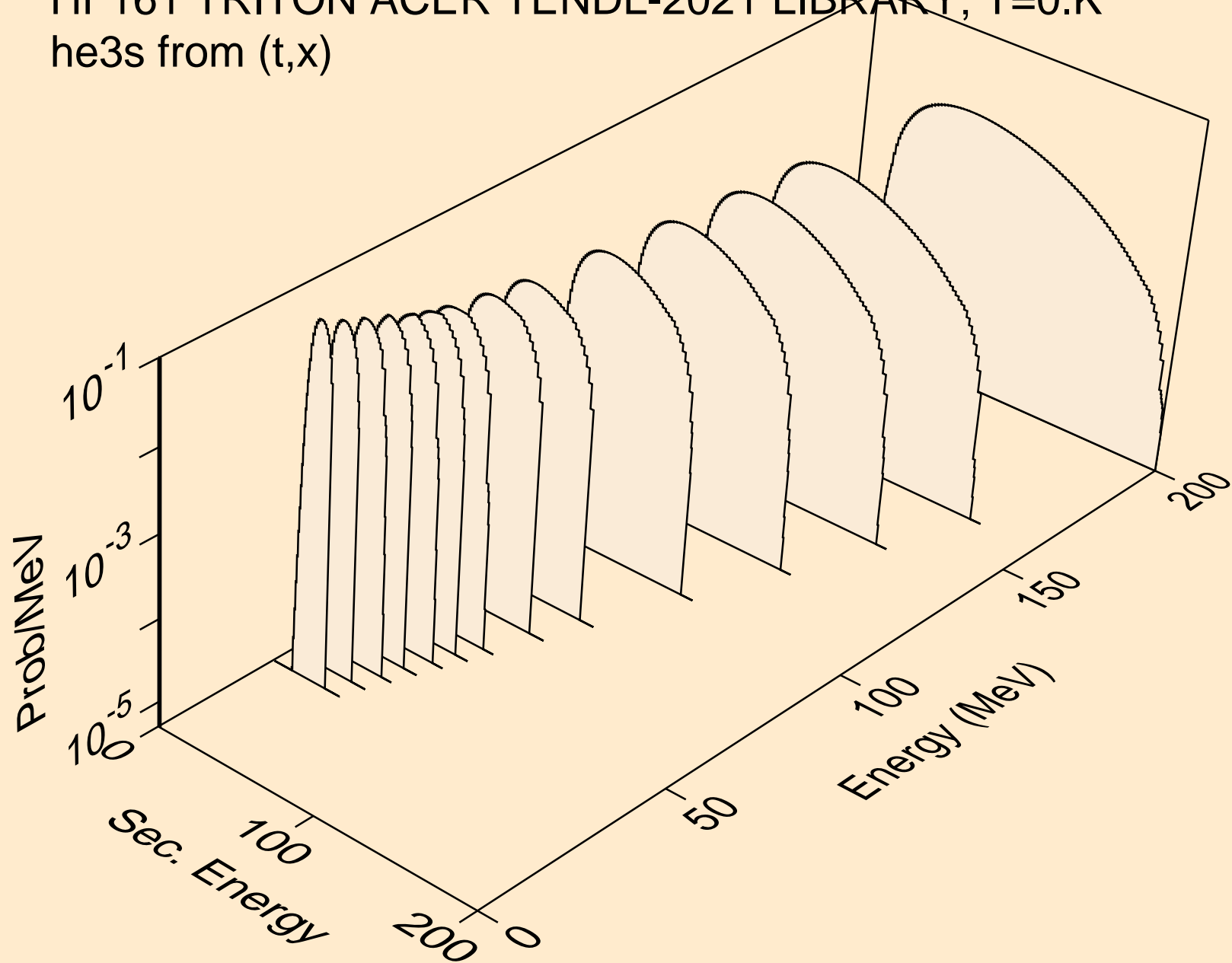

HF161 TRITON ACER TENDL-2021 LIBRARY; T=0.K  
he3s from (t,n\*)he3

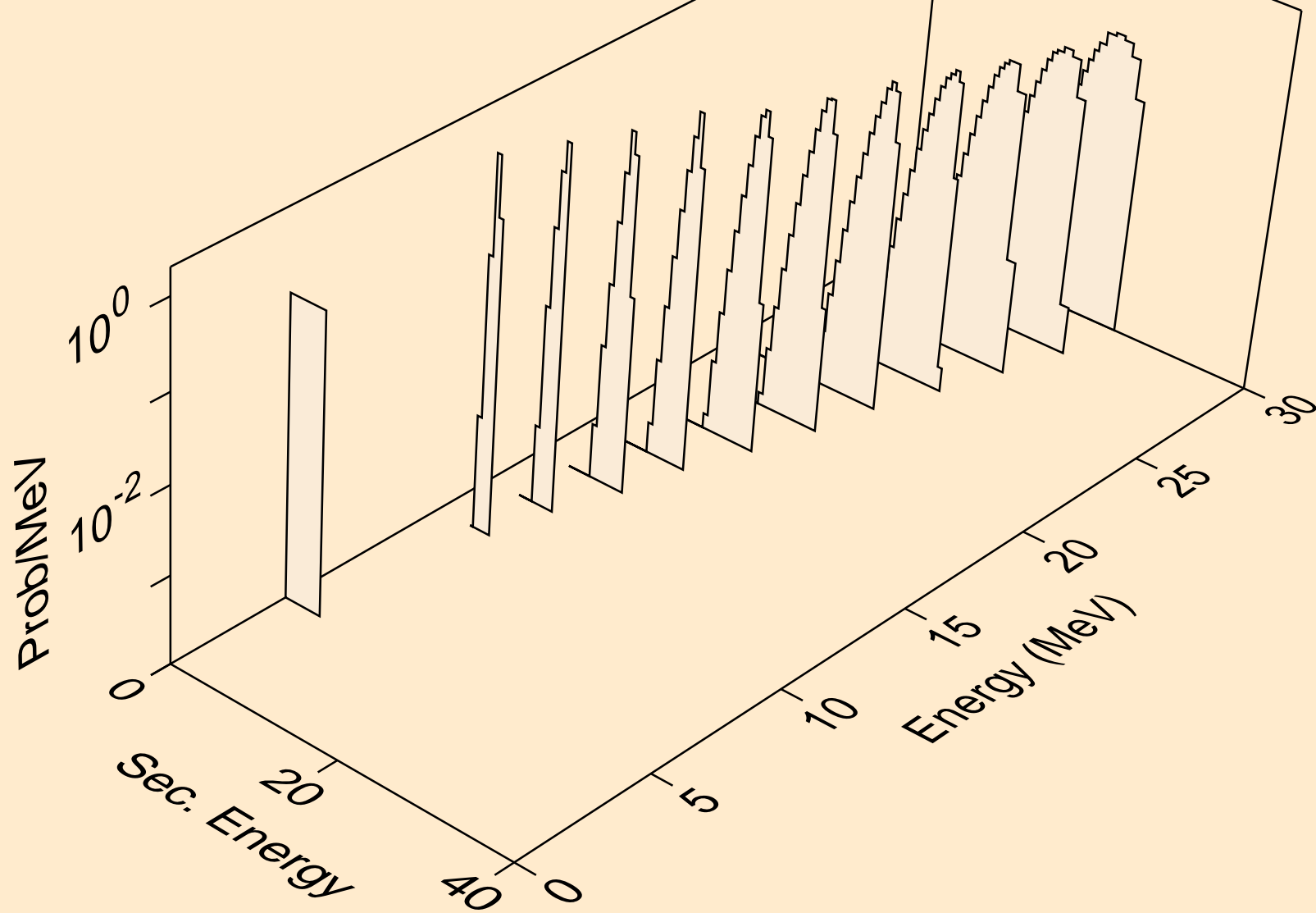

HF161 TRITON ACER TENDL-2021 LIBRARY; T=0.K  
he3s from (t,he3)

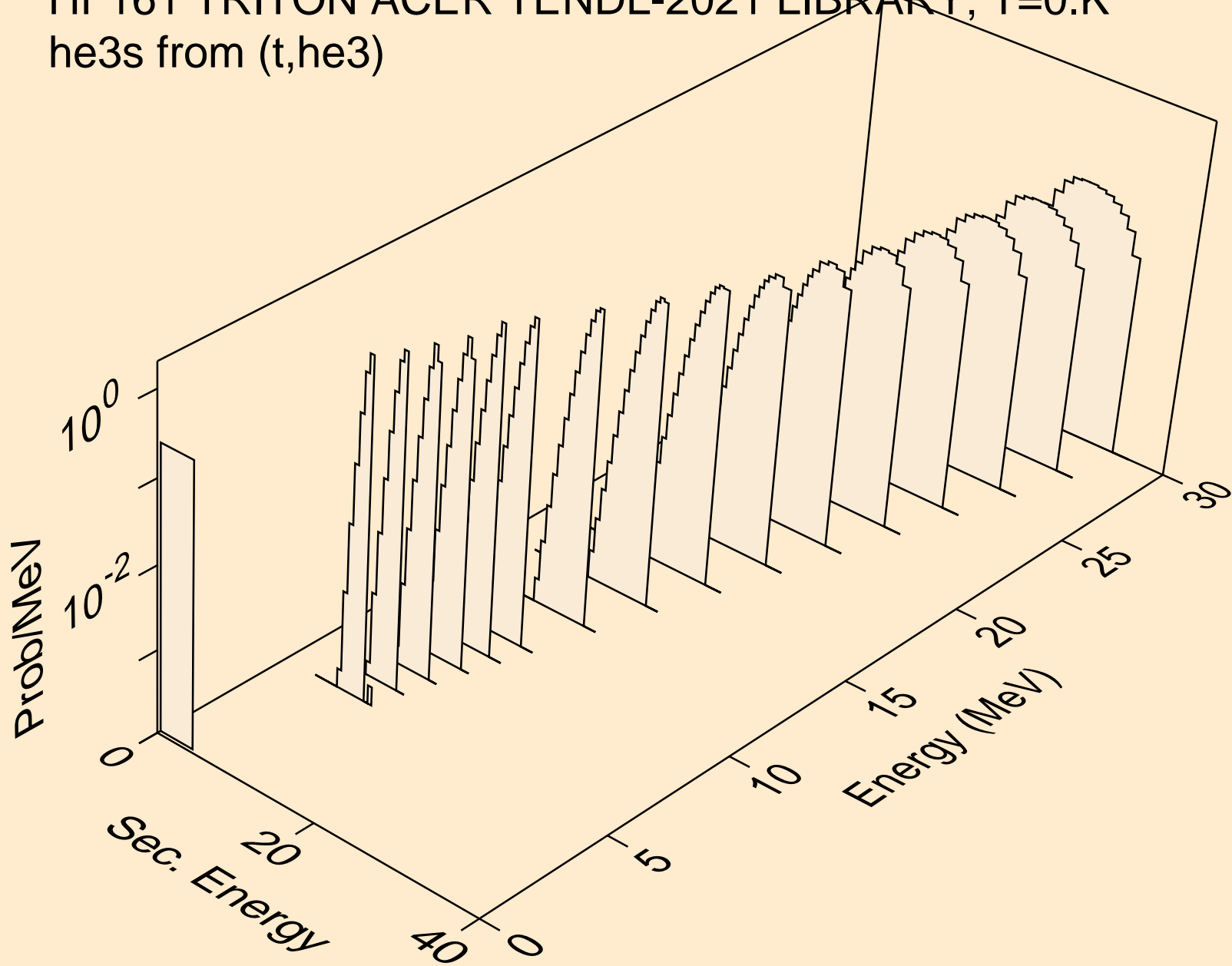

HF161 TRITON ACER TENDL-2021 LIBRARY; T=0.K  
alphas from (t,x)

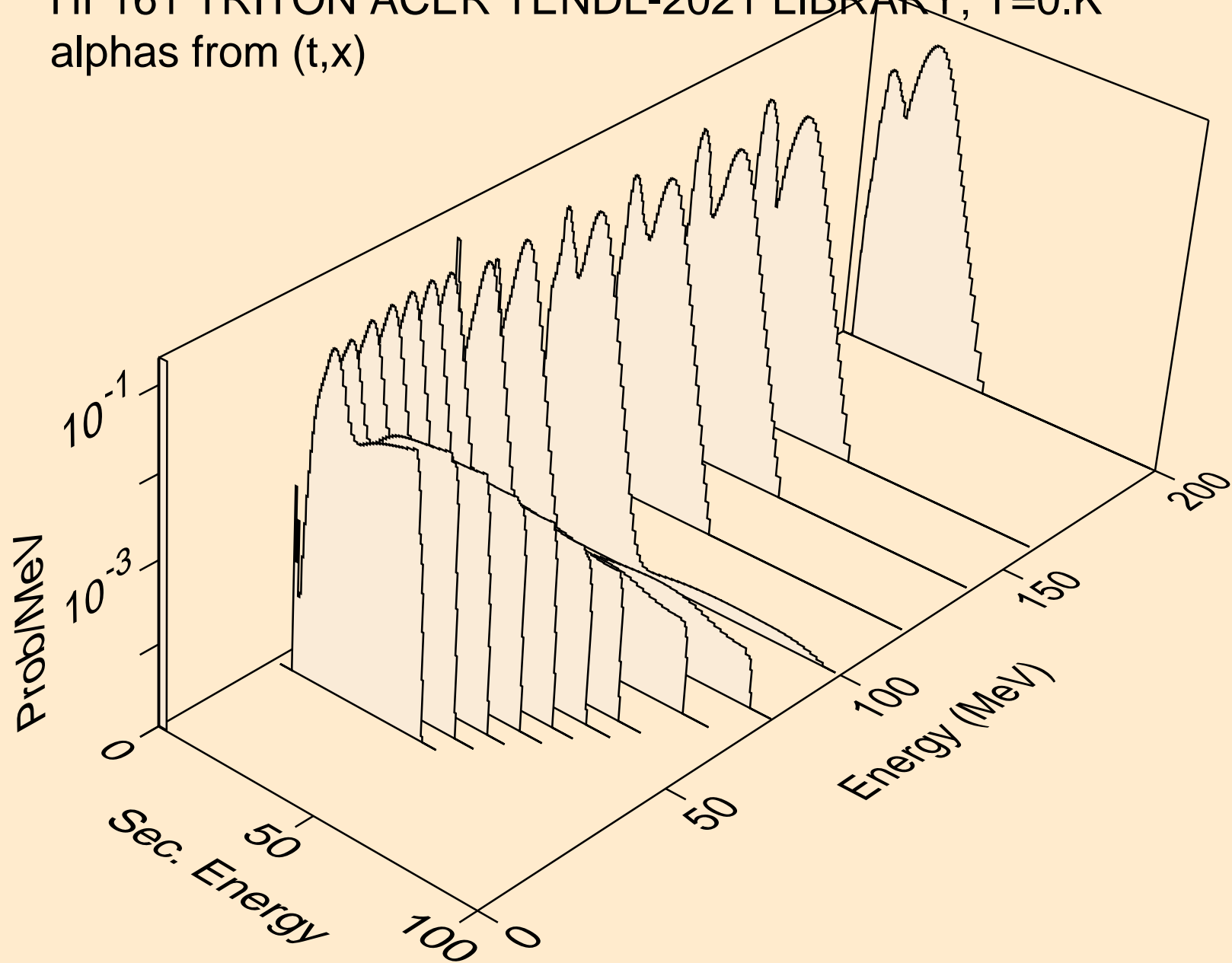

HF161 TRITON ACER TENDL-2021 LIBRARY; T=0.K  
alphas from (t,n\*)a

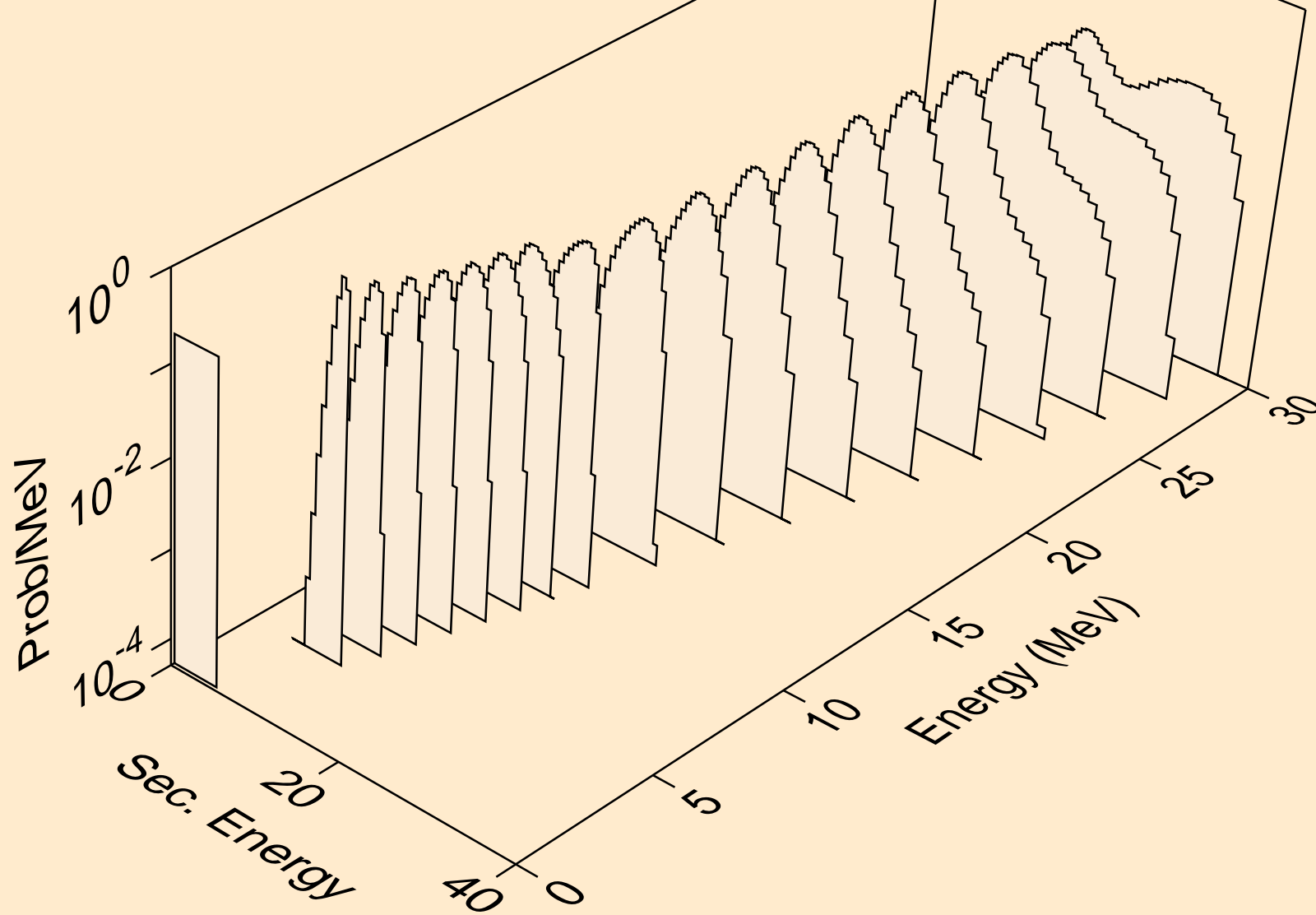

HF161 TRITON ACER TENDL-2021 LIBRARY; T=0.K  
alphas from (t,n\*)3a

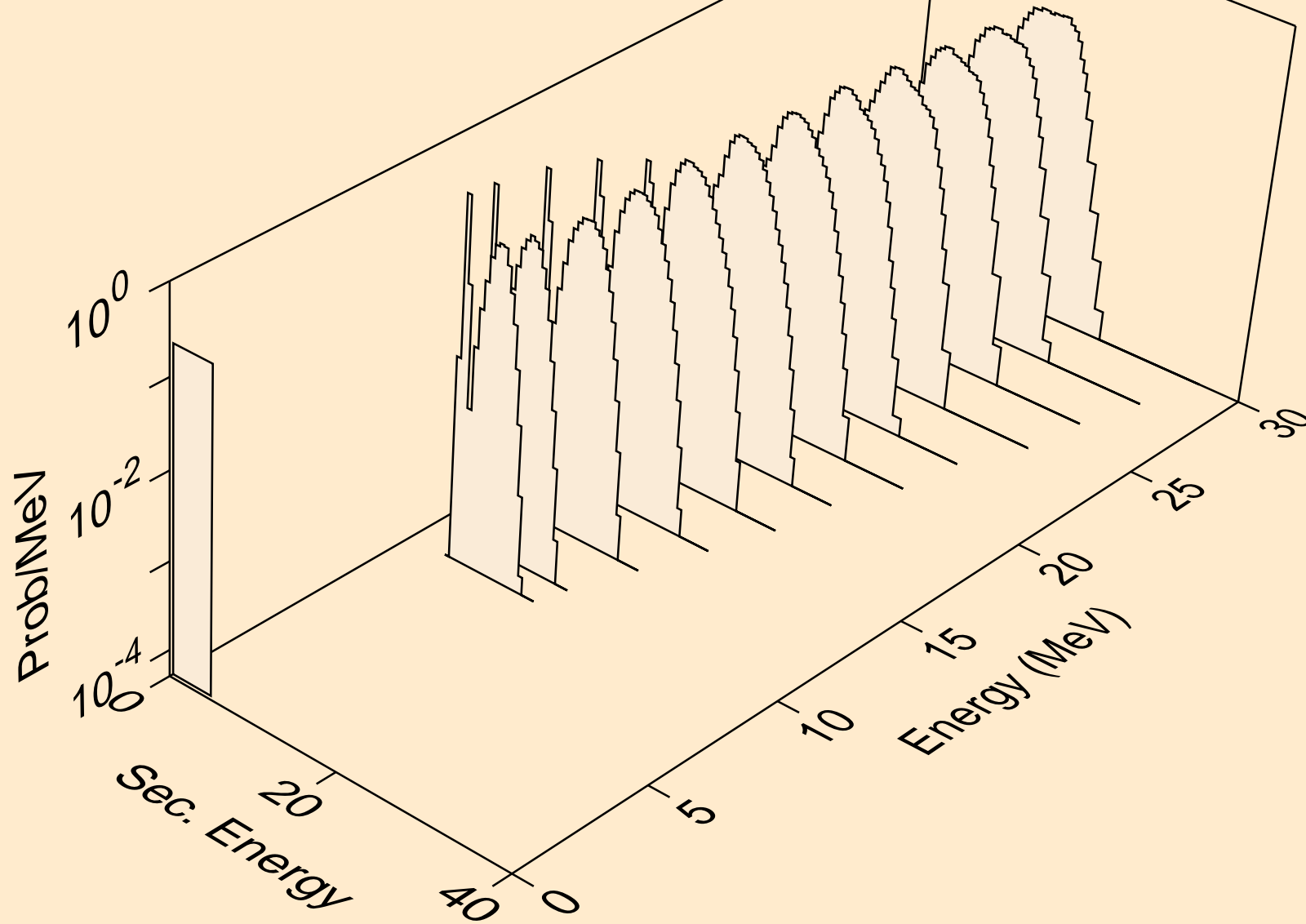

HF161 TRITON ACER TENDL-2021 LIBRARY; T=0.K  
alphas from (t,2n)a

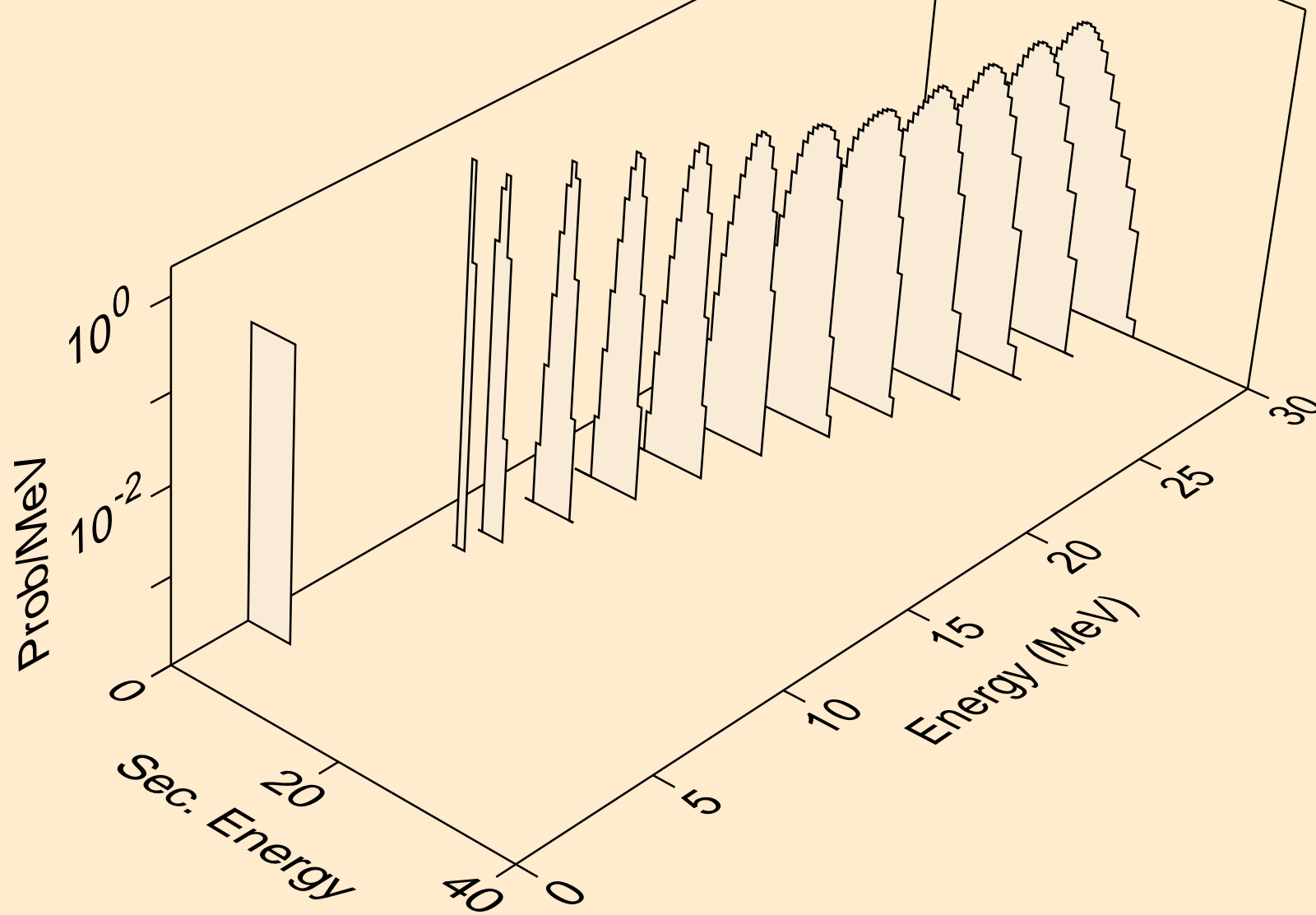



HF161 TRITON ACER TENDL-2021 LIBRARY; T=0.K  
alphas from (t,3n)a

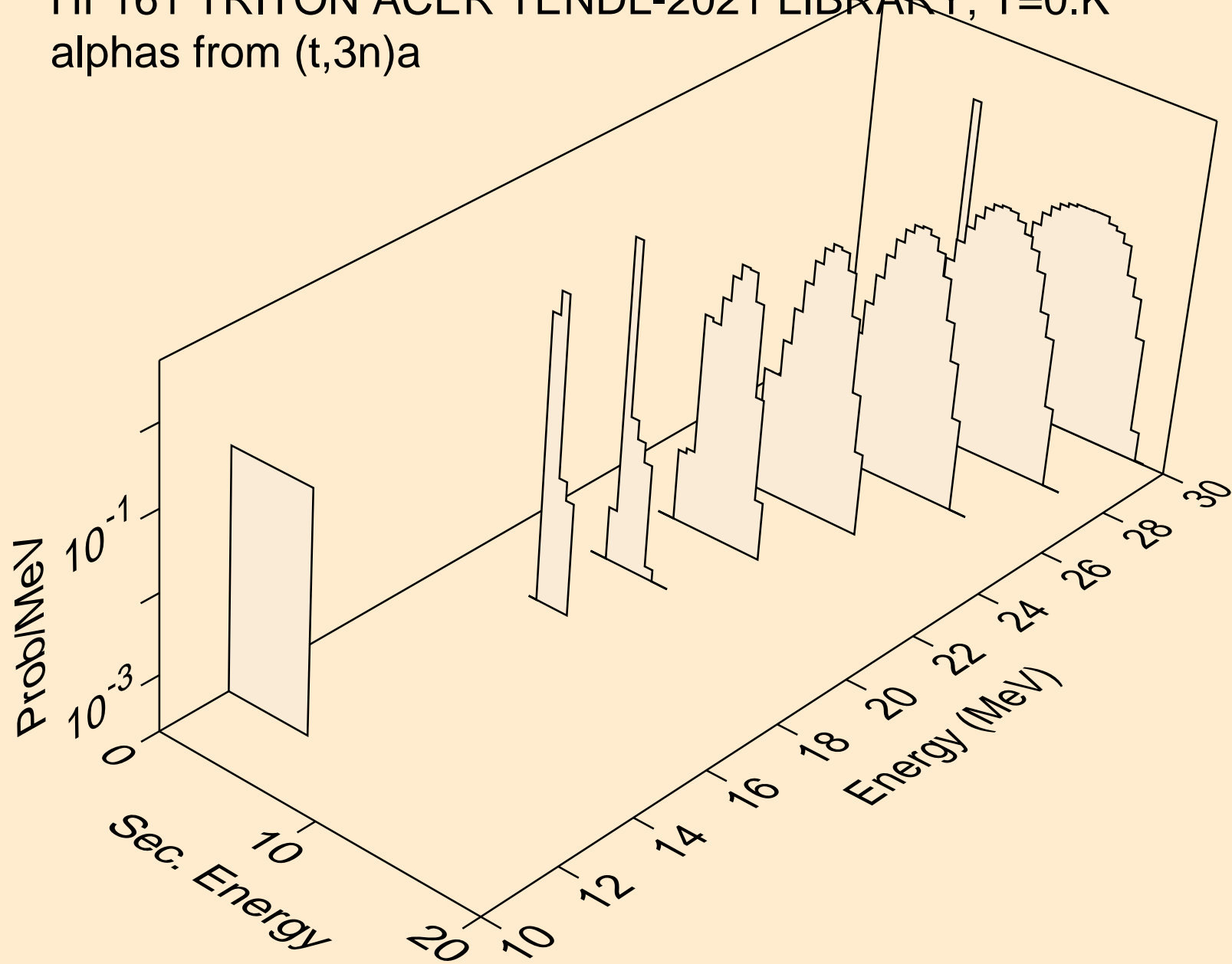

HF161 TRITON ACER TENDL-2021 LIBRARY; T=0.K  
alphas from (t,n\*)2a

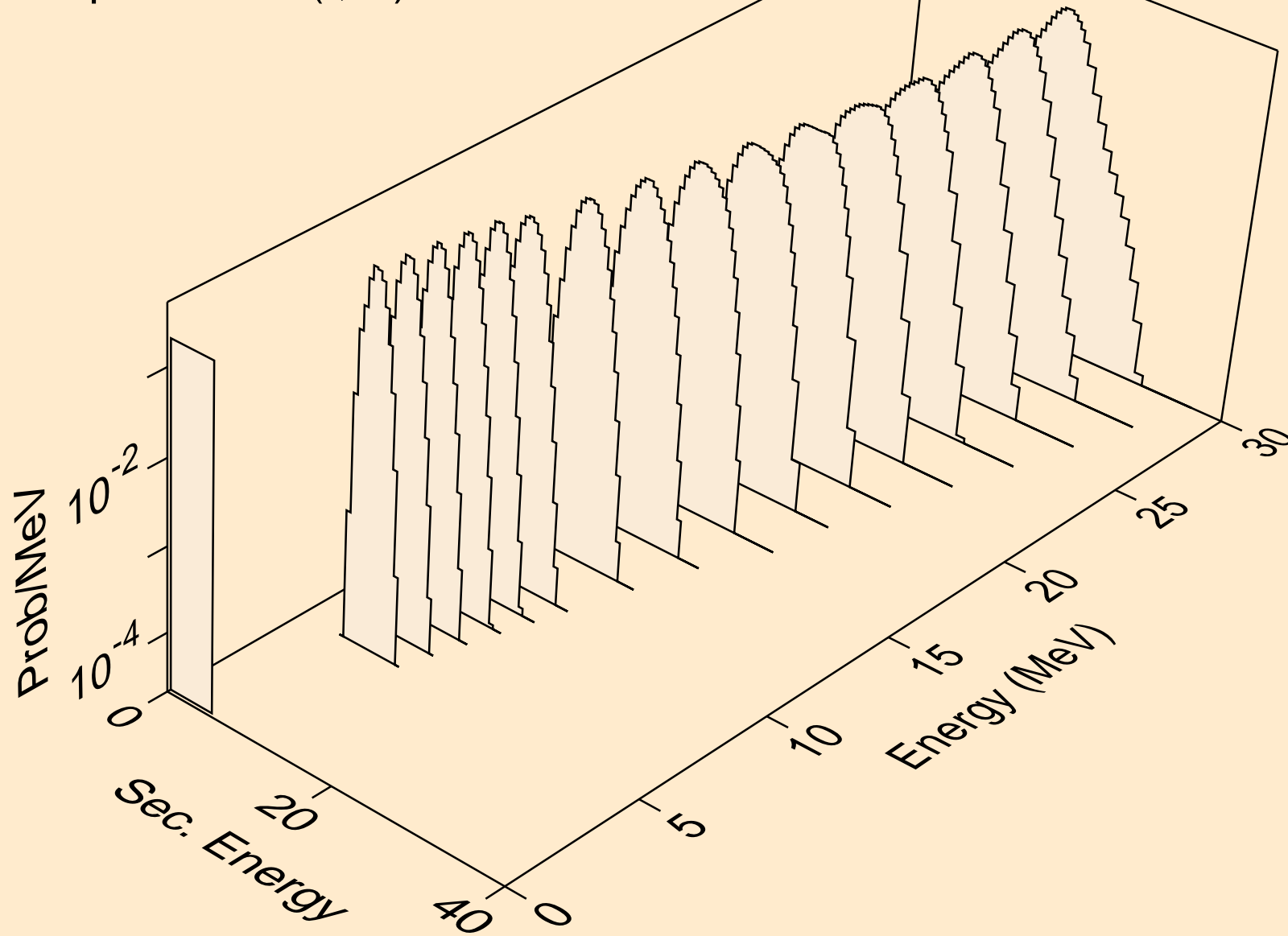

HF161 TRITON ACER TENDL-2021 LIBRARY; T=0.K  
alphas from (t,2n)2a

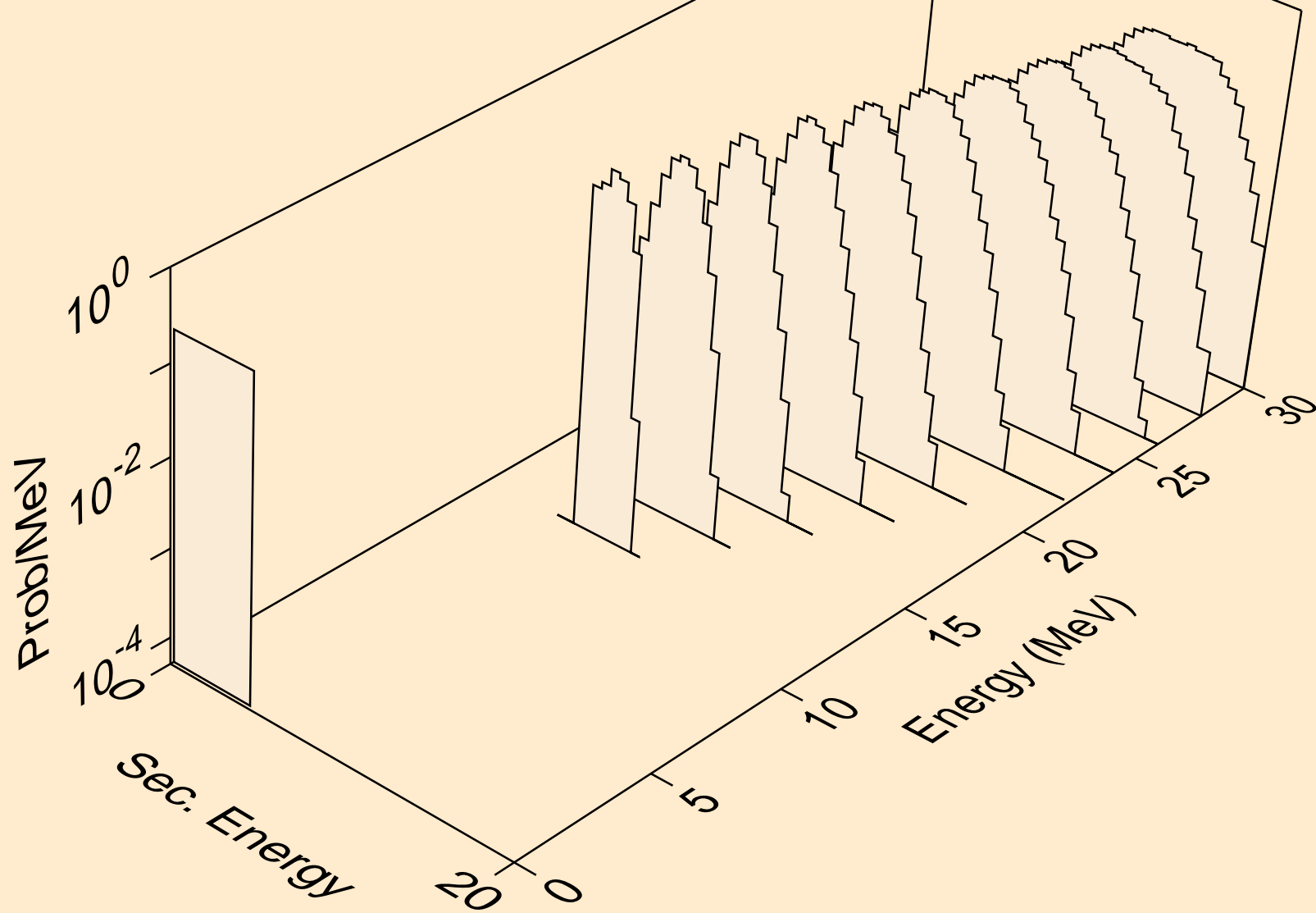

HF161 TRITON ACER TENDL-2021 LIBRARY; T=0.K  
alphas from (t,npa)

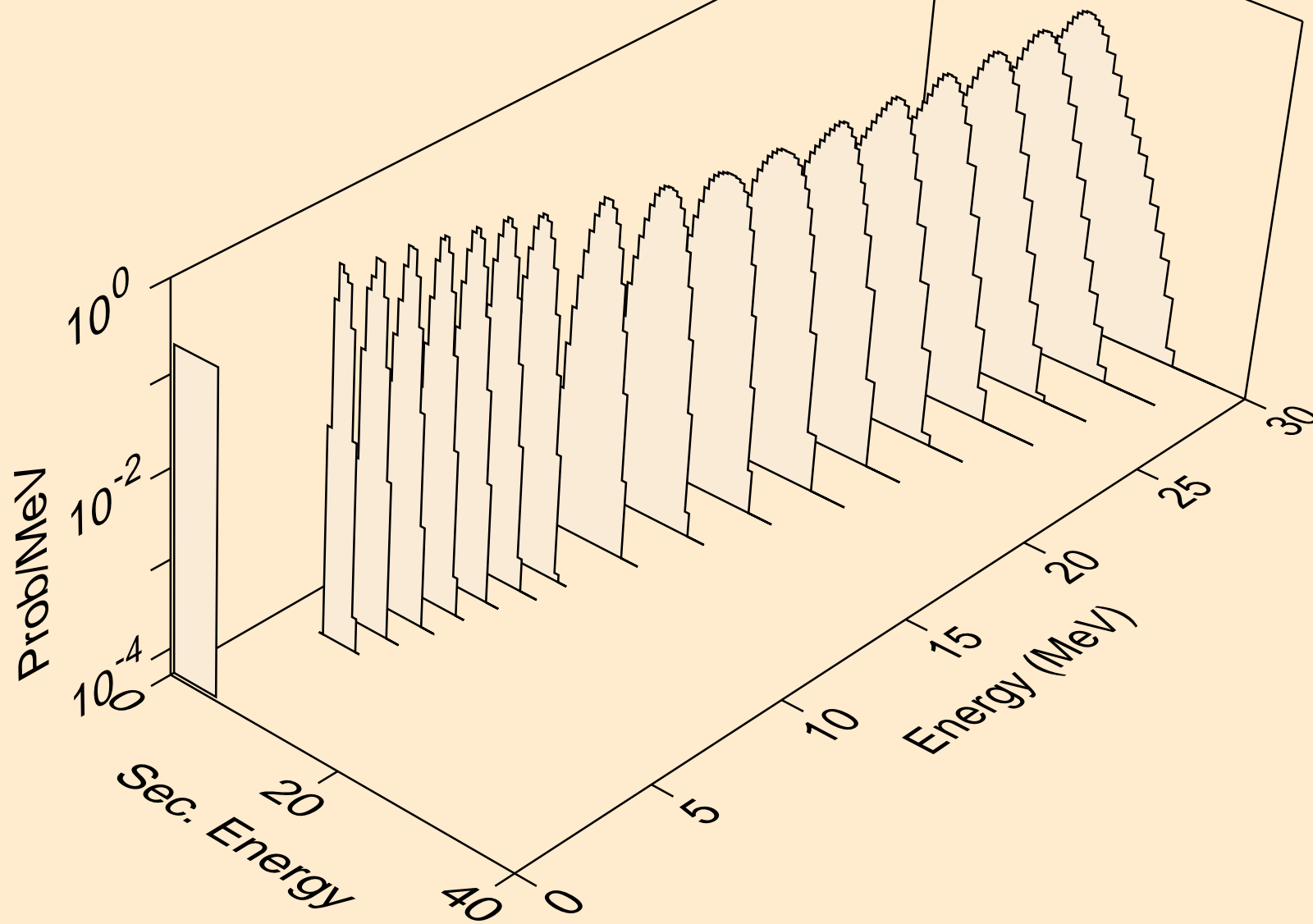

HF161 TRITON ACER TENDL-2021 LIBRARY; T=0.K  
alphas from (t,a)

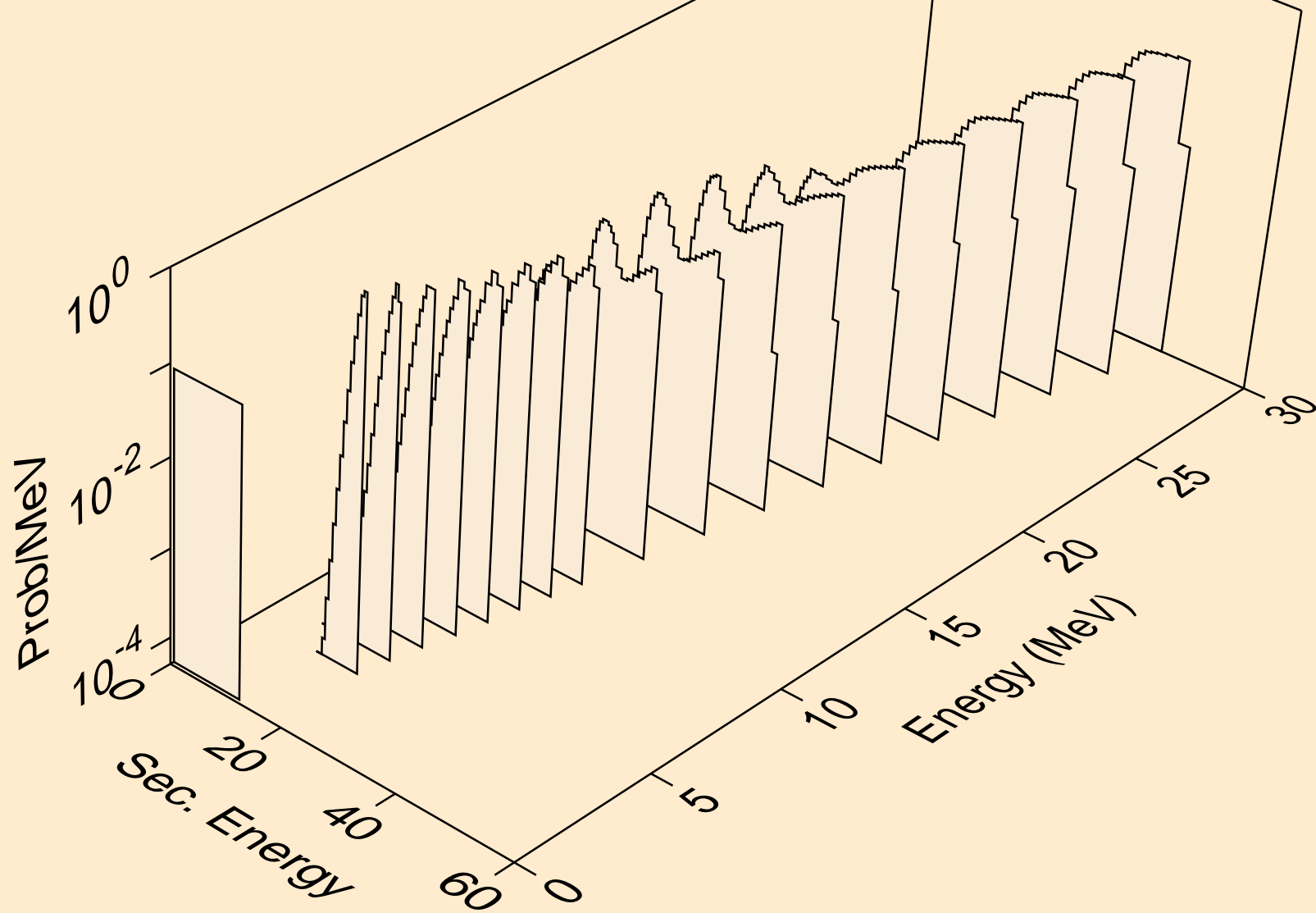

HF161 TRITON ACER TENDL-2021 LIBRARY; T=0.K  
alphas from (t,2a)

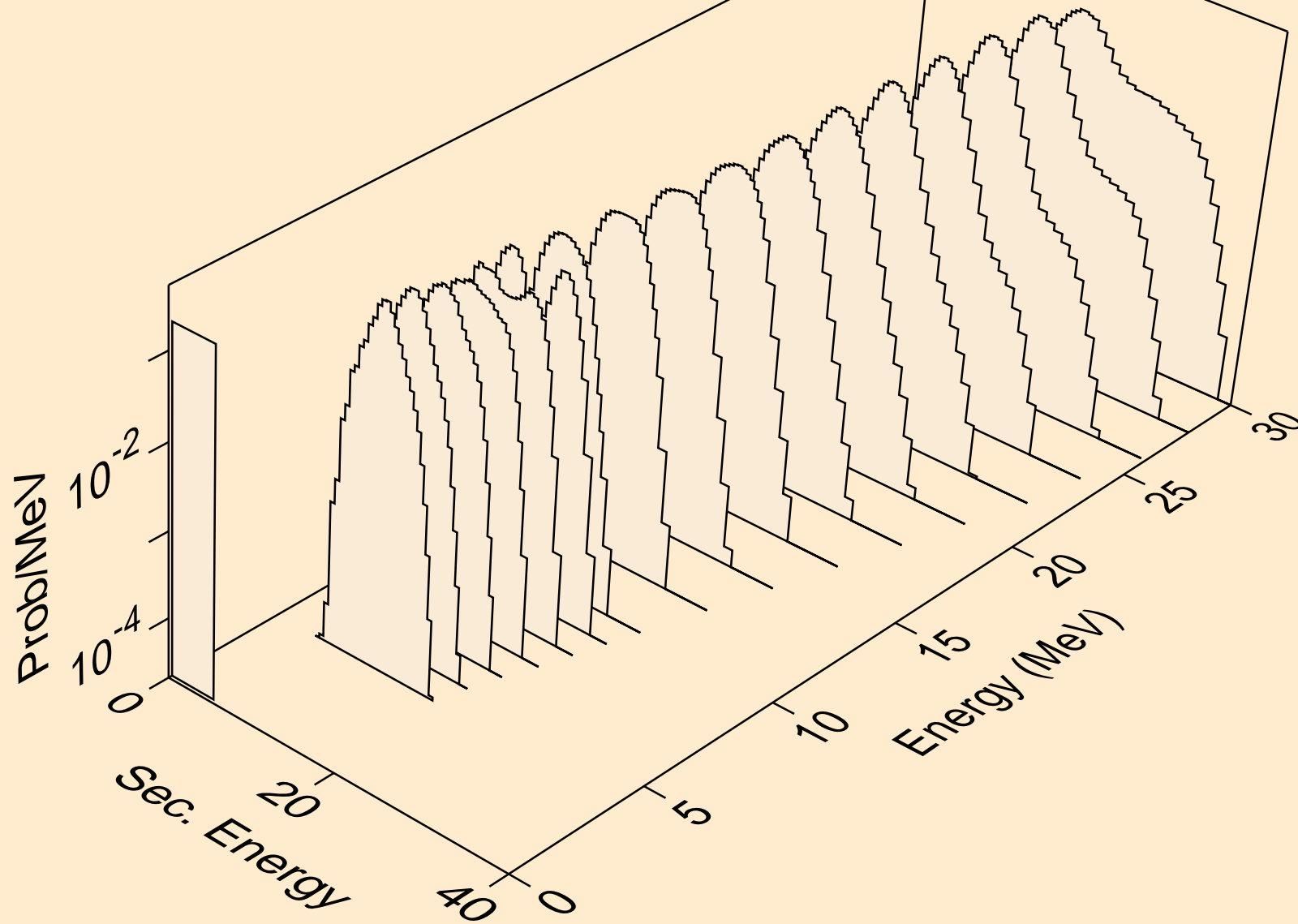

HF161 TRITON ACER TENDL-2021 LIBRARY; T=0.K  
alphas from (t,3a)

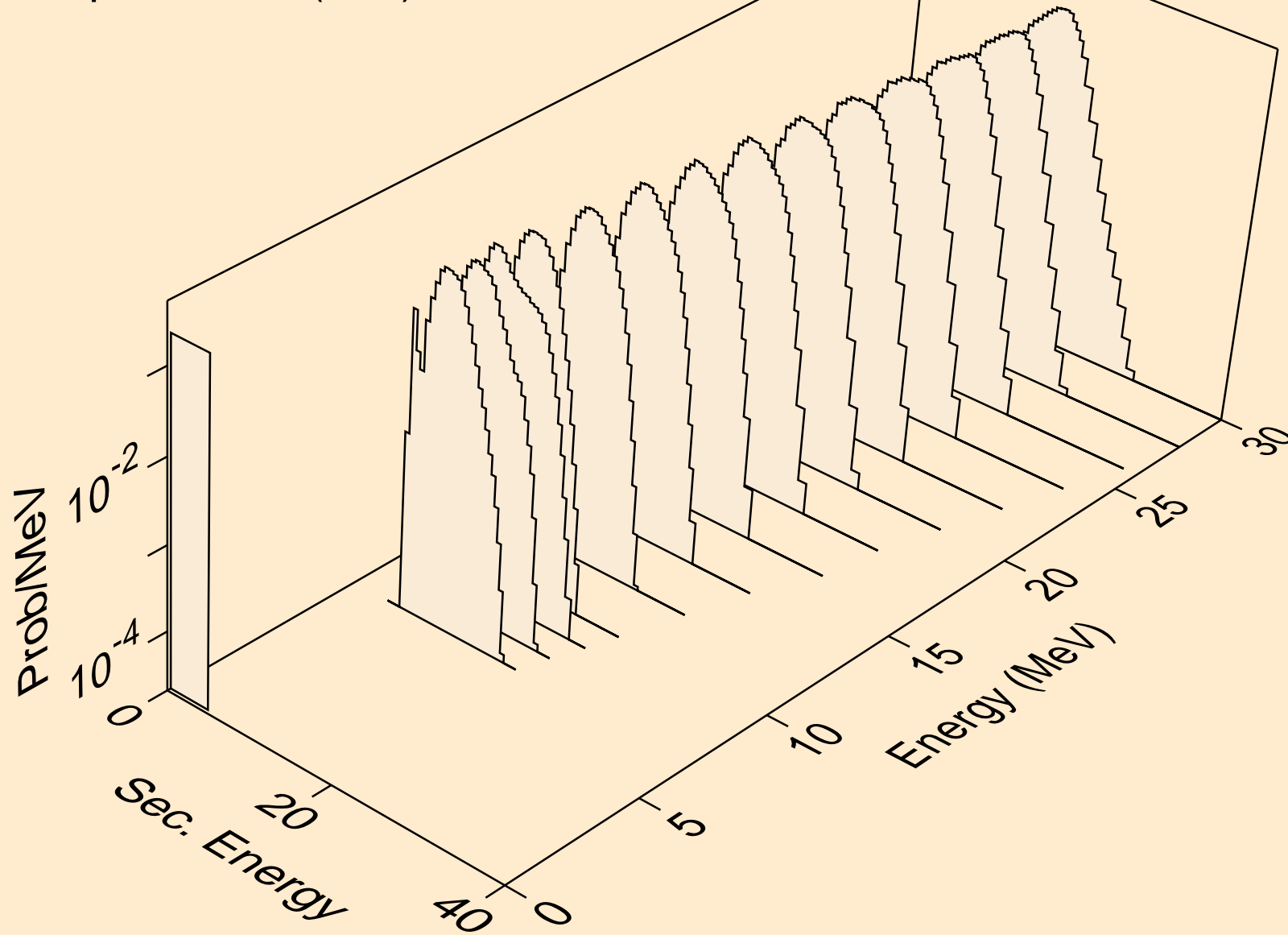

HF161 TRITON ACER TENDL-2021 LIBRARY; T=0.K  
alphas from (t,pa)

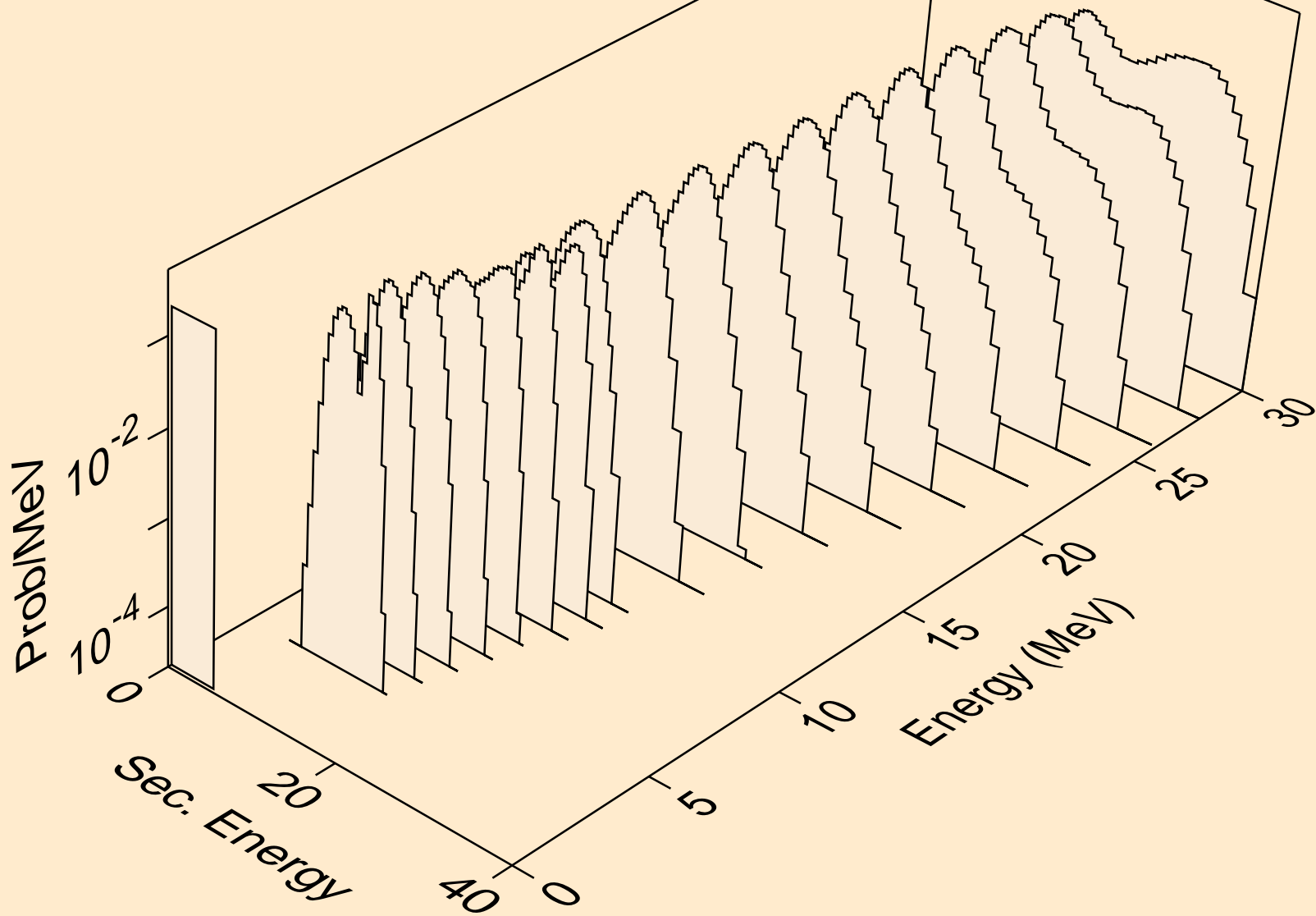



HF161 TRITON ACER TENDL-2021 LIBRARY; T=0.K  
alphas from (t,t2a)

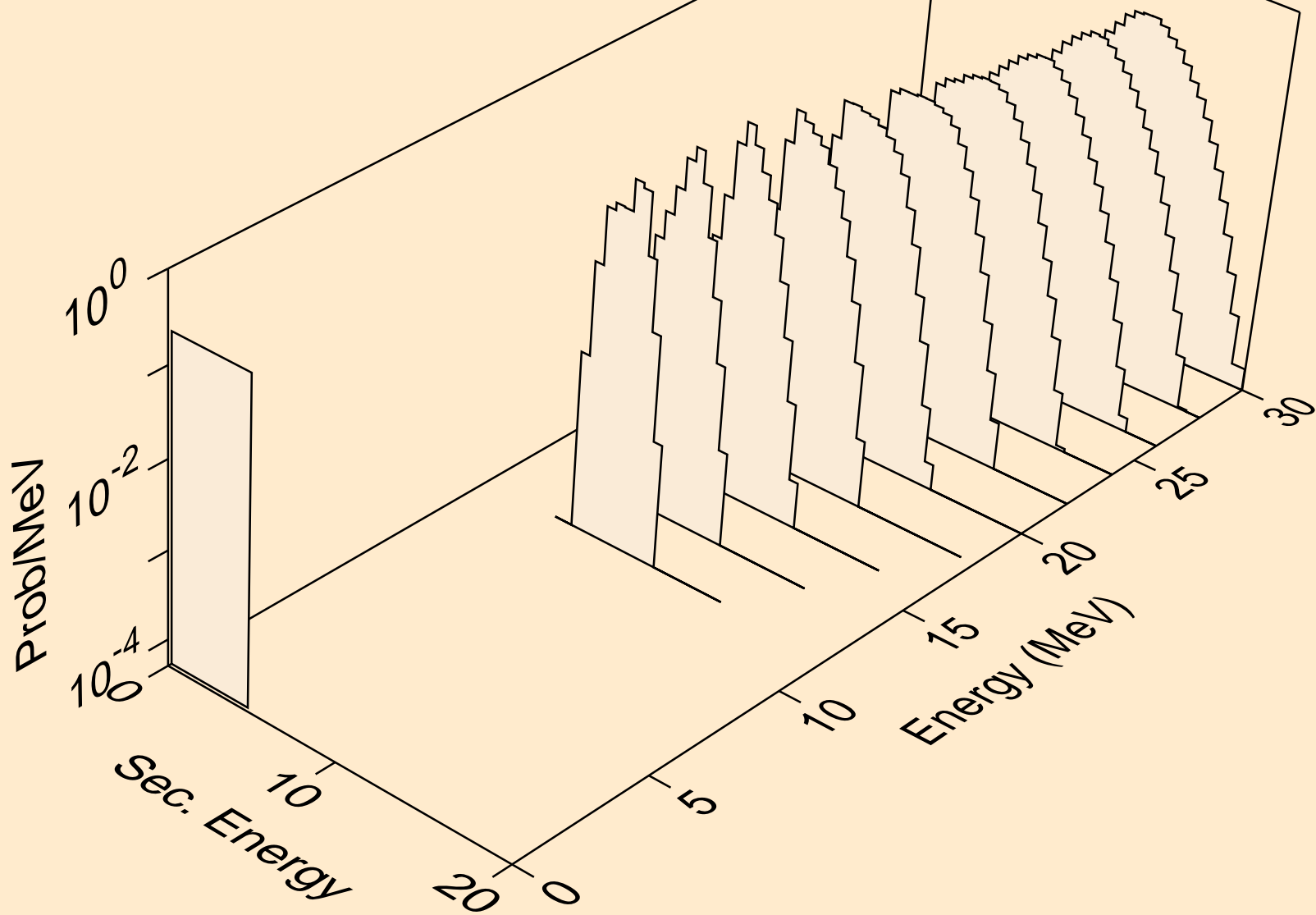

HF161 TRITON ACER TENDL-2021 LIBRARY; T=0.K  
alphas from (t,d2a)

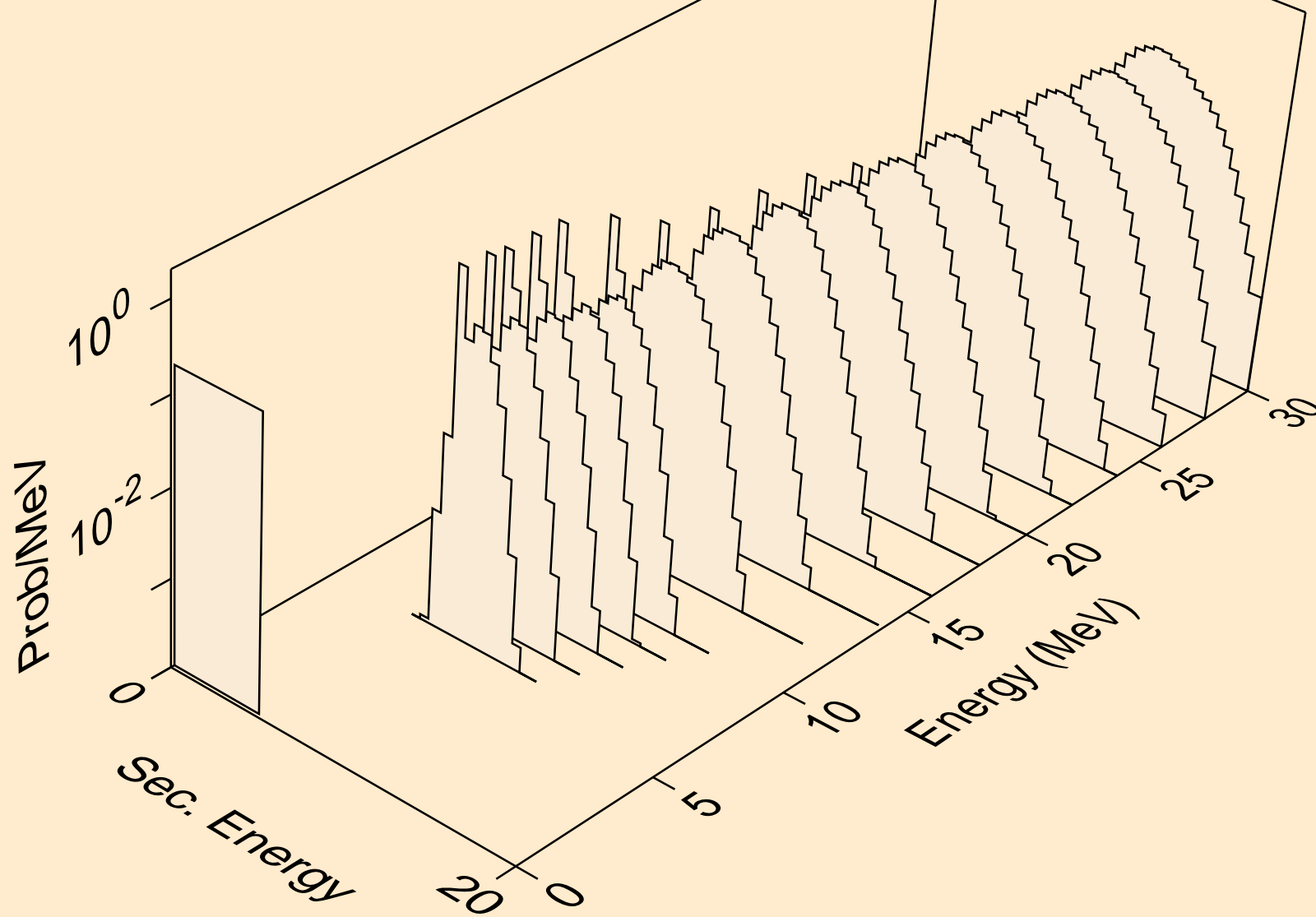

HF161 TRITON ACER TENDL-2021 LIBRARY; T=0.K  
alphas from (t,da)

