

# HO164 TRITON ACER TENDL-2021 LIBRARY; T=0.K

## Principal cross sections

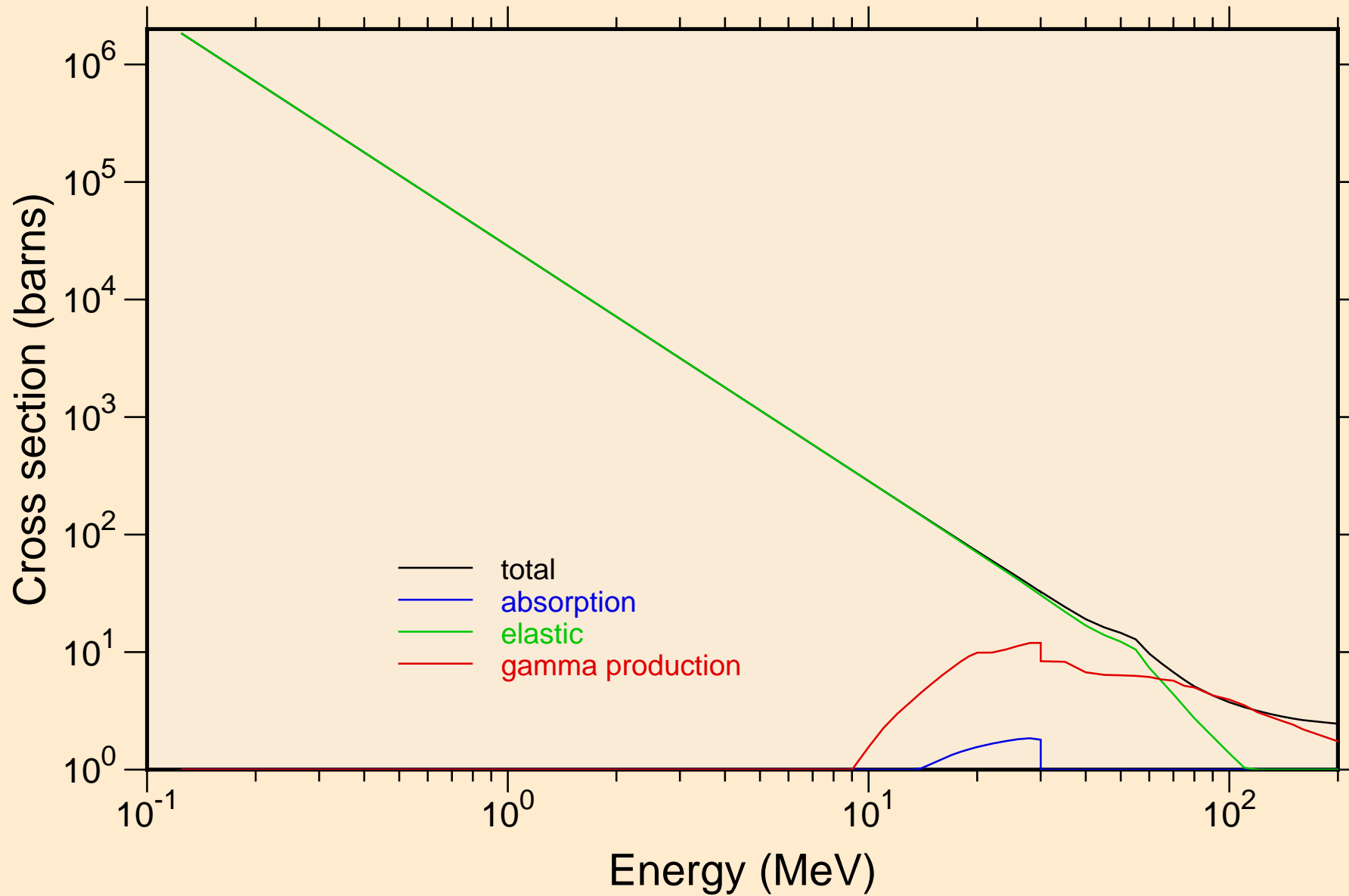

# HO164 TRITON ACER TENDL-2021 LIBRARY; T=0.K

## Heating

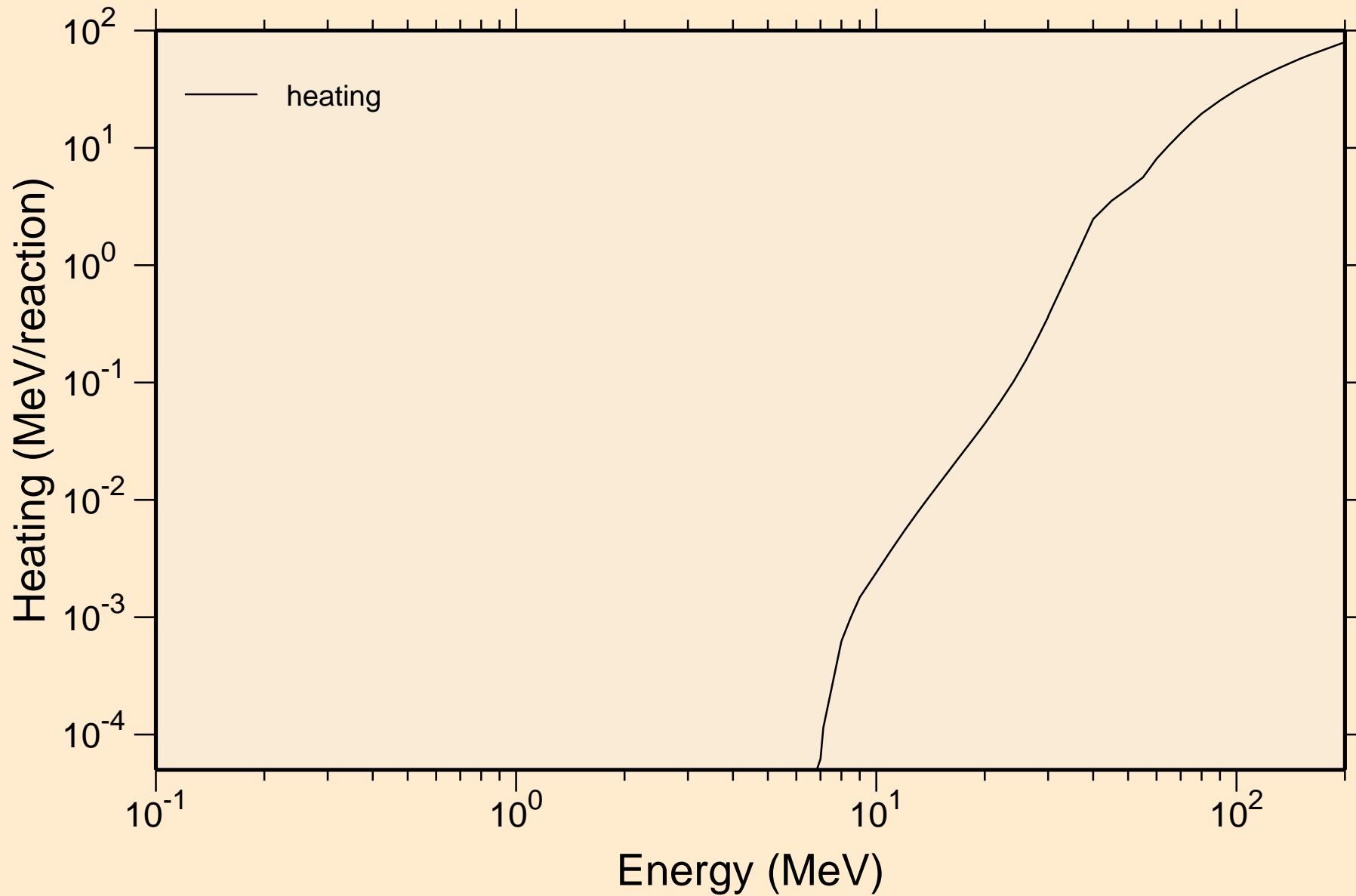

# HO164 TRITON ACER TENDL-2021 LIBRARY; T=0.K

## Principal cross sections

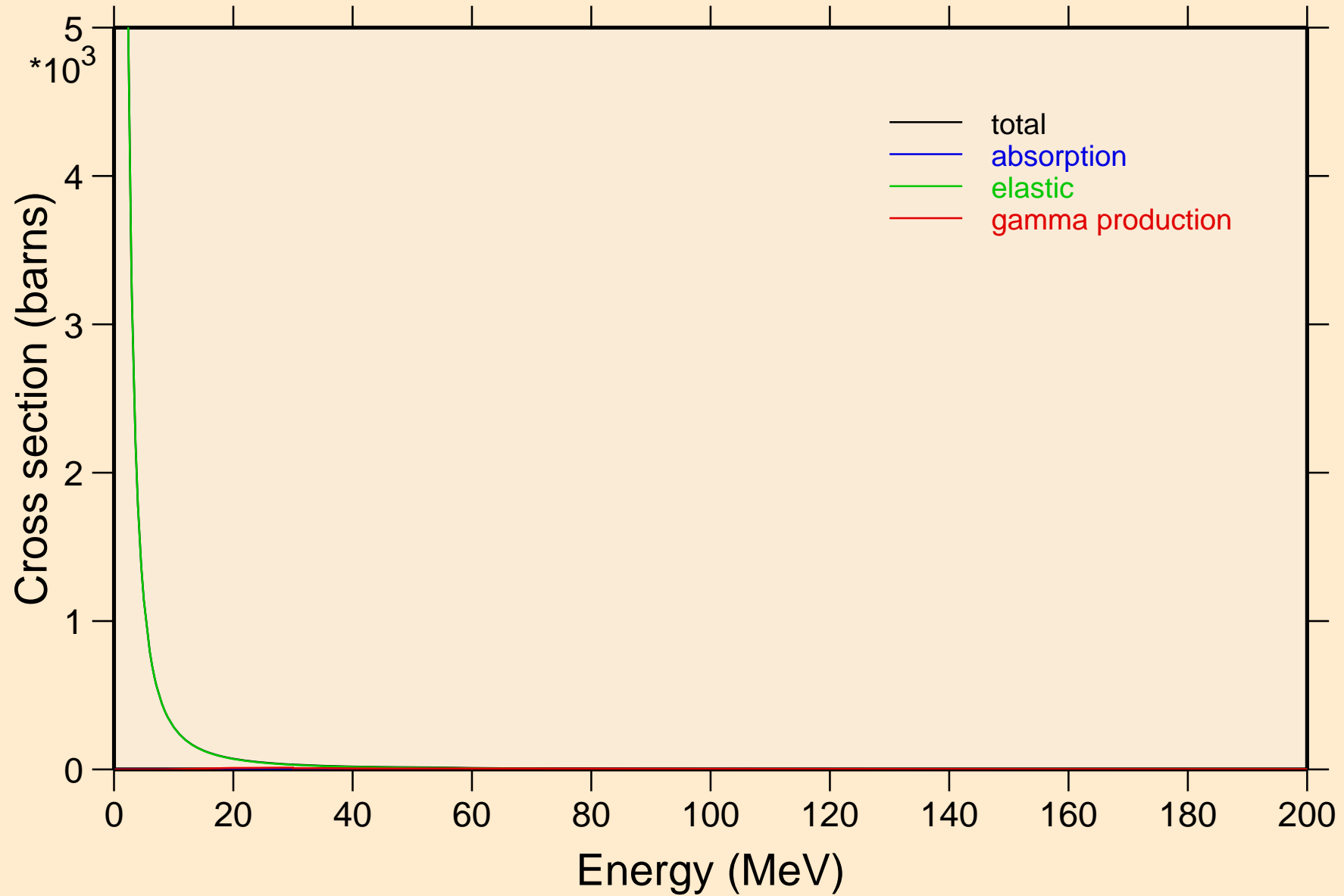

HO164 TRITON ACER TENDL-2021 LIBRARY; T=0.K

Heating

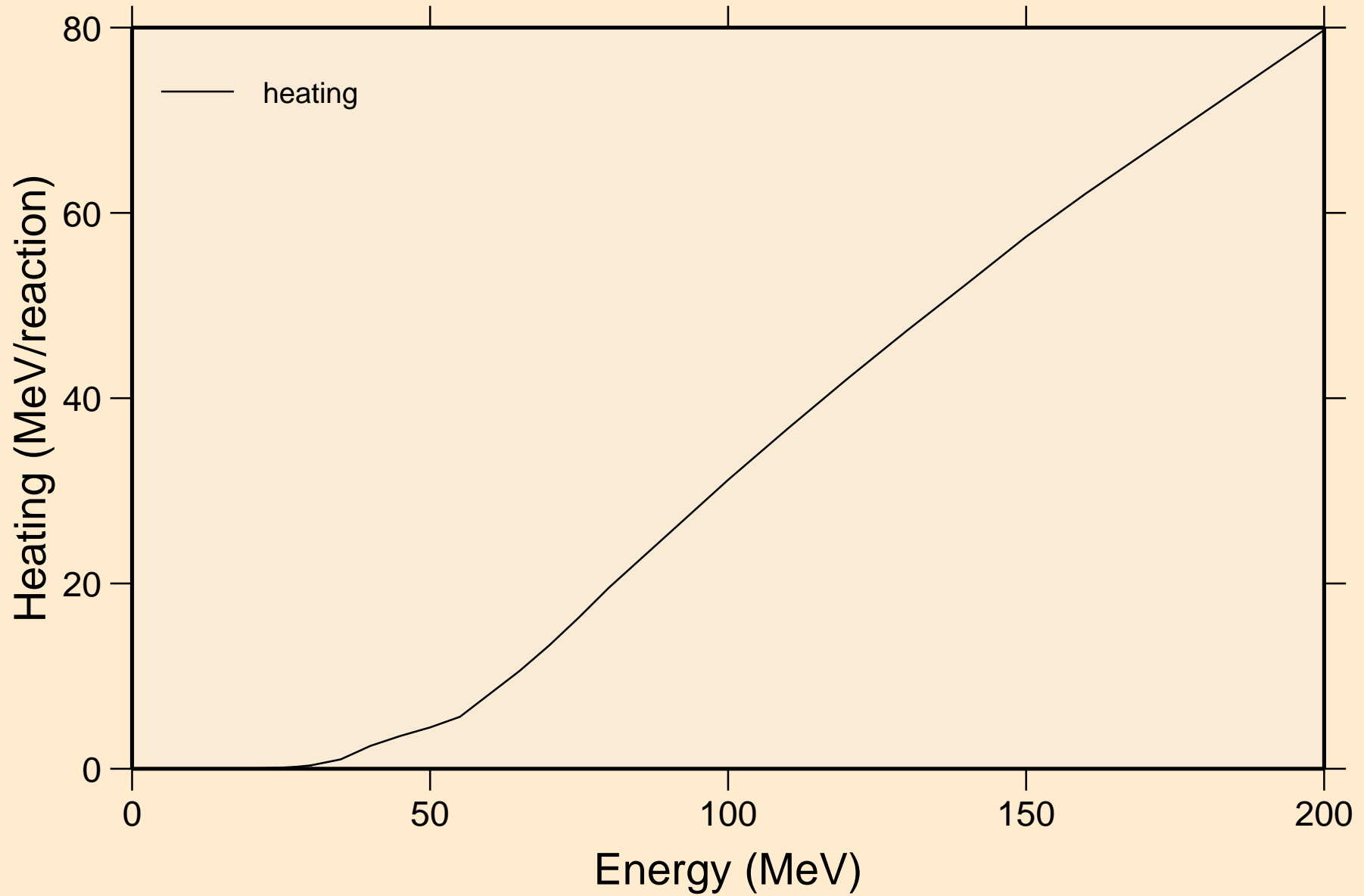

HO164 TRITON ACER TENDL-2021 LIBRARY; T=0.K  
Threshold reactions

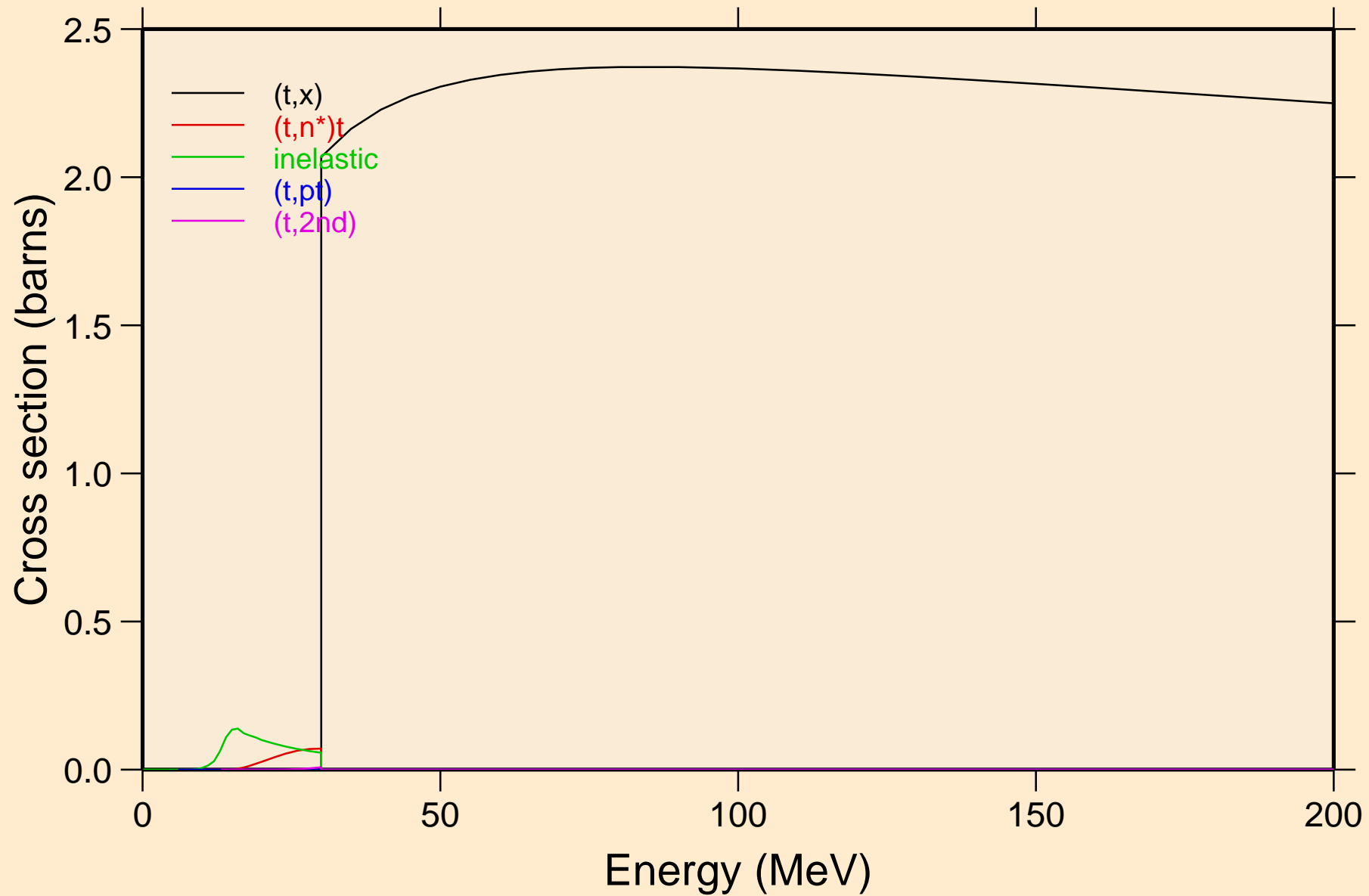

HO164 TRITON ACER TENDL-2021 LIBRARY; T=0.K  
Threshold reactions

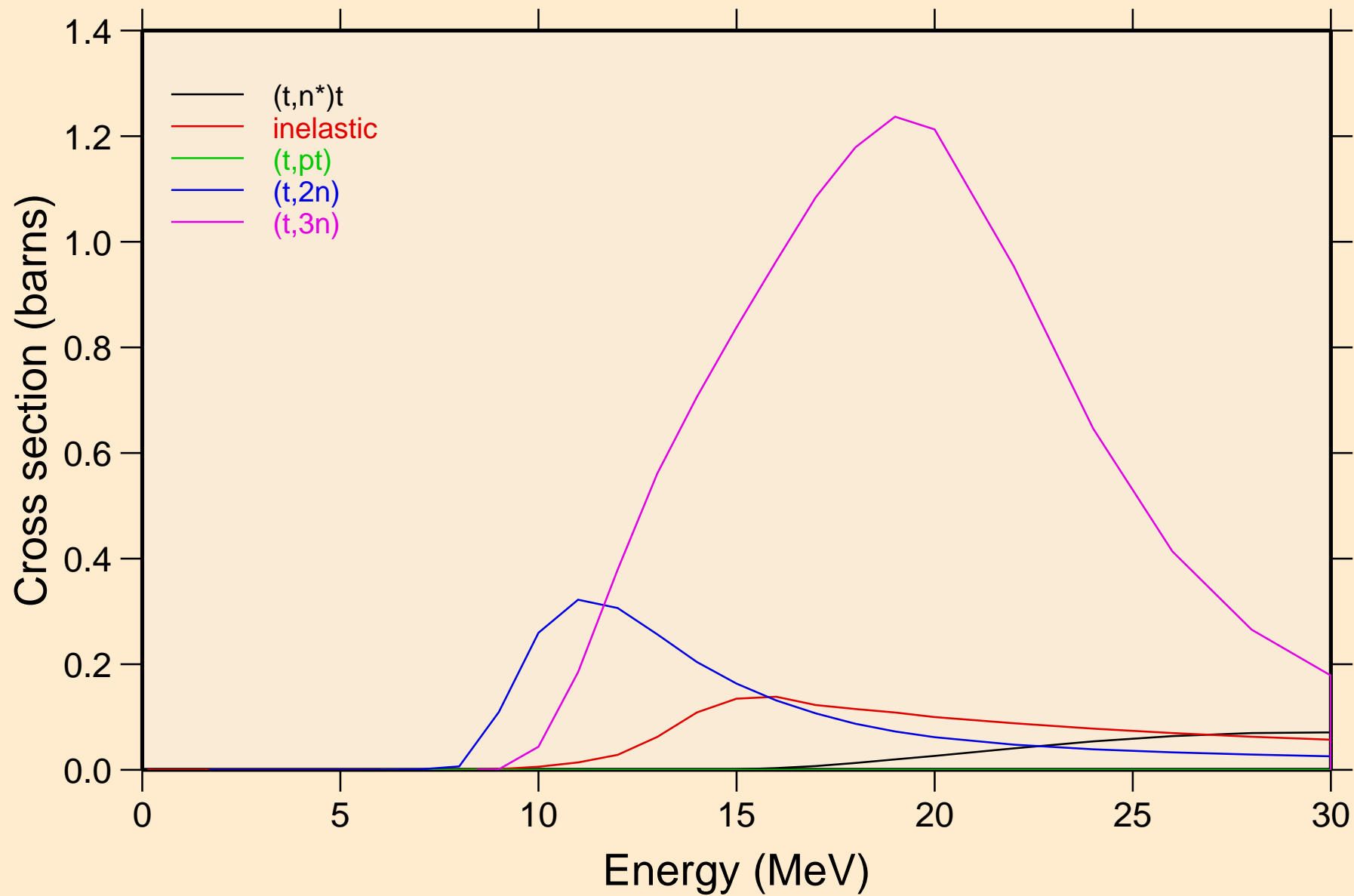

HO164 TRITON ACER TENDL-2021 LIBRARY; T=0.K  
Threshold reactions

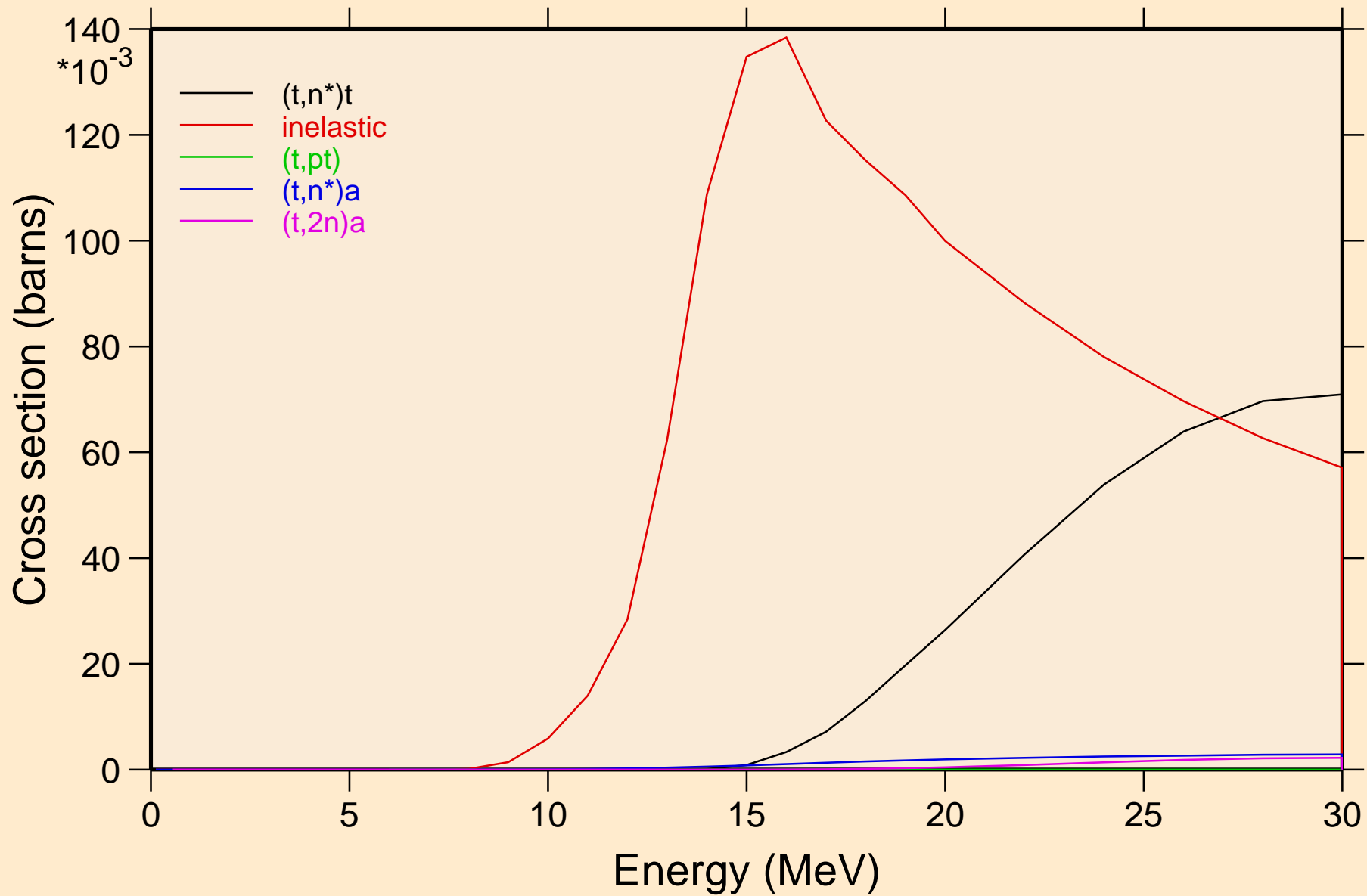

# HO164 TRITON ACER TENDL-2021 LIBRARY; T=0.K

## Threshold reactions

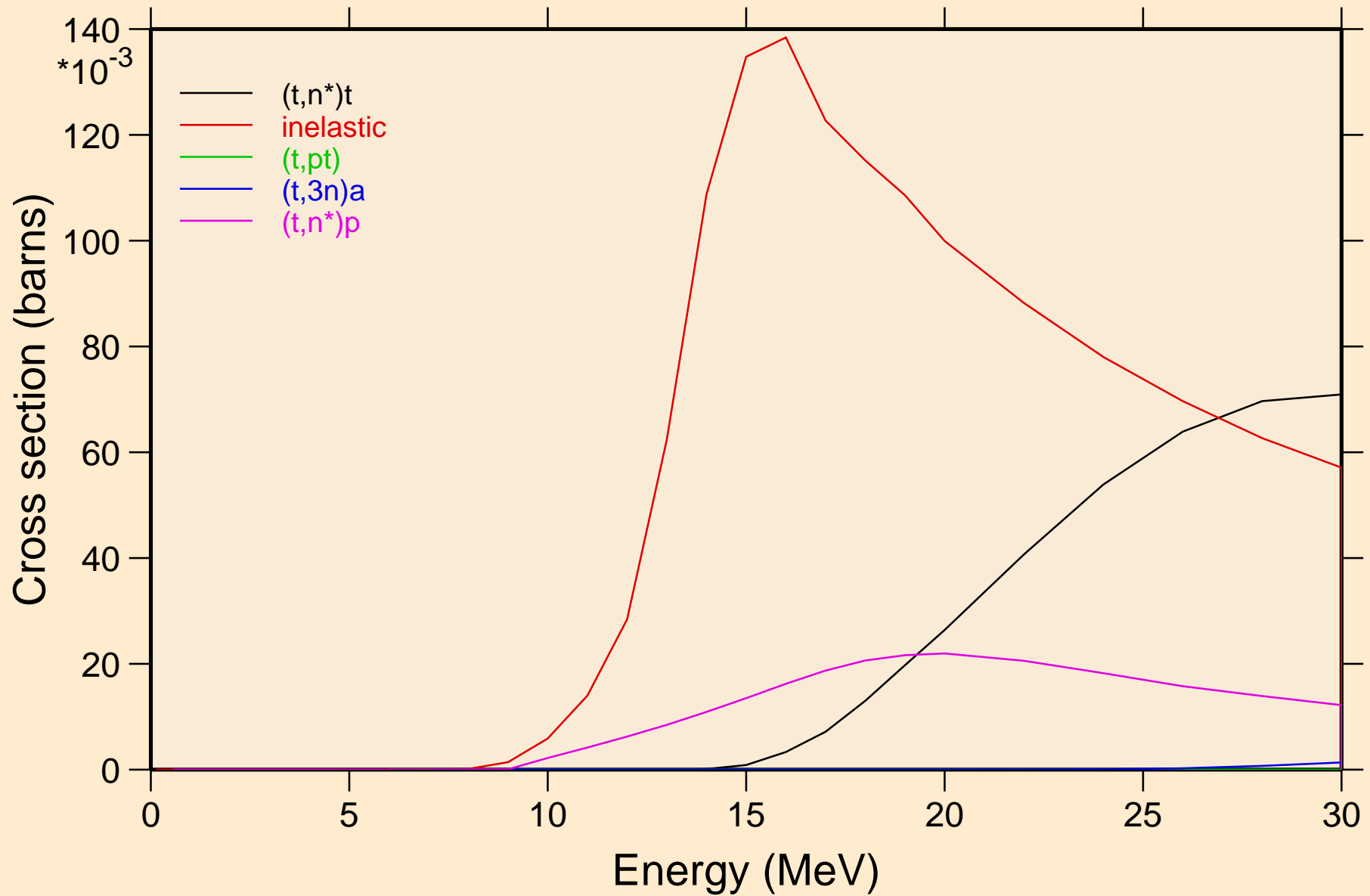



# HO164 TRITON ACER TENDL-2021 LIBRARY; T=0.K

## Threshold reactions

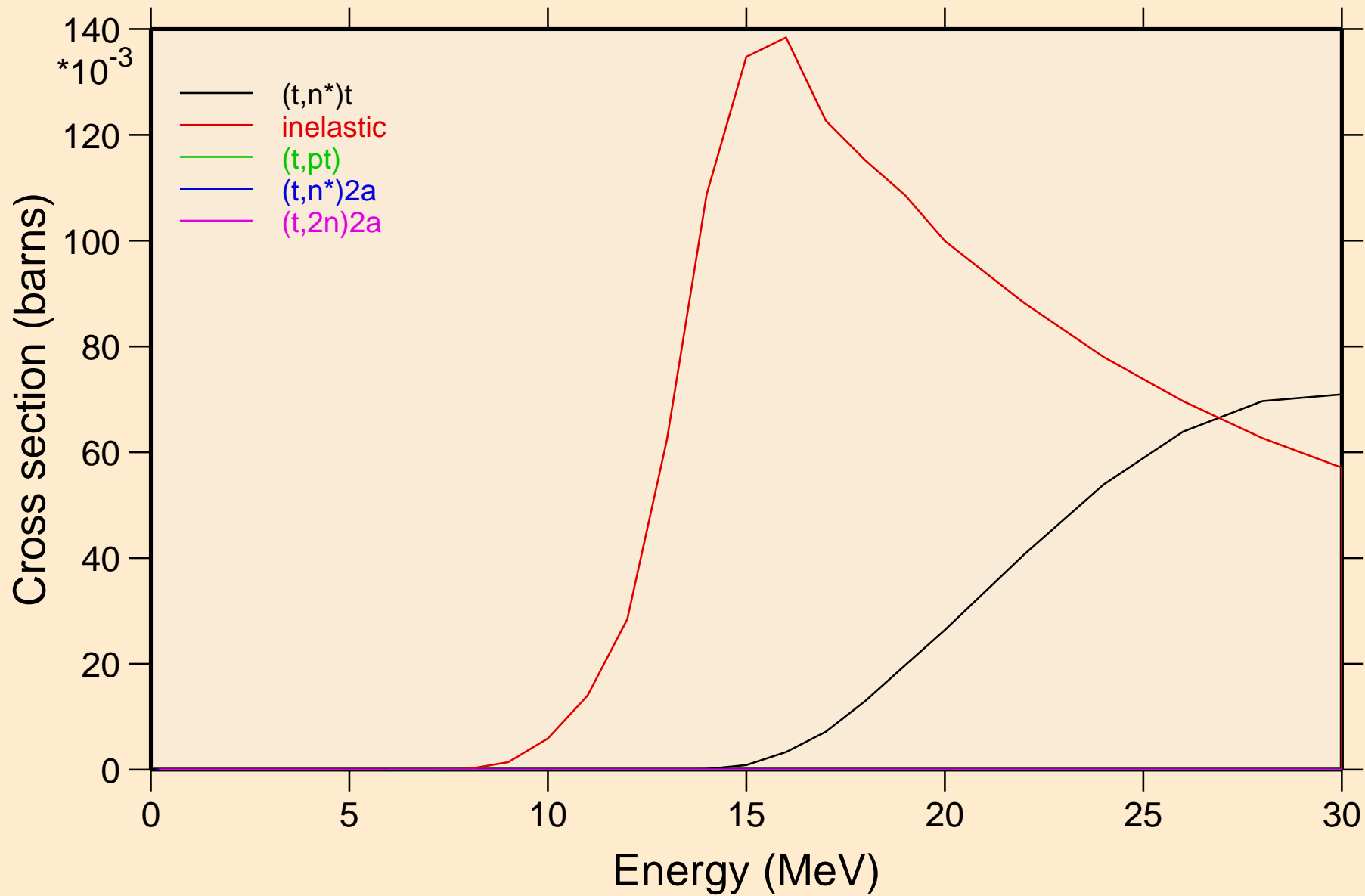

# HO164 TRITON ACER TENDL-2021 LIBRARY; T=0.K

## Threshold reactions

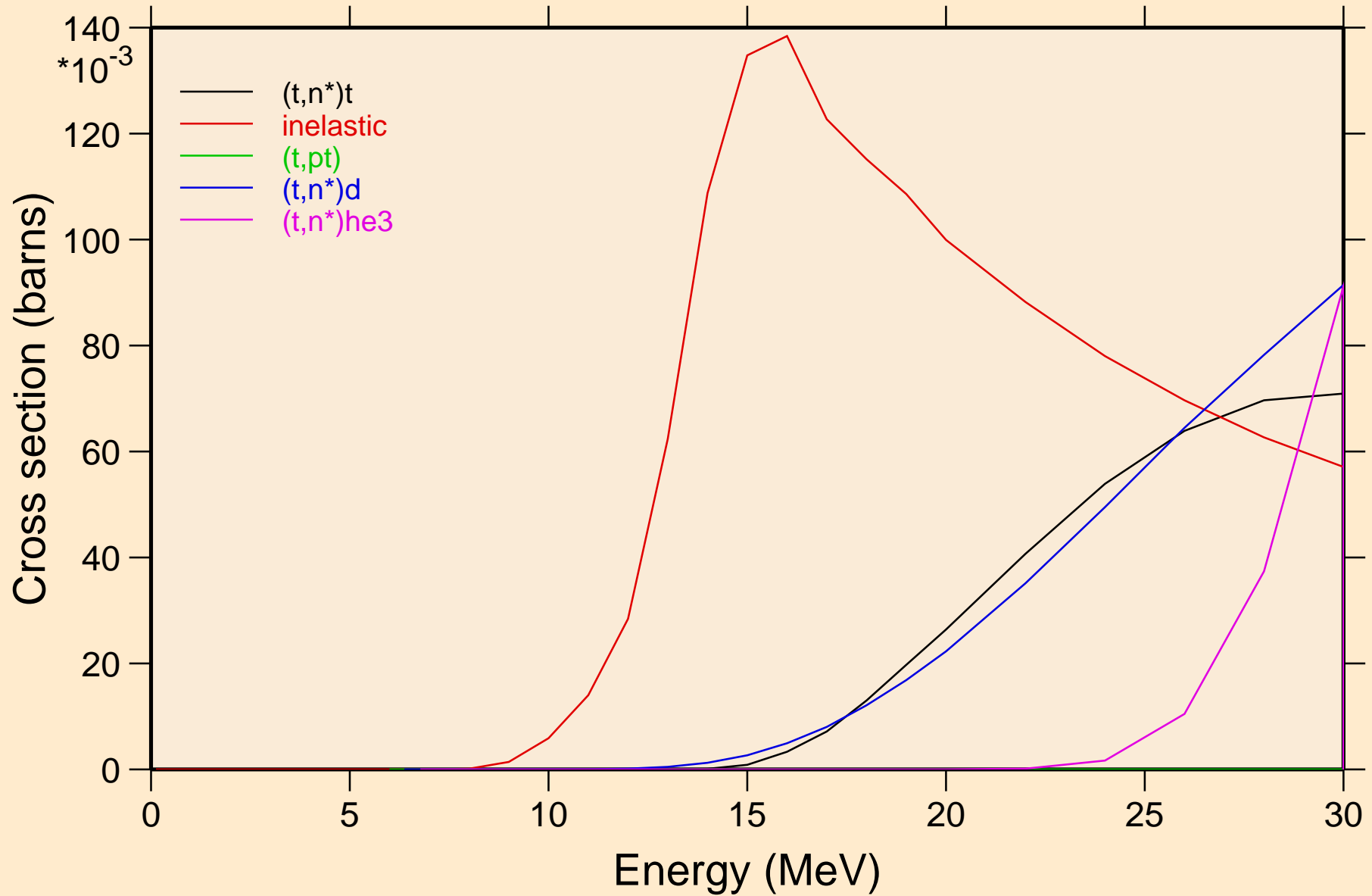

HO164 TRITON ACER TENDL-2021 LIBRARY; T=0.K  
Threshold reactions

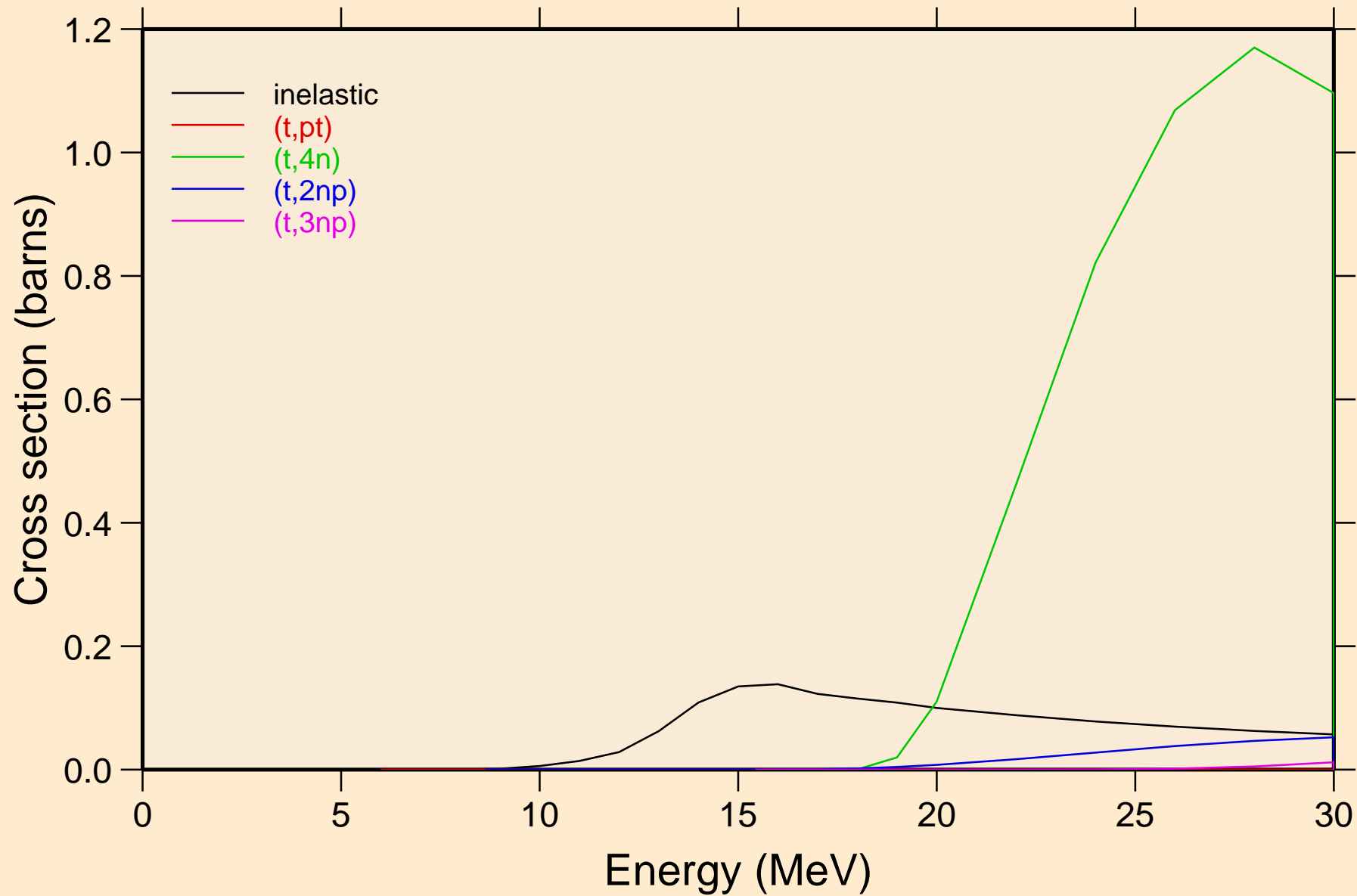

HO164 TRITON ACER TENDL-2021 LIBRARY; T=0.K  
Threshold reactions

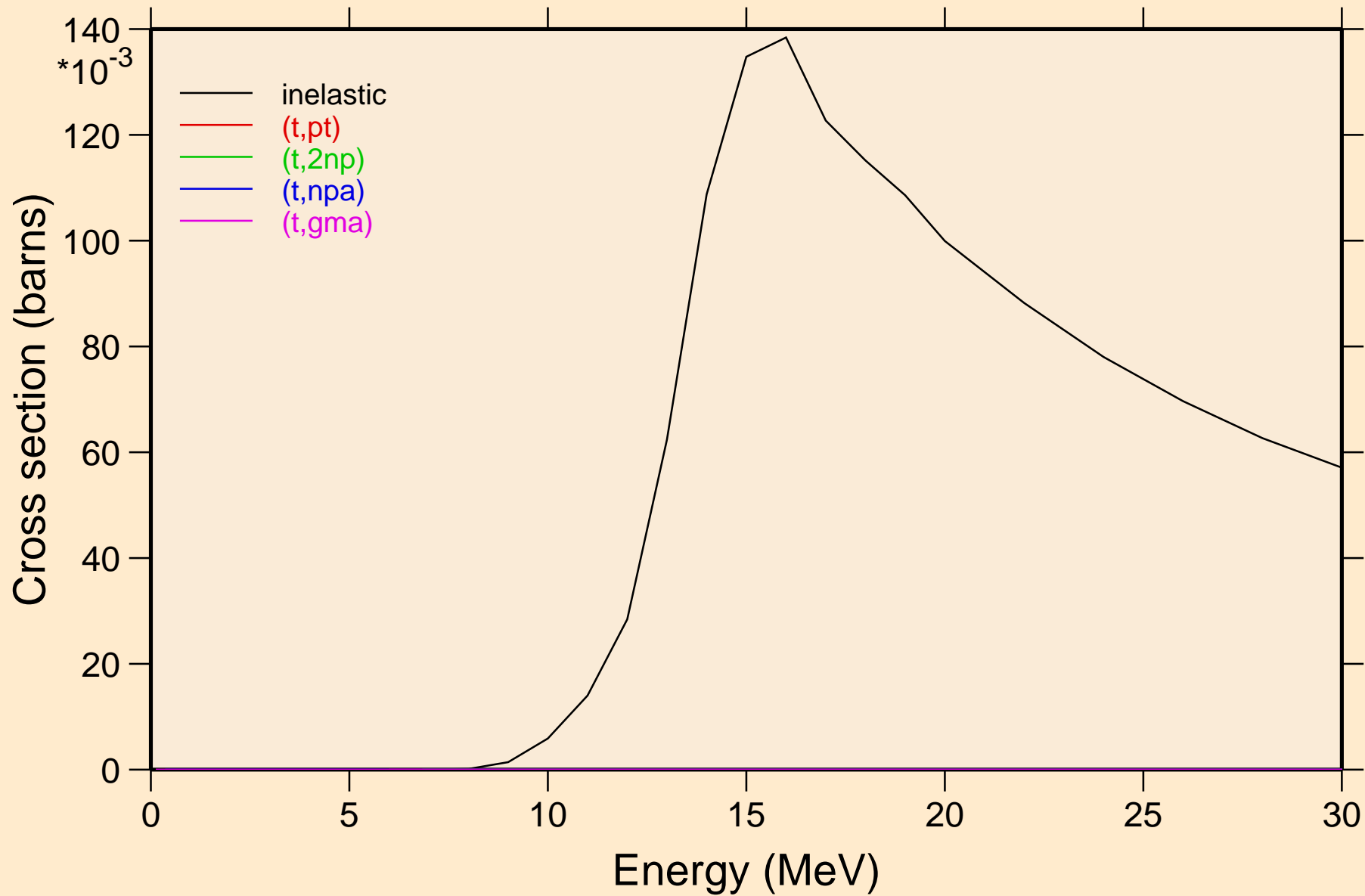

HO164 TRITON ACER TENDL-2021 LIBRARY; T=0.K  
Threshold reactions

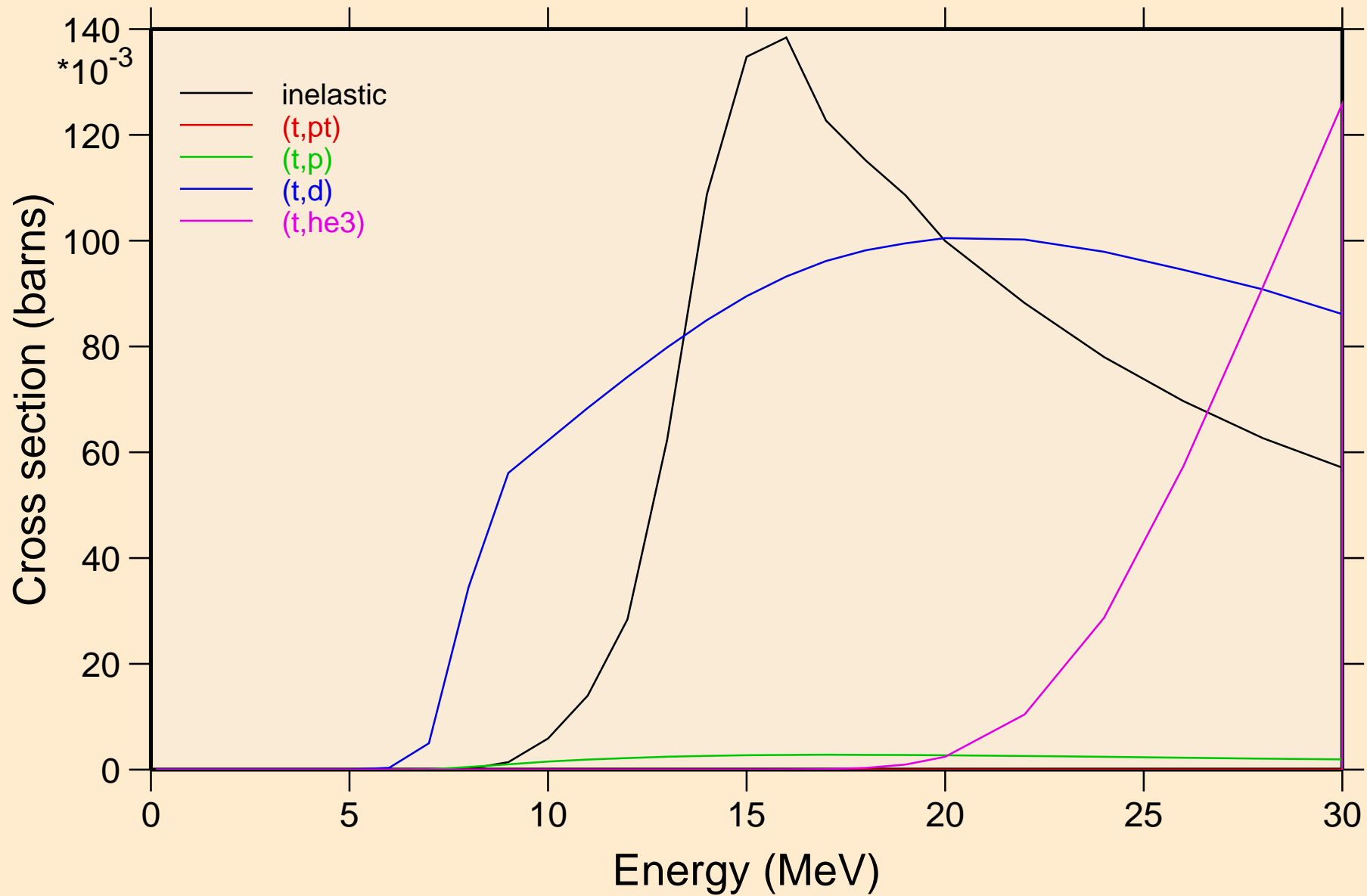

HO164 TRITON ACER TENDL-2021 LIBRARY; T=0.K  
Threshold reactions

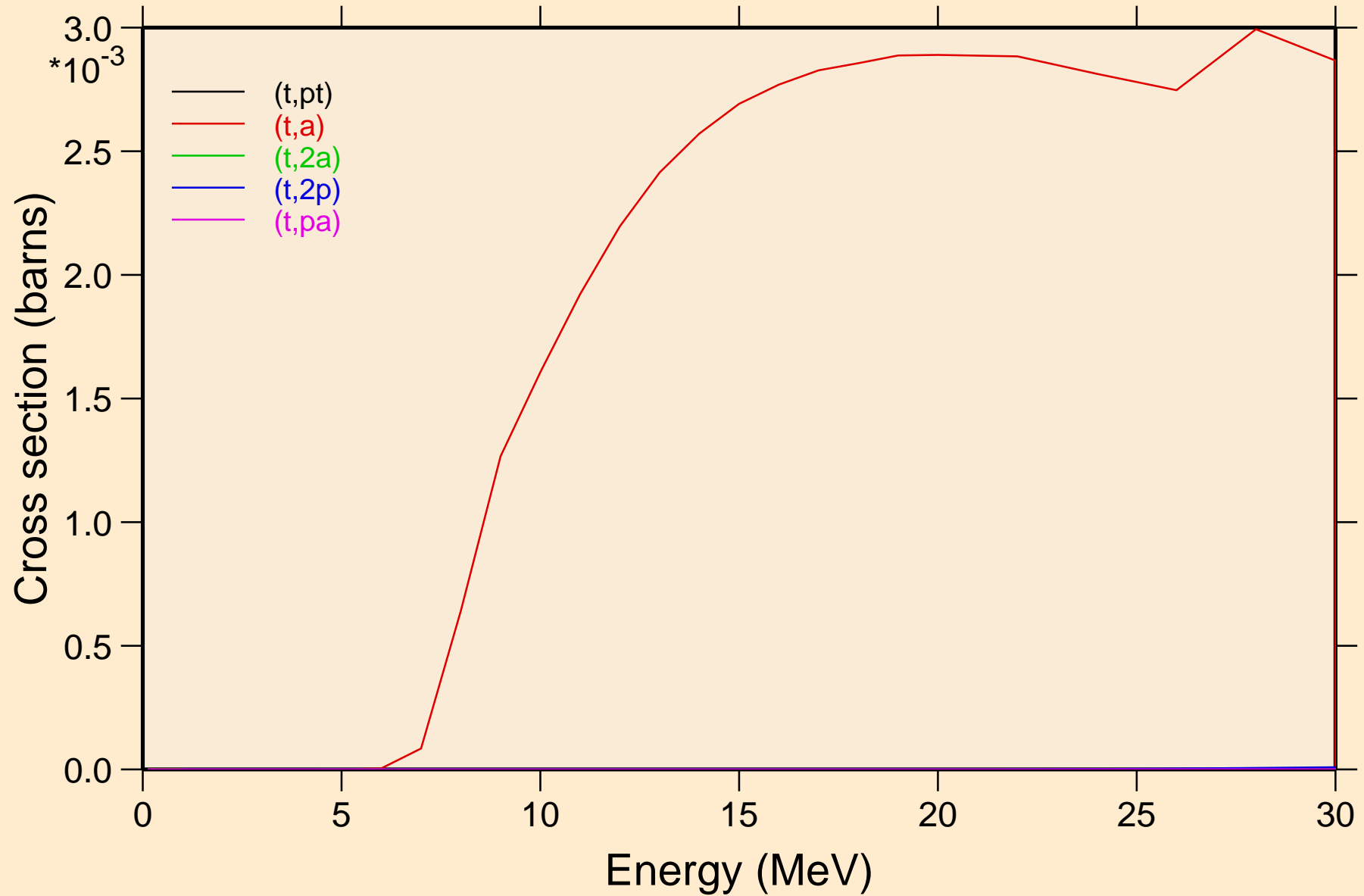

HO164 TRITON ACER TENDL-2021 LIBRARY; T=0.K  
Threshold reactions

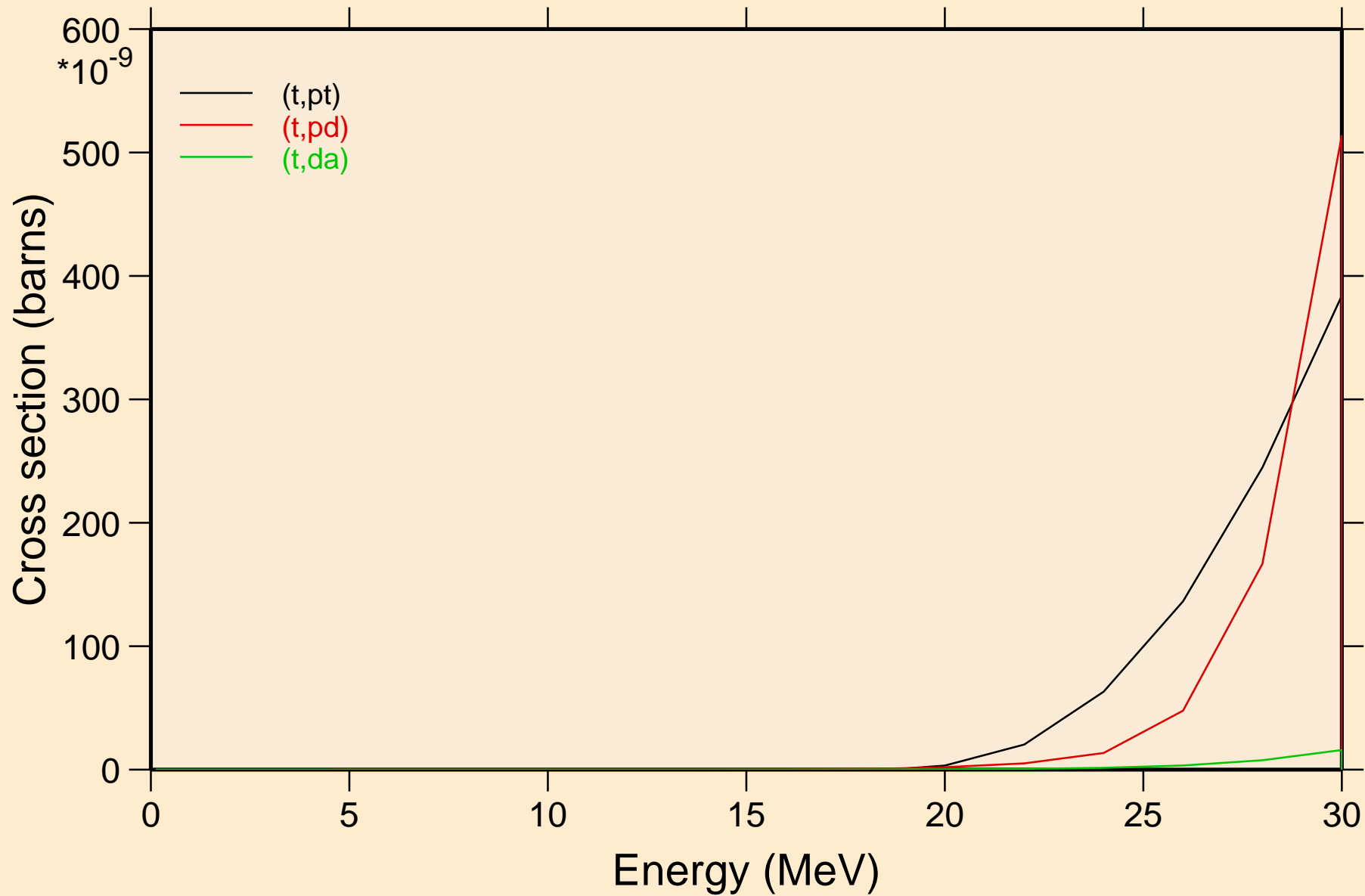

HO164 TRITON ACER TENDL-2021 LIBRARY; T=0.K  
angular distribution for elastic

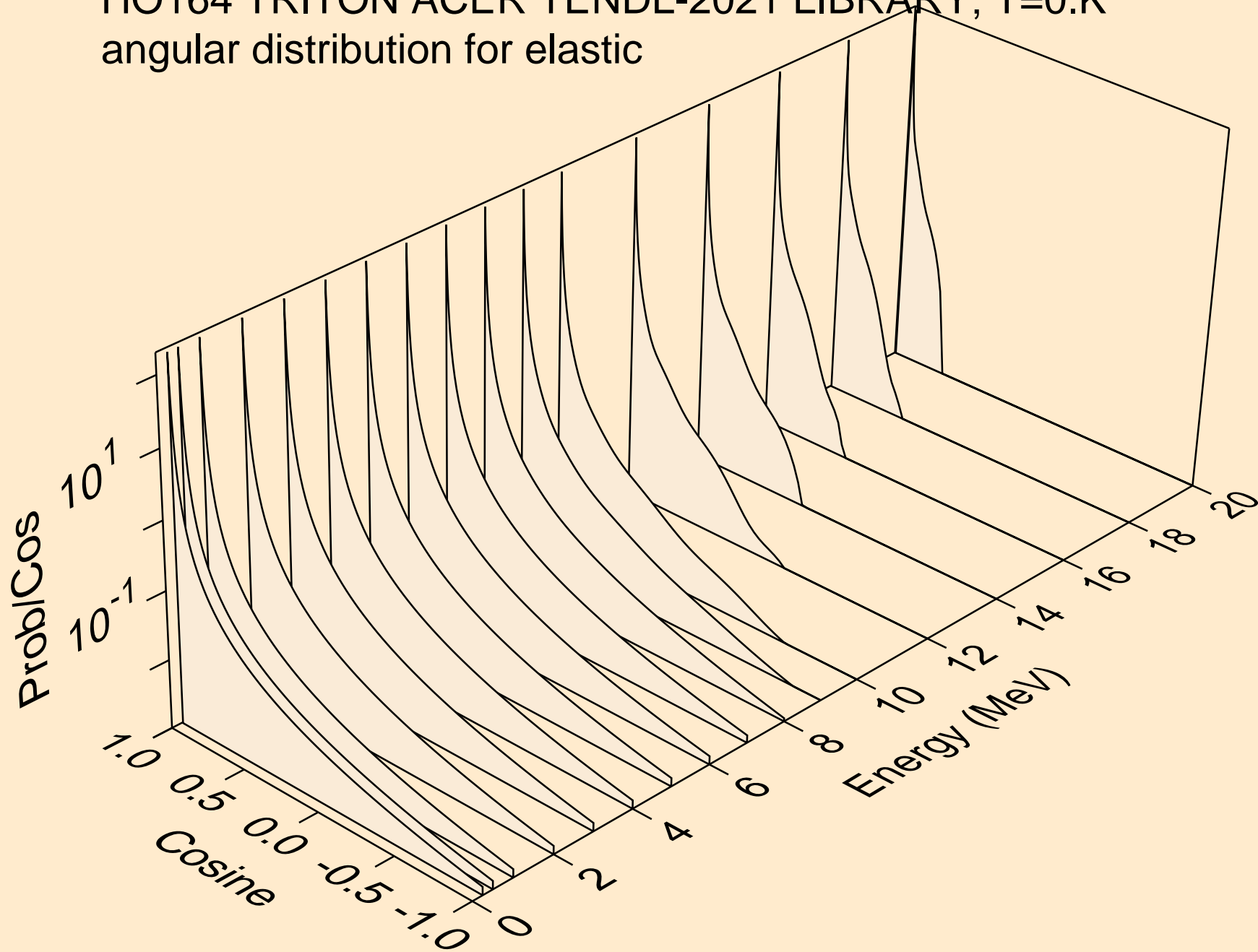



HO164 TRITON ACER TENDL-2021 LIBRARY; T=0.K  
angular distribution for elastic

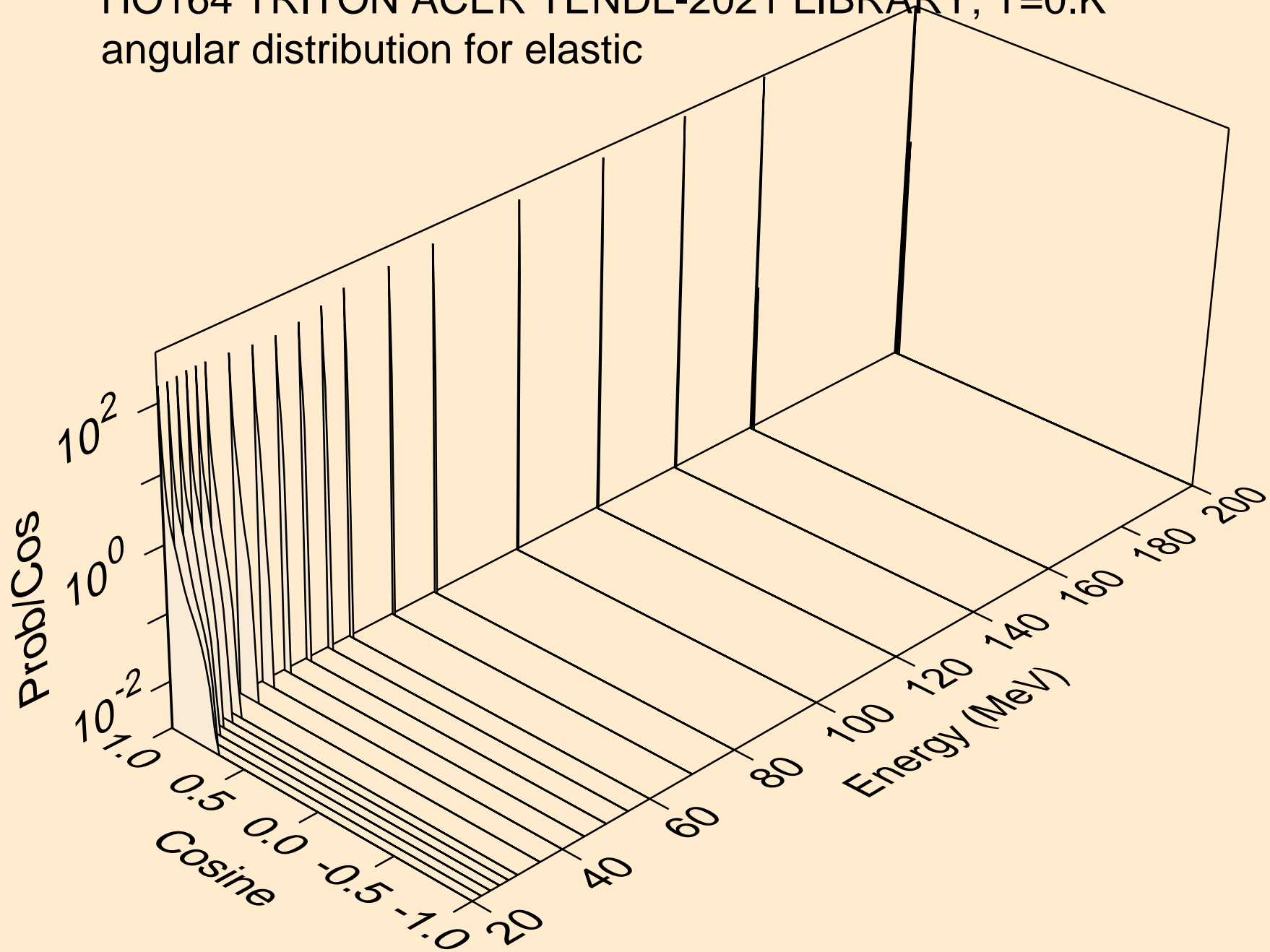

HO164 TRITON ACER TENDL-2021 LIBRARY; T=0.K  
Triton emission for (t,x)

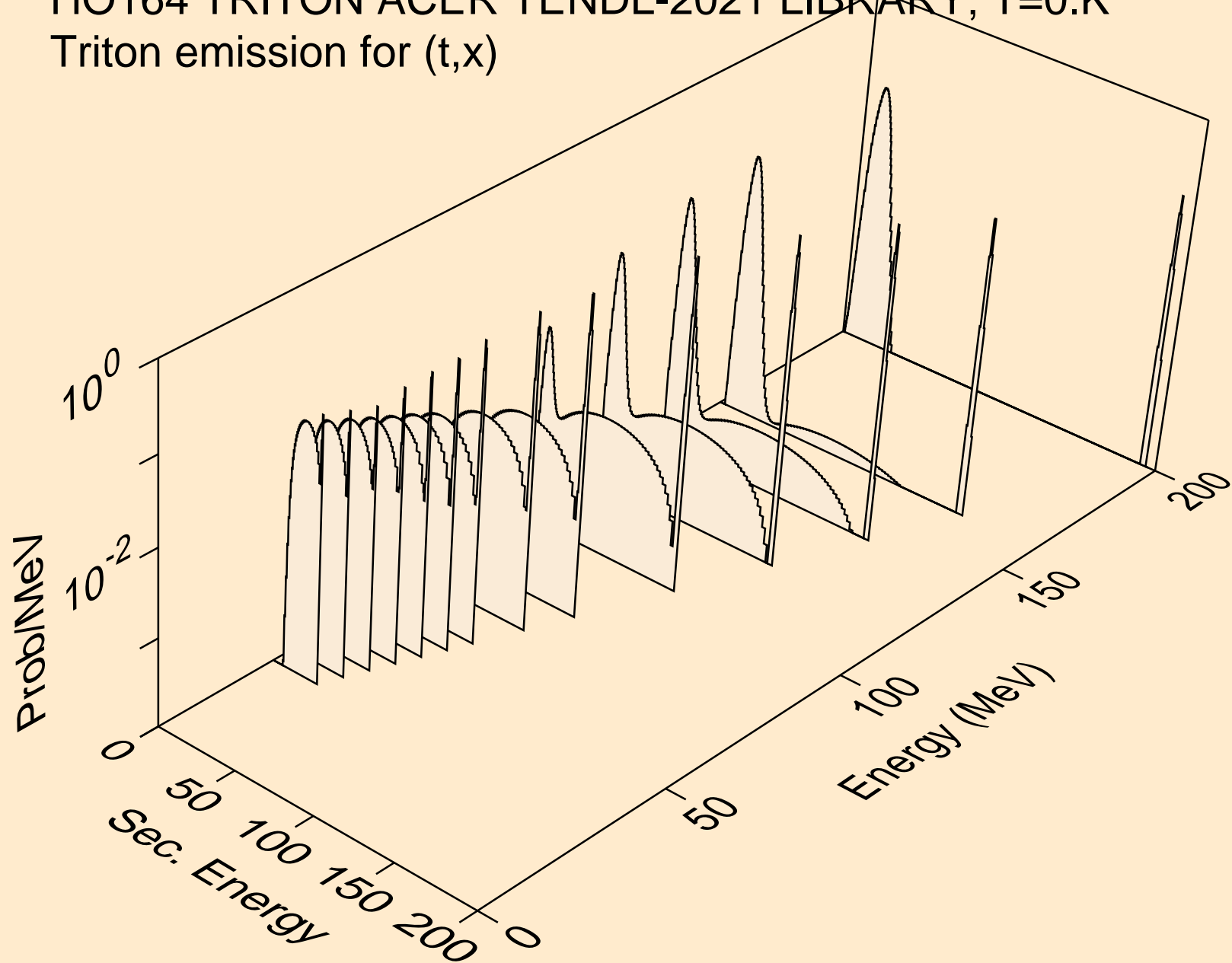

HO164 TRITON ACER TENDL-2021 LIBRARY; T=0.K  
Triton emission for (t,n\*)t

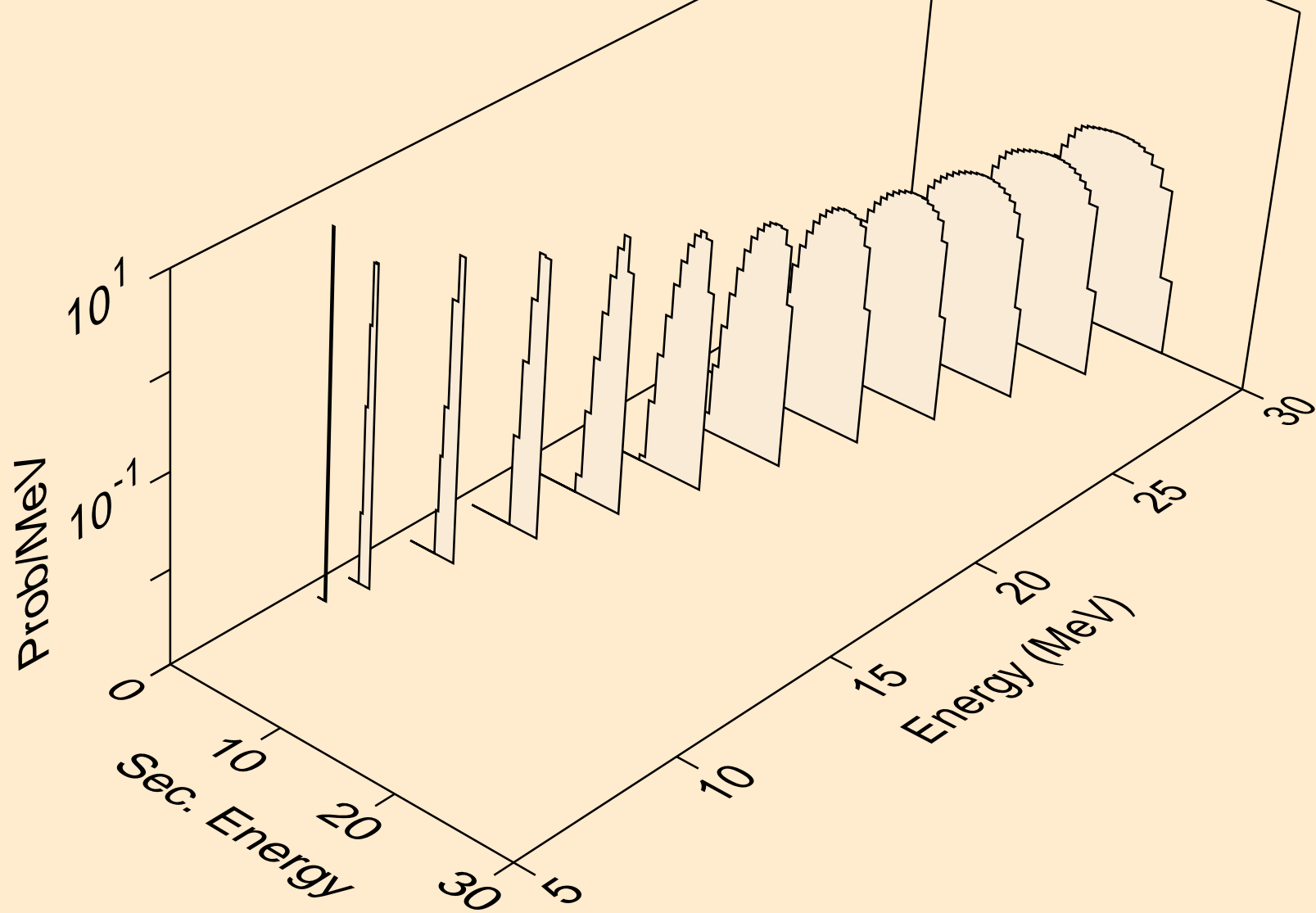

HO164 TRITON ACER TENDL-2021 LIBRARY; T=0.K  
Triton emission for inelastic

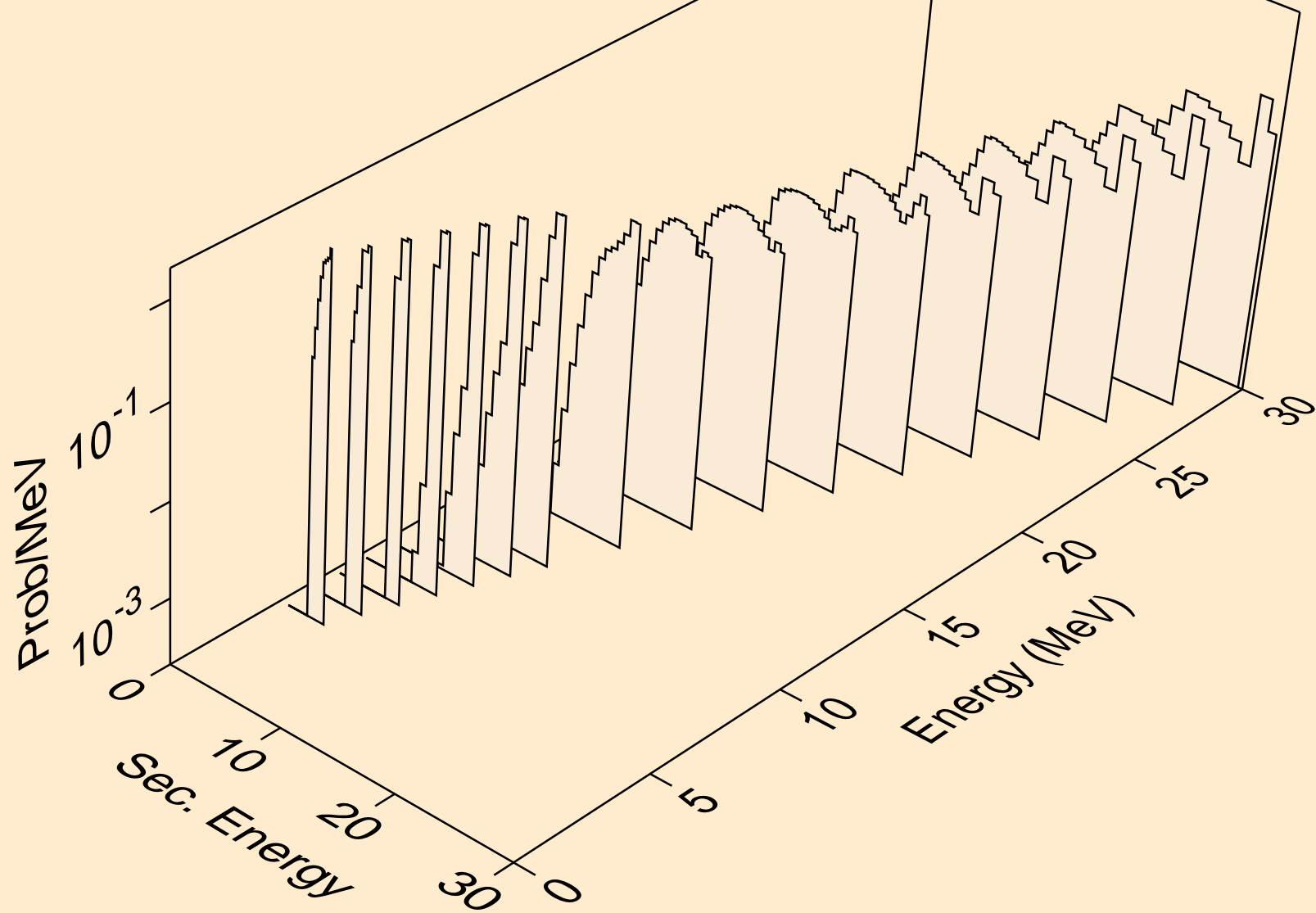

HO164 TRITON ACER TENDL-2021 LIBRARY; T=0.K  
Triton emission for (t,pt)

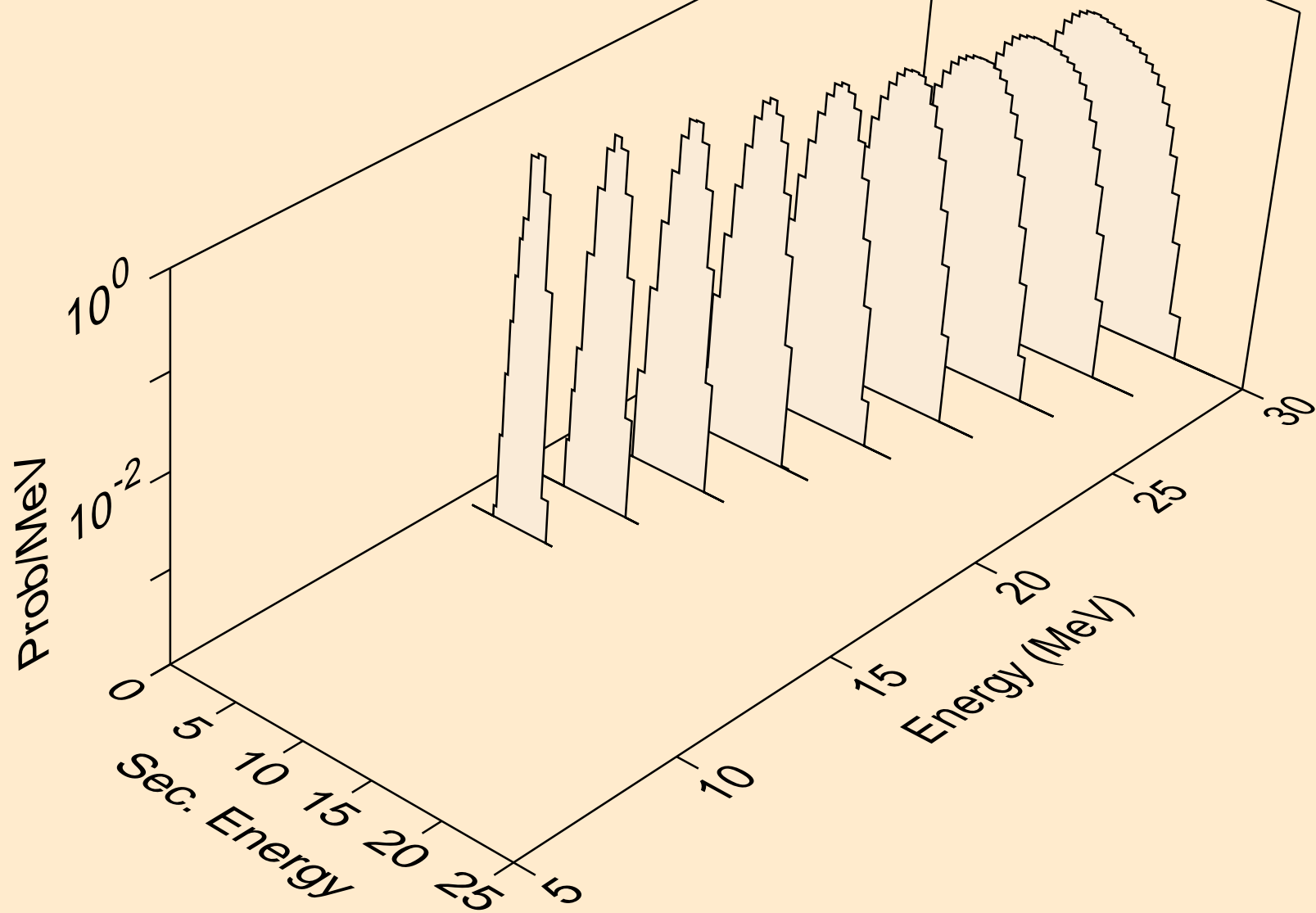

HO164 TRITON ACER TENDL-2021 LIBRARY; T=0.K  
Photon emission for (z,n)

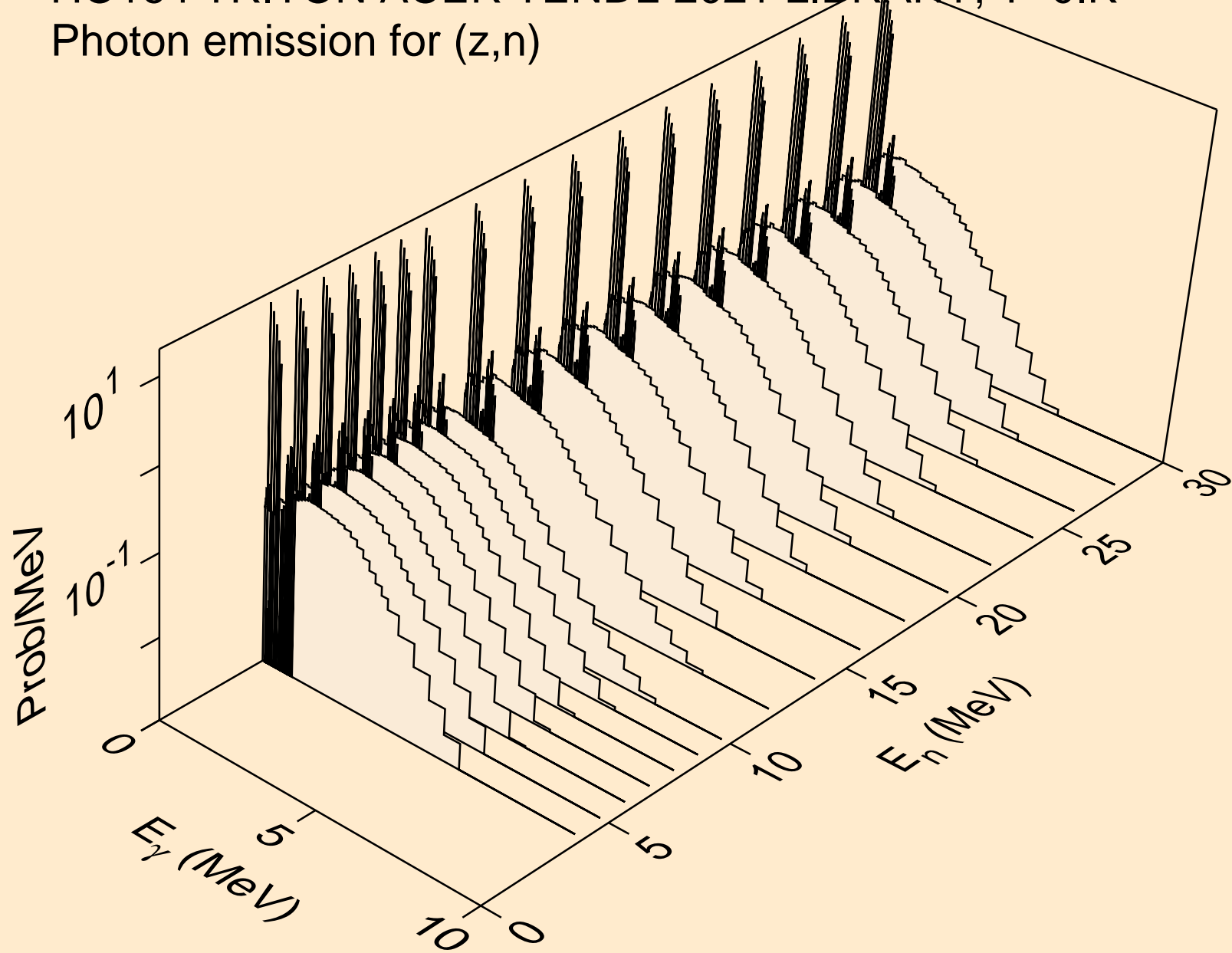

HO164 TRITON ACER TENDL-2021 LIBRARY; T=0.K  
Photon emission for (n,x)

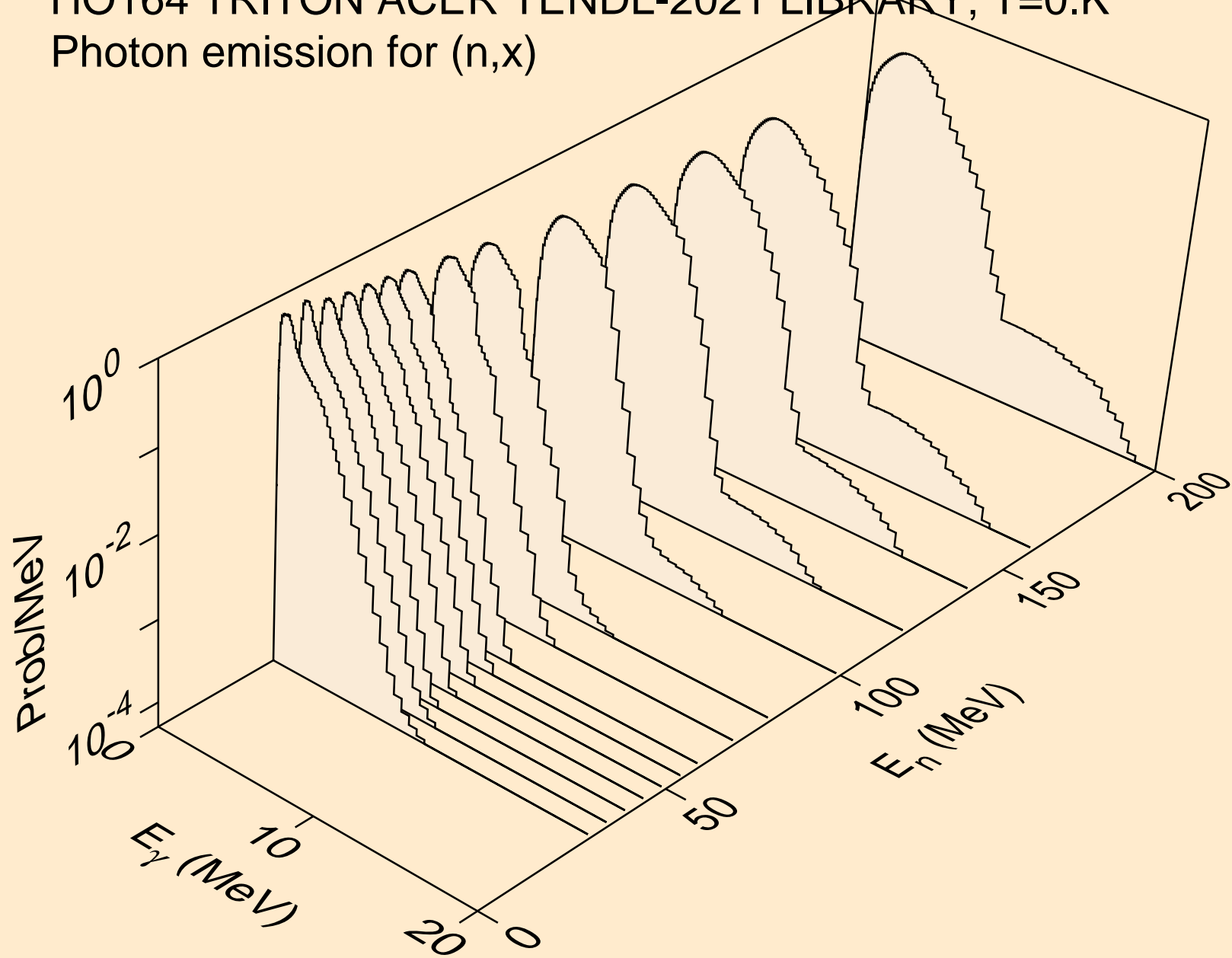

HO164 TRITON ACER TENDL-2021 LIBRARY; T=0.K  
Photon emission for (n,2nd)

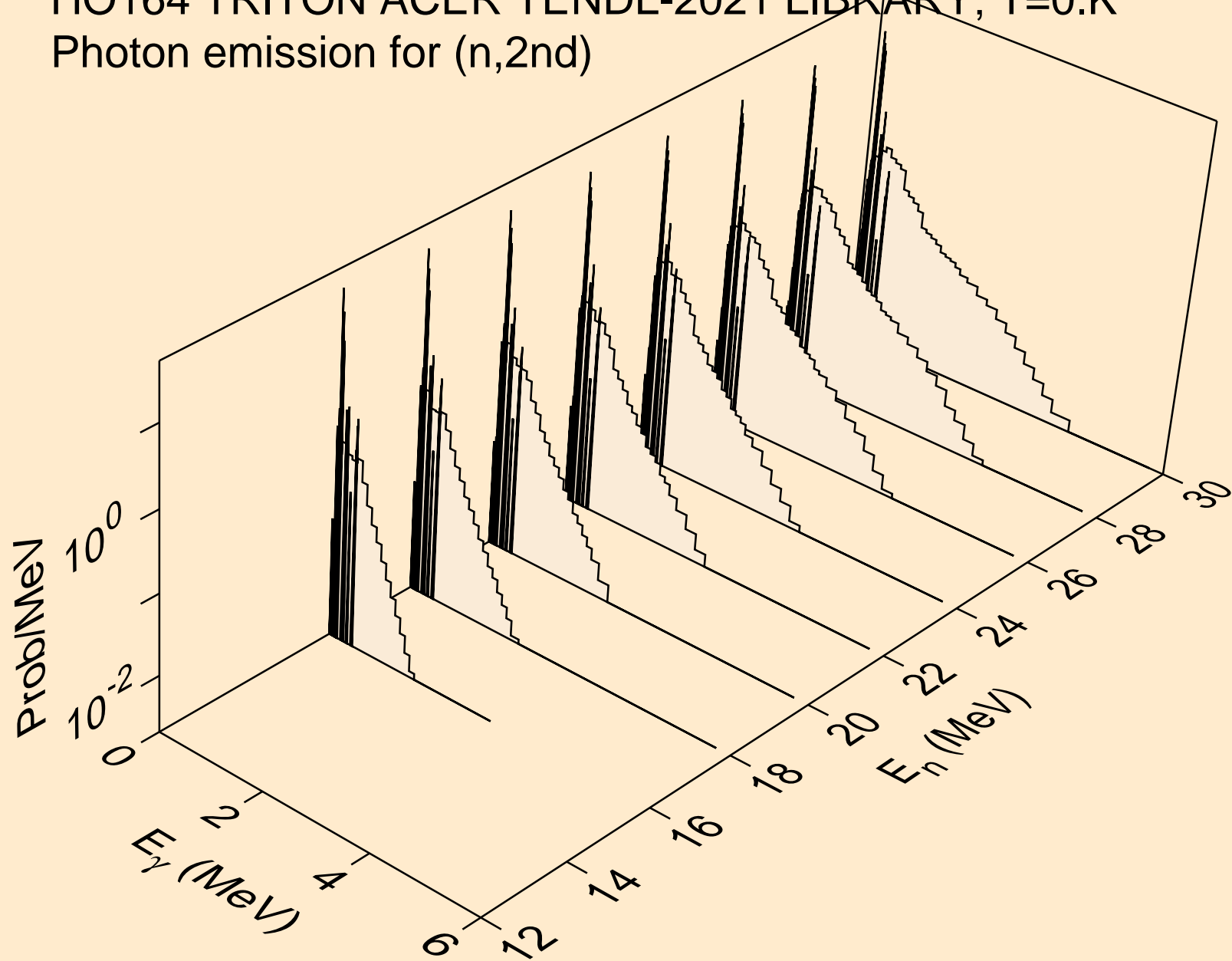



HO164 TRITON ACER TENDL-2021 LIBRARY; T=0.K  
Photon emission for (n,2n)

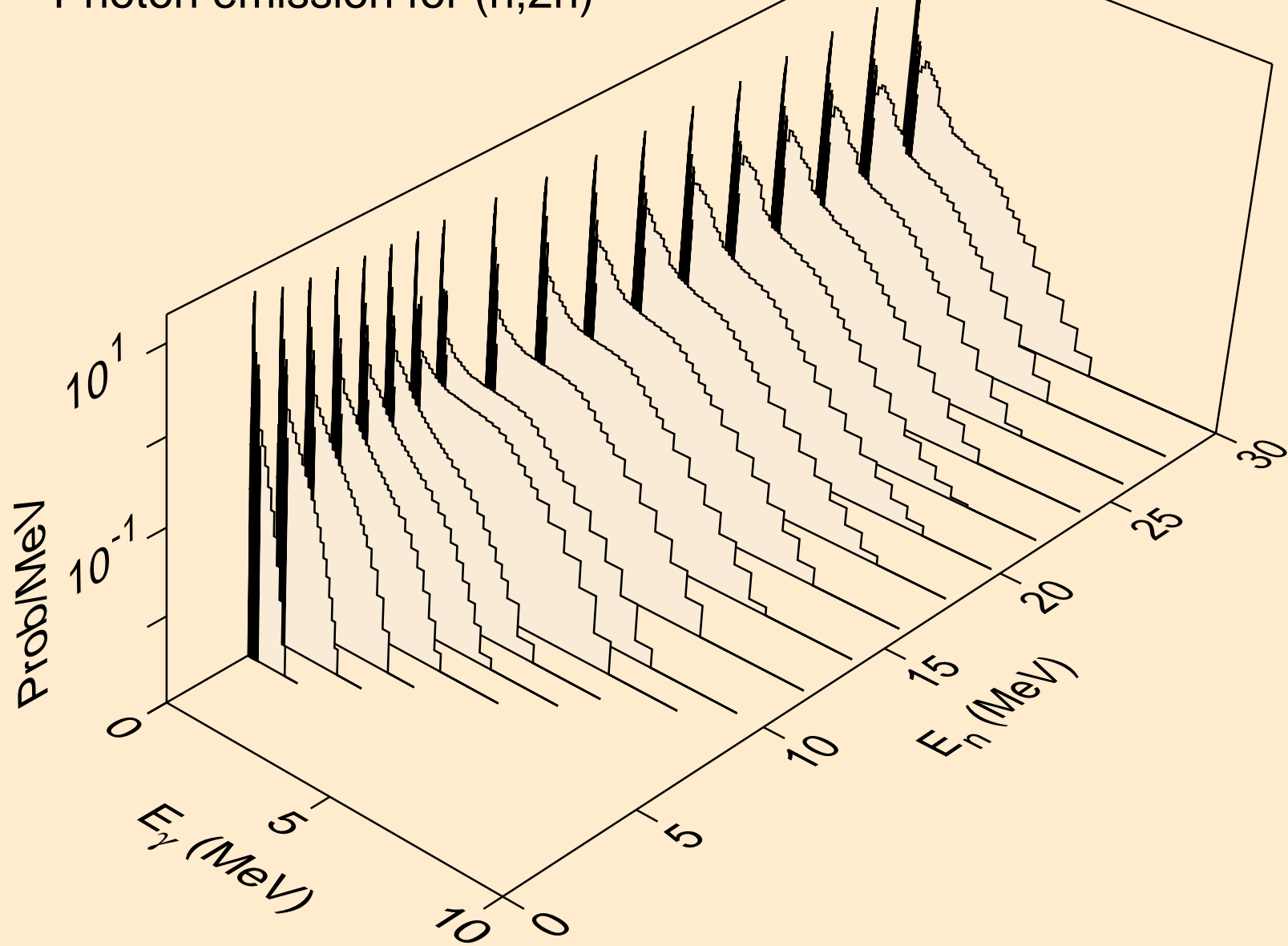

HO164 TRITON ACER TENDL-2021 LIBRARY; T=0.K  
Photon emission for (n,3n)

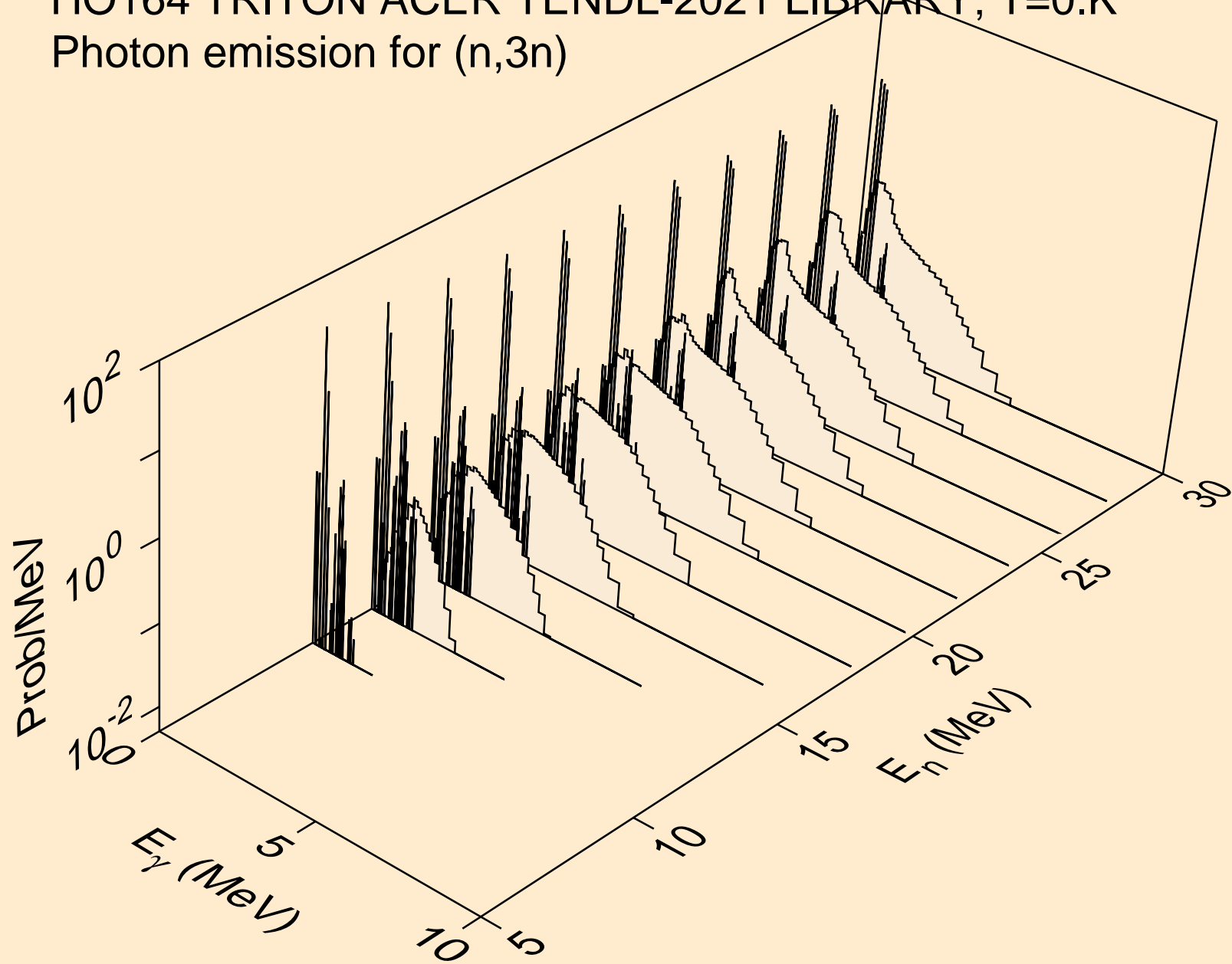

HO164 TRITON ACER TENDL-2021 LIBRARY; T=0.K  
Photon emission for (n,n\*)a

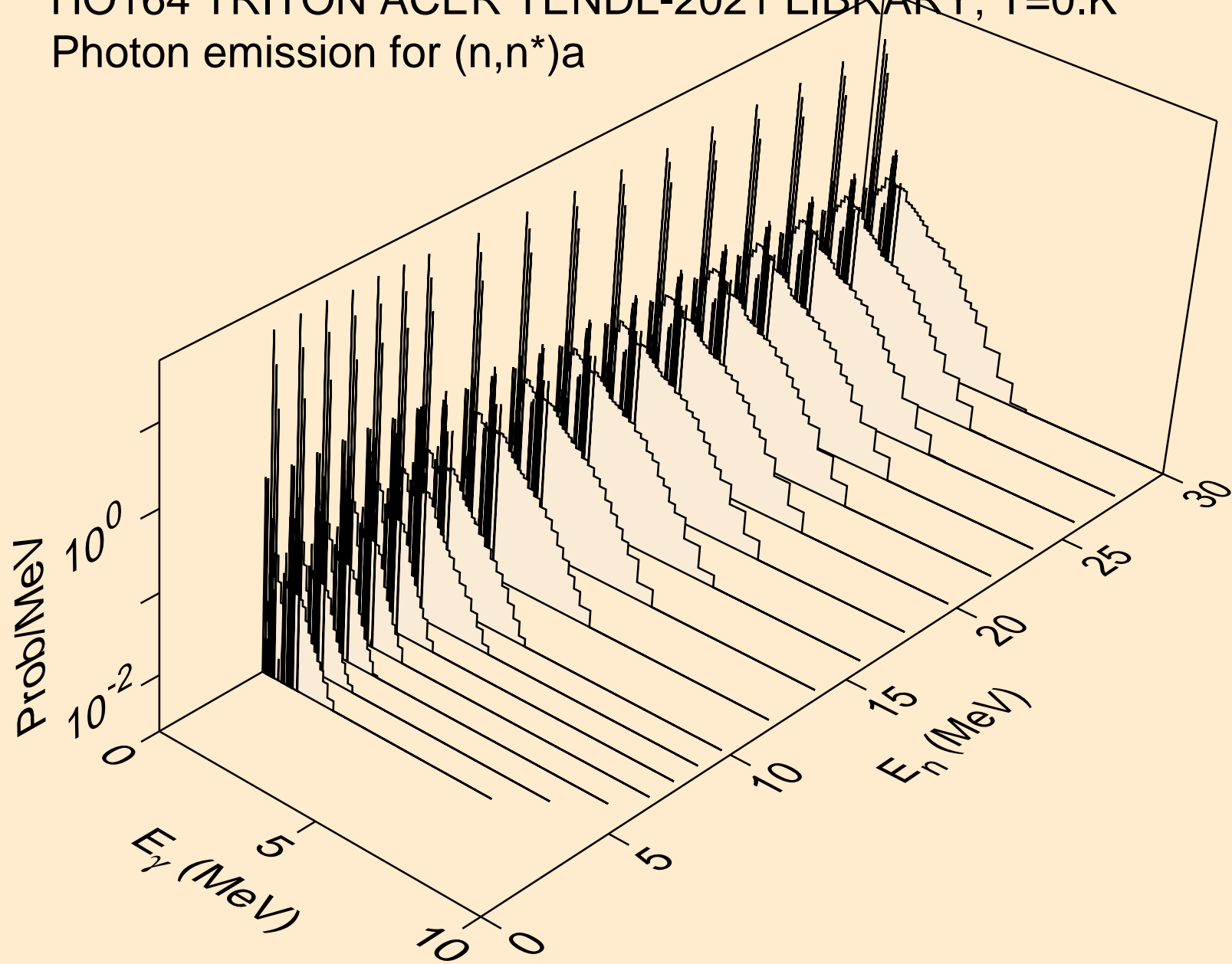

HO164 TRITON ACER TENDL-2021 LIBRARY; T=0.K  
Photon emission for (n,2n)a

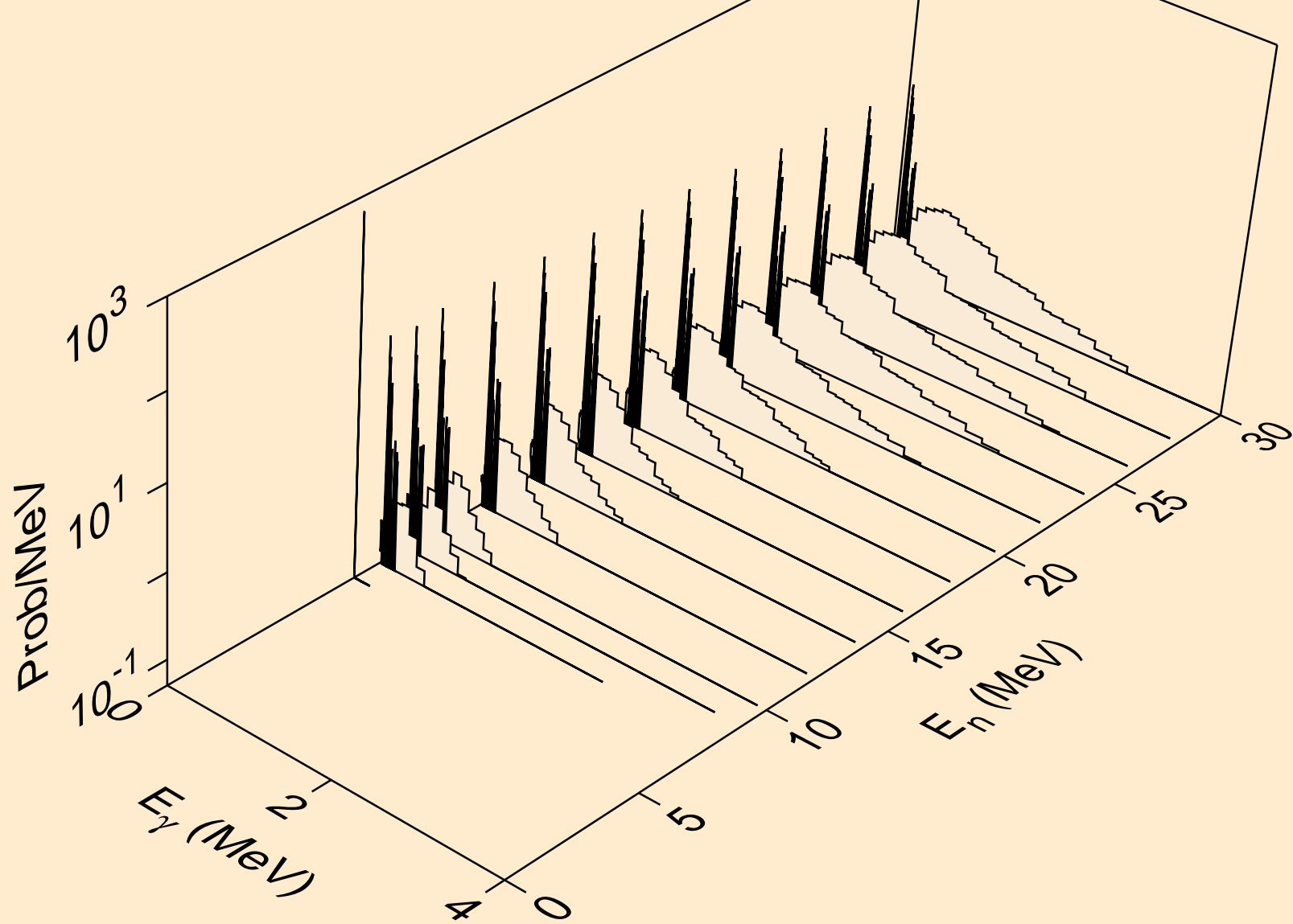

HO164 TRITON ACER TENDL-2021 LIBRARY; T=0.K  
Photon emission for (n,3n)a

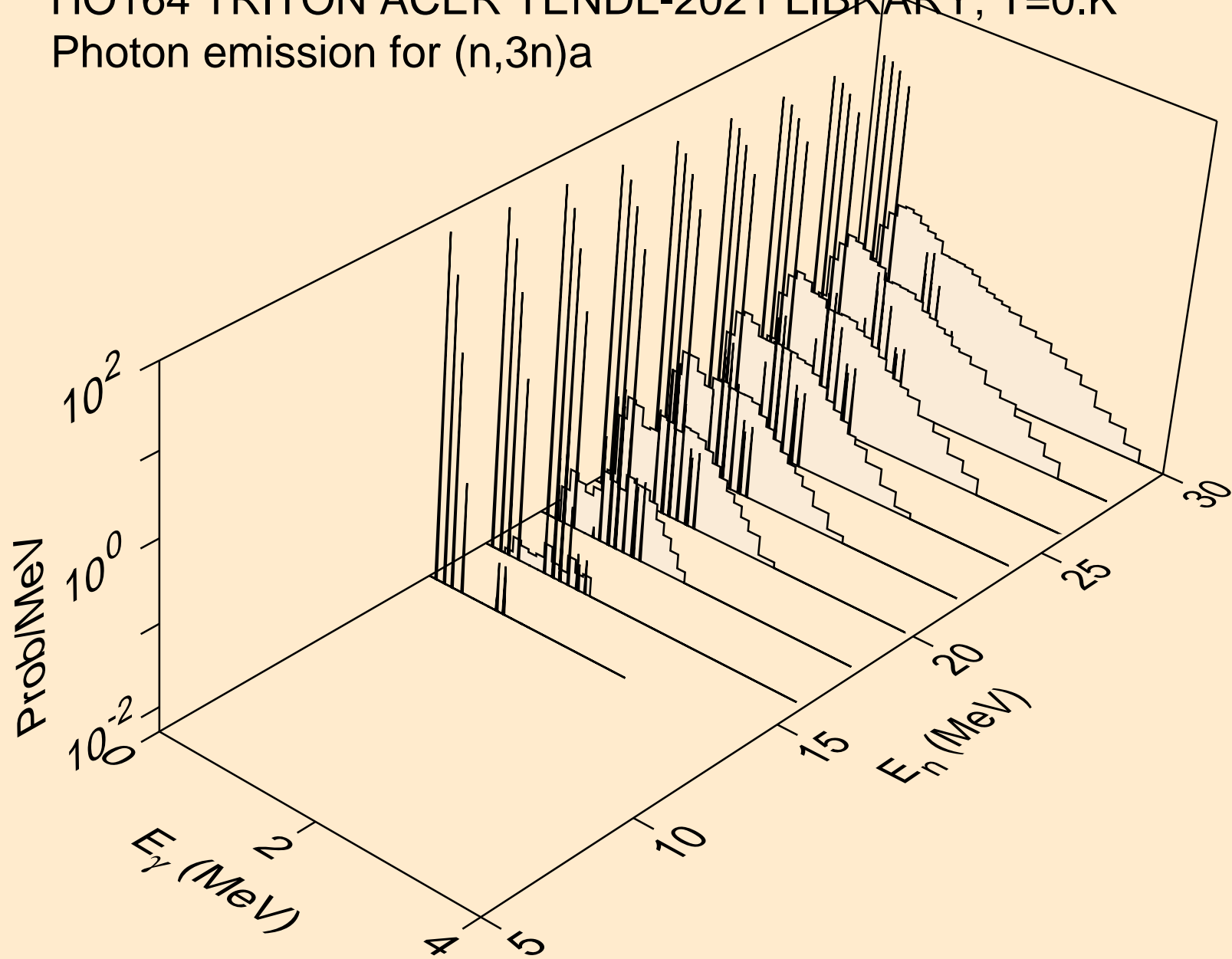

HO164 TRITON ACER TENDL-2021 LIBRARY; T=0.K  
Photon emission for (n,n\*)p

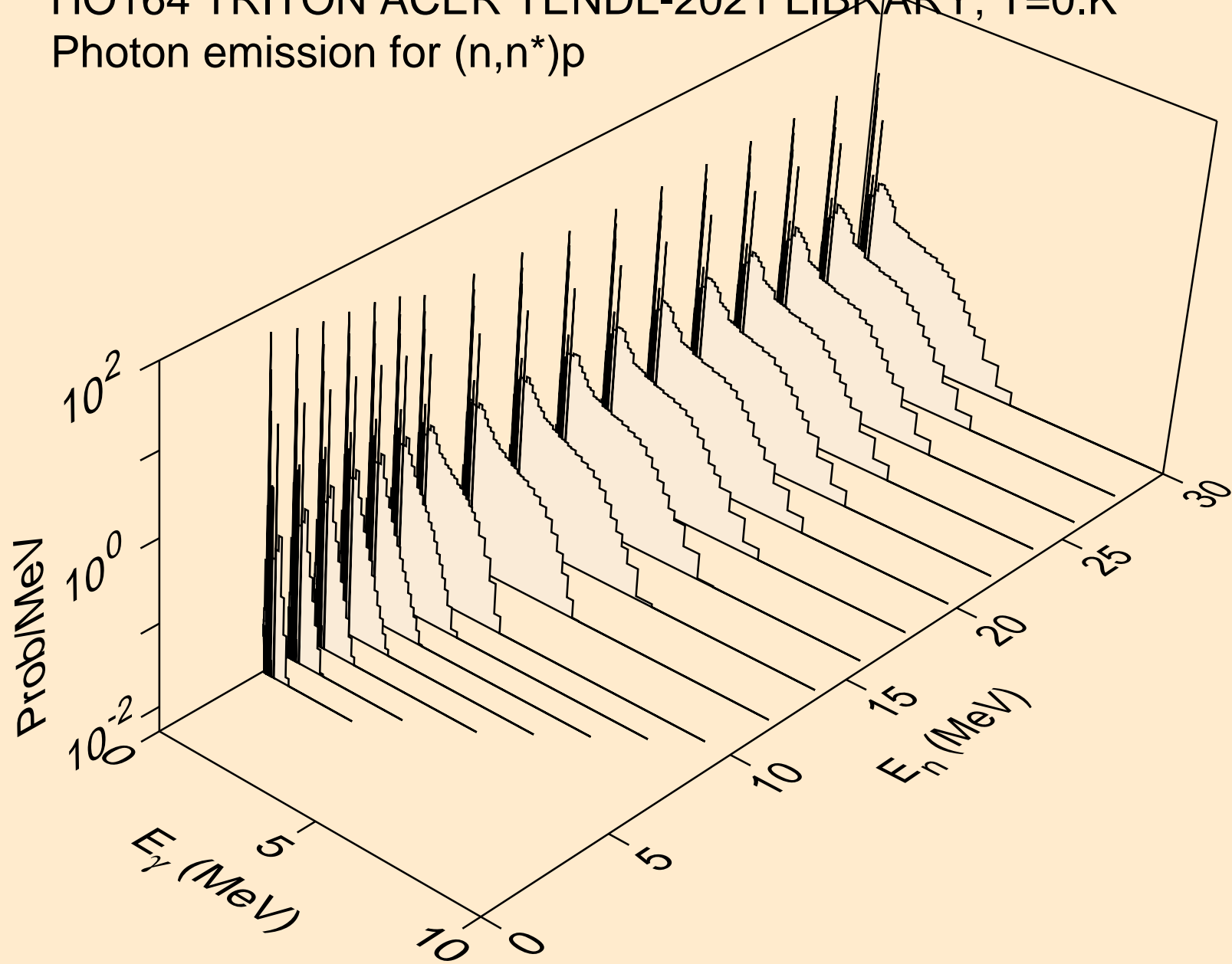

HO164 TRITON ACER TENDL-2021 LIBRARY; T=0.K  
Photon emission for (n,n\*)2a

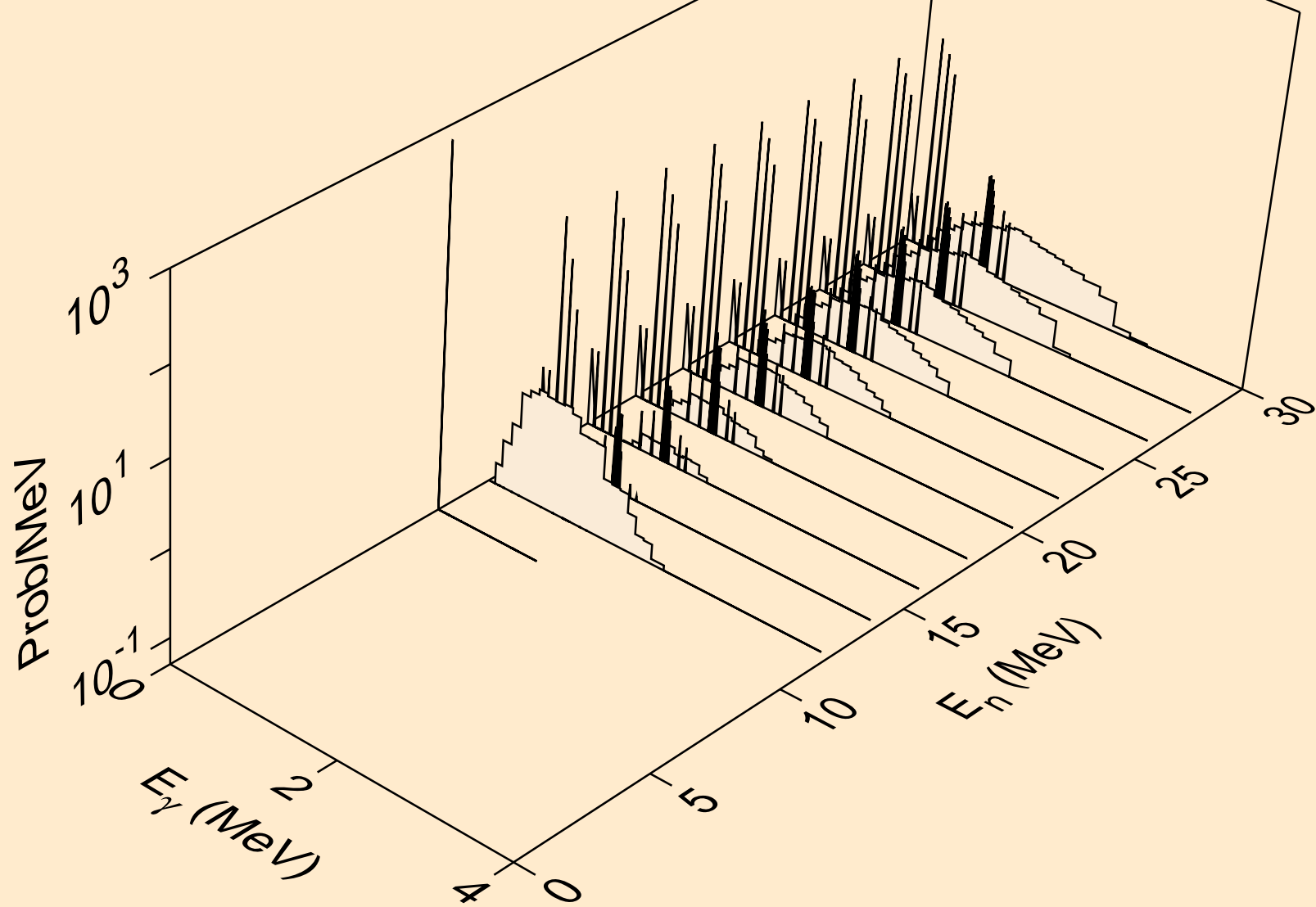

HO164 TRITON ACER TENDL-2021 LIBRARY; T=0.K  
Photon emission for (n,2n)2a

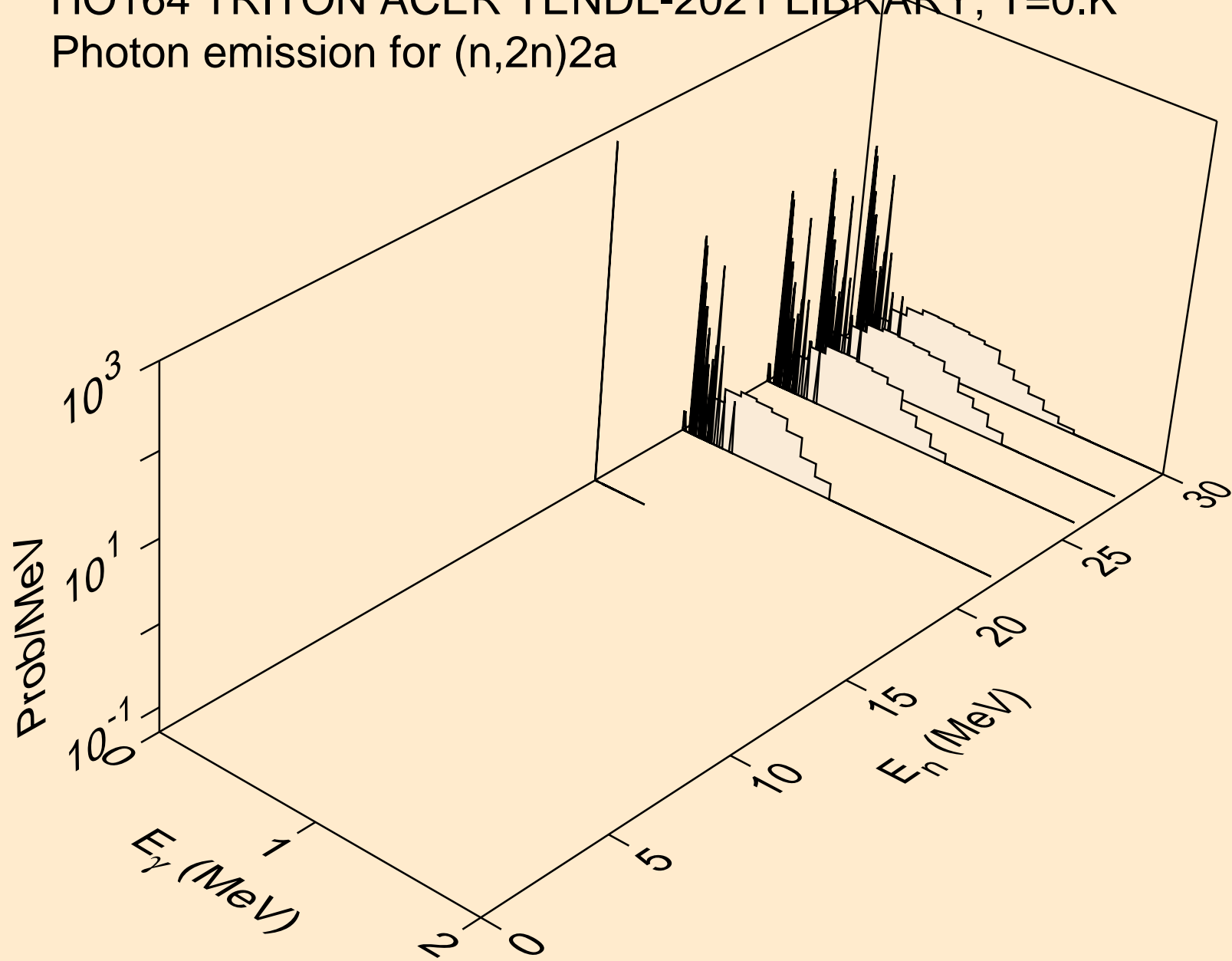



HO164 TRITON ACER TENDL-2021 LIBRARY; T=0.K  
Photon emission for (n,n\*)d

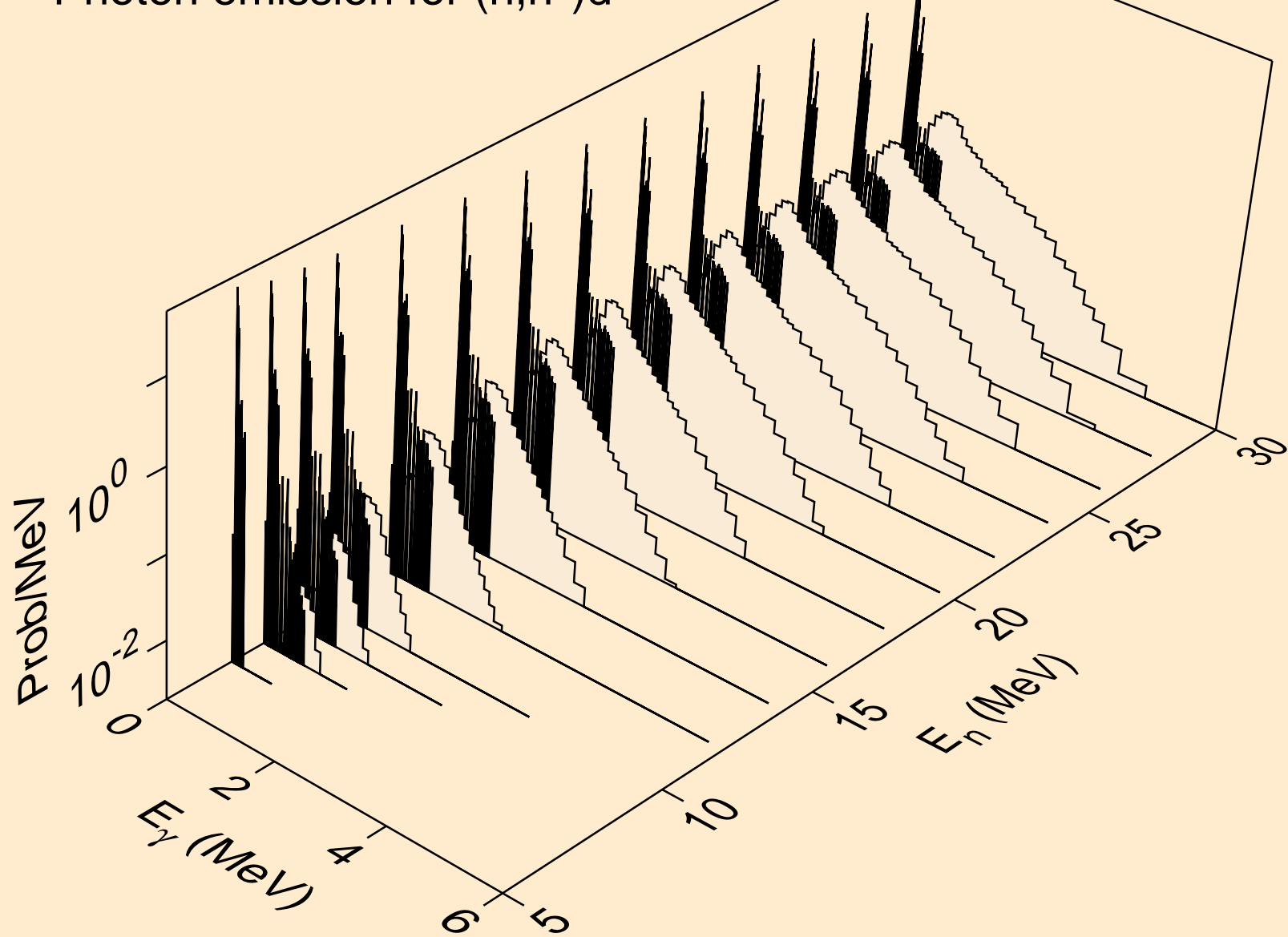

HO164 TRITON ACER TENDL-2021 LIBRARY; T=0.K  
Photon emission for (n,n\*)t

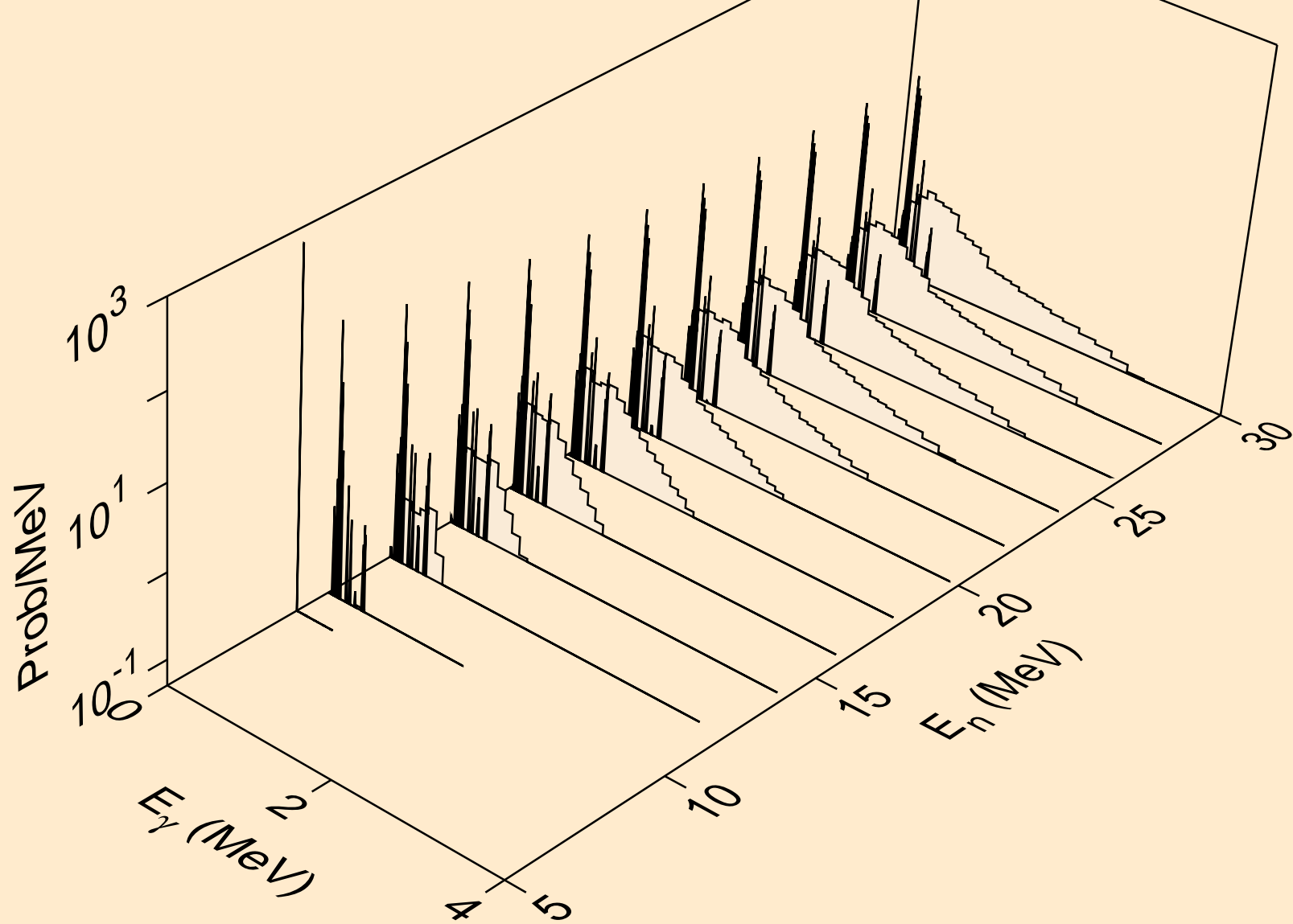

HO164 TRITON ACER TENDL-2021 LIBRARY; T=0.K  
Photon emission for (n,n\*)he3

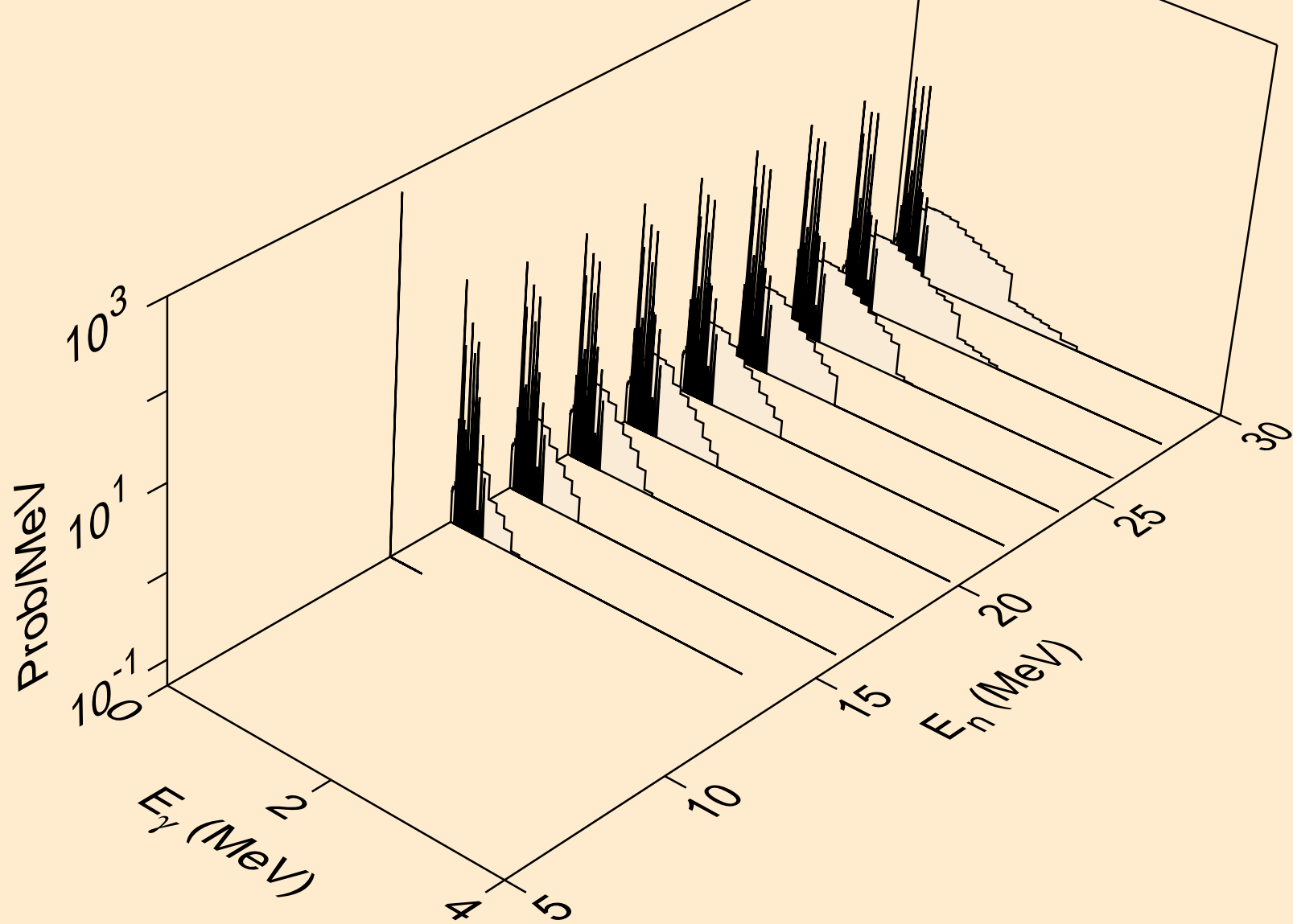

HO164 TRITON ACER TENDL-2021 LIBRARY; T=0.K  
Photon emission for (n,4n)

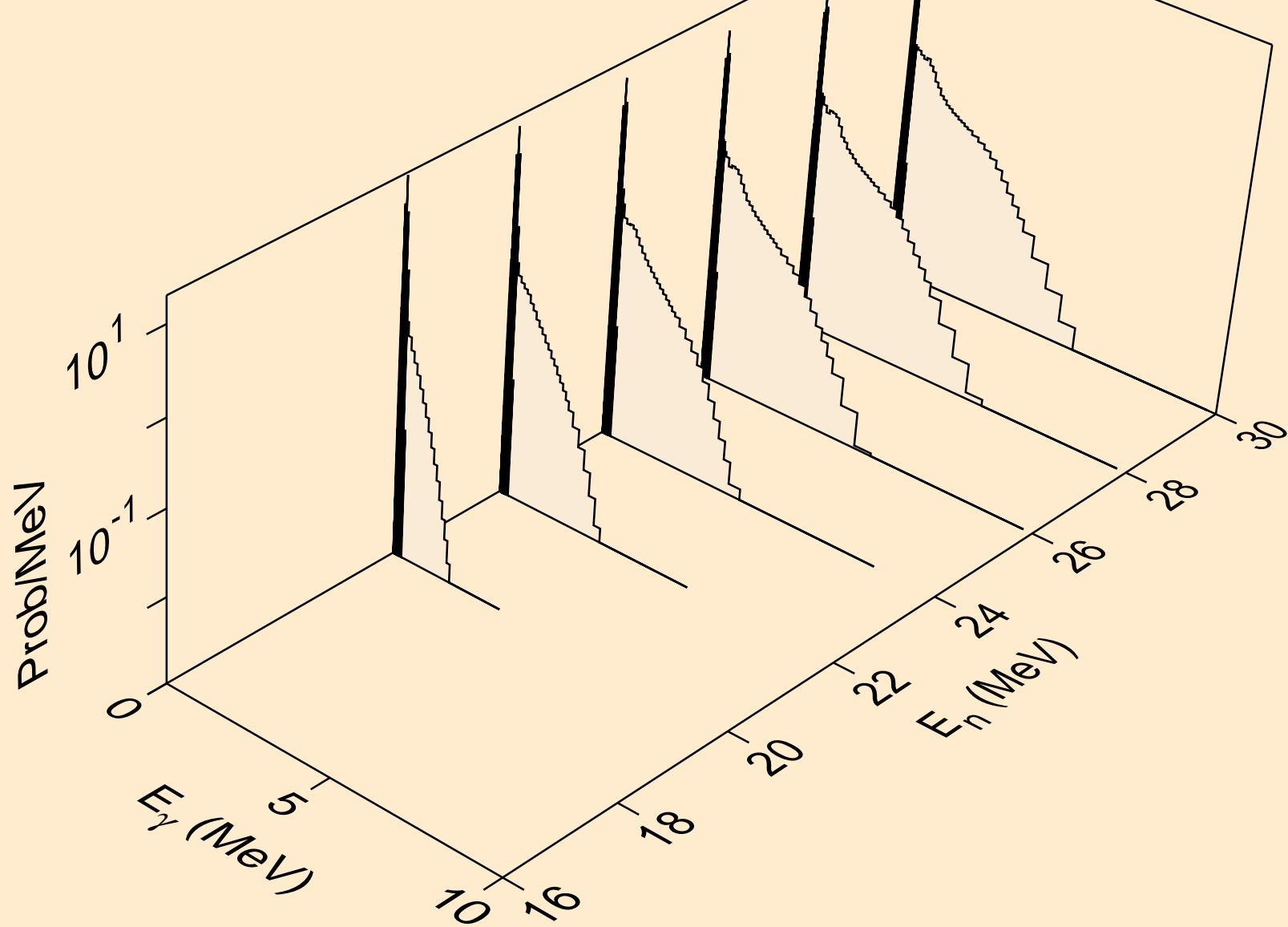

HO164 TRITON ACER TENDL-2021 LIBRARY; T=0.K  
Photon emission for (n,2np)

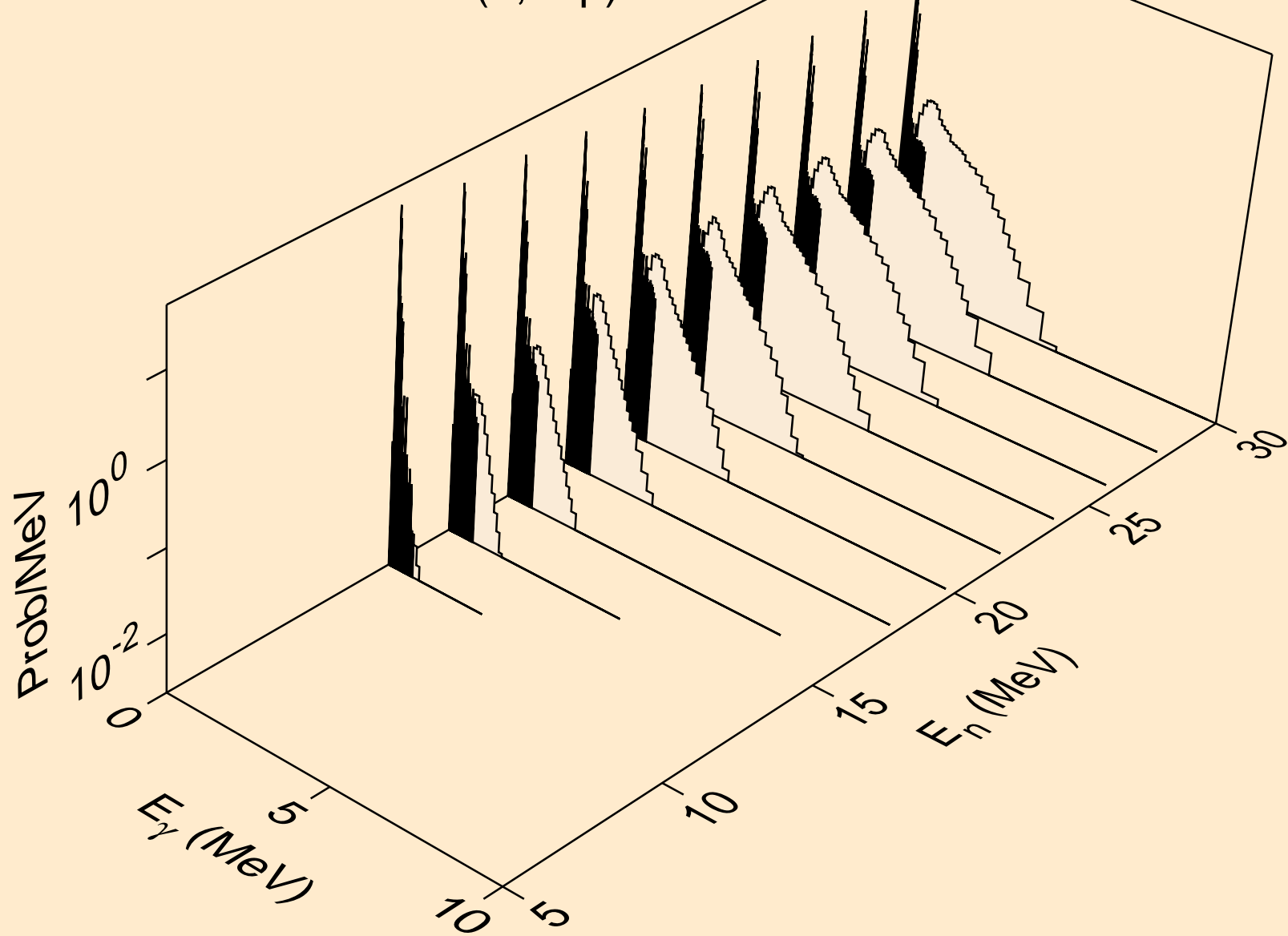

HO164 TRITON ACER TENDL-2021 LIBRARY; T=0.K  
Photon emission for (n,3np)

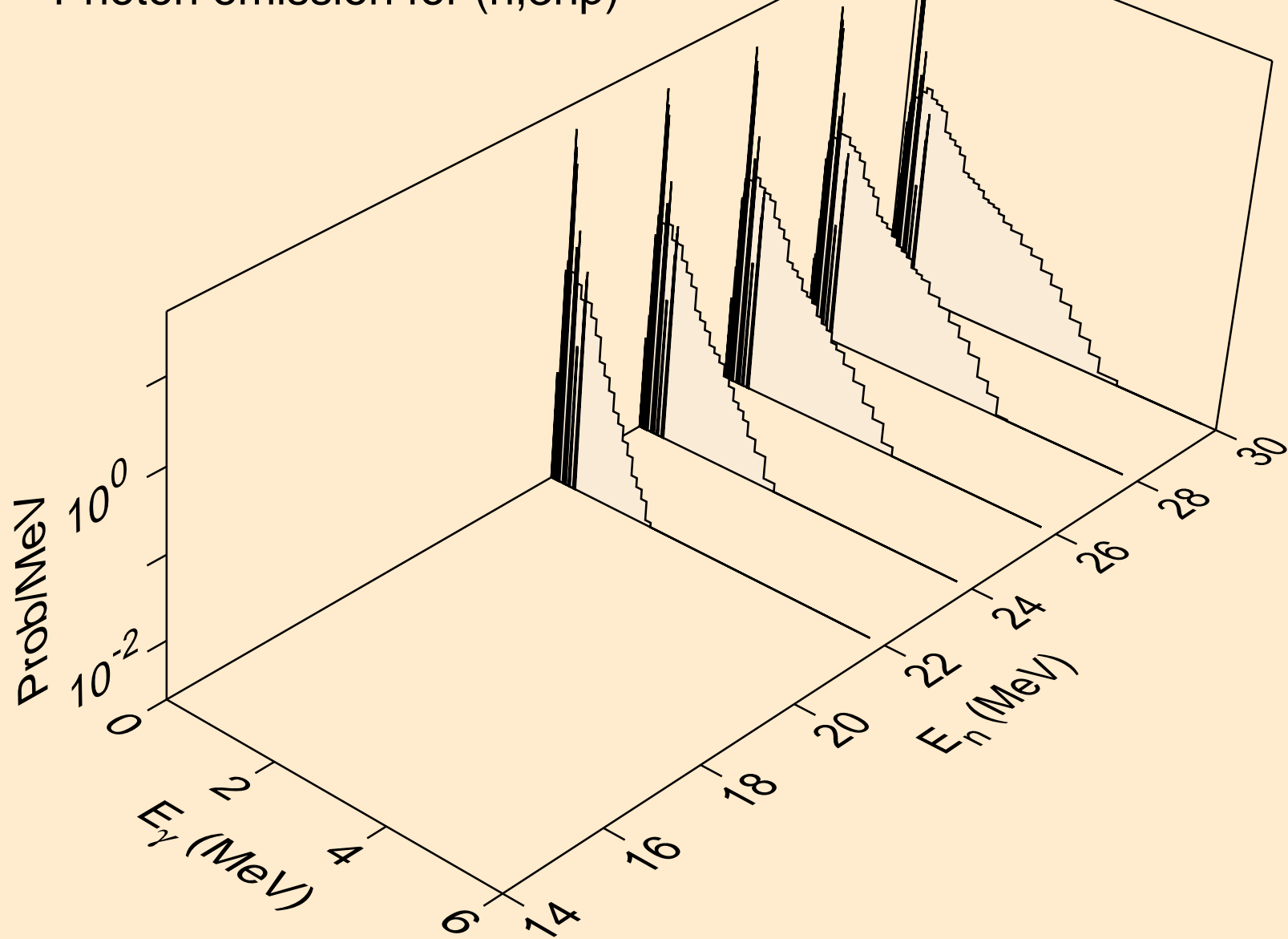

HO164 TRITON ACER TENDL-2021 LIBRARY; T=0.K  
Photon emission for (n,2np)

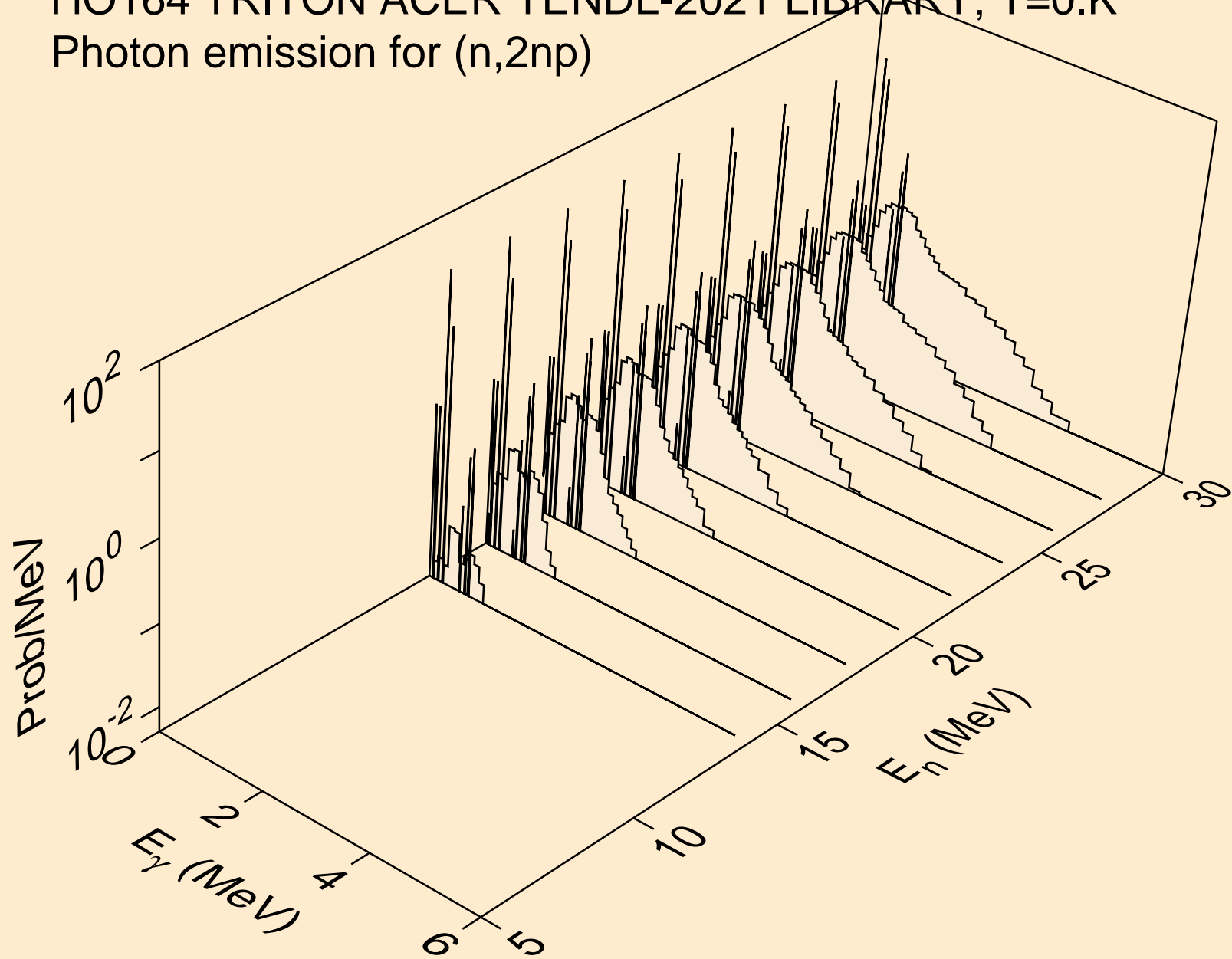

HO164 TRITON ACER TENDL-2021 LIBRARY; T=0.K  
Photon emission for (n,npa)

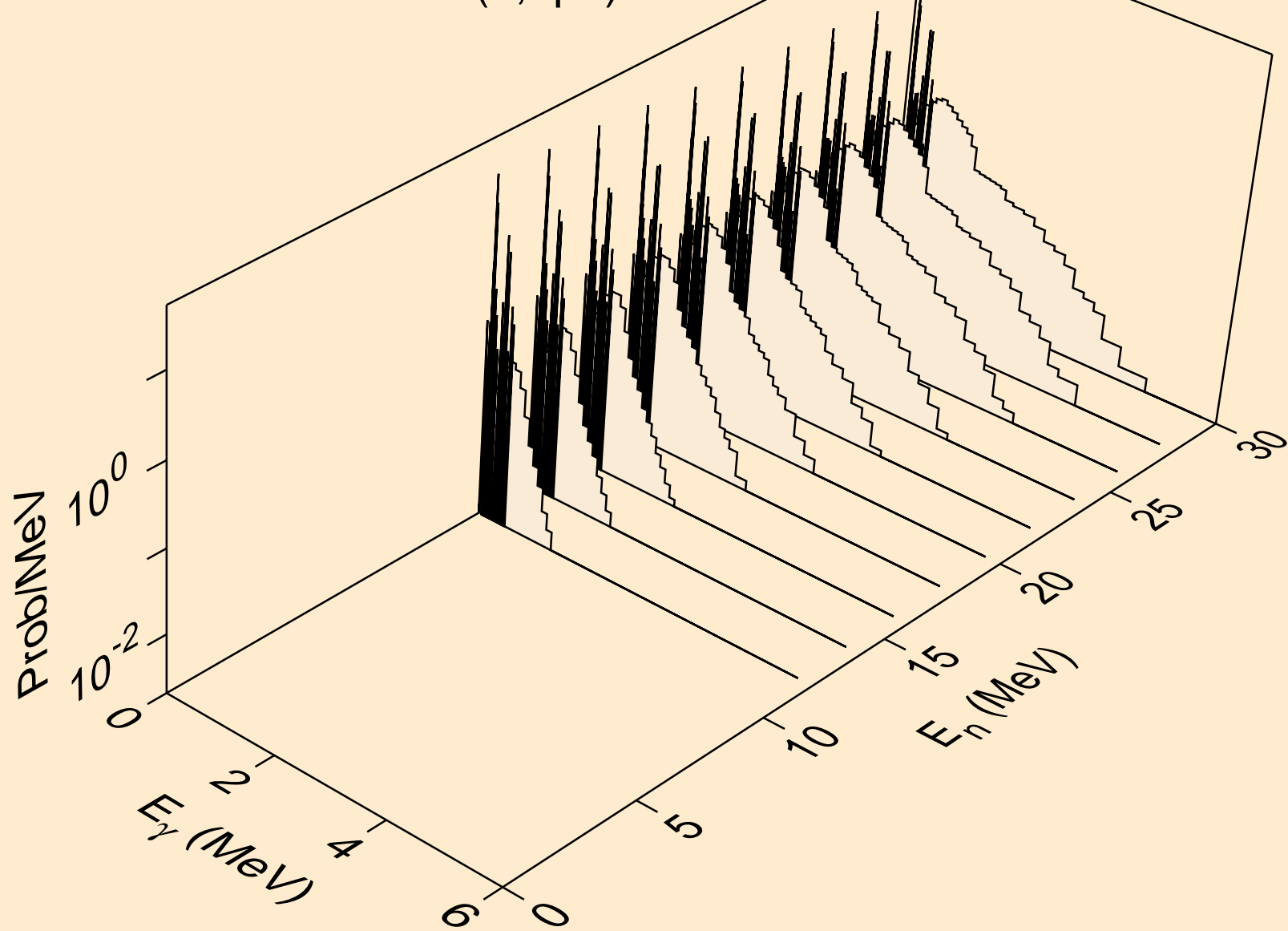



HO164 TRITON ACER TENDL-2021 LIBRARY; T=0.K  
Photon emission for (n,gma)

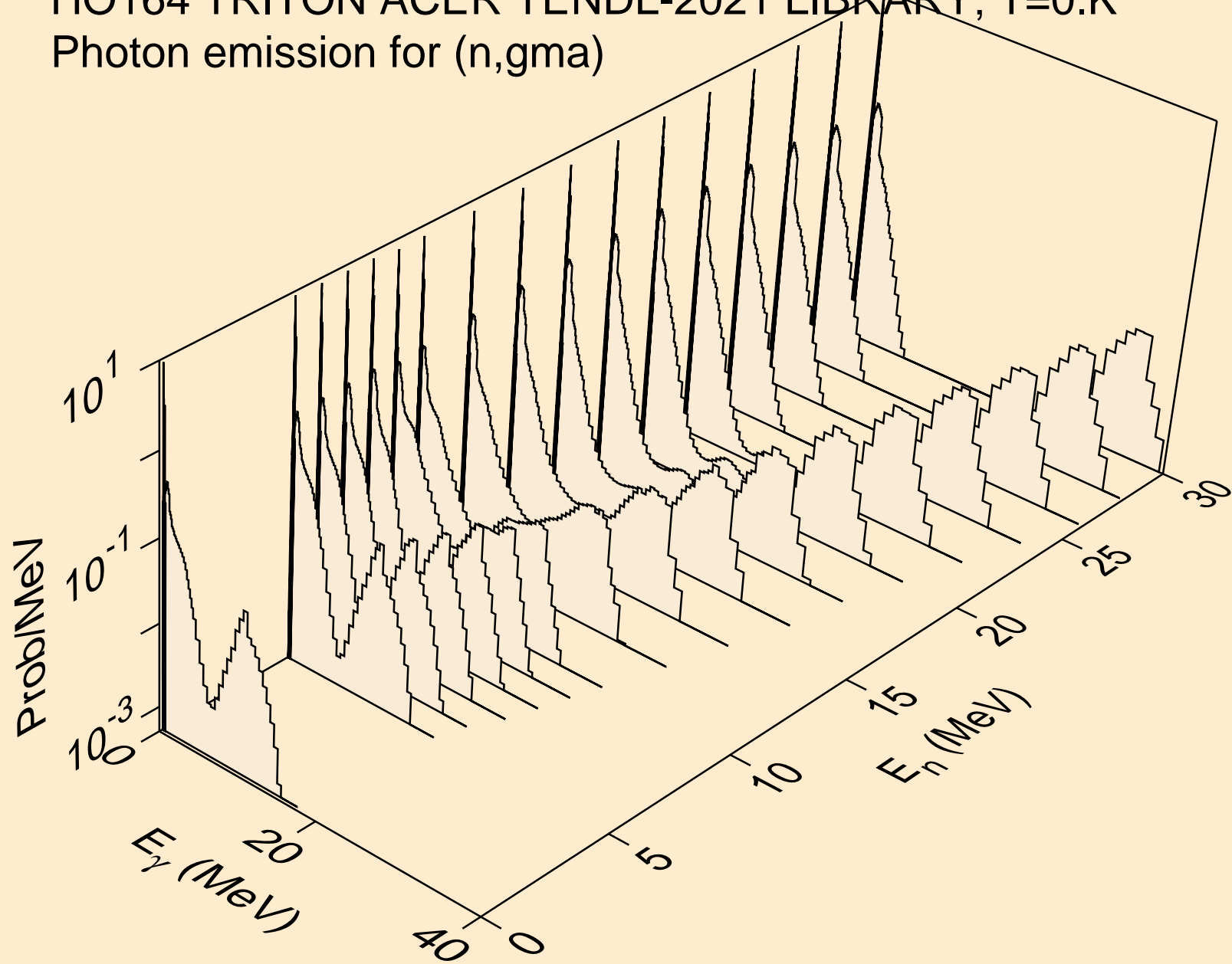

HO164 TRITON ACER TENDL-2021 LIBRARY; T=0.K  
Photon emission for (n,p)

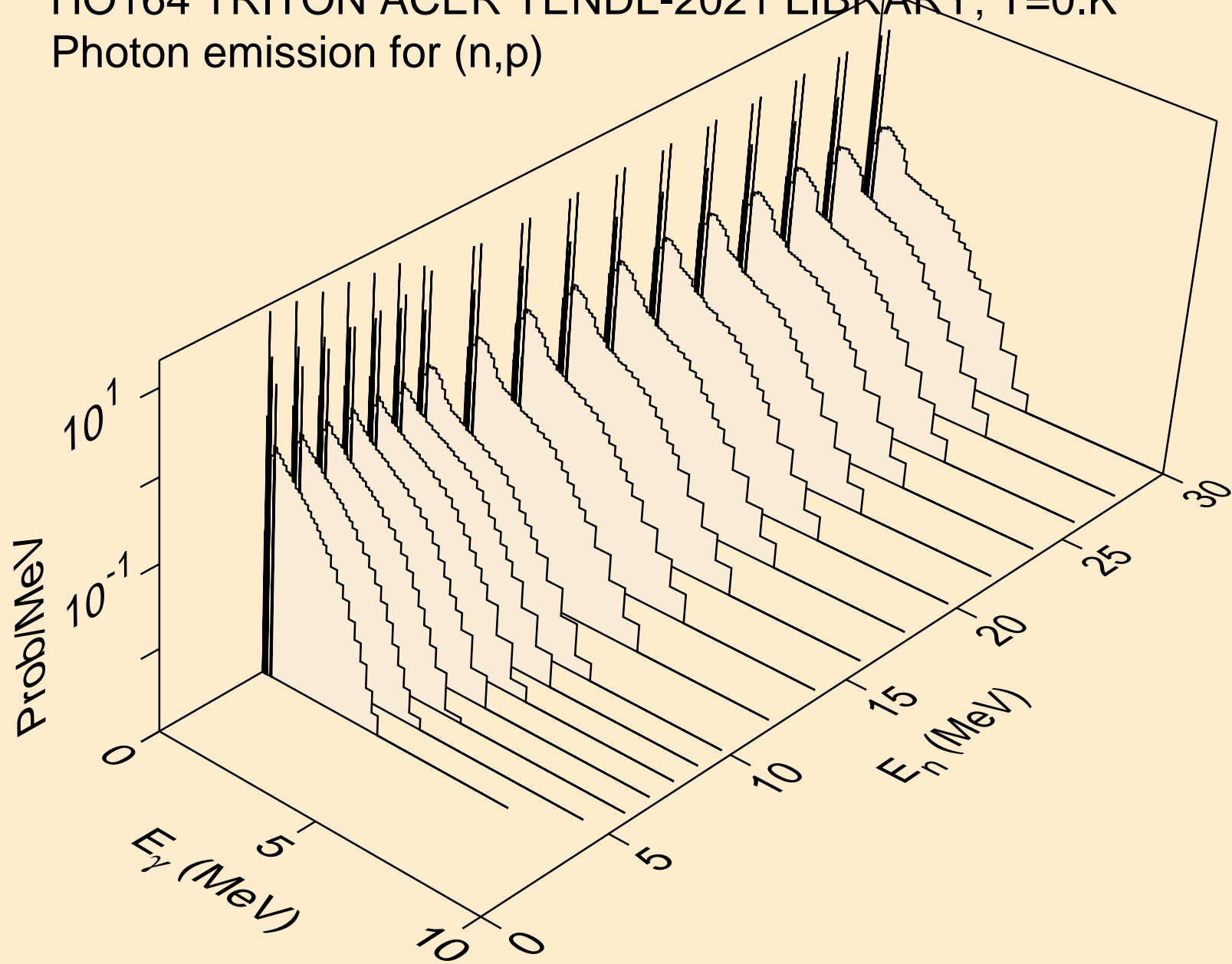

HO164 TRITON ACER TENDL-2021 LIBRARY; T=0.K  
Photon emission for (n,d)

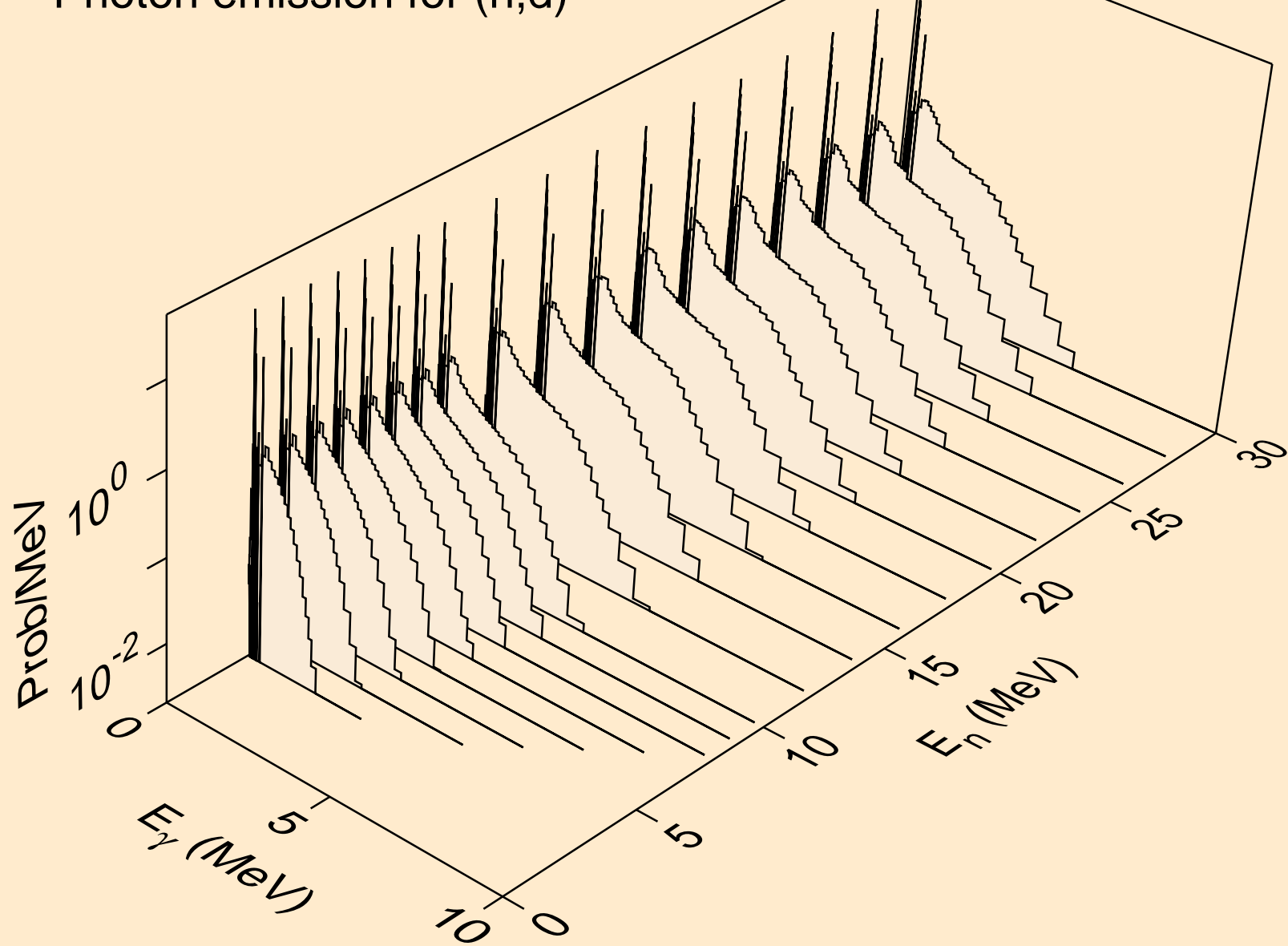

HO164 TRITON ACER TENDL-2021 LIBRARY; T=0.K  
Photon emission for inelastic

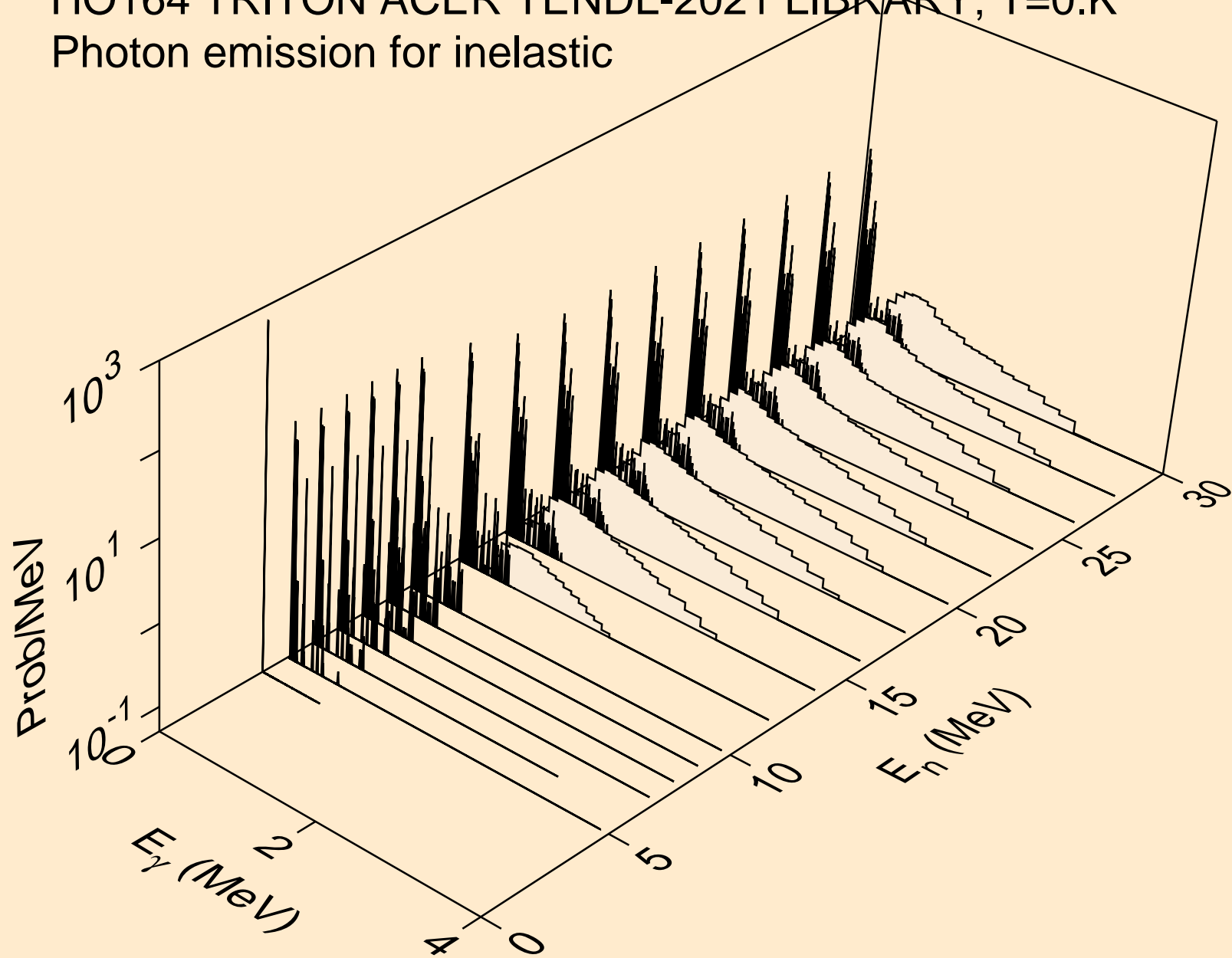

HO164 TRITON ACER TENDL-2021 LIBRARY; T=0.K  
Photon emission for (n,he3)

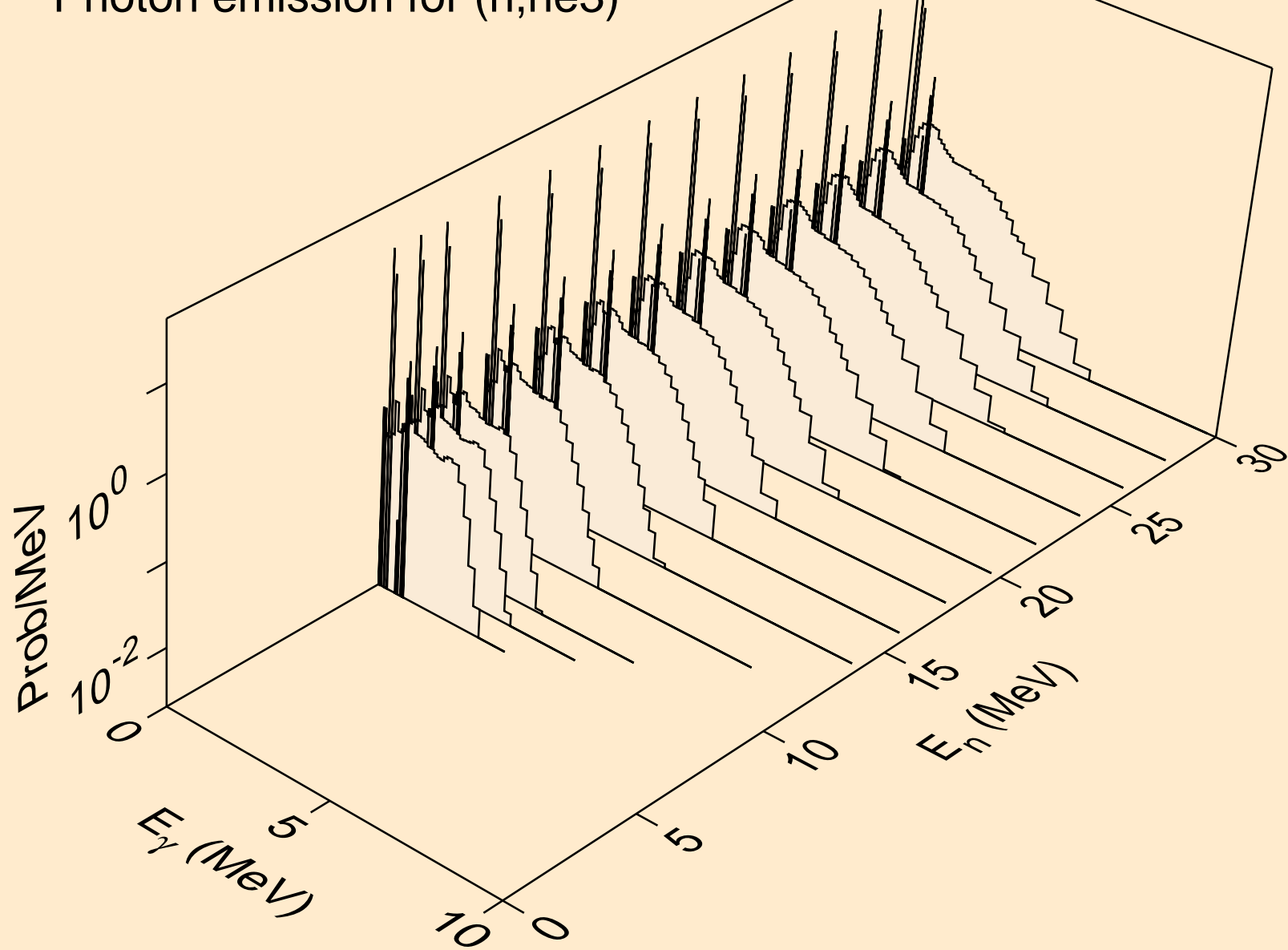

HO164 TRITON ACER TENDL-2021 LIBRARY; T=0.K  
Photon emission for (n,a)

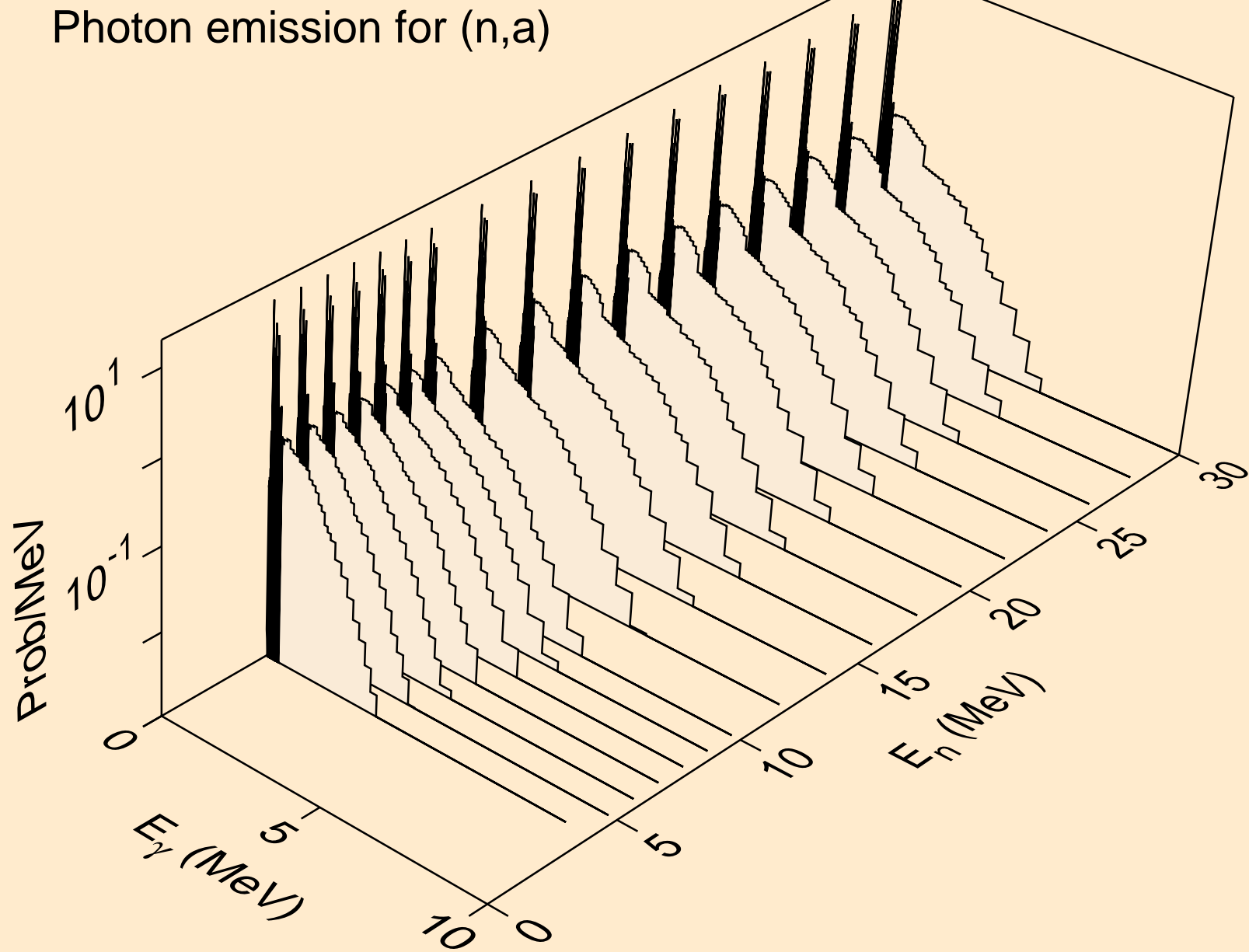

HO164 TRITON ACER TENDL-2021 LIBRARY; T=0.K  
Photon emission for (n,2a)

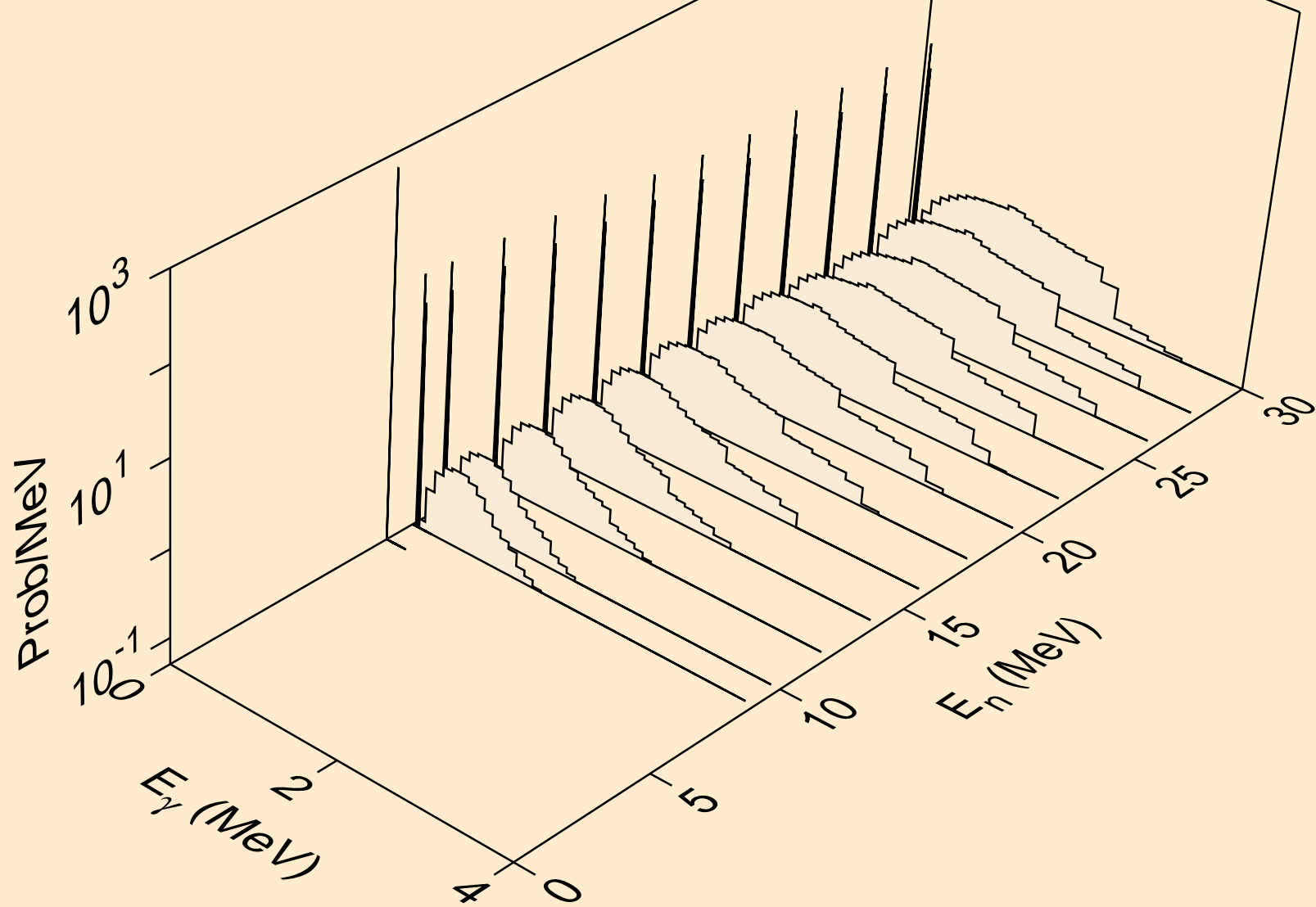

HO164 TRITON ACER TENDL-2021 LIBRARY; T=0.K  
Photon emission for (n,2p)

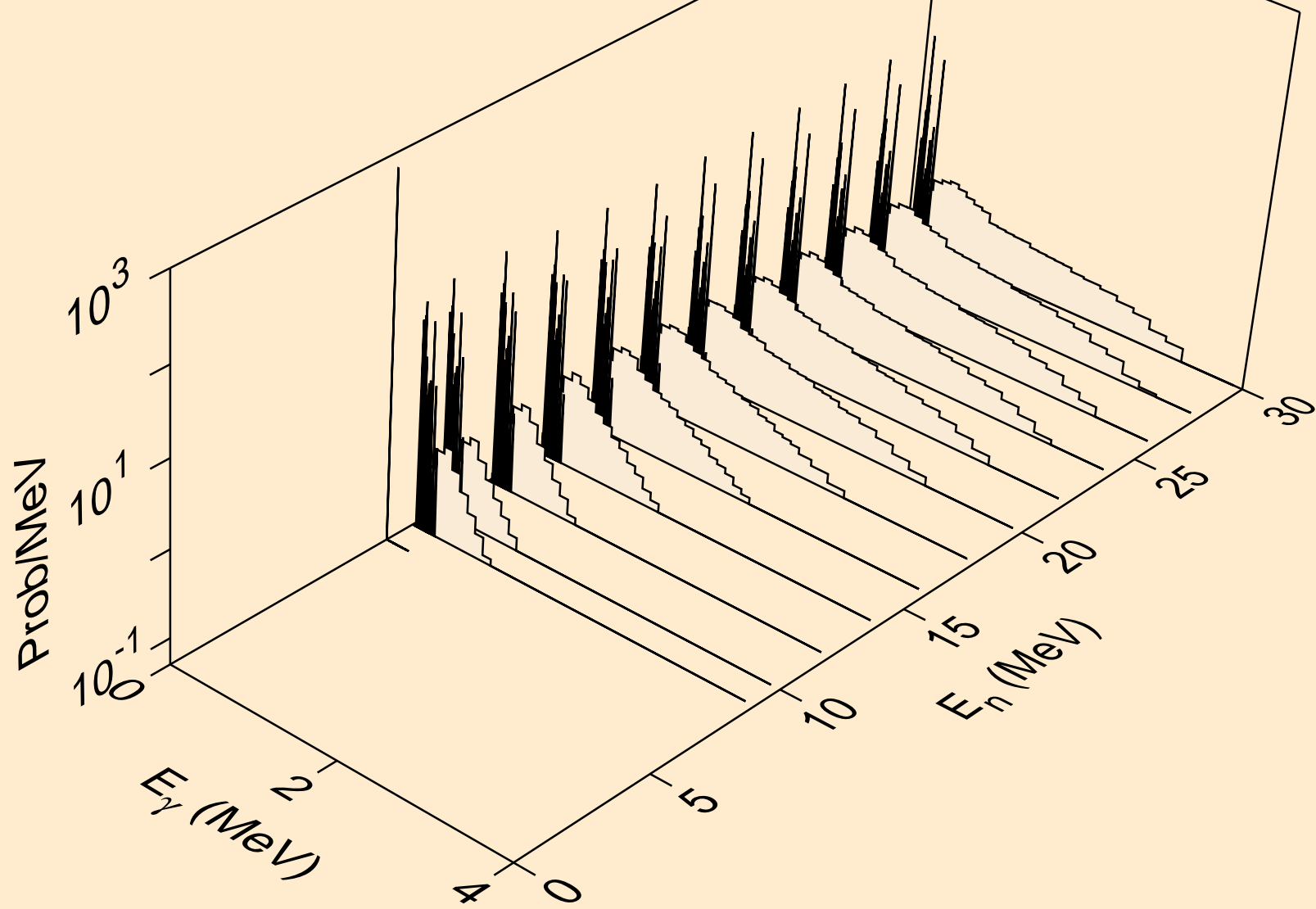



HO164 TRITON ACER TENDL-2021 LIBRARY; T=0.K  
Photon emission for (n,pa)

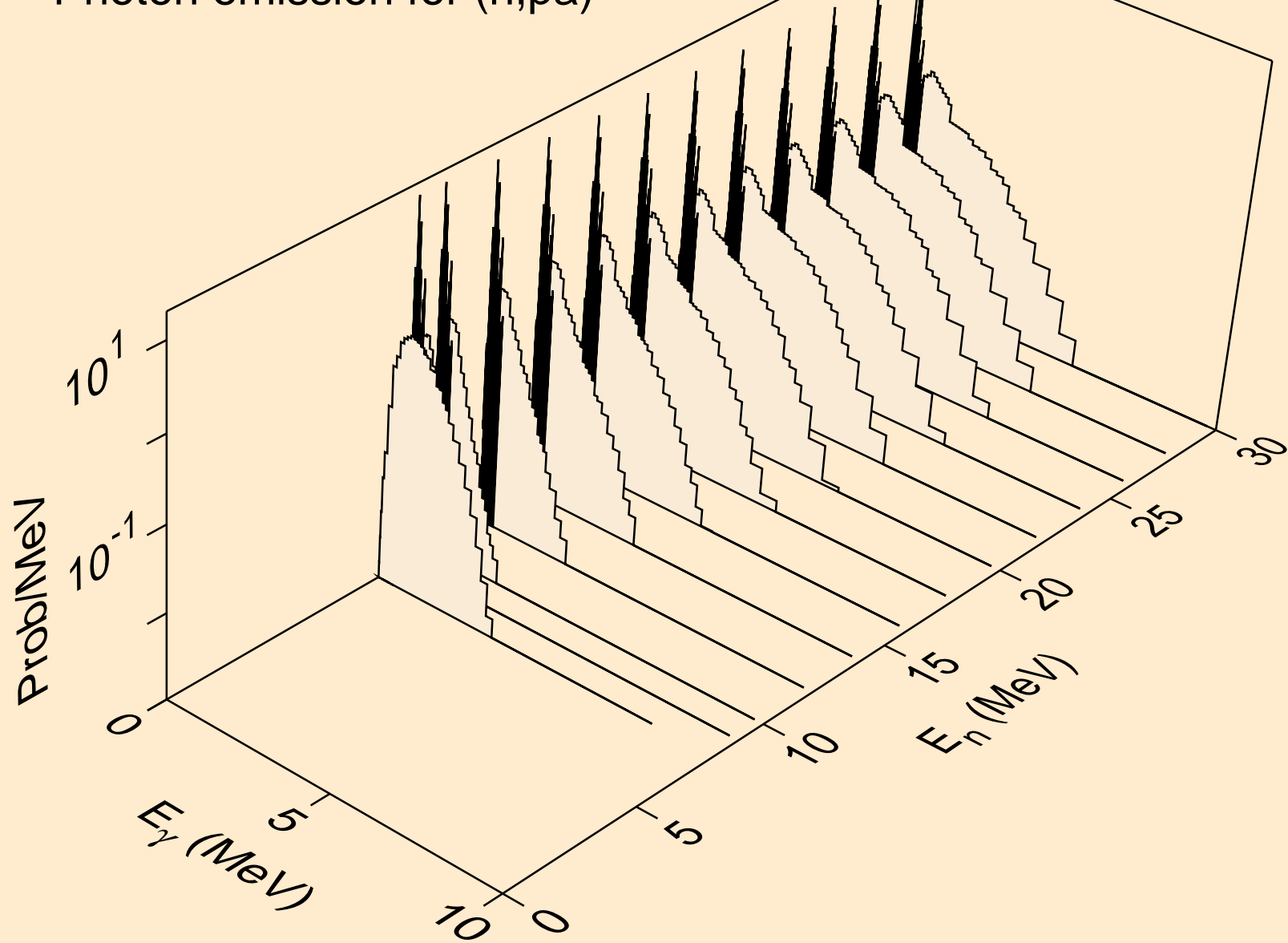

HO164 TRITON ACER TENDL-2021 LIBRARY; T=0.K  
Photon emission for (n,pd)

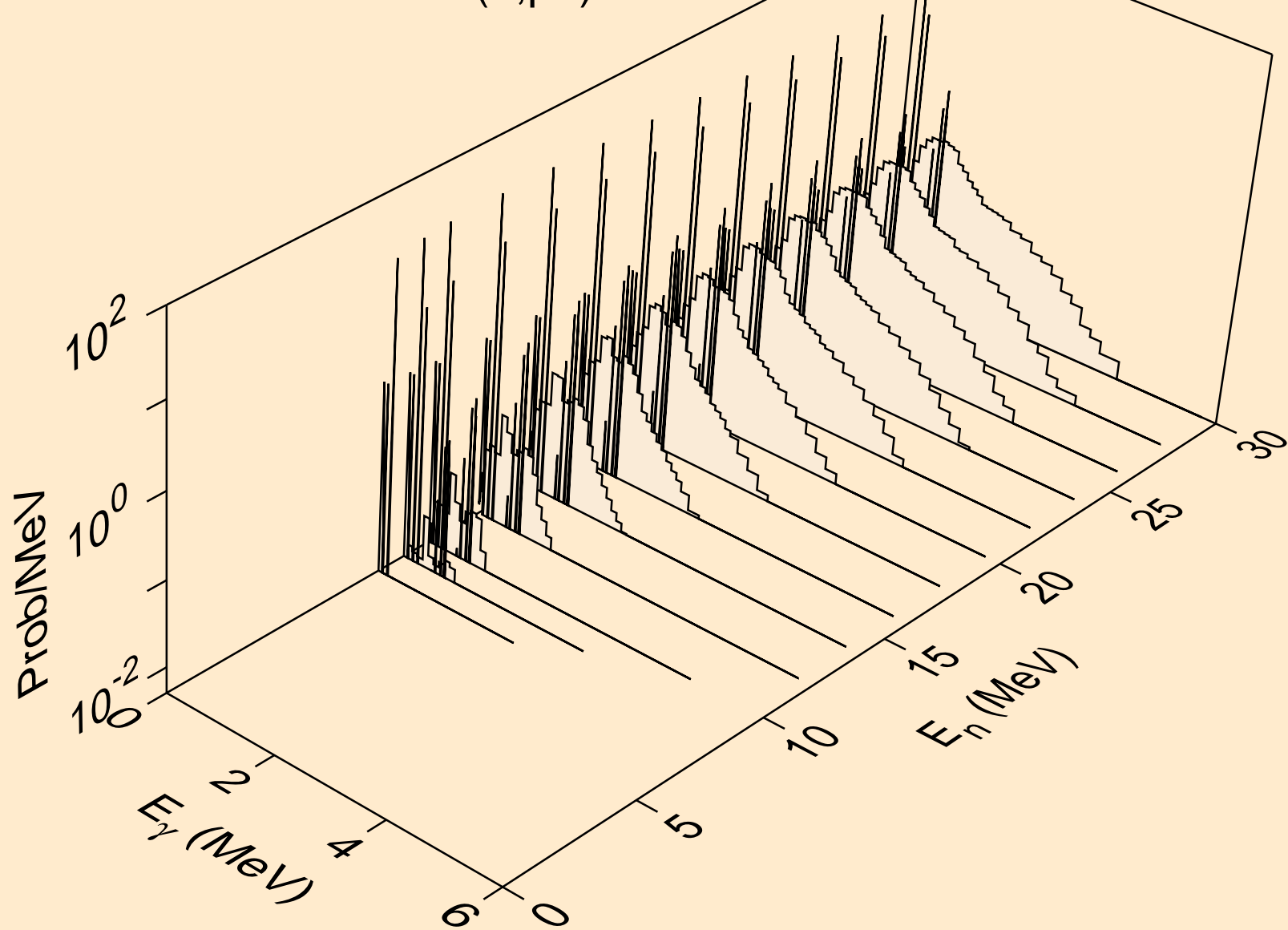

HO164 TRITON ACER TENDL-2021 LIBRARY; T=0.K  
Photon emission for (n,pt)

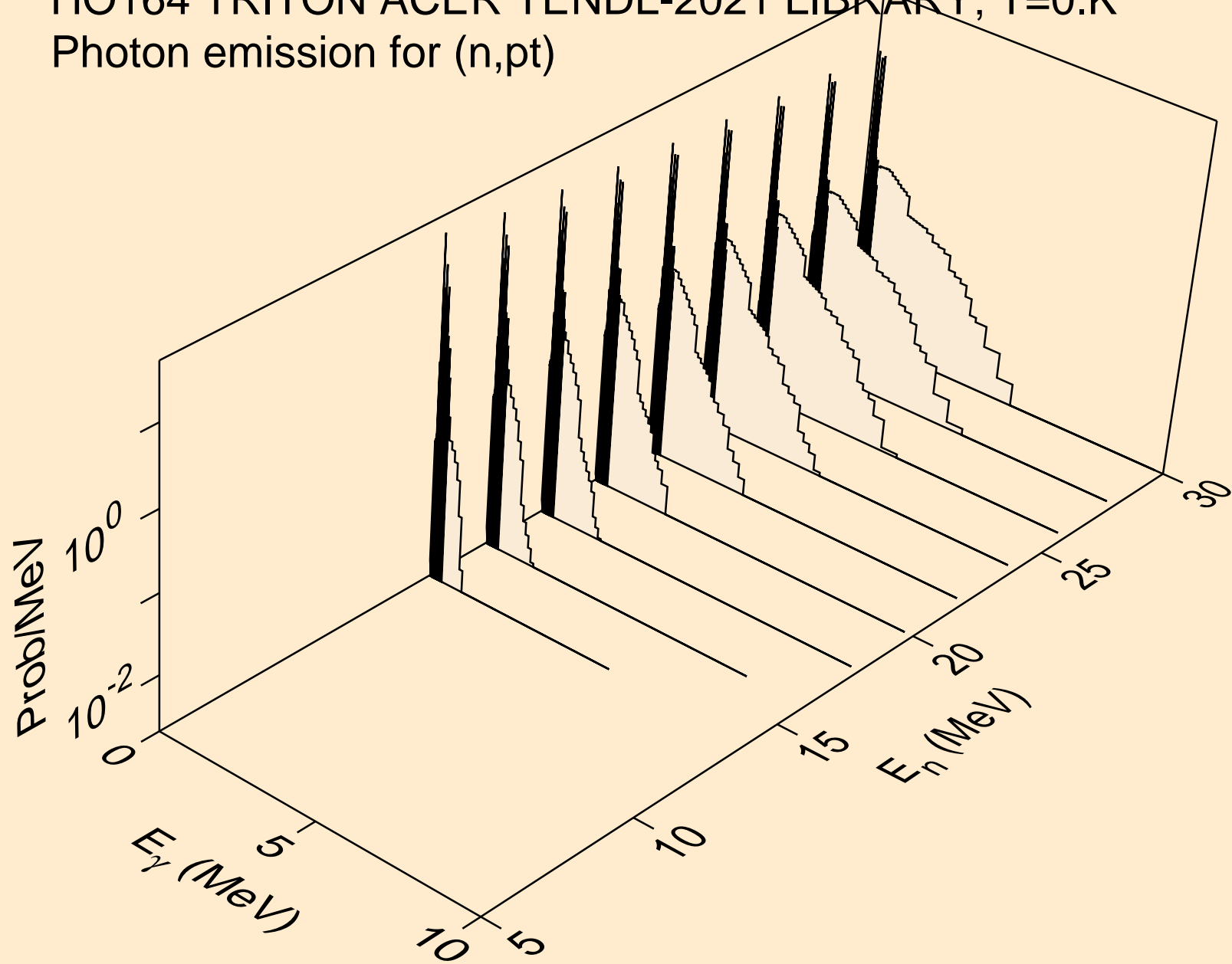

HO164 TRITON ACER TENDL-2021 LIBRARY; T=0.K  
Photon emission for (n,da)

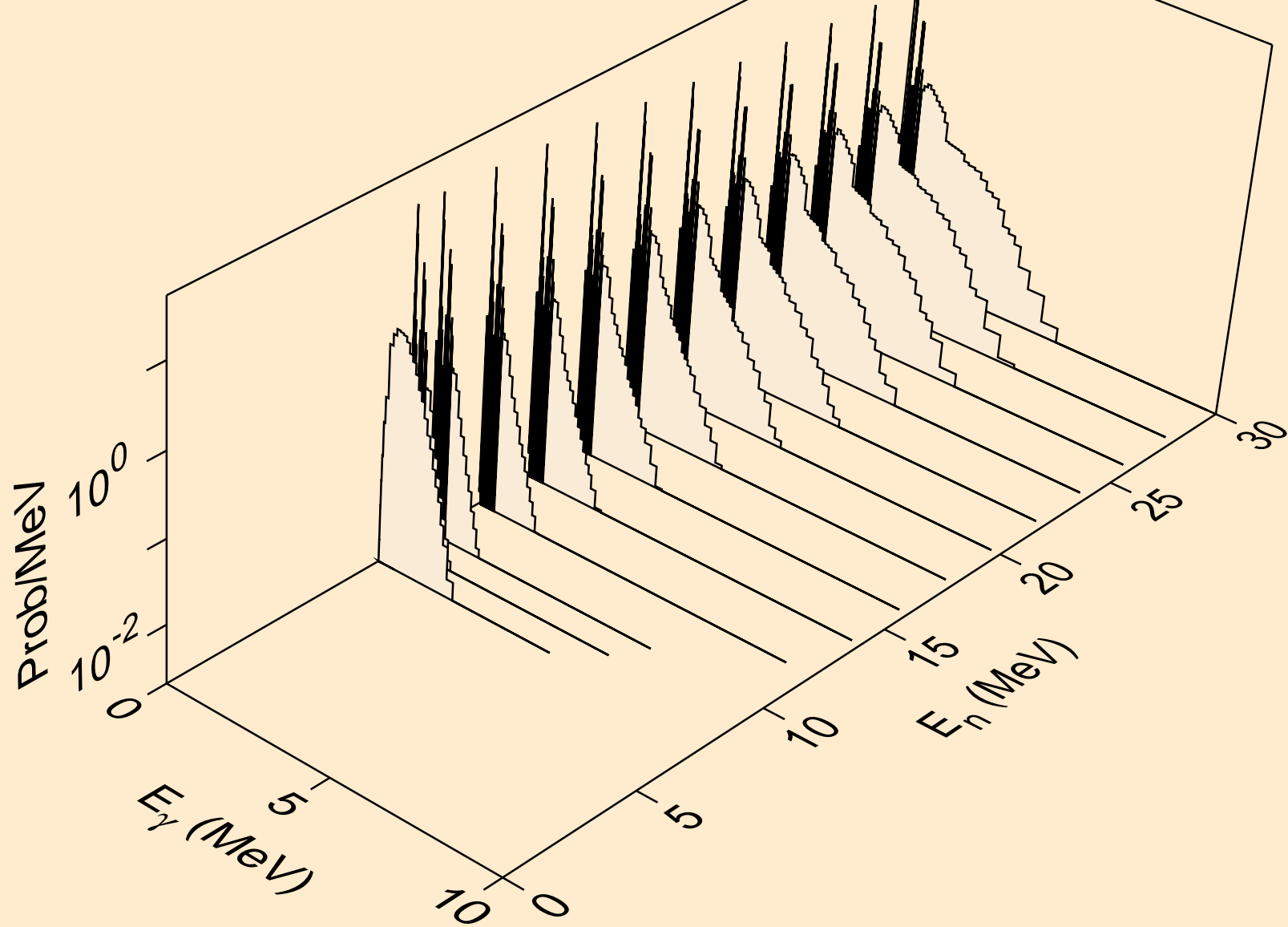

# HO164 TRITON ACER TENDL-2021 LIBRARY; T=0.K

## Particle heating contributions

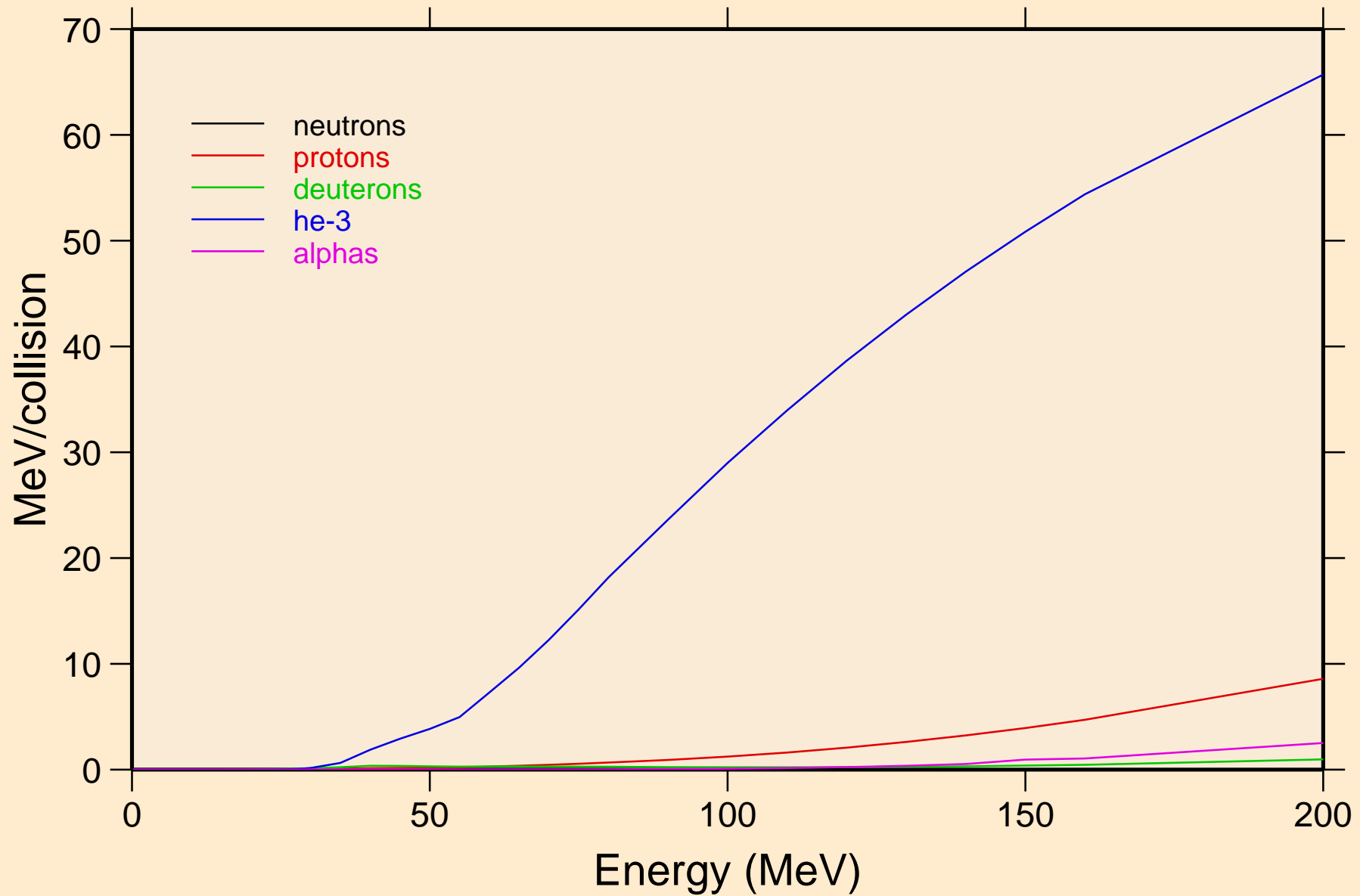

HO164 TRITON ACER TENDL-2021 LIBRARY; T=0.K  
Recoil Heating

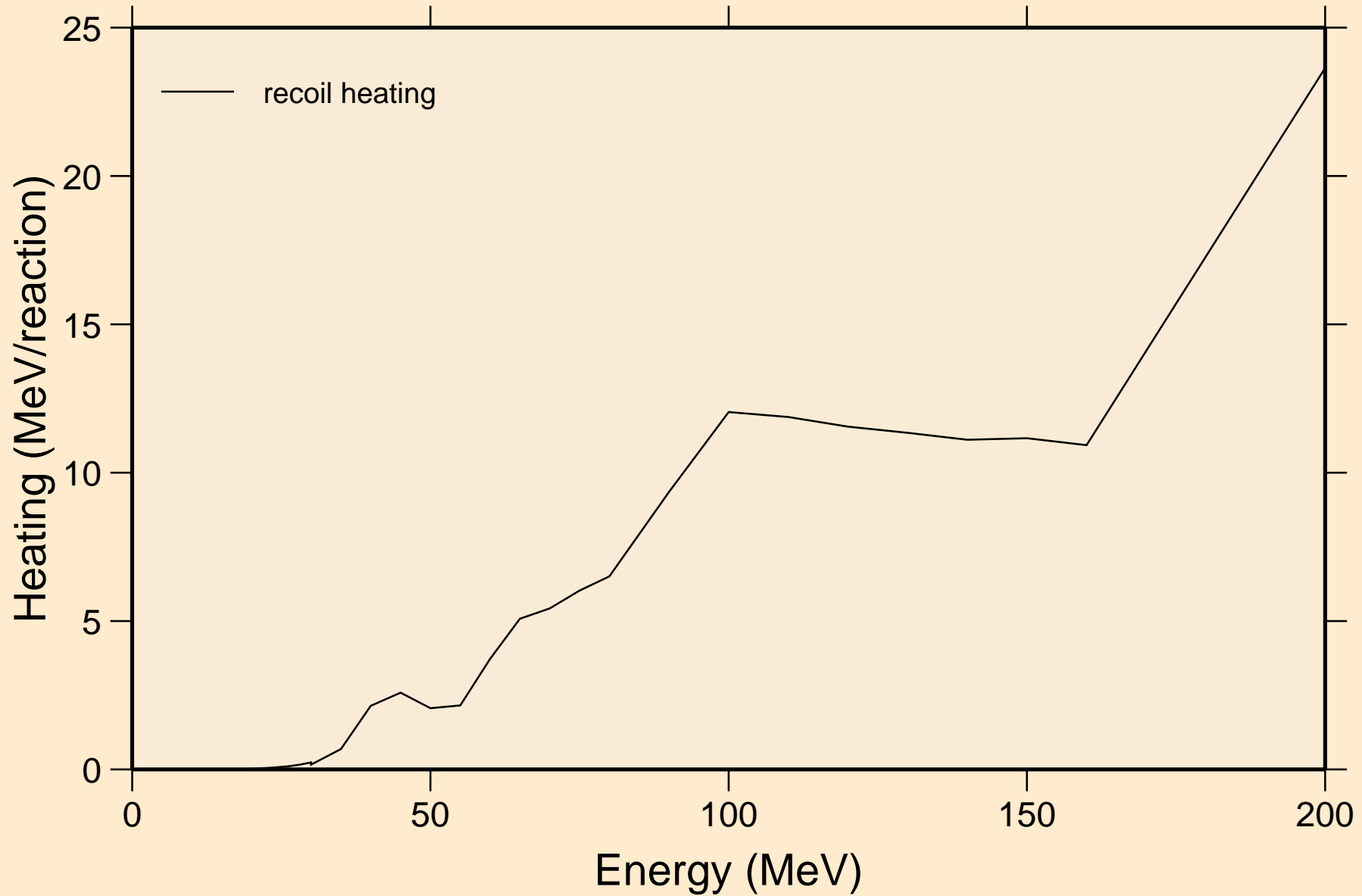

HO164 TRITON ACER TENDL-2021 LIBRARY; T=0.K  
Particle production cross sections

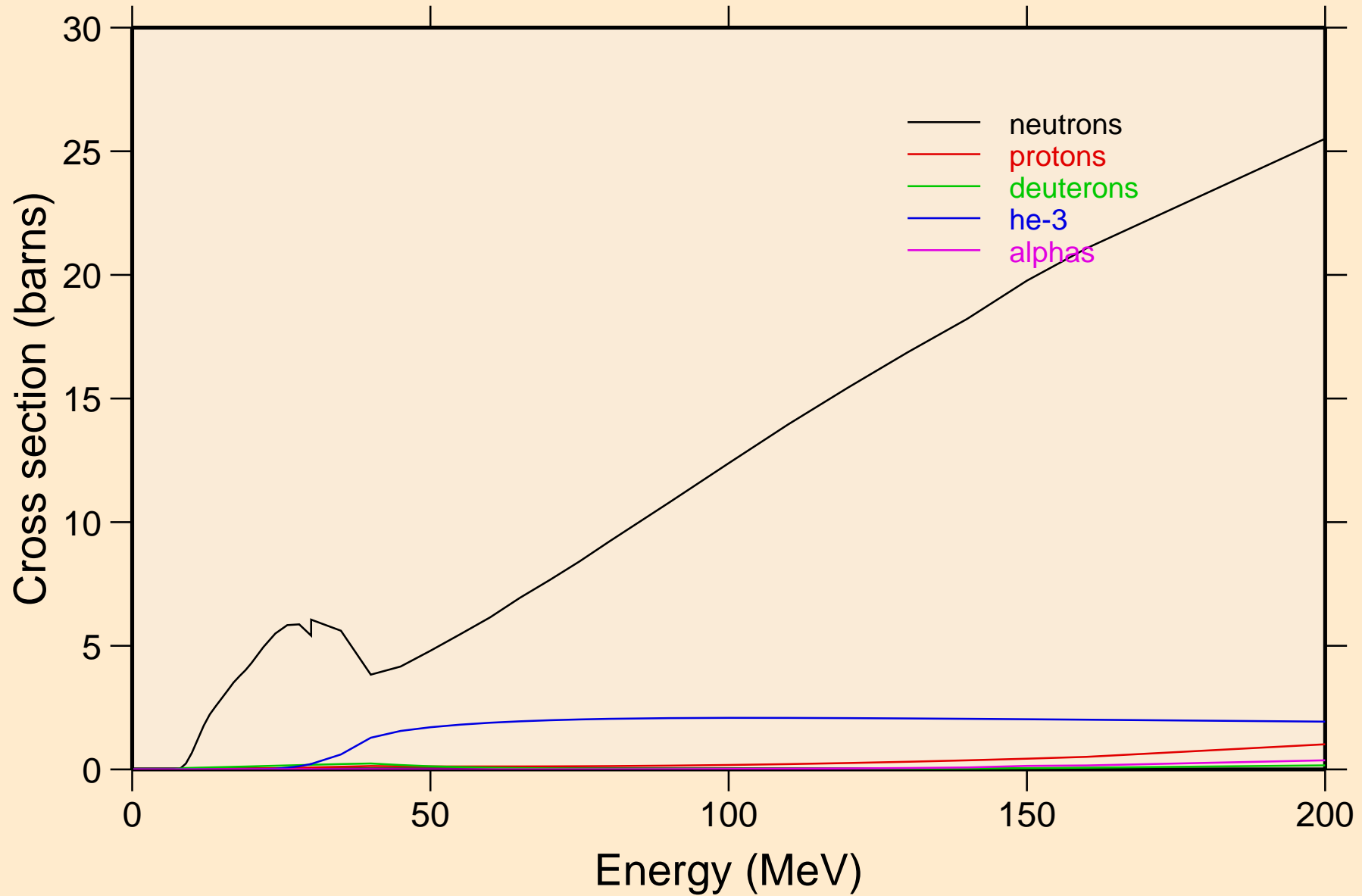

HO164 TRITON ACER TENDL-2021 LIBRARY; T=0.K  
neutrons from (t,n)

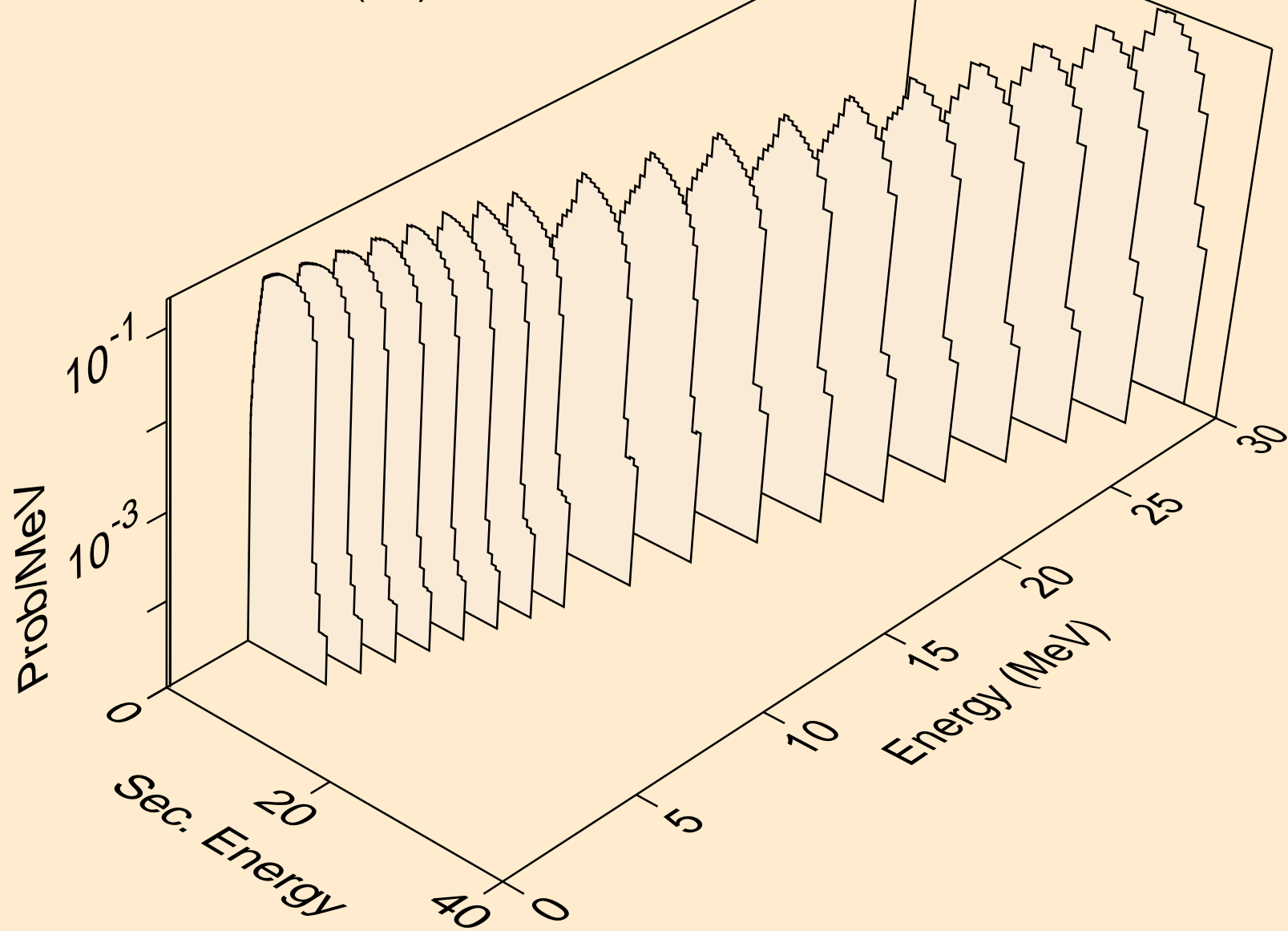



HO164 TRITON ACER TENDL-2021 LIBRARY; T=0.K  
neutrons from (t,x)

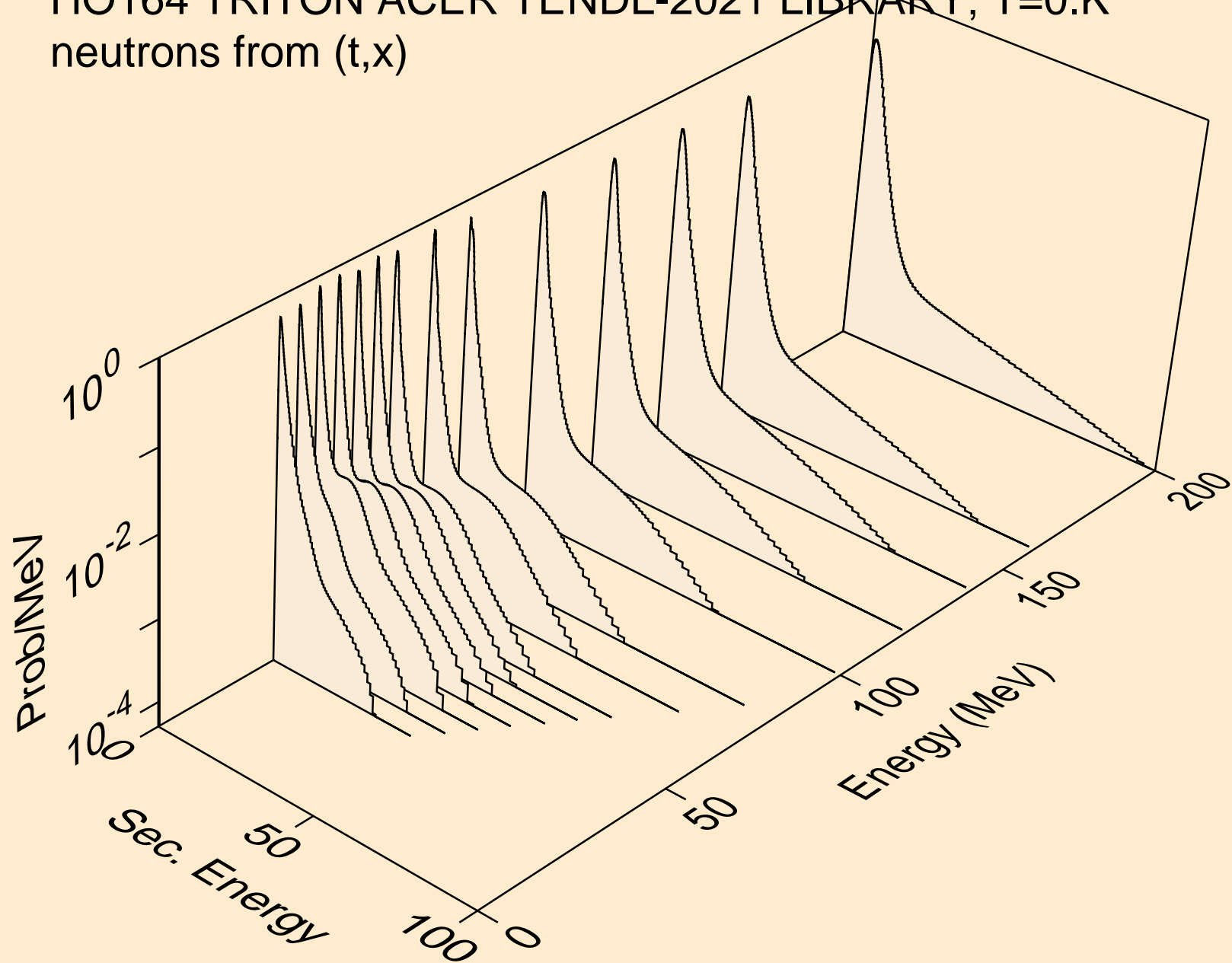

HO164 TRITON ACER TENDL-2021 LIBRARY; T=0.K  
neutrons from (t,2nd)

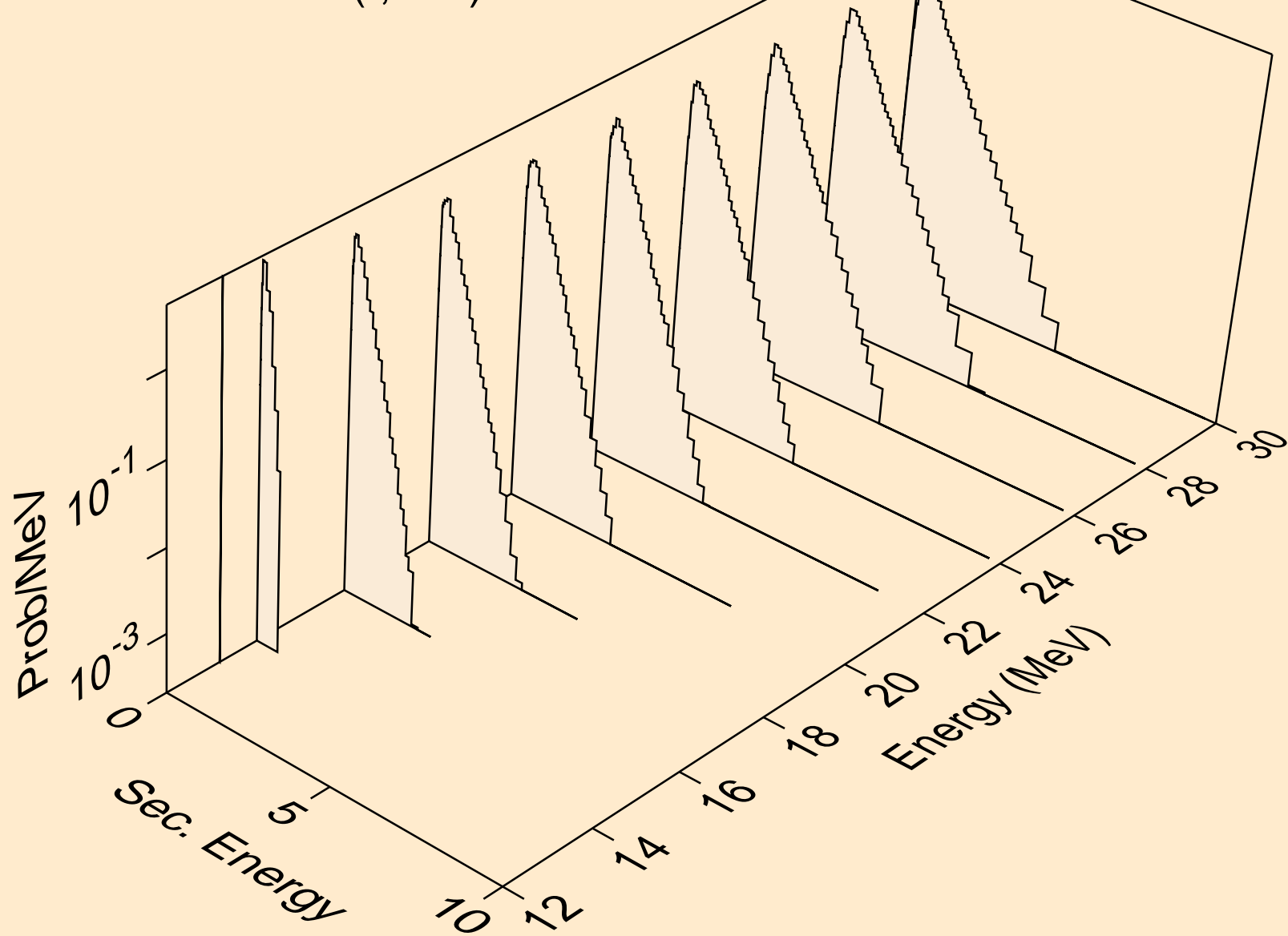

HO164 TRITON ACER TENDL-2021 LIBRARY; T=0.K  
neutrons from (t,2n)

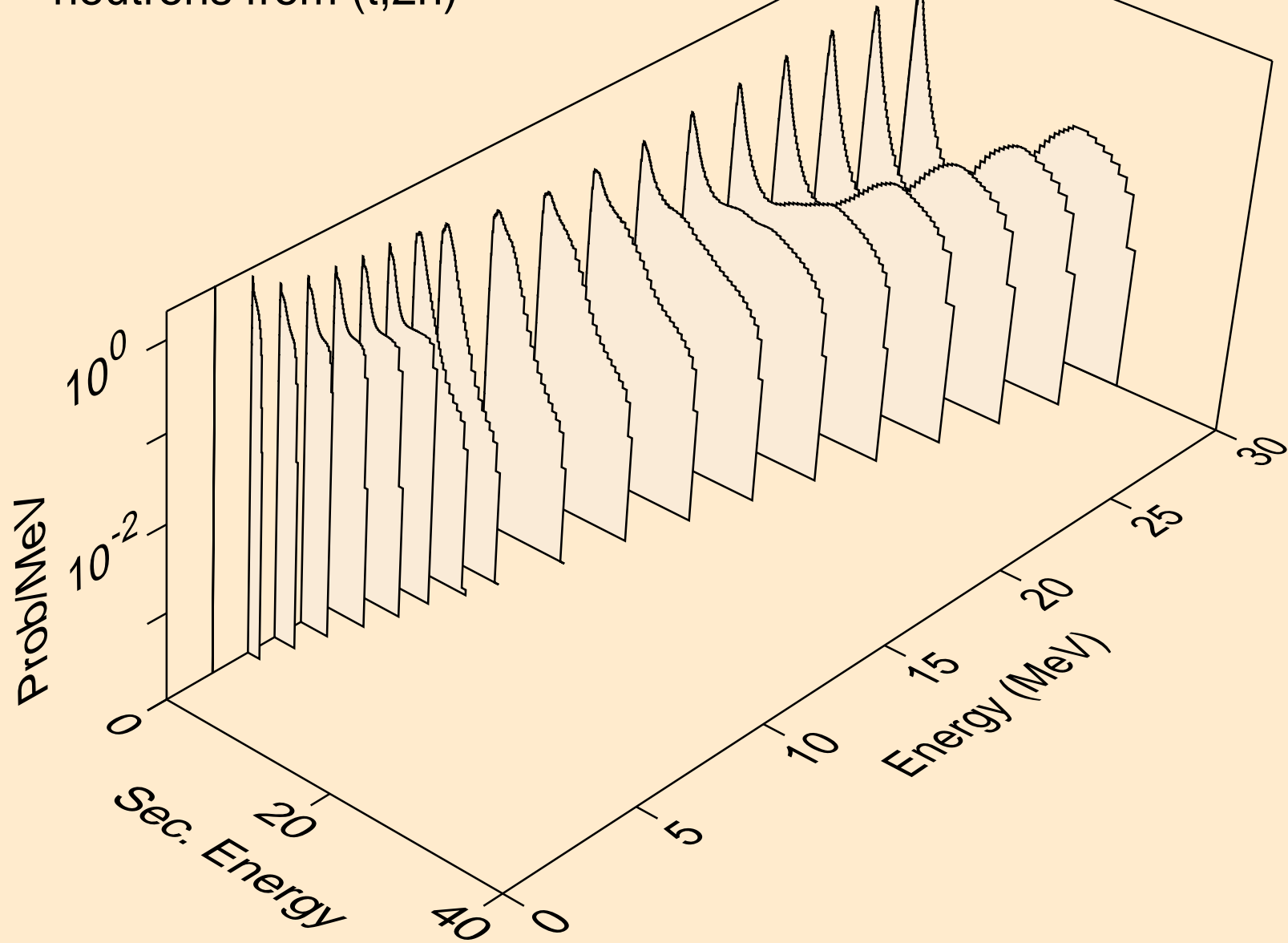

HO164 TRITON ACER TENDL-2021 LIBRARY; T=0.K  
neutrons from (t,3n)

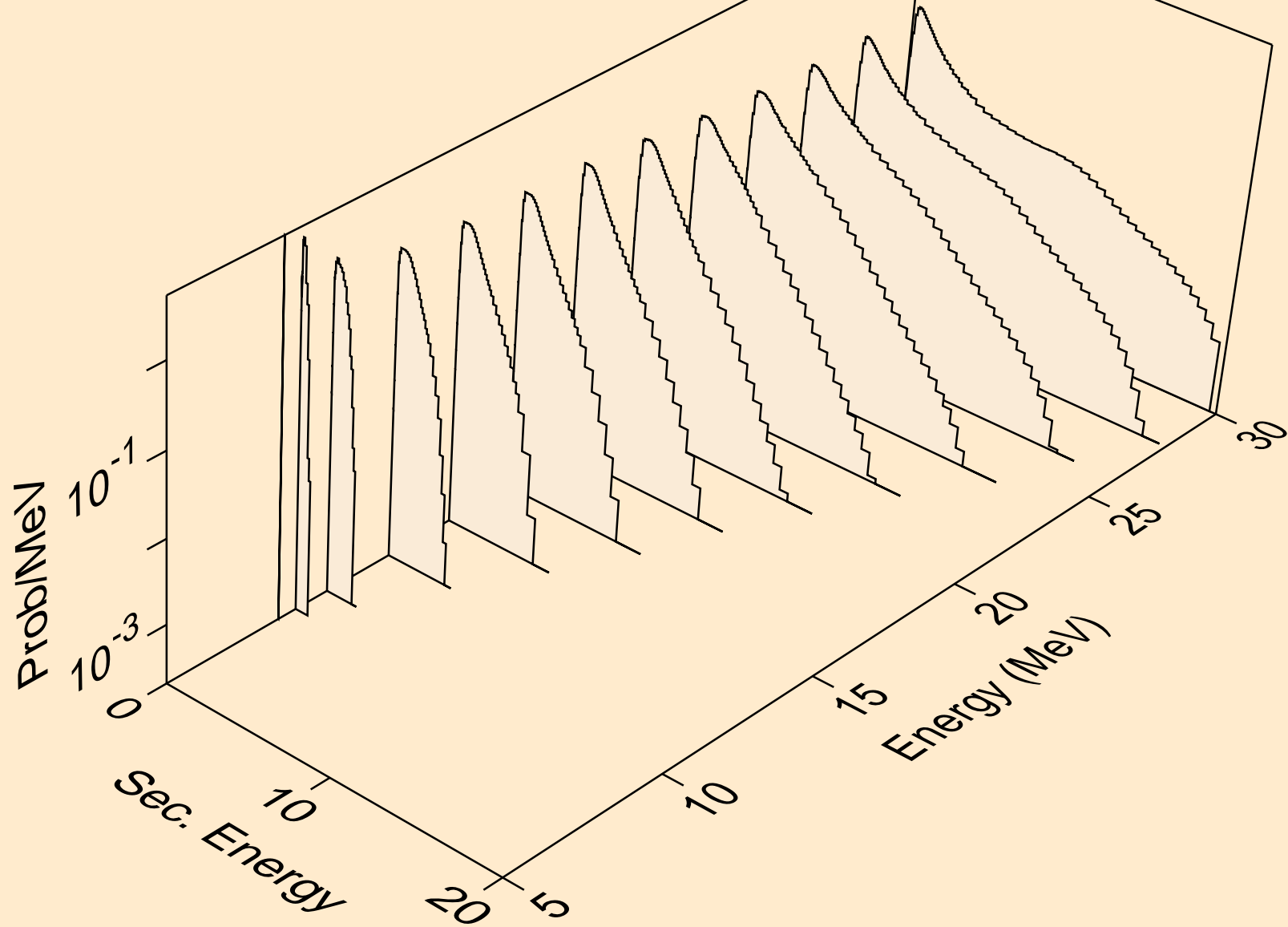

HO164 TRITON ACER TENDL-2021 LIBRARY; T=0.K  
neutrons from (t,n\*)a

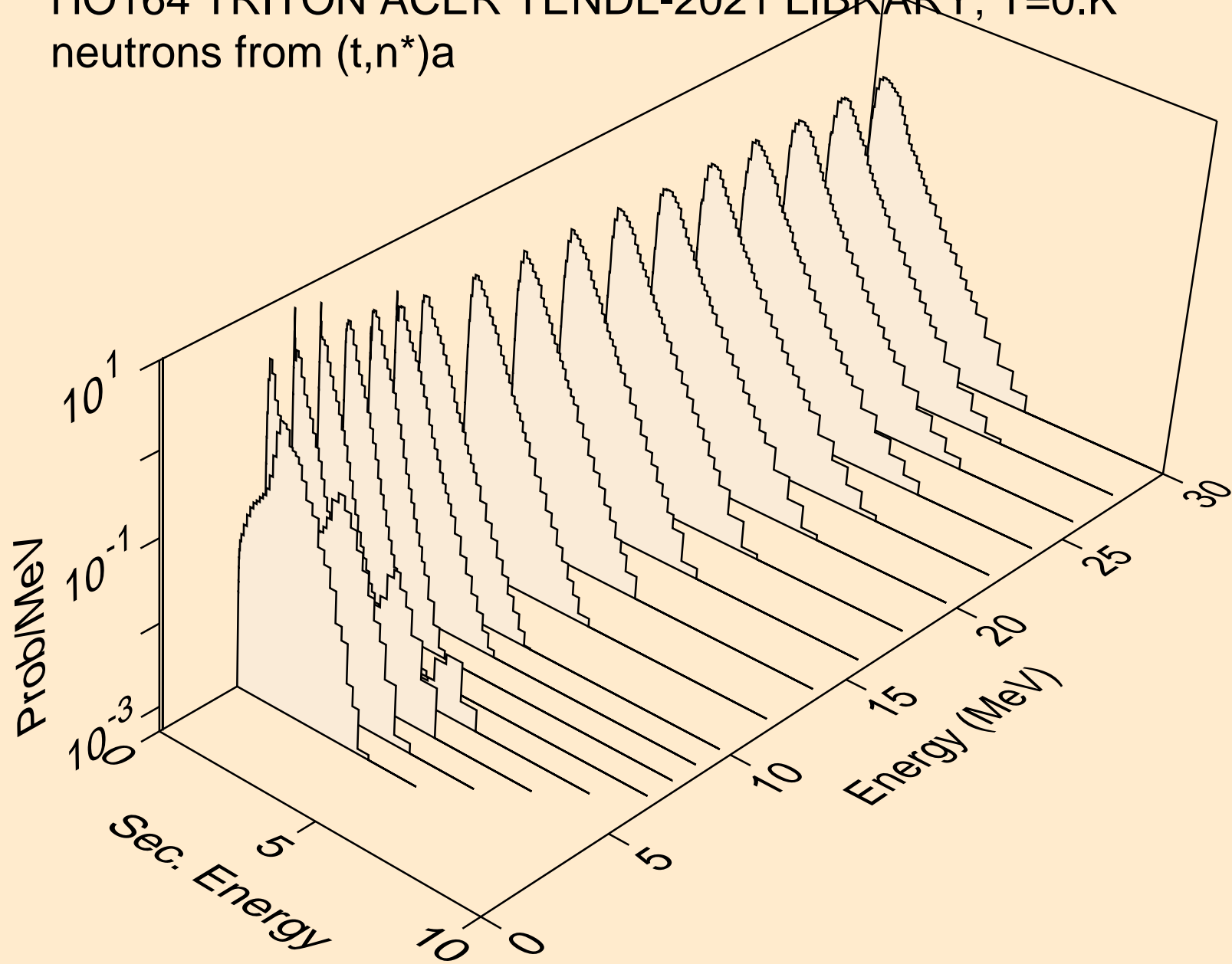

HO164 TRITON ACER TENDL-2021 LIBRARY; T=0.K  
neutrons from (t,2n)a

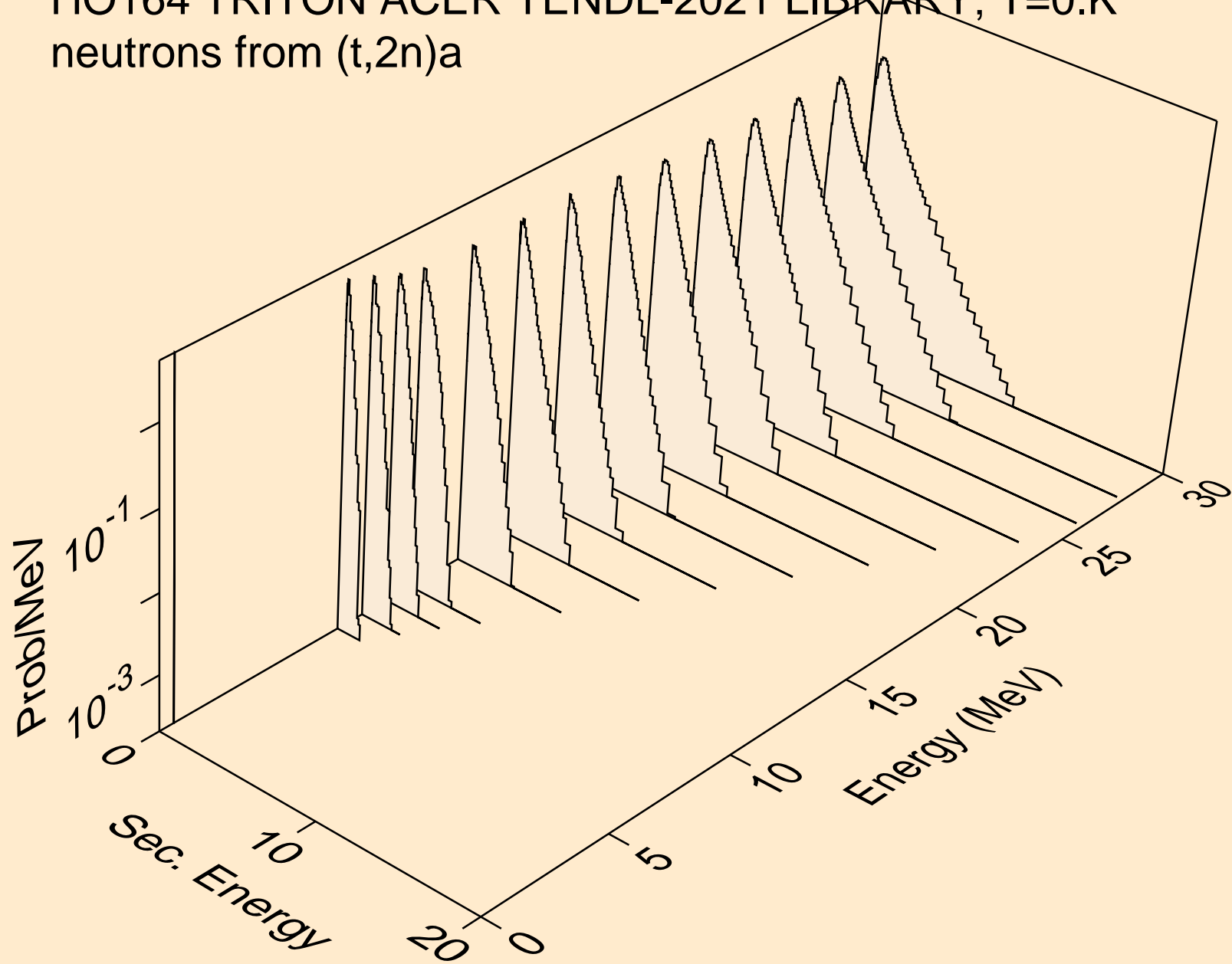

HO164 TRITON ACER TENDL-2021 LIBRARY; T=0.K  
neutrons from (t,3n)a

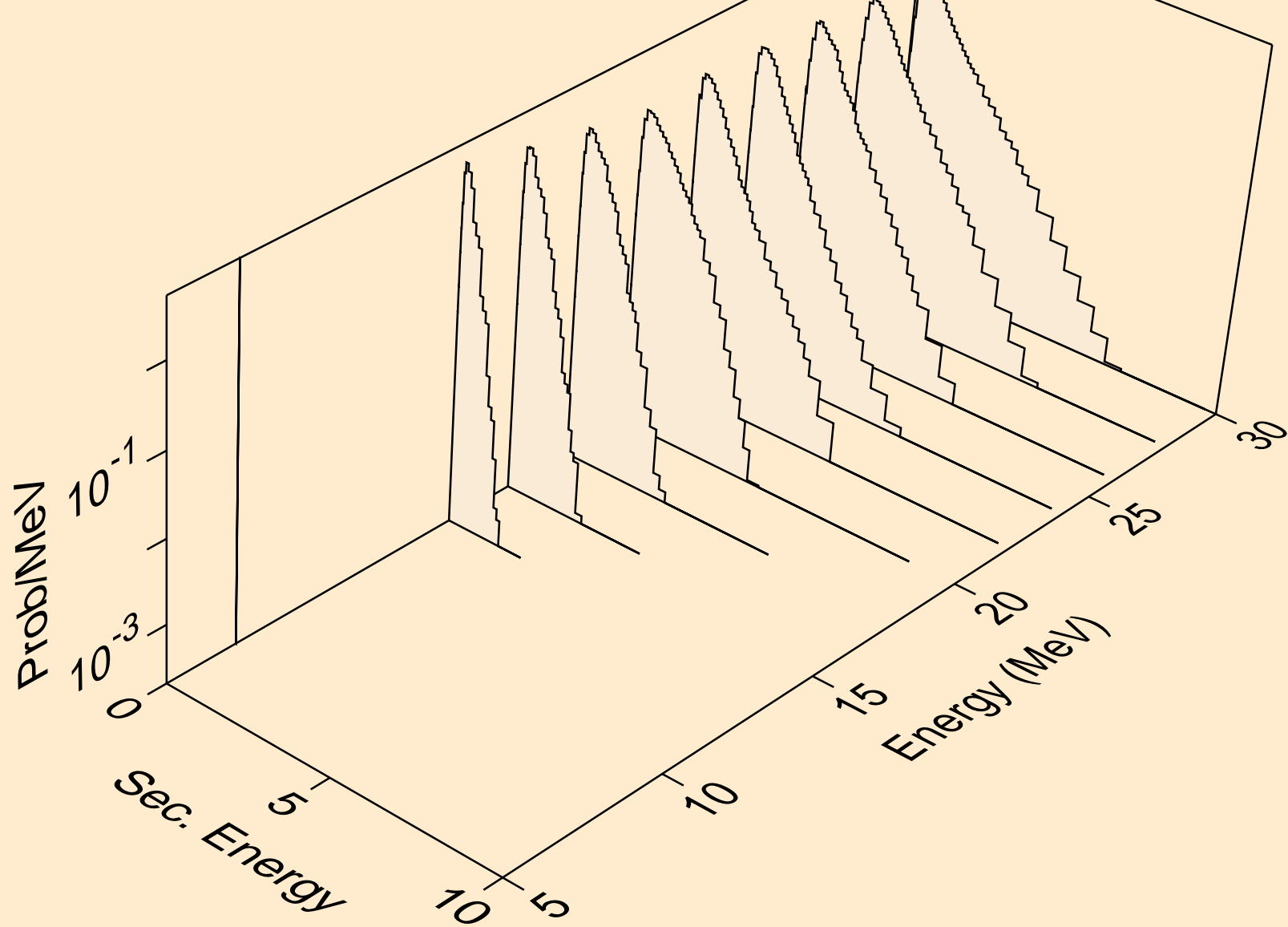

HO164 TRITON ACER TENDL-2021 LIBRARY; T=0.K  
neutrons from (t,n\*)p

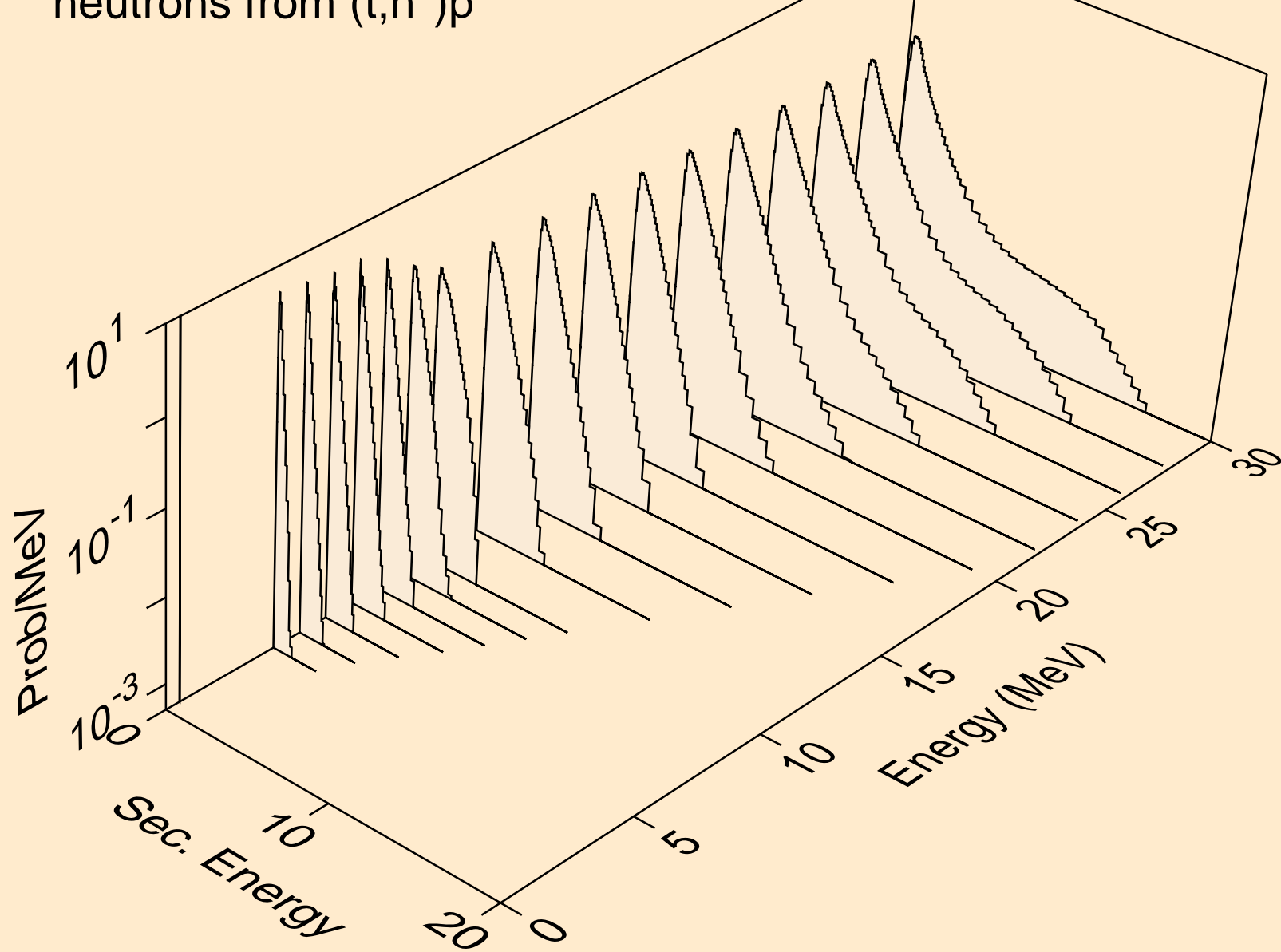



HO164 TRITON ACER TENDL-2021 LIBRARY; T=0.K  
neutrons from (t,n\*)2a

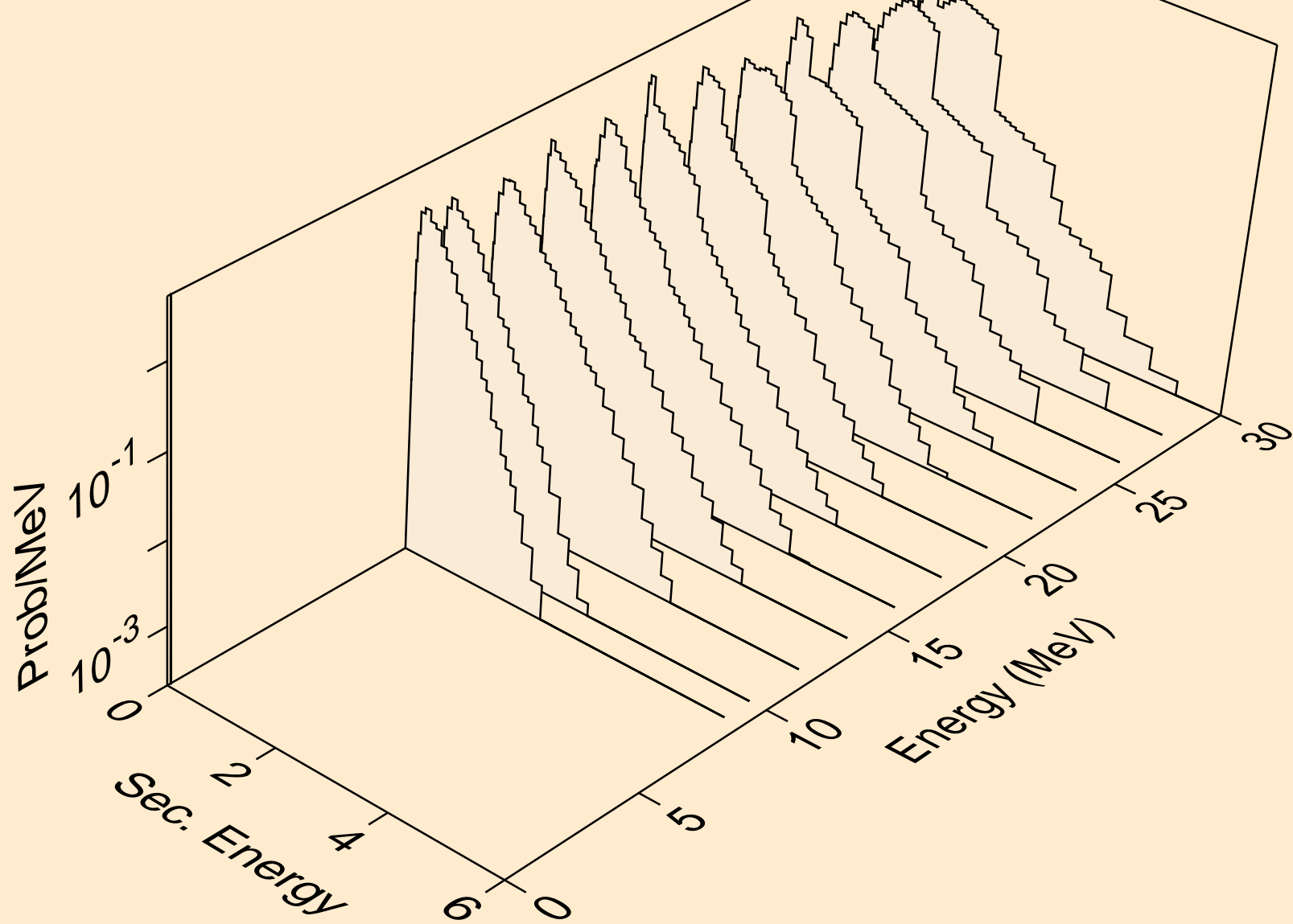

HO164 TRITON ACER TENDL-2021 LIBRARY; T=0.K  
neutrons from (t,2n)2a

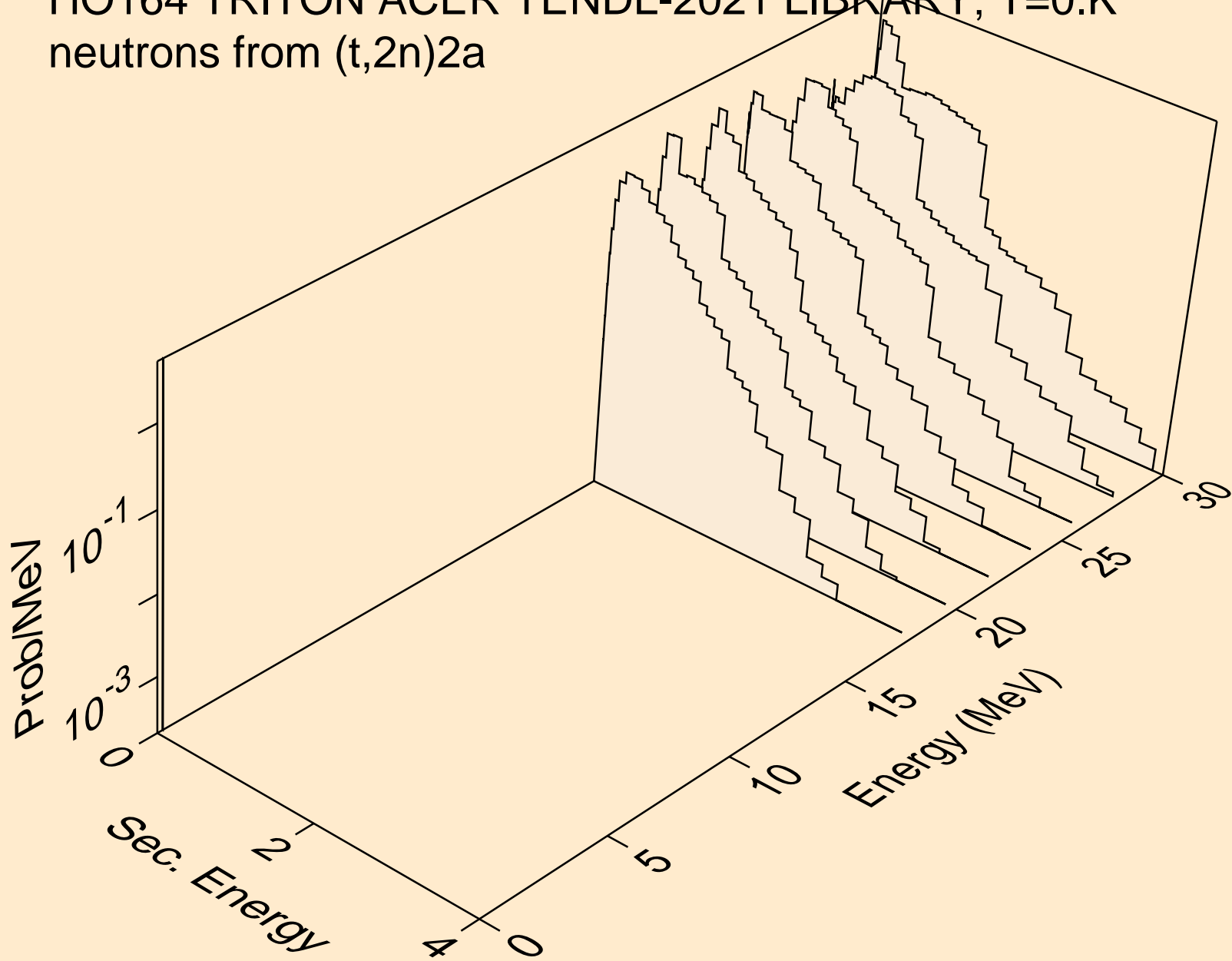

HO164 TRITON ACER TENDL-2021 LIBRARY; T=0.K  
neutrons from (t,n\*)d

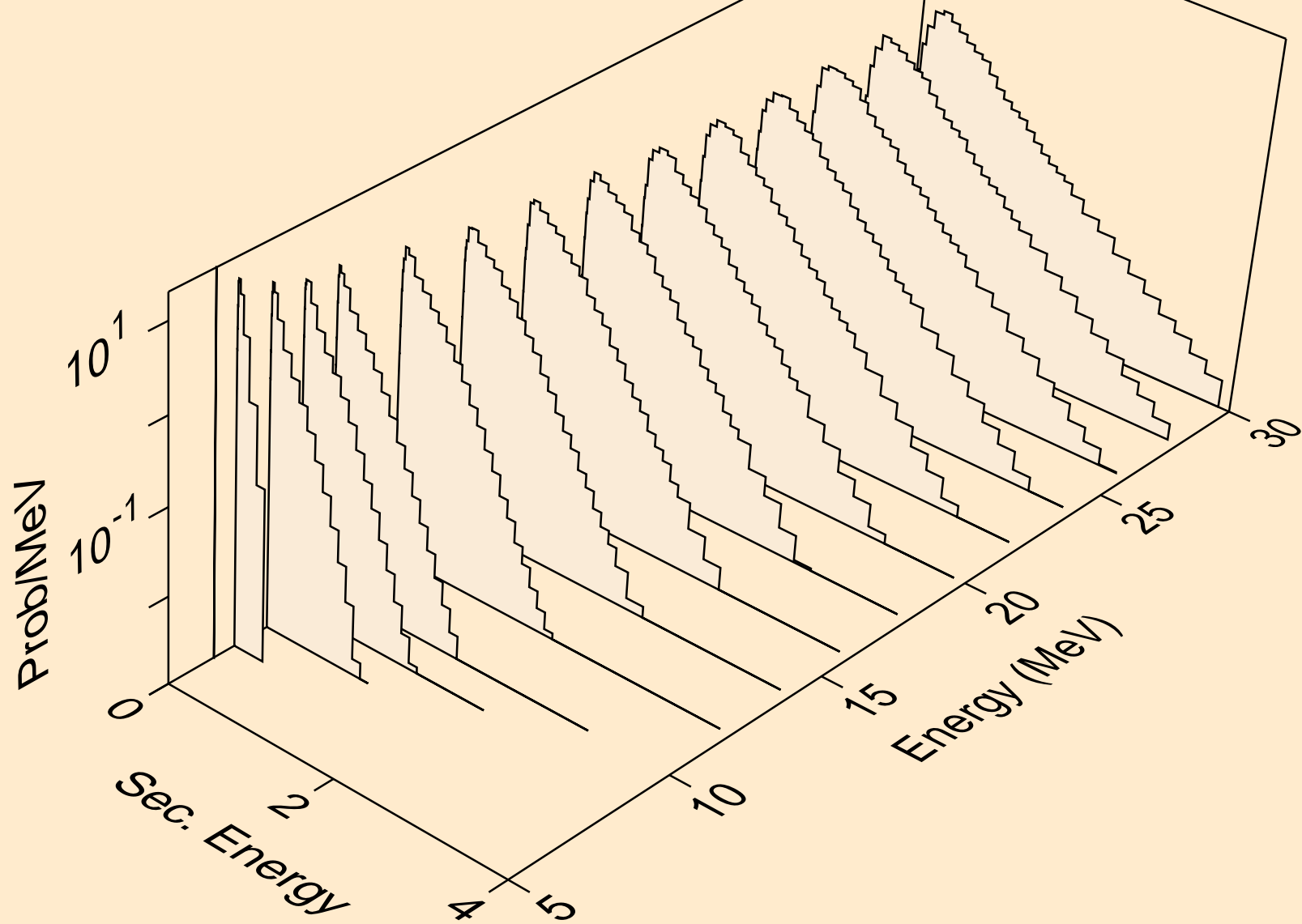

HO164 TRITON ACER TENDL-2021 LIBRARY; T=0.K  
neutrons from (t,n\*)t

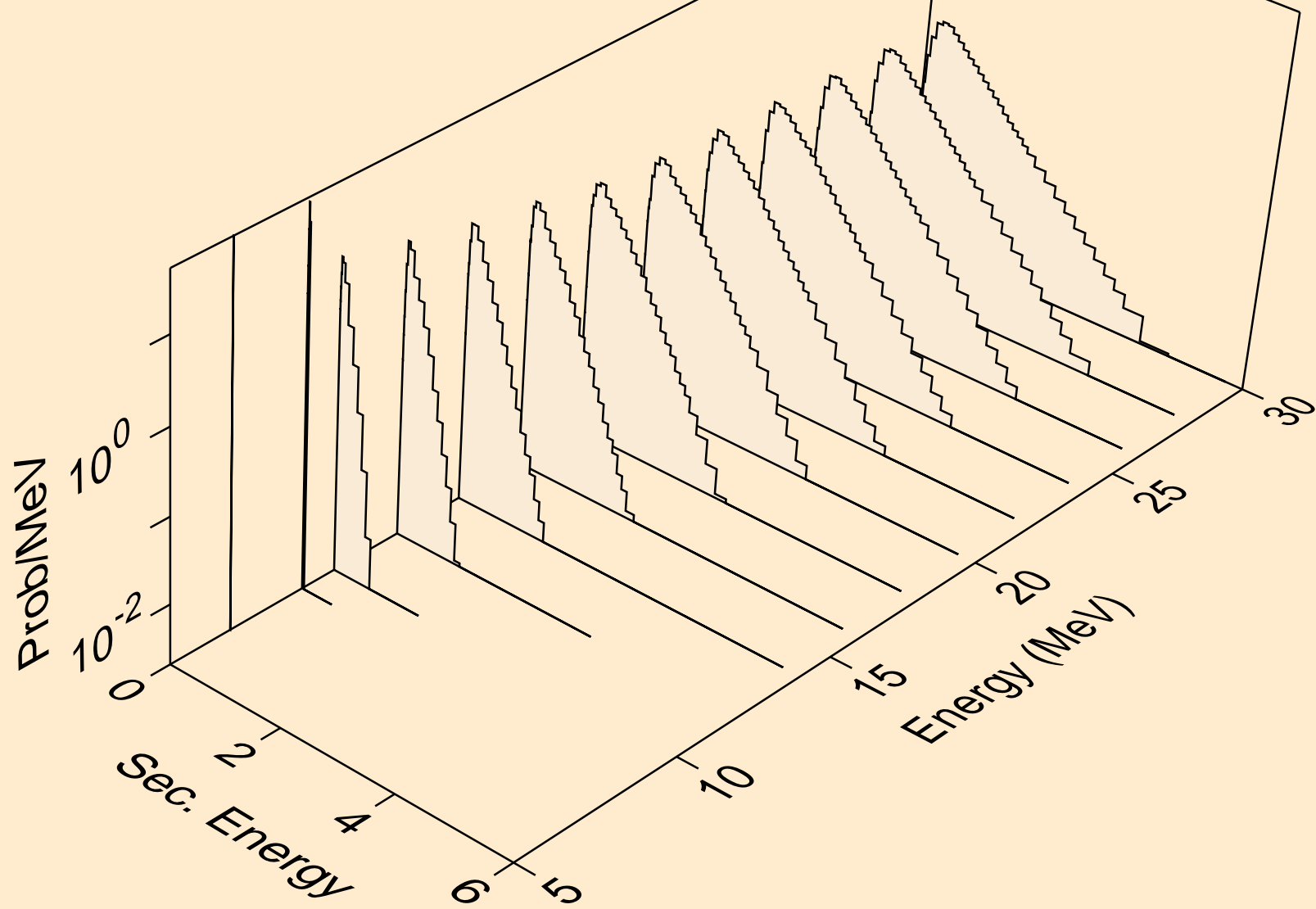

HO164 TRITON ACER TENDL-2021 LIBRARY; T=0.K  
neutrons from (t,n\*)he3

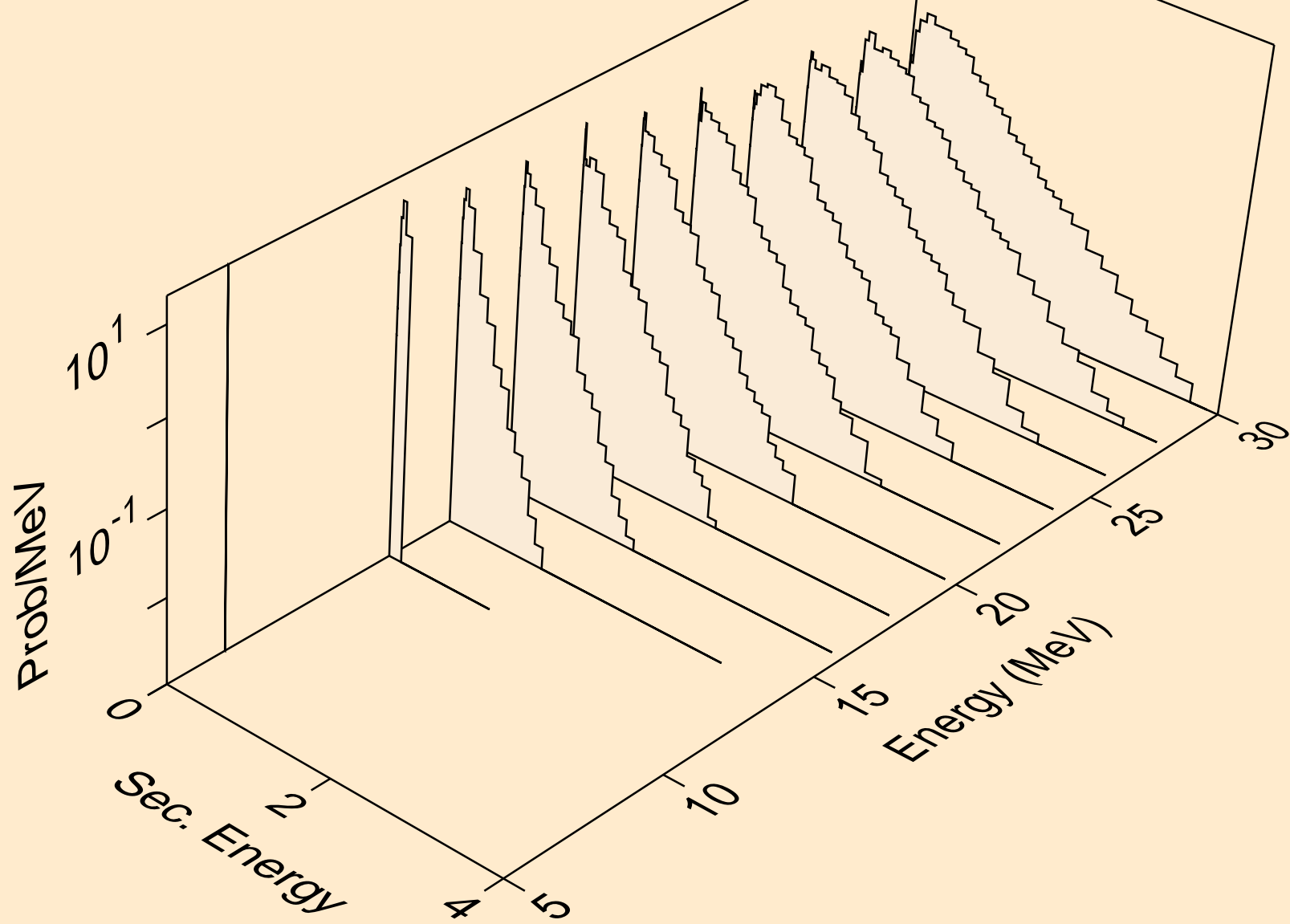

HO164 TRITON ACER TENDL-2021 LIBRARY; T=0.K  
neutrons from (t,4n)

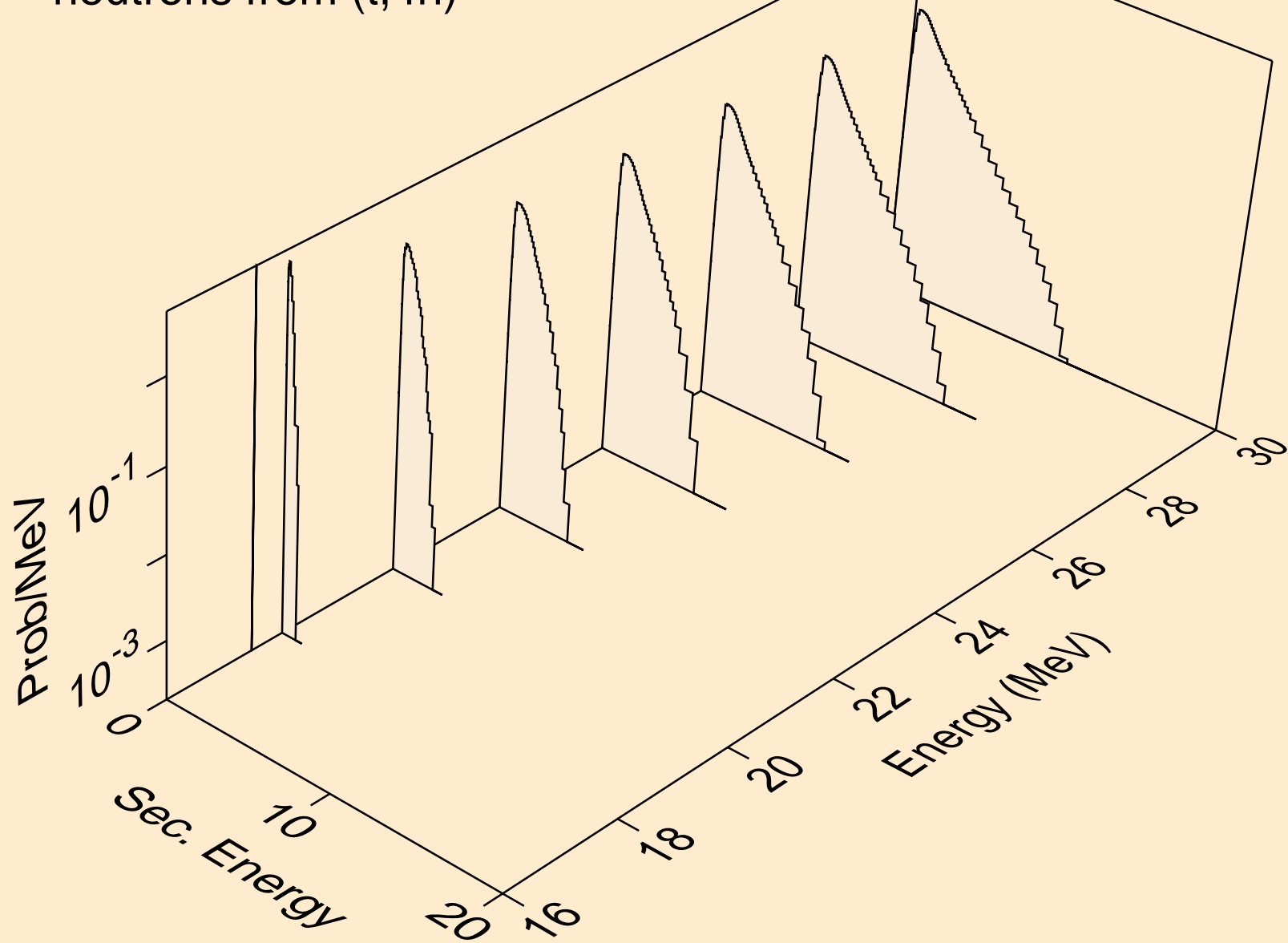

HO164 TRITON ACER TENDL-2021 LIBRARY; T=0.K  
neutrons from (t,2np)

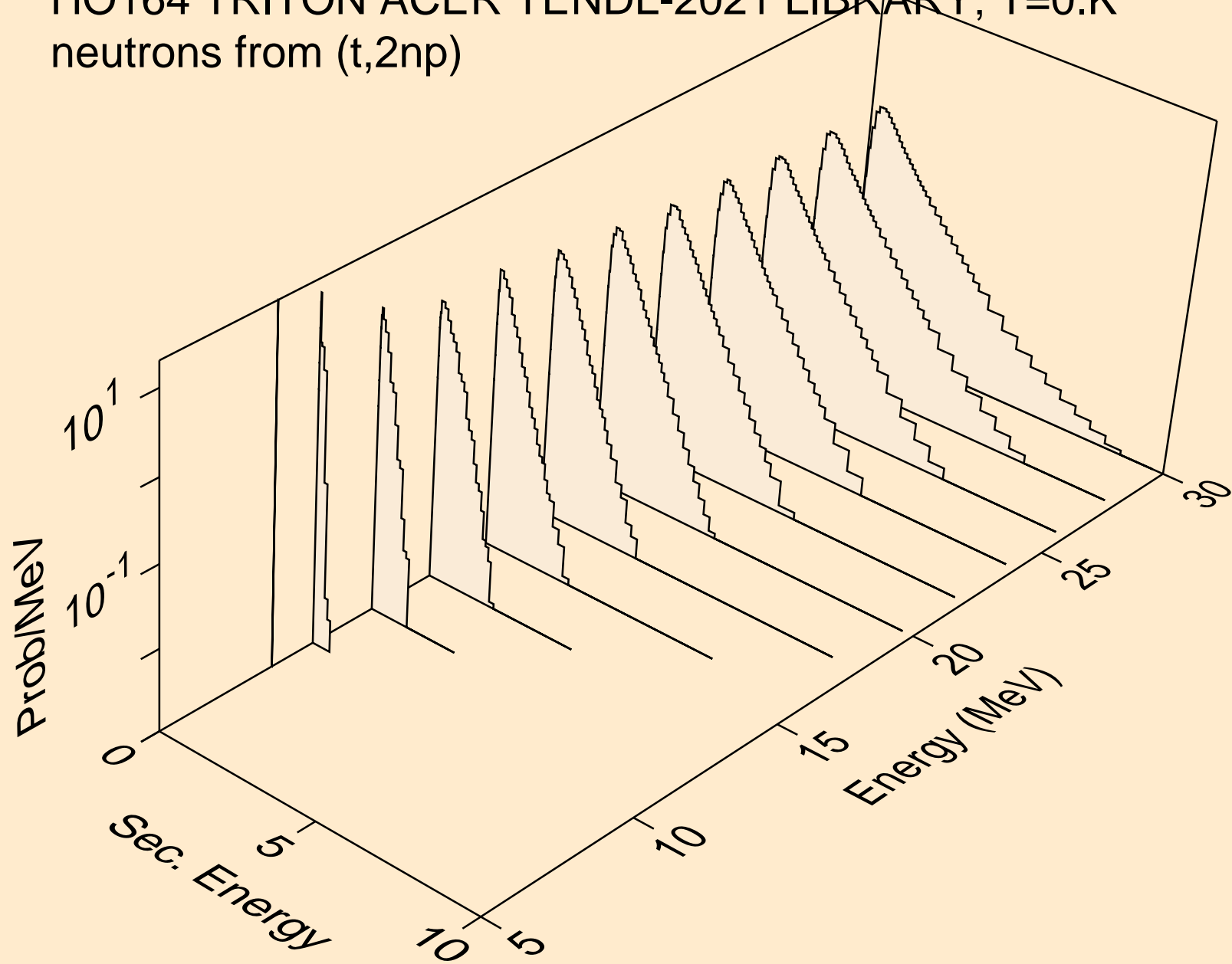

HO164 TRITON ACER TENDL-2021 LIBRARY; T=0.K  
neutrons from (t,3np)

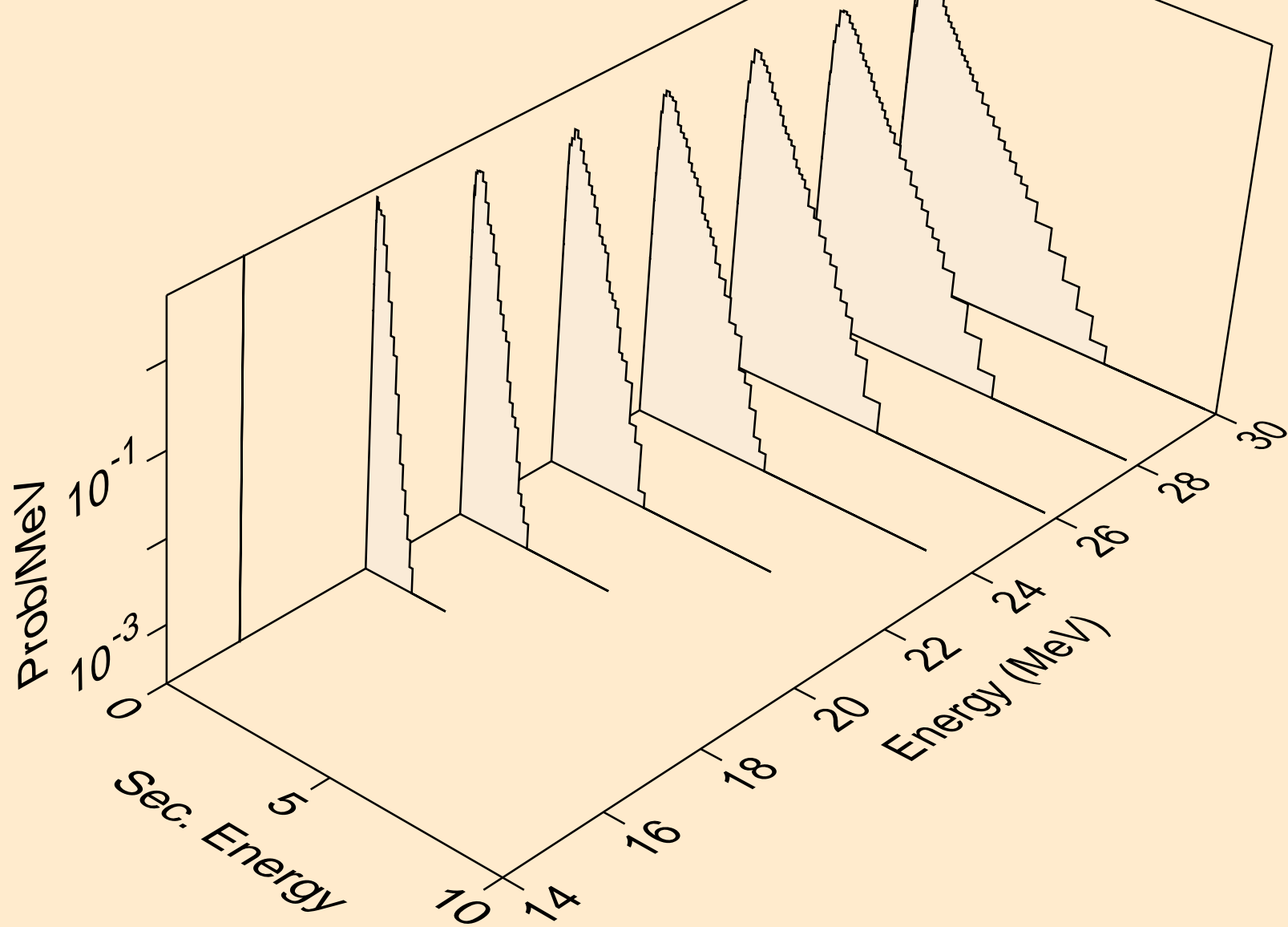



HO164 TRITON ACER TENDL-2021 LIBRARY; T=0.K  
neutrons from (t,2np)

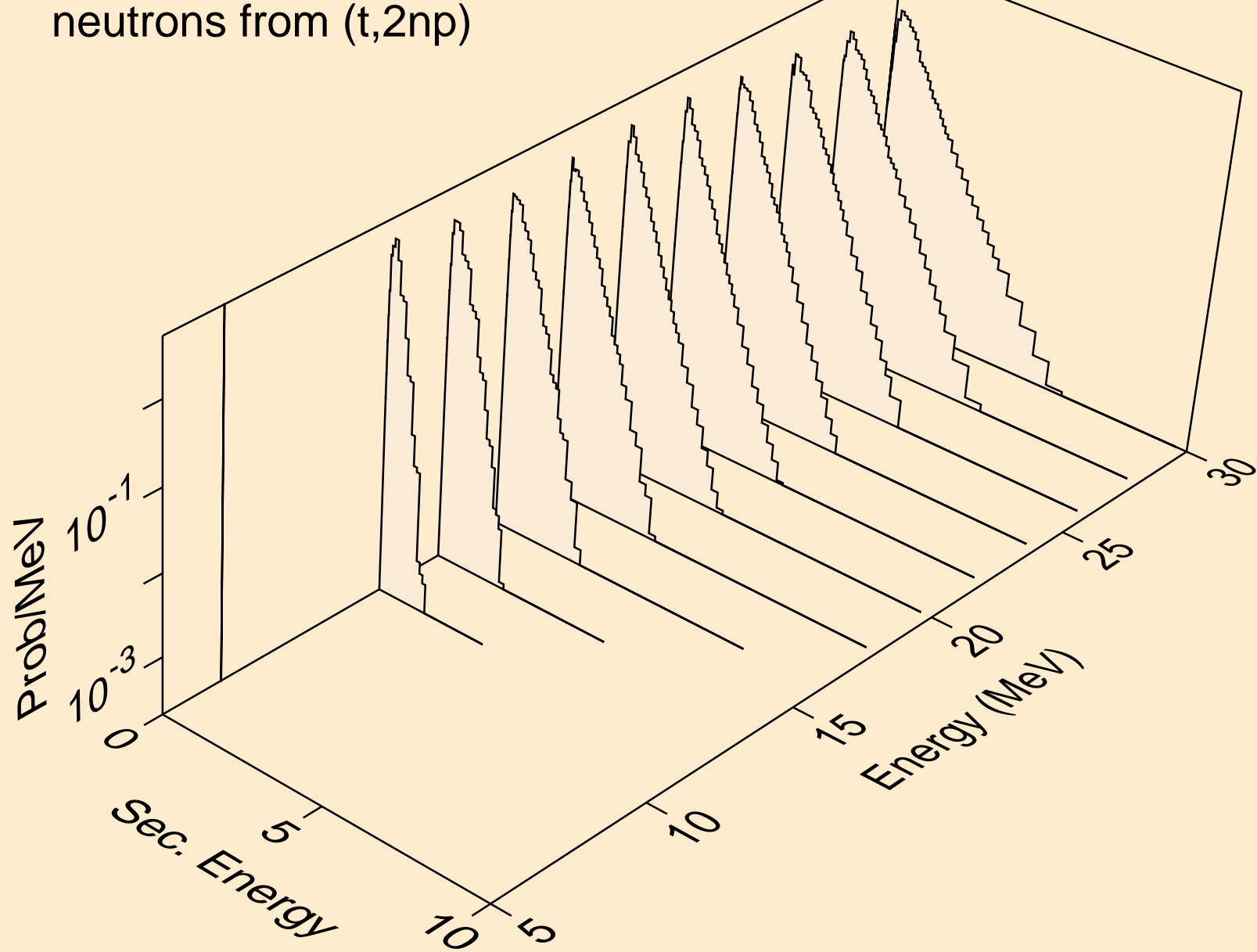

HO164 TRITON ACER TENDL-2021 LIBRARY; T=0.K  
neutrons from (t,npa)

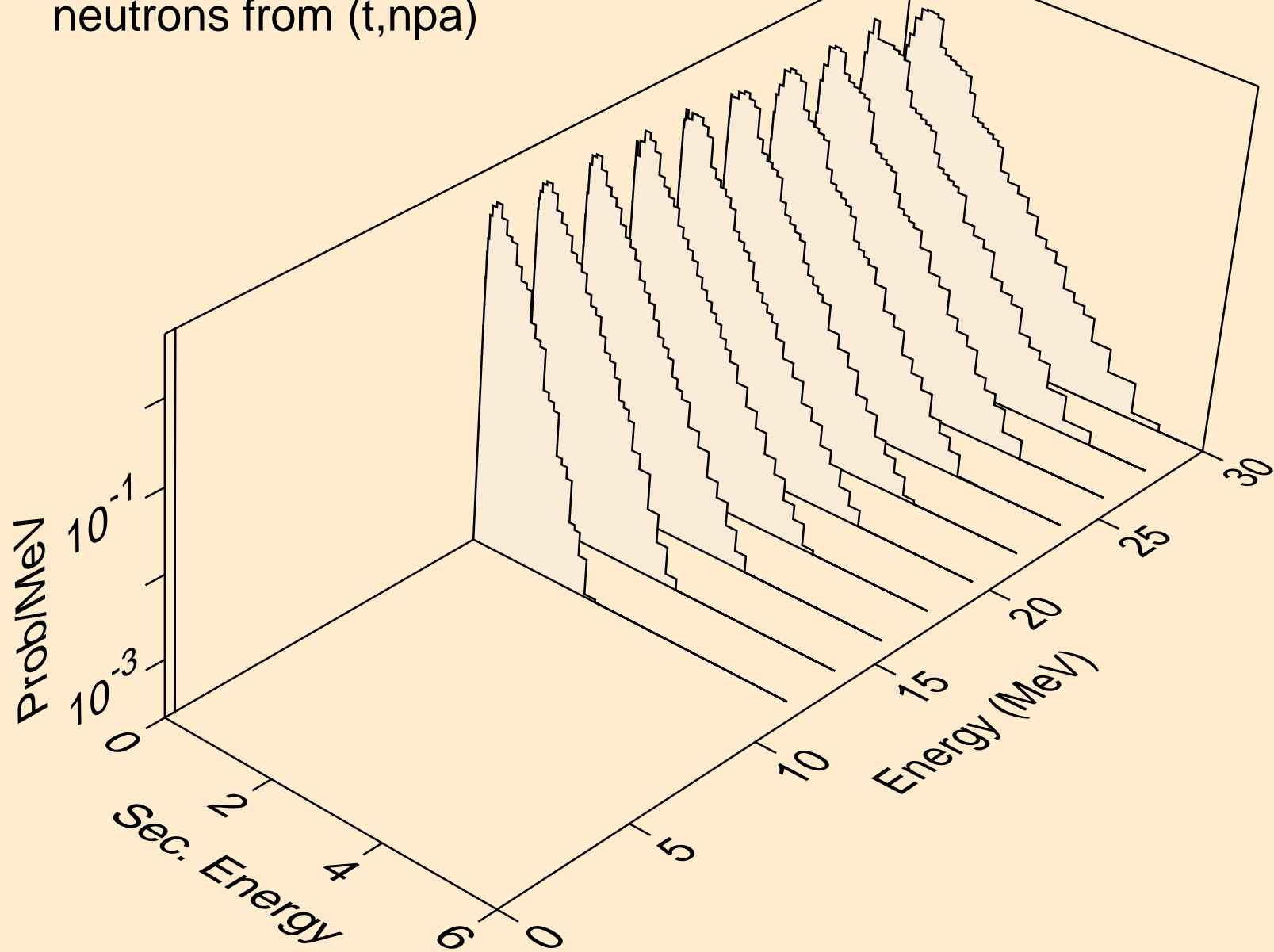

HO164 TRITON ACER TENDL-2021 LIBRARY; T=0.K  
protons from (t,x)

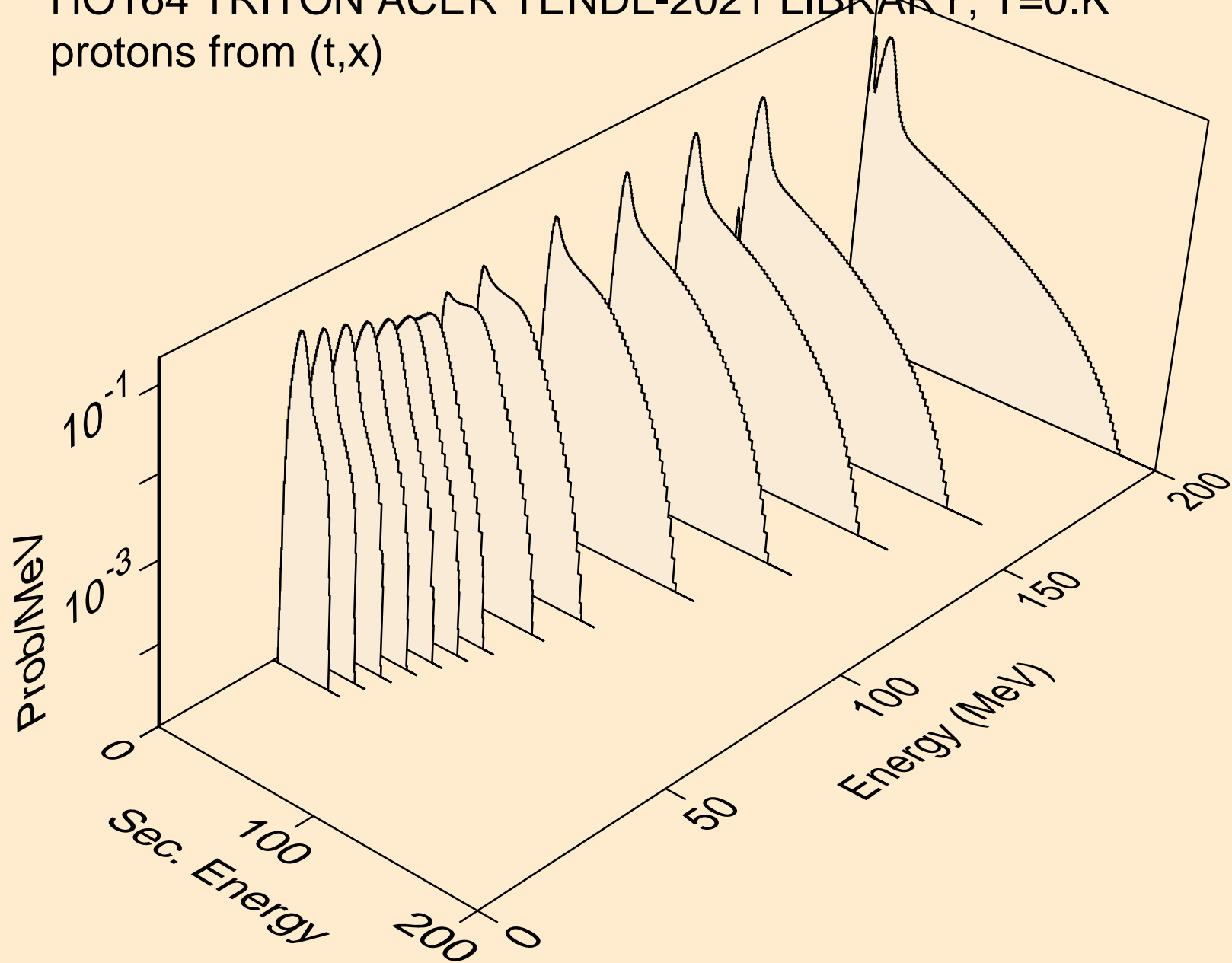

HO164 TRITON ACER TENDL-2021 LIBRARY; T=0.K  
protons from (t,n\*)p

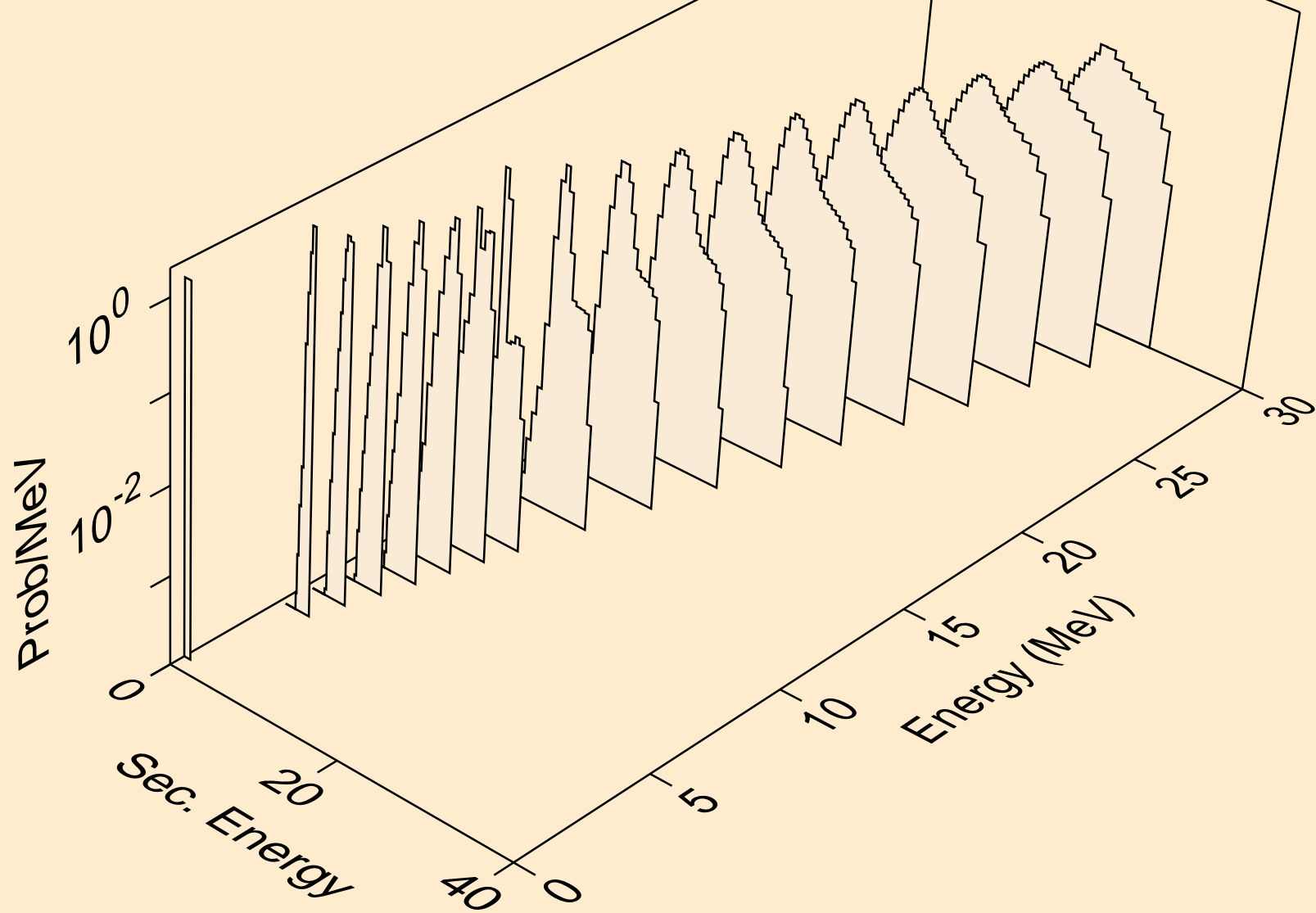

HO164 TRITON ACER TENDL-2021 LIBRARY; T=0.K  
protons from (t,2np)

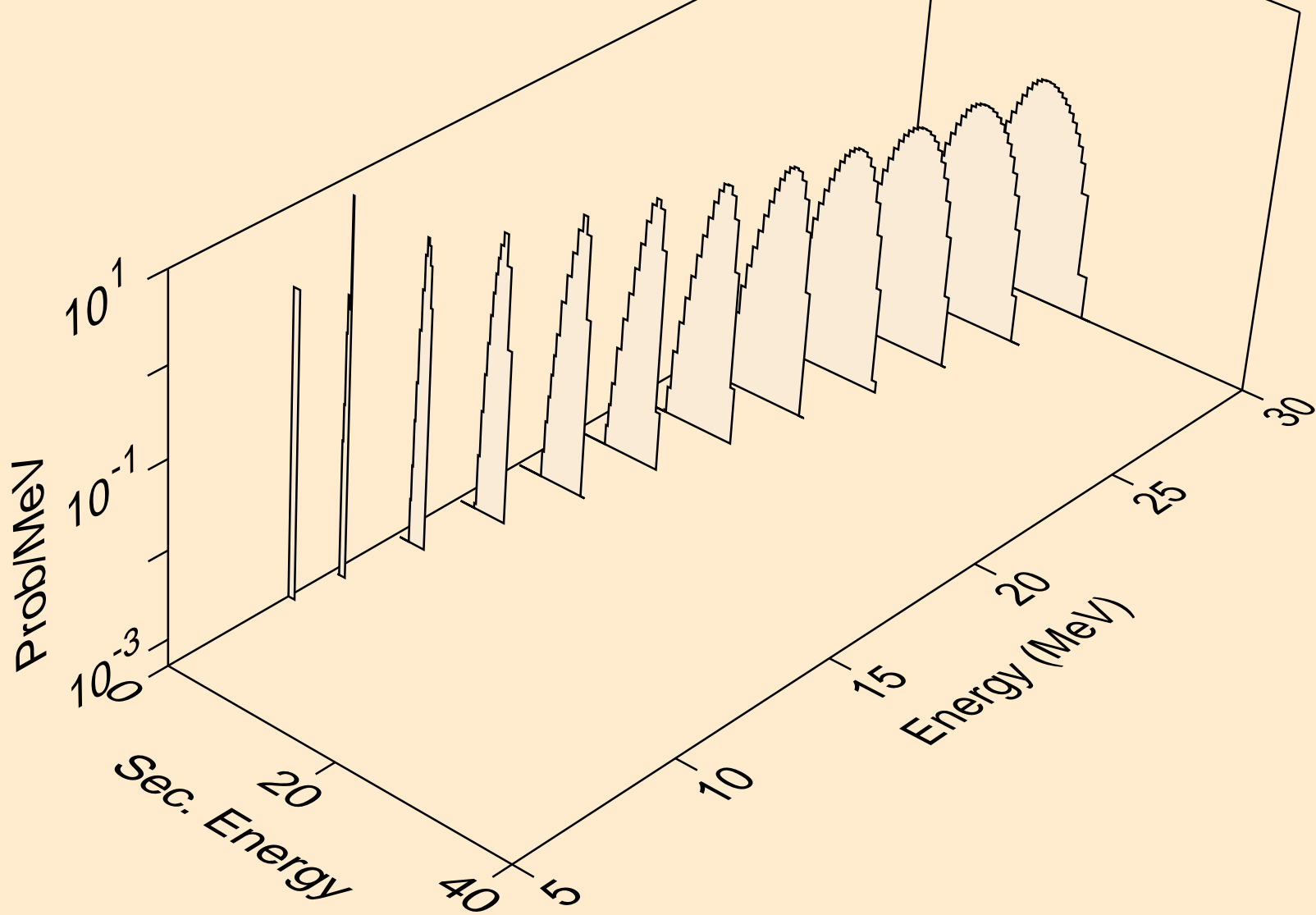

HO164 TRITON ACER TENDL-2021 LIBRARY; T=0.K  
protons from (t,3np)

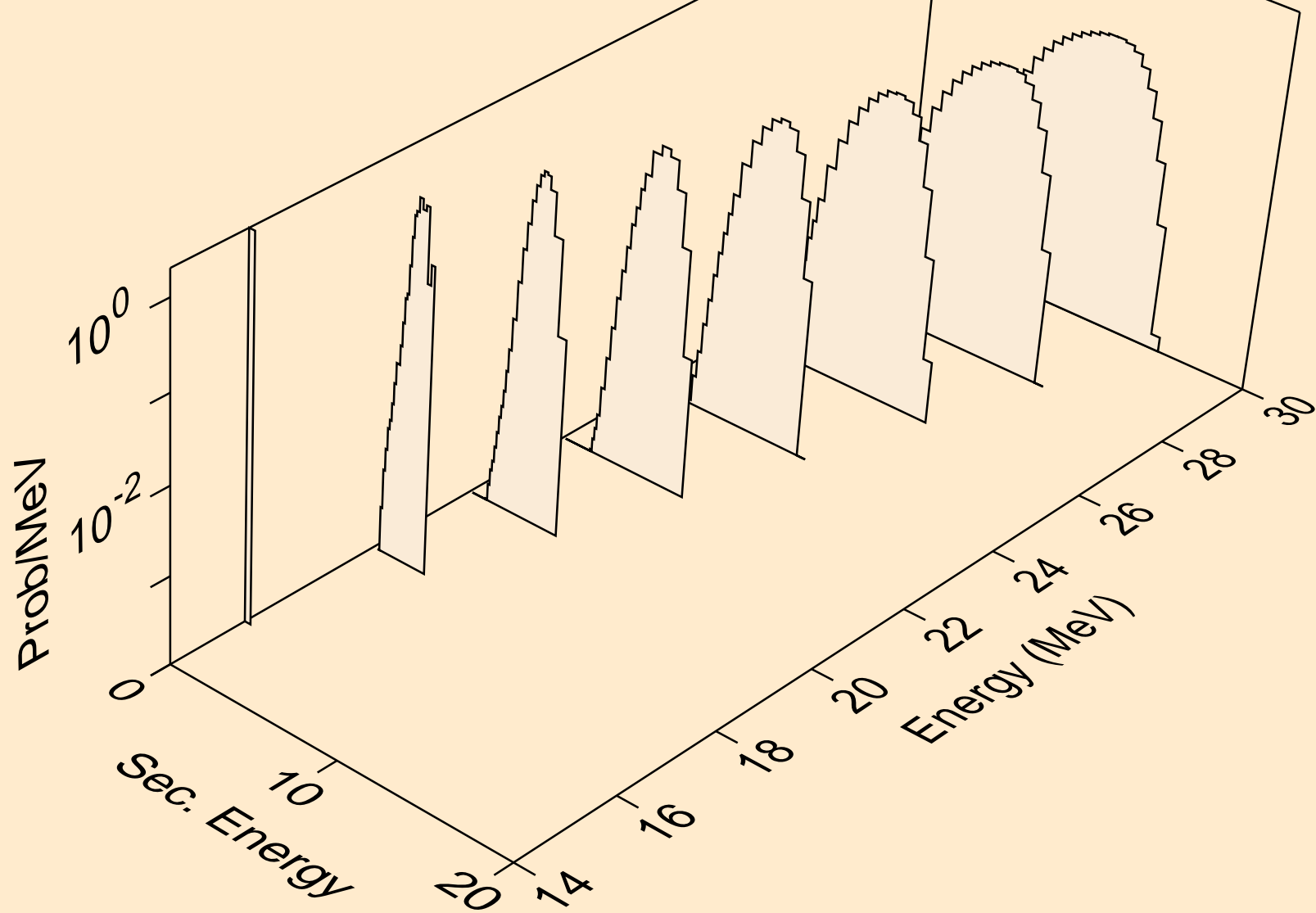

HO164 TRITON ACER TENDL-2021 LIBRARY; T=0.K  
protons from (t,2np)

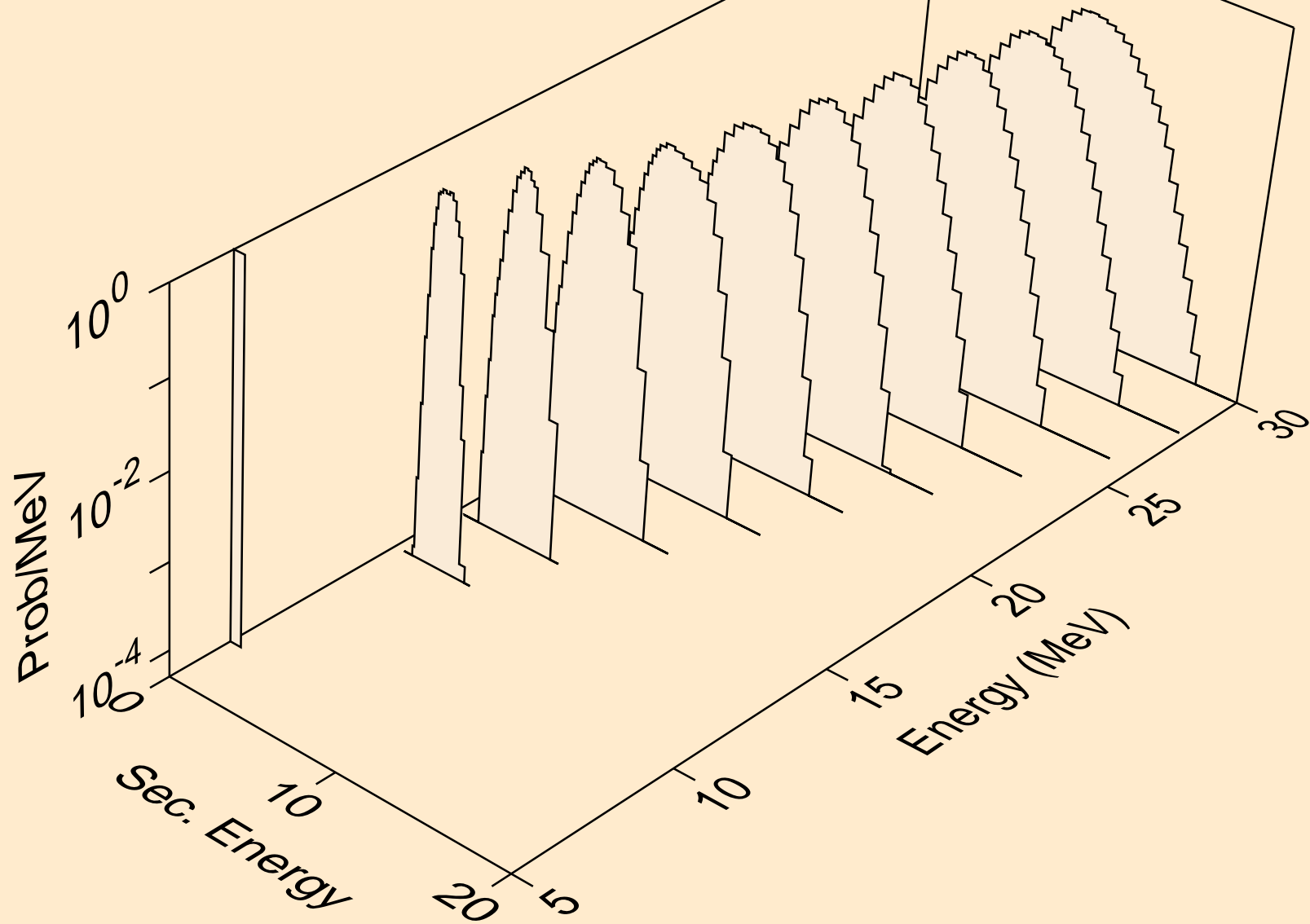

HO164 TRITON ACER TENDL-2021 LIBRARY; T=0.K  
protons from (t,npa)

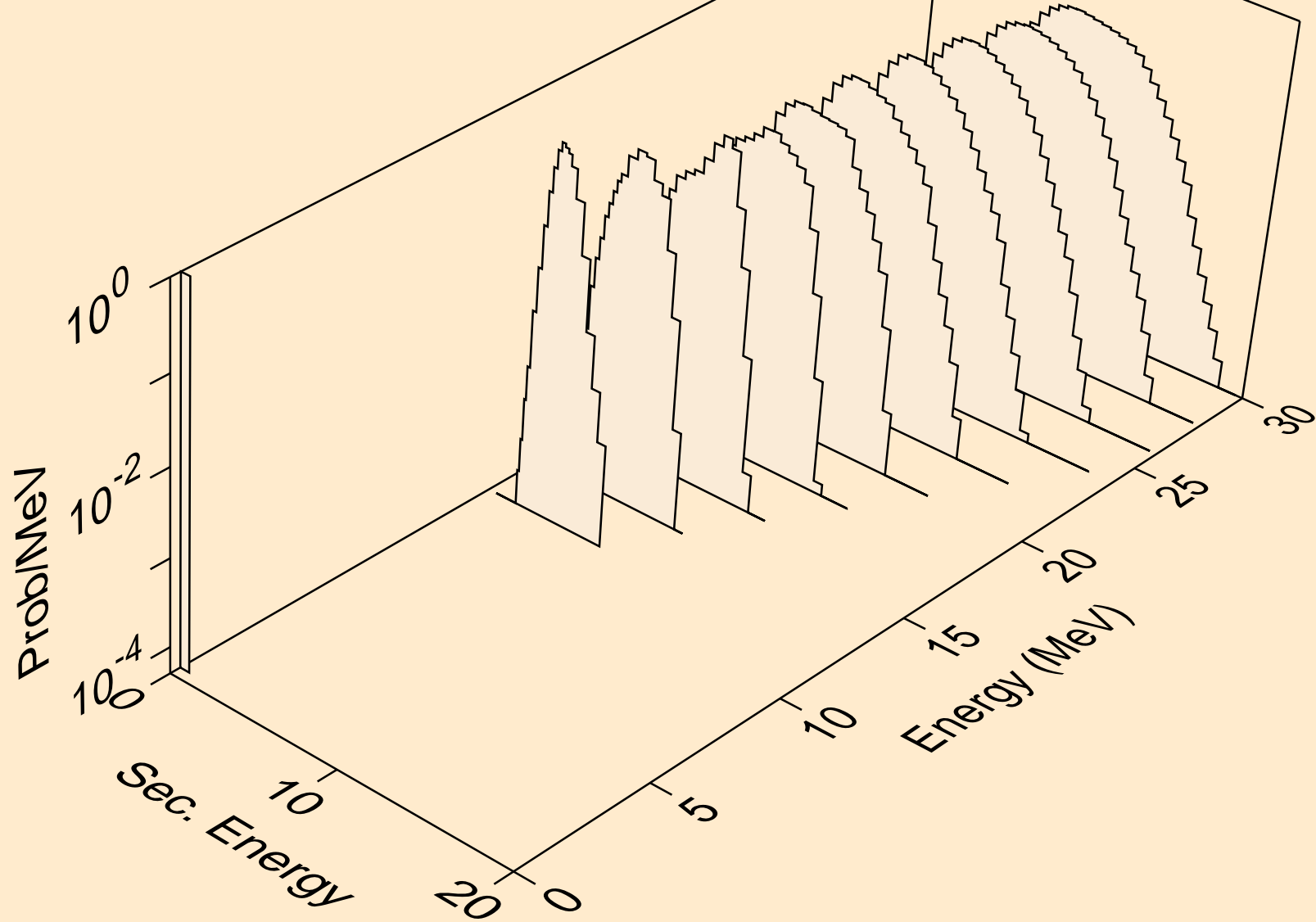



HO164 TRITON ACER TENDL-2021 LIBRARY; T=0.K  
protons from (t,p)

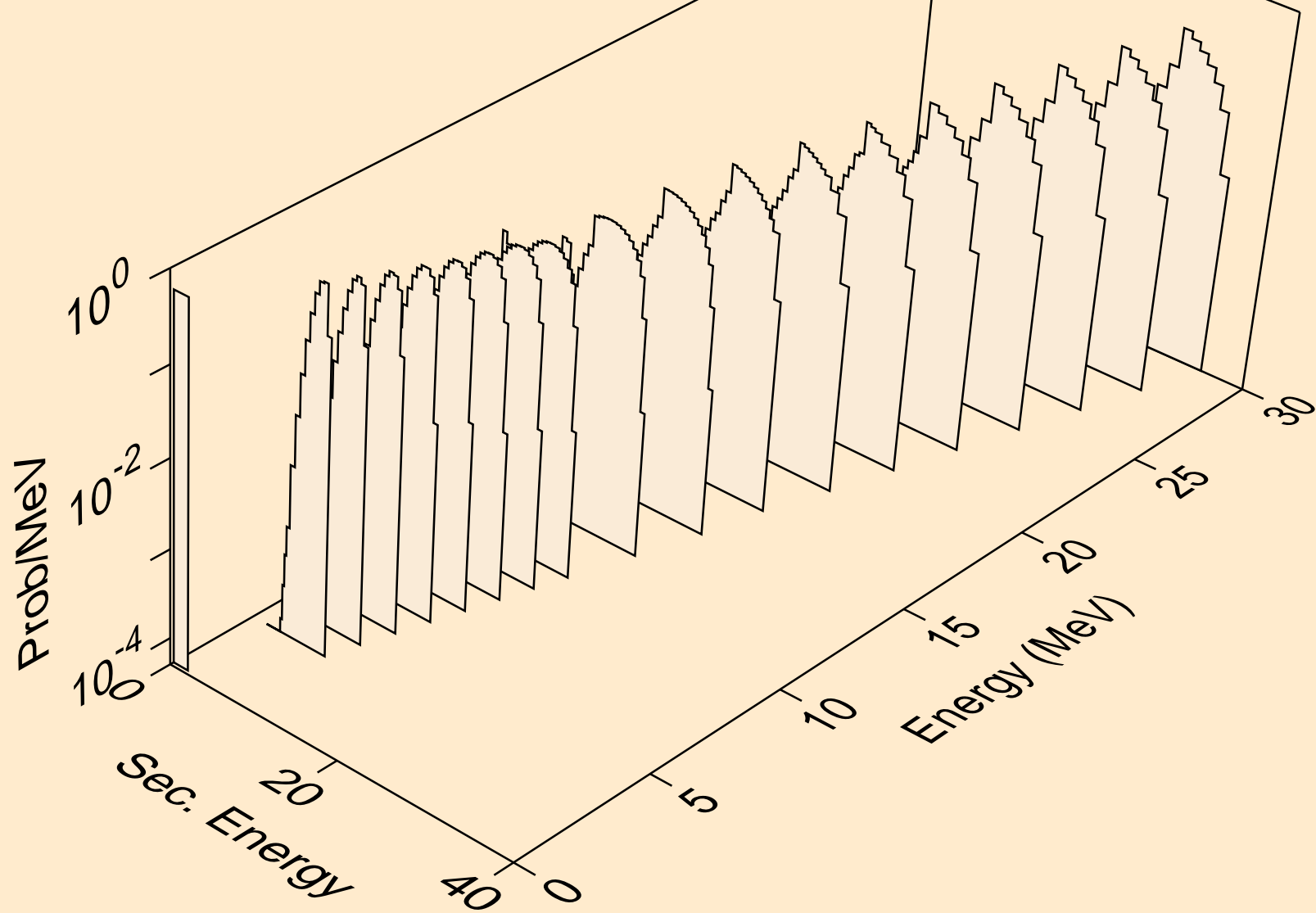

HO164 TRITON ACER TENDL-2021 LIBRARY; T=0.K  
protons from (t,2p)

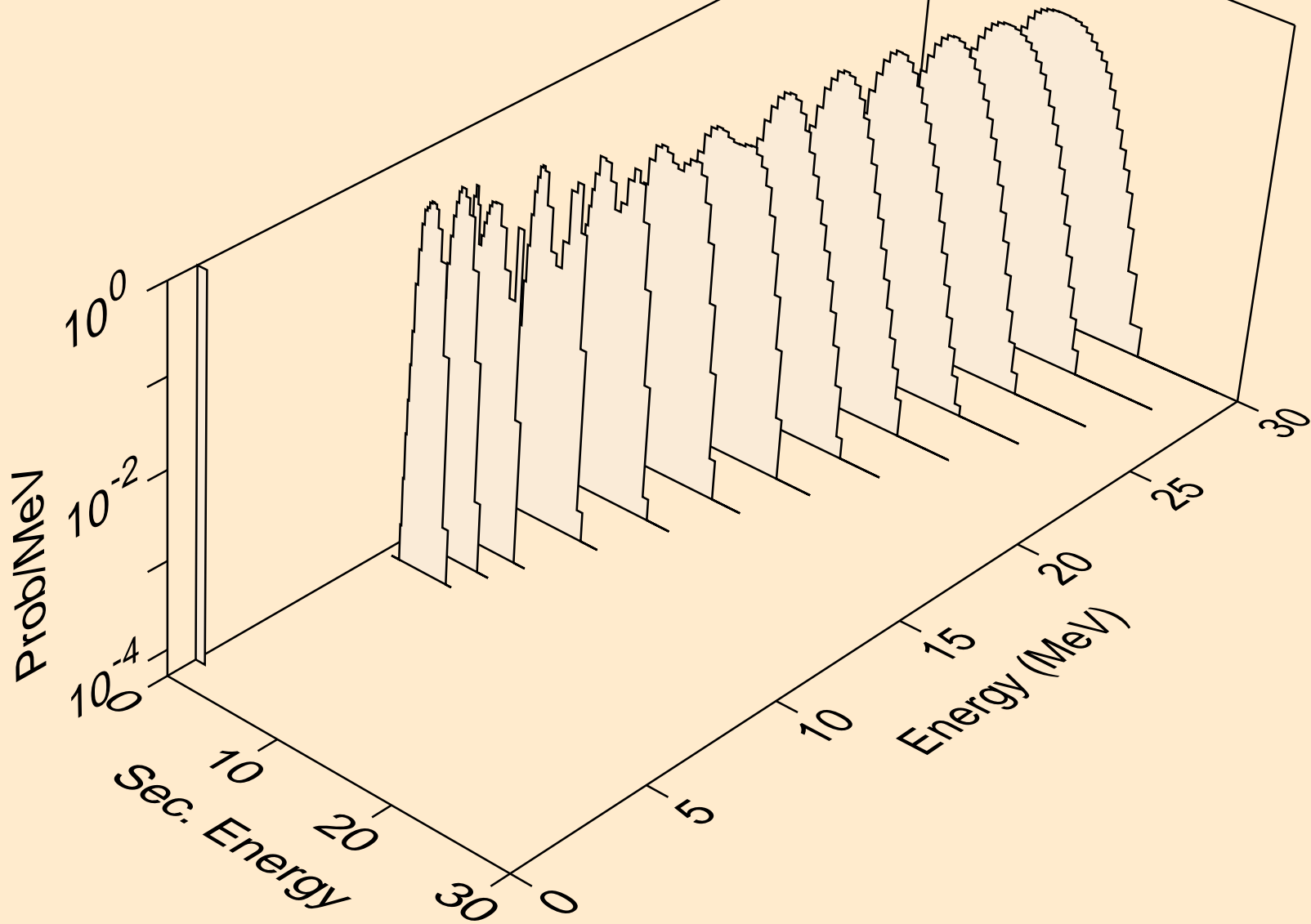

HO164 TRITON ACER TENDL-2021 LIBRARY; T=0.K  
protons from (t,pa)

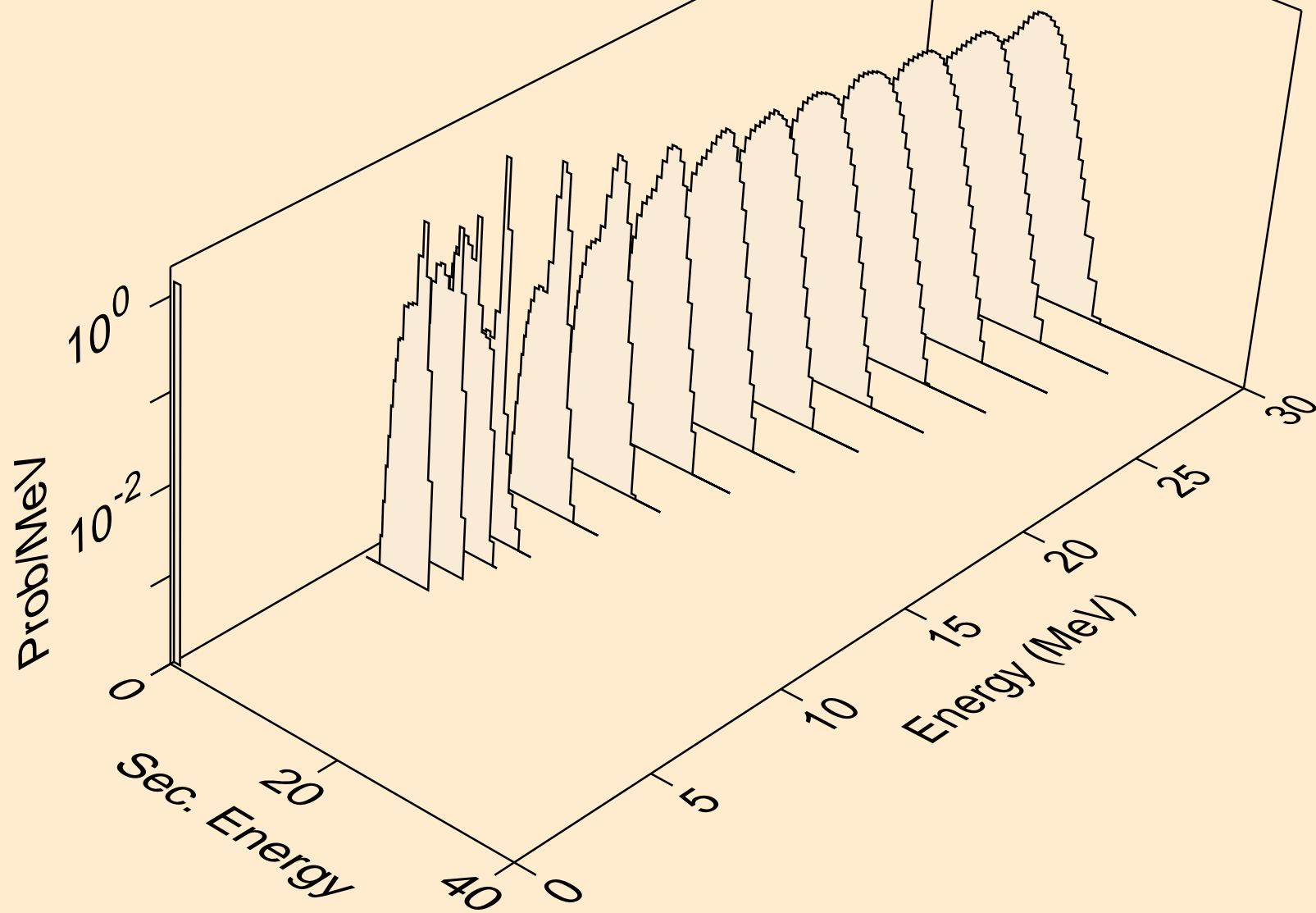

HO164 TRITON ACER TENDL-2021 LIBRARY; T=0.K  
protons from (t,pd)

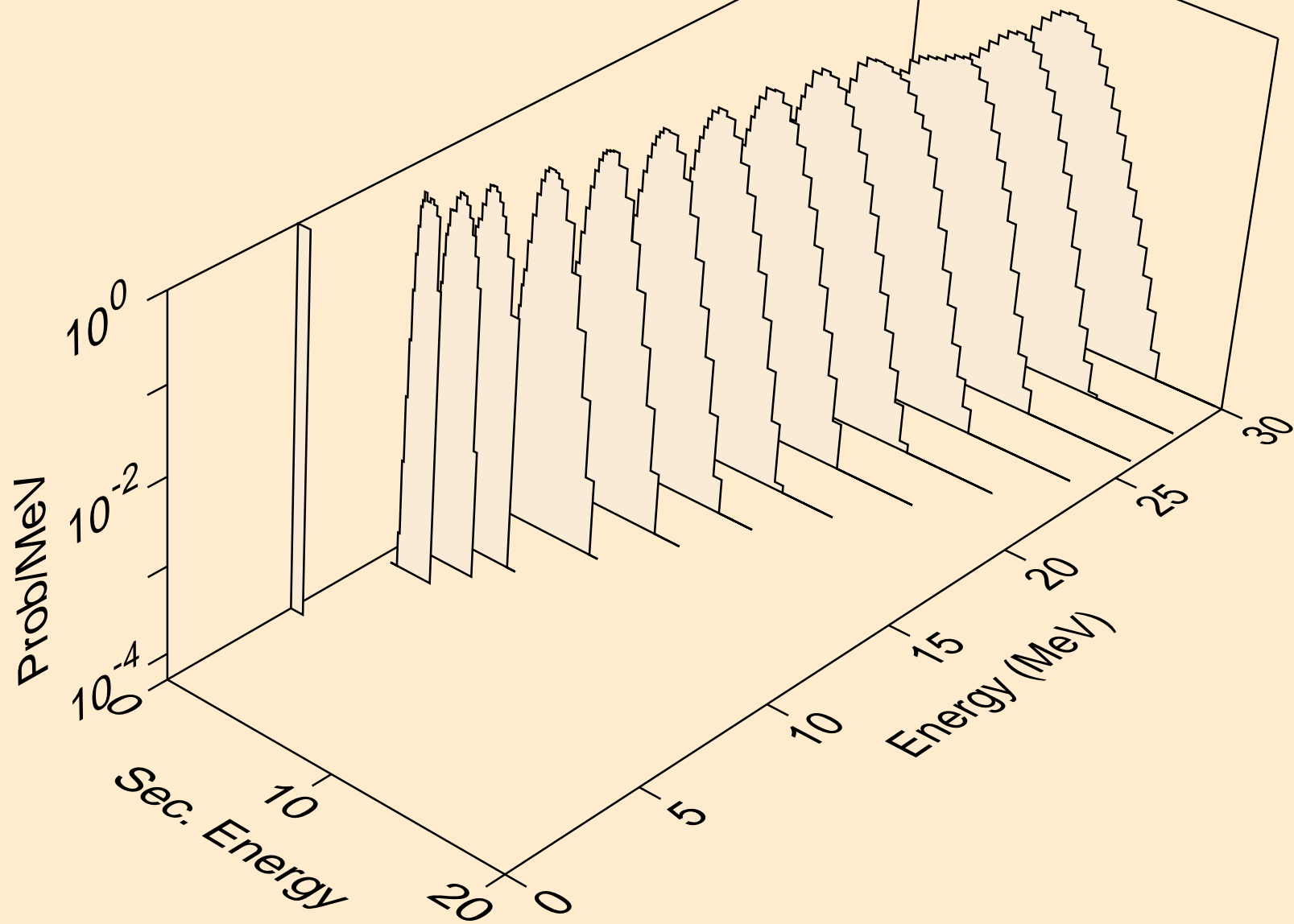

HO164 TRITON ACER TENDL-2021 LIBRARY; T=0.K  
protons from (t,pt)

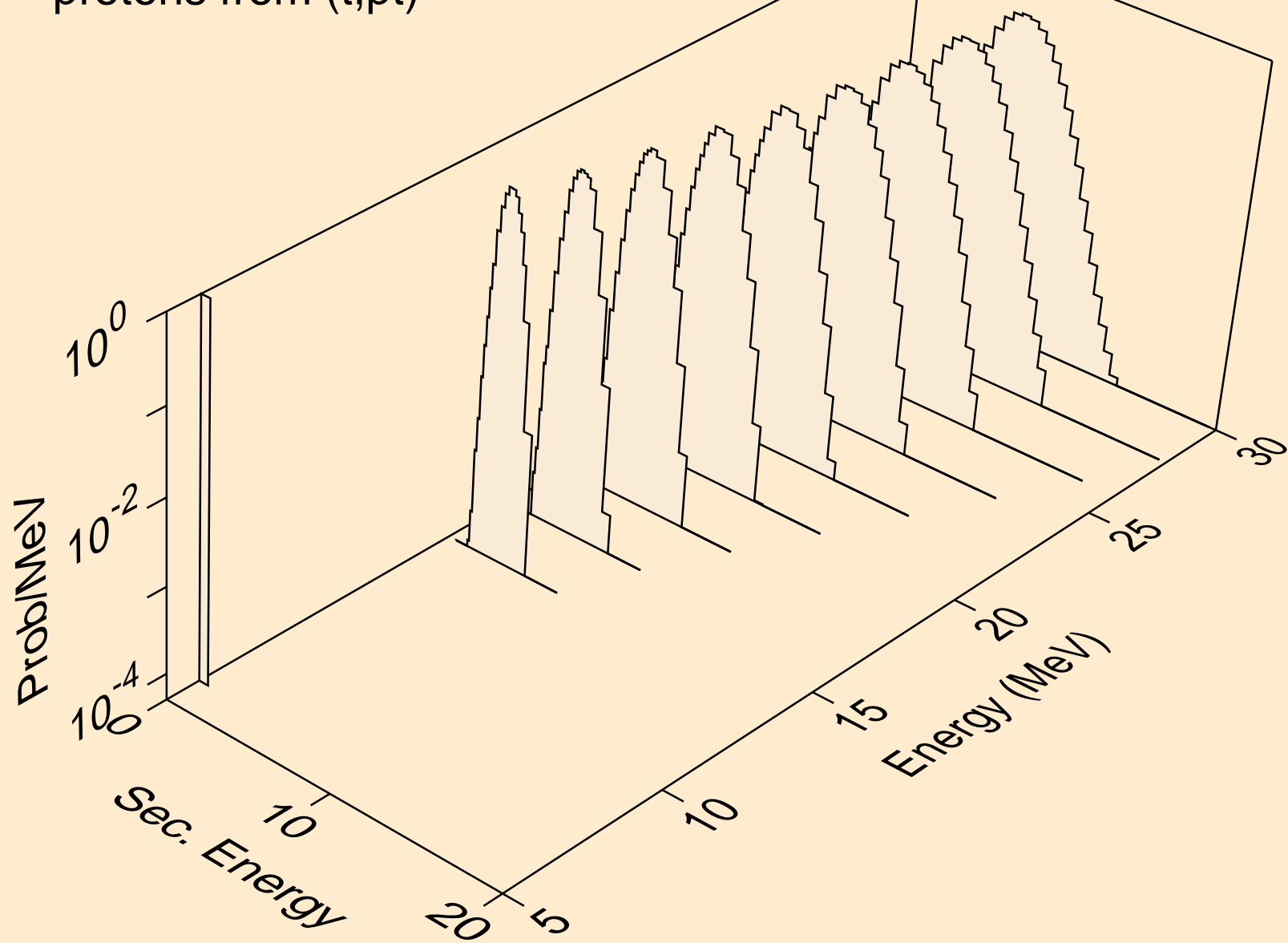

HO164 TRITON ACER TENDL-2021 LIBRARY; T=0.K  
deuterons from (t,x)

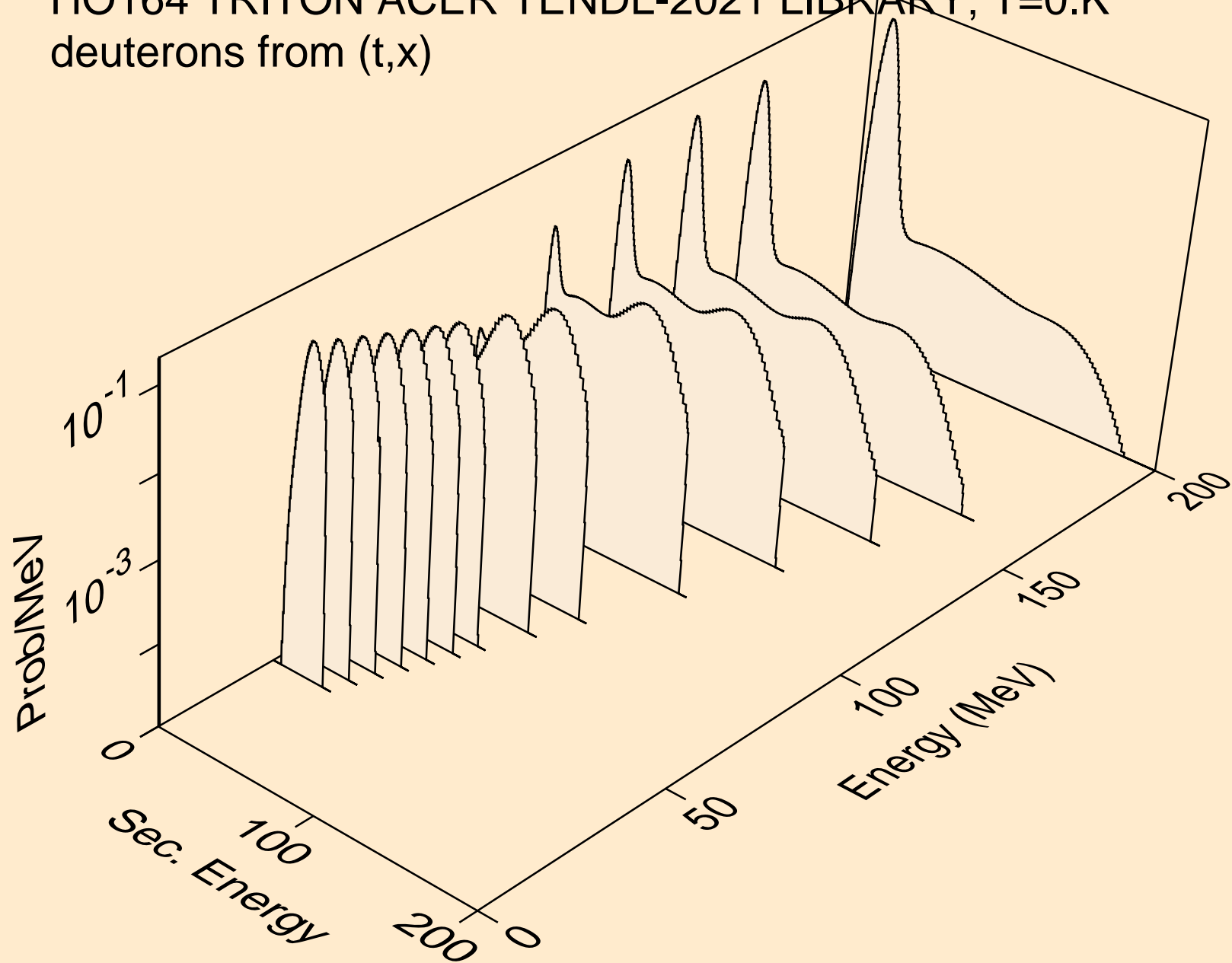

HO164 TRITON ACER TENDL-2021 LIBRARY; T=0.K  
deuterons from (t,2nd)

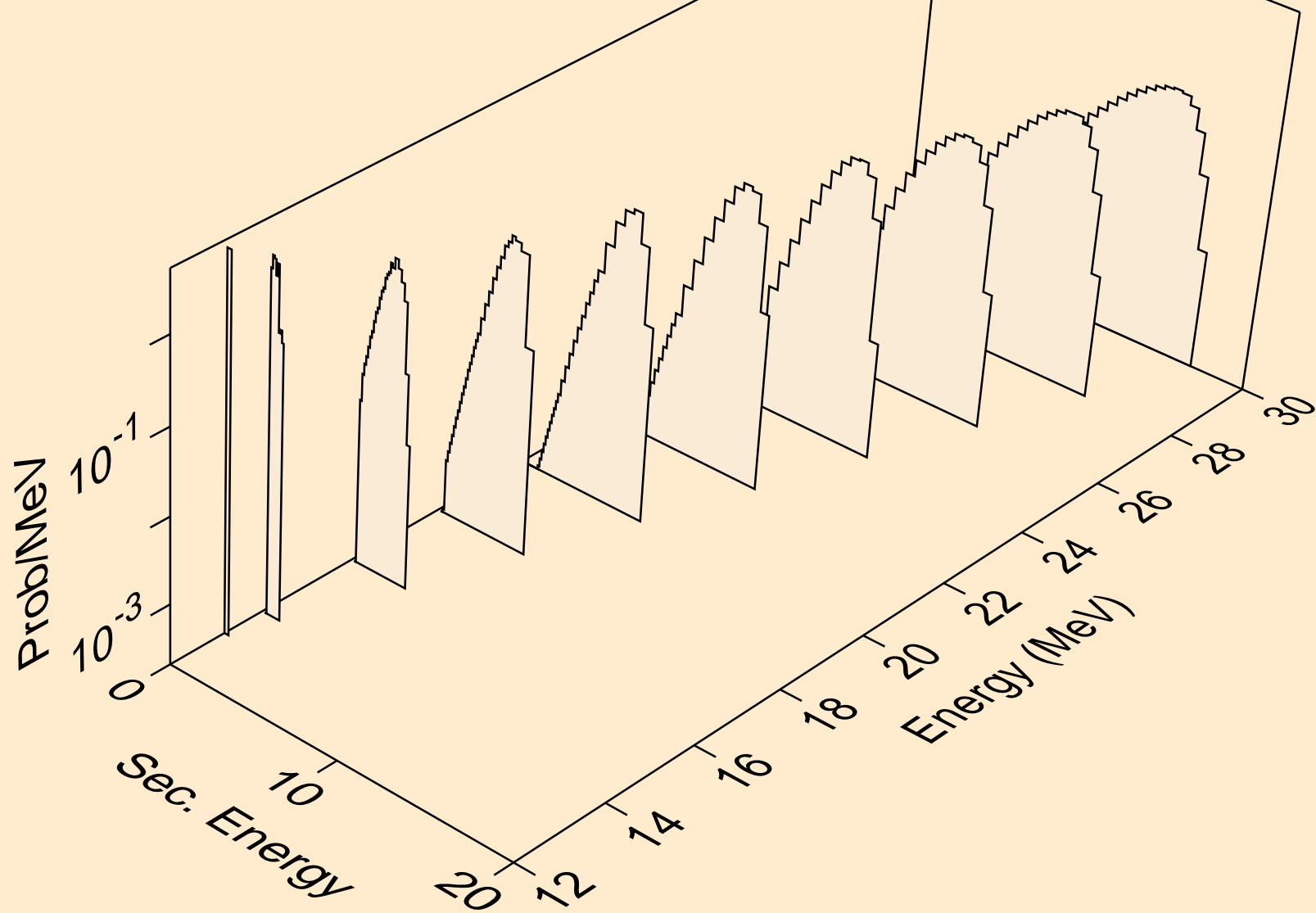

HO164 TRITON ACER TENDL-2021 LIBRARY; T=0.K  
deuterons from (t,n\*)d

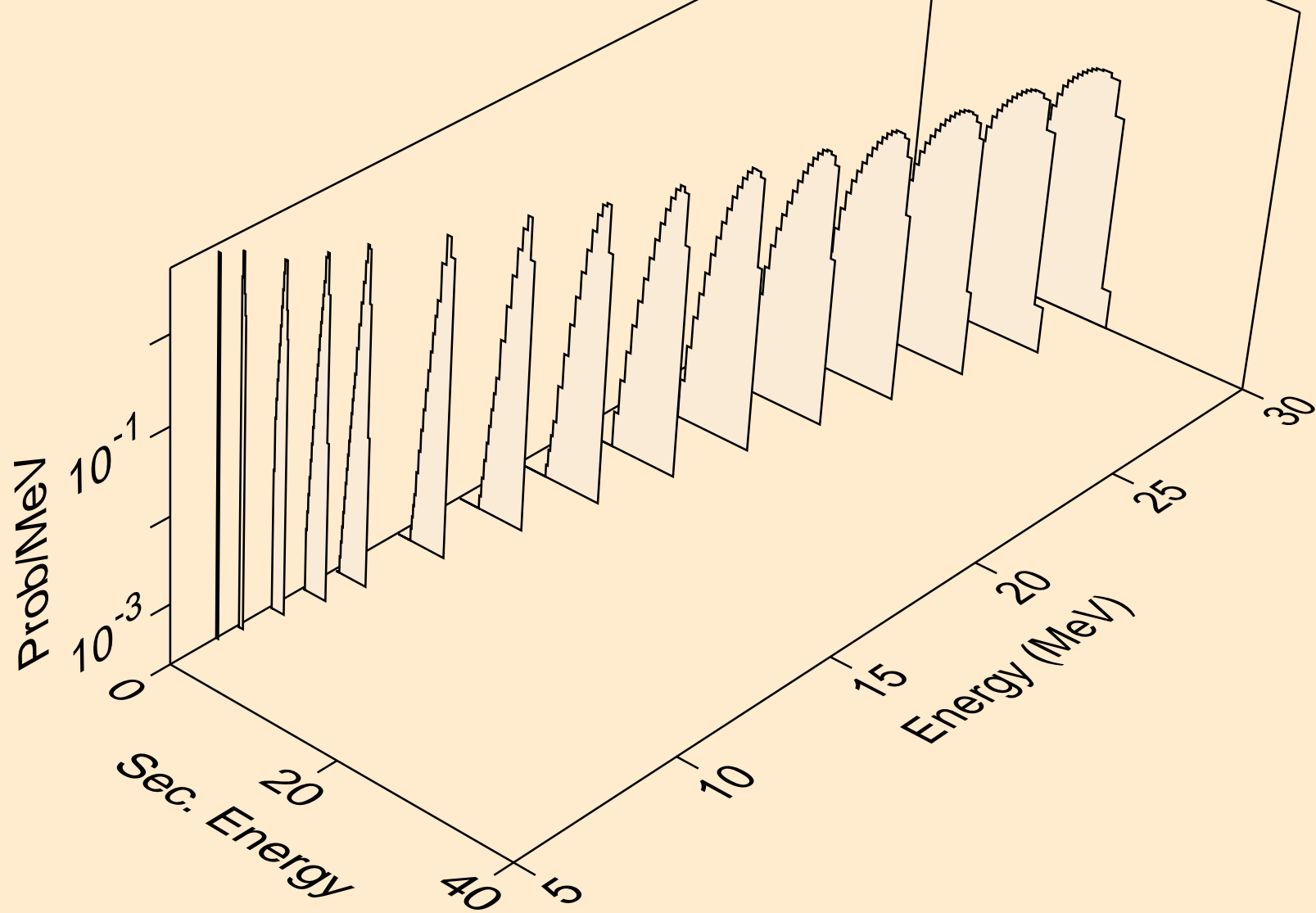



HO164 TRITON ACER TENDL-2021 LIBRARY; T=0.K  
deuterons from (t,d)

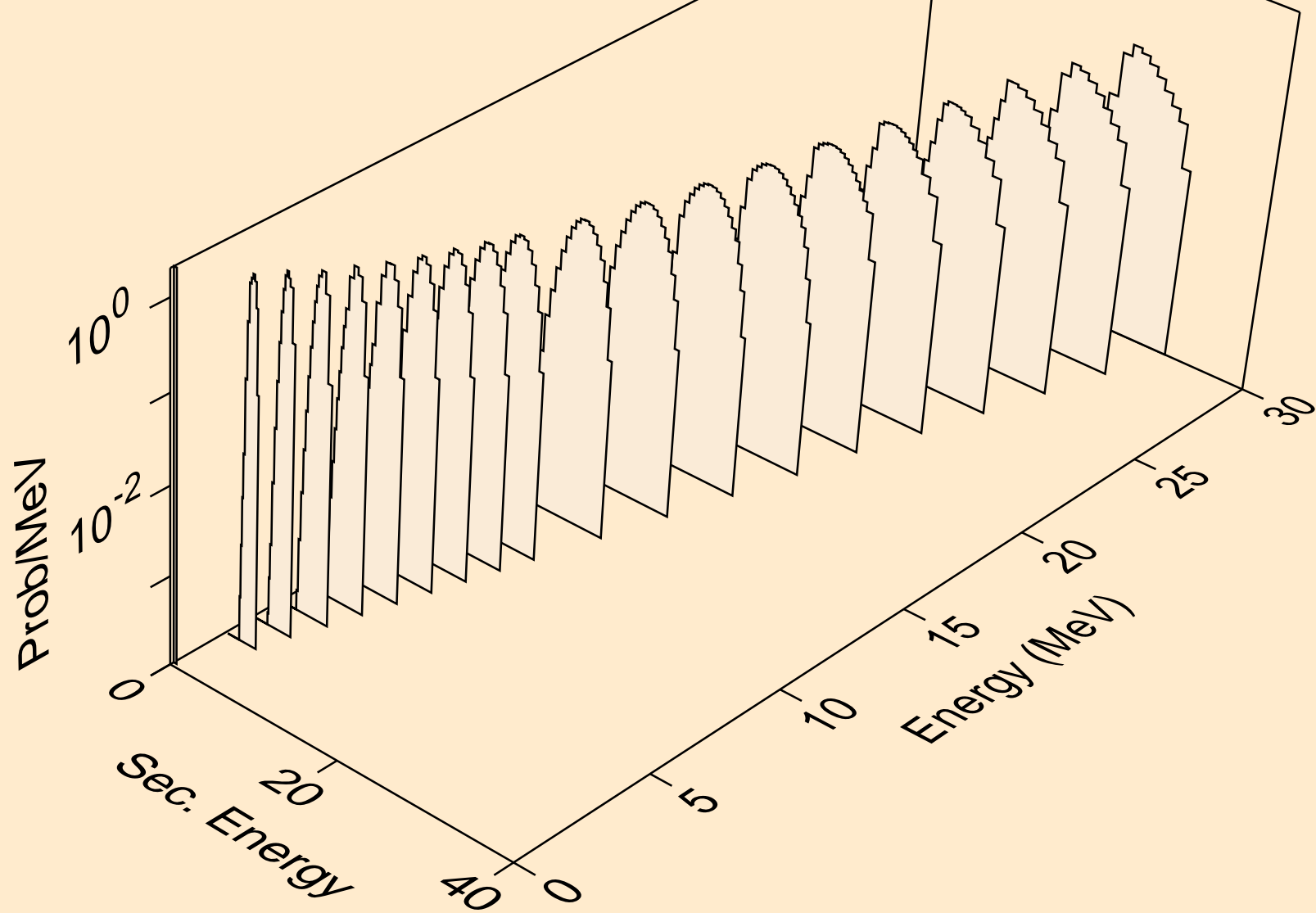

HO164 TRITON ACER TENDL-2021 LIBRARY; T=0.K  
deuterons from (t,pd)

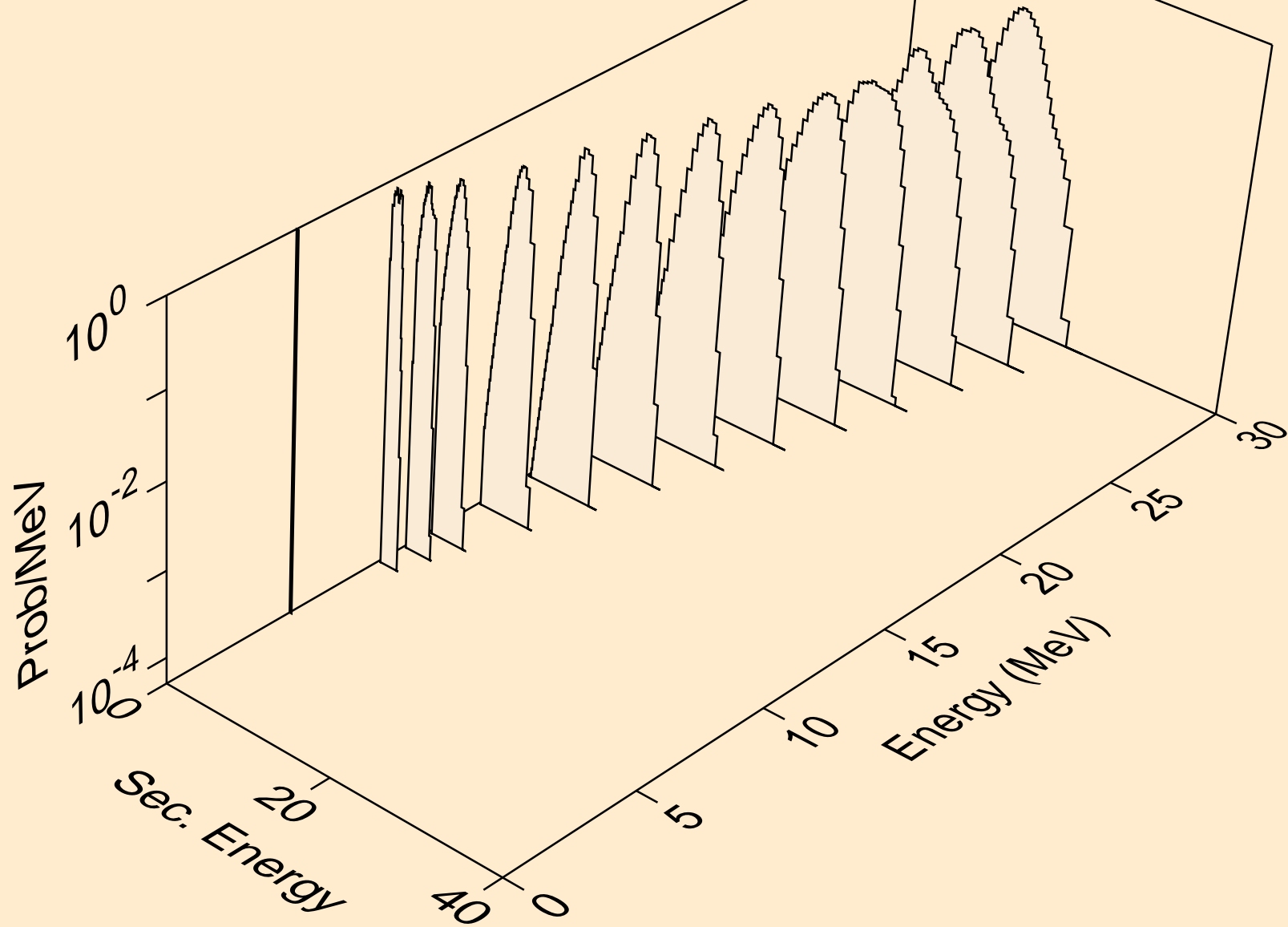

HO164 TRITON ACER TENDL-2021 LIBRARY; T=0.K  
deuterons from (t,da)

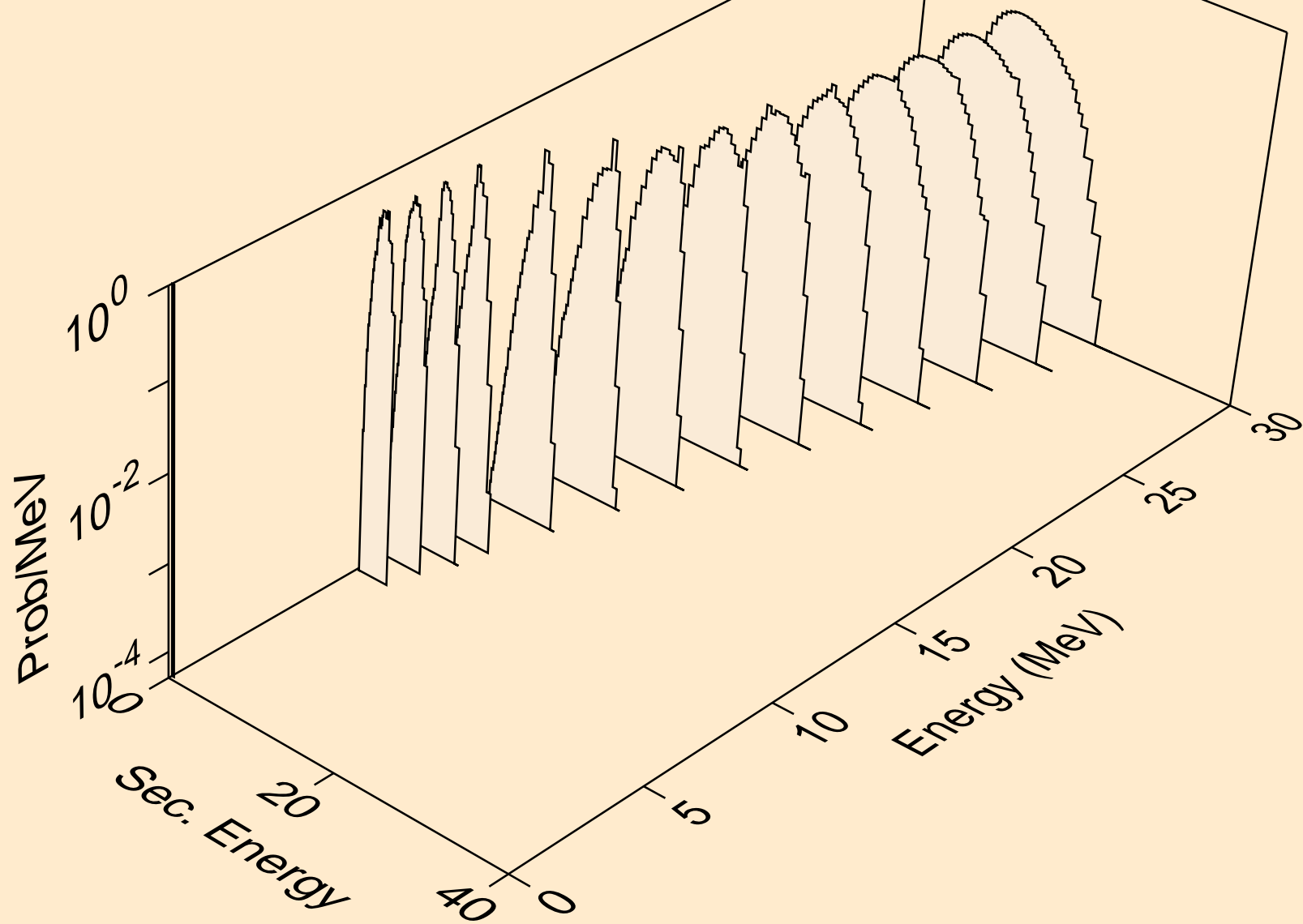

HO164 TRITON ACER TENDL-2021 LIBRARY; T=0.K  
he3s from (t,x)

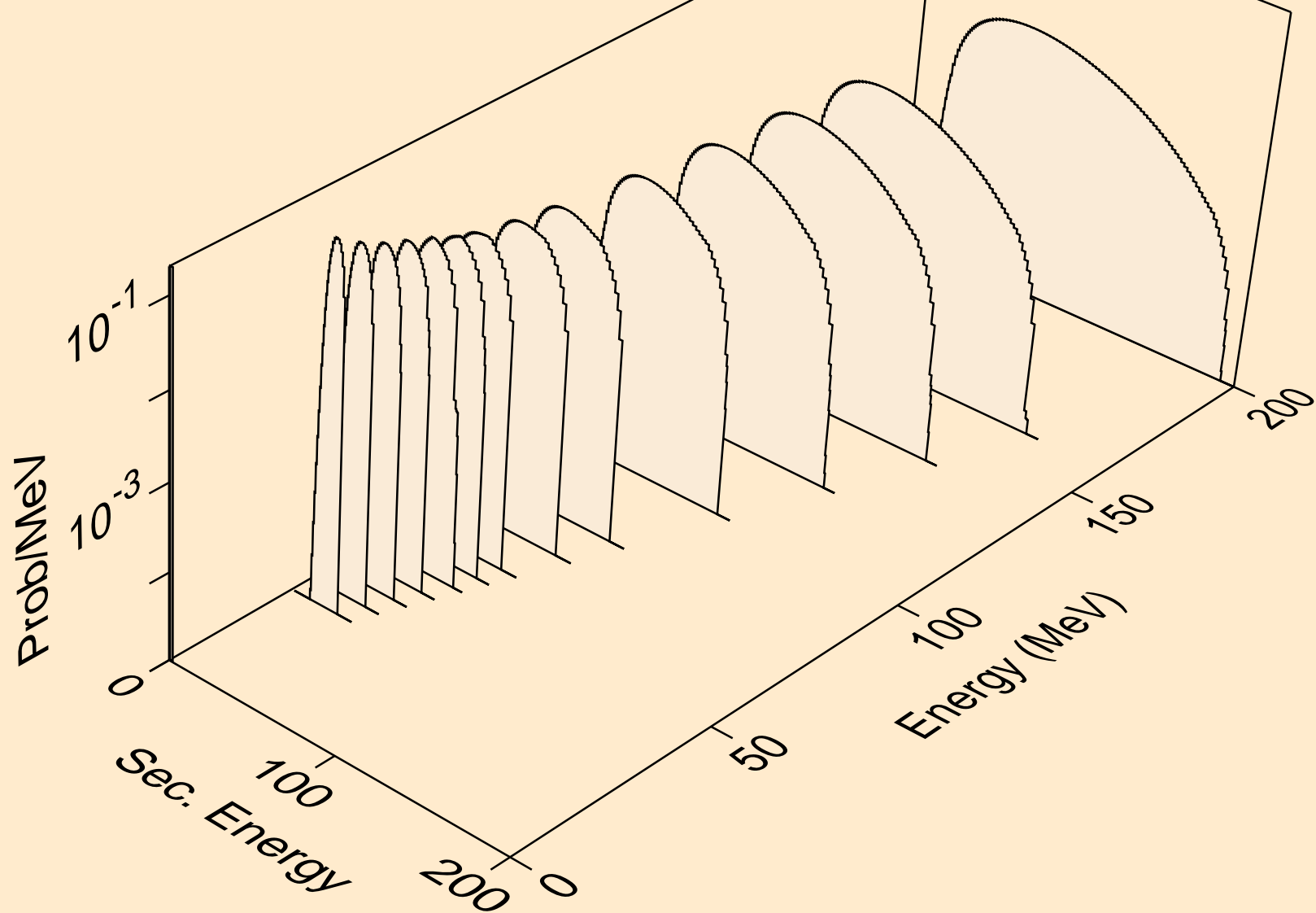

HO164 TRITON ACER TENDL-2021 LIBRARY; T=0.K  
he3s from (t,n\*)he3

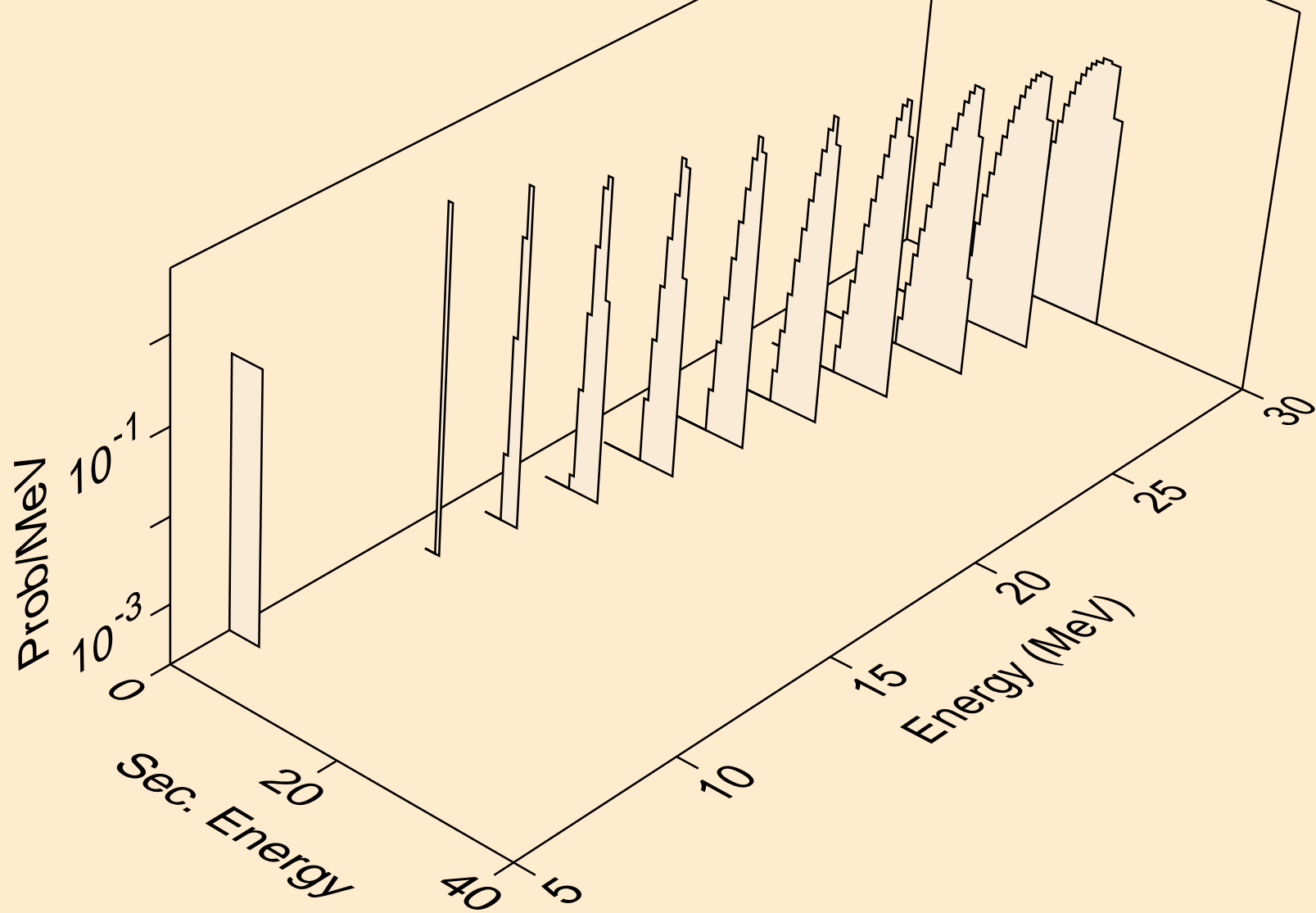

HO164 TRITON ACER TENDL-2021 LIBRARY; T=0.K  
he3s from (t,he3)

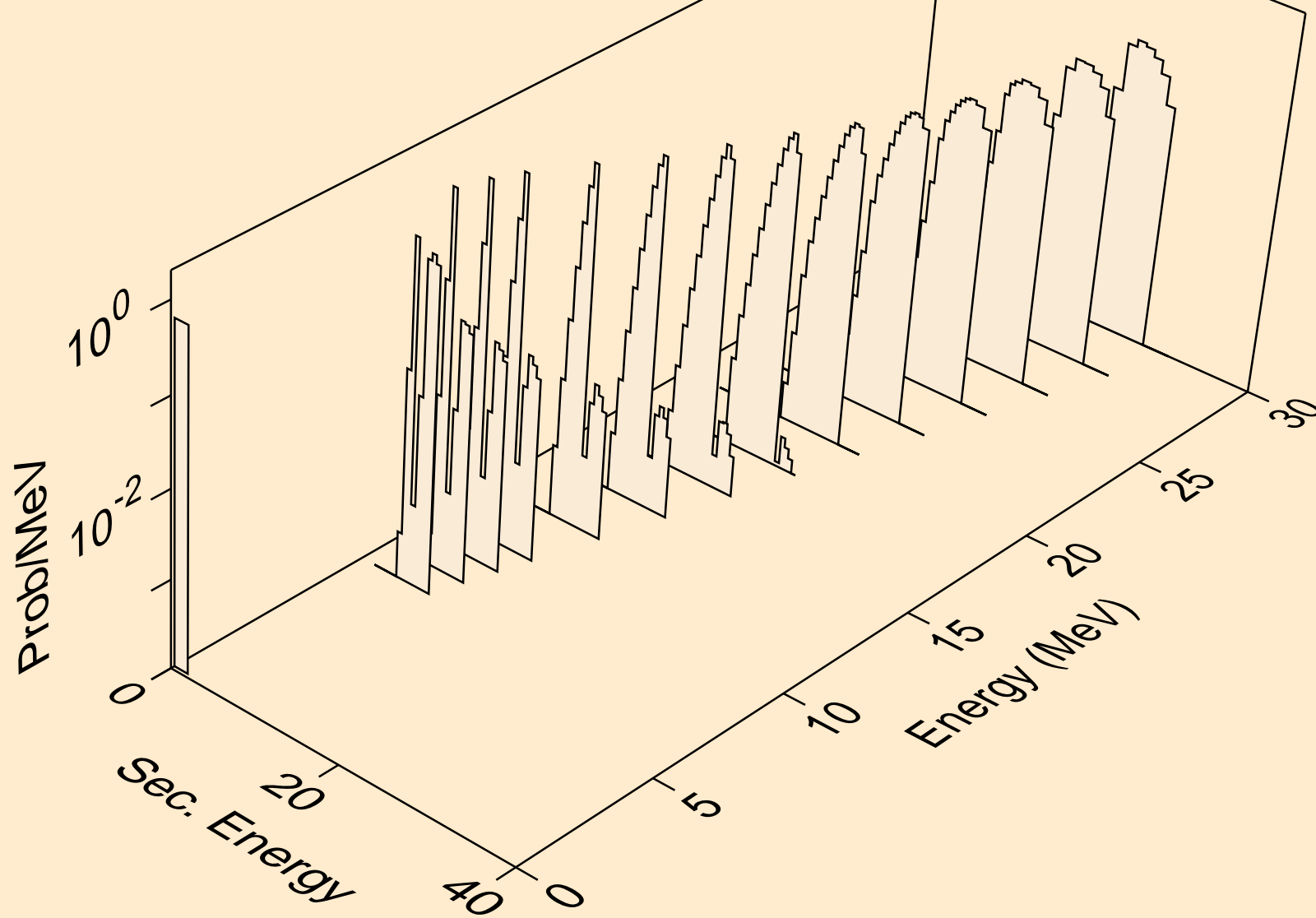

HO164 TRITON ACER TENDL-2021 LIBRARY; T=0.K  
alphas from (t,x)

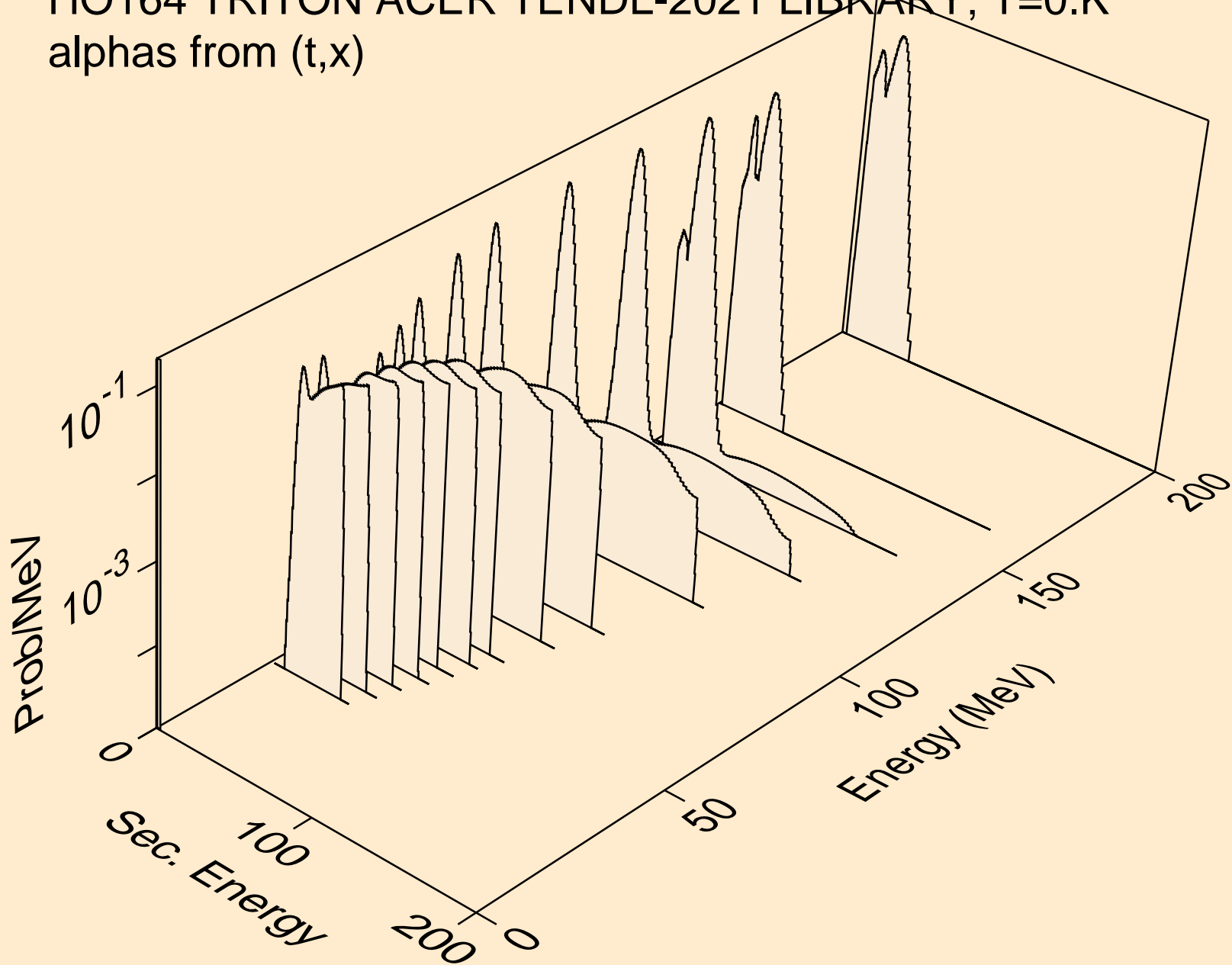

HO164 TRITON ACER TENDL-2021 LIBRARY; T=0.K  
alphas from (t,n\*)a

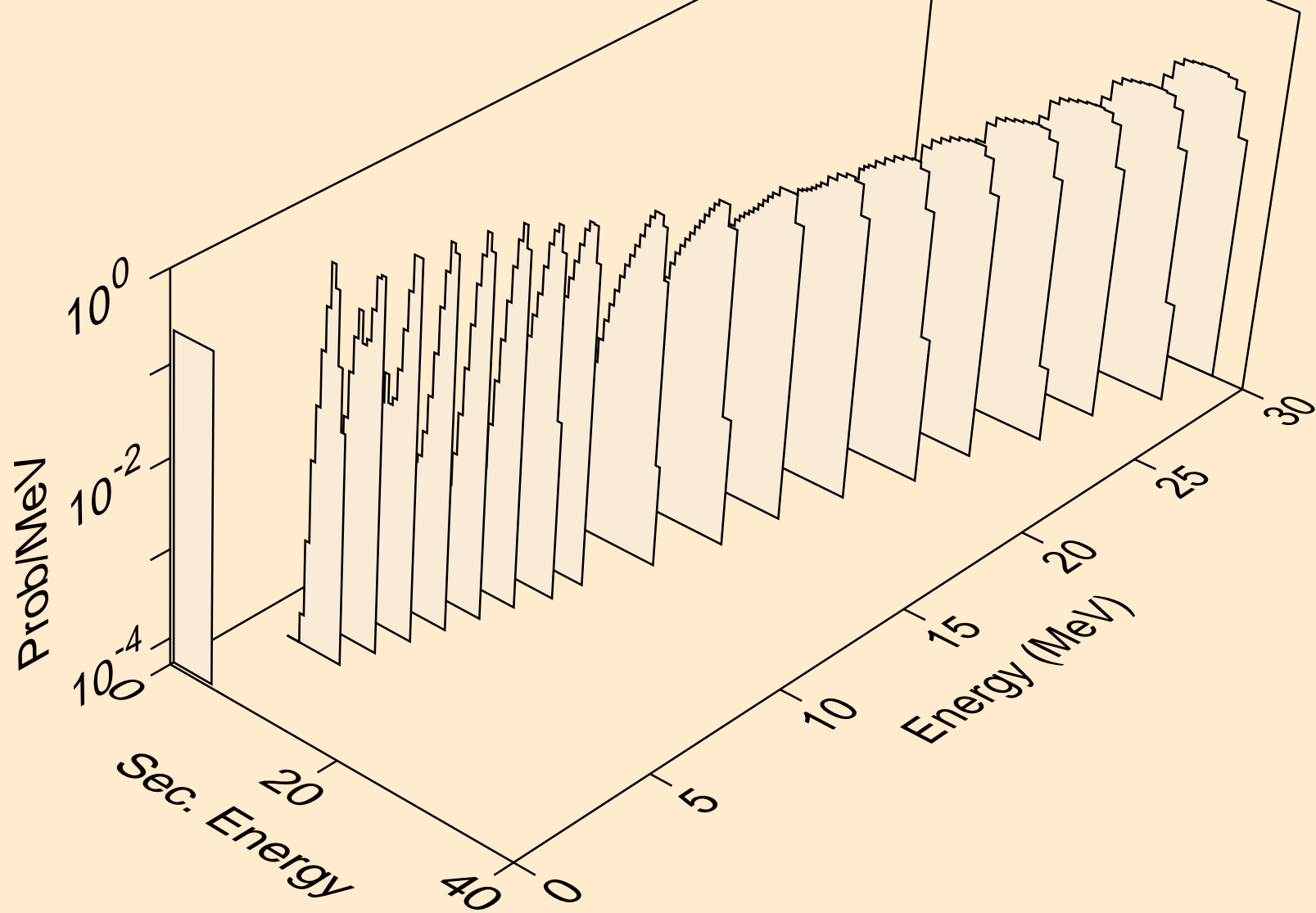



HO164 TRITON ACER TENDL-2021 LIBRARY; T=0.K  
alphas from (t,2n)a

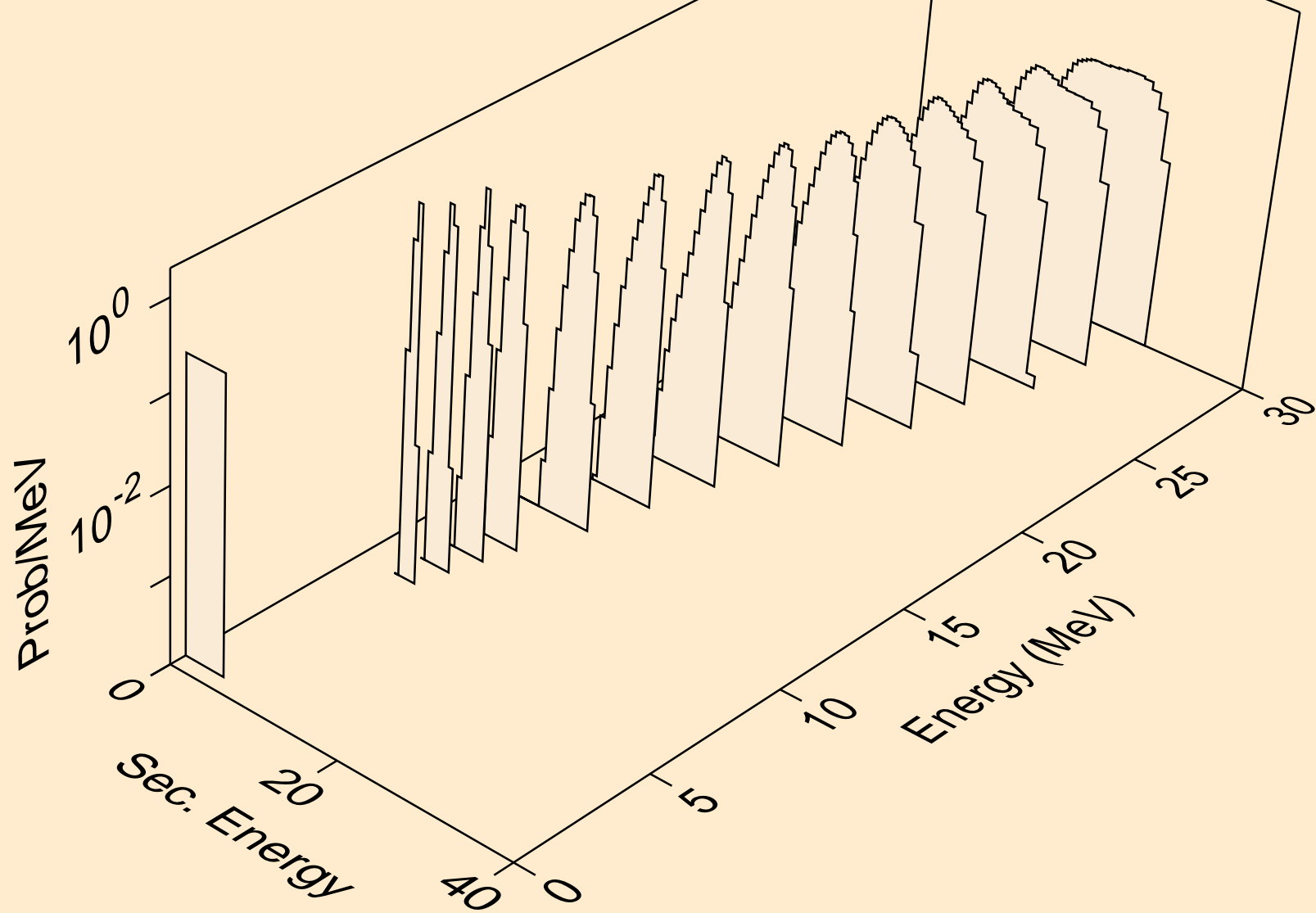

HO164 TRITON ACER TENDL-2021 LIBRARY; T=0.K  
alphas from (t,3n)a

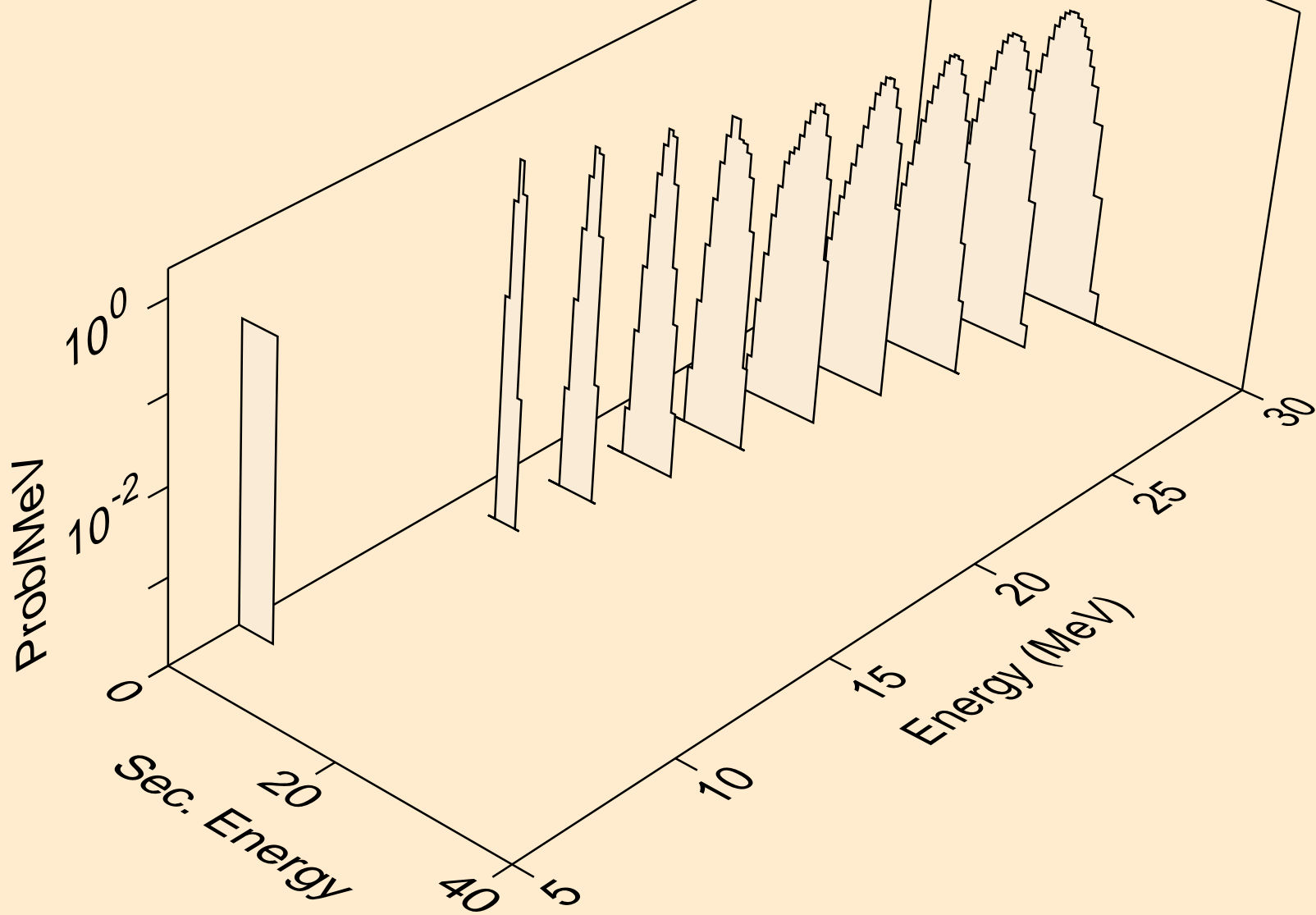

HO164 TRITON ACER TENDL-2021 LIBRARY; T=0.K  
alphas from (t,n\*)2a

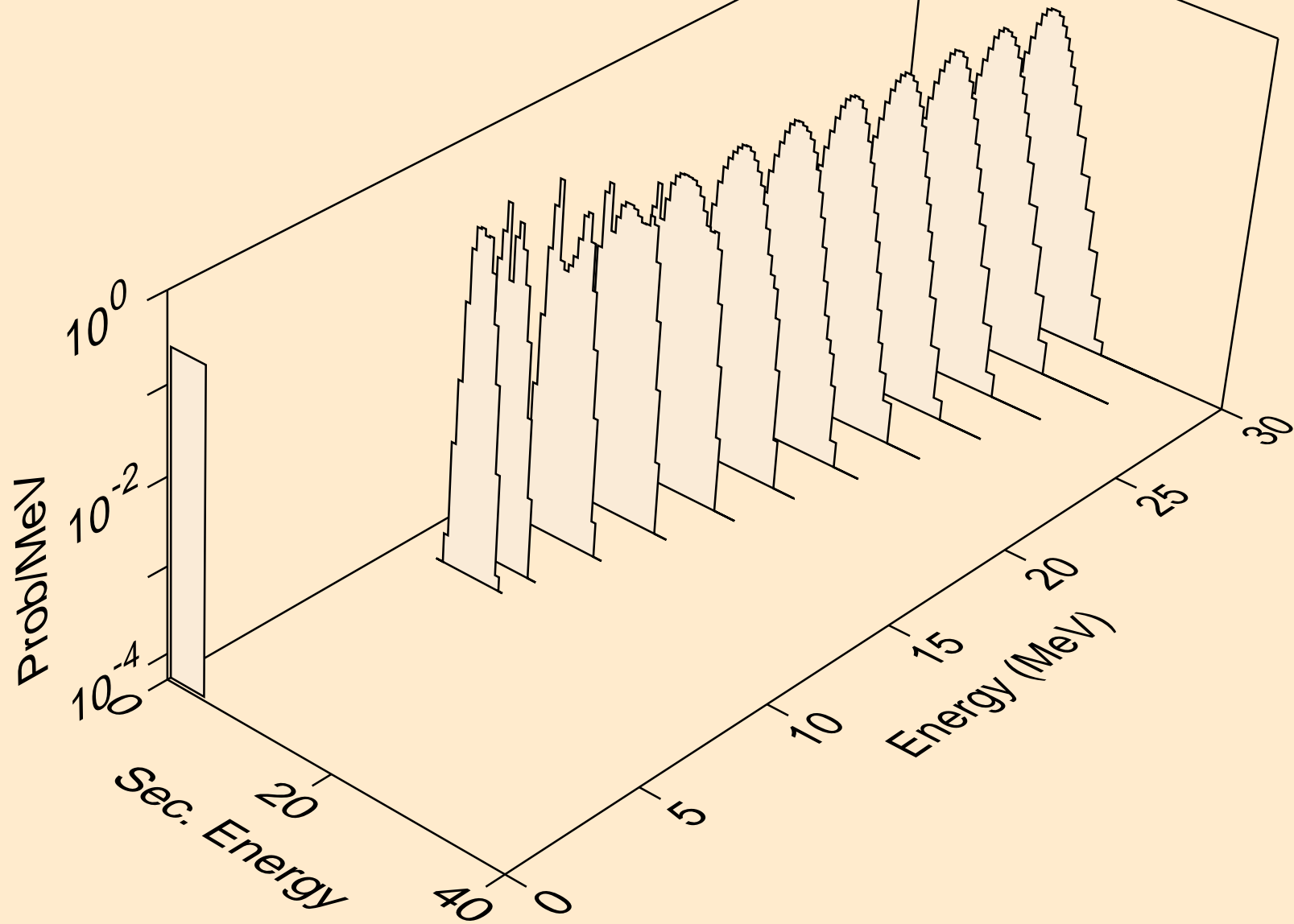

HO164 TRITON ACER TENDL-2021 LIBRARY; T=0.K  
alphas from (t,2n)2a

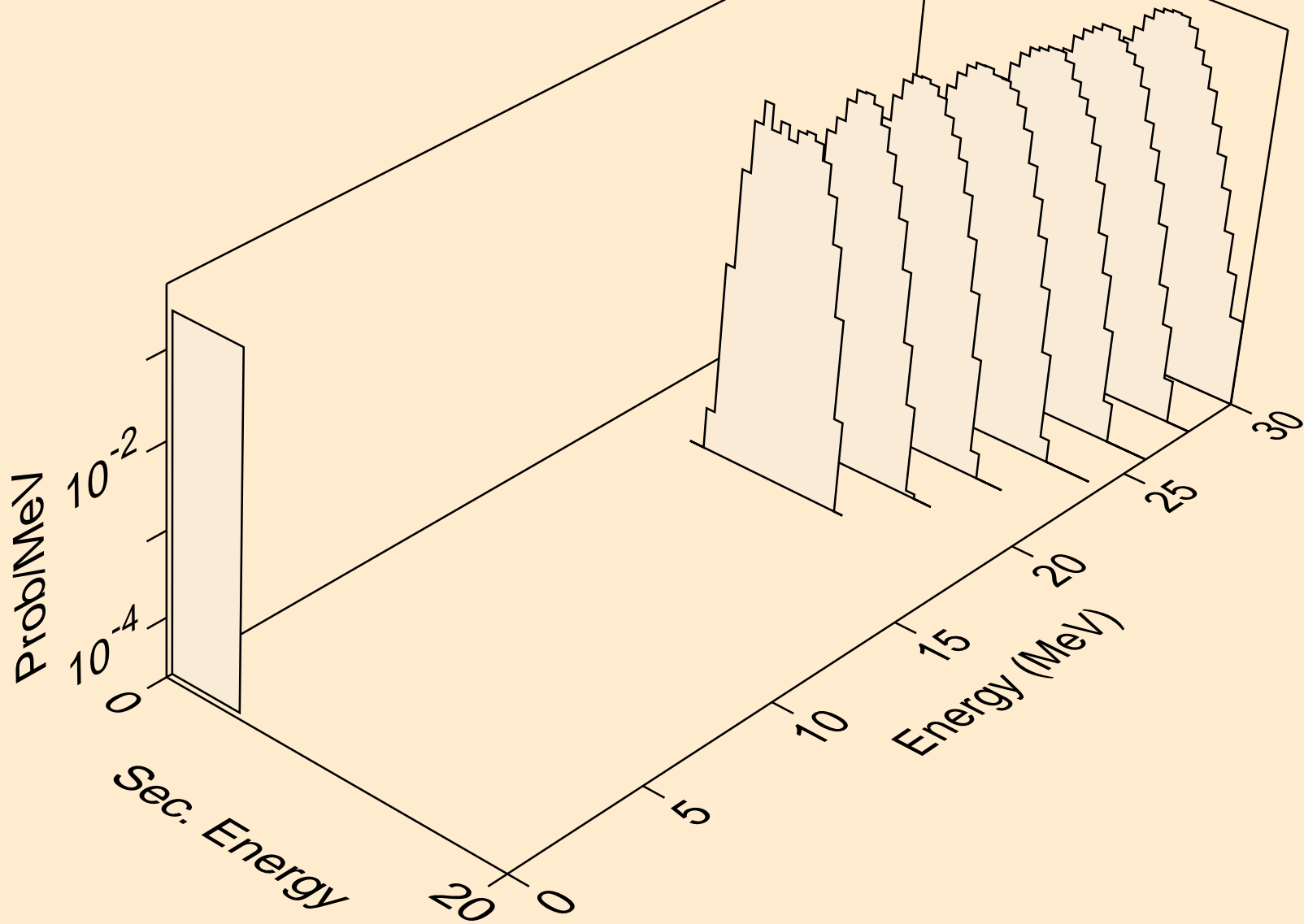

HO164 TRITON ACER TENDL-2021 LIBRARY; T=0.K  
alphas from (t,npa)

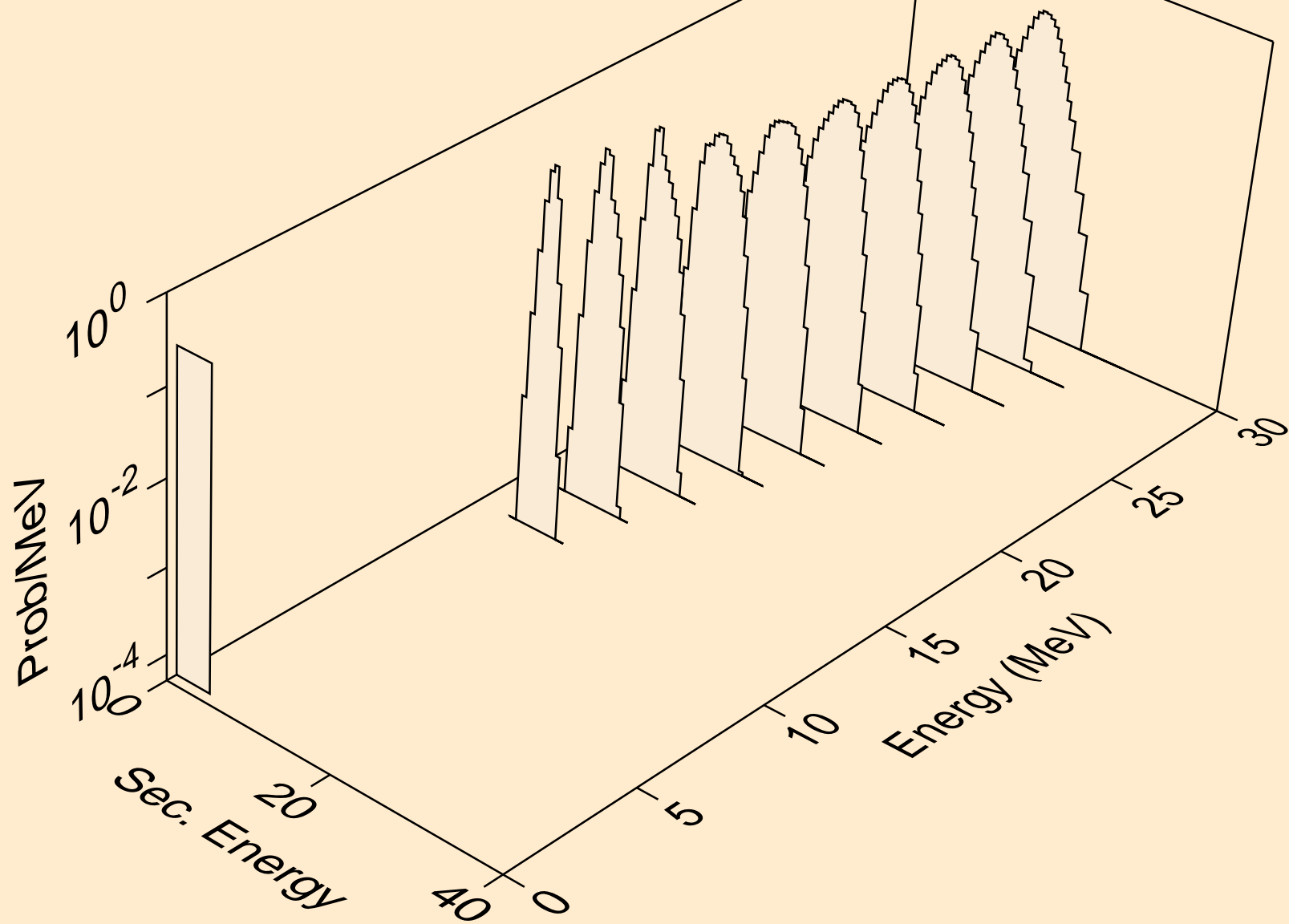

HO164 TRITON ACER TENDL-2021 LIBRARY; T=0.K  
alphas from (t,a)

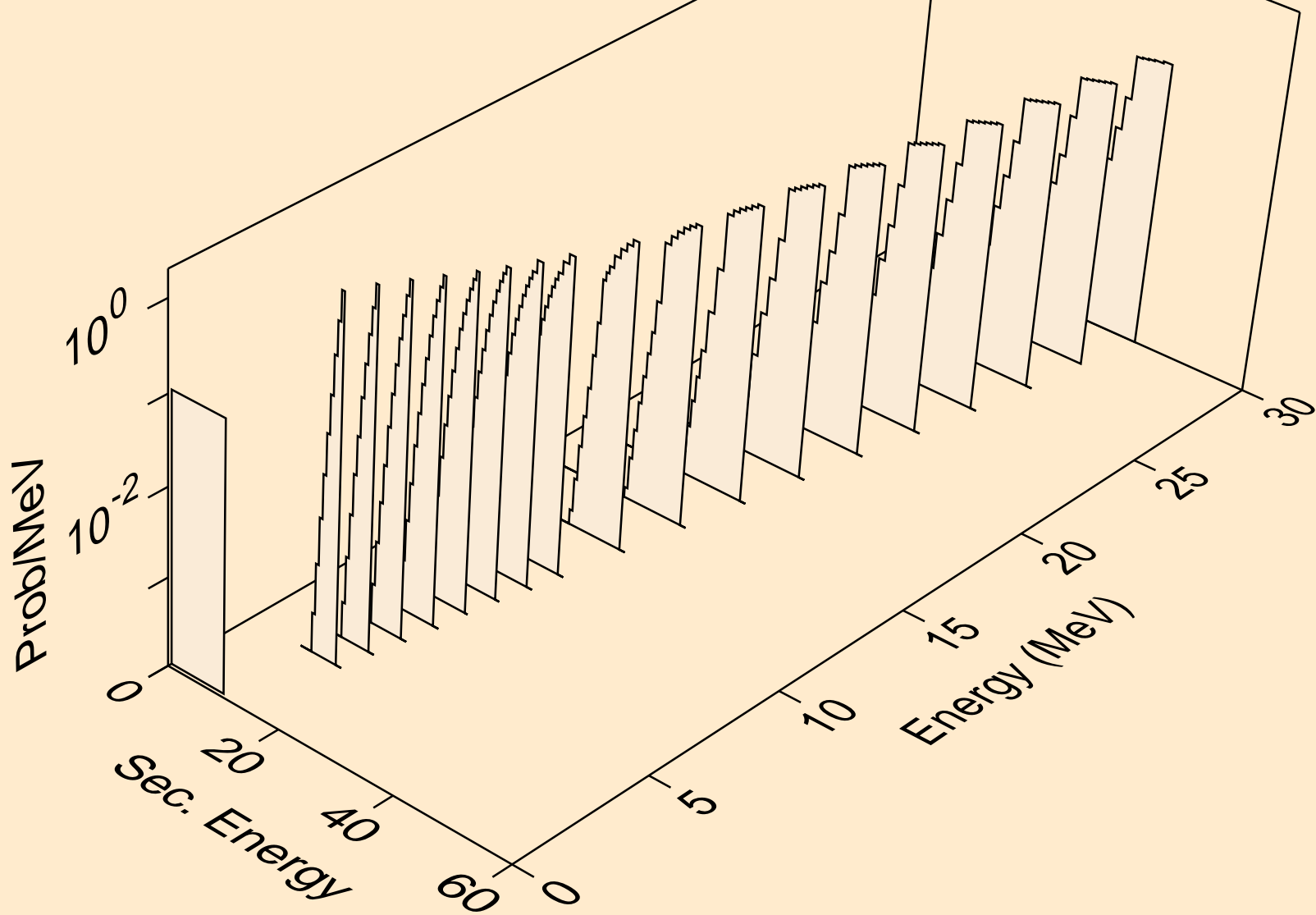

HO164 TRITON ACER TENDL-2021 LIBRARY; T=0.K  
alphas from (t,2a)

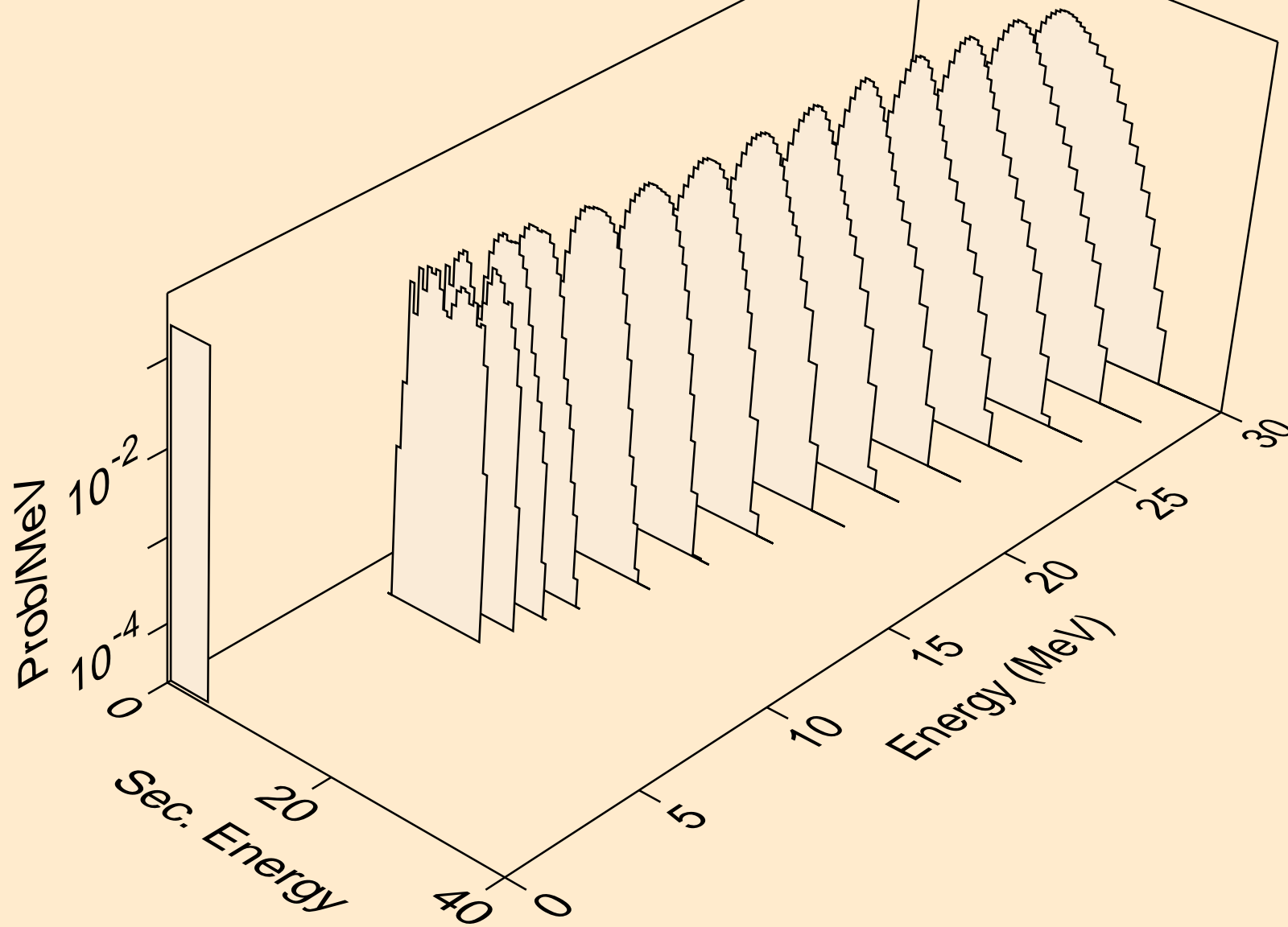

HO164 TRITON ACER TENDL-2021 LIBRARY; T=0.K  
alphas from (t,pa)

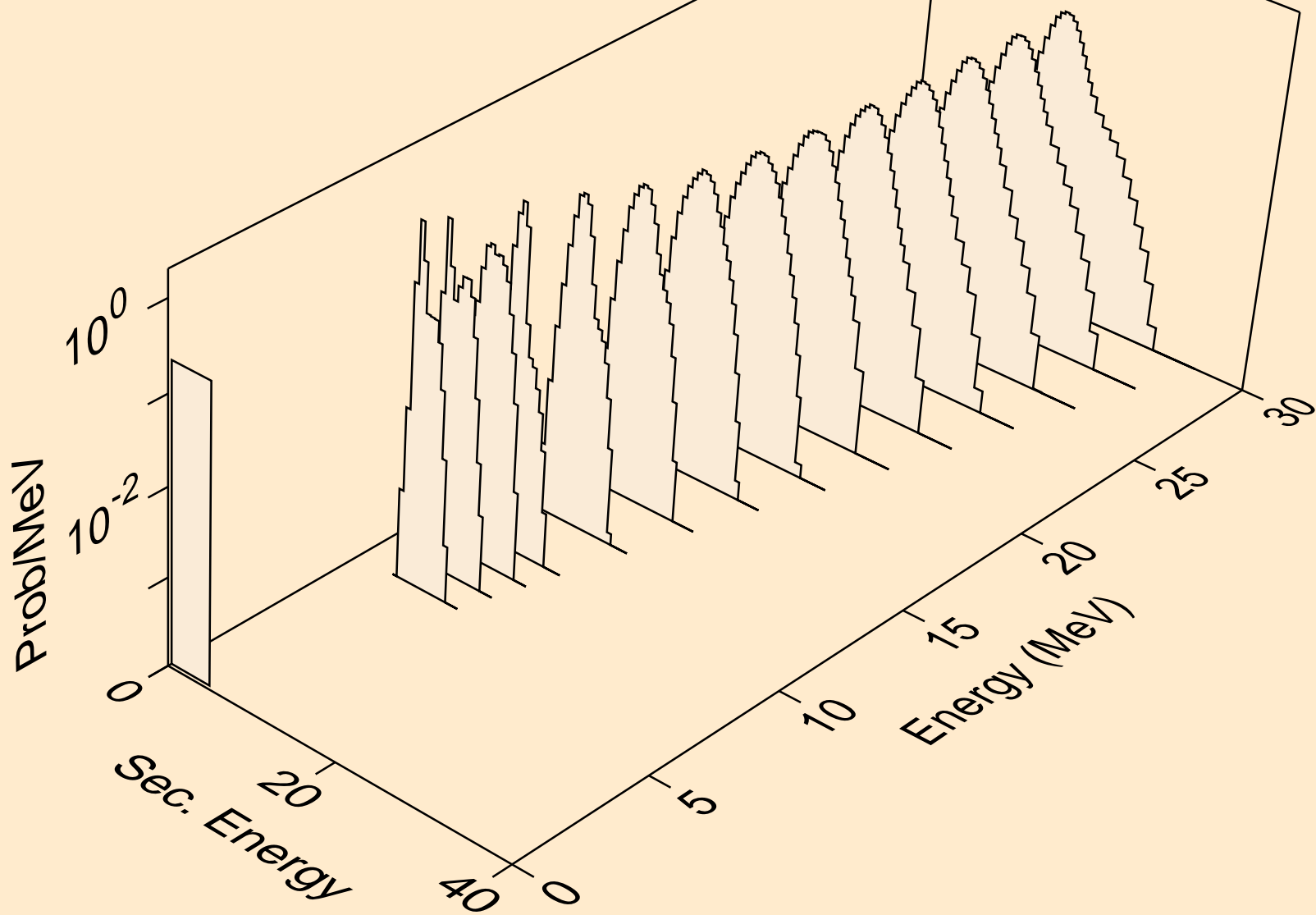



HO164 TRITON ACER TENDL-2021 LIBRARY; T=0.K  
alphas from (t,da)

