

IR204 TRITON ACER TENDL-2023 LIBRARY; T=0.K
Principal cross sections

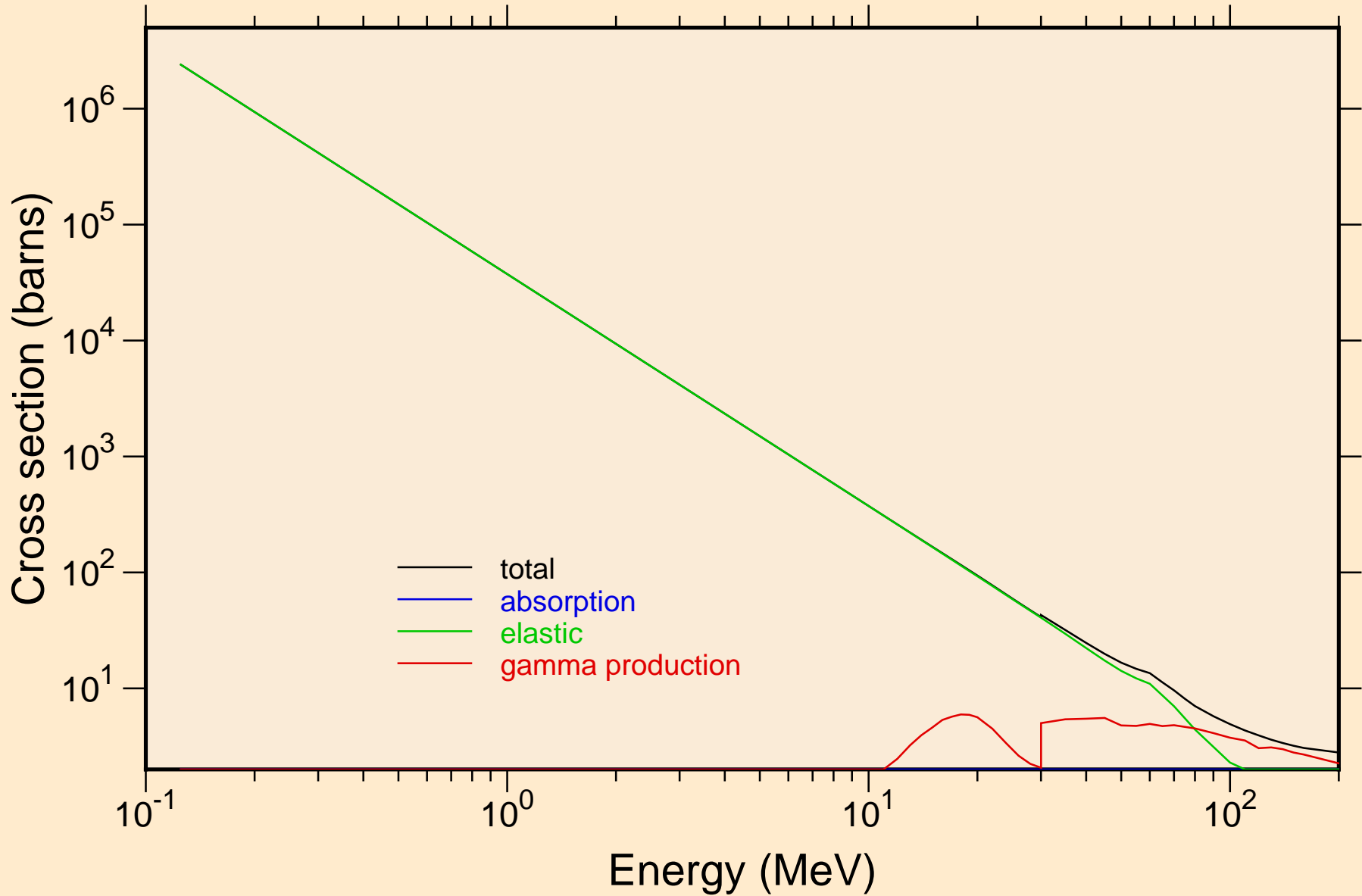

IR204 TRITON ACER TENDL-2023 LIBRARY; T=0.K

Heating

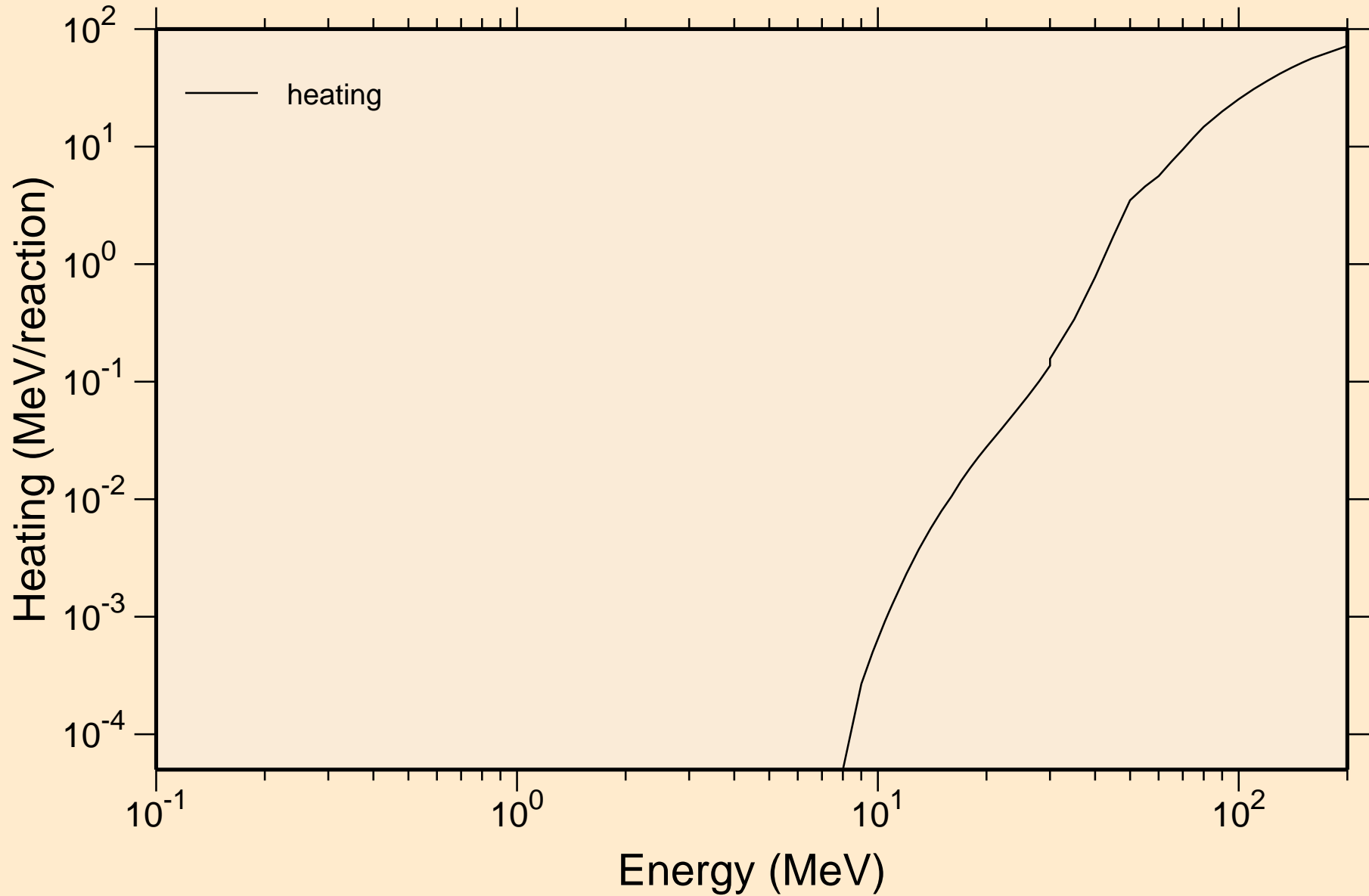

IR204 TRITON ACER TENDL-2023 LIBRARY; T=0.K

Principal cross sections

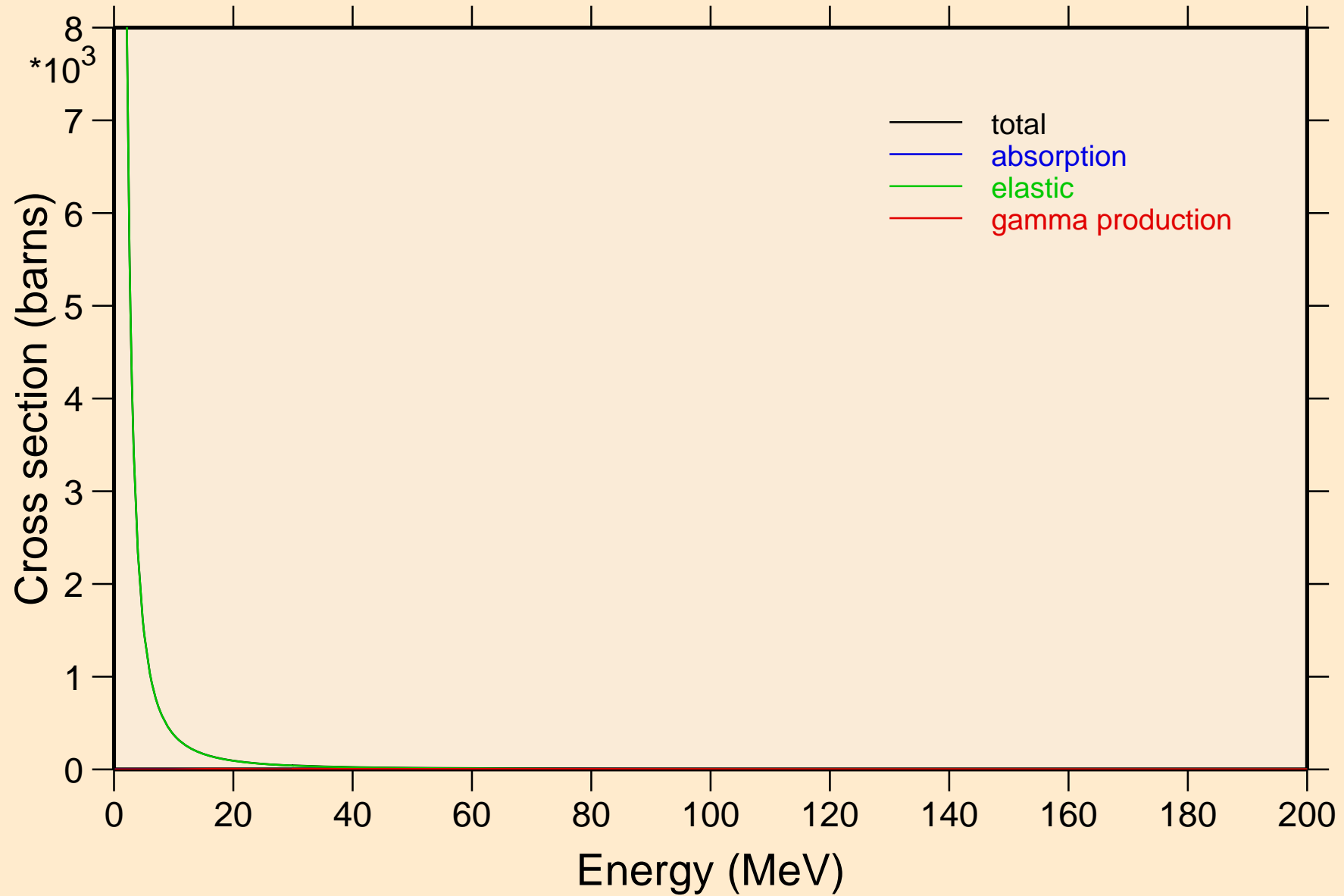

IR204 TRITON ACER TENDL-2023 LIBRARY; T=0.K

Heating

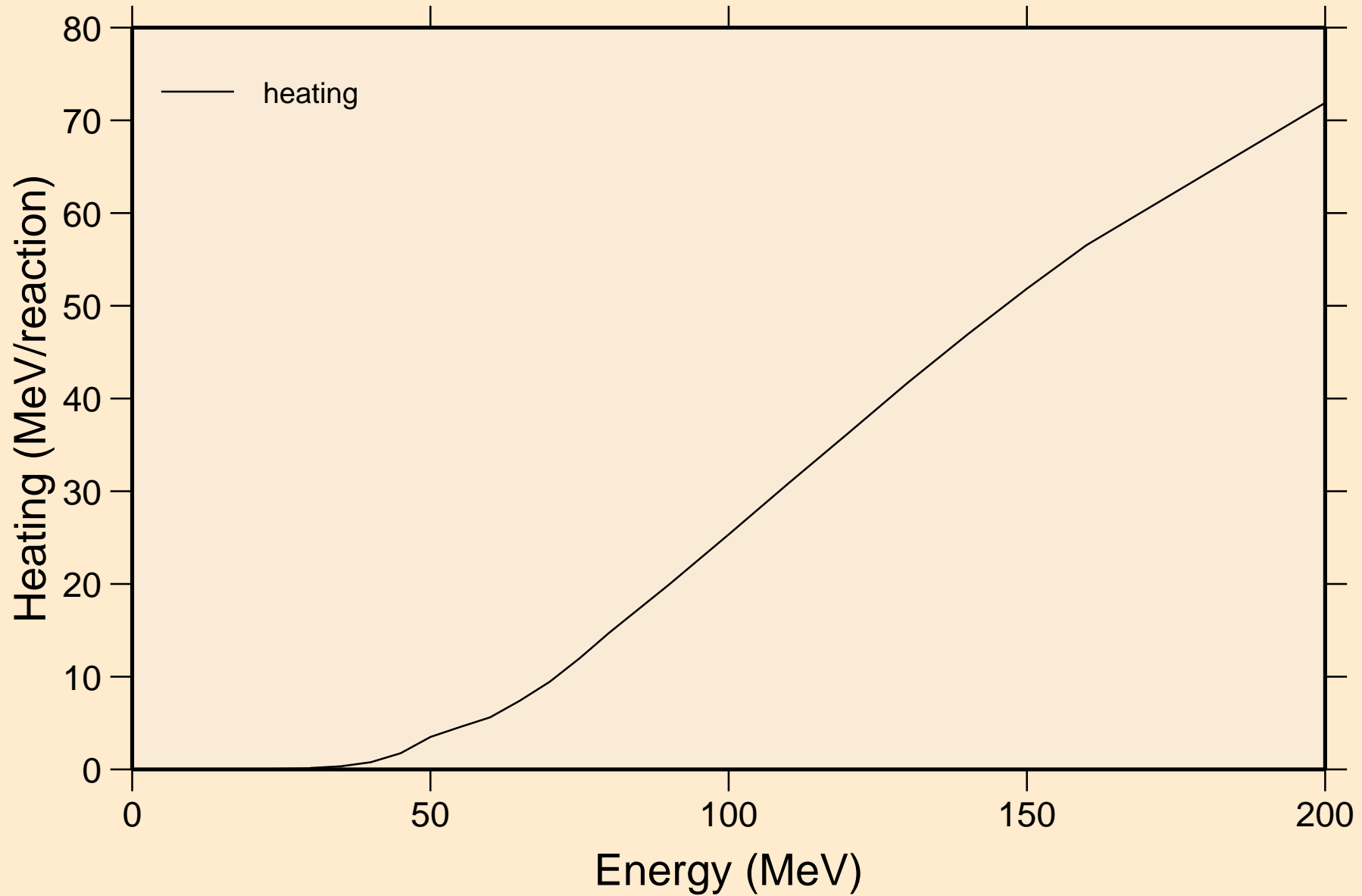

IR204 TRITON ACER TENDL-2023 LIBRARY; T=0.K
Threshold reactions

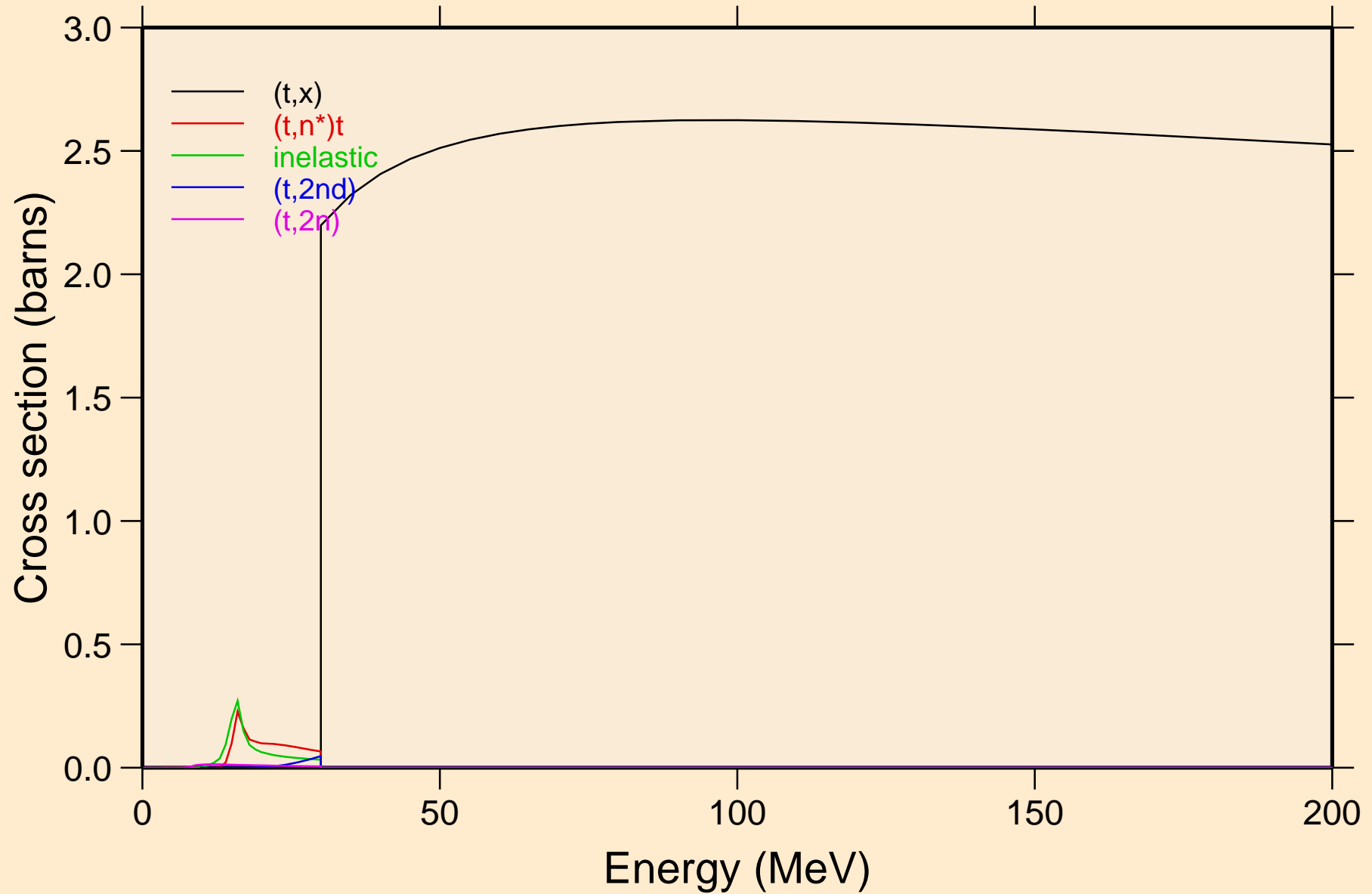

IR204 TRITON ACER TENDL-2023 LIBRARY; T=0.K
Threshold reactions

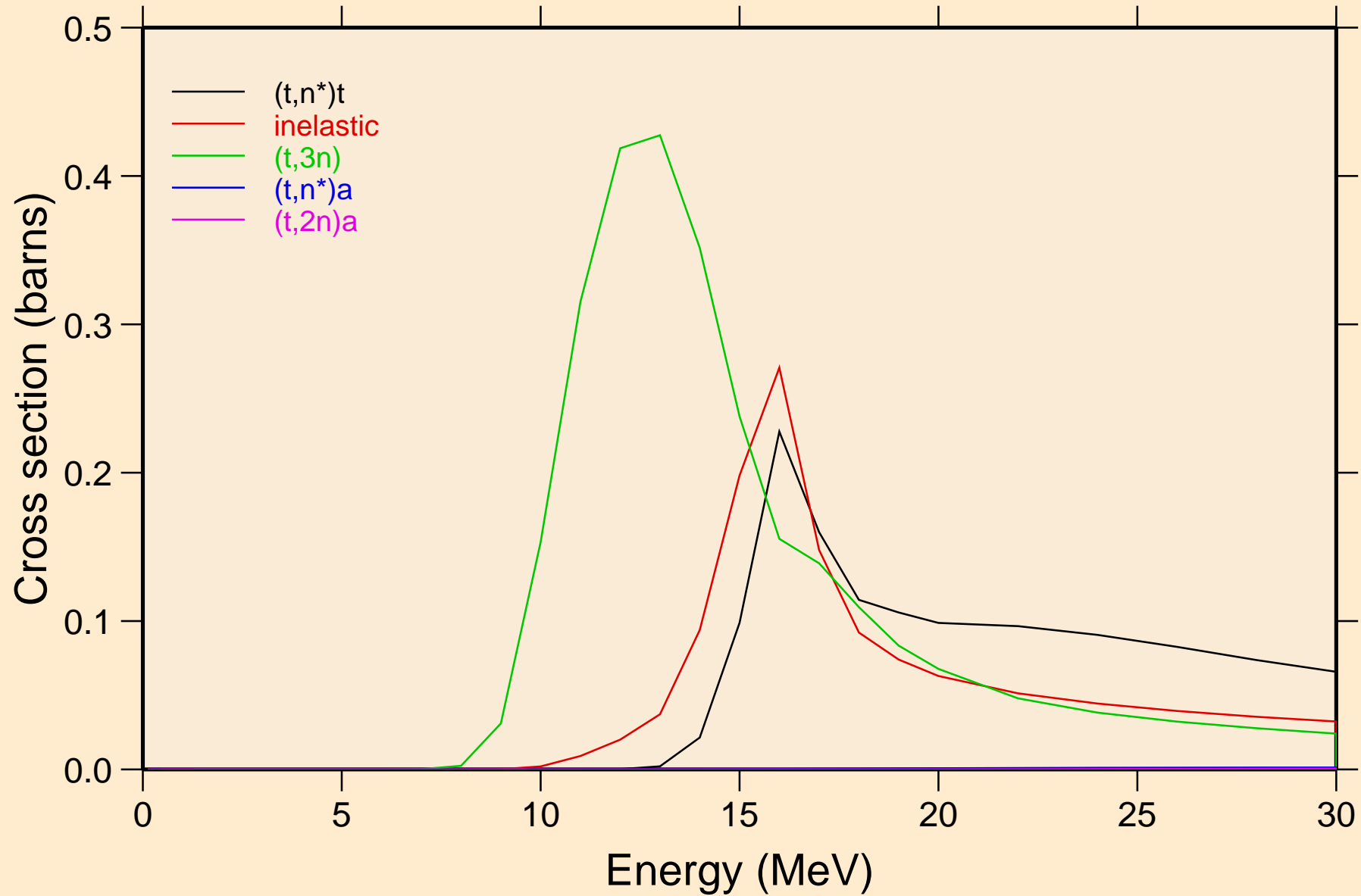

IR204 TRITON ACER TENDL-2023 LIBRARY; T=0.K

Threshold reactions

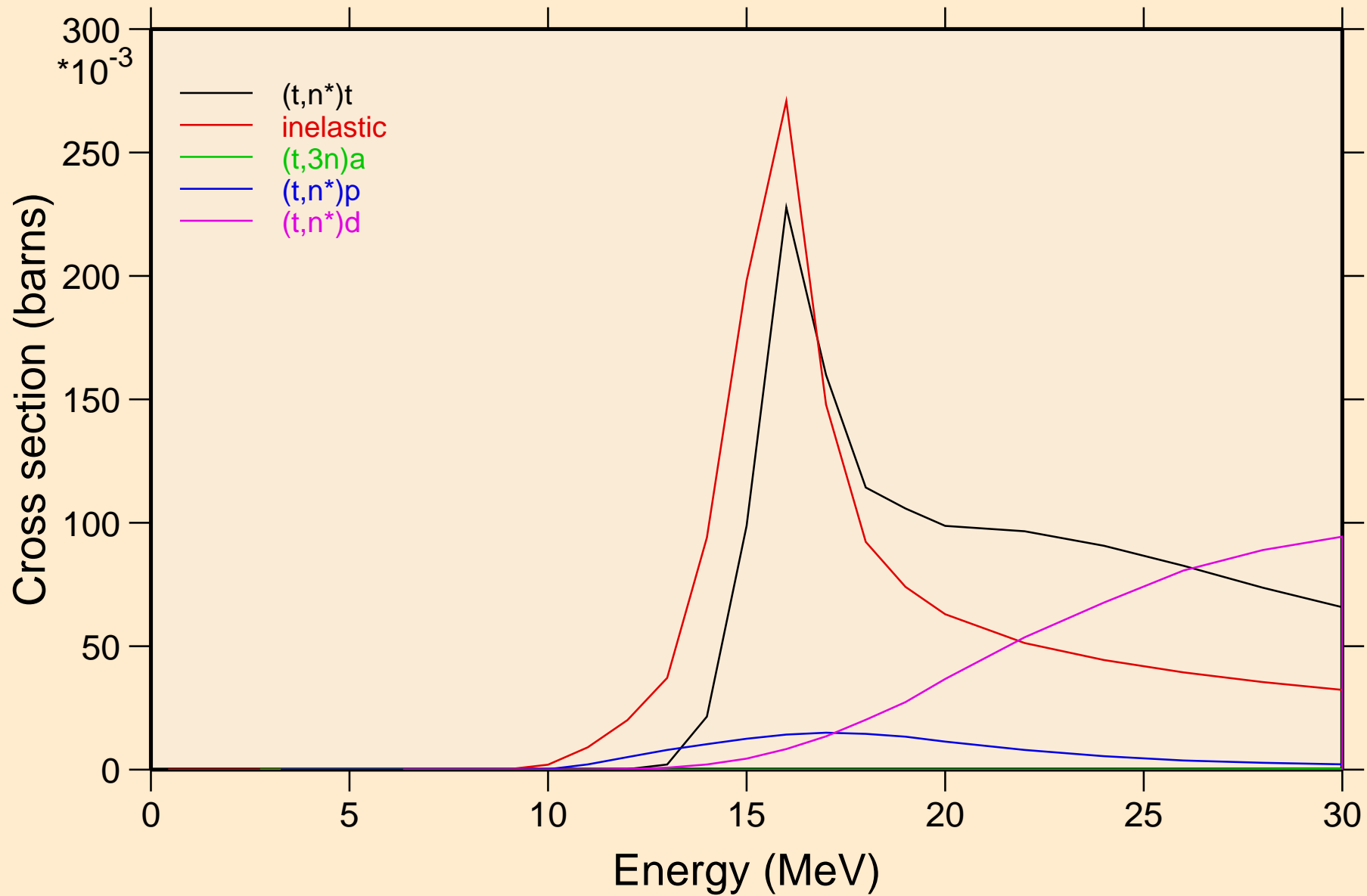

IR204 TRITON ACER TENDL-2023 LIBRARY; T=0.K
Threshold reactions

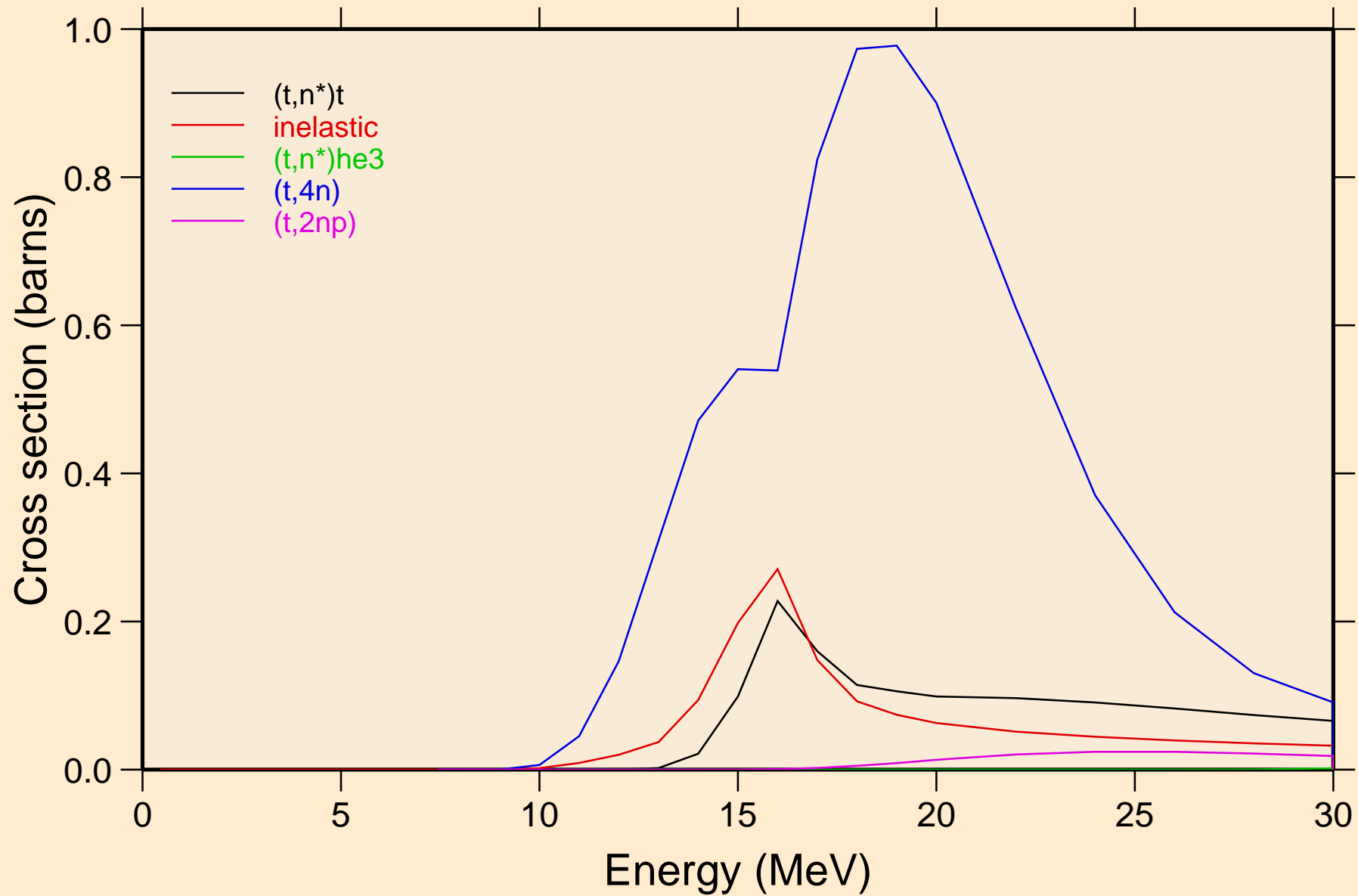

IR204 TRITON ACER TENDL-2023 LIBRARY; T=0.K
Threshold reactions

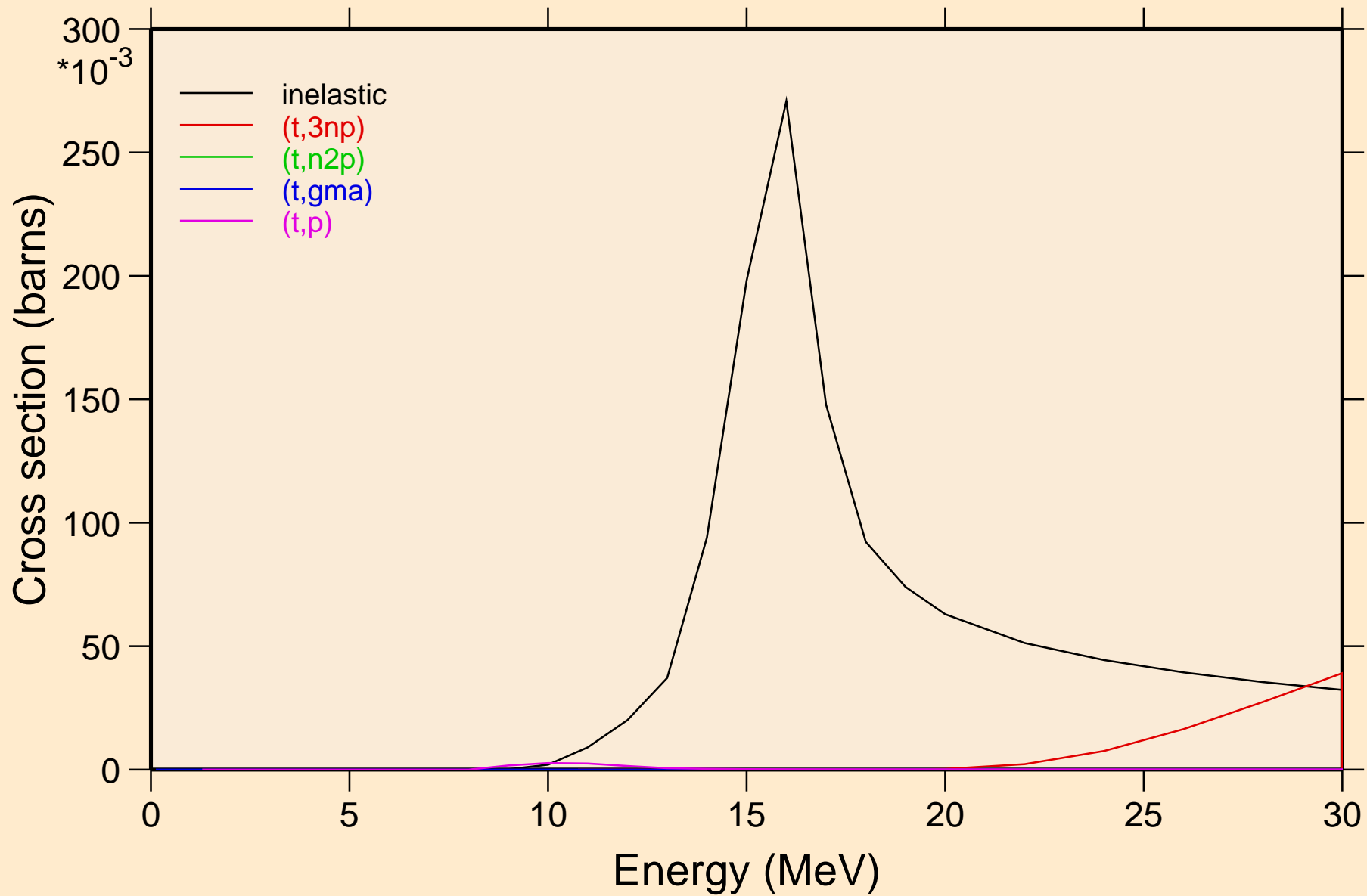

IR204 TRITON ACER TENDL-2023 LIBRARY; T=0.K
Threshold reactions

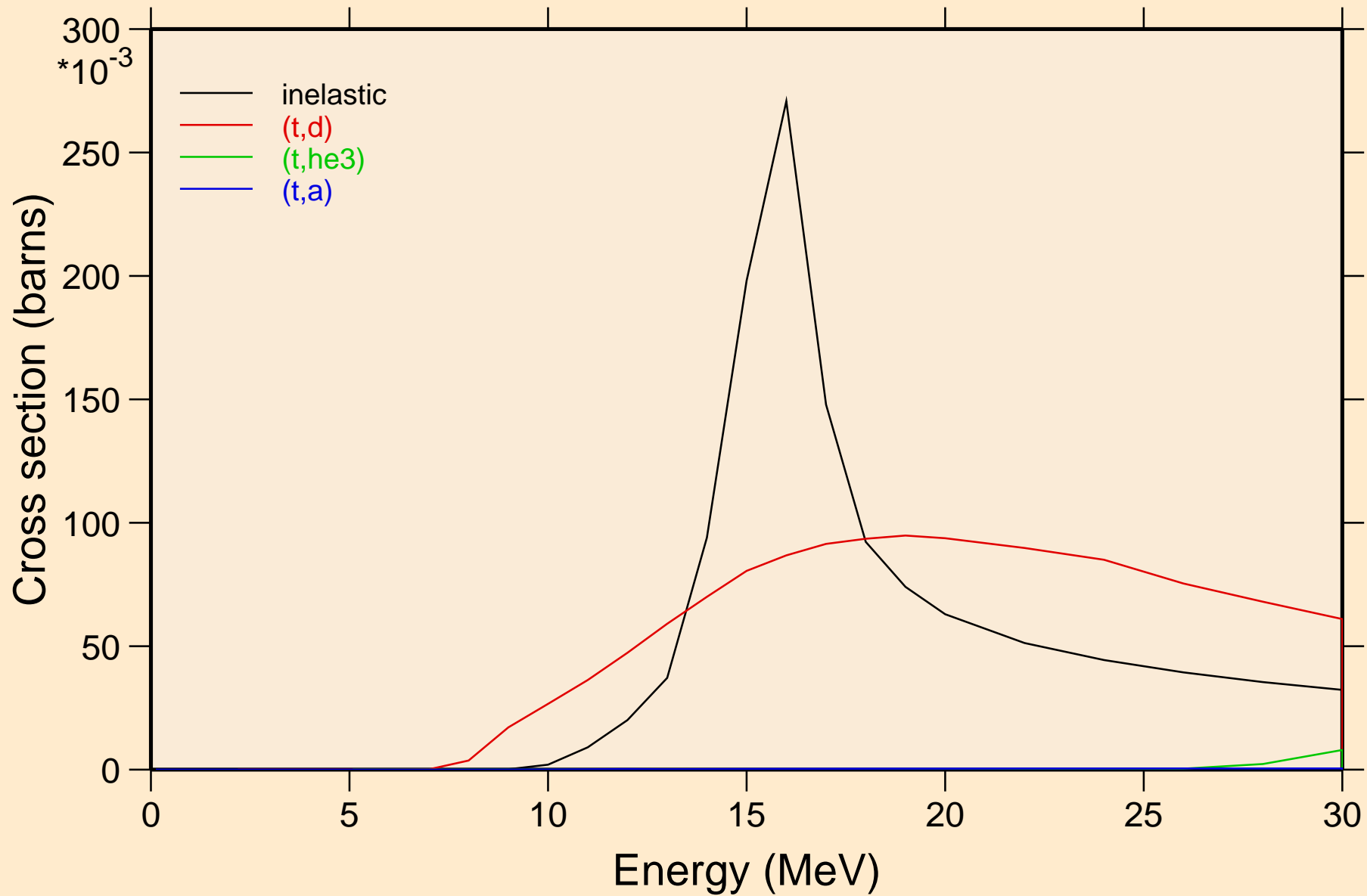

IR204 TRITON ACER TENDL-2023 LIBRARY; T=0.K
angular distribution for elastic

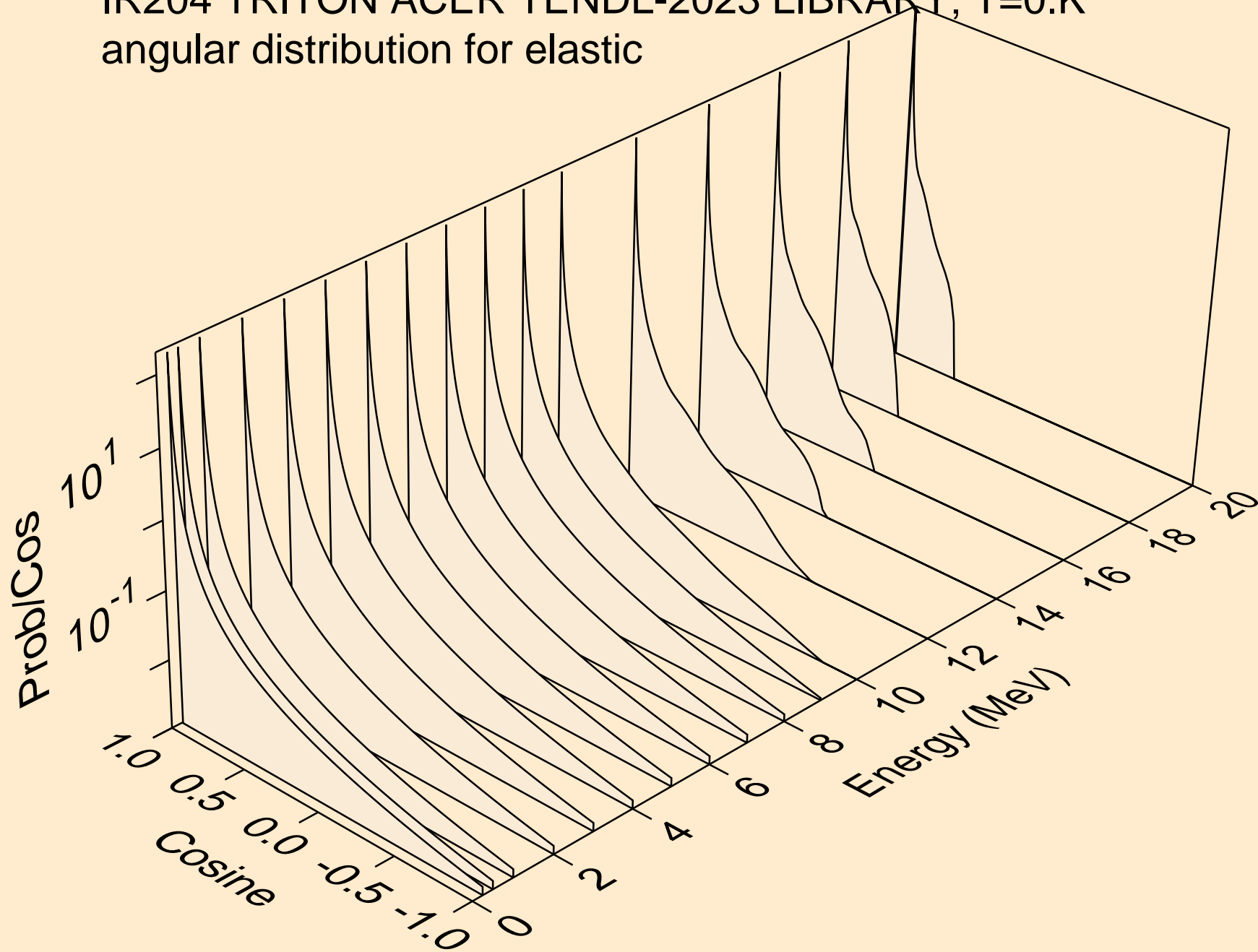

IR204 TRITON ACER TENDL-2023 LIBRARY; T=0.K
angular distribution for elastic

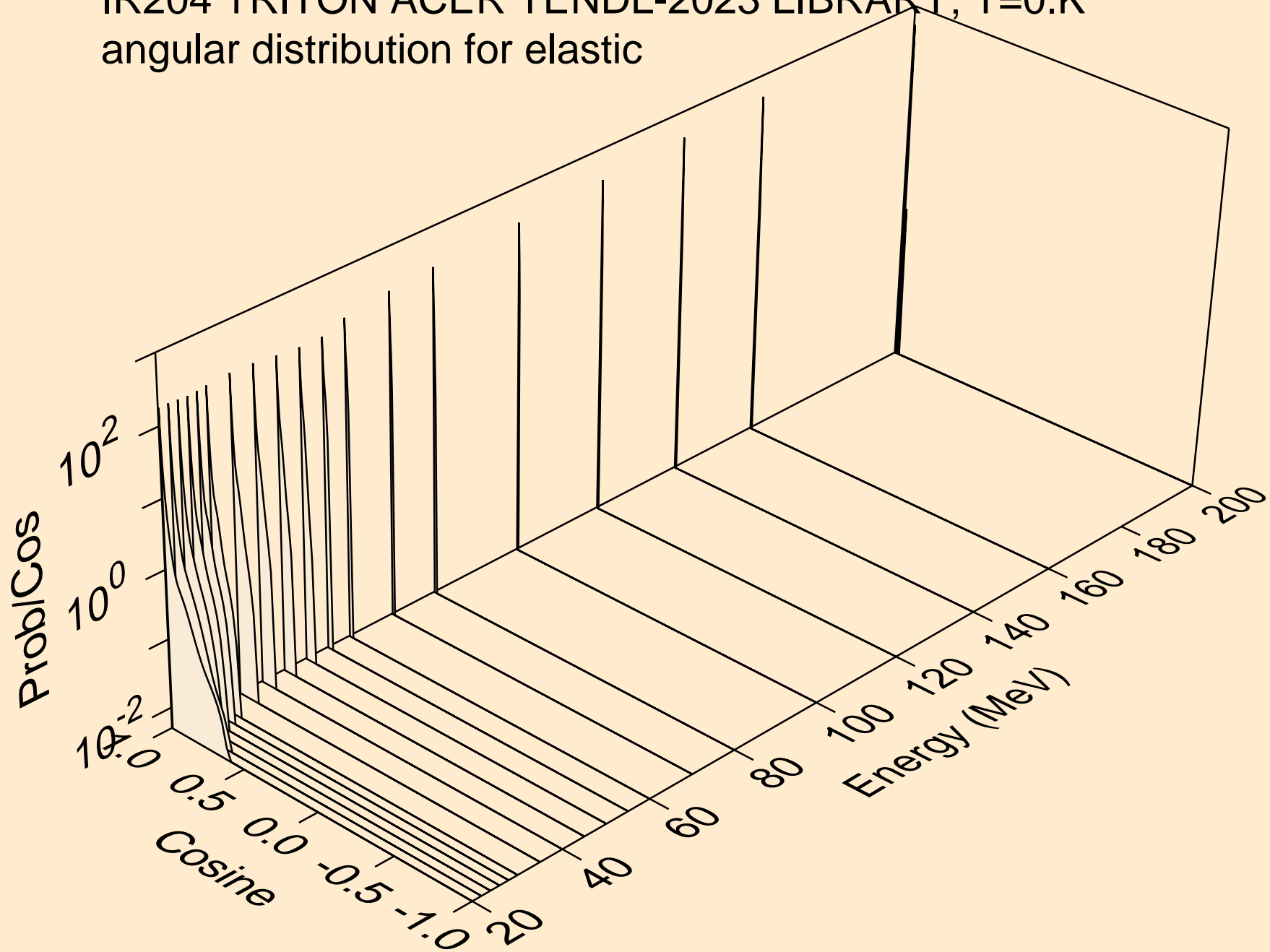

IR204 TRITON ACER TENDL-2023 LIBRARY; T=0.K
Triton emission for (t,x)

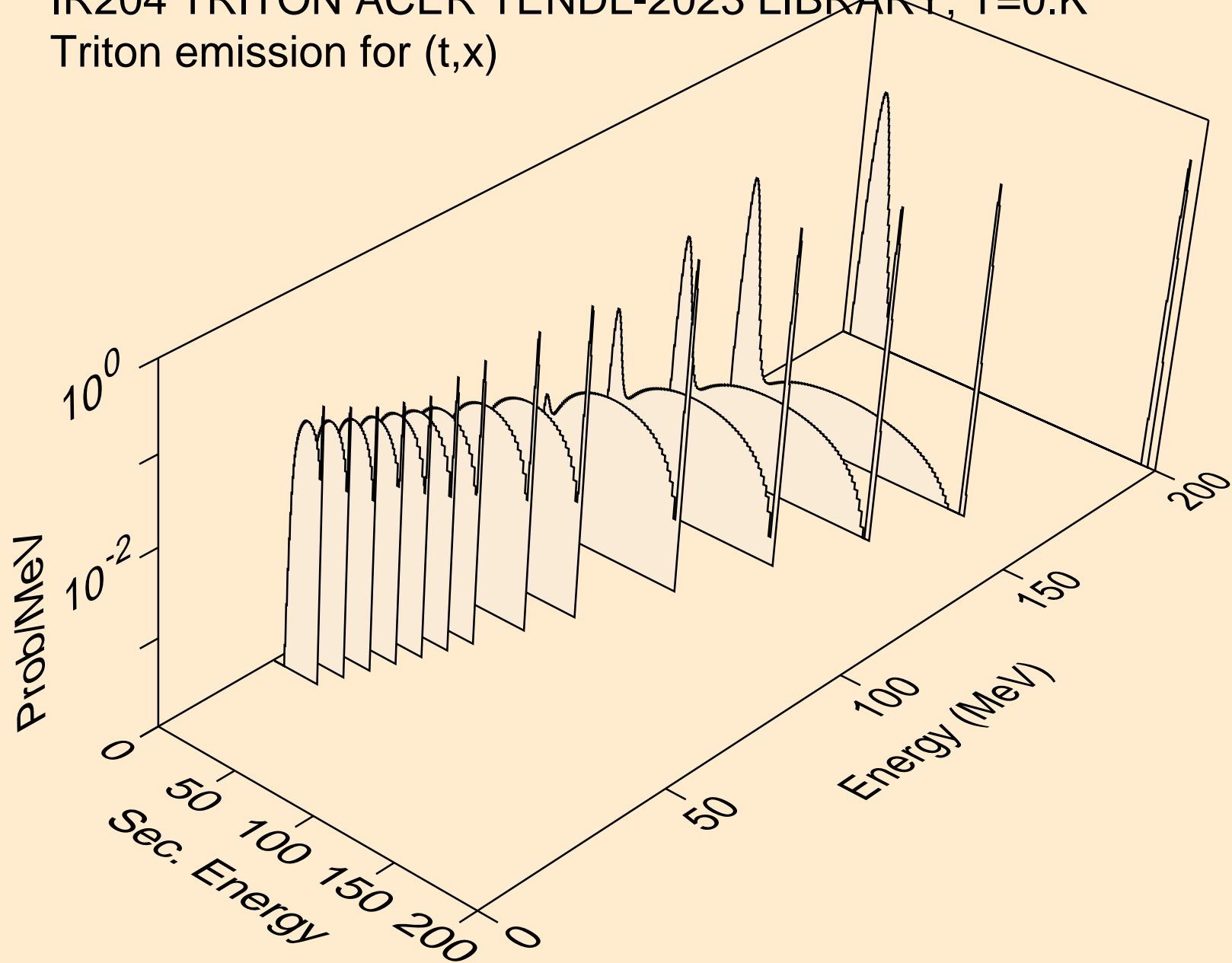

IR204 TRITON ACER TENDL-2023 LIBRARY; T=0.K
Triton emission for (t,n*)t

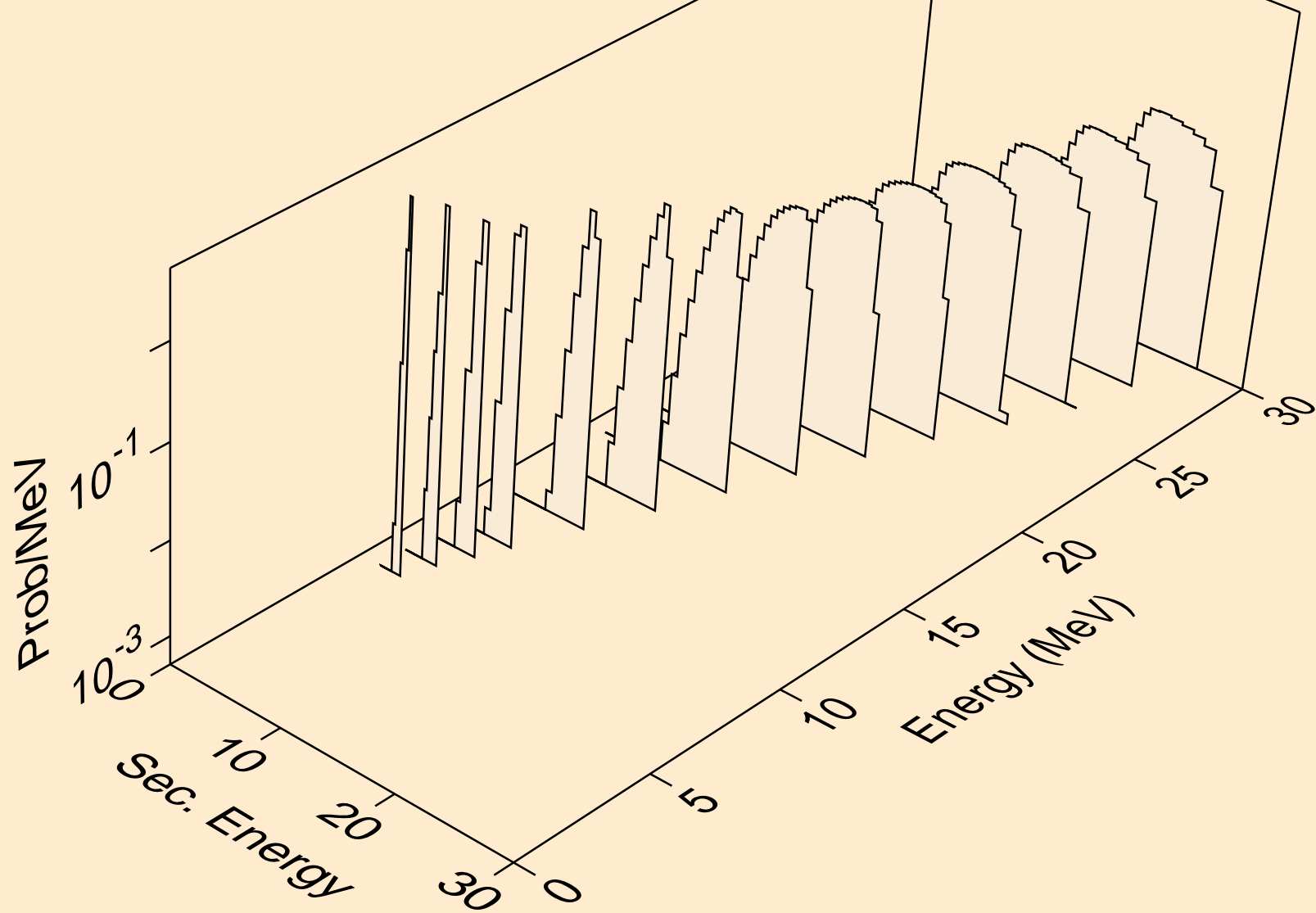

IR204 TRITON ACER TENDL-2023 LIBRARY; T=0.K
Triton emission for inelastic

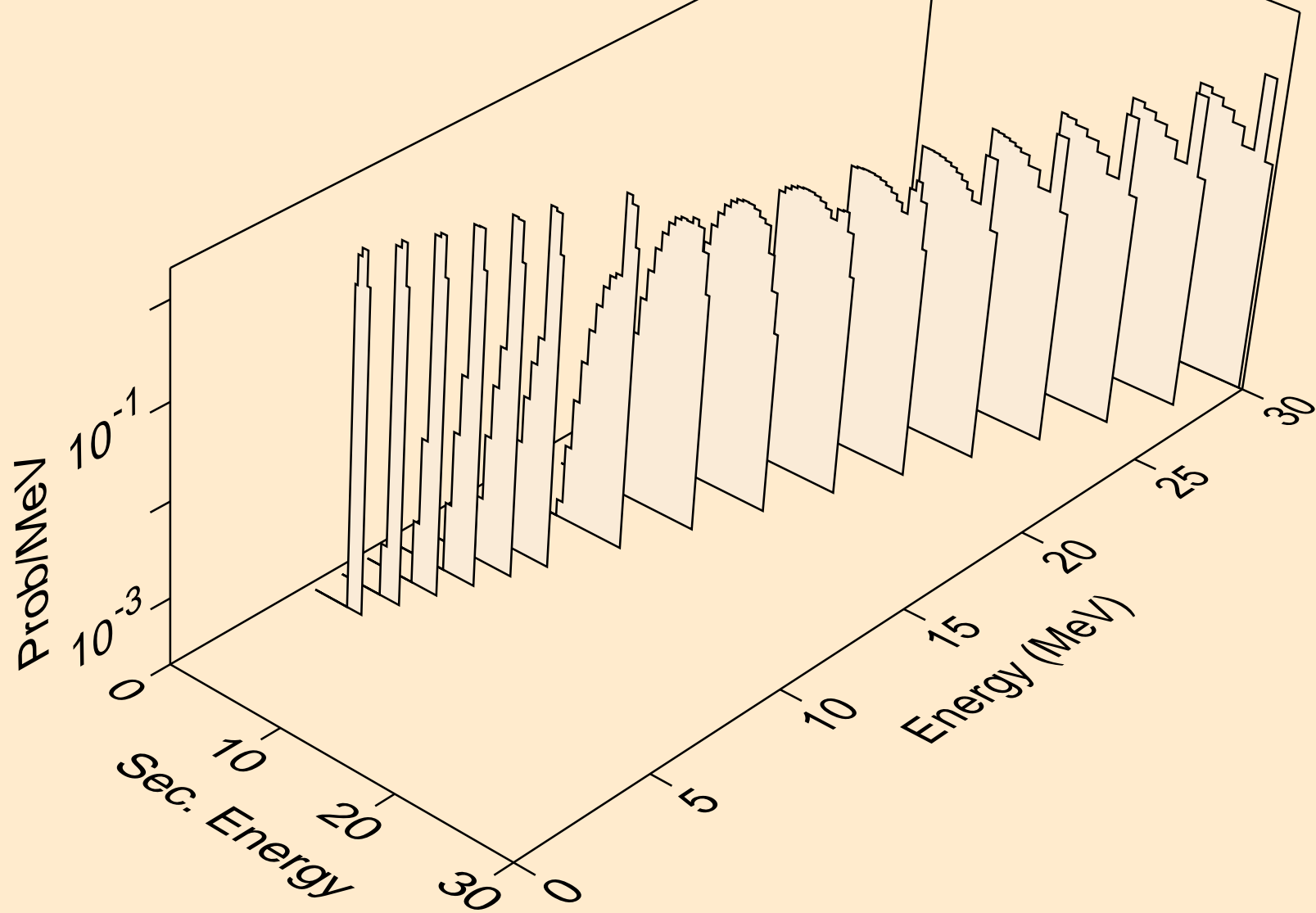

IR204 TRITON ACER TENDL-2023 LIBRARY; T=0.K
Photon emission for (z,n)

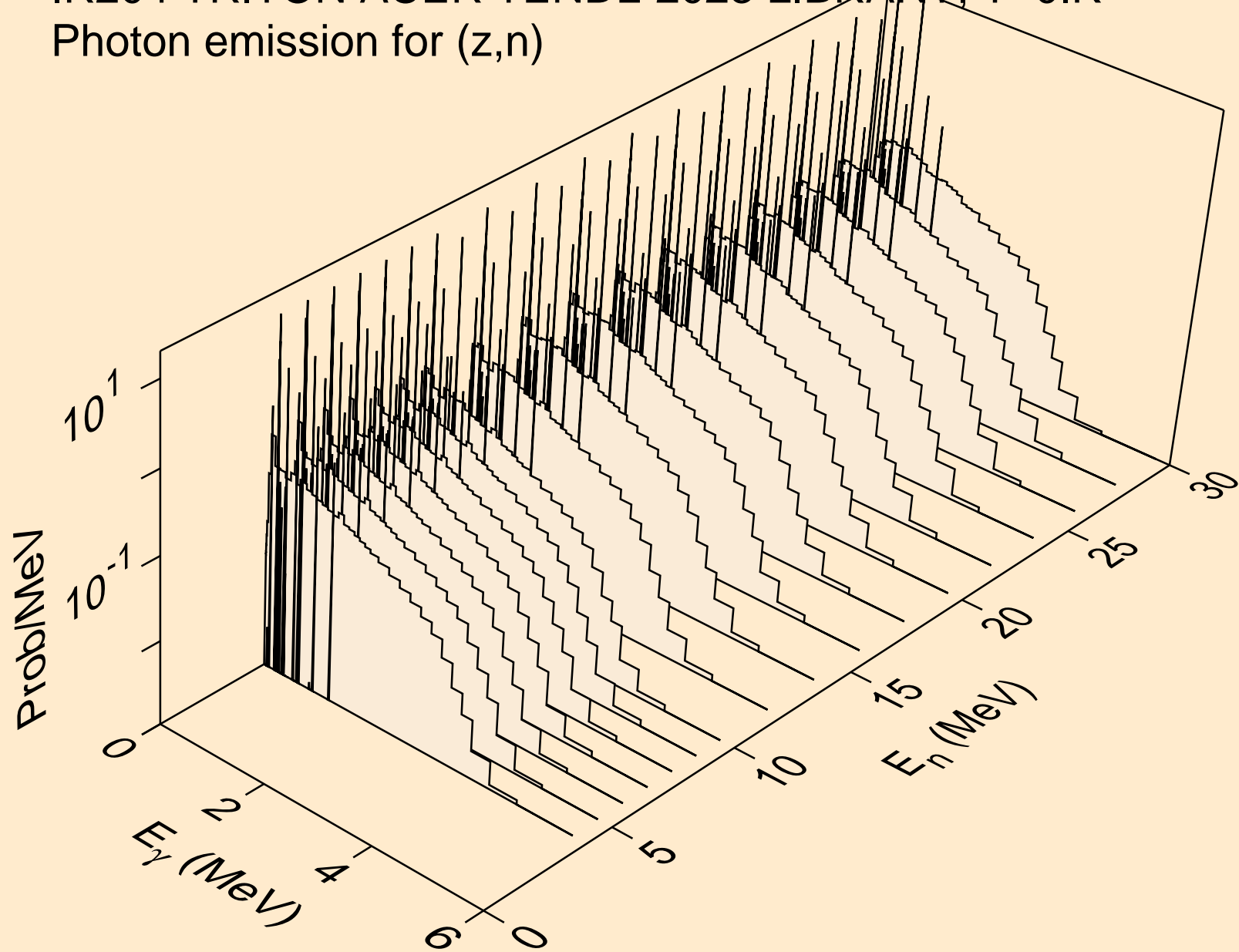

IR204 TRITON ACER TENDL-2023 LIBRARY; T=0.K
Photon emission for (z,x)

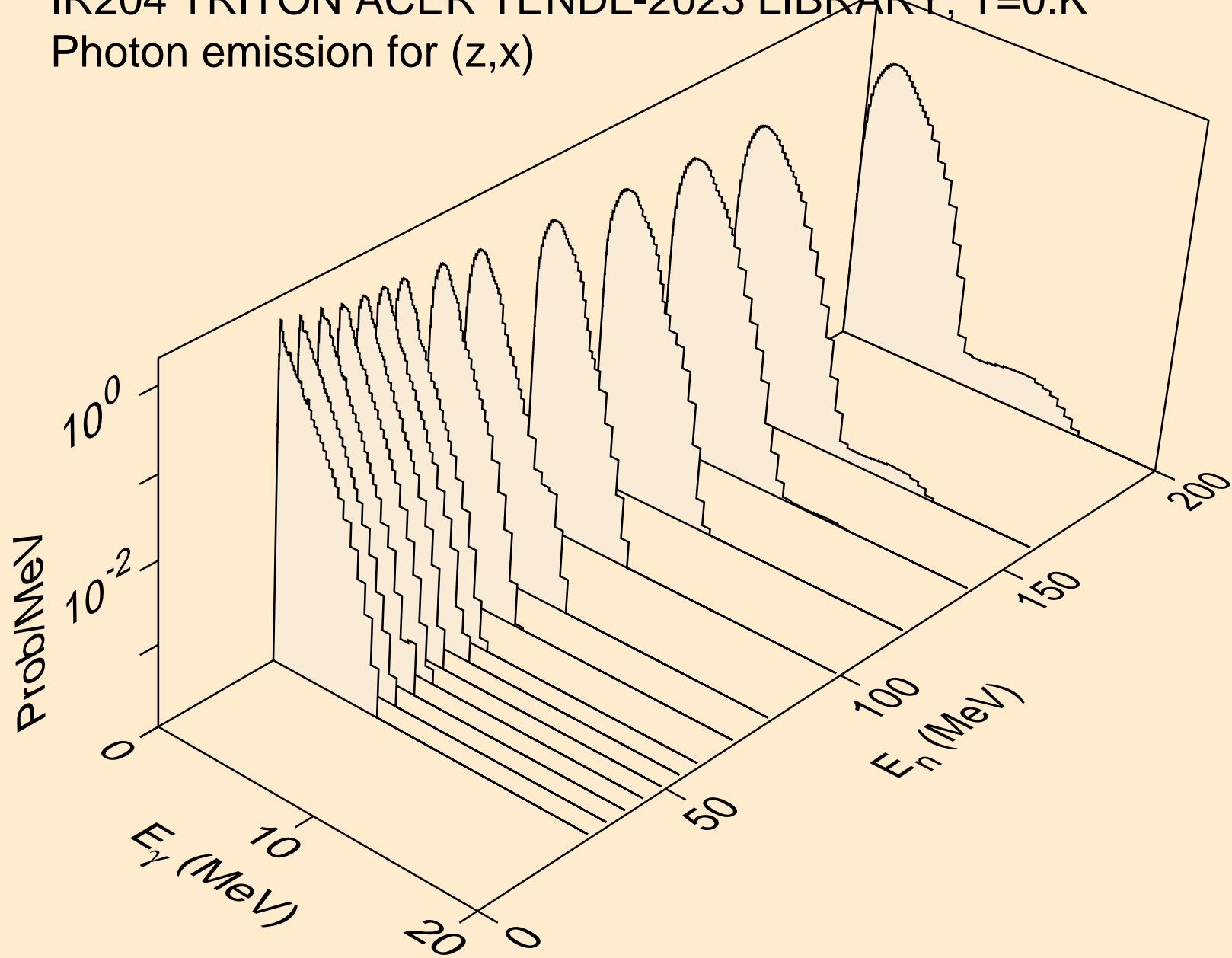

IR204 TRITON ACER TENDL-2023 LIBRARY; T=0.K
Photon emission for (n,2nd)

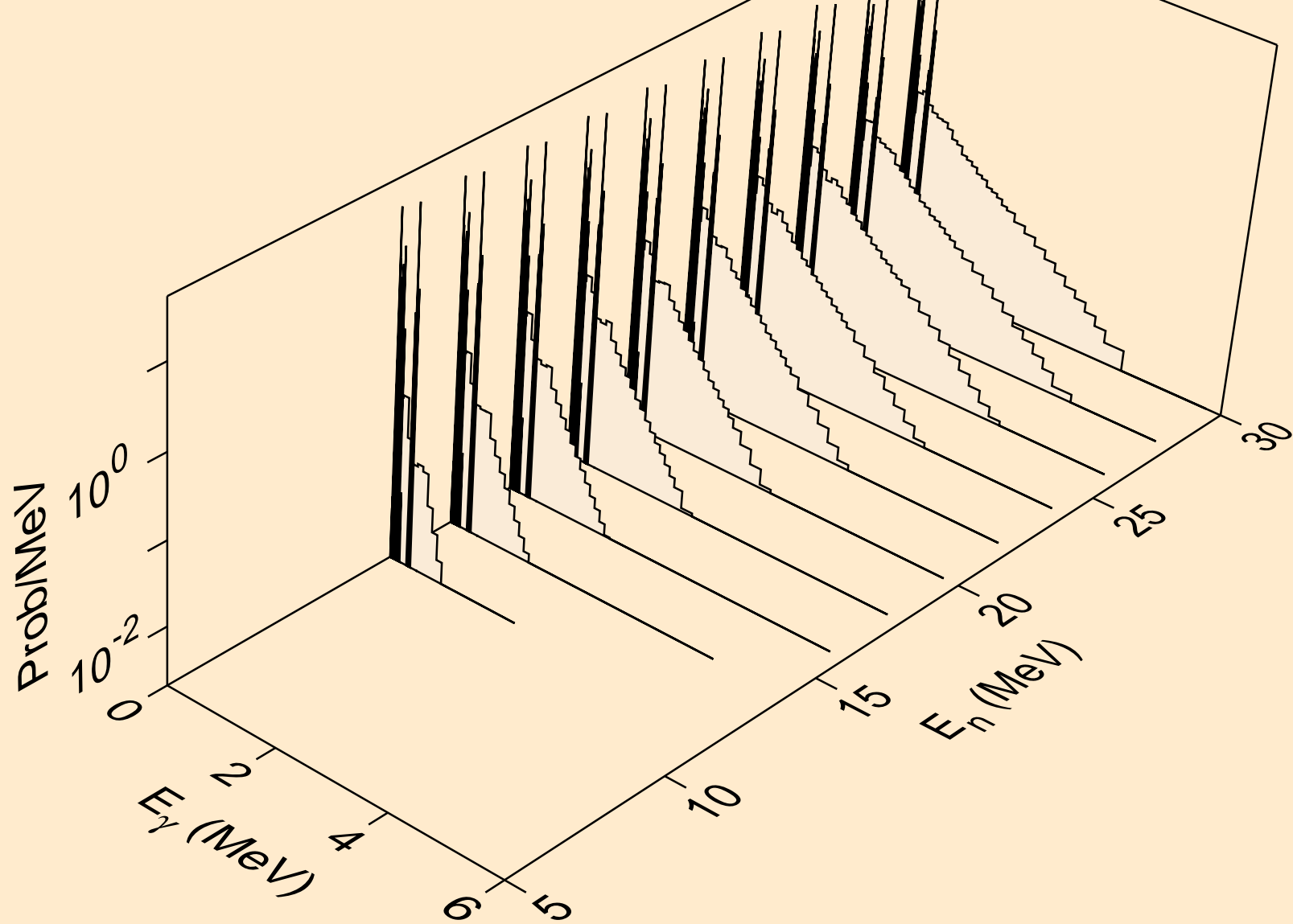

IR204 TRITON ACER TENDL-2023 LIBRARY; T=0.K
Photon emission for (n,2n)

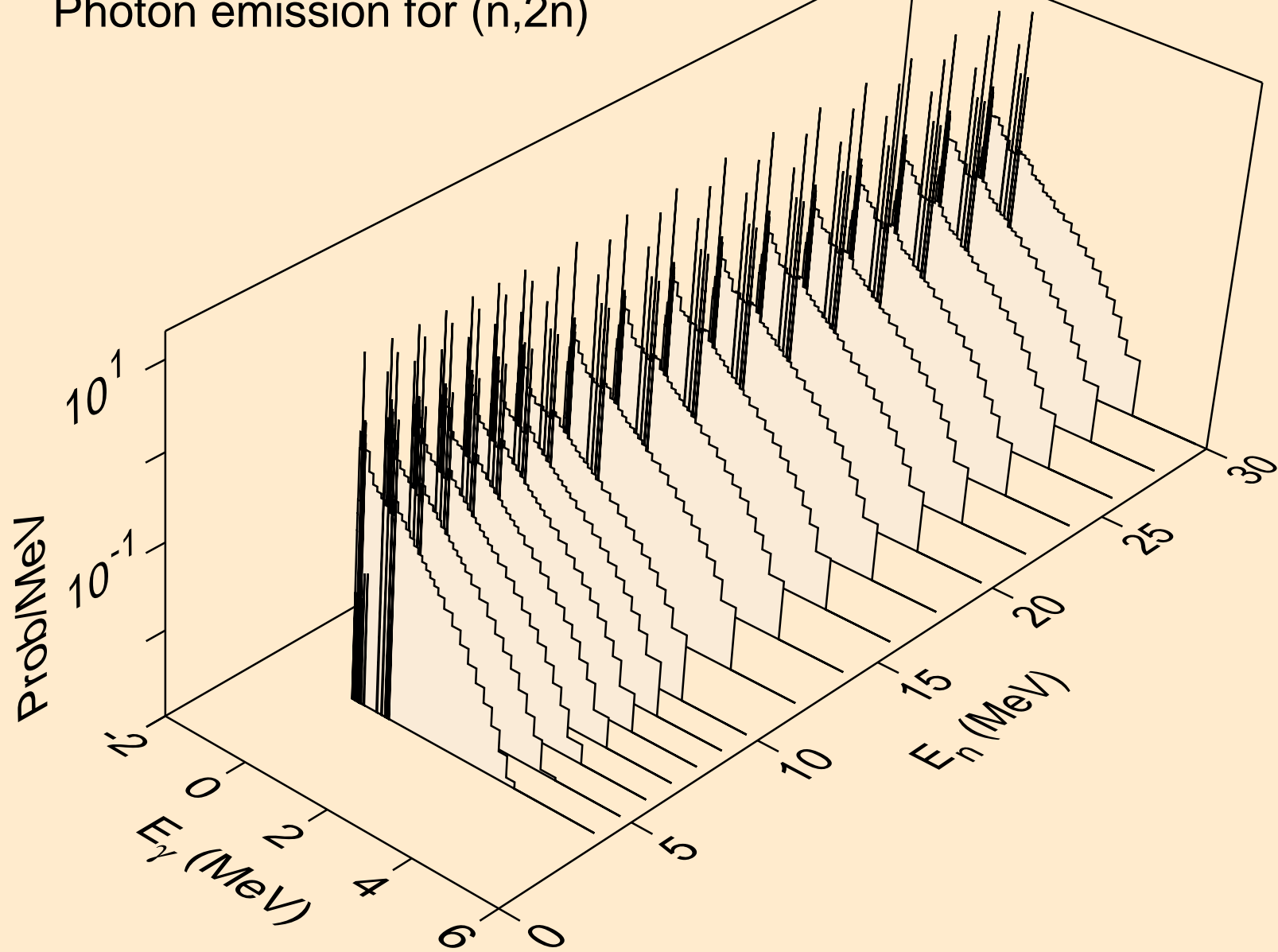

IR204 TRITON ACER TENDL-2023 LIBRARY; T=0.K
Photon emission for (n,3n)

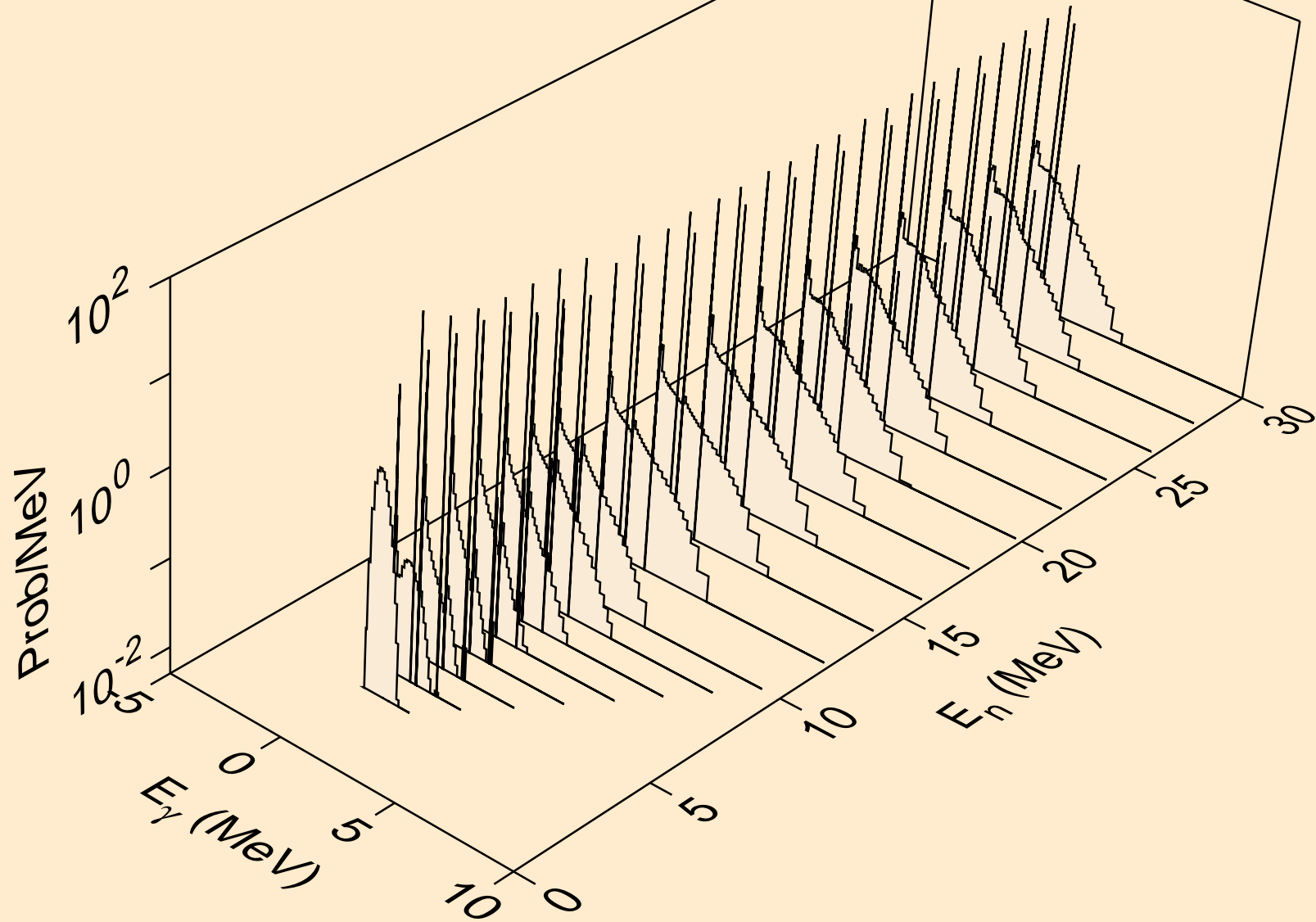

IR204 TRITON ACER TENDL-2023 LIBRARY; T=0.K
Photon emission for (n,n*)a

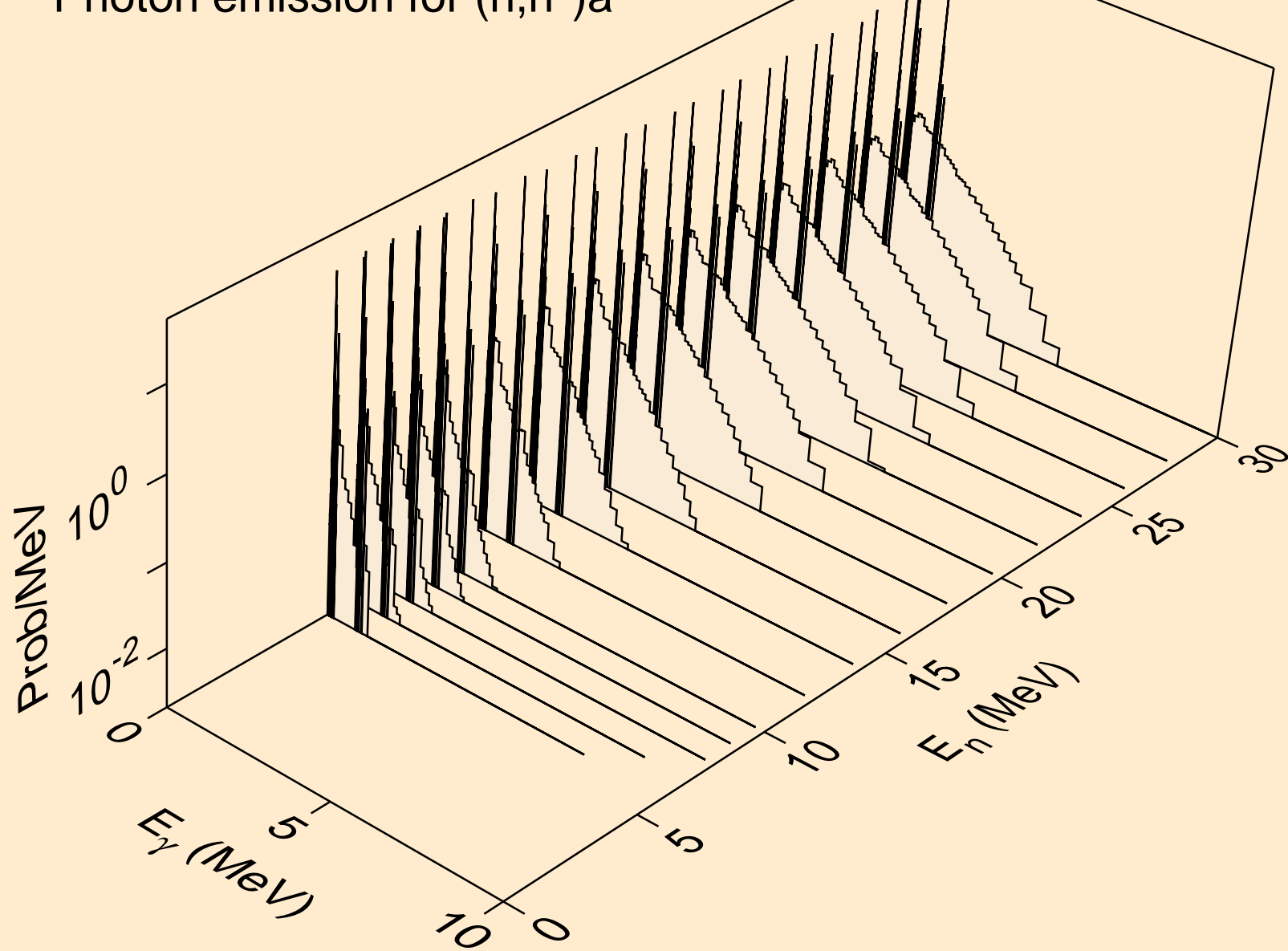

IR204 TRITON ACER TENDL-2023 LIBRARY; T=0.K
Photon emission for (n,2n)a

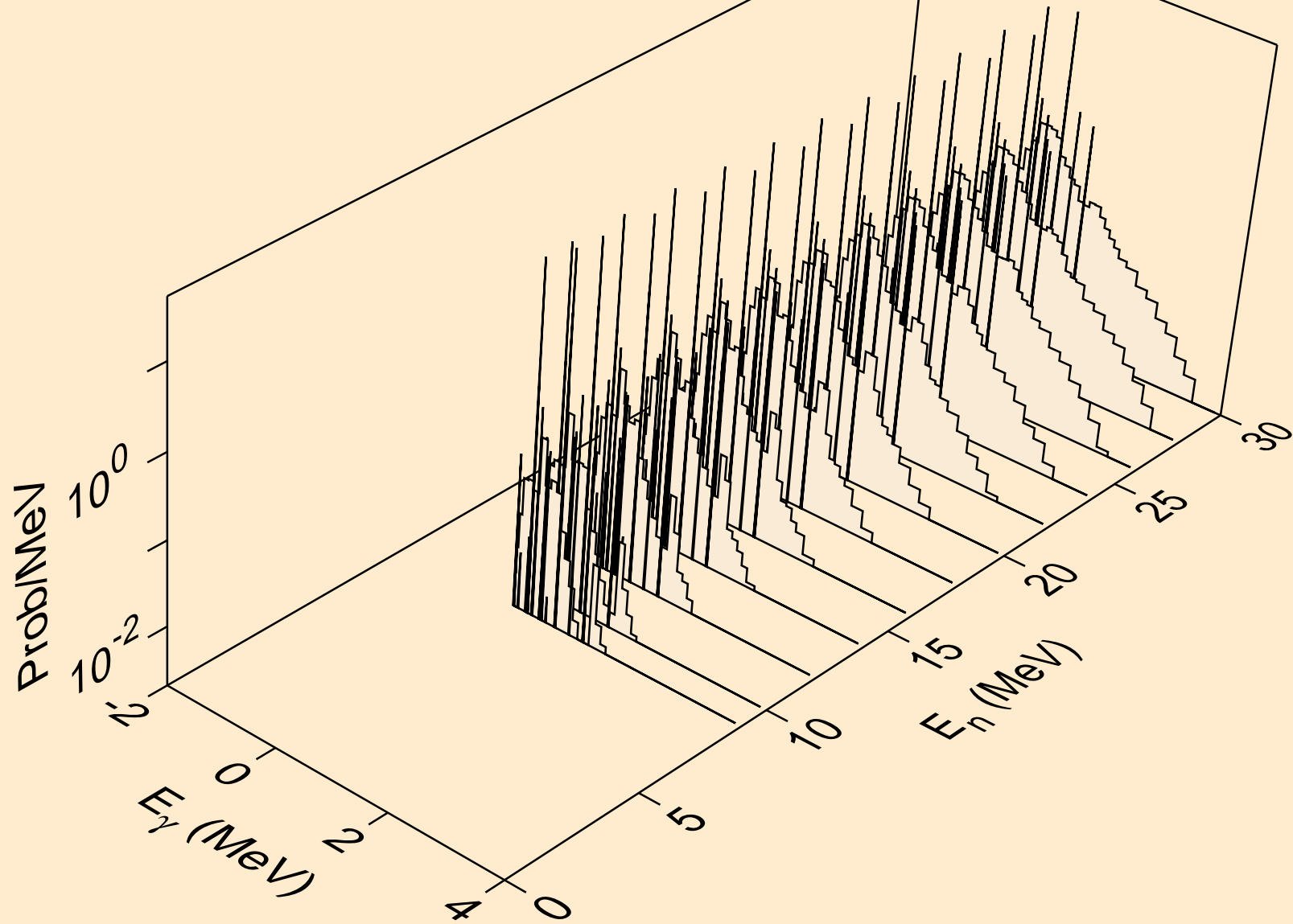

IR204 TRITON ACER TENDL-2023 LIBRARY; T=0.K
Photon emission for (n,3n)a

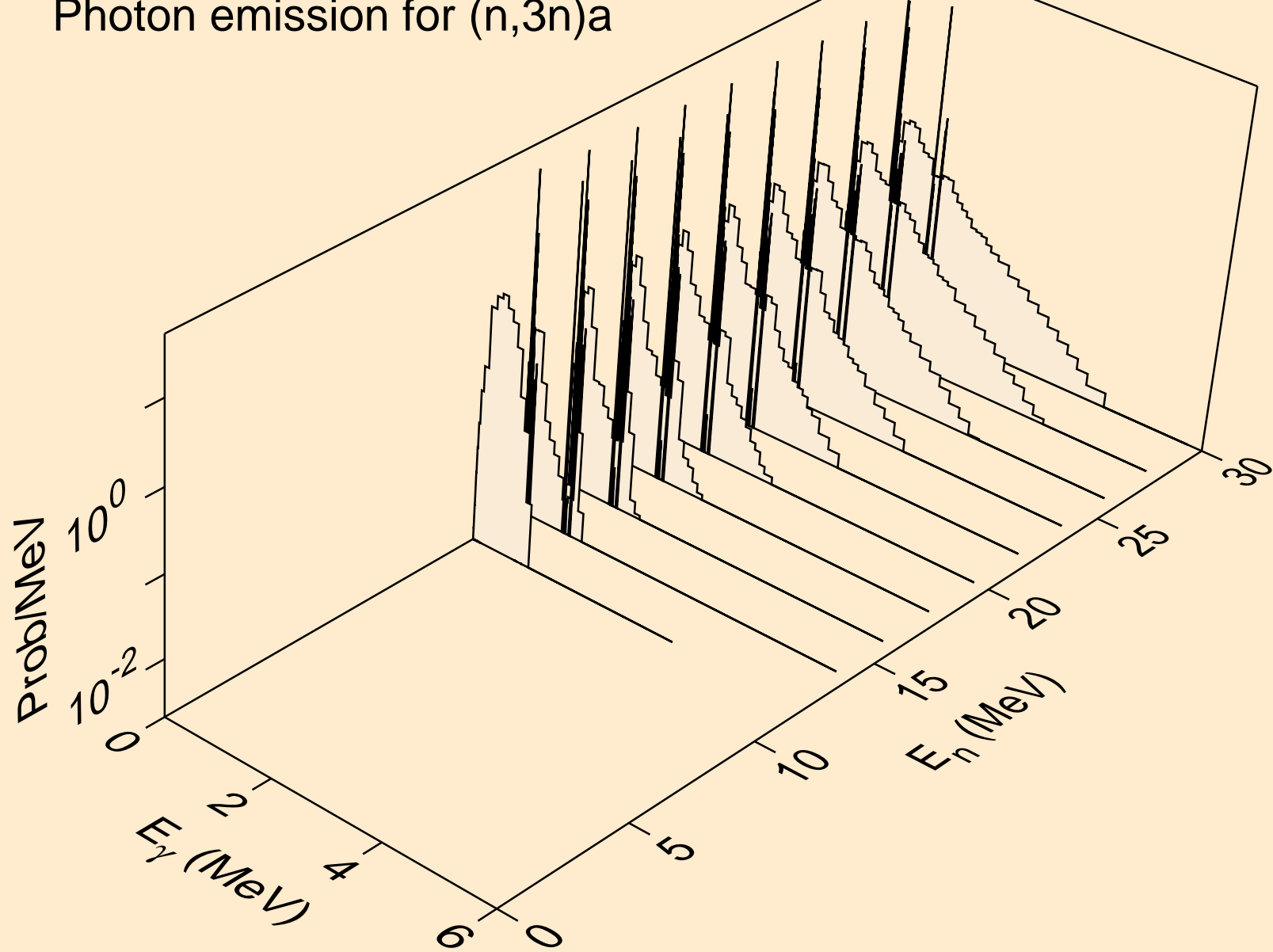

IR204 TRITON ACER TENDL-2023 LIBRARY; T=0.K
Photon emission for (n,n*)p

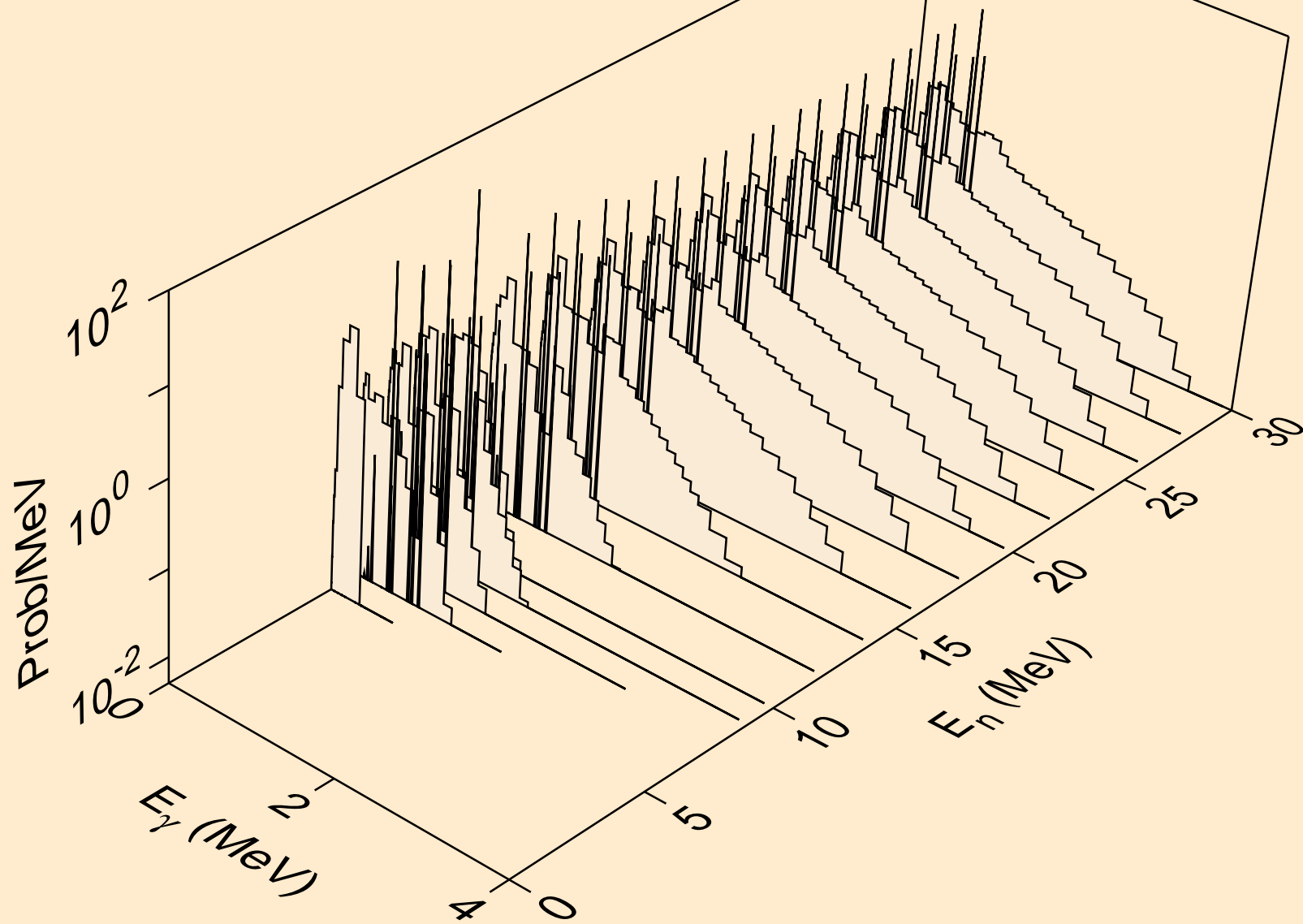

IR204 TRITON ACER TENDL-2023 LIBRARY; T=0.K
Photon emission for (n,n*)d

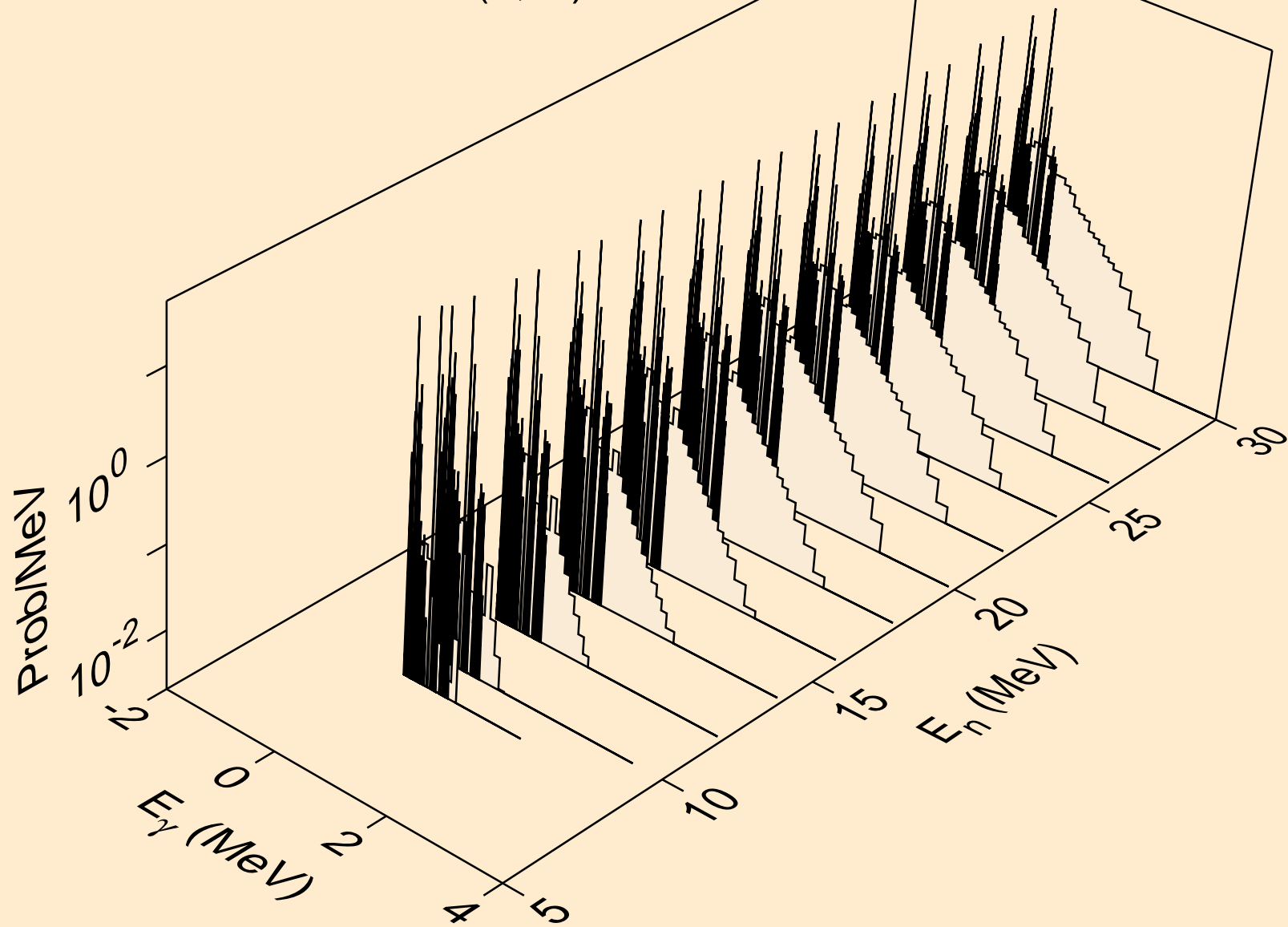

IR204 TRITON ACER TENDL-2023 LIBRARY; T=0.K
Photon emission for (n,n*)t

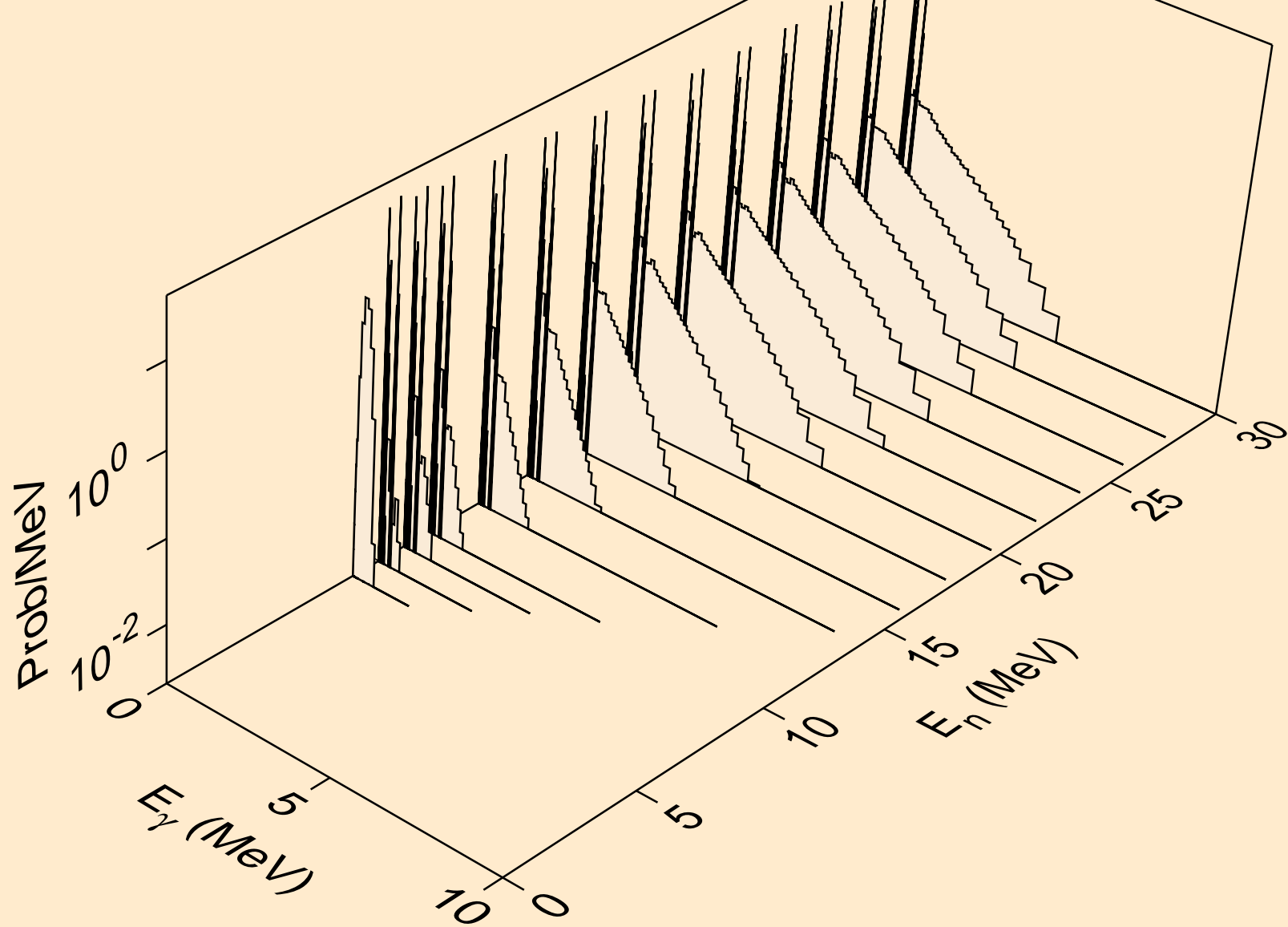

IR204 TRITON ACER TENDL-2023 LIBRARY; T=0.K
Photon emission for (n,n*)he3

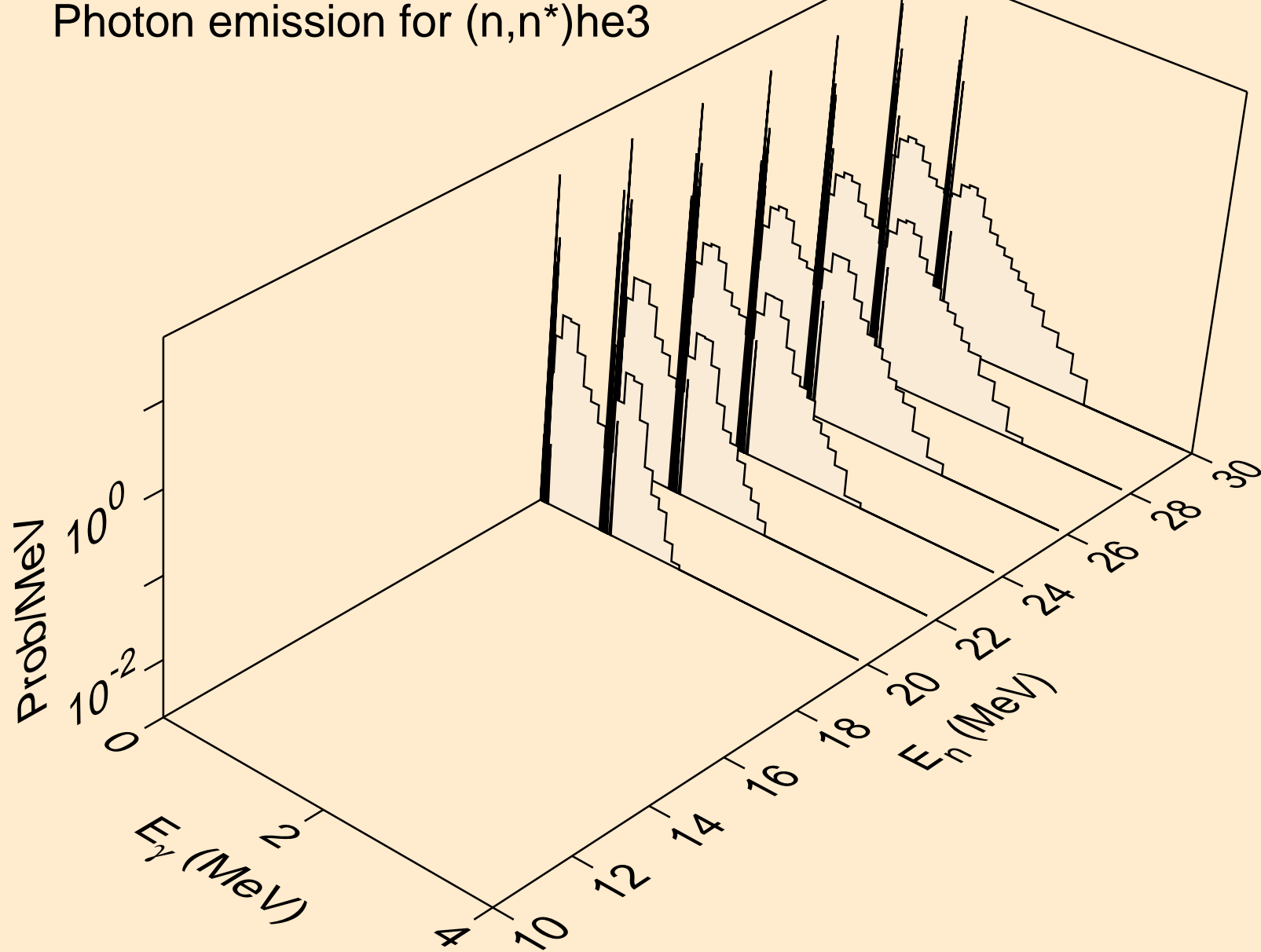

IR204 TRITON ACER TENDL-2023 LIBRARY; T=0.K
Photon emission for (n,4n)

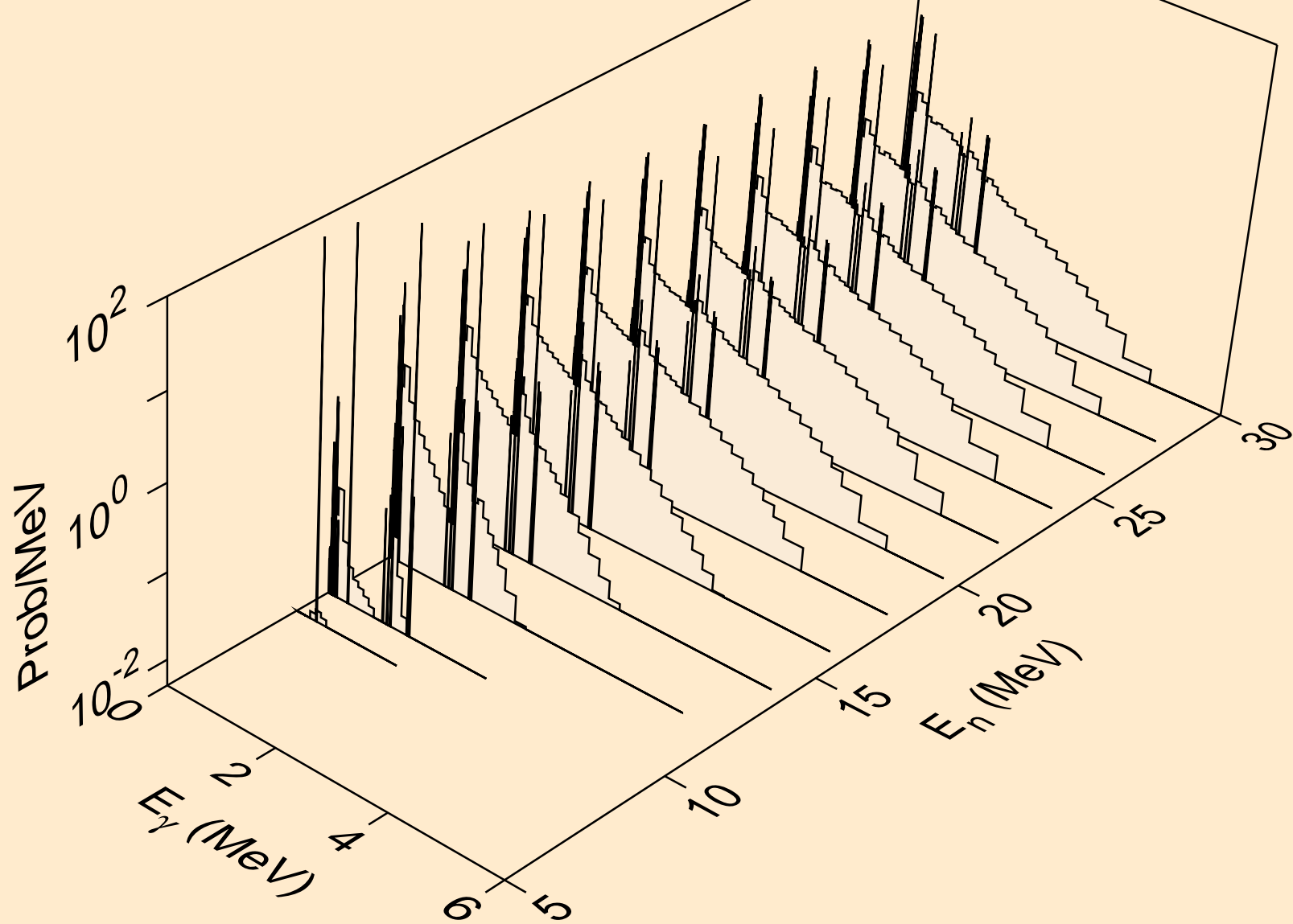

IR204 TRITON ACER TENDL-2023 LIBRARY; T=0.K
Photon emission for (n,2np)

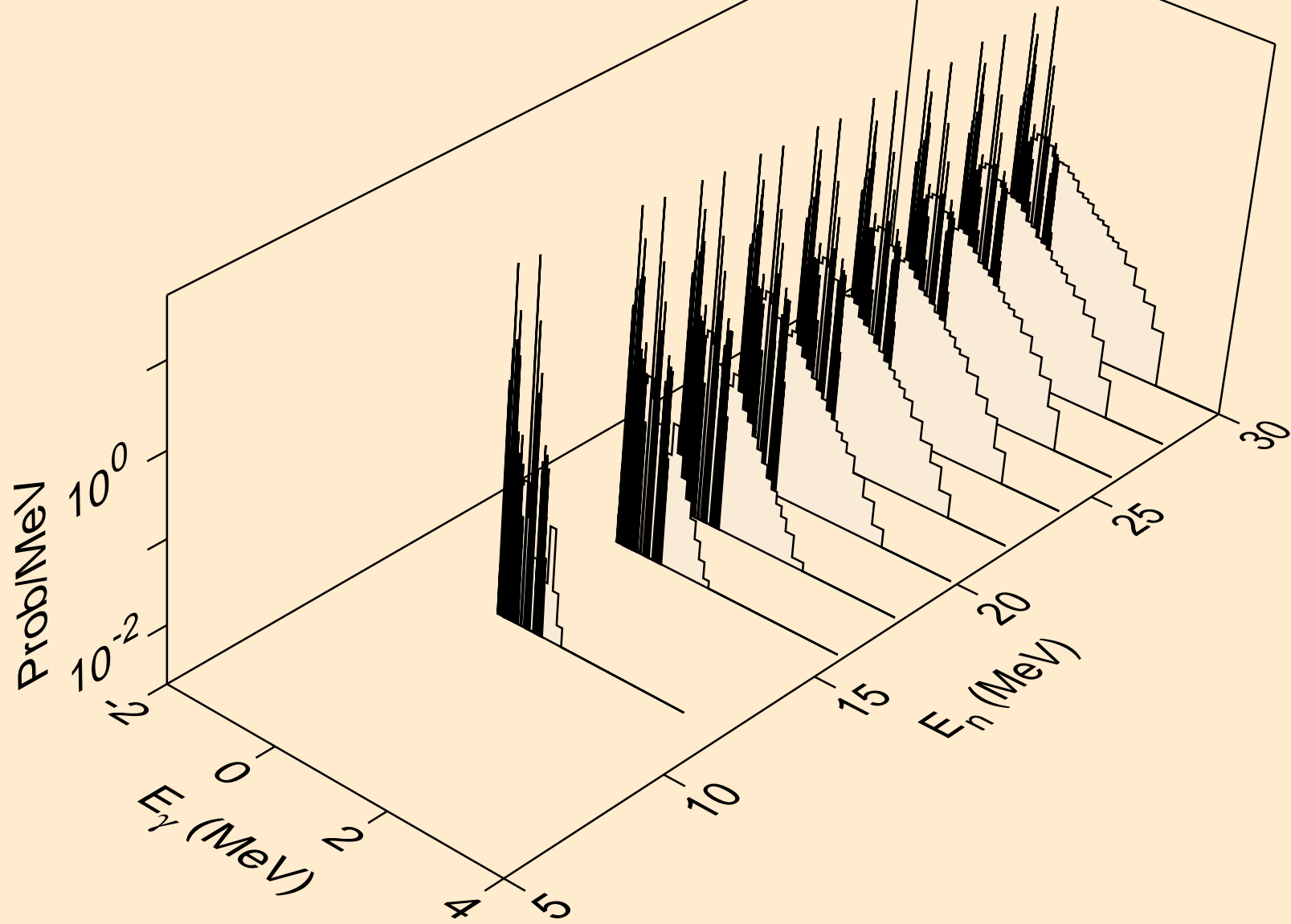

IR204 TRITON ACER TENDL-2023 LIBRARY; T=0.K
Photon emission for (n,3np)

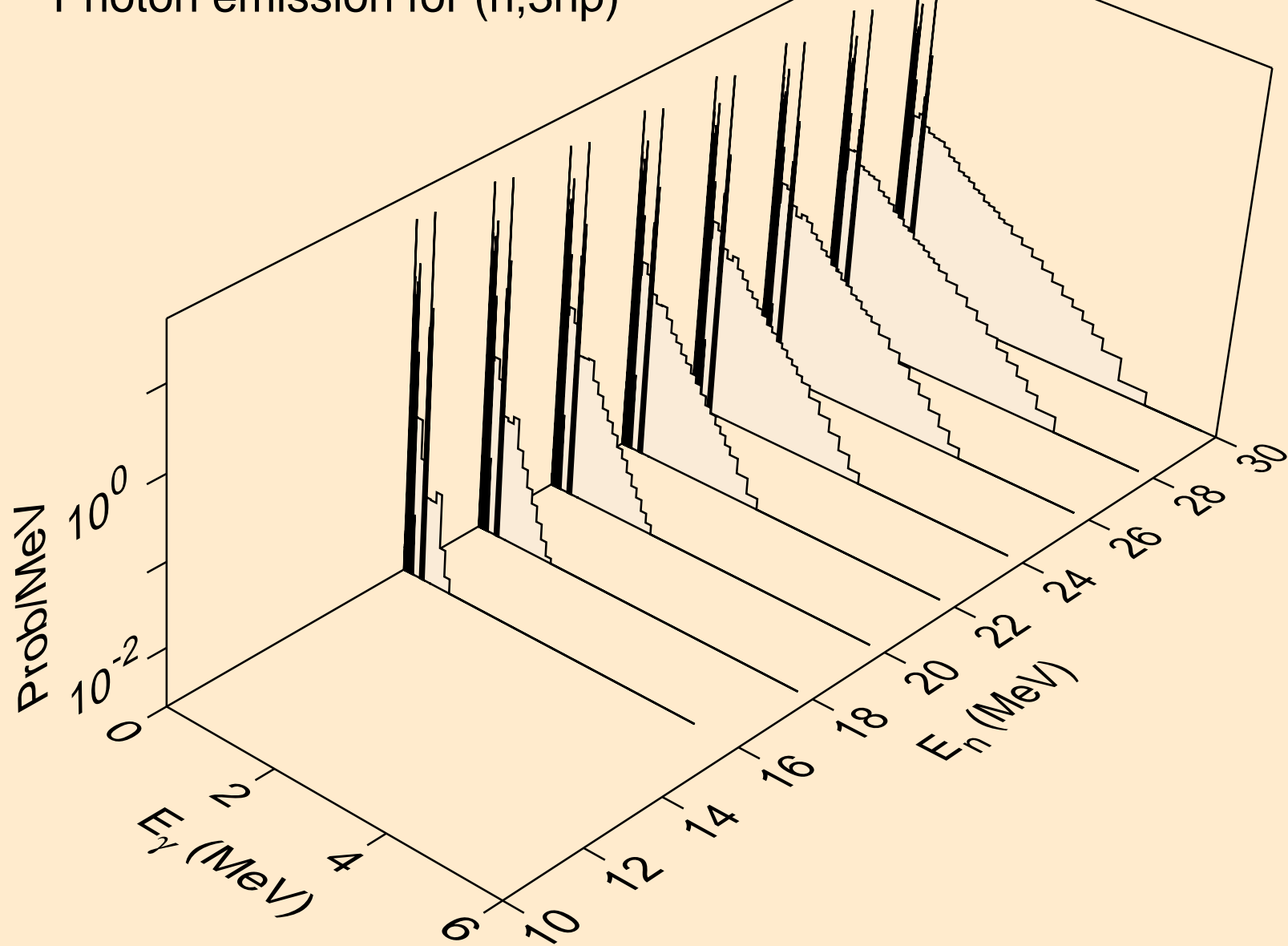

IR204 TRITON ACER TENDL-2023 LIBRARY; T=0.K
Photon emission for (n,n2p)

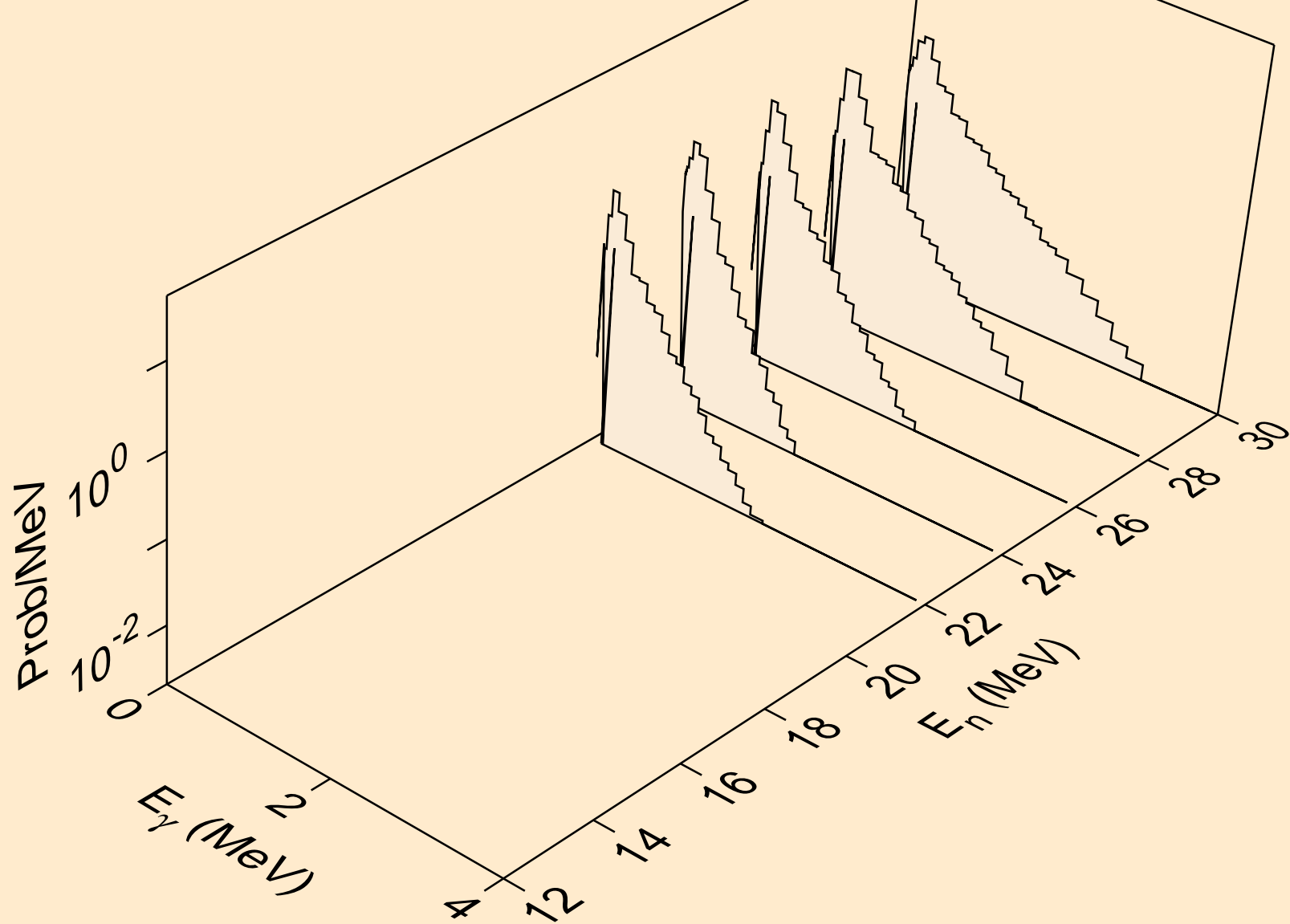

IR204 TRITON ACER TENDL-2023 LIBRARY; T=0.K
Photon emission for (n,gma)

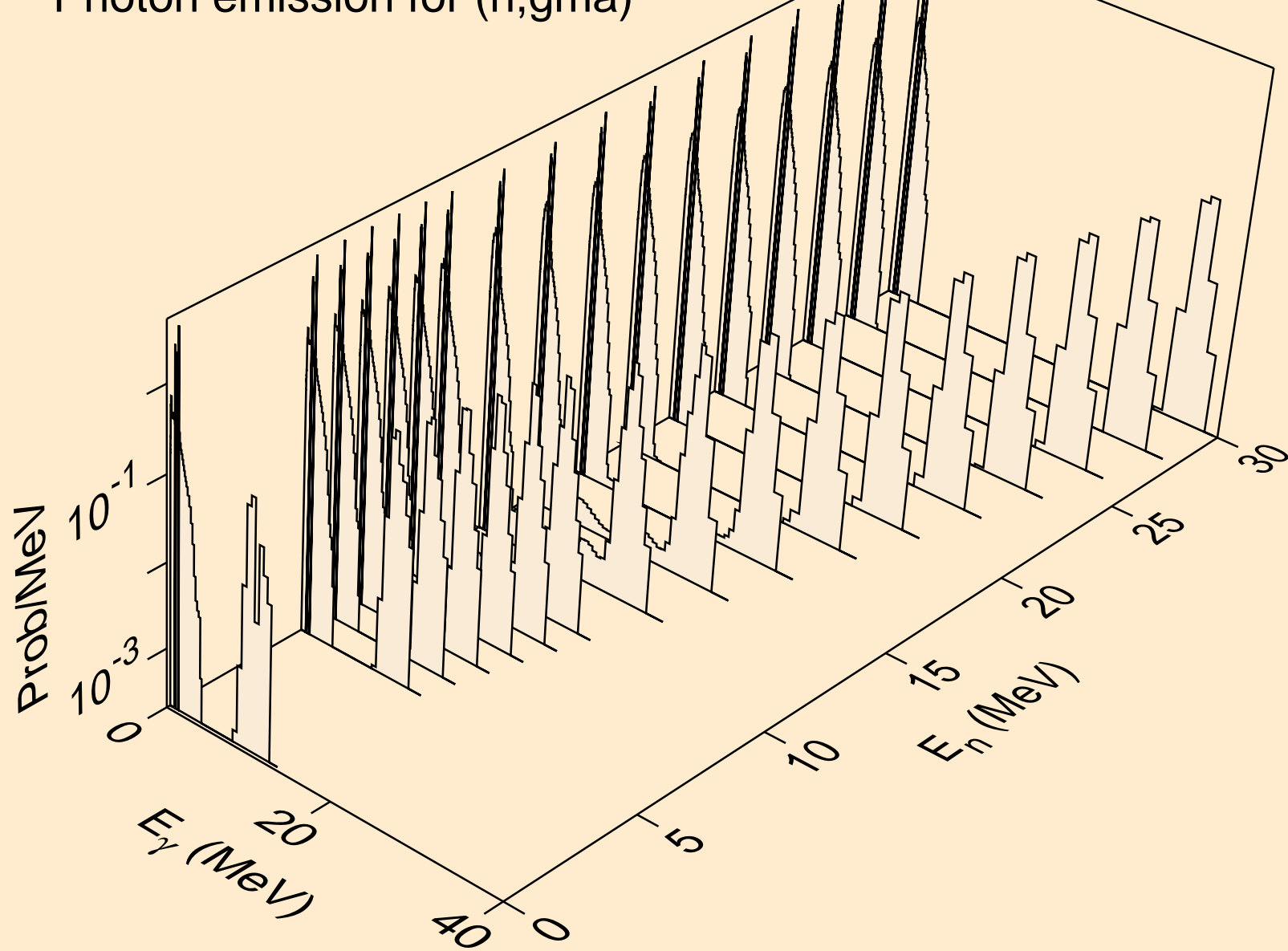

IR204 TRITON ACER TENDL-2023 LIBRARY; T=0.K
Photon emission for (n,p)

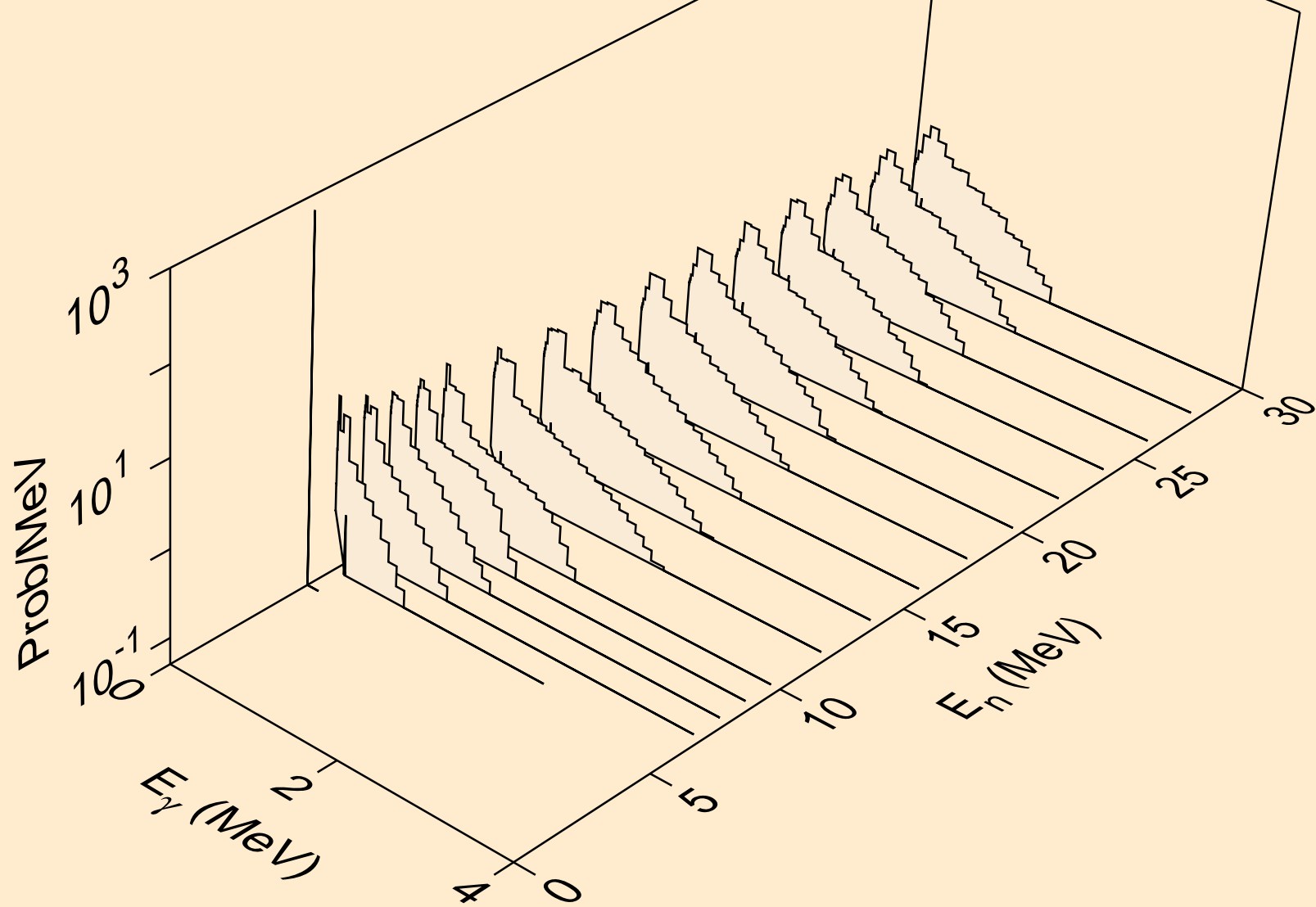

IR204 TRITON ACER TENDL-2023 LIBRARY; T=0.K
Photon emission for (n,d)

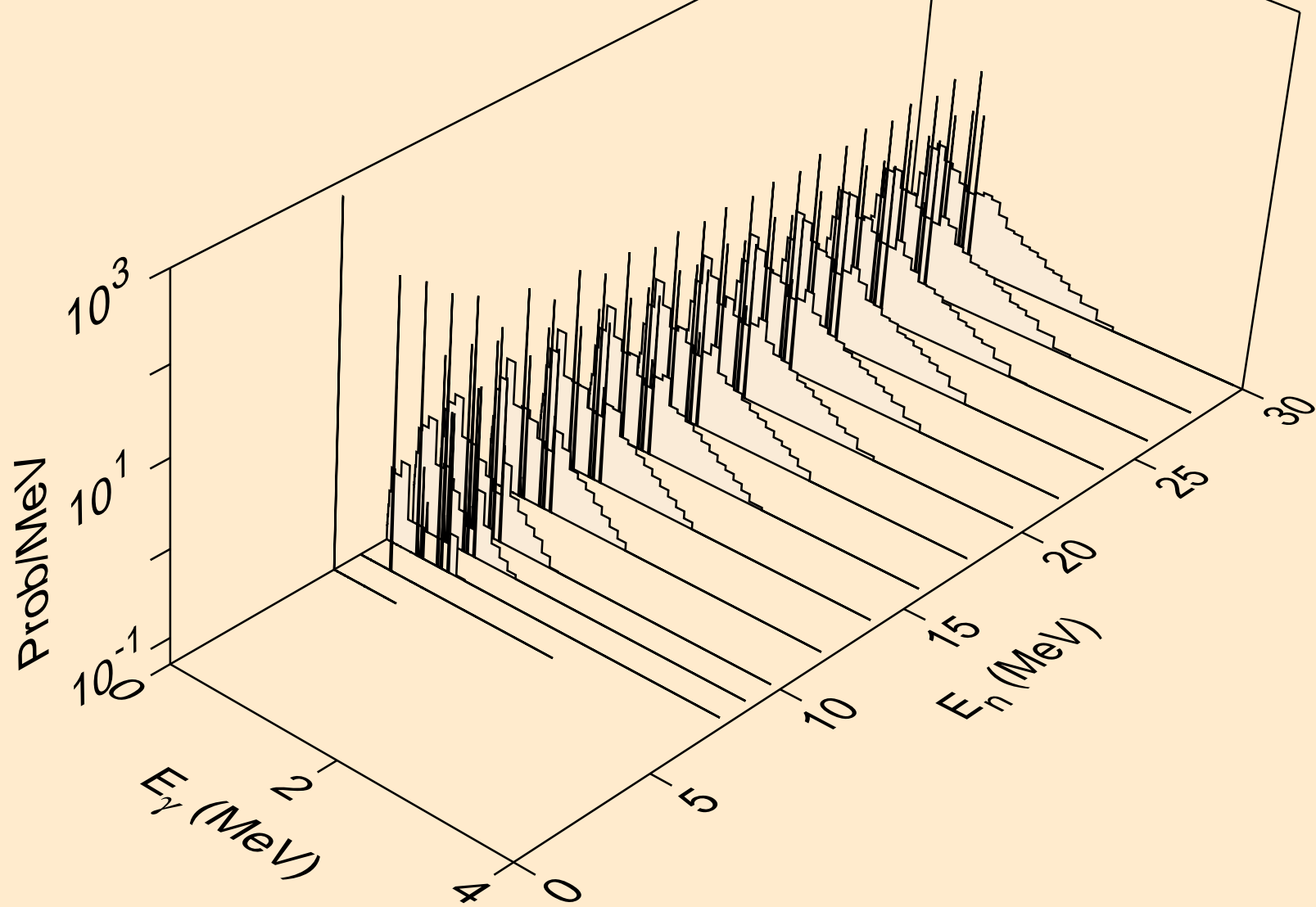

IR204 TRITON ACER TENDL-2023 LIBRARY; T=0.K
Photon emission for inelastic

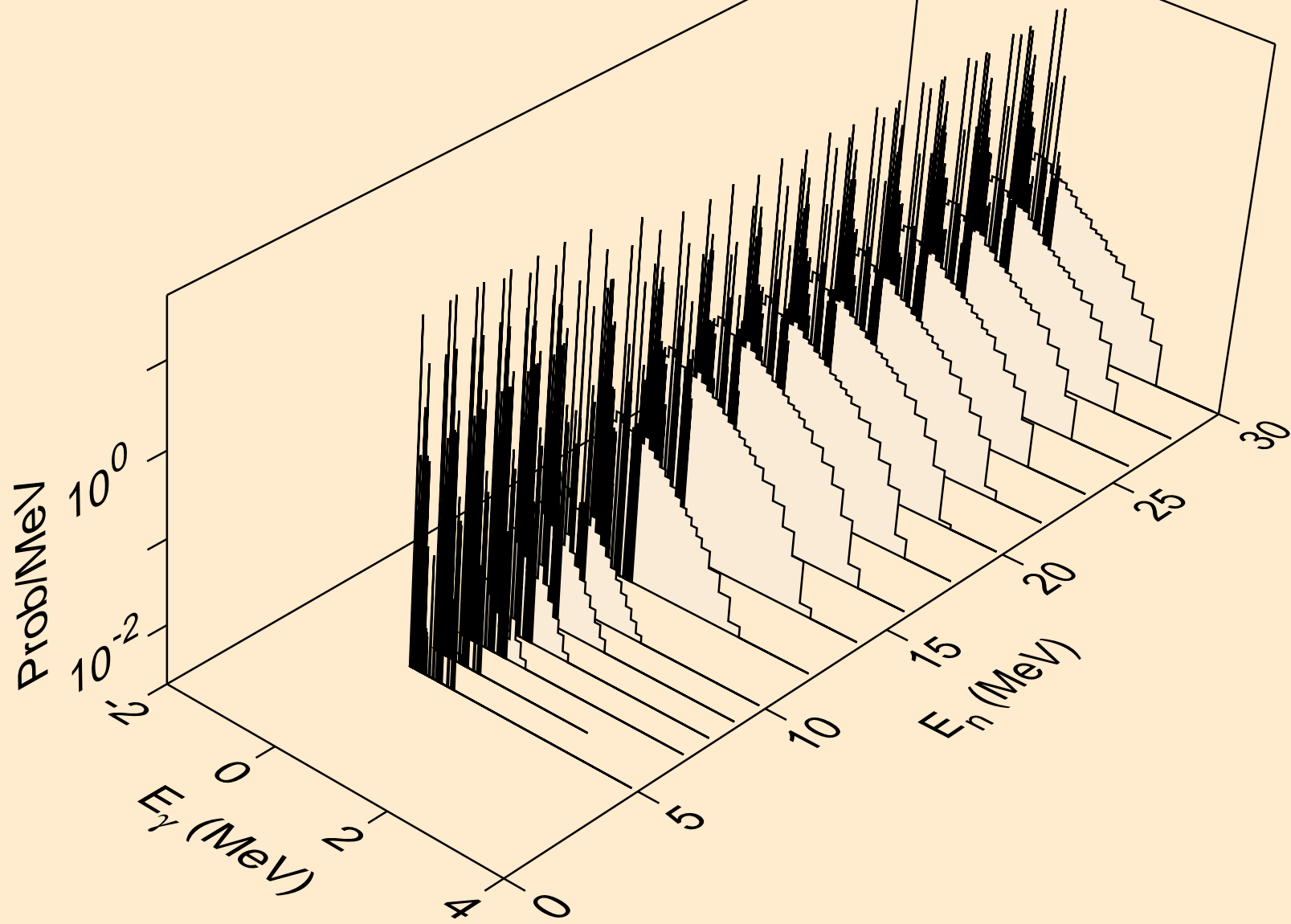

IR204 TRITON ACER TENDL-2023 LIBRARY; T=0.K
Photon emission for (n,he3)

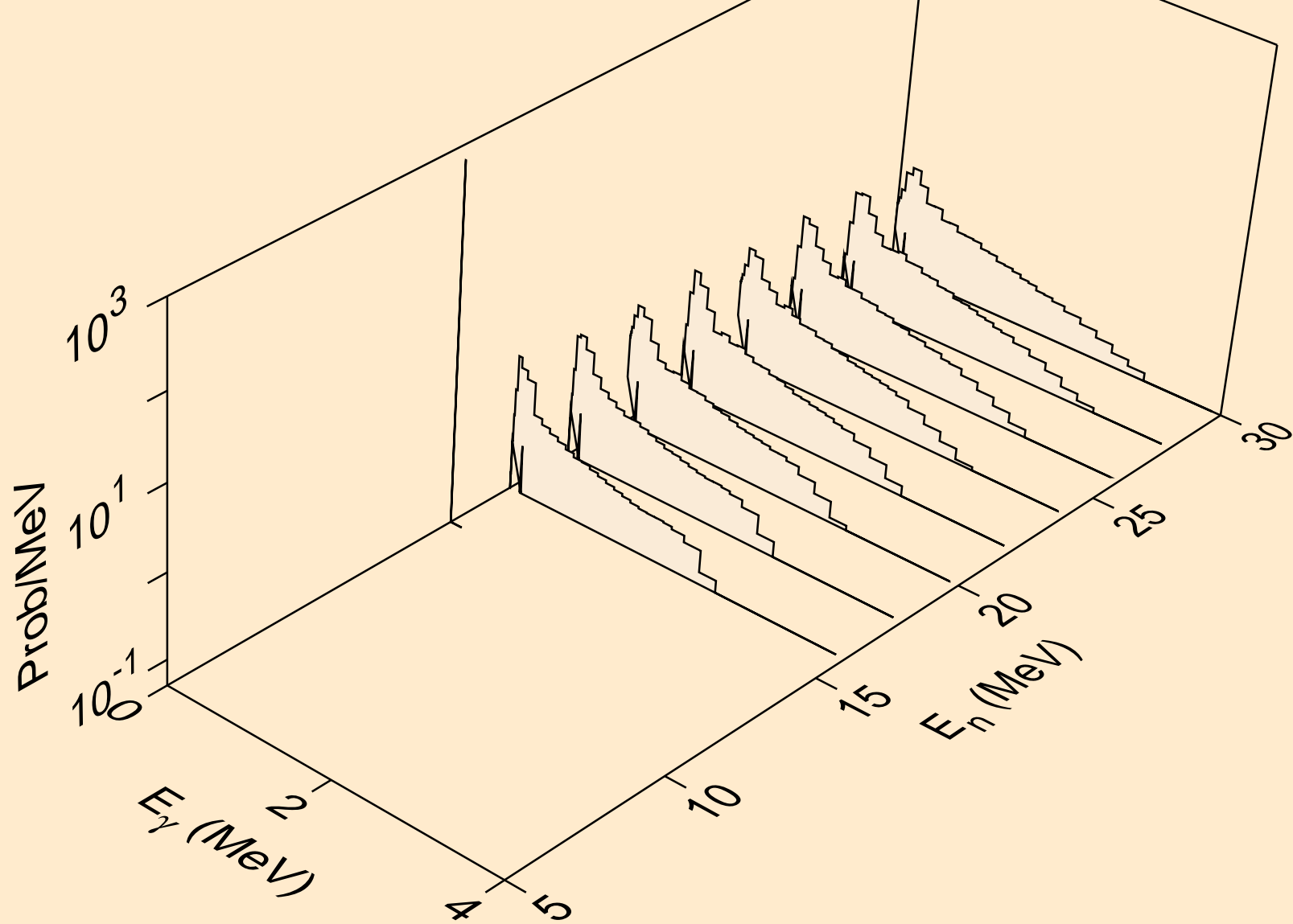

IR204 TRITON ACER TENDL-2023 LIBRARY; T=0.K
Photon emission for (n,a)

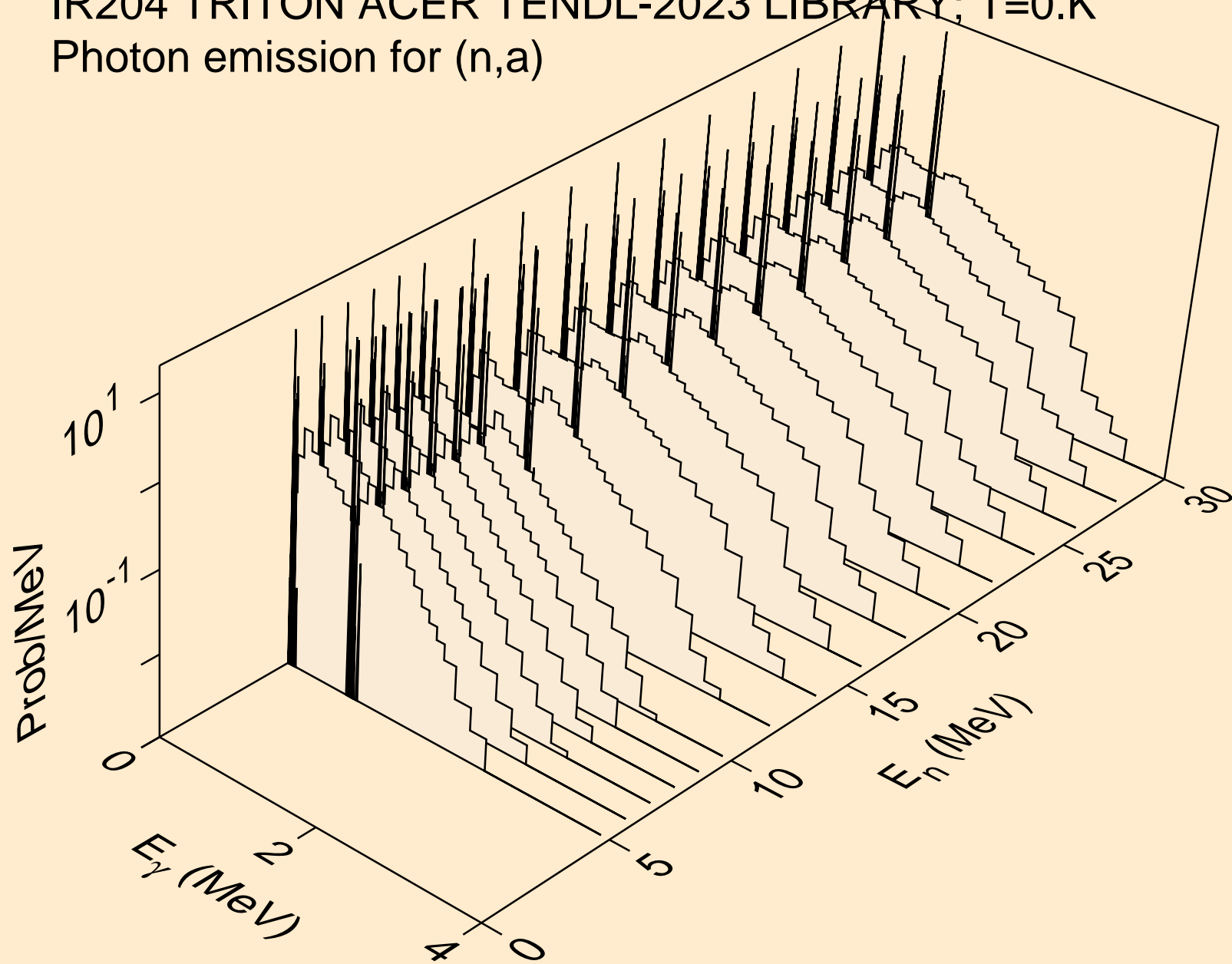

IR204 TRITON ACER TENDL-2023 LIBRARY; T=0.K
Particle heating contributions

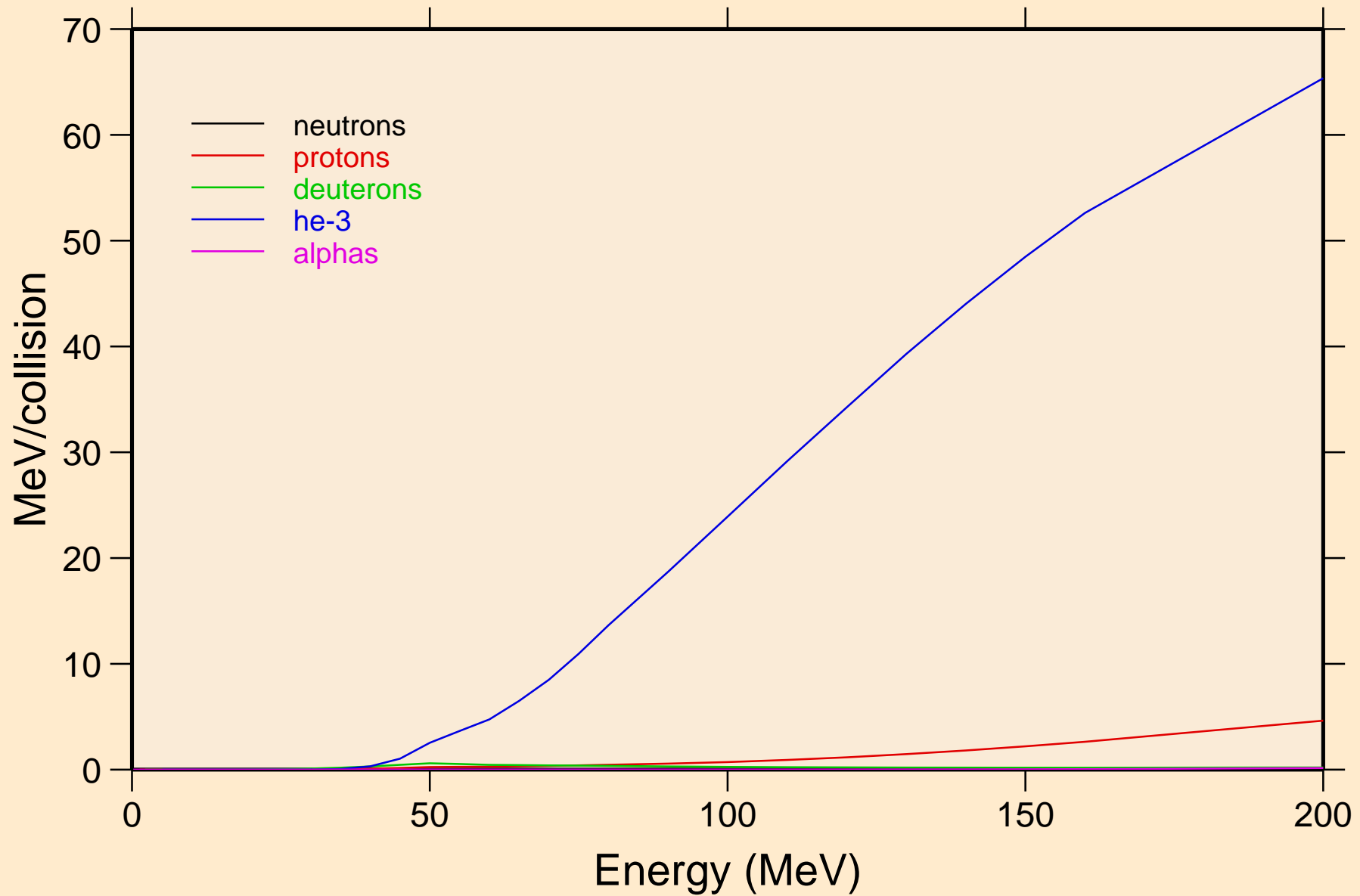

IR204 TRITON ACER TENDL-2023 LIBRARY; T=0.K
Recoil Heating

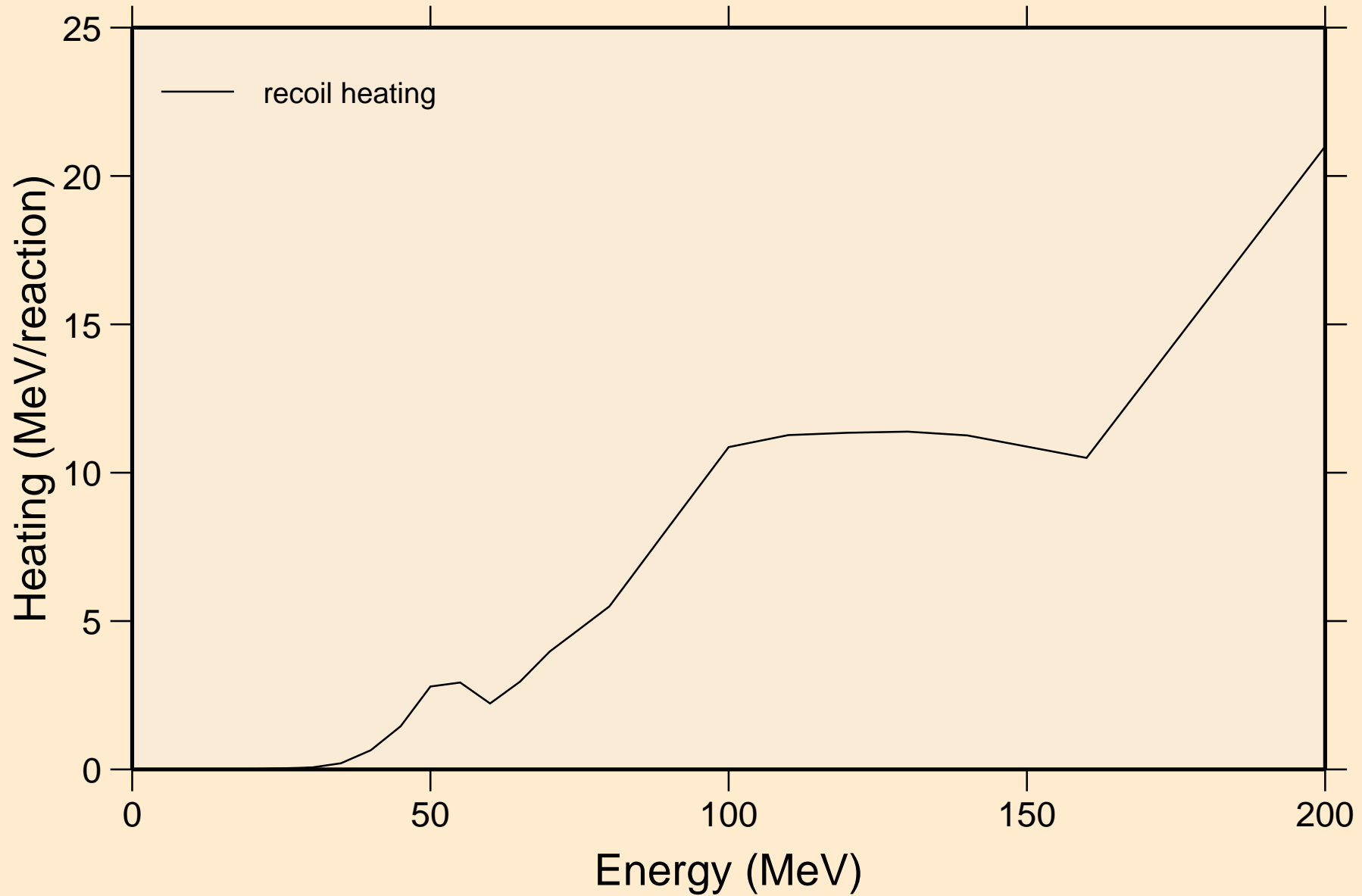

IR204 TRITON ACER TENDL-2023 LIBRARY; T=0.K
Particle production cross sections

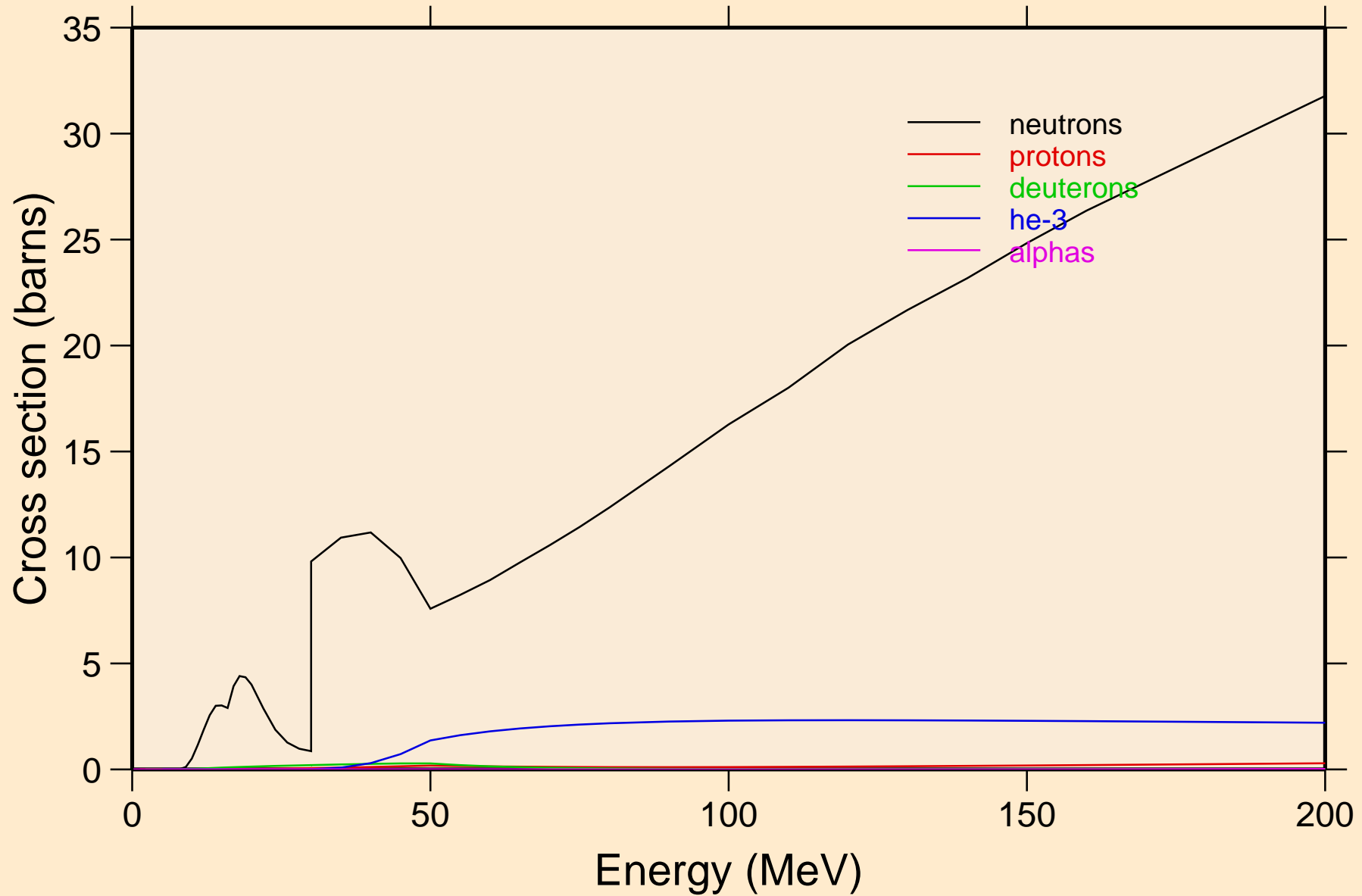

IR204 TRITON ACER TENDL-2023 LIBRARY; T=0.K
neutrons from (t,n)

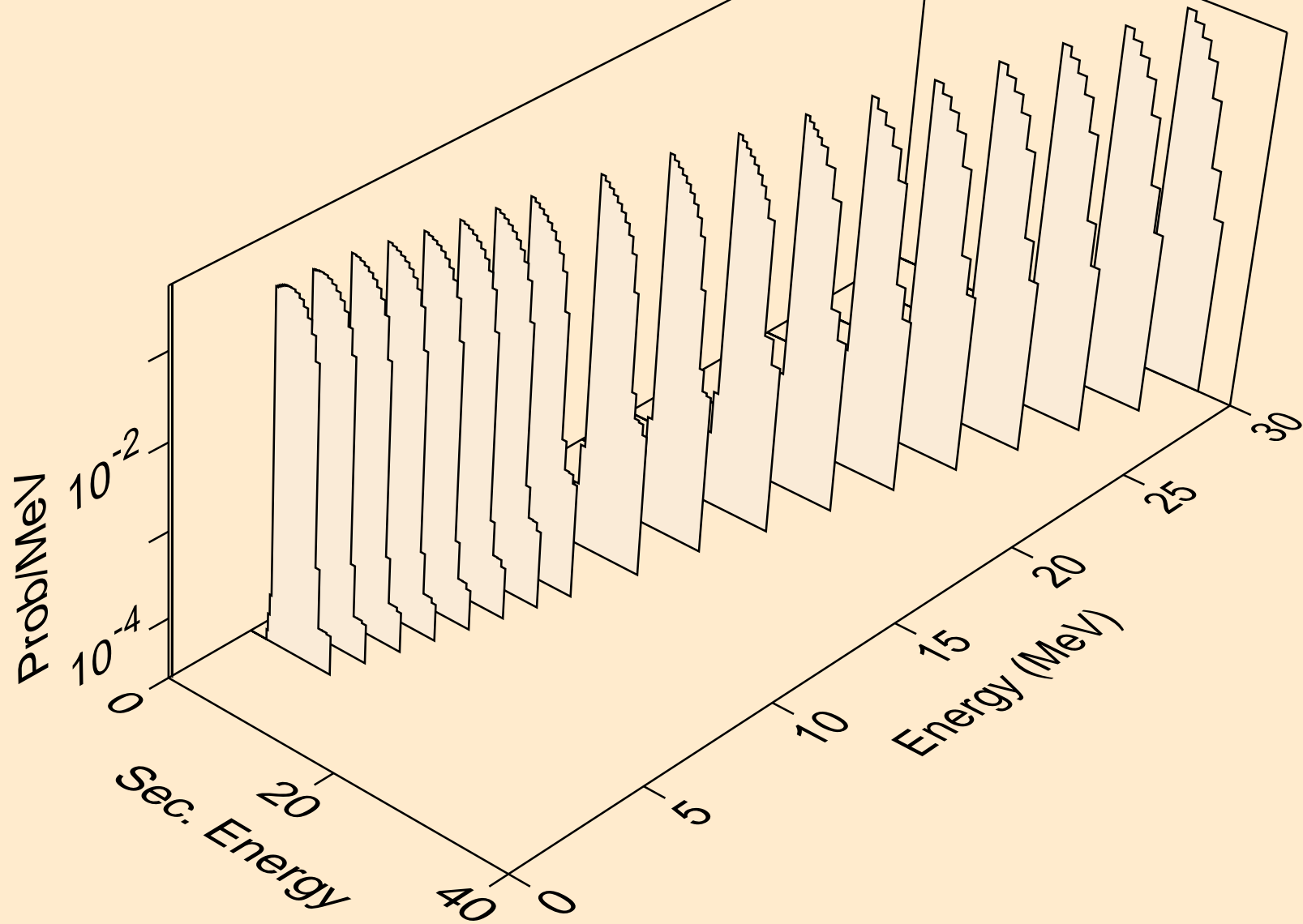

IR204 TRITON ACER TENDL-2023 LIBRARY; T=0.K
neutrons from (t,x)

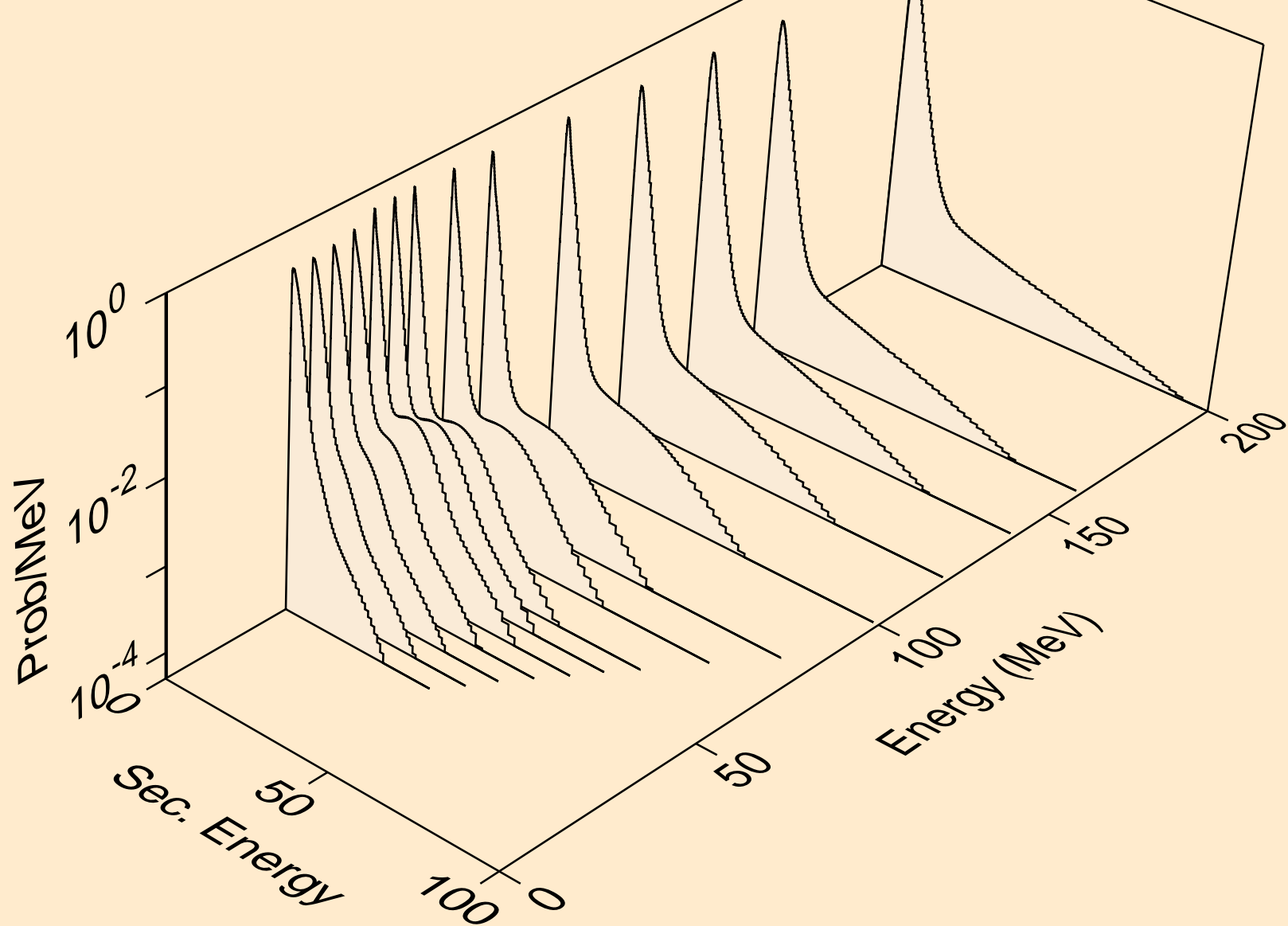

IR204 TRITON ACER TENDL-2023 LIBRARY; T=0.K
neutrons from (t,2nd)

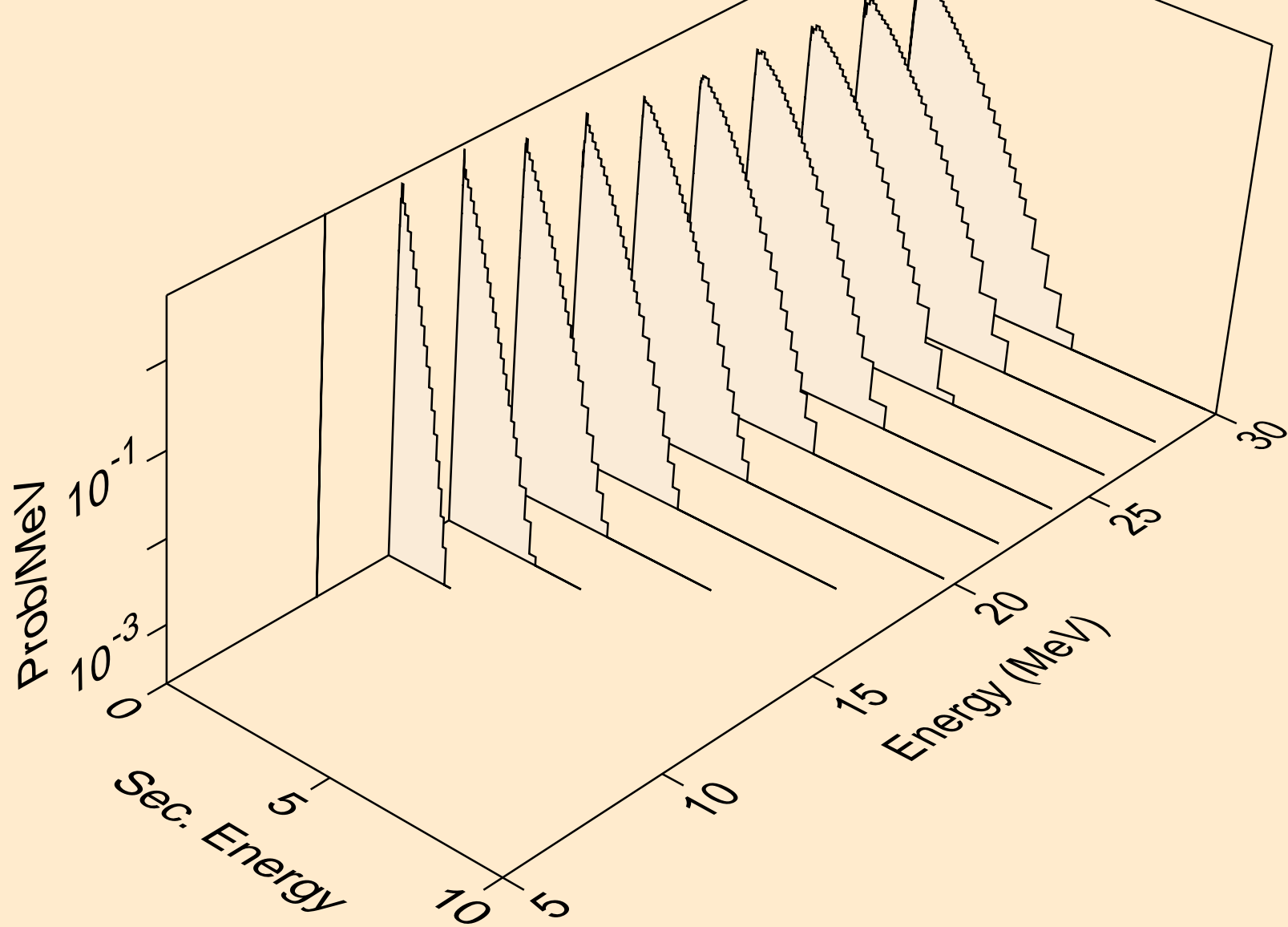

IR204 TRITON ACER TENDL-2023 LIBRARY; T=0.K
neutrons from (t,2n)

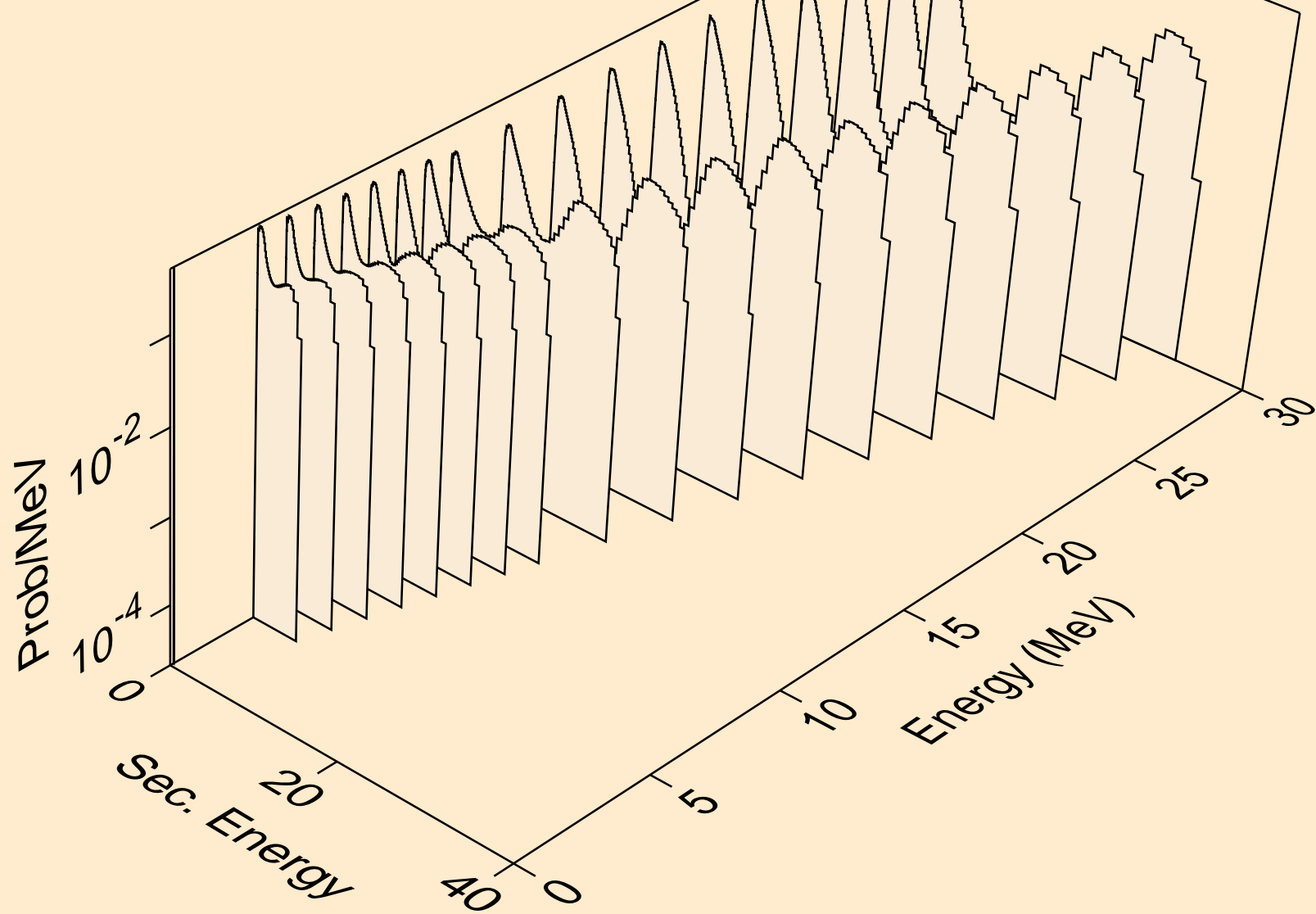

IR204 TRITON ACER TENDL-2023 LIBRARY; T=0.K
neutrons from (t,3n)

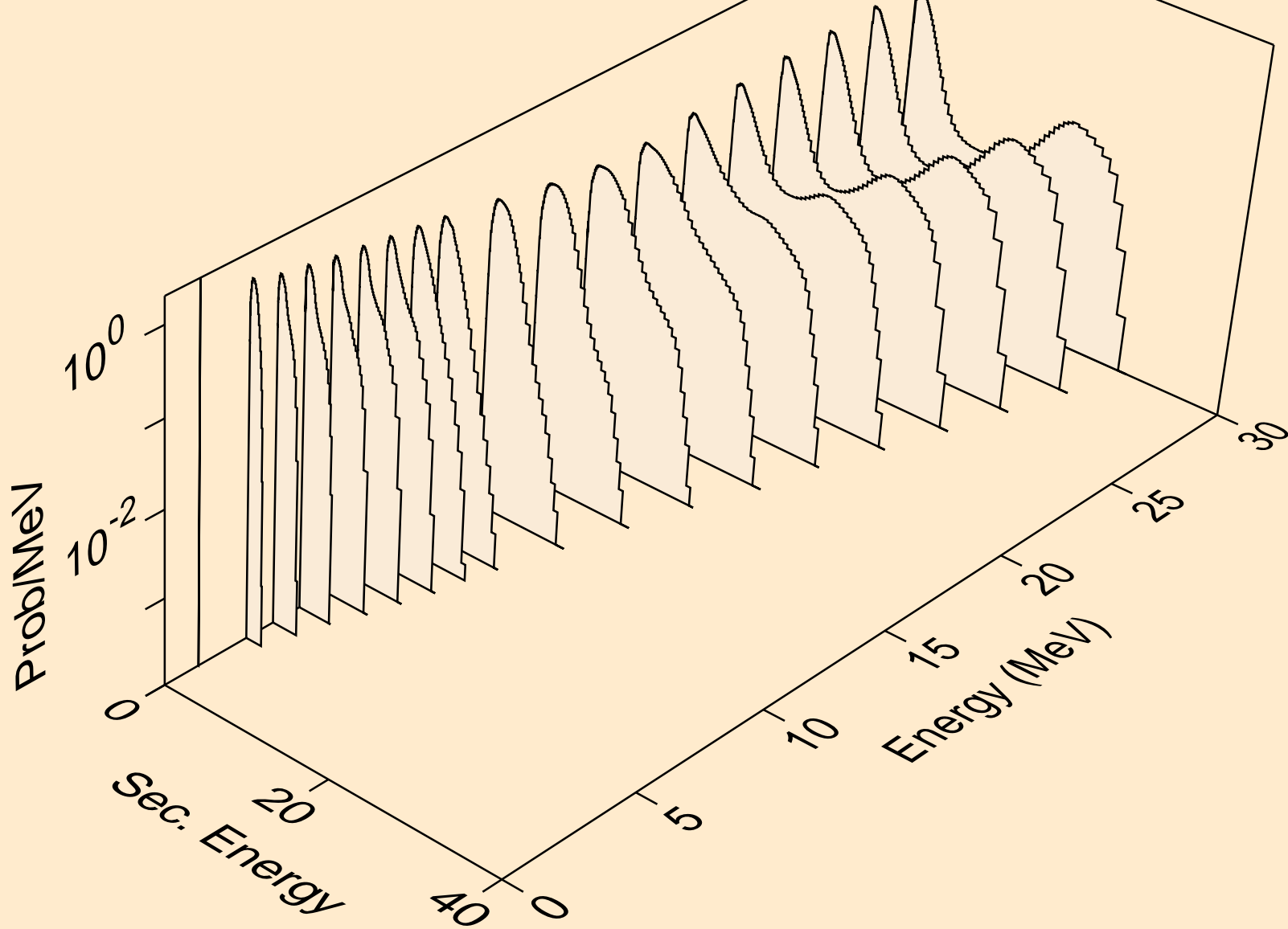

IR204 TRITON ACER TENDL-2023 LIBRARY; T=0.K
neutrons from (t,n*)a

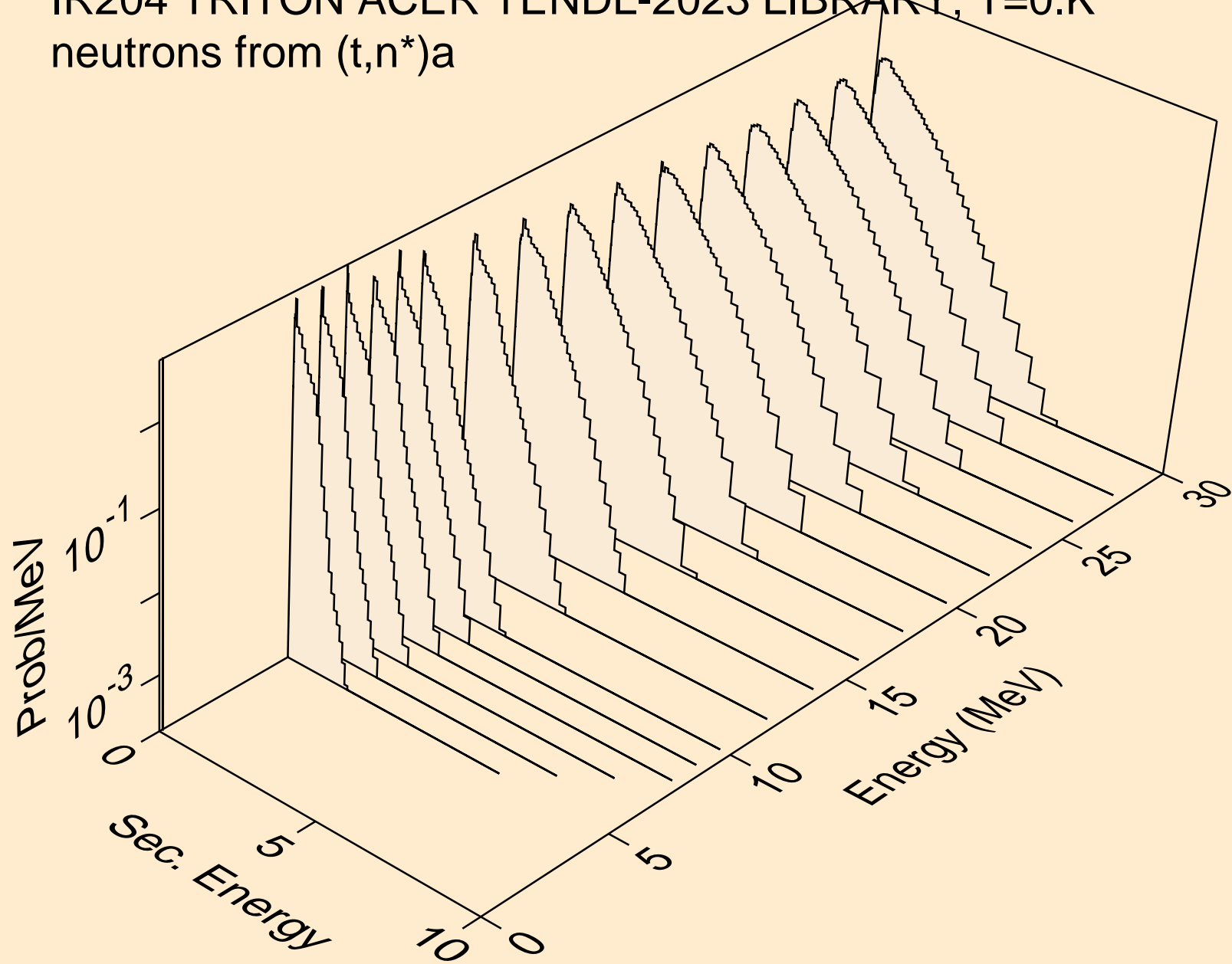

IR204 TRITON ACER TENDL-2023 LIBRARY; T=0.K
neutrons from (t,2n)a

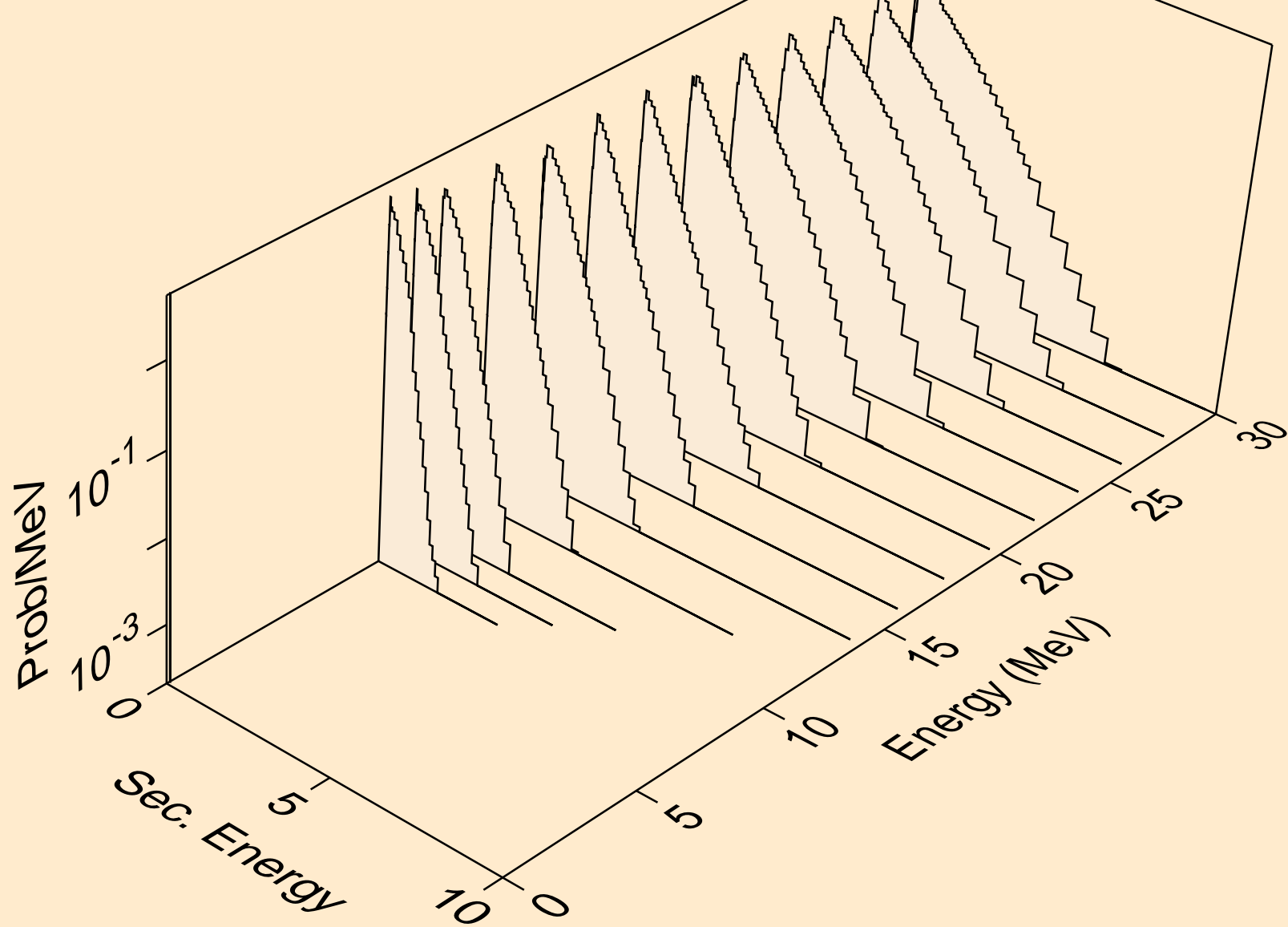

IR204 TRITON ACER TENDL-2023 LIBRARY; T=0.K
neutrons from (t,3n)a

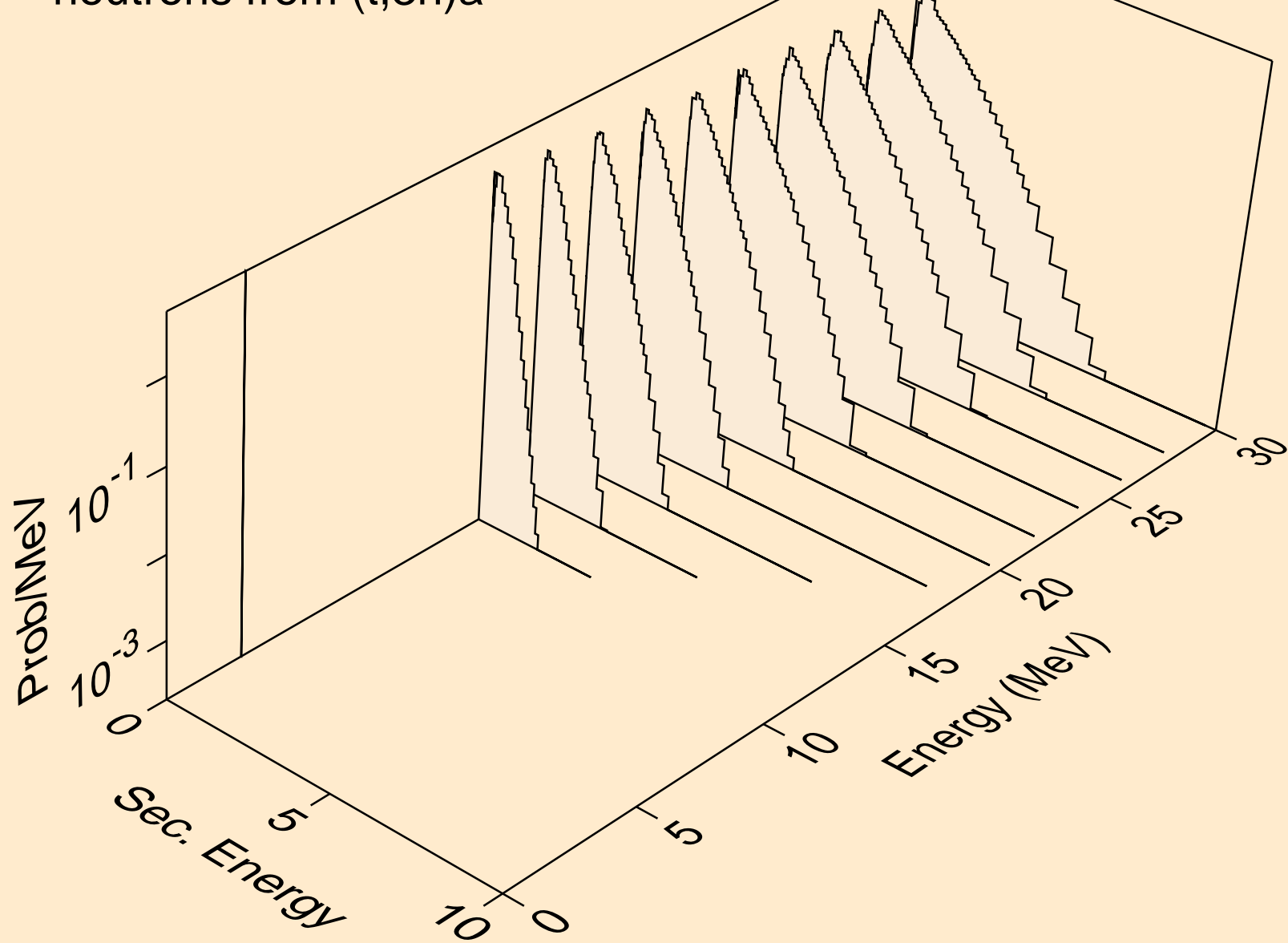

IR204 TRITON ACER TENDL-2023 LIBRARY; T=0.K
neutrons from (t,n*)p

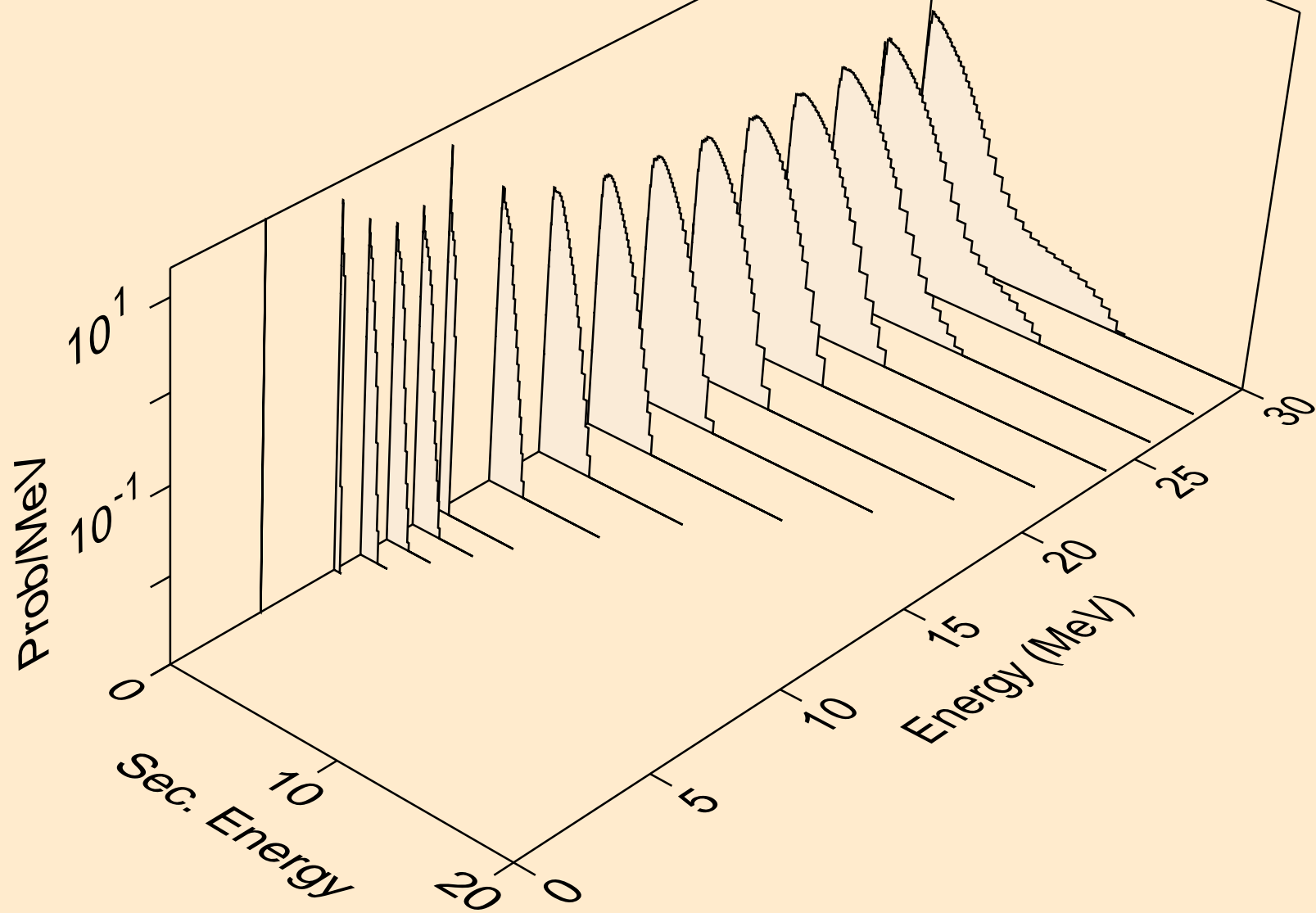

IR204 TRITON ACER TENDL-2023 LIBRARY; T=0.K
neutrons from (t,n*)d

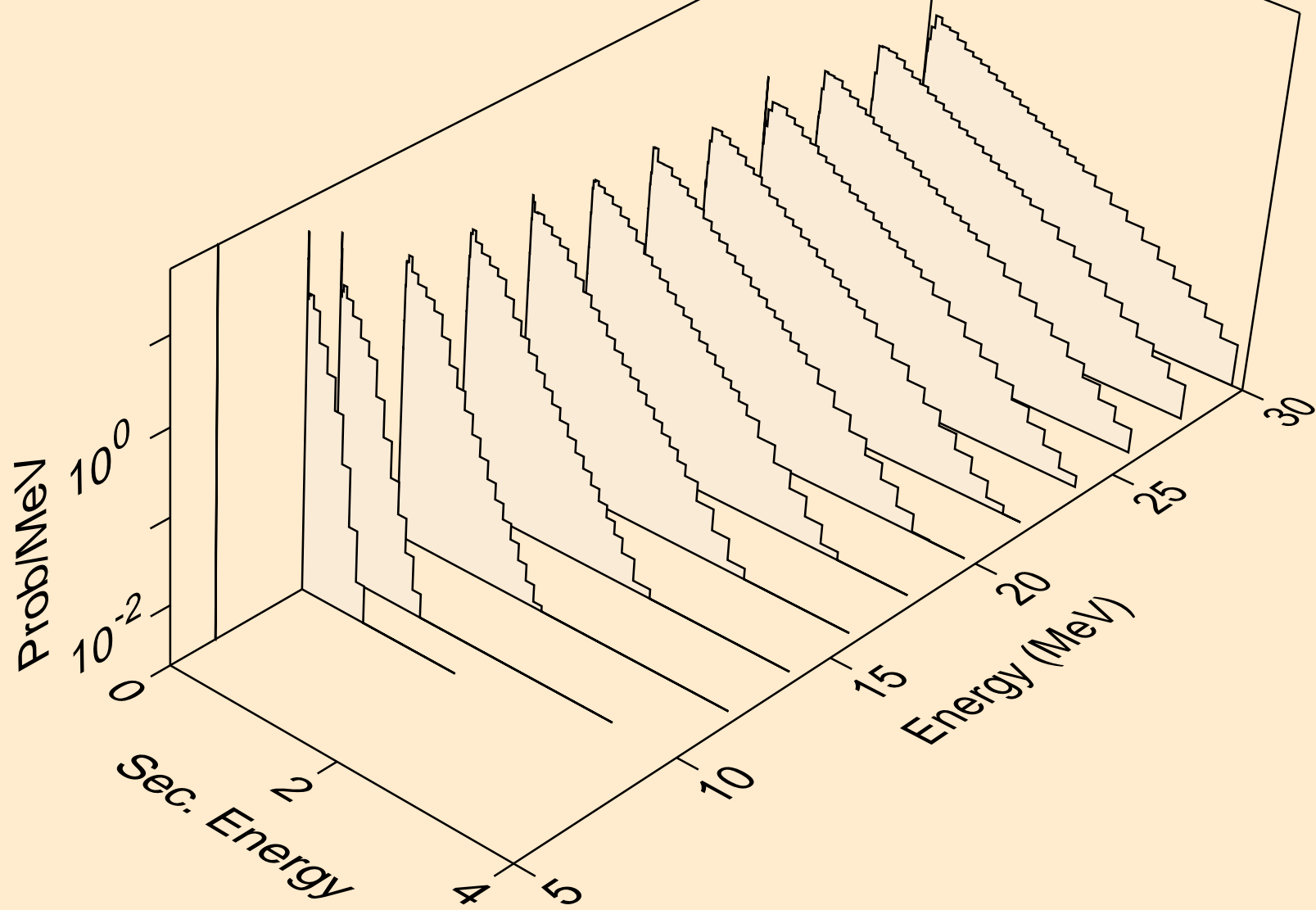

IR204 TRITON ACER TENDL-2023 LIBRARY; T=0.K
neutrons from (t,n*)t

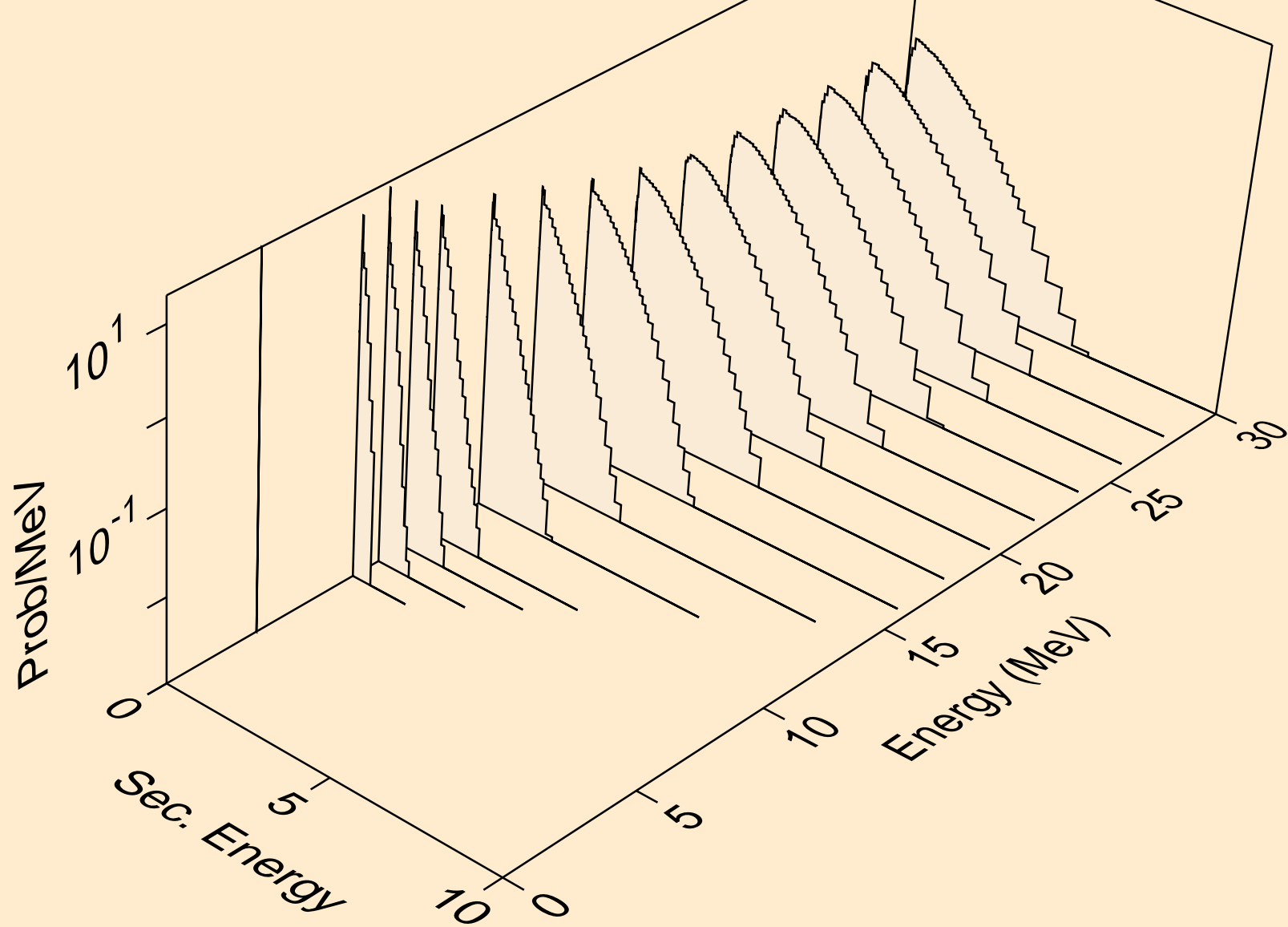

IR204 TRITON ACER TENDL-2023 LIBRARY; T=0.K
neutrons from (t,n*)he3

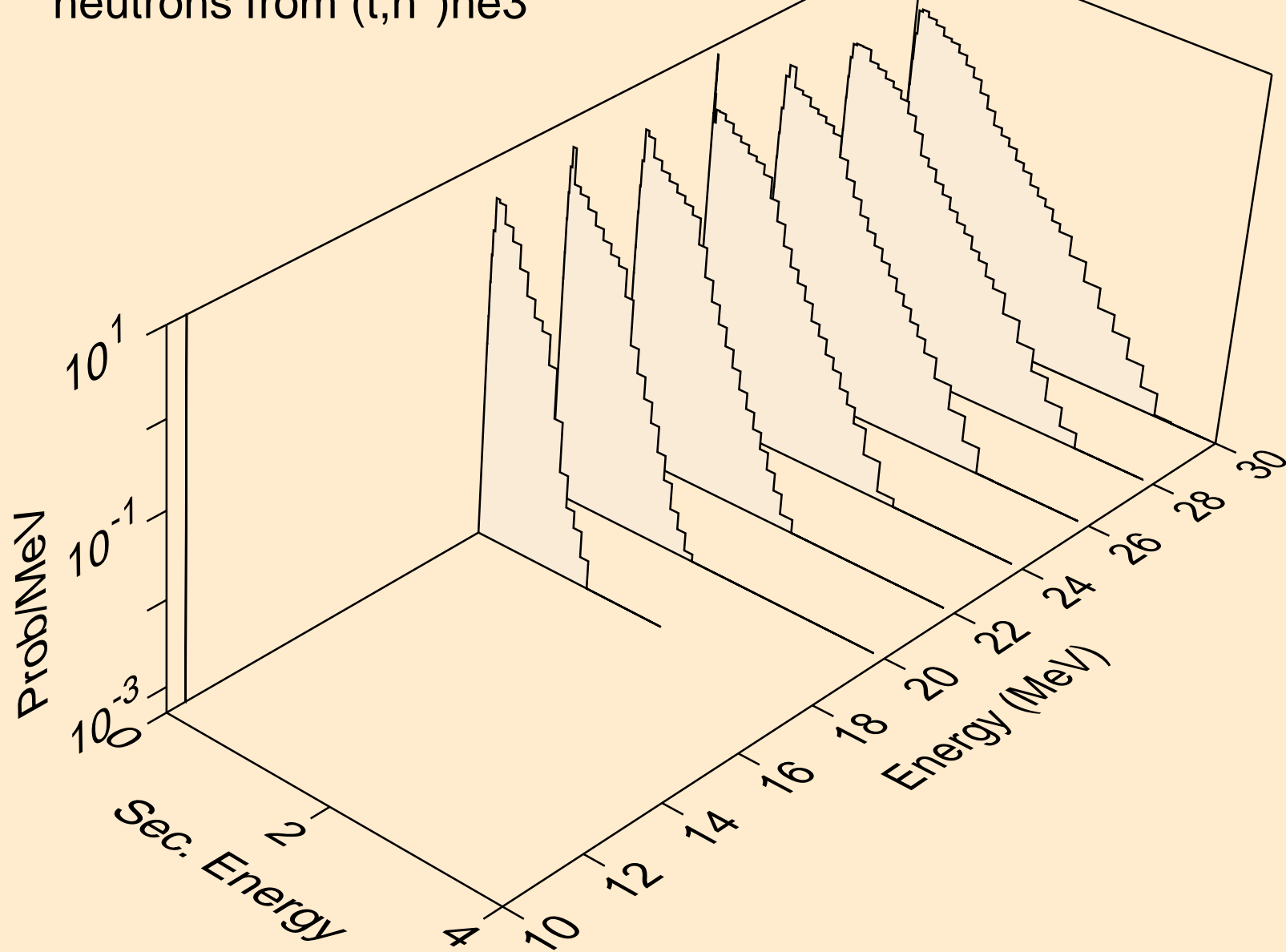

IR204 TRITON ACER TENDL-2023 LIBRARY; T=0.K
neutrons from (t,4n)

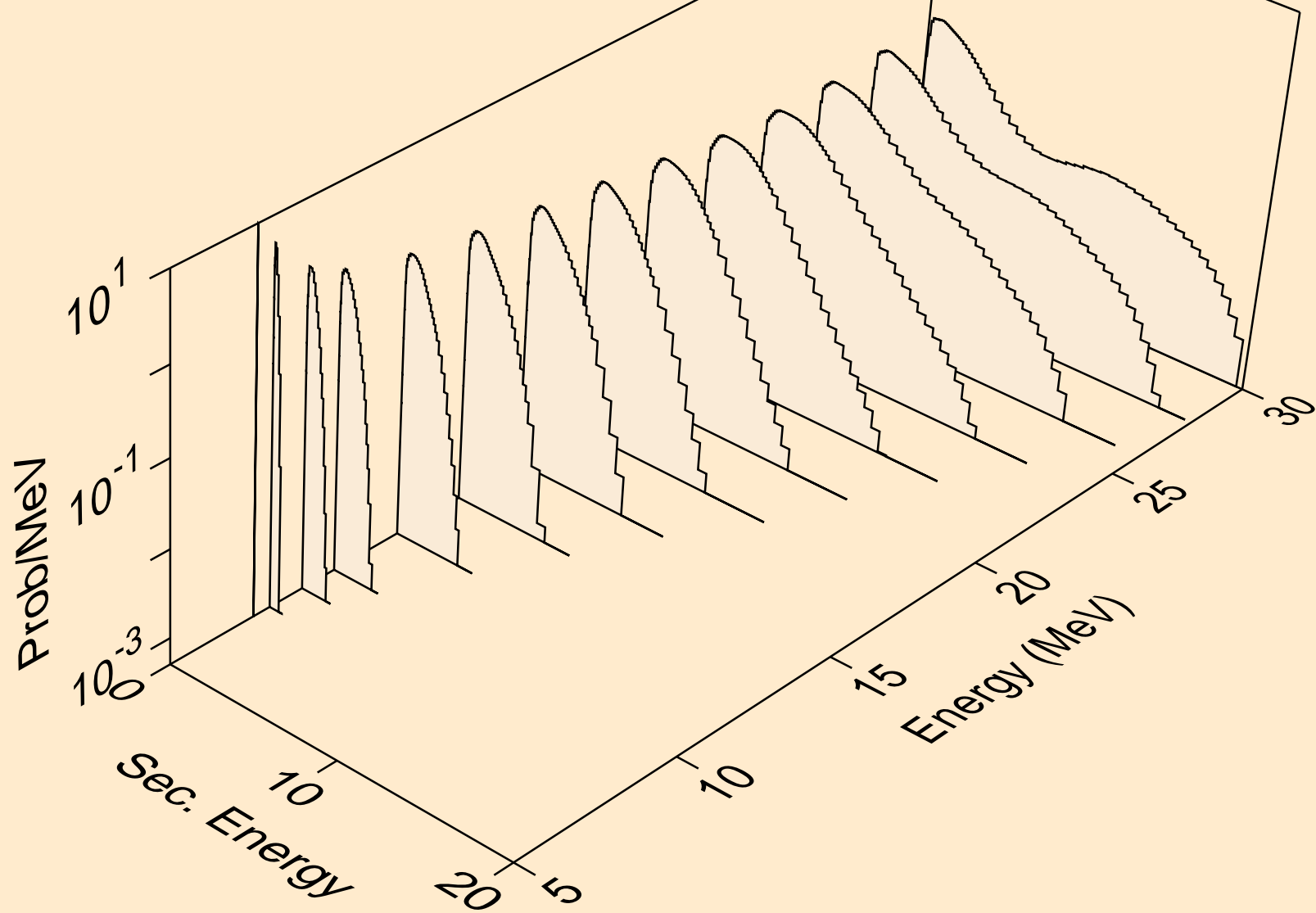

IR204 TRITON ACER TENDL-2023 LIBRARY; T=0.K
neutrons from (t,2np)

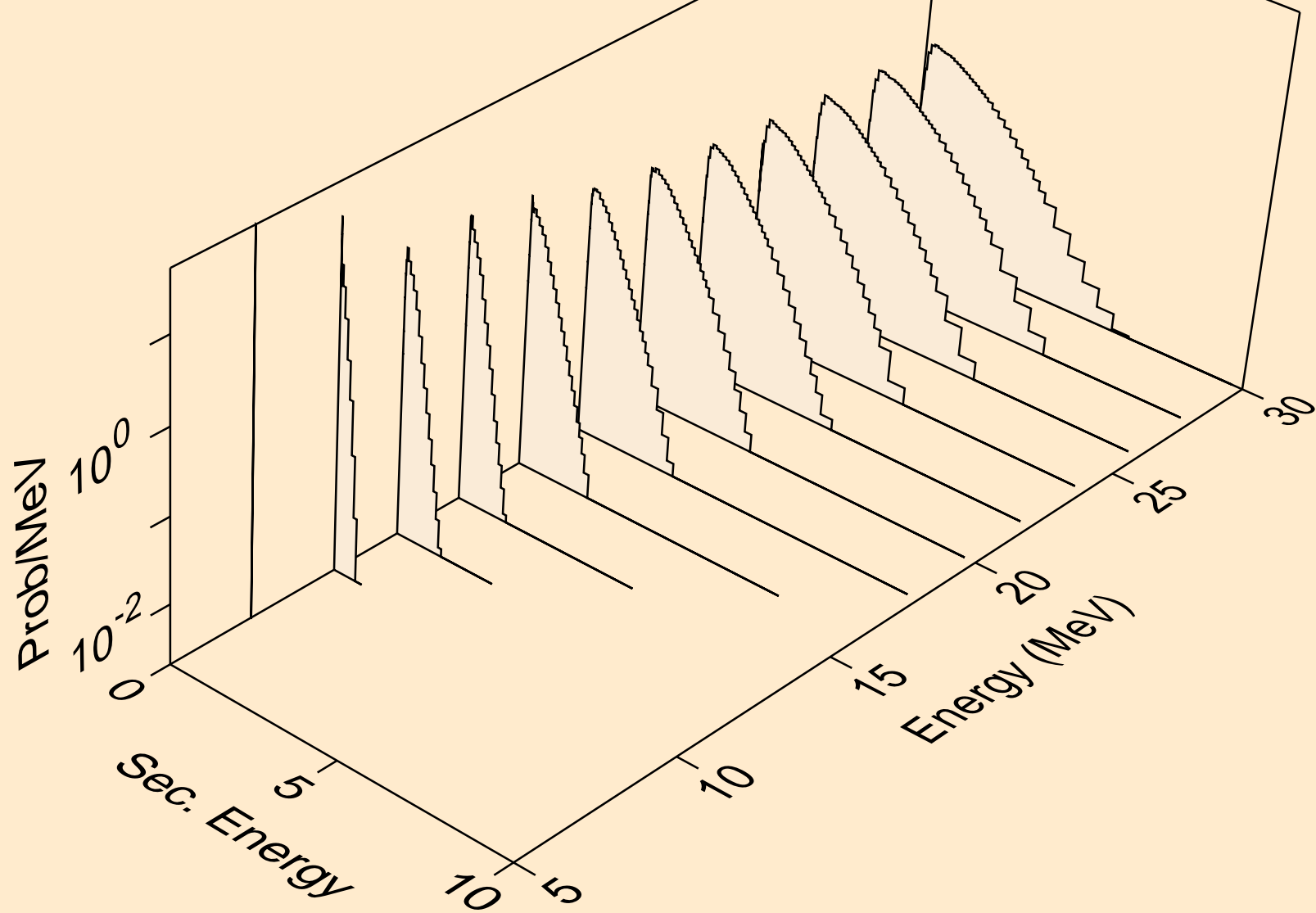

IR204 TRITON ACER TENDL-2023 LIBRARY; T=0.K
neutrons from (t,3np)

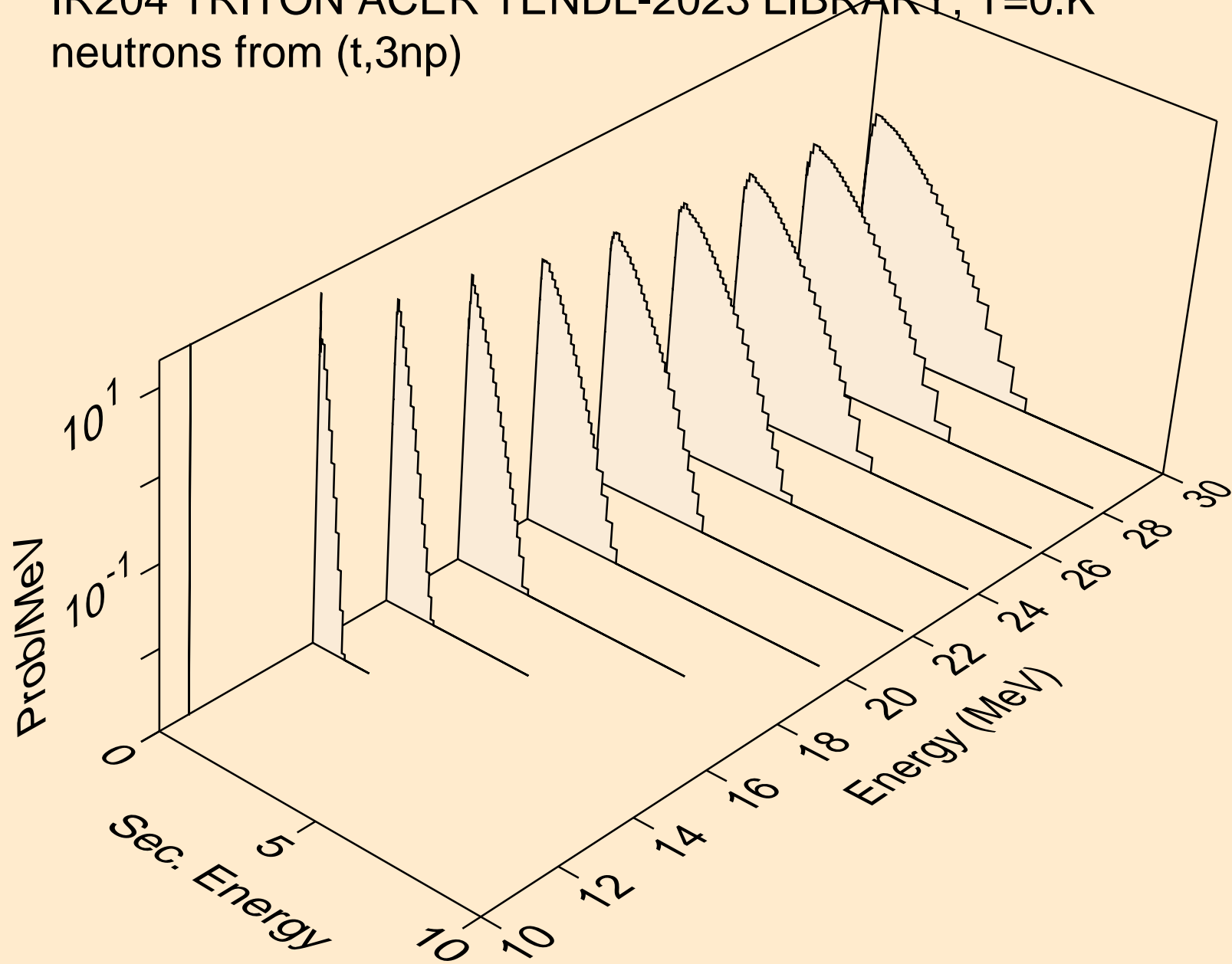

IR204 TRITON ACER TENDL-2023 LIBRARY; T=0.K
neutrons from (t,n2p)

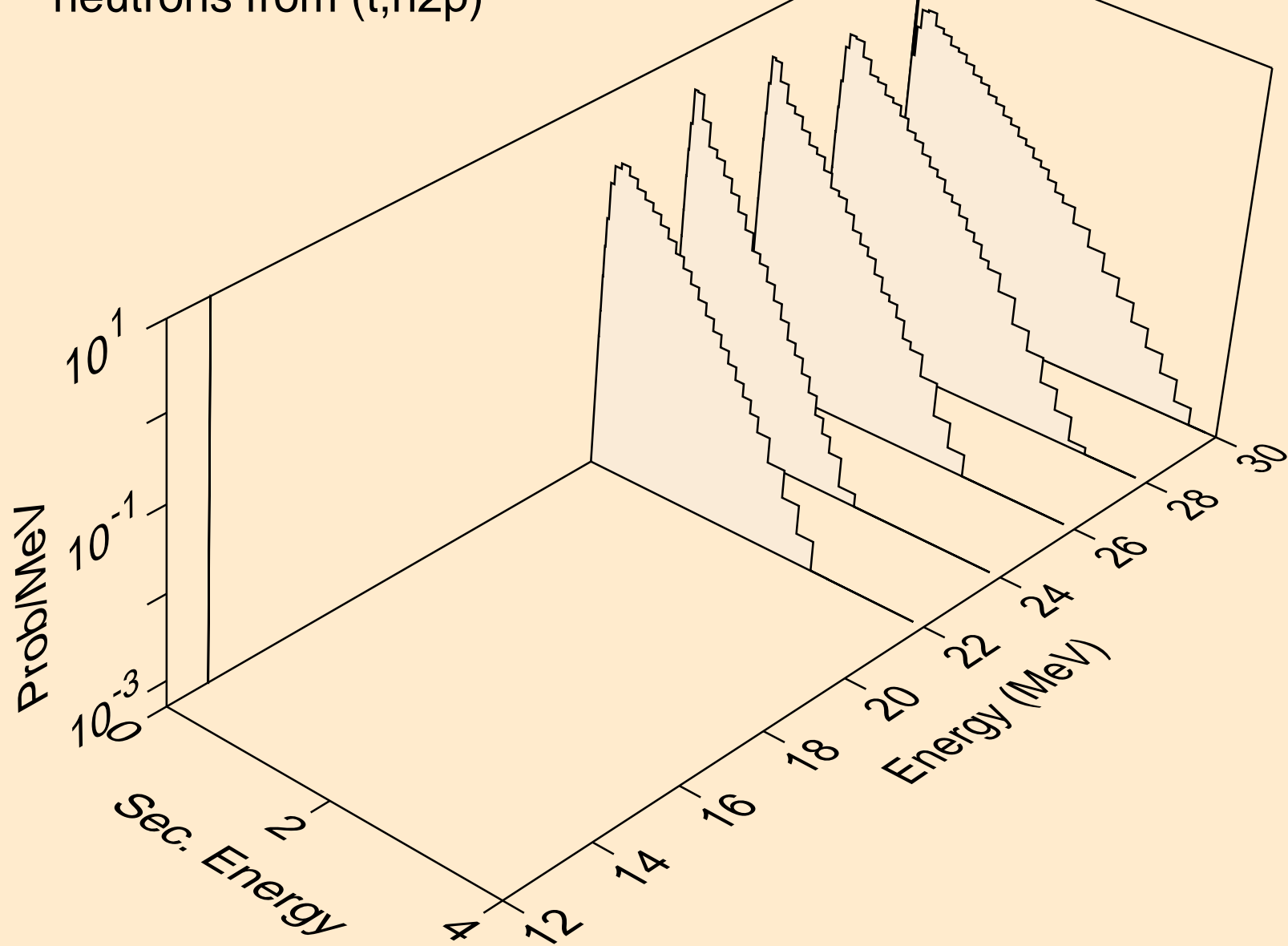

IR204 TRITON ACER TENDL-2023 LIBRARY; T=0.K
protons from (t,x)

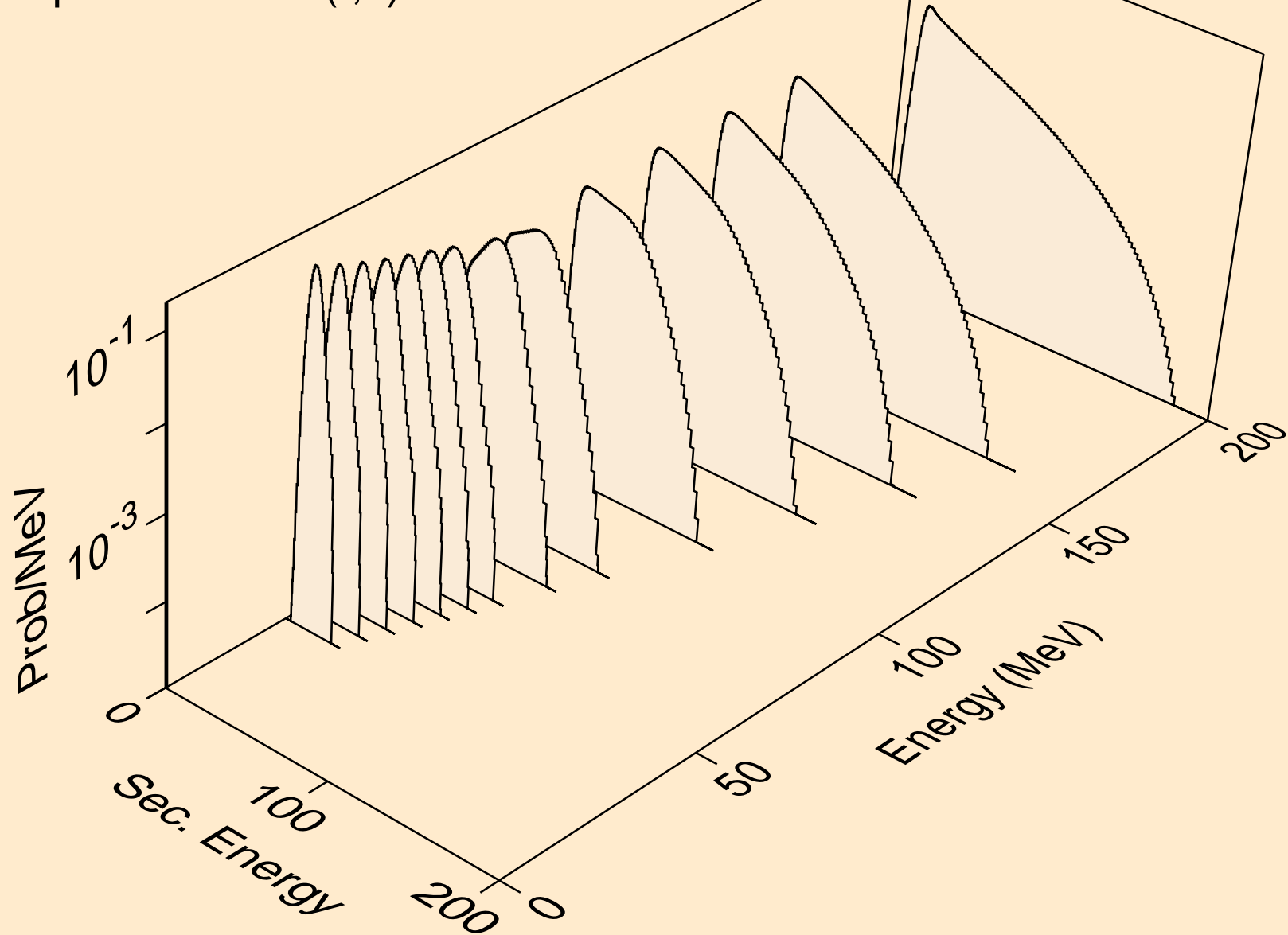

IR204 TRITON ACER TENDL-2023 LIBRARY; T=0.K
protons from (t,n*)p

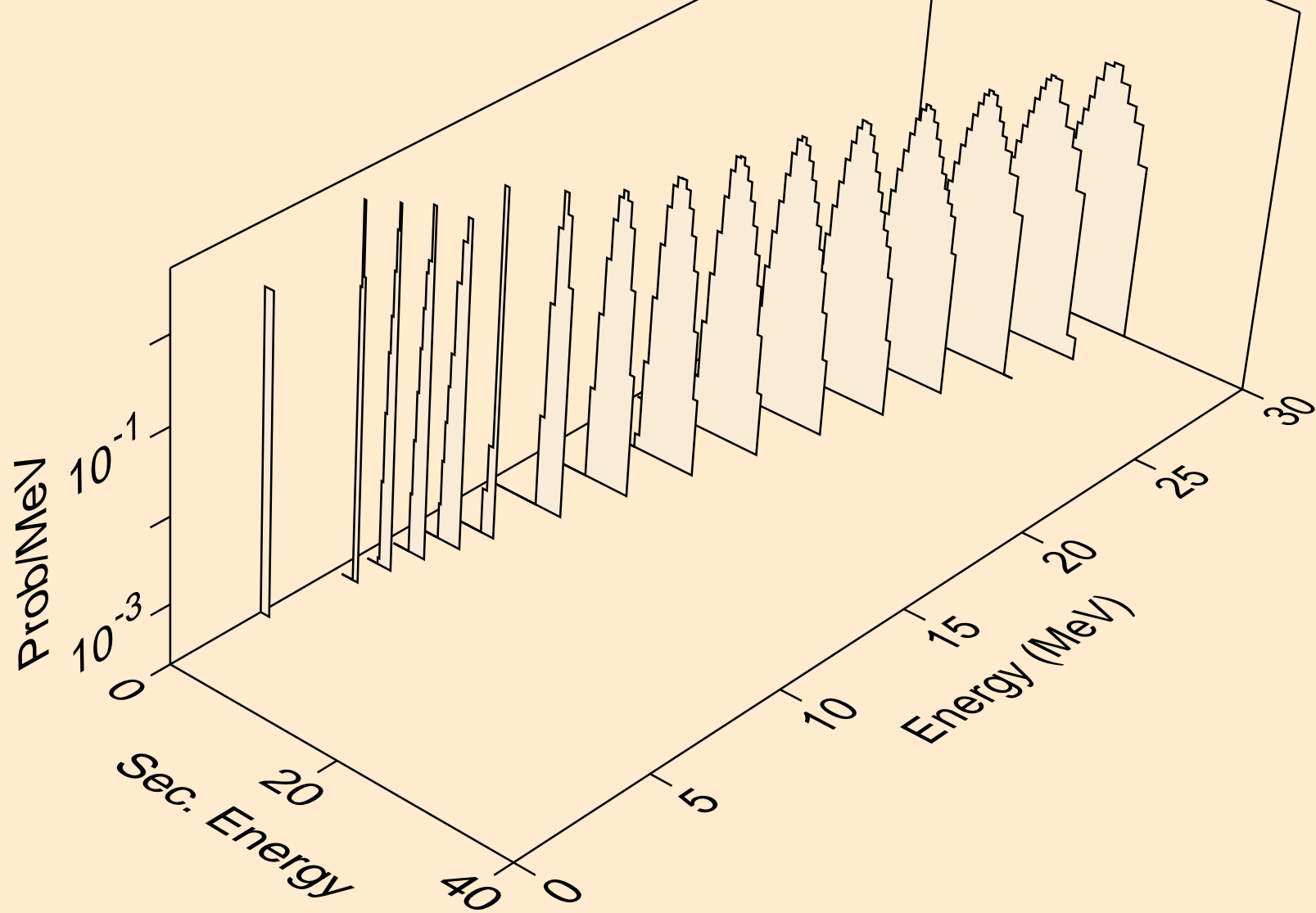

IR204 TRITON ACER TENDL-2023 LIBRARY; T=0.K
protons from (t,2np)

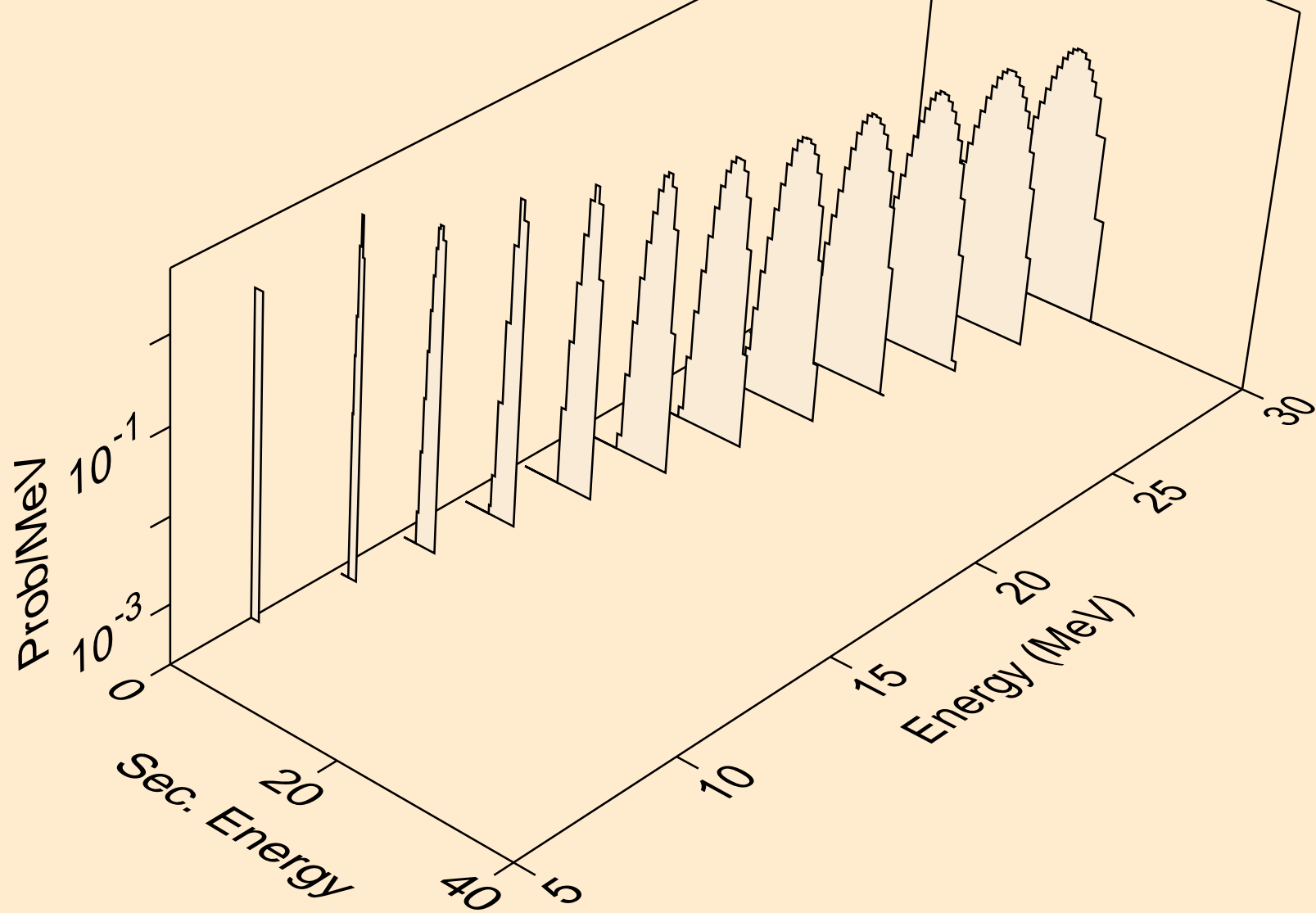

IR204 TRITON ACER TENDL-2023 LIBRARY; T=0.K
protons from (t,3np)

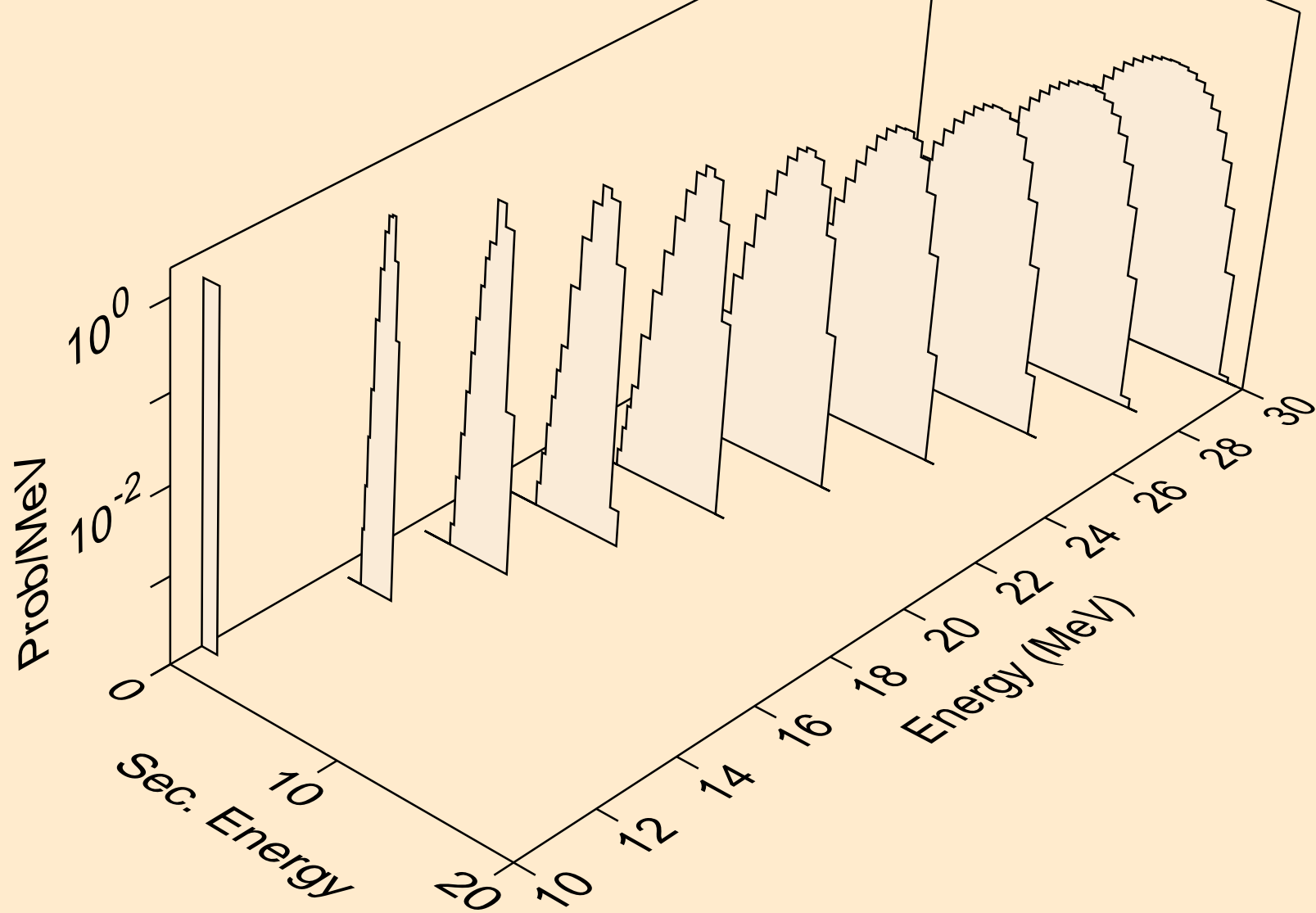

IR204 TRITON ACER TENDL-2023 LIBRARY; T=0.K
protons from (t,n2p)

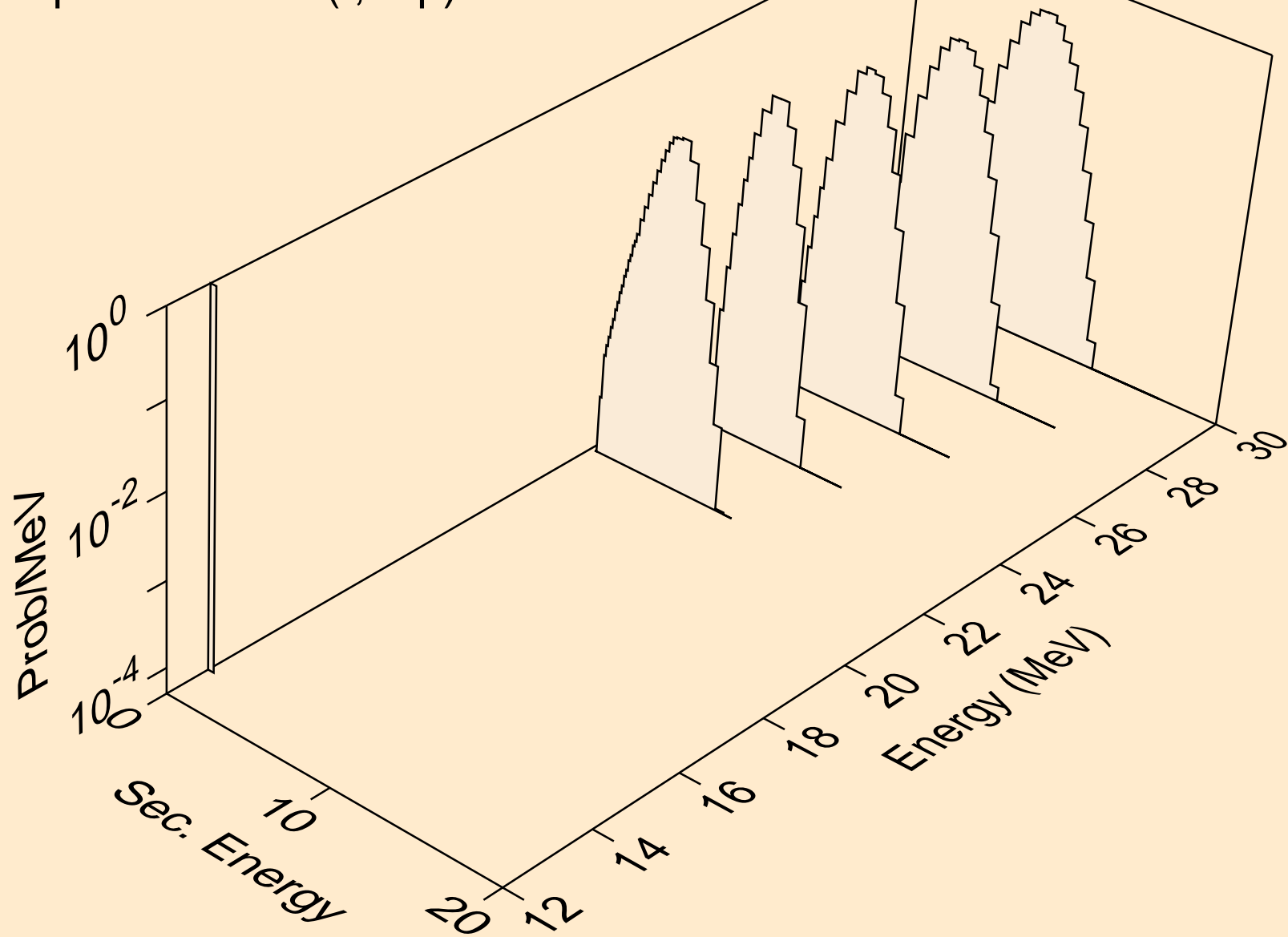

IR204 TRITON ACER TENDL-2023 LIBRARY; T=0.K
protons from (t,p)

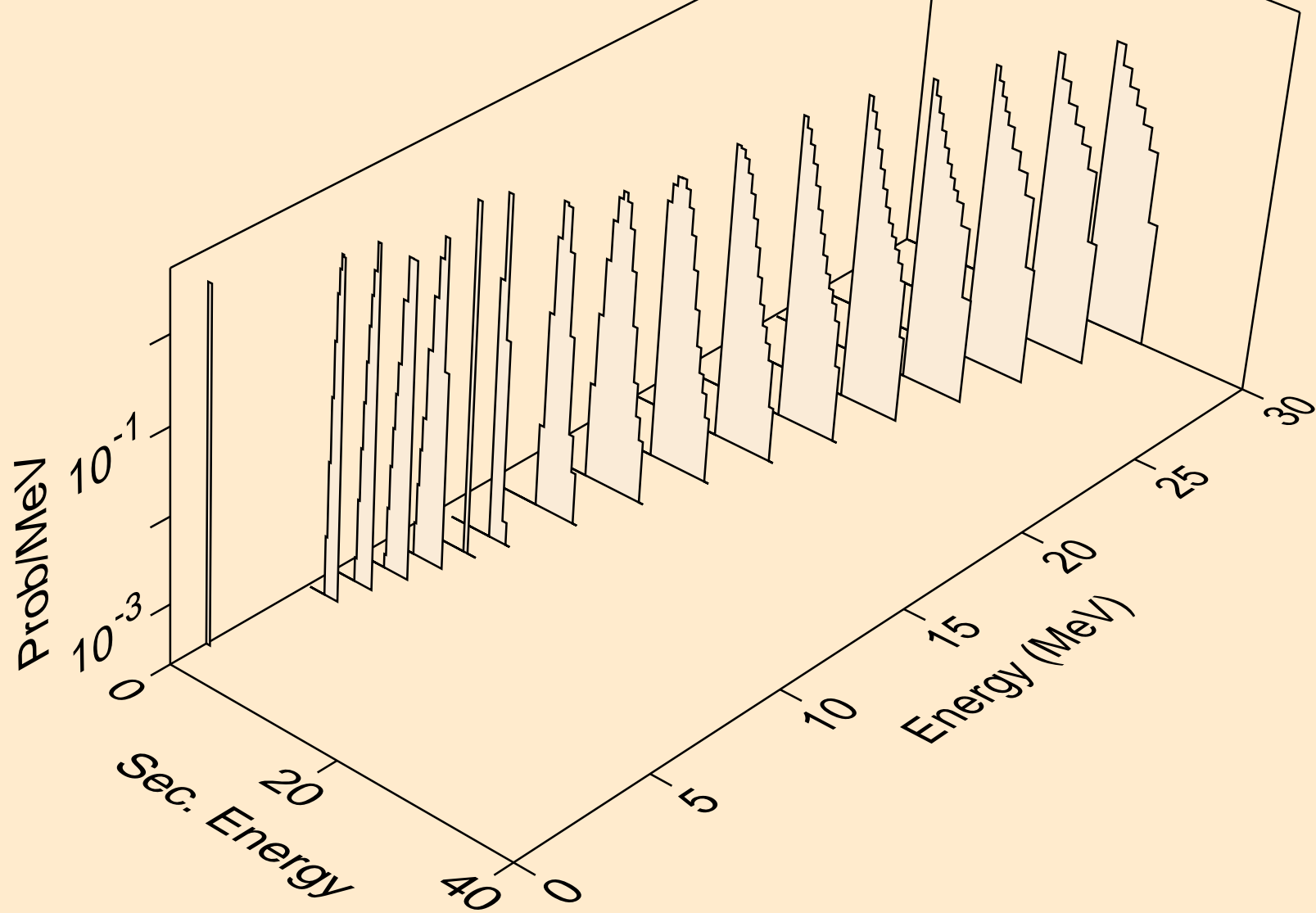

IR204 TRITON ACER TENDL-2023 LIBRARY; T=0.K
deuterons from (t,x)

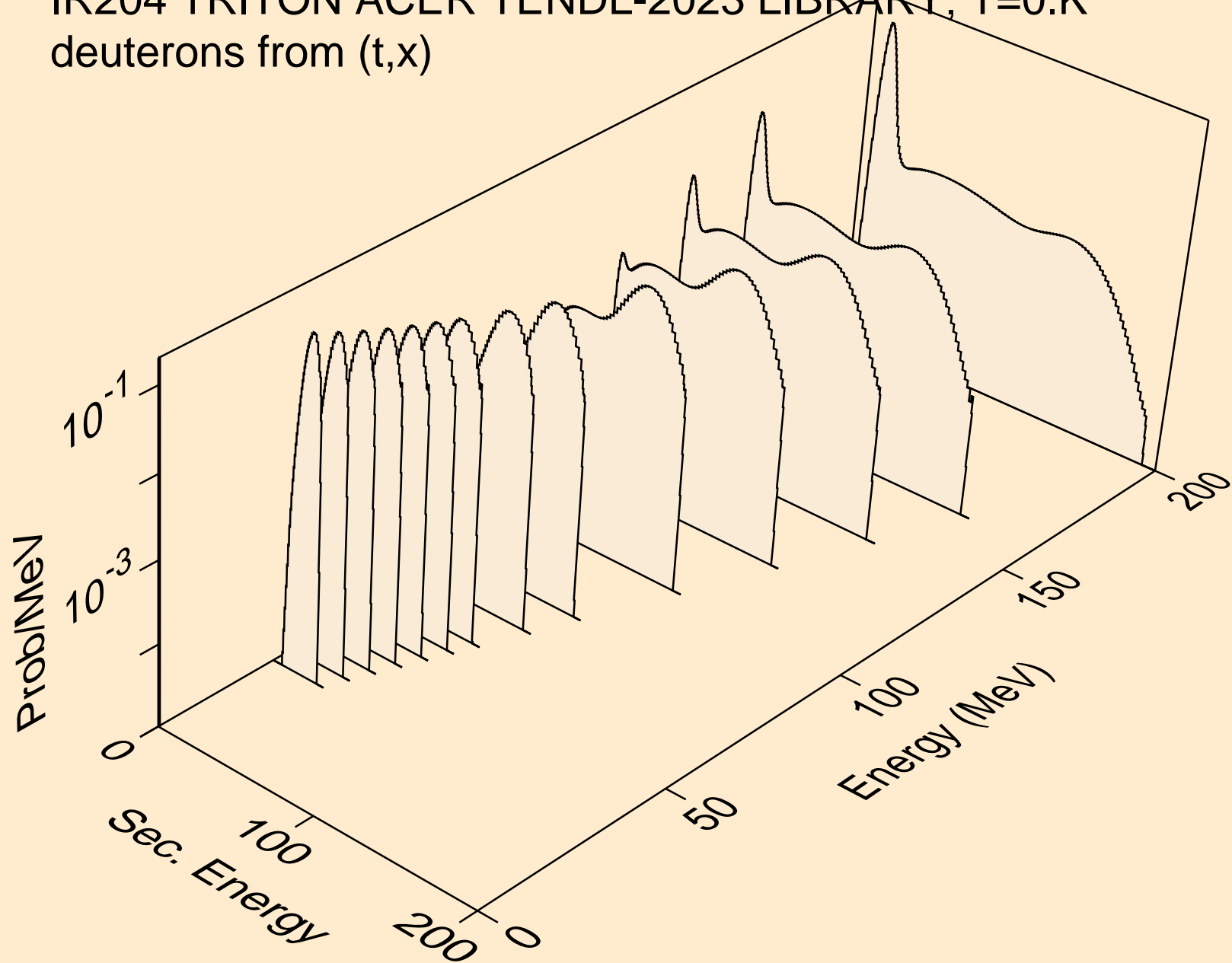

IR204 TRITON ACER TENDL-2023 LIBRARY; T=0.K
deuterons from (t,2nd)

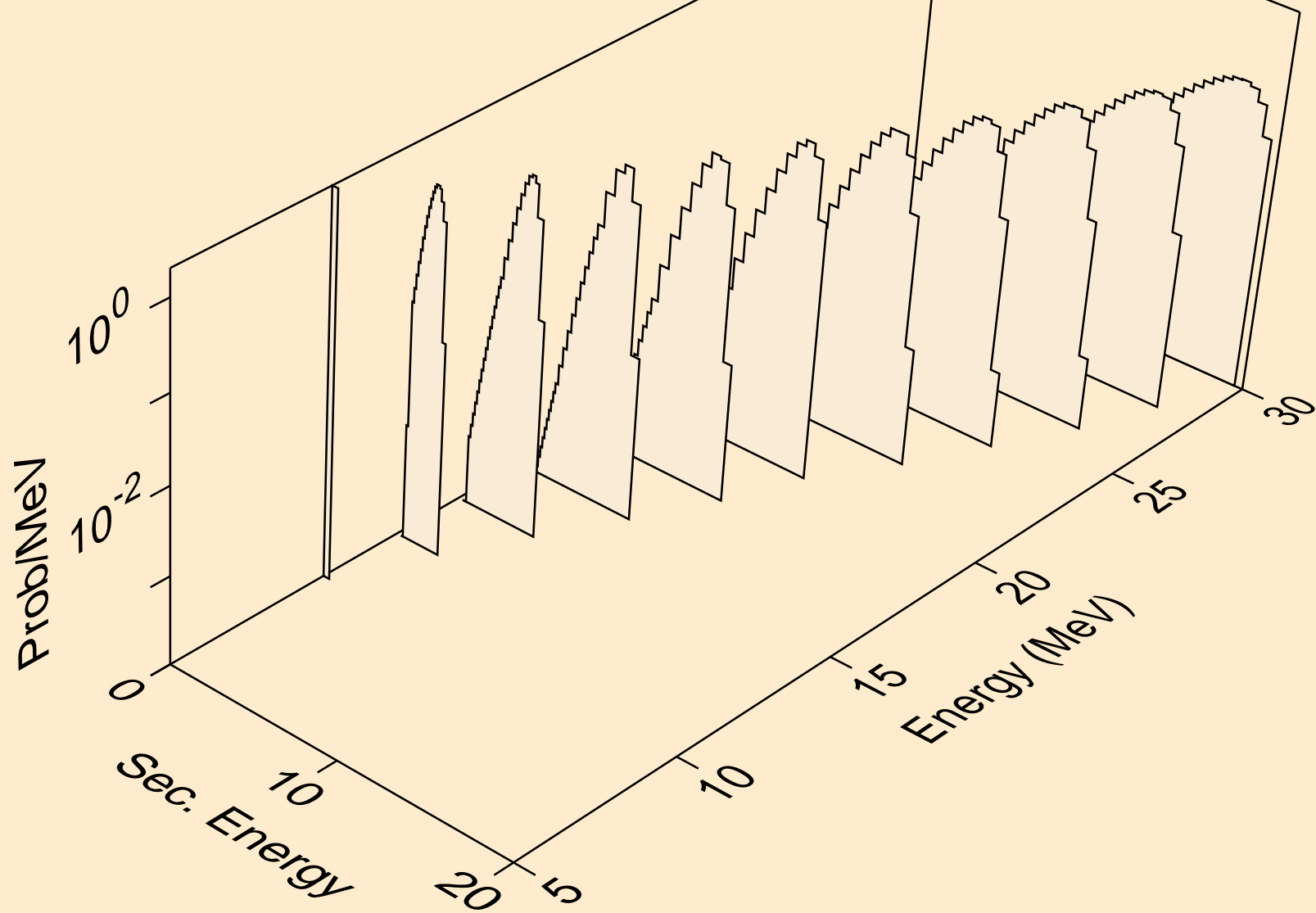

IR204 TRITON ACER TENDL-2023 LIBRARY; T=0.K
deuterons from (t,n*)d

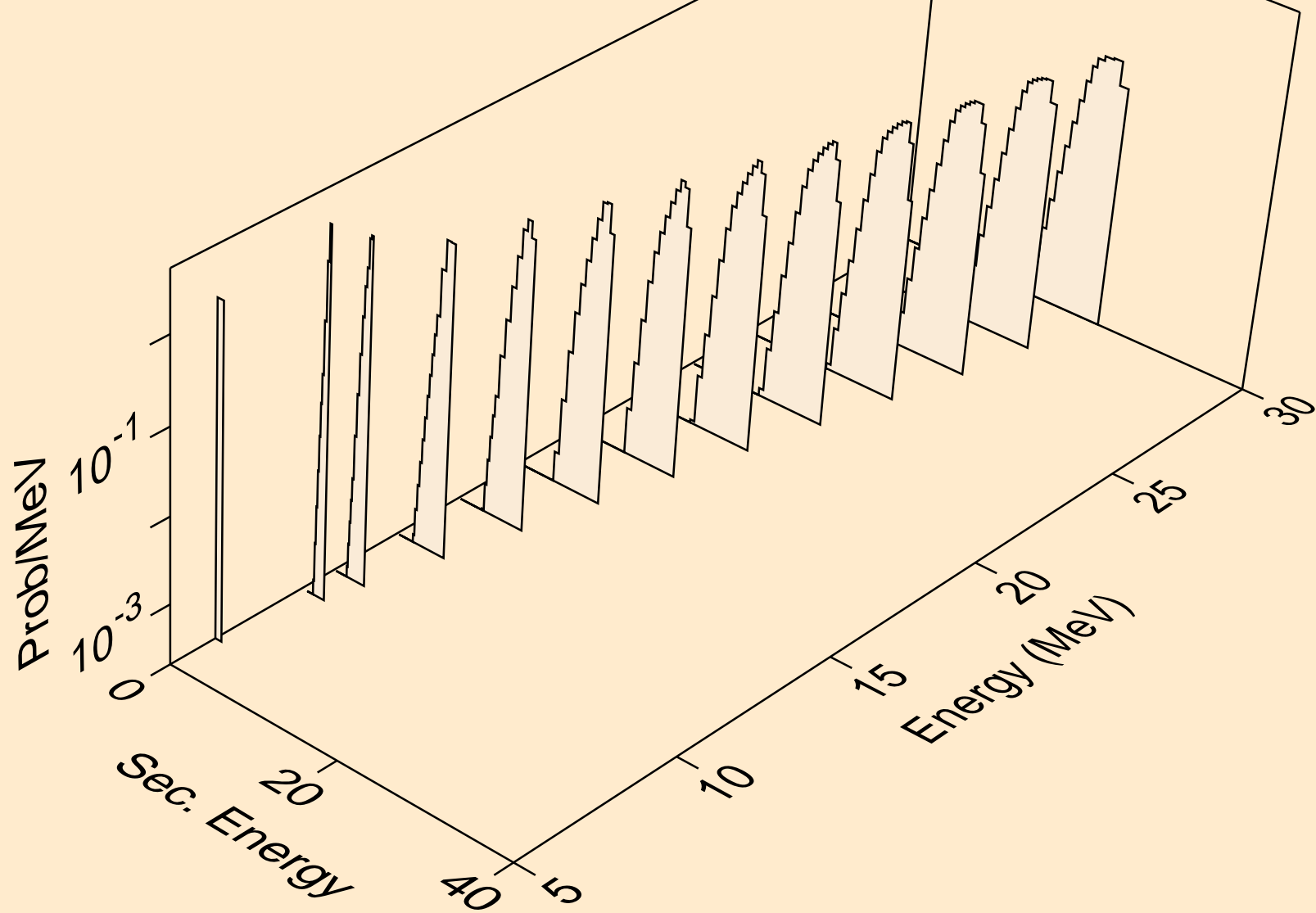

IR204 TRITON ACER TENDL-2023 LIBRARY; T=0.K
deuterons from (t,d)

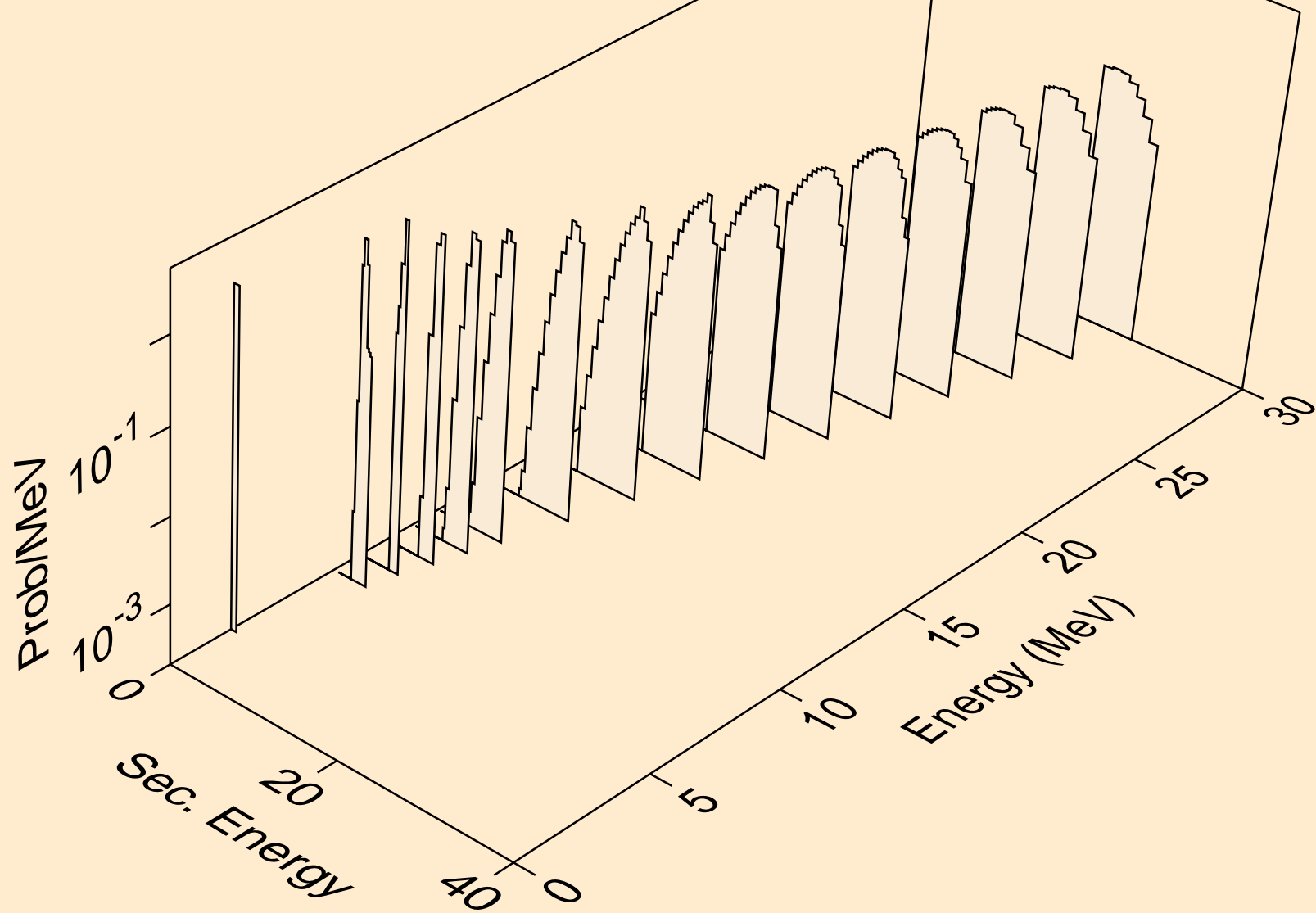

IR204 TRITON ACER TENDL-2023 LIBRARY; T=0.K
he3s from (t,x)

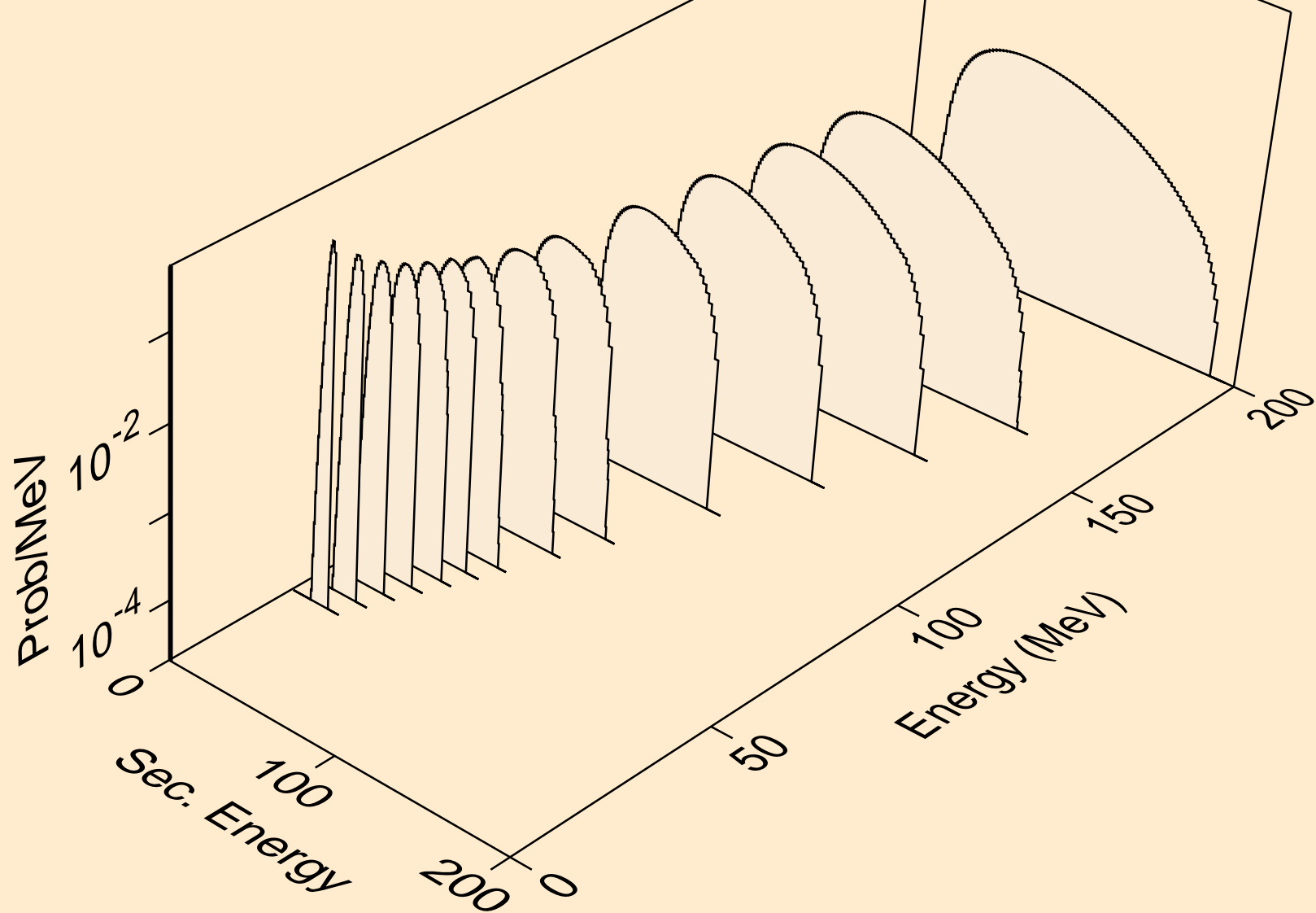

IR204 TRITON ACER TENDL-2023 LIBRARY; T=0.K
he3s from (t,n*)he3

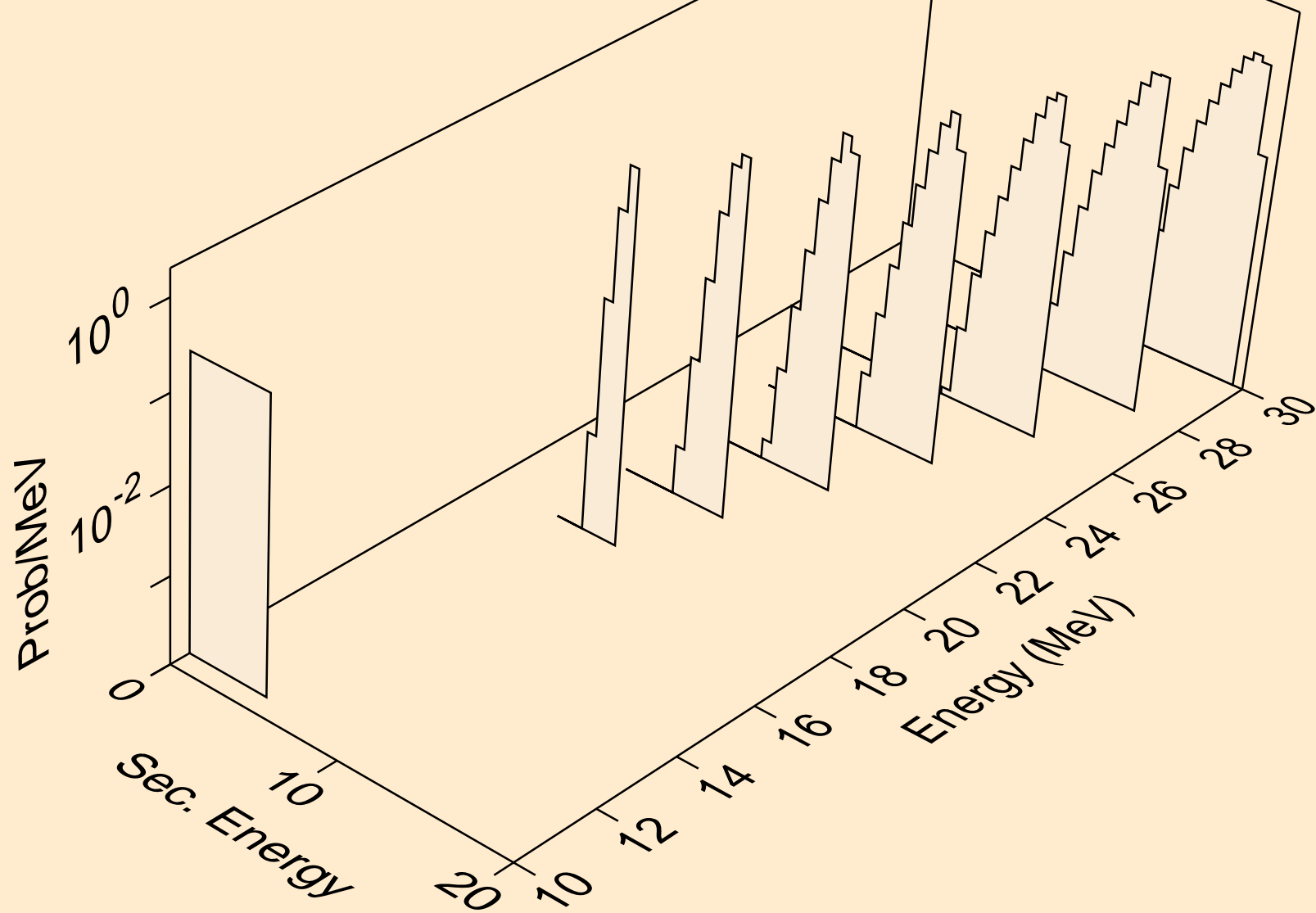

IR204 TRITON ACER TENDL-2023 LIBRARY; T=0.K
he3s from (t,he3)

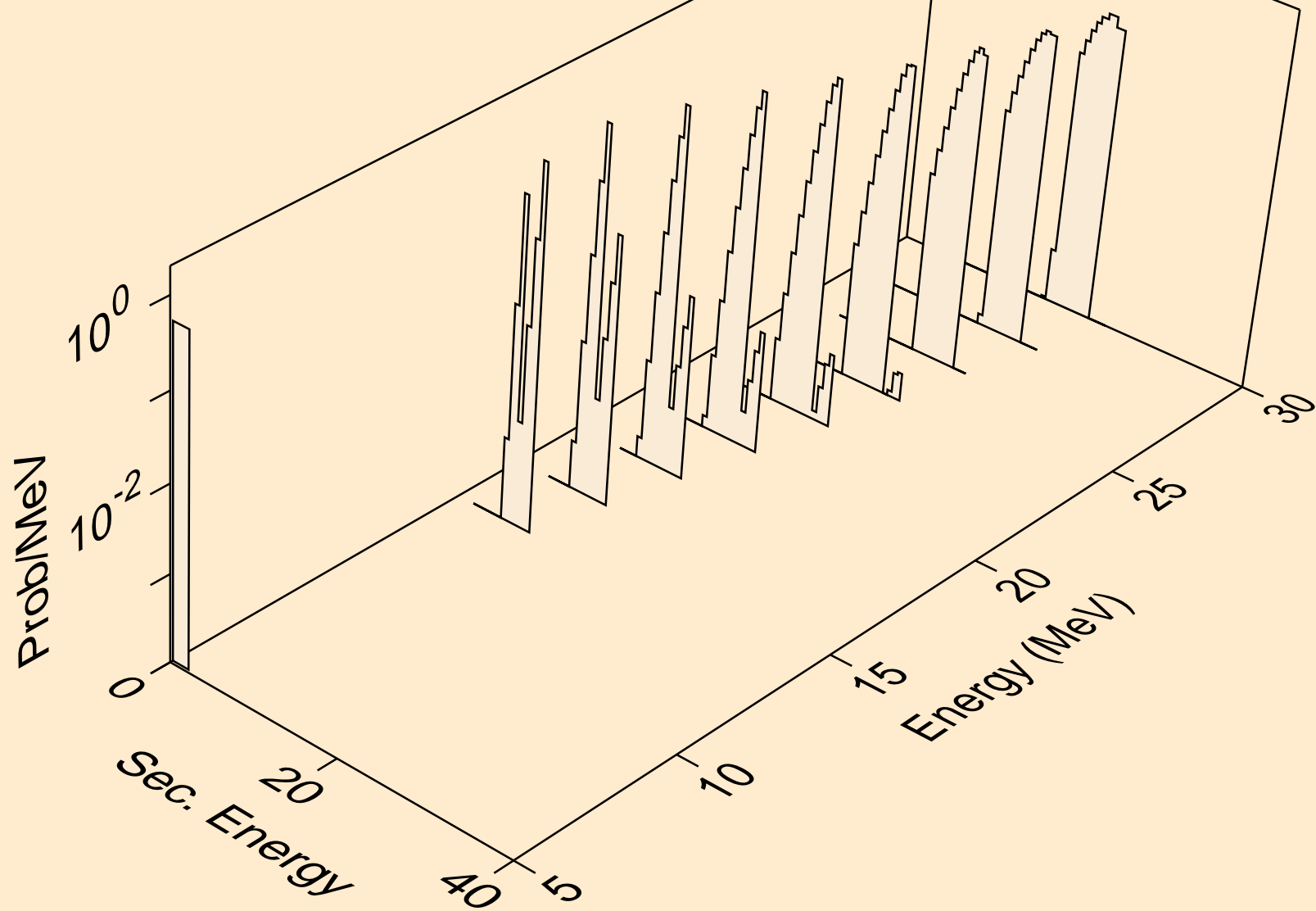

IR204 TRITON ACER TENDL-2023 LIBRARY; T=0.K
alphas from (t,x)

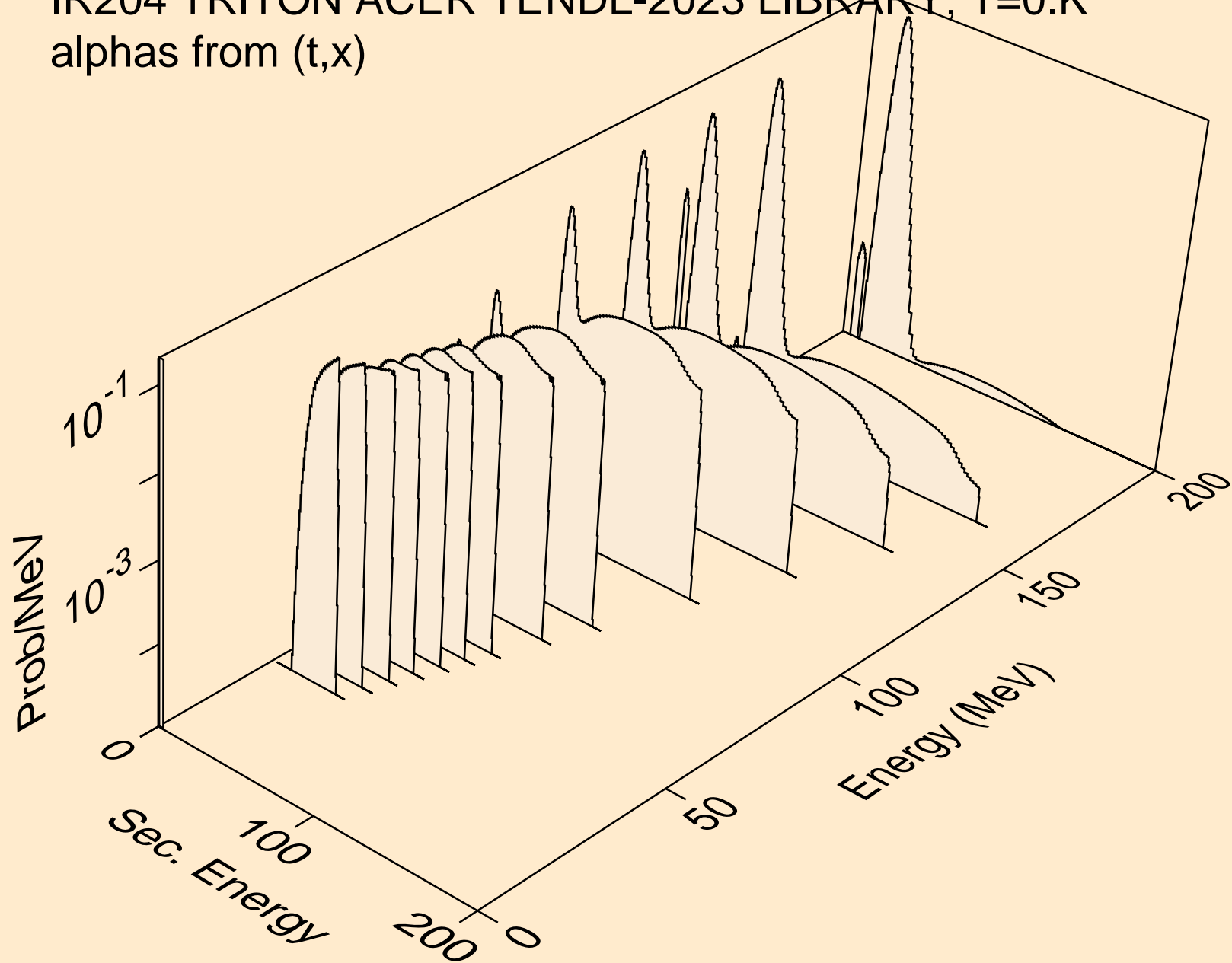

IR204 TRITON ACER TENDL-2023 LIBRARY; T=0.K
alphas from (t,n*)a

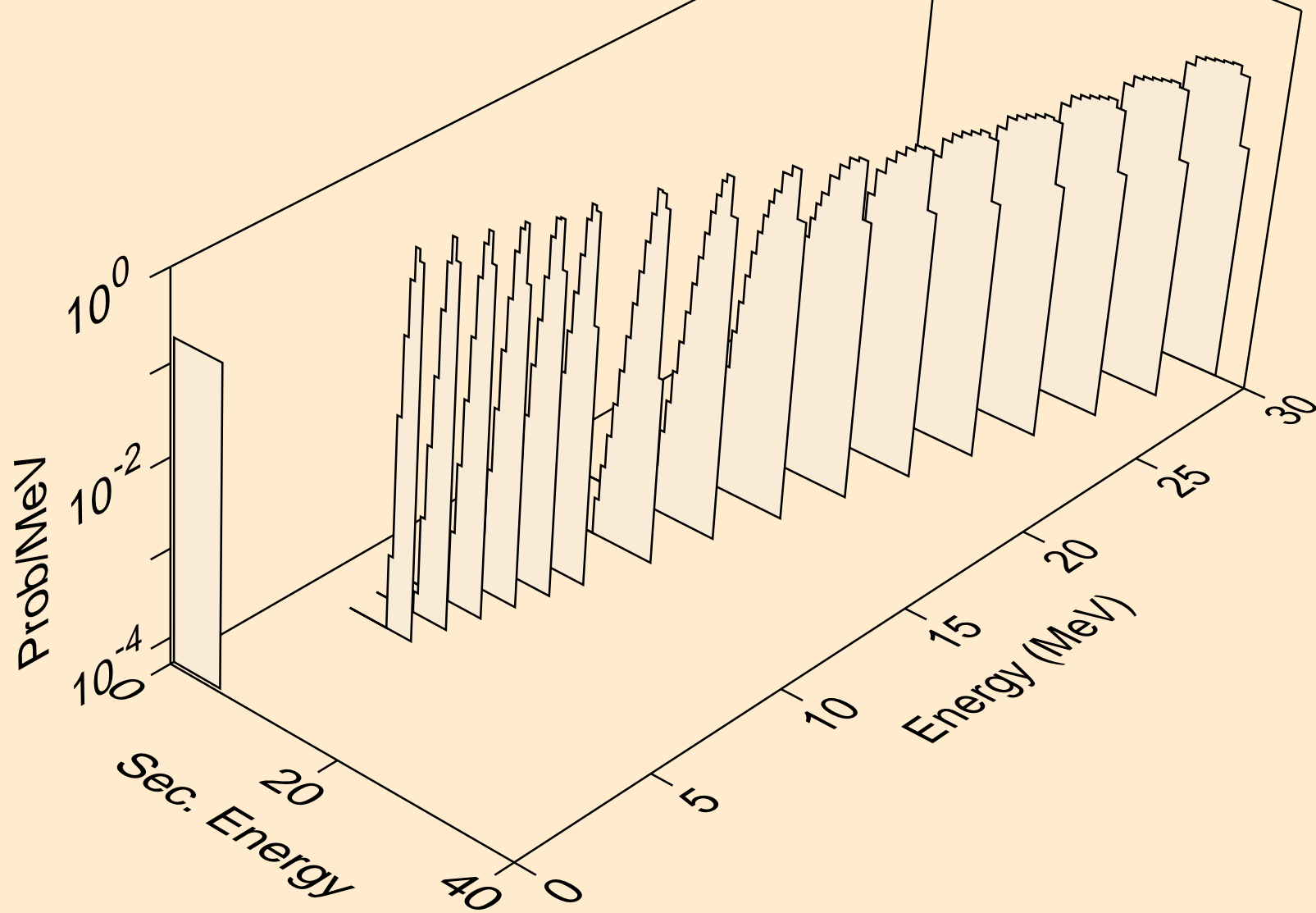

IR204 TRITON ACER TENDL-2023 LIBRARY; T=0.K
alphas from (t,2n)a

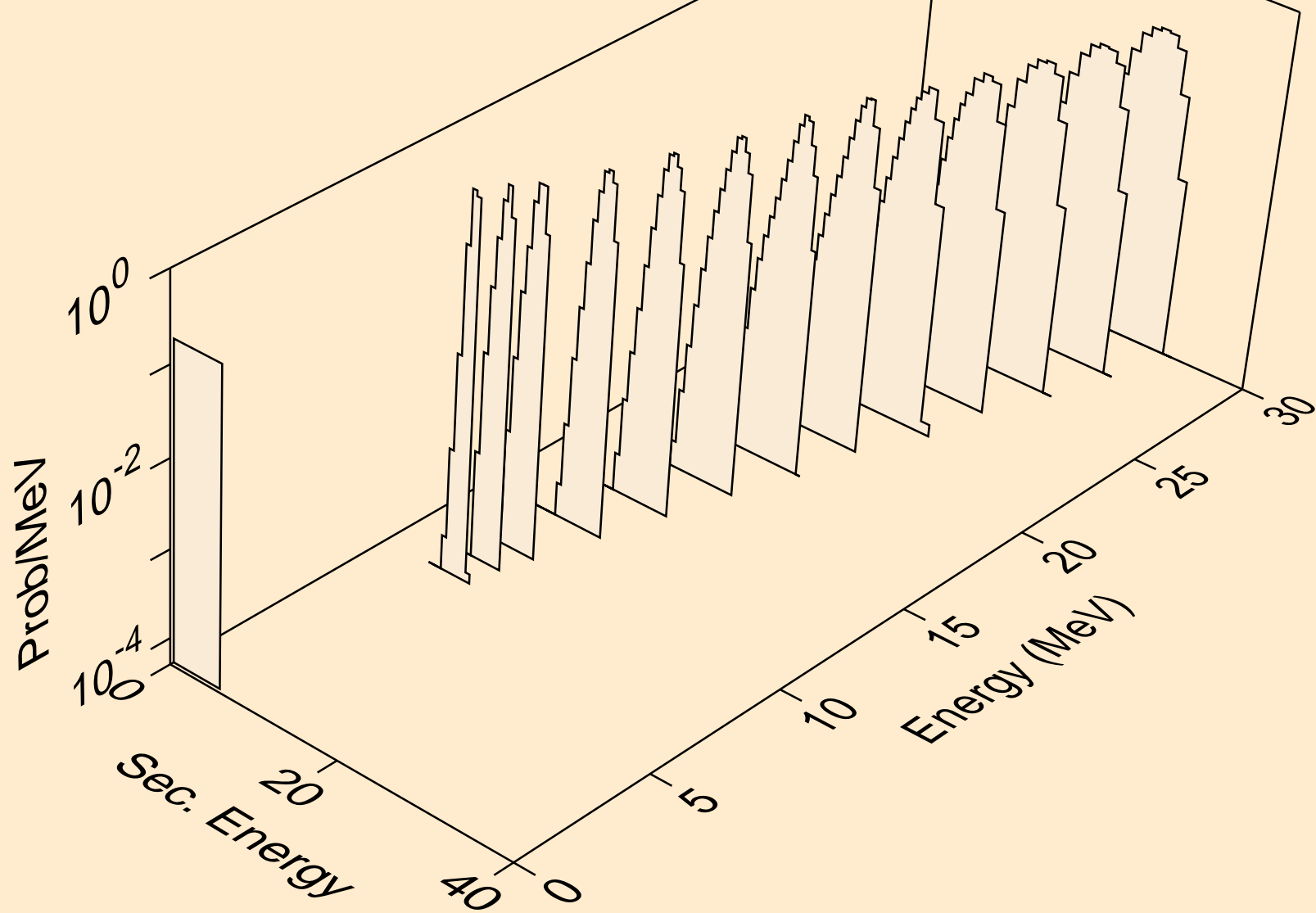

IR204 TRITON ACER TENDL-2023 LIBRARY; T=0.K
alphas from (t,3n)a

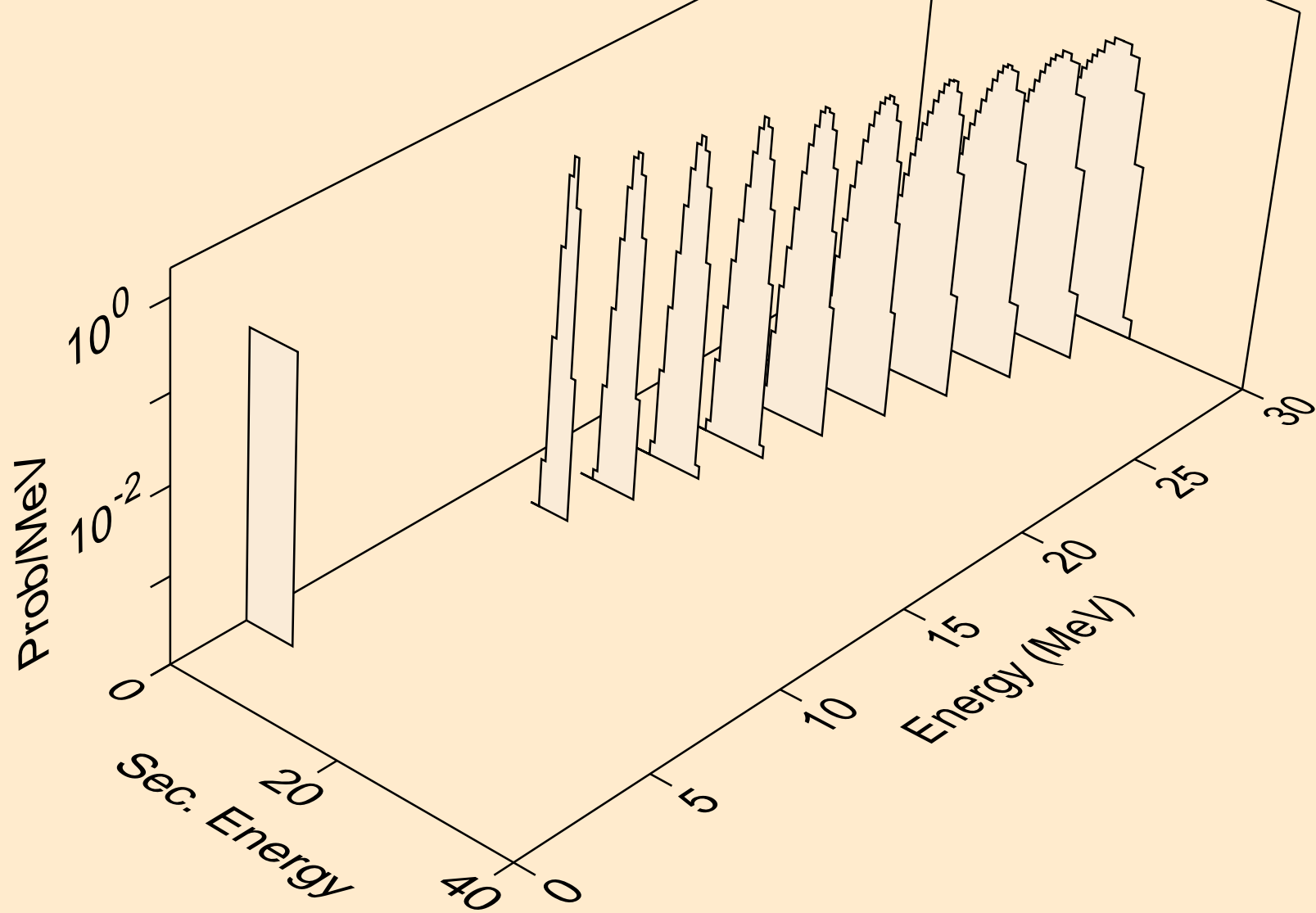

IR204 TRITON ACER TENDL-2023 LIBRARY; T=0.K
alphas from (t,a)

