

KR089 TRITON ACER TENDL-2021 LIBRARY; T=0.K  
Principal cross sections

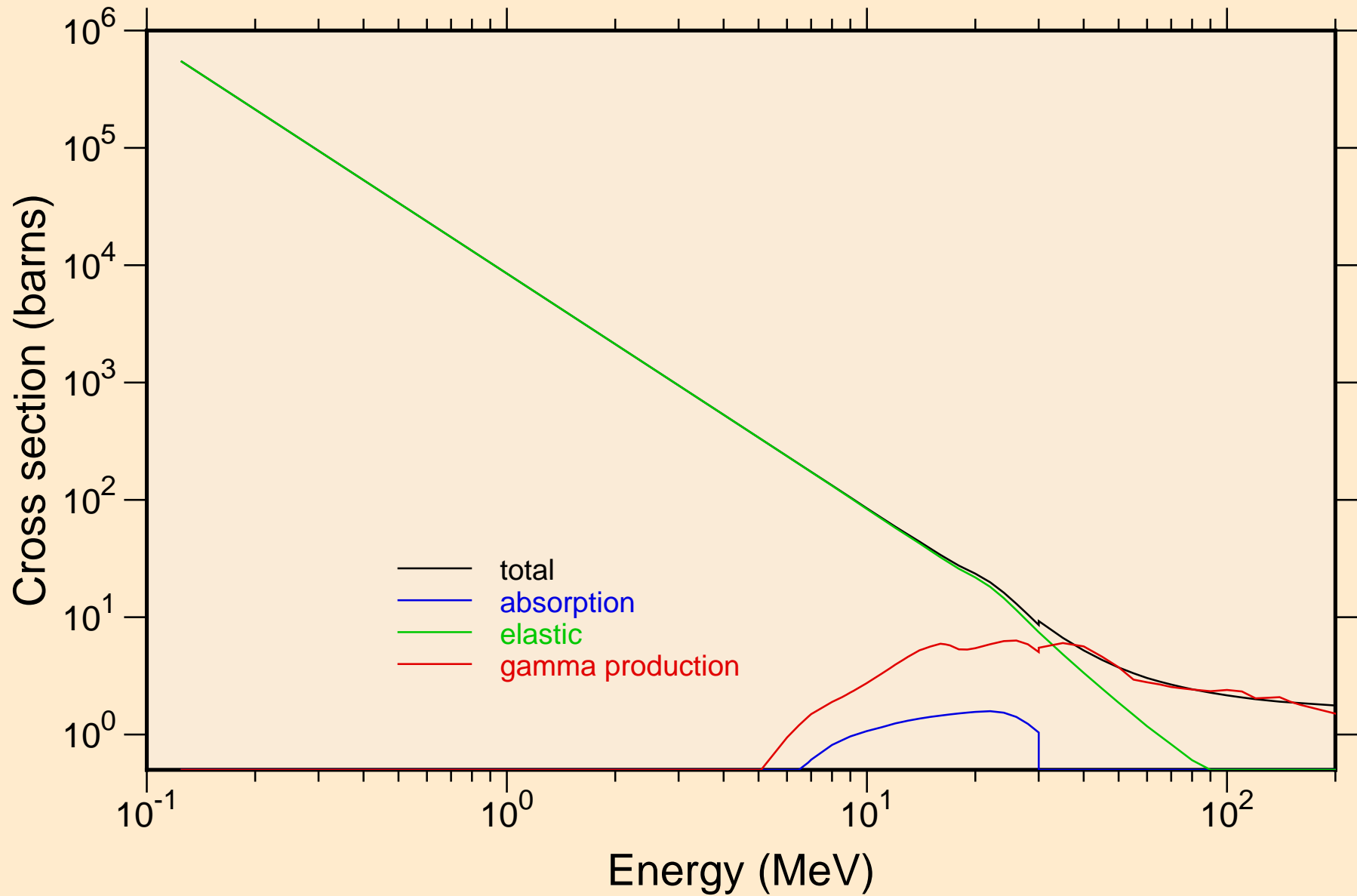

KR089 TRITON ACER TENDL-2021 LIBRARY; T=0.K

Heating

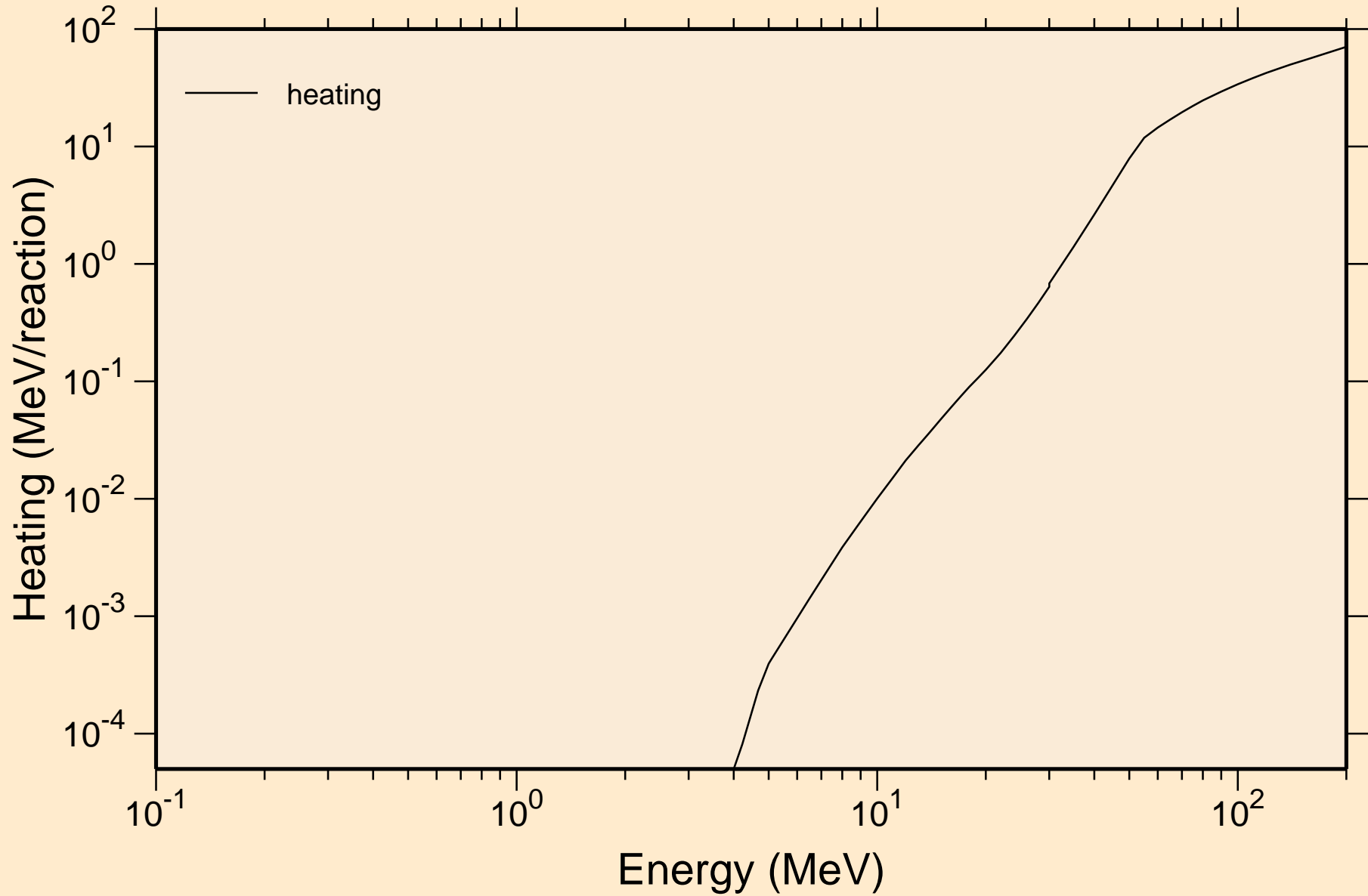

# KR089 TRITON ACER TENDL-2021 LIBRARY; T=0.K

## Principal cross sections

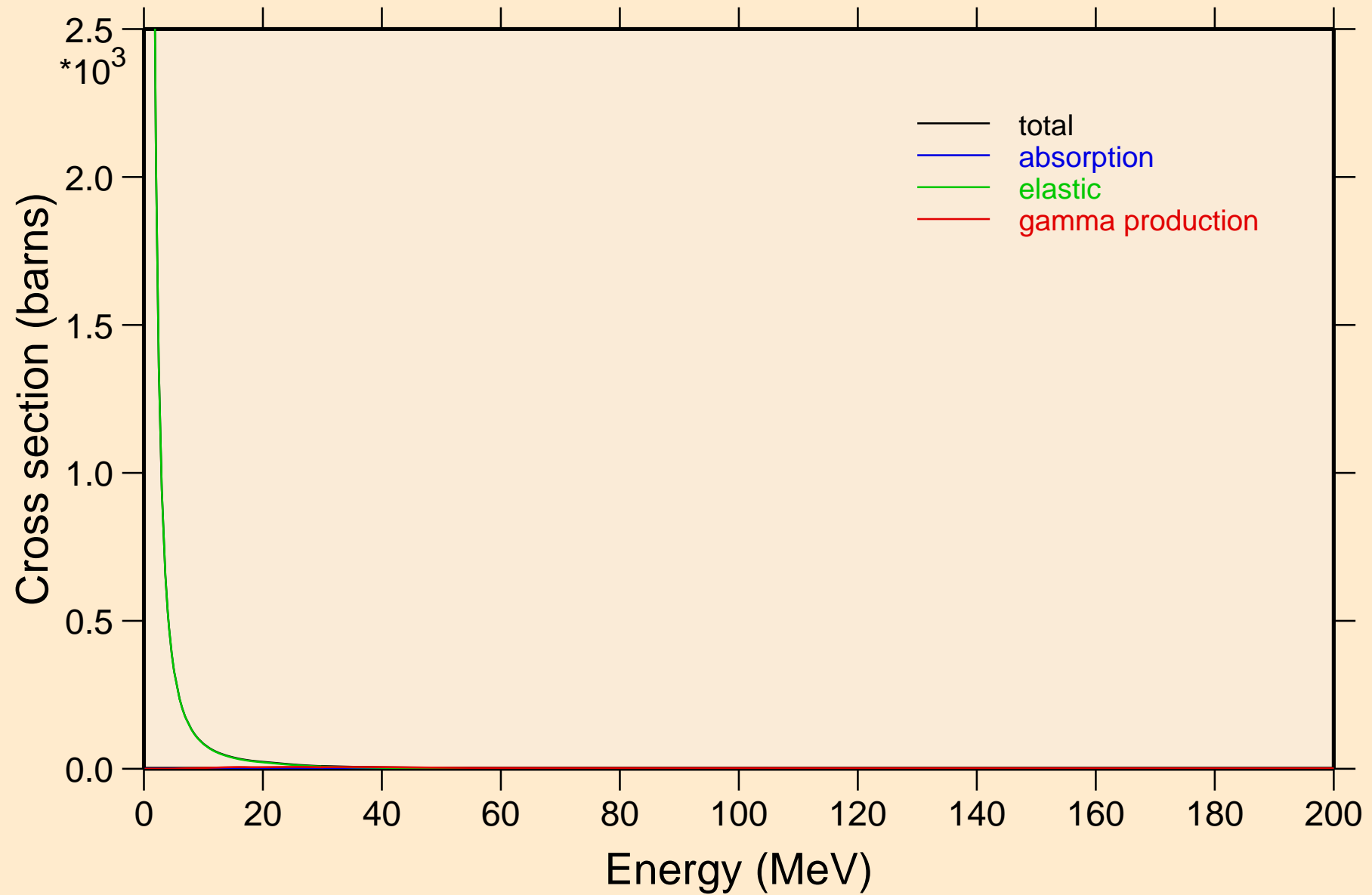

KR089 TRITON ACER TENDL-2021 LIBRARY; T=0.K

Heating

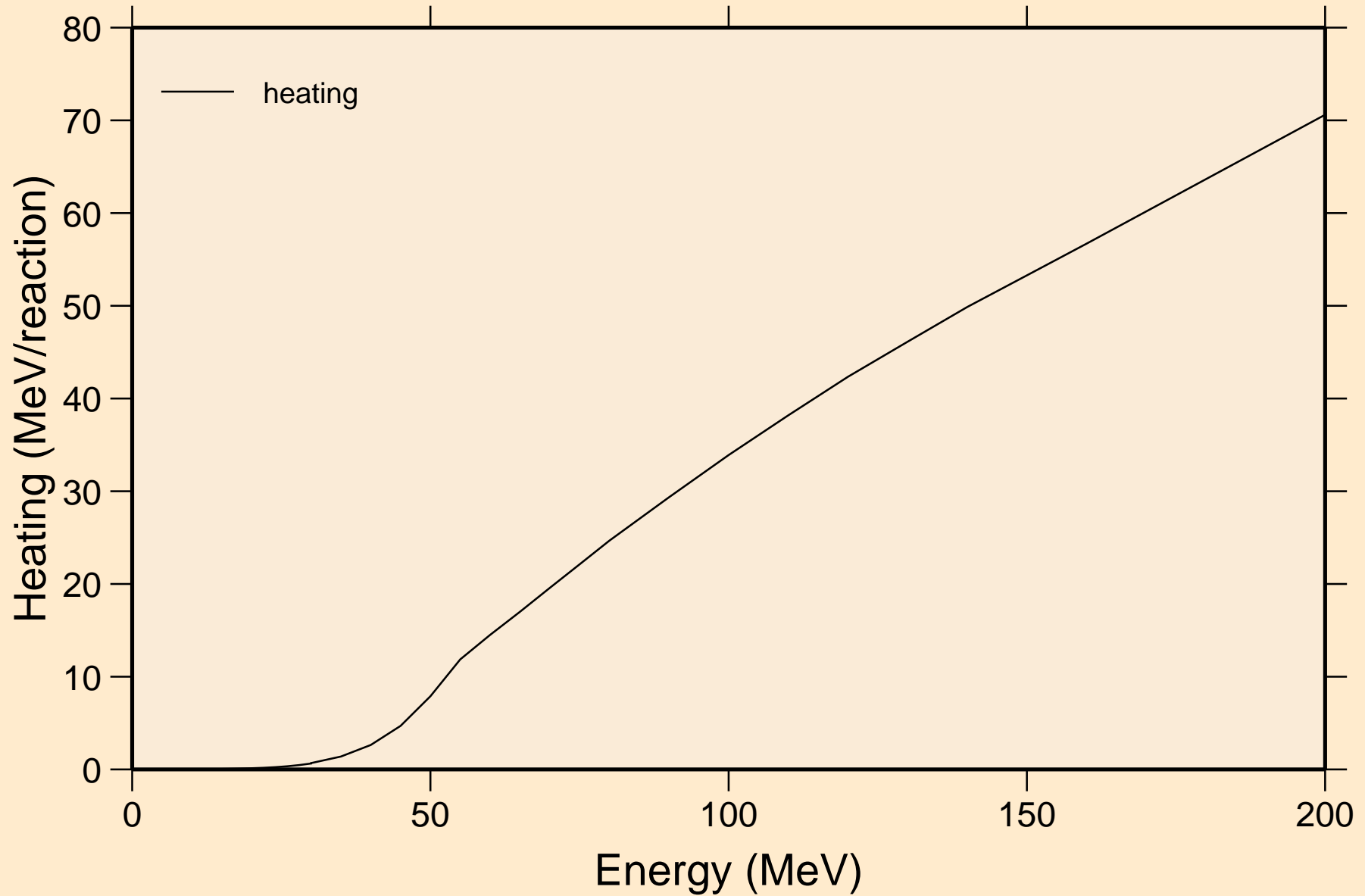

# KR089 TRITON ACER TENDL-2021 LIBRARY; T=0.K

## Threshold reactions

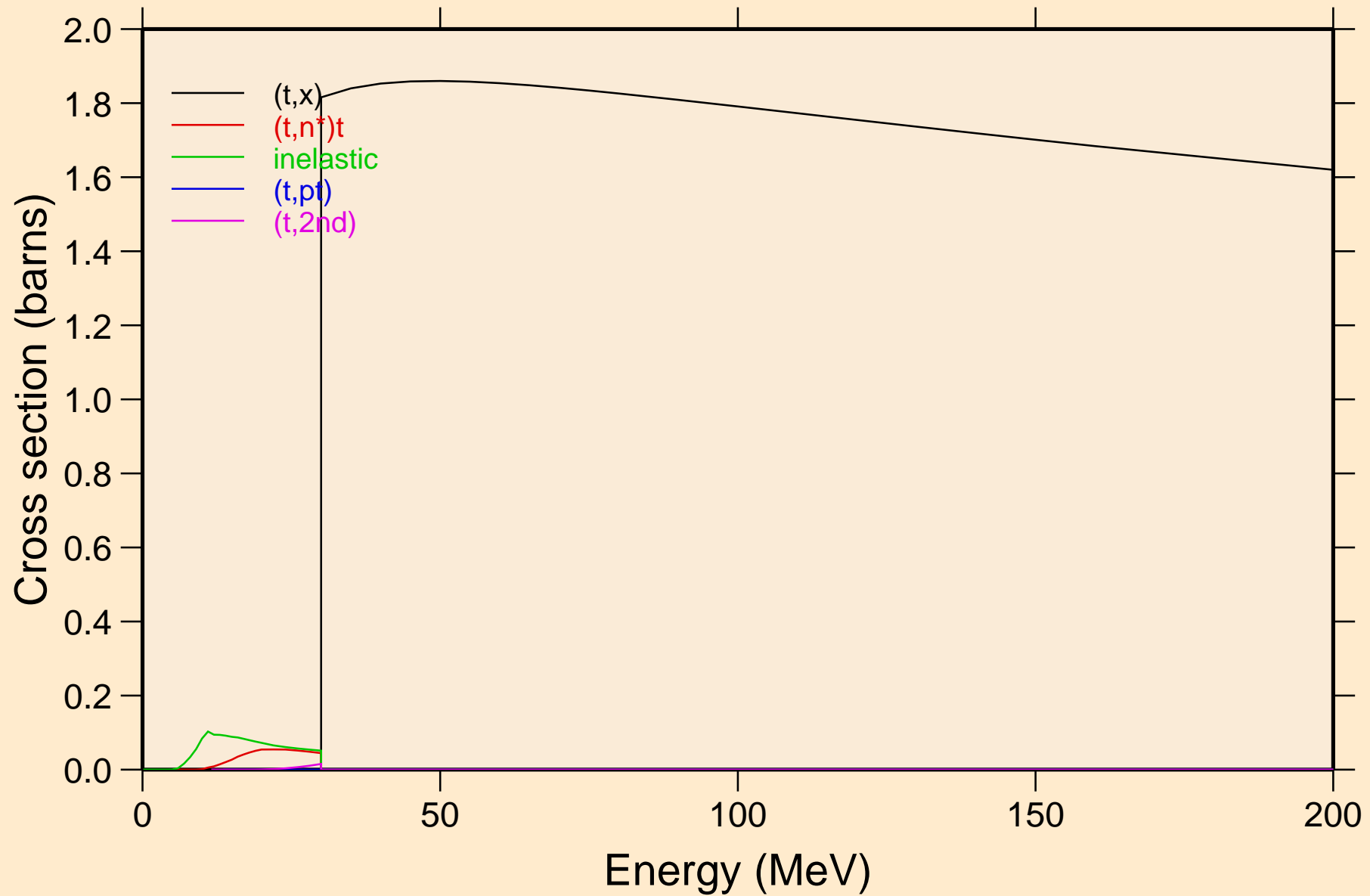

KR089 TRITON ACER TENDL-2021 LIBRARY; T=0.K  
Threshold reactions

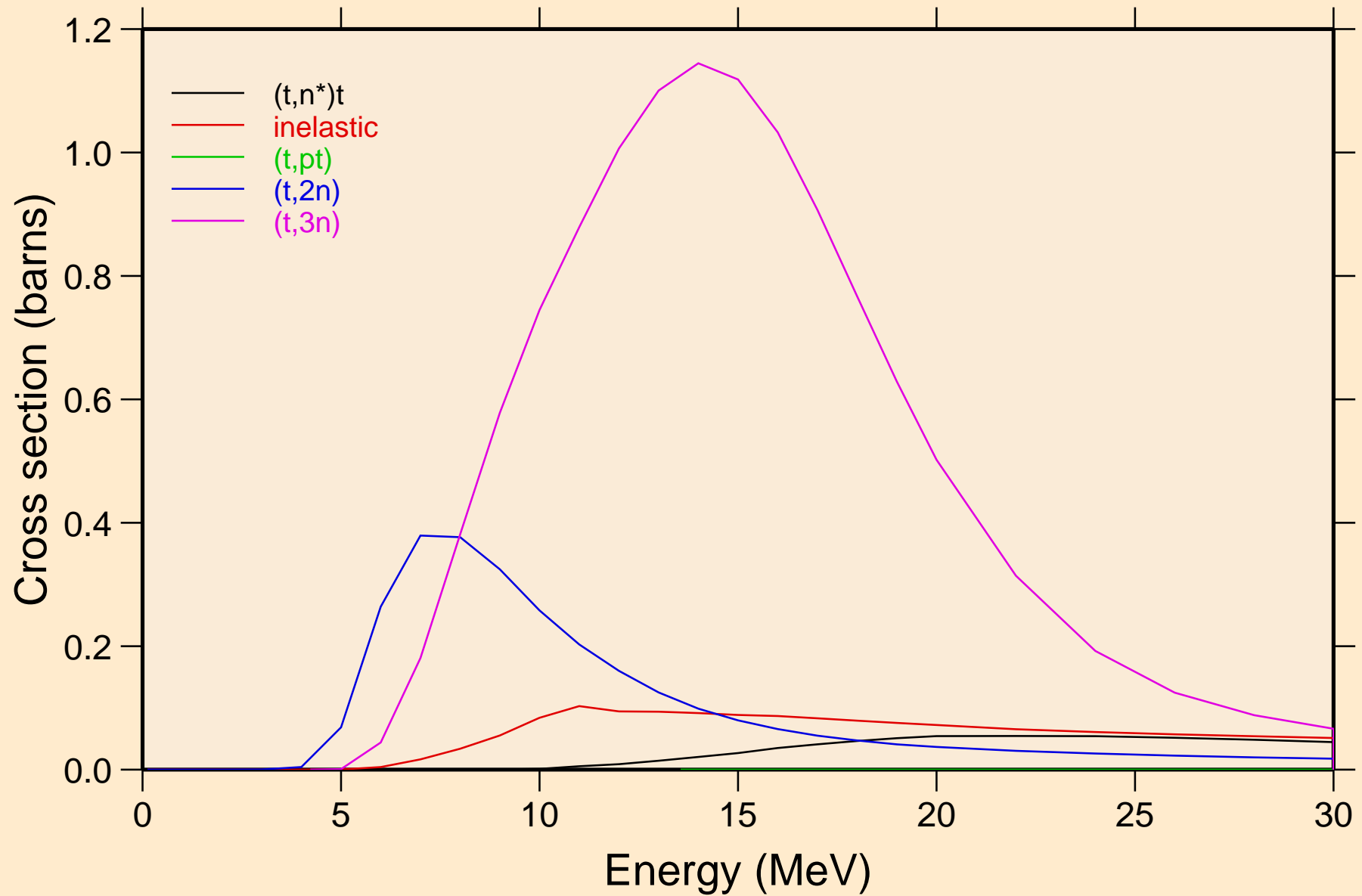

KR089 TRITON ACER TENDL-2021 LIBRARY; T=0.K  
Threshold reactions

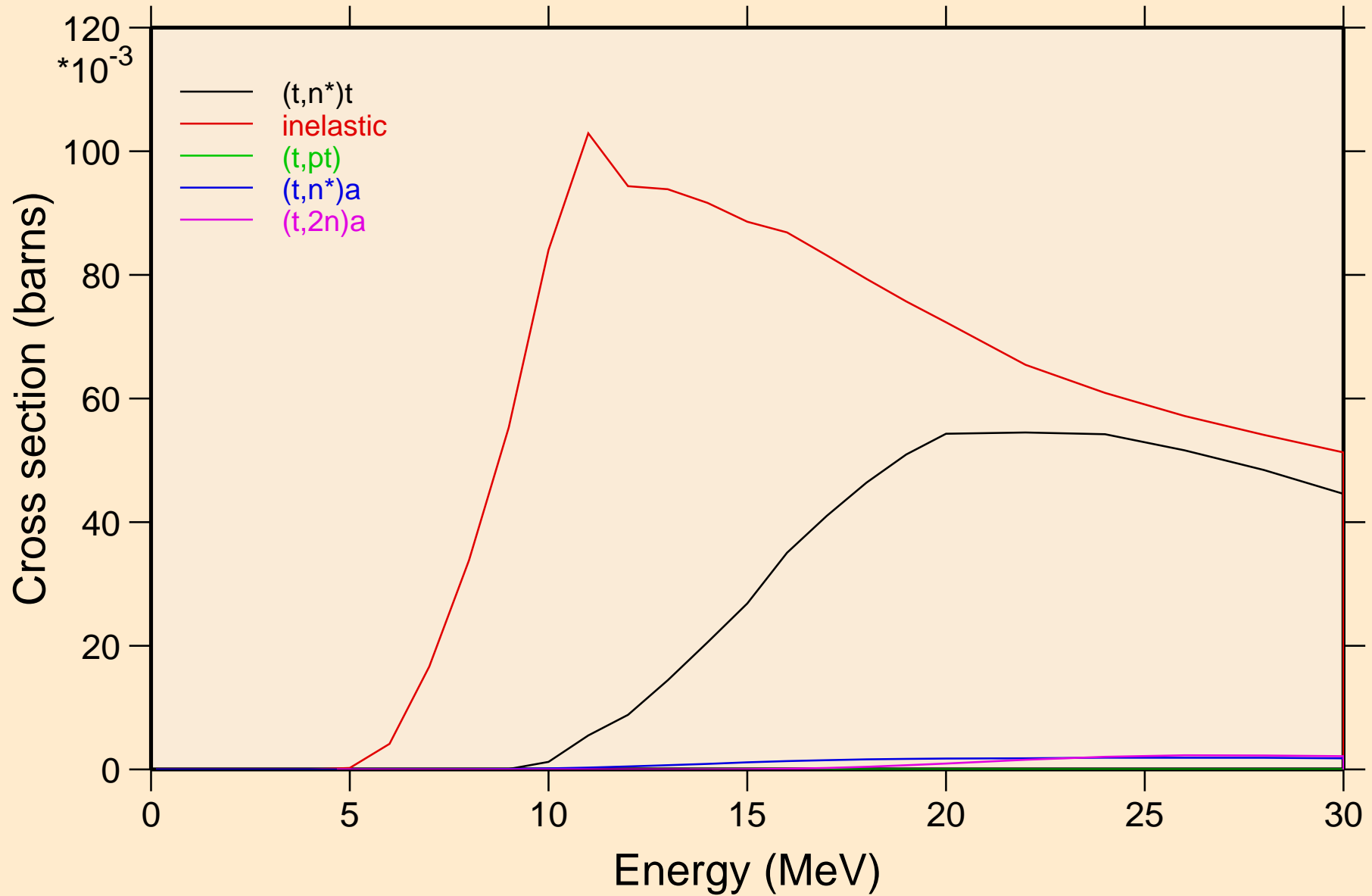

KR089 TRITON ACER TENDL-2021 LIBRARY; T=0.K  
Threshold reactions

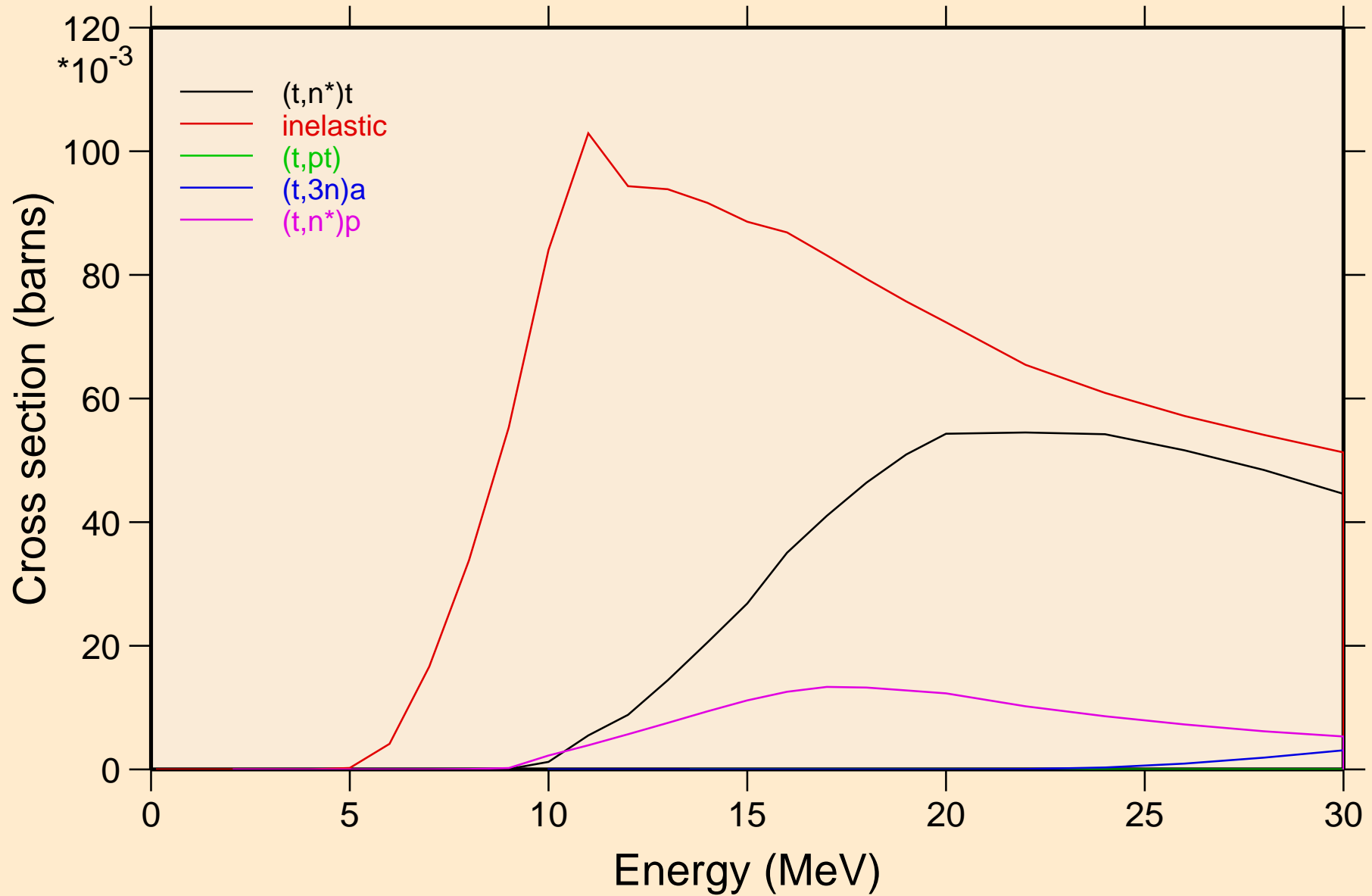



KR089 TRITON ACER TENDL-2021 LIBRARY; T=0.K  
Threshold reactions

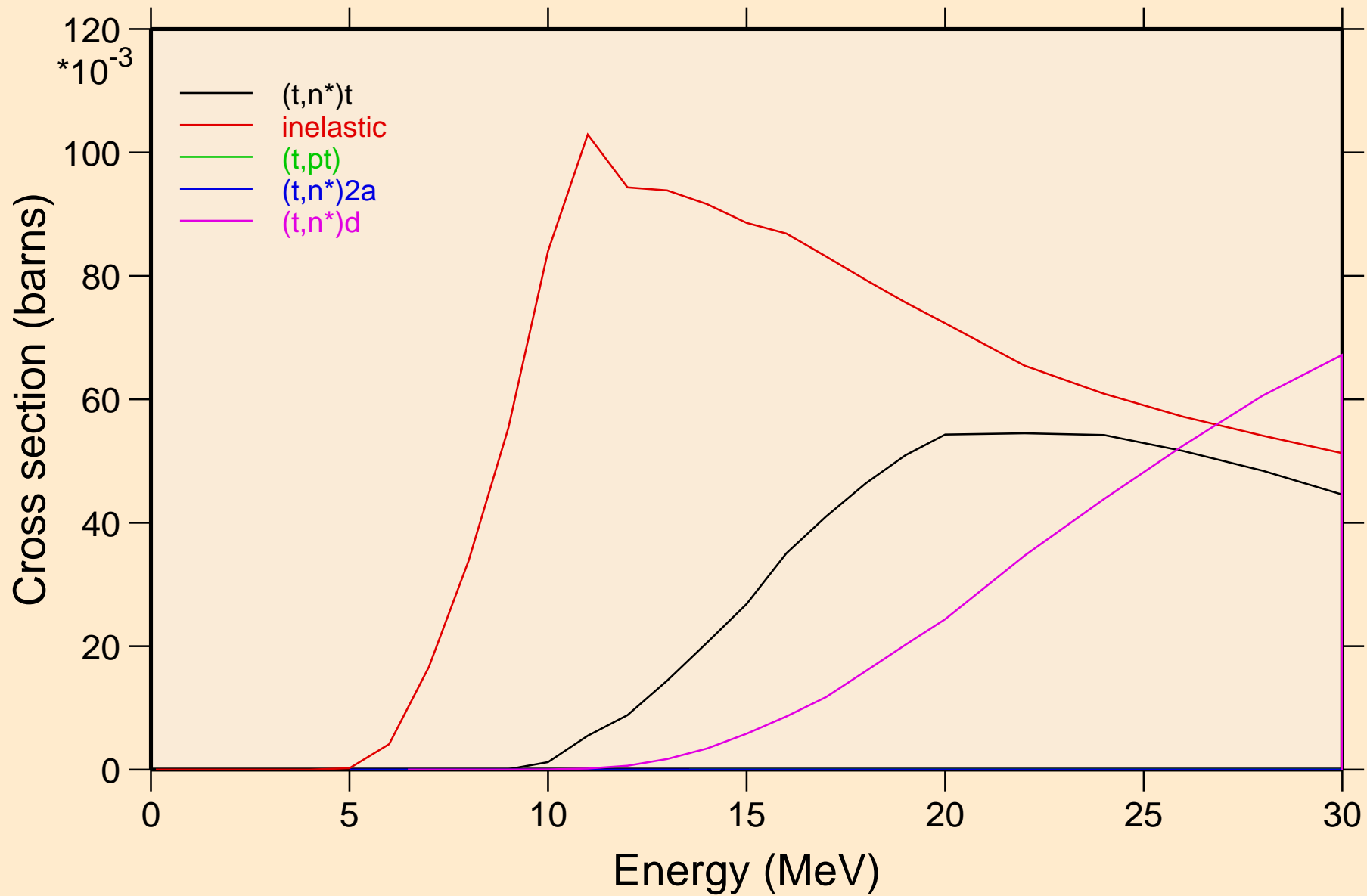

KR089 TRITON ACER TENDL-2021 LIBRARY; T=0.K  
Threshold reactions

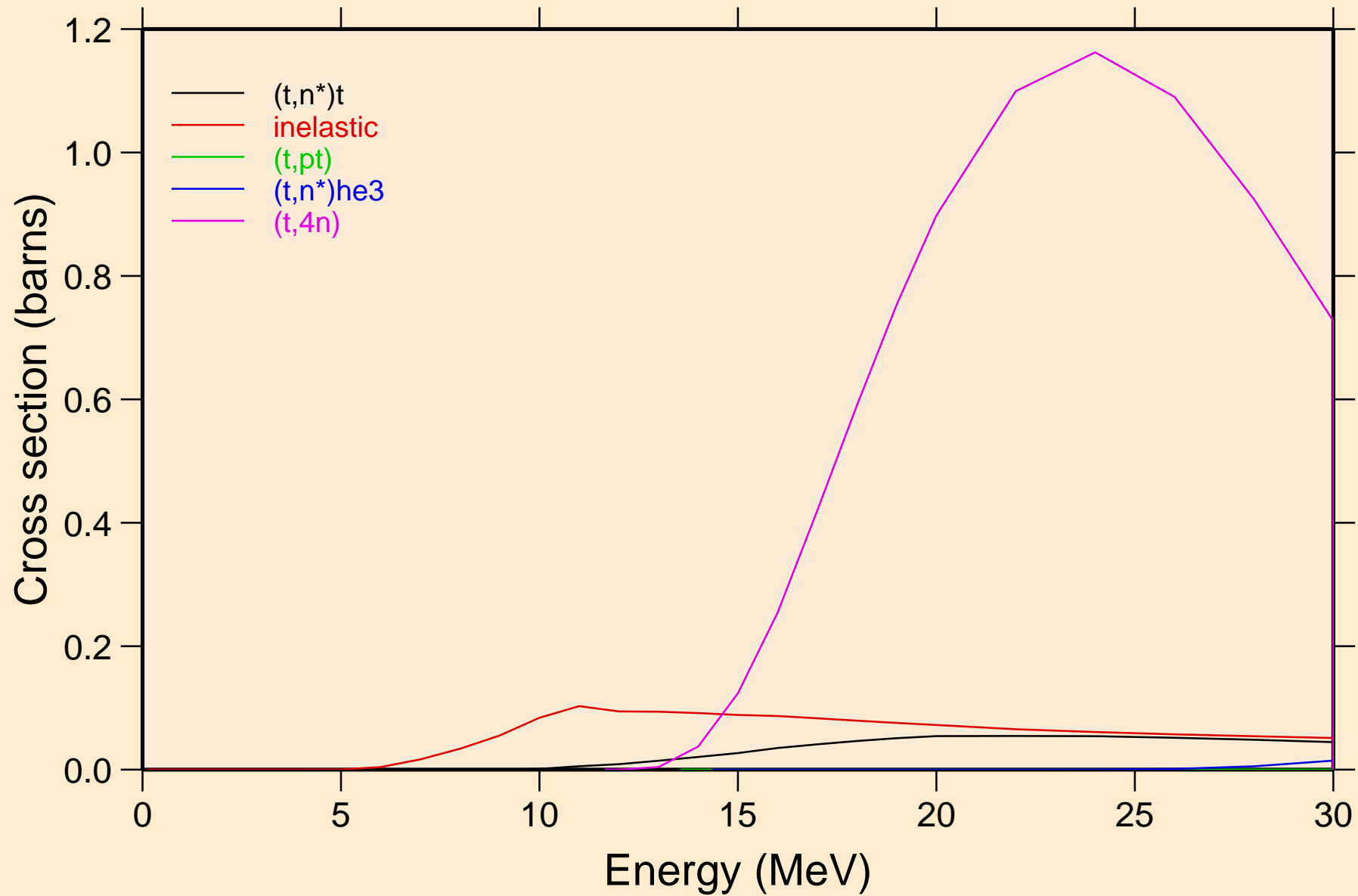

KR089 TRITON ACER TENDL-2021 LIBRARY; T=0.K  
Threshold reactions

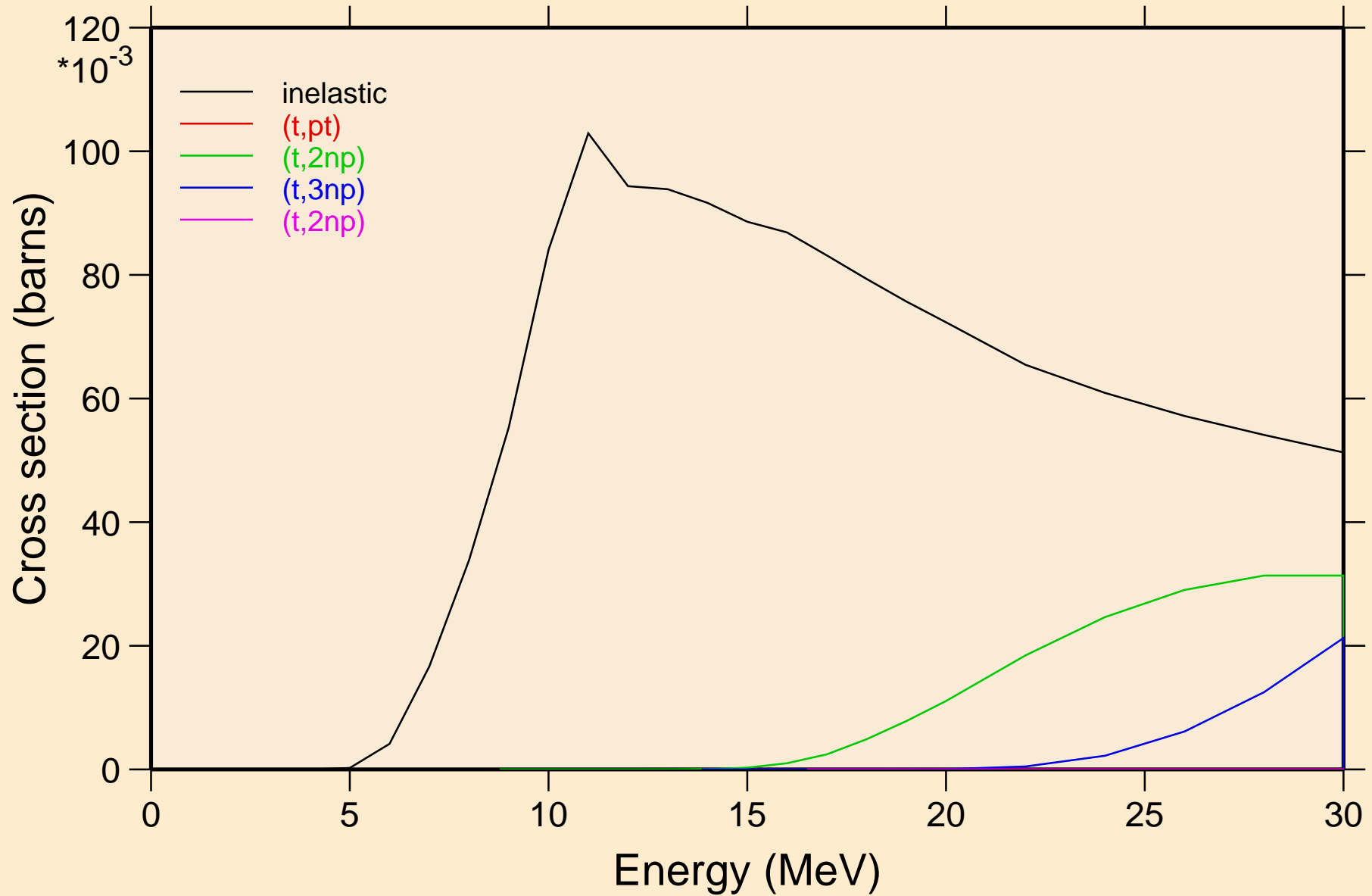

KR089 TRITON ACER TENDL-2021 LIBRARY; T=0.K  
Threshold reactions

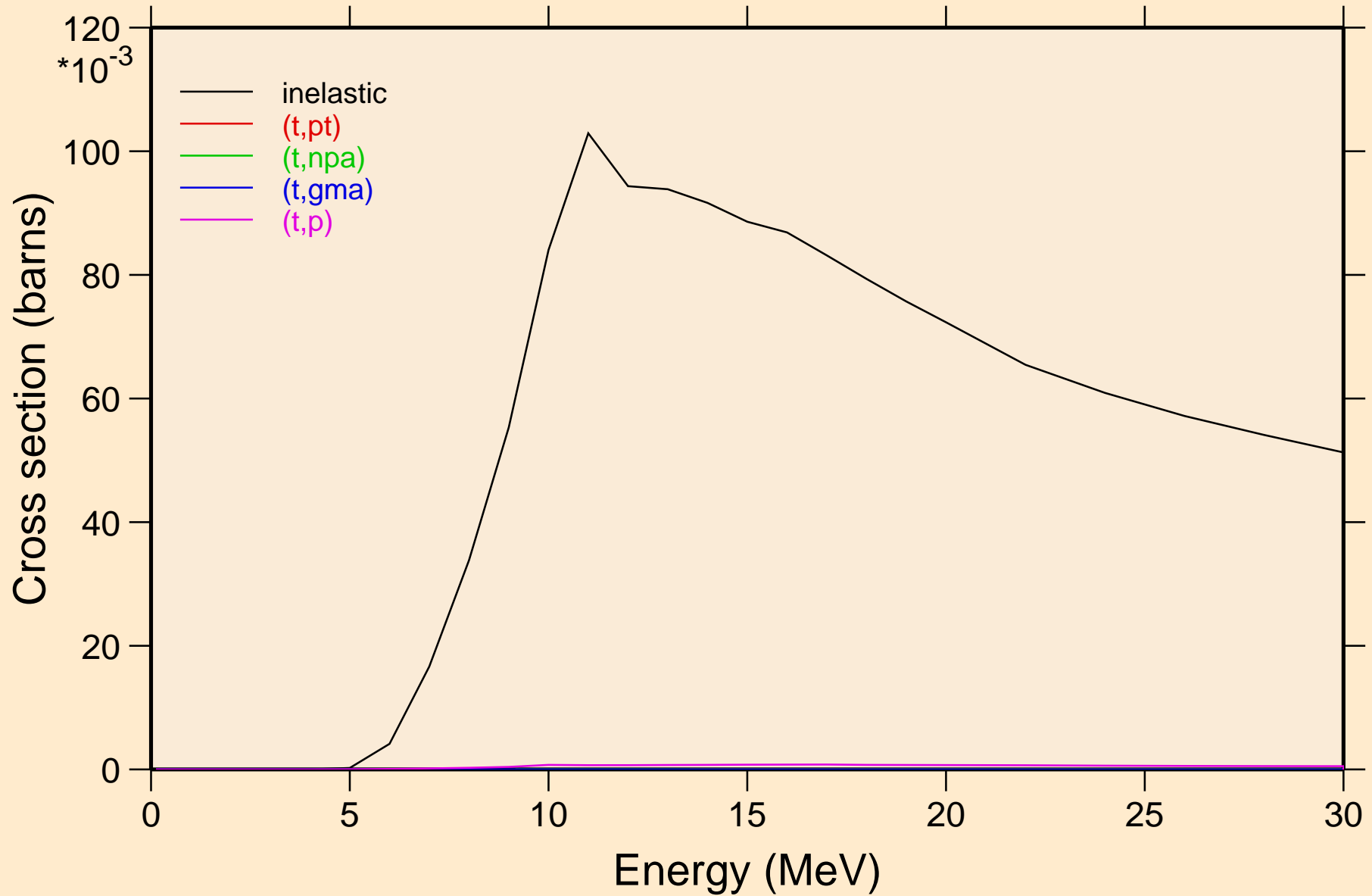

KR089 TRITON ACER TENDL-2021 LIBRARY; T=0.K  
Threshold reactions

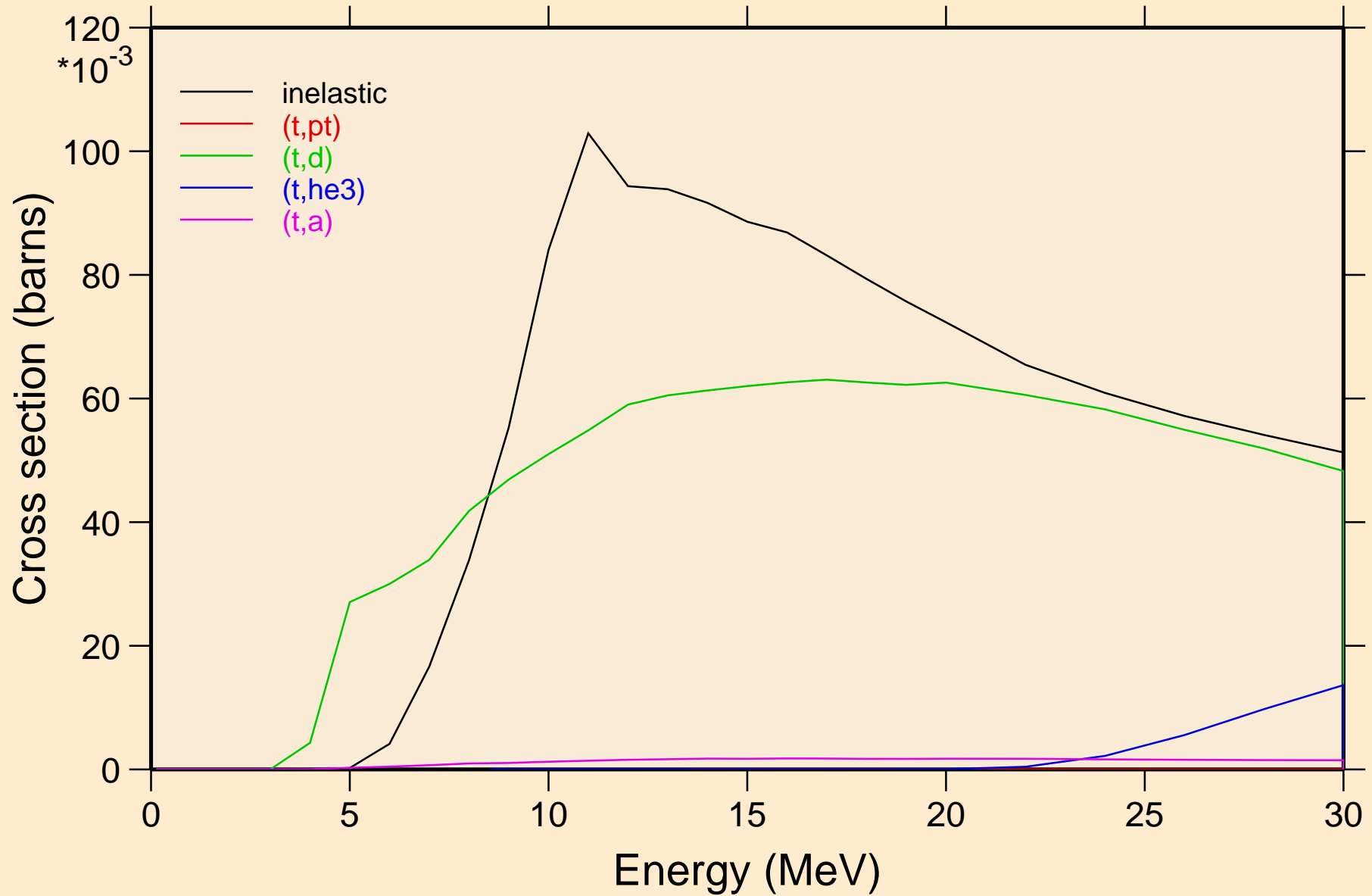

KR089 TRITON ACER TENDL-2021 LIBRARY; T=0.K  
Threshold reactions

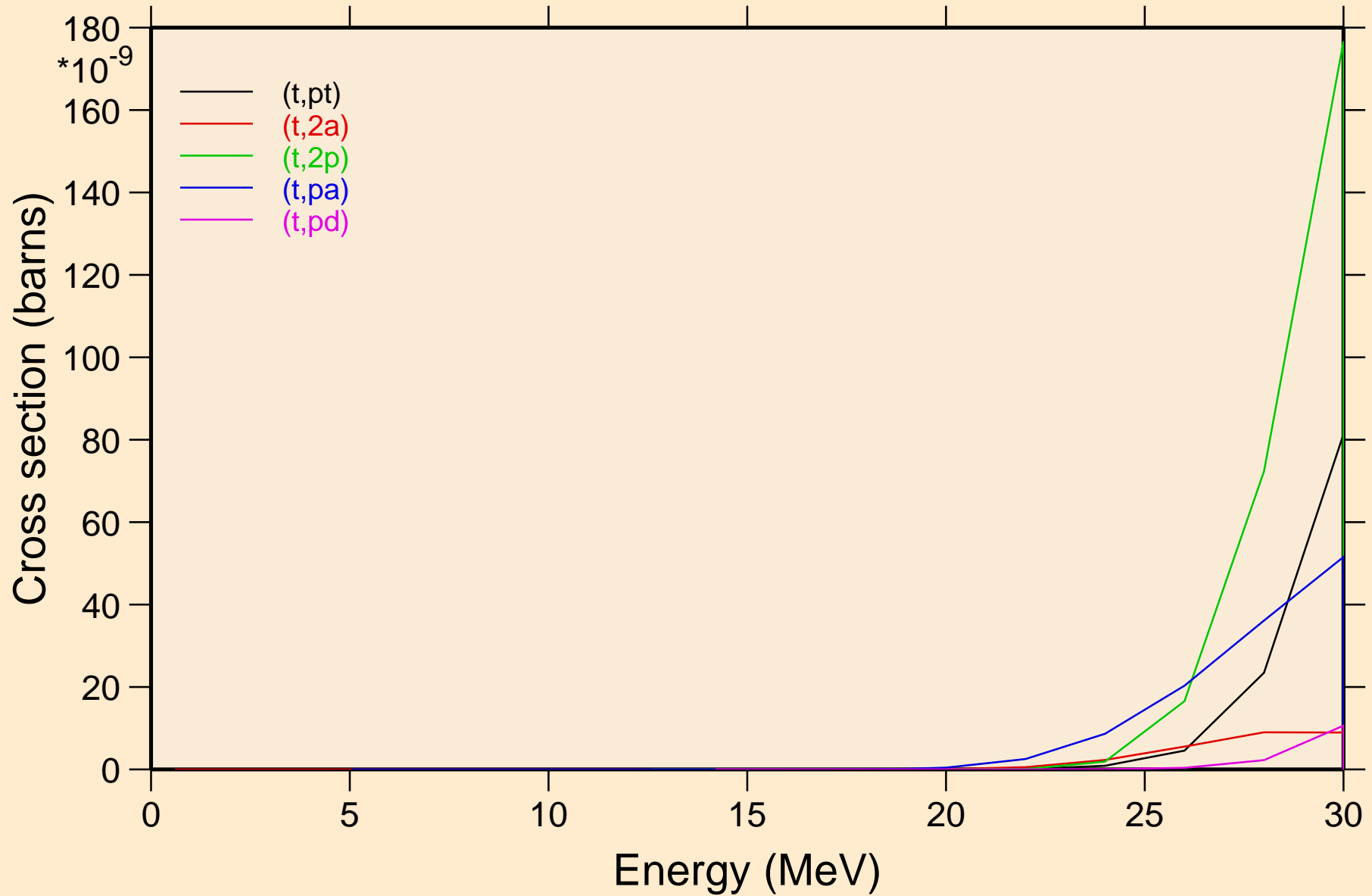

KR089 TRITON ACER TENDL-2021 LIBRARY; T=0.K  
Threshold reactions

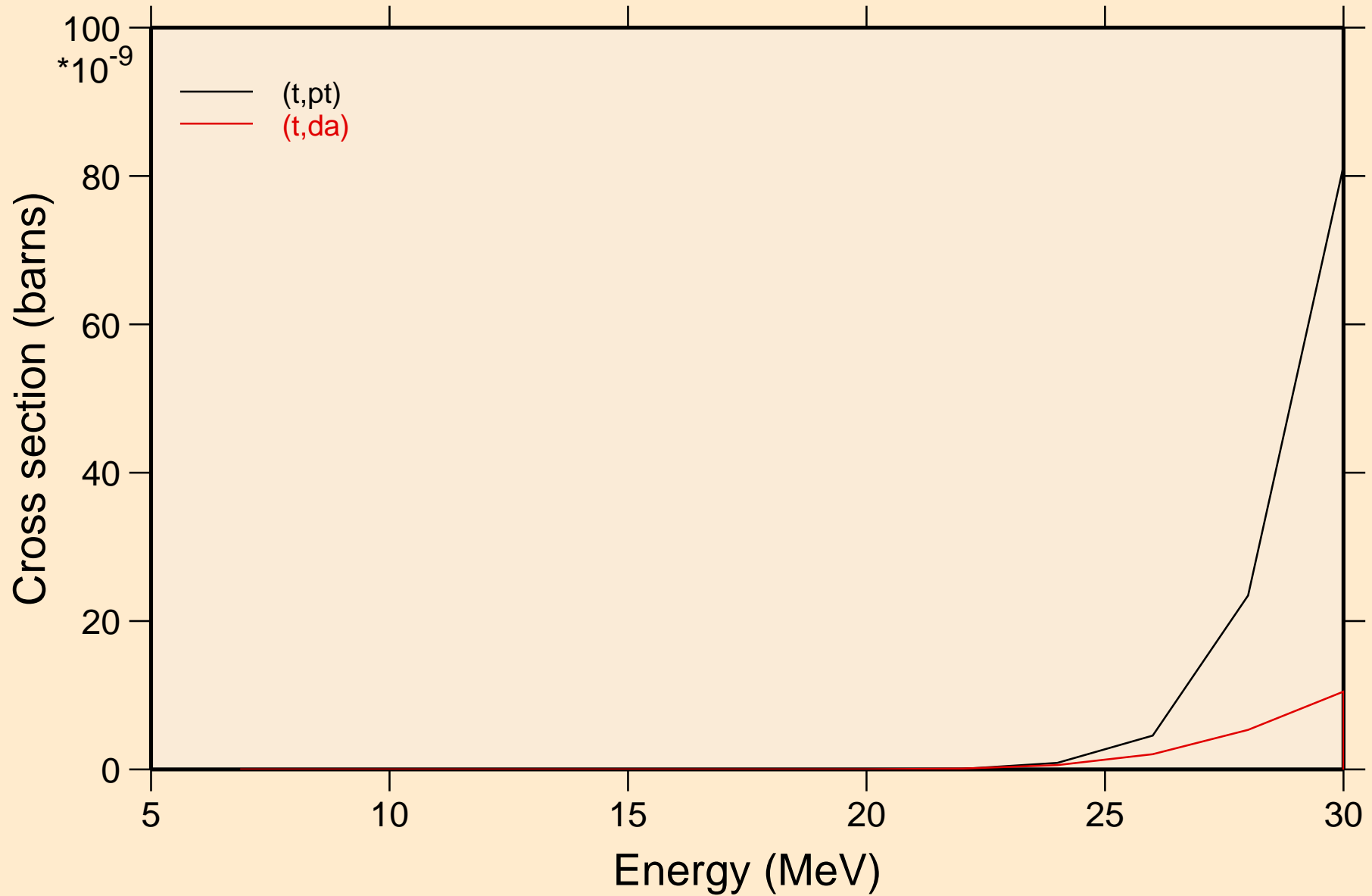

KR089 TRITON ACER TENDL-2021 LIBRARY; T=0.K  
angular distribution for elastic

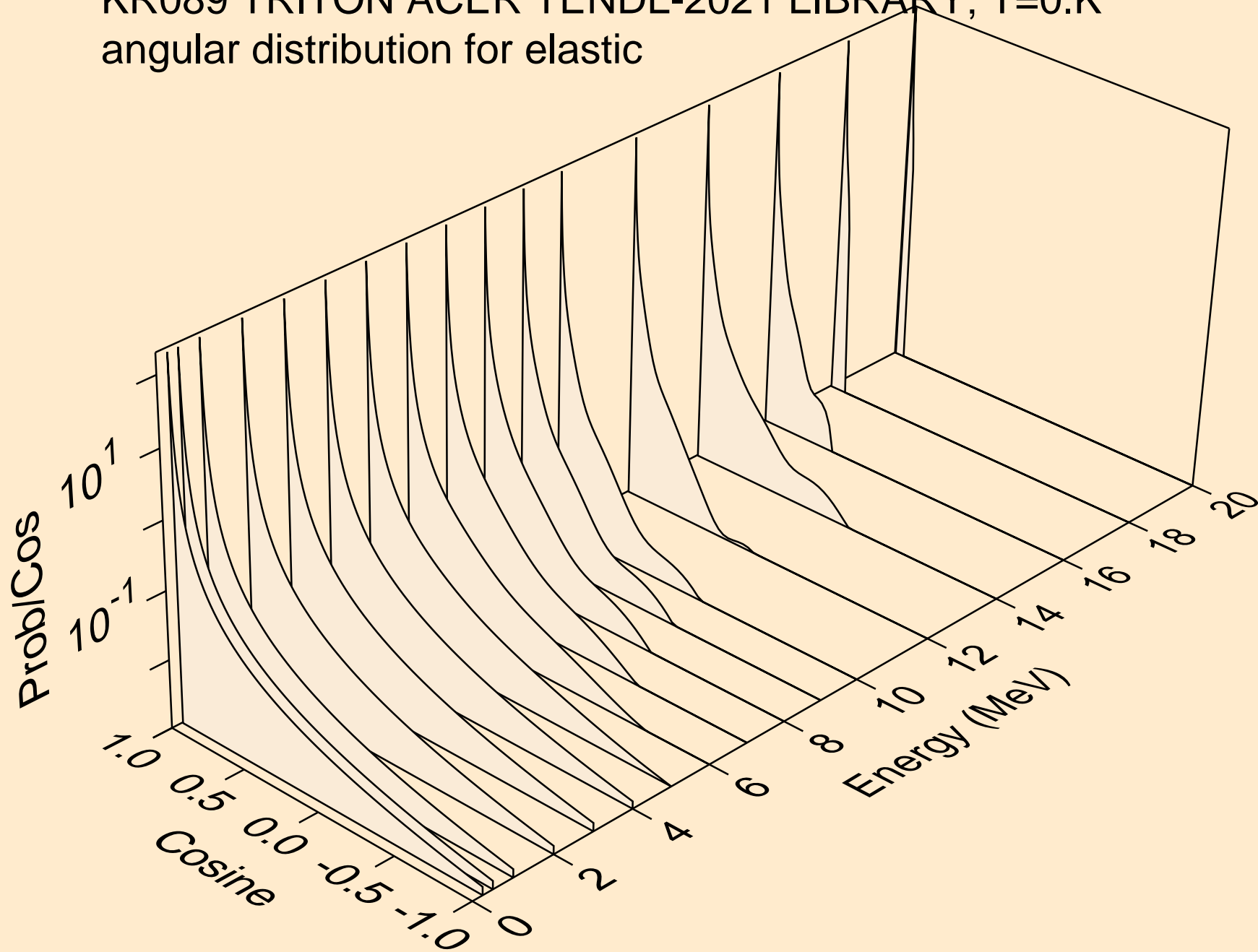



KR089 TRITON ACER TENDL-2021 LIBRARY; T=0.K  
angular distribution for elastic

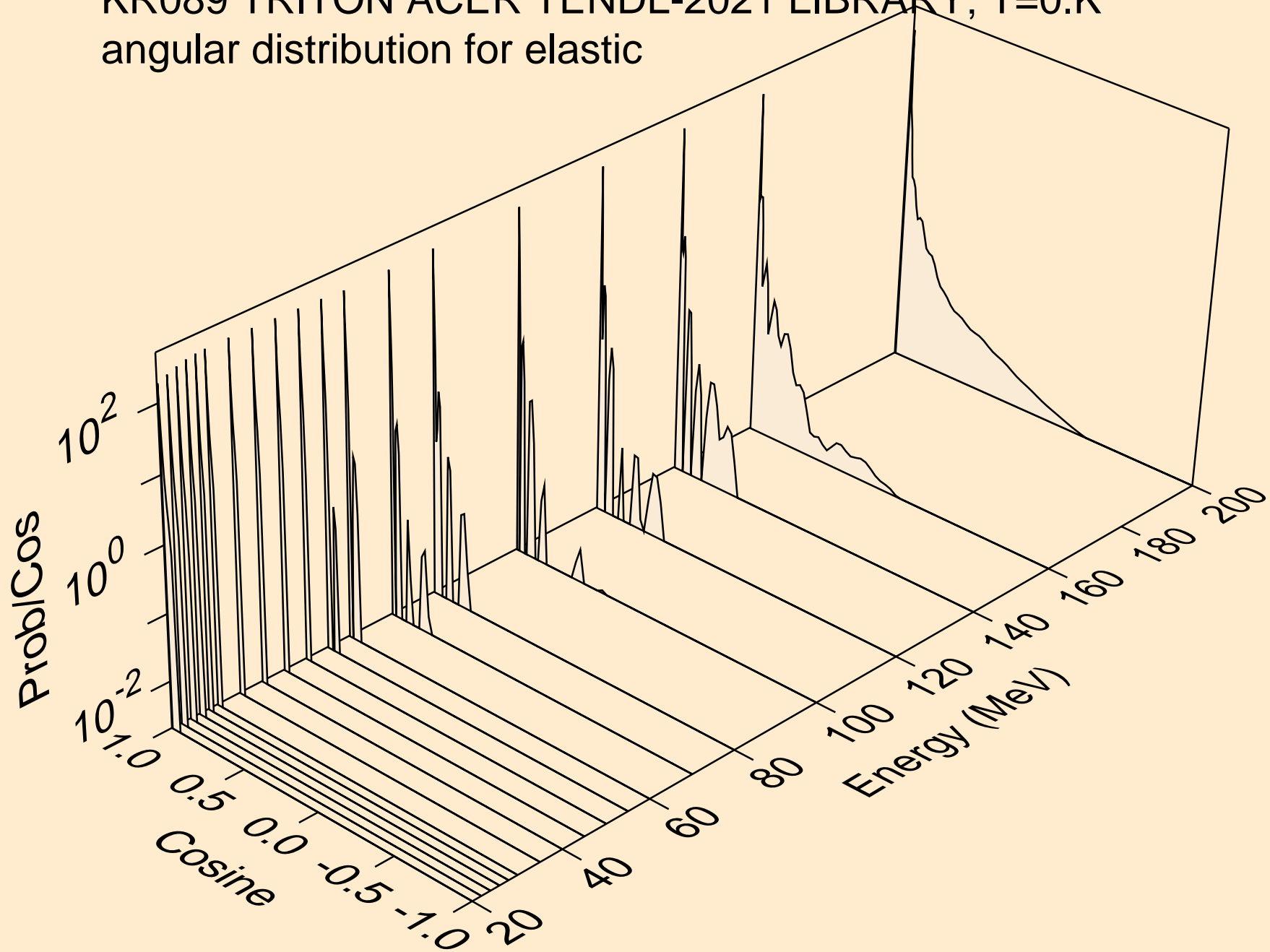

KR089 TRITON ACER TENDL-2021 LIBRARY; T=0.K  
Triton emission for (t,x)

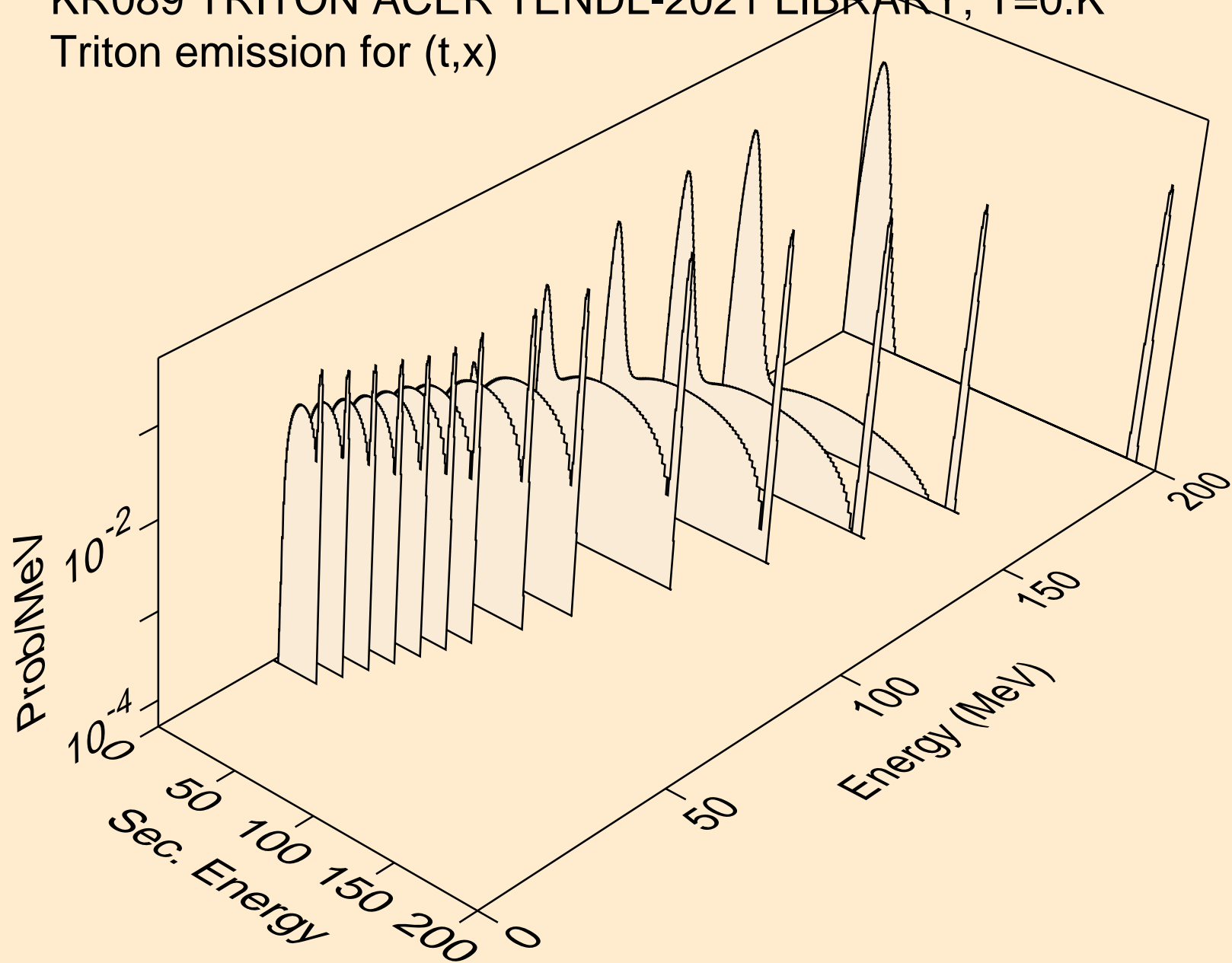

KR089 TRITON ACER TENDL-2021 LIBRARY; T=0.K  
Triton emission for (t,n\*)t

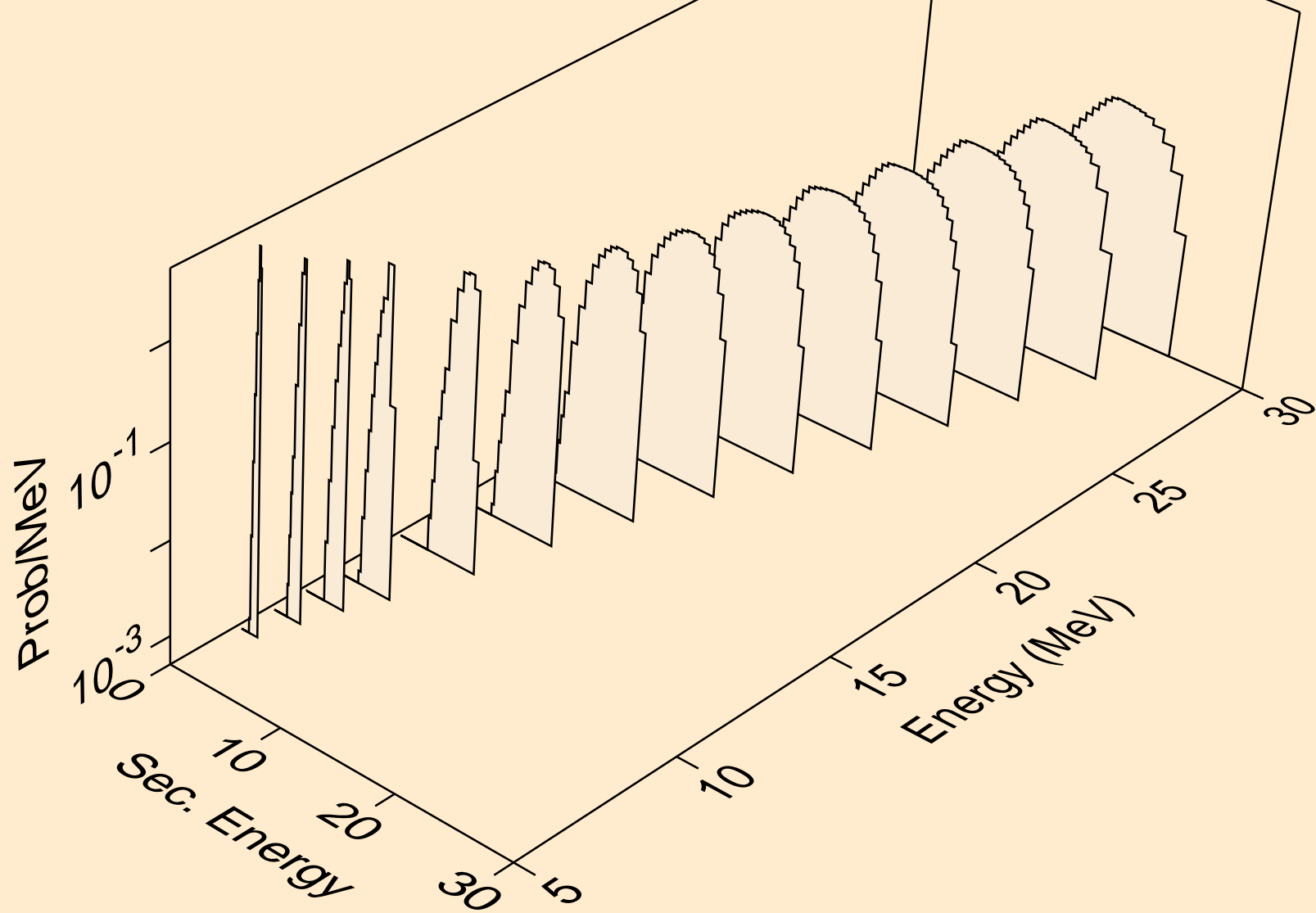

KR089 TRITON ACER TENDL-2021 LIBRARY; T=0.K  
Triton emission for inelastic

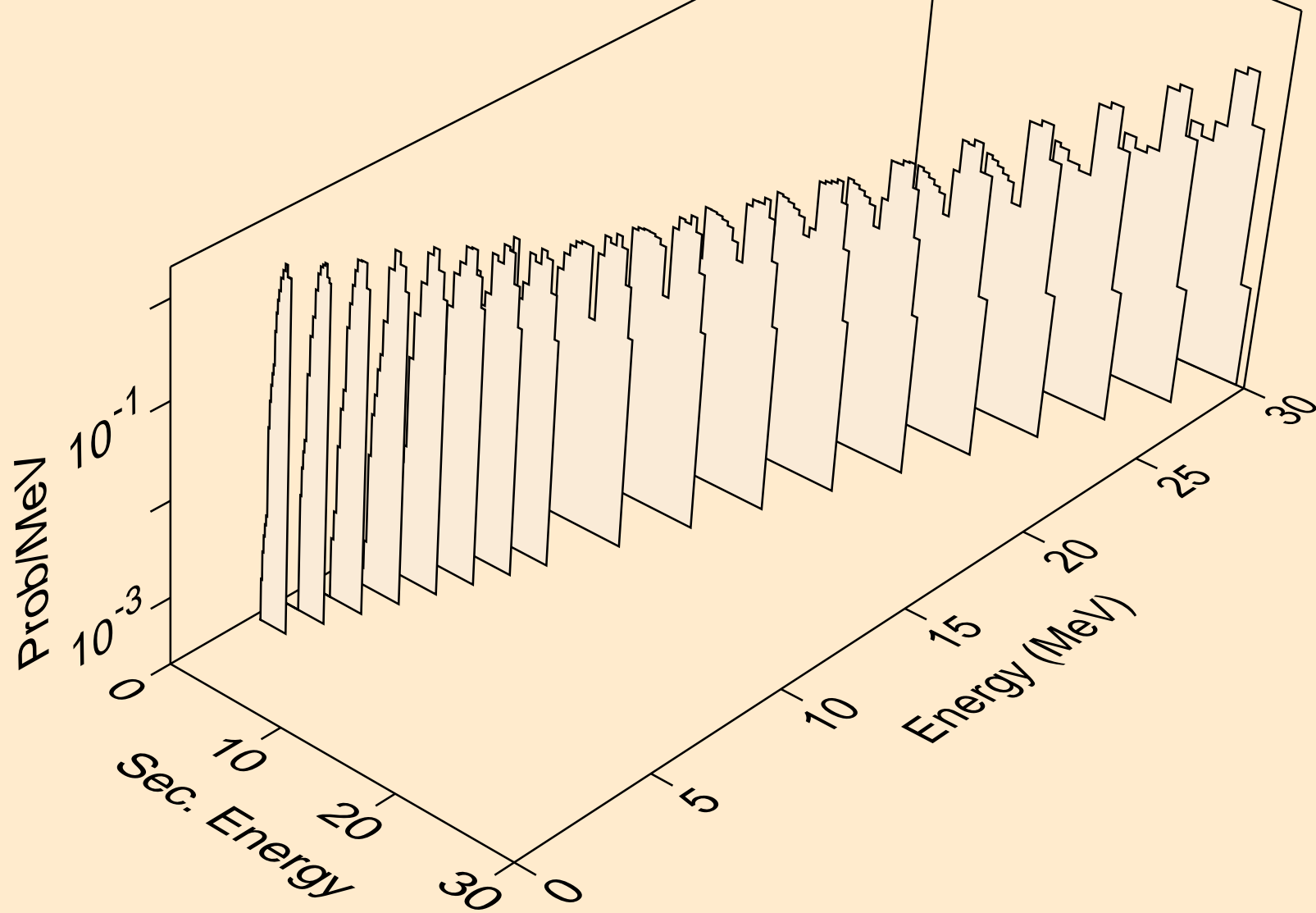

KR089 TRITON ACER TENDL-2021 LIBRARY; T=0.K  
Triton emission for (t,pt)

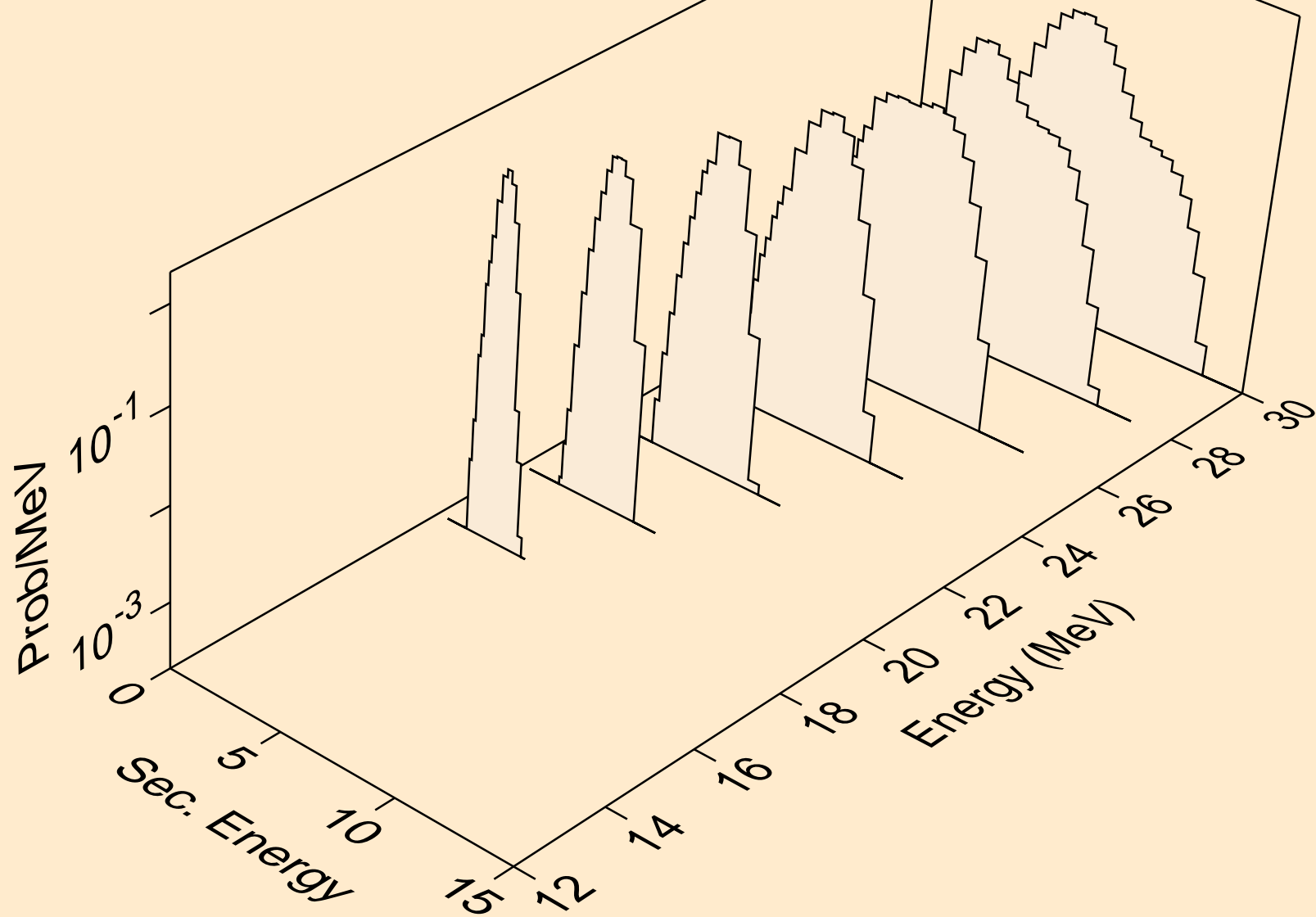

KR089 TRITON ACER TENDL-2021 LIBRARY; T=0.K  
Photon emission for (z,n)

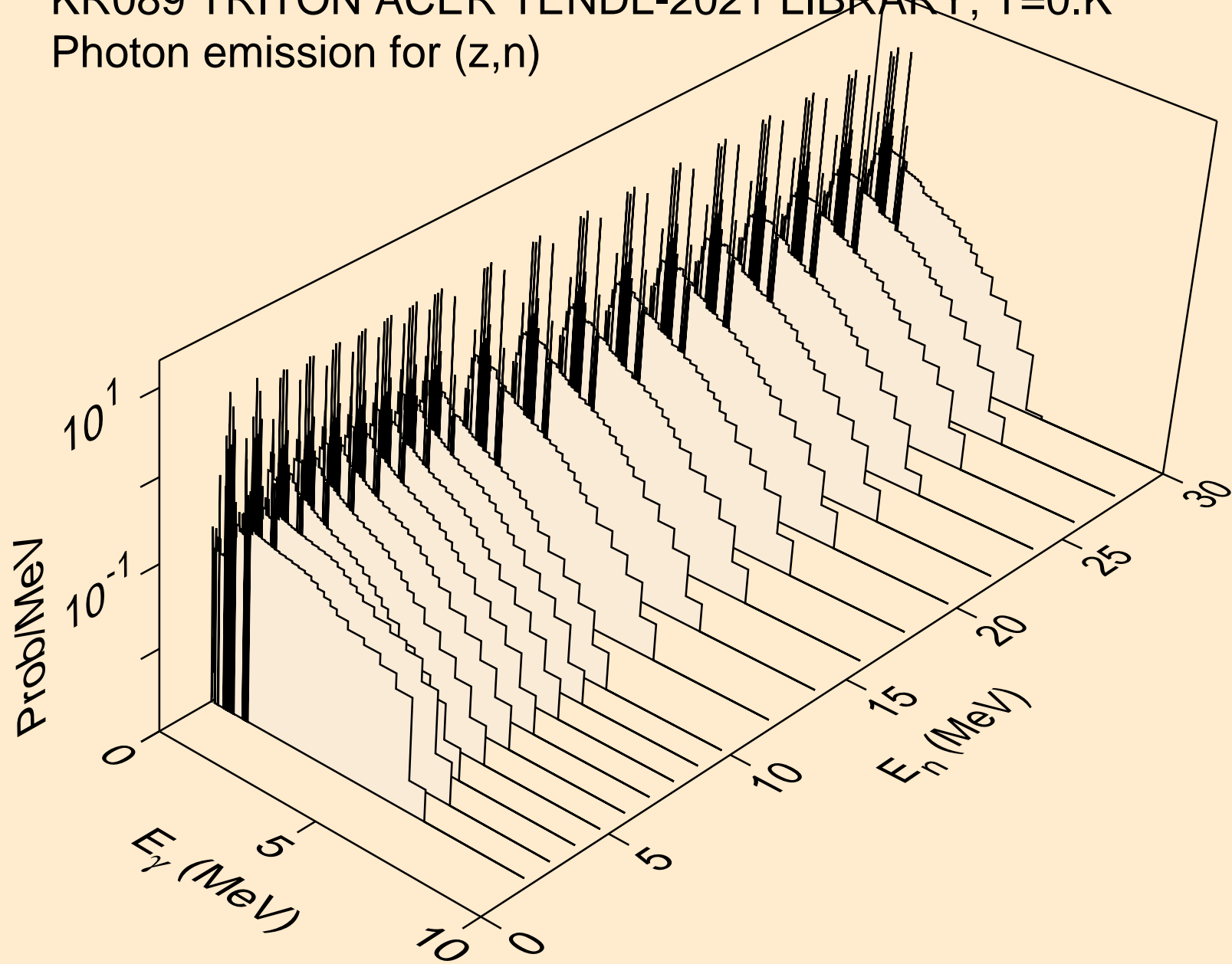

KR089 TRITON ACER TENDL-2021 LIBRARY; T=0.K  
Photon emission for (n,x)

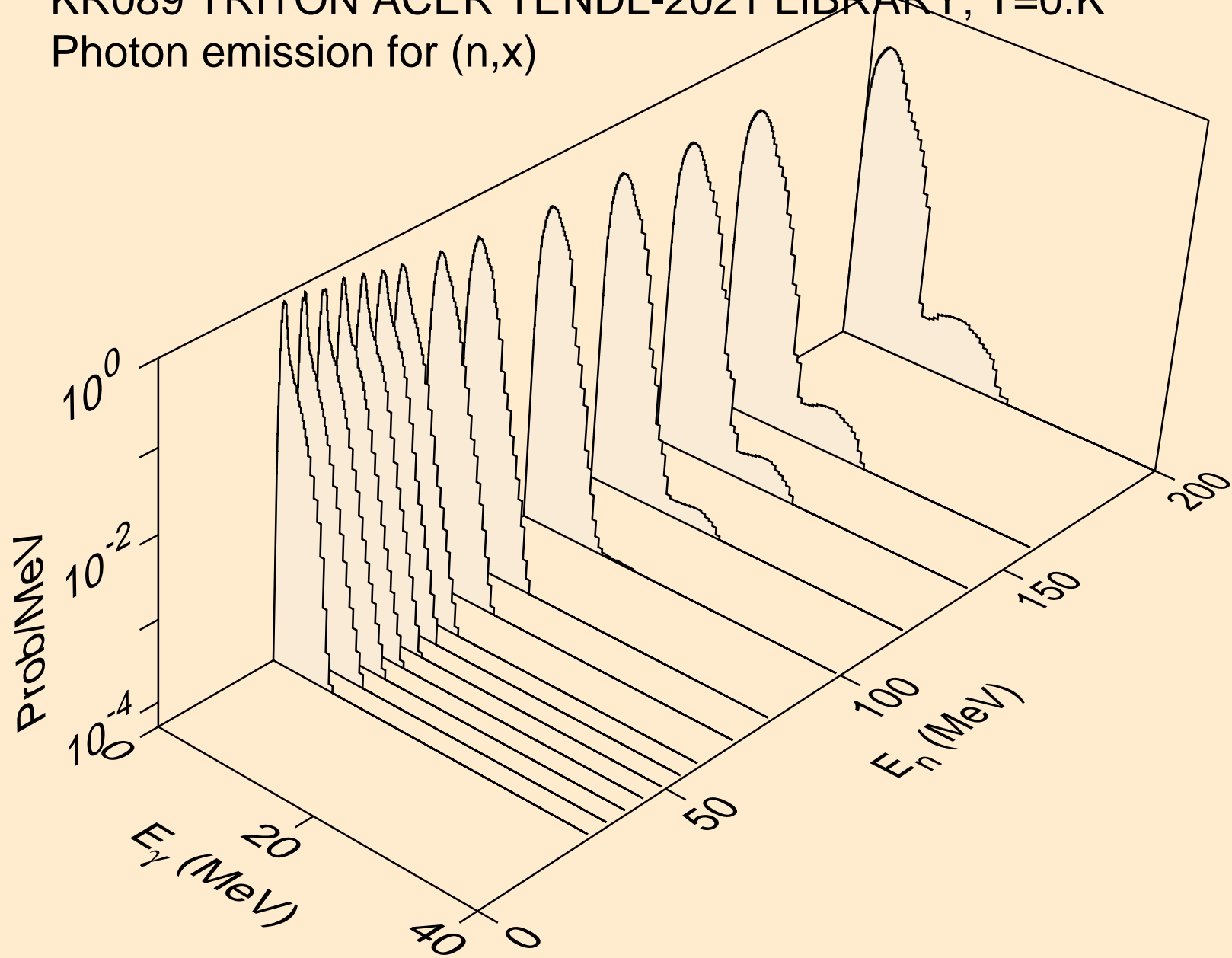

KR089 TRITON ACER TENDL-2021 LIBRARY; T=0.K  
Photon emission for (n,2nd)

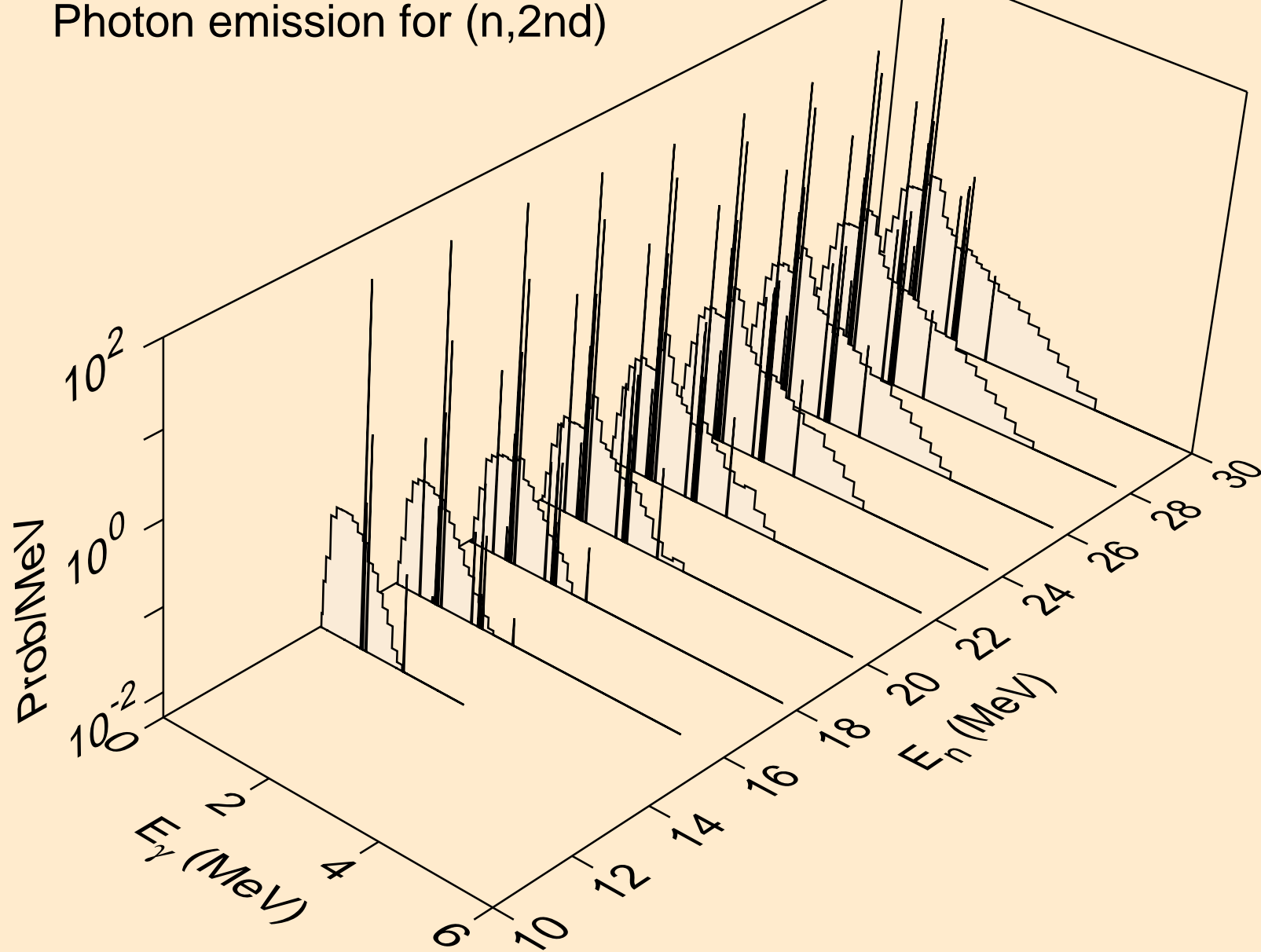



KR089 TRITON ACER TENDL-2021 LIBRARY; T=0.K  
Photon emission for (n,2n)

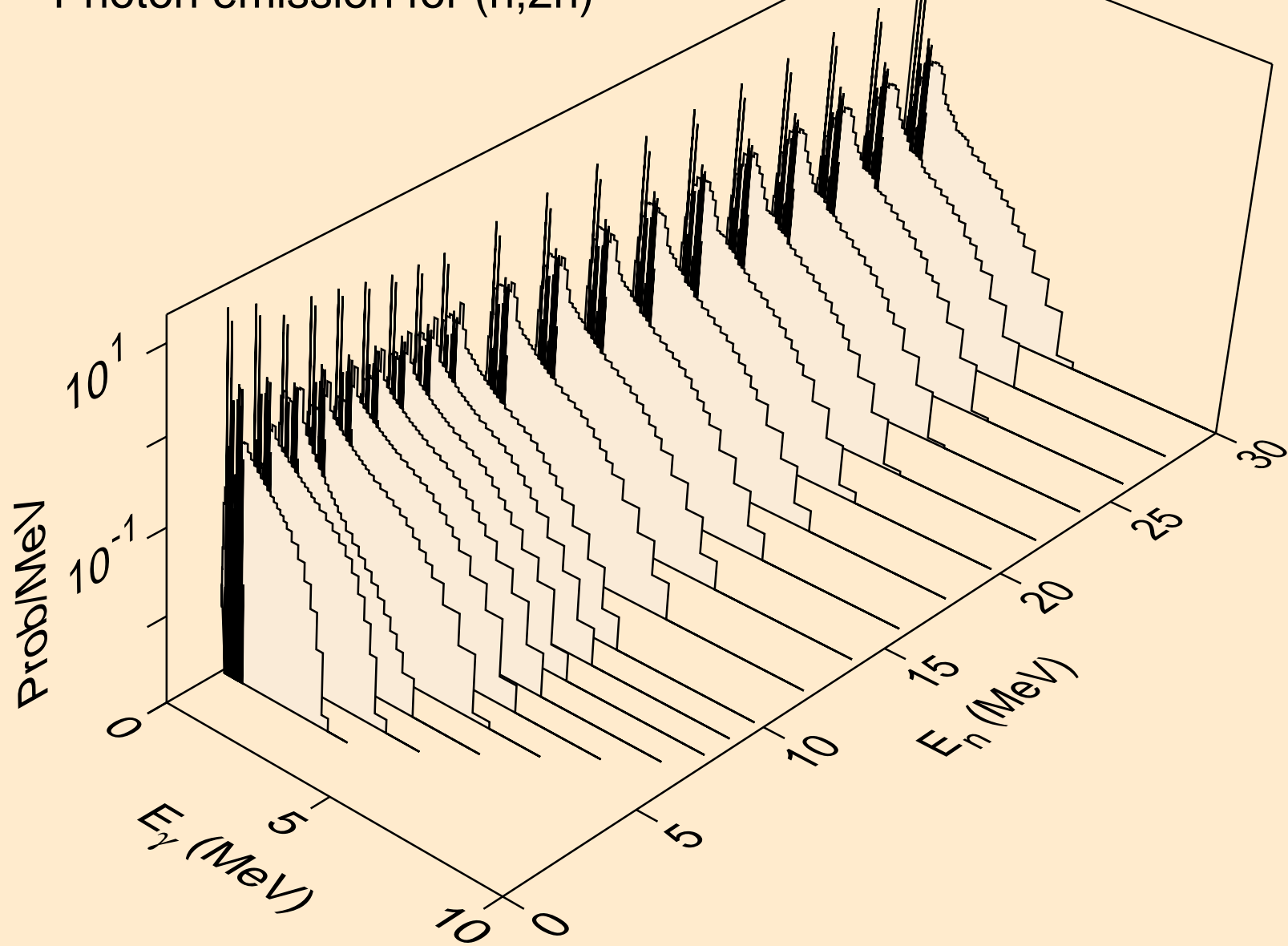

KR089 TRITON ACER TENDL-2021 LIBRARY; T=0.K  
Photon emission for (n,3n)

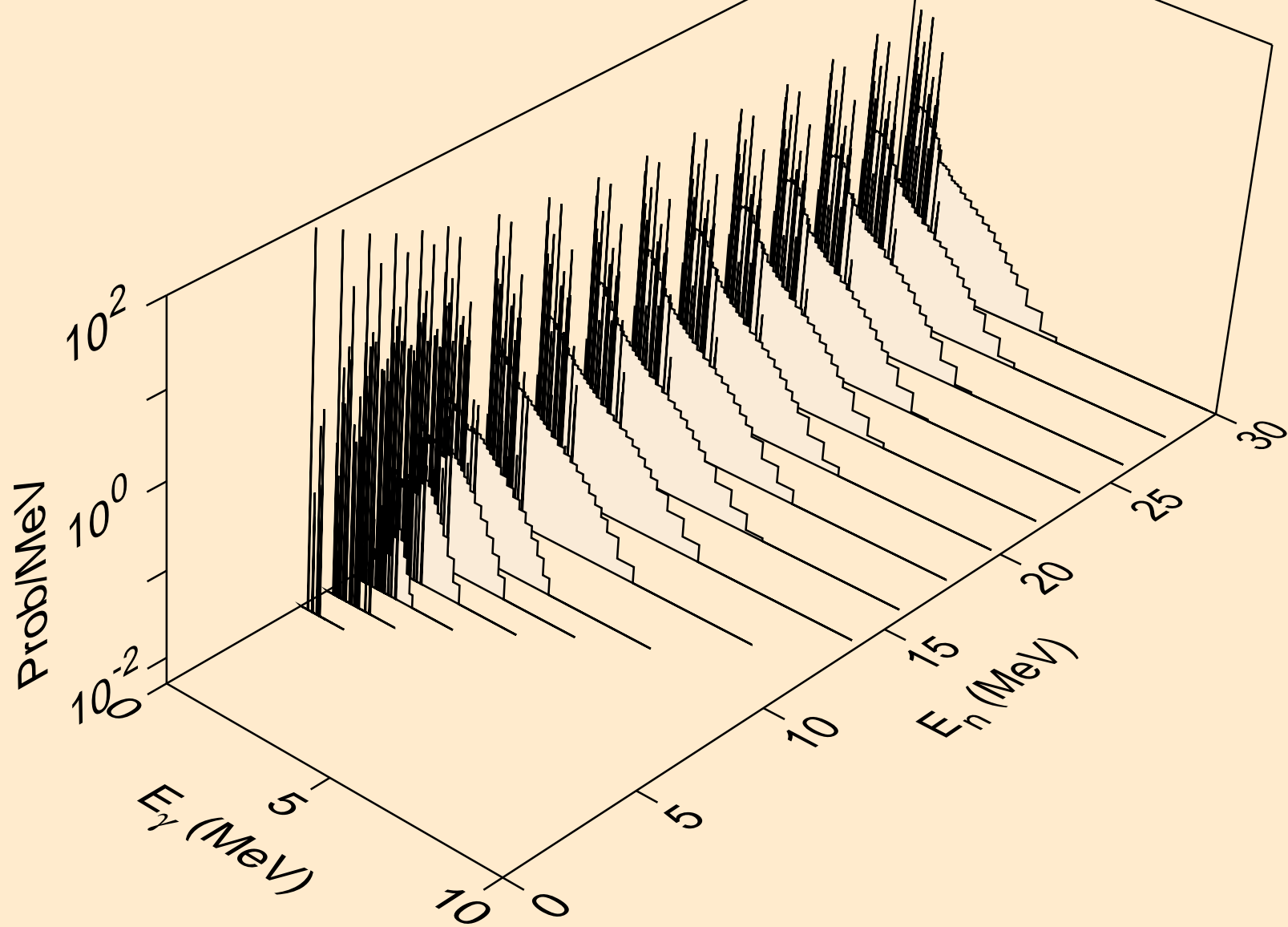

KR089 TRITON ACER TENDL-2021 LIBRARY; T=0.K  
Photon emission for (n,n\*)a

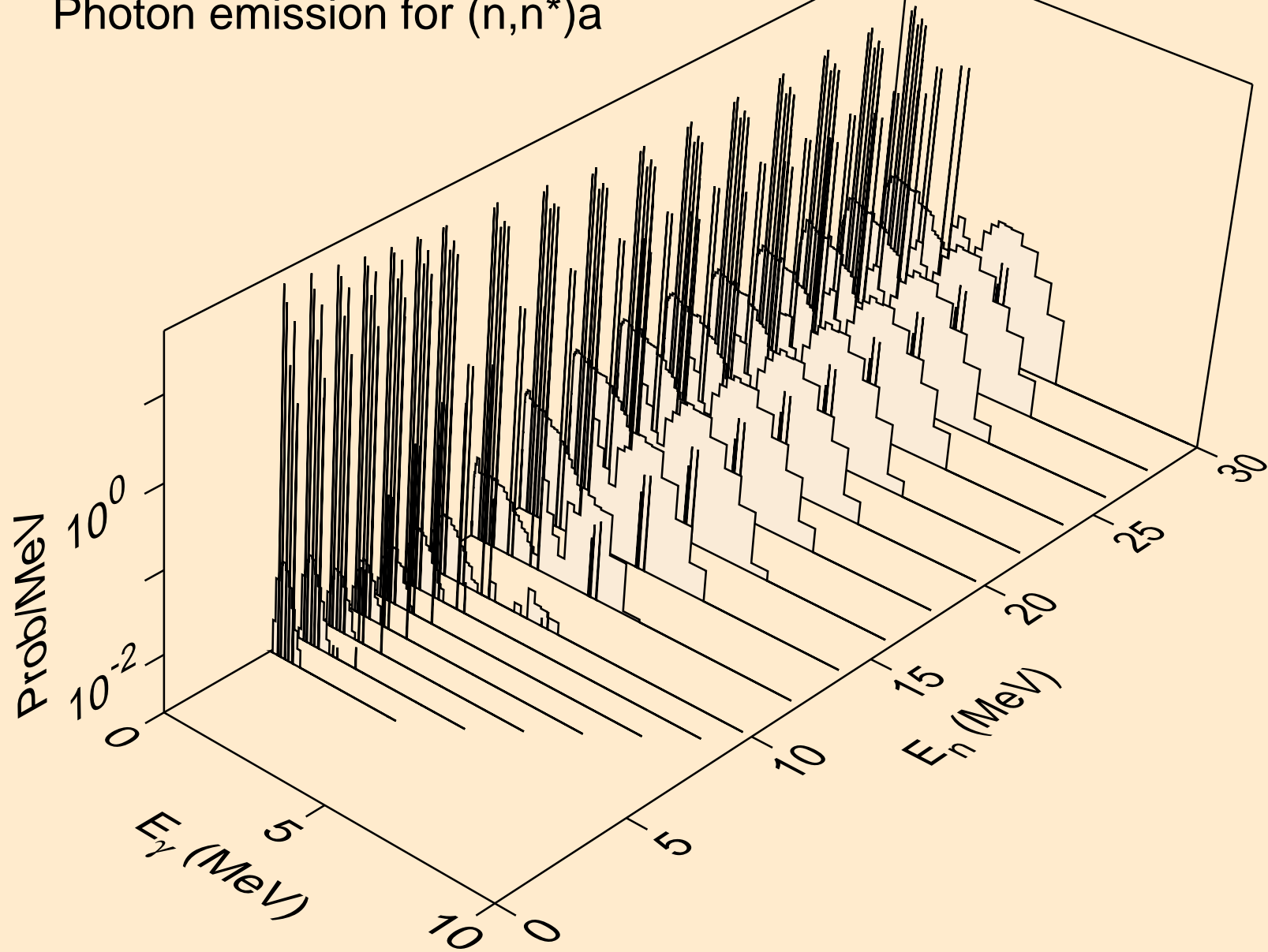

KR089 TRITON ACER TENDL-2021 LIBRARY; T=0.K  
Photon emission for (n,2n)a

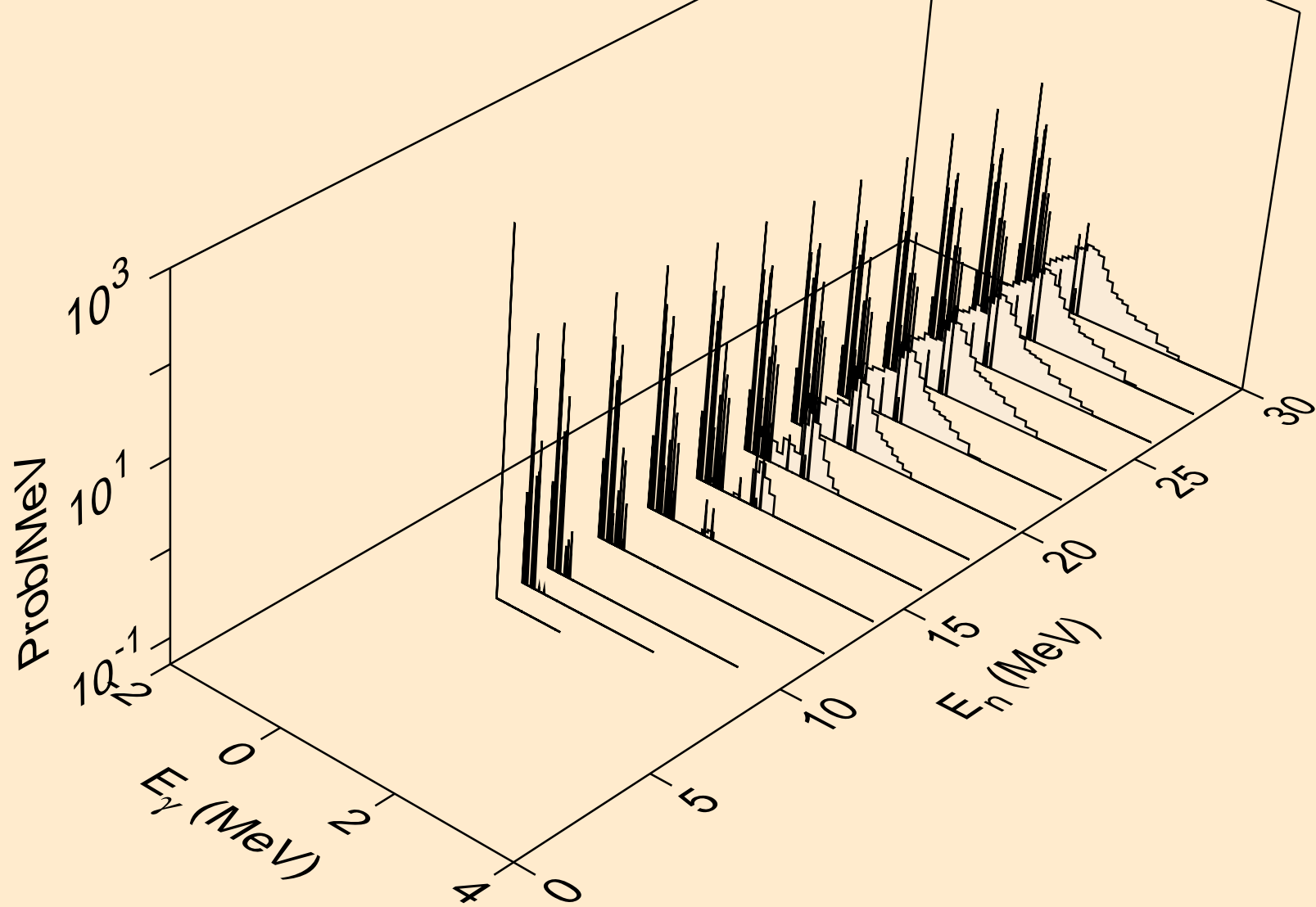

KR089 TRITON ACER TENDL-2021 LIBRARY; T=0.K  
Photon emission for (n,3n)a

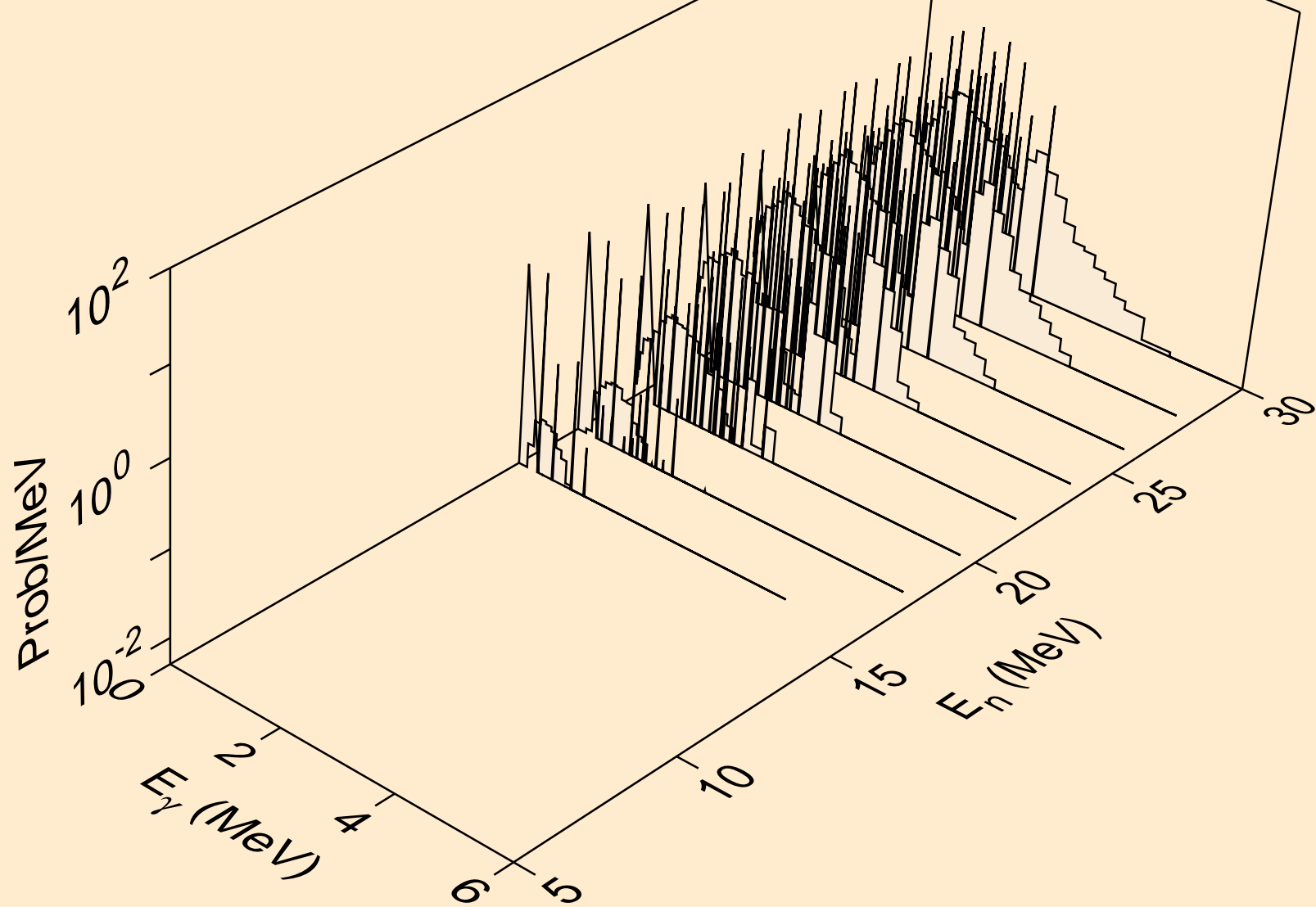

KR089 TRITON ACER TENDL-2021 LIBRARY; T=0.K  
Photon emission for (n,n\*)p

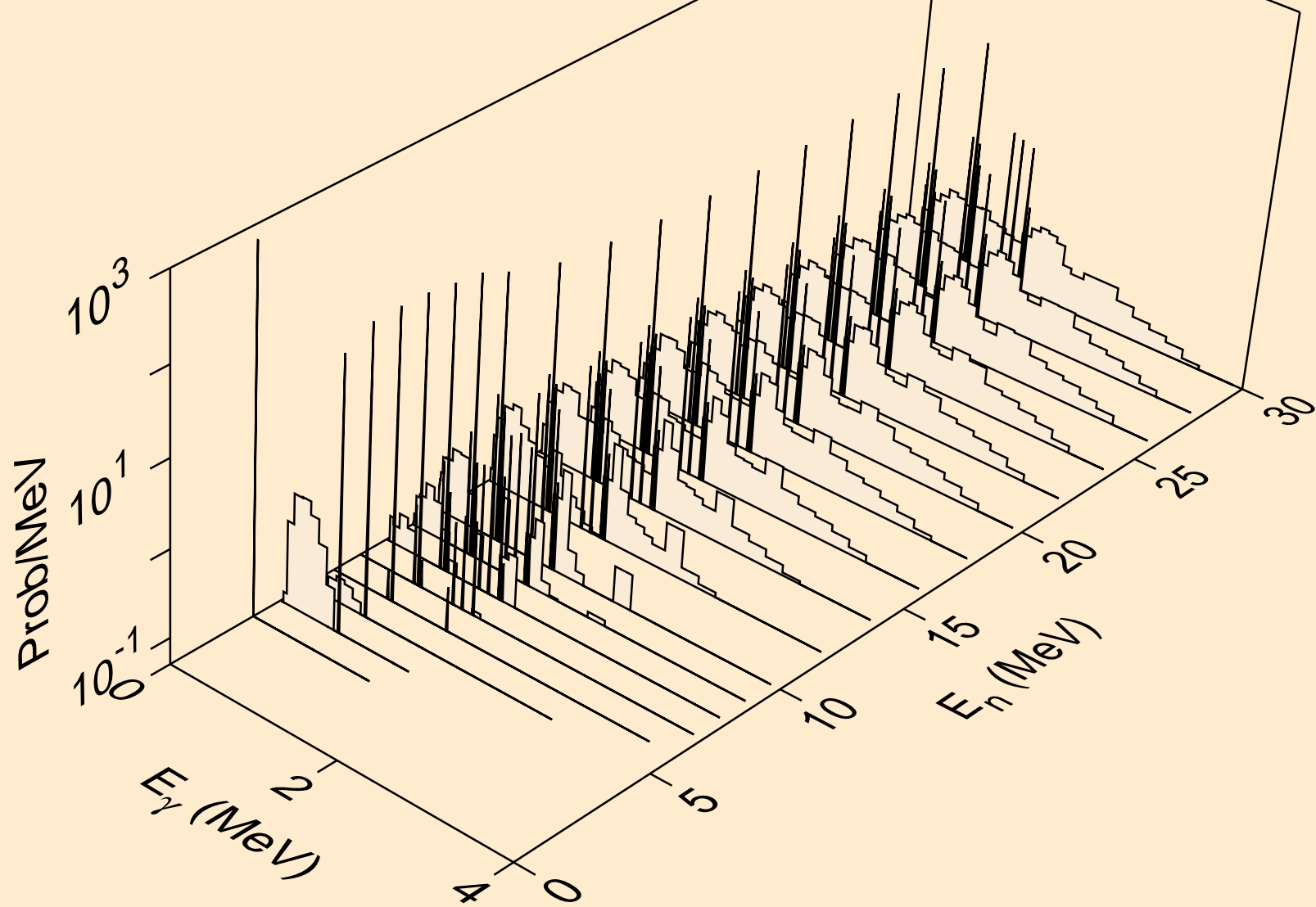

KR089 TRITON ACER TENDL-2021 LIBRARY; T=0.K  
Photon emission for (n,n\*)2a

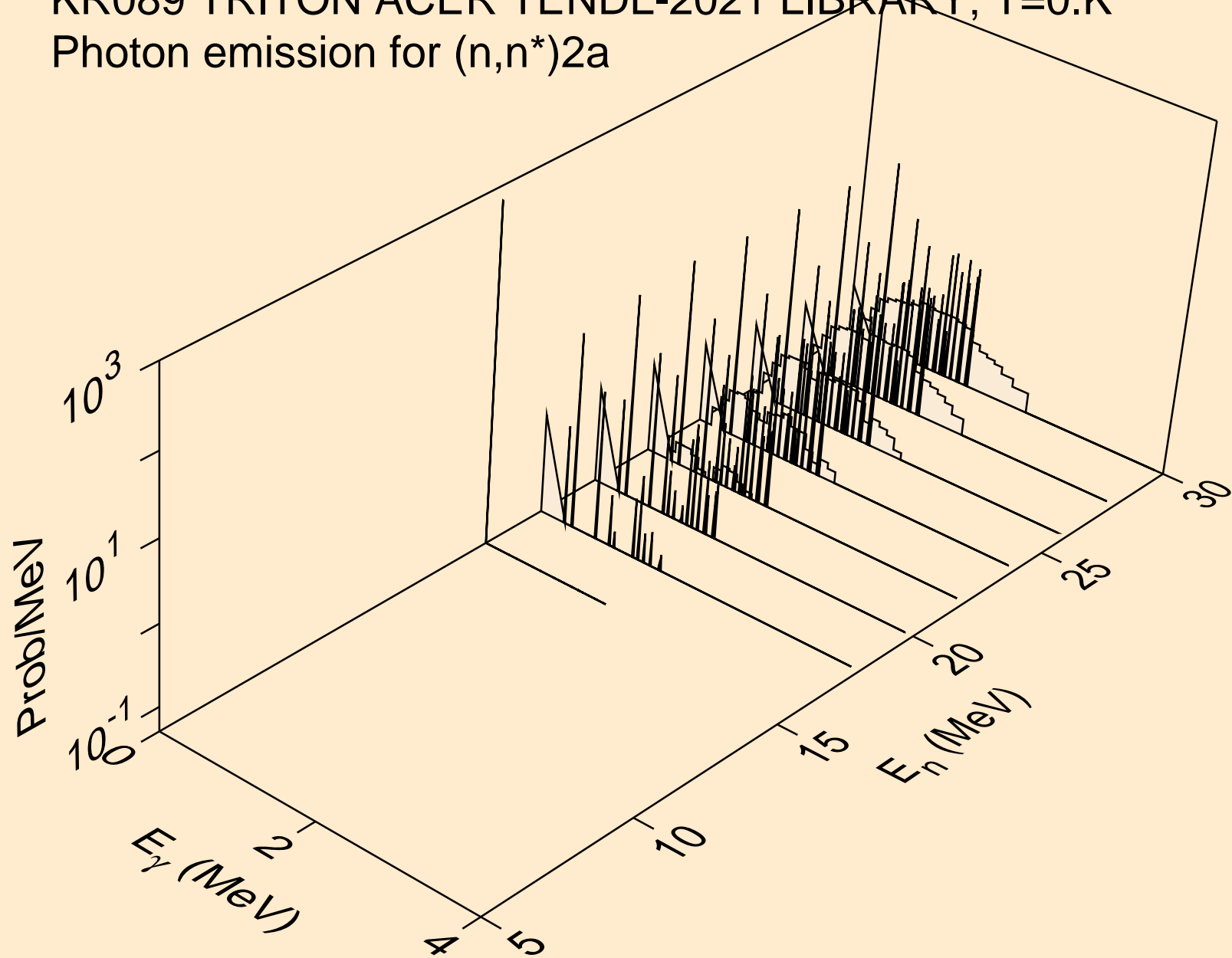

KR089 TRITON ACER TENDL-2021 LIBRARY; T=0.K  
Photon emission for (n,n\*)d

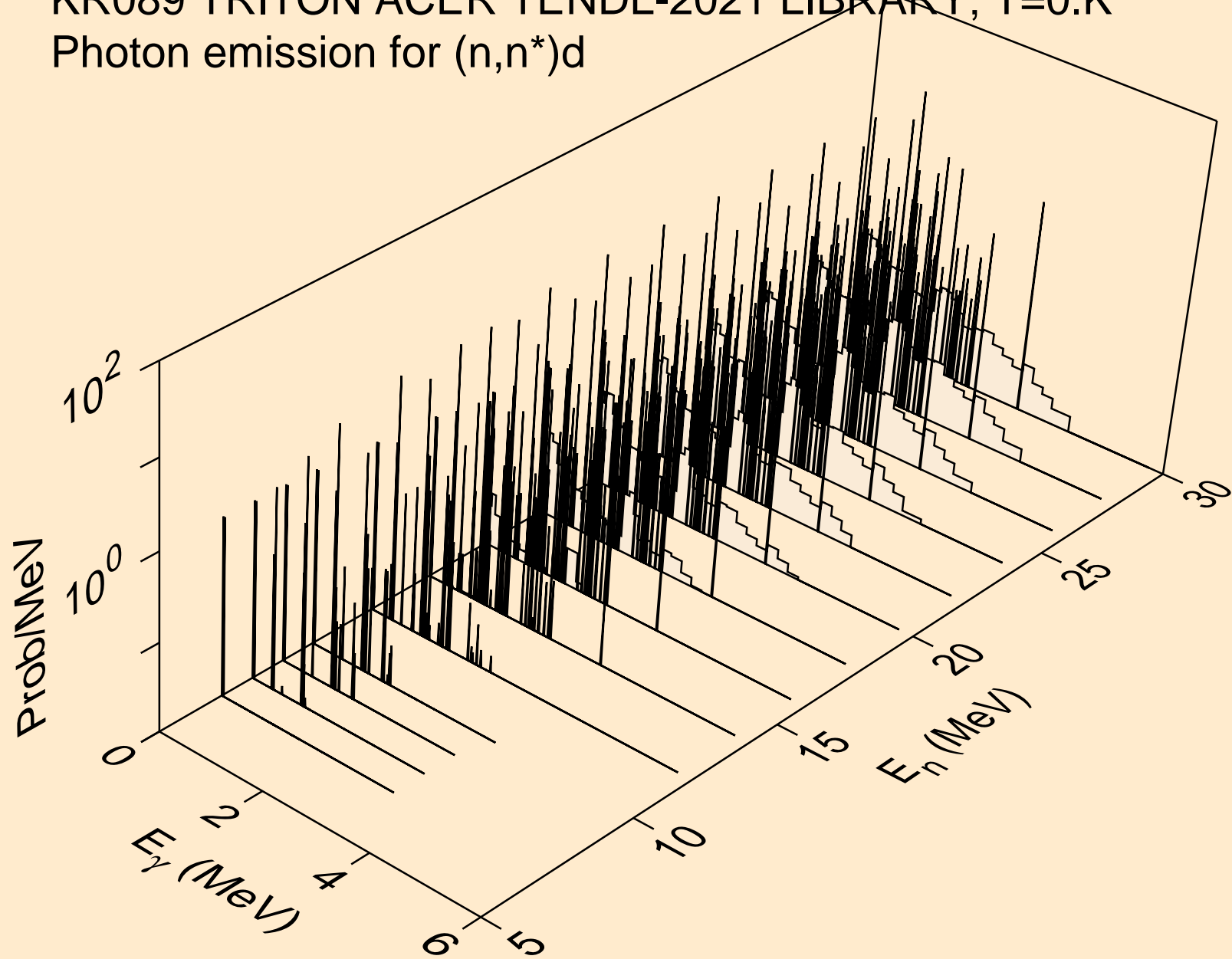



KR089 TRITON ACER TENDL-2021 LIBRARY; T=0.K  
Photon emission for (n,n\*)t

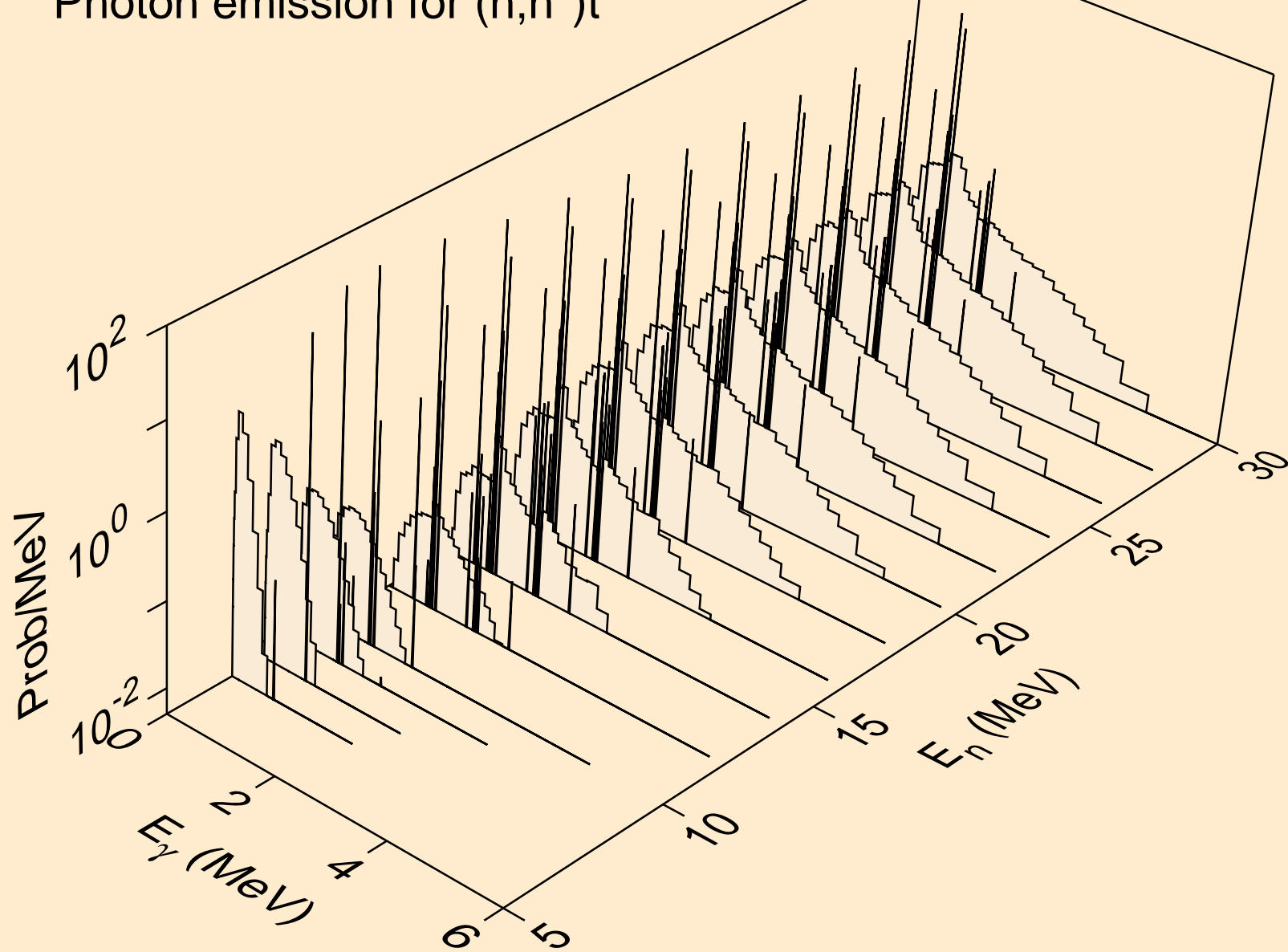

KR089 TRITON ACER TENDL-2021 LIBRARY; T=0.K  
Photon emission for (n,n\*)he3

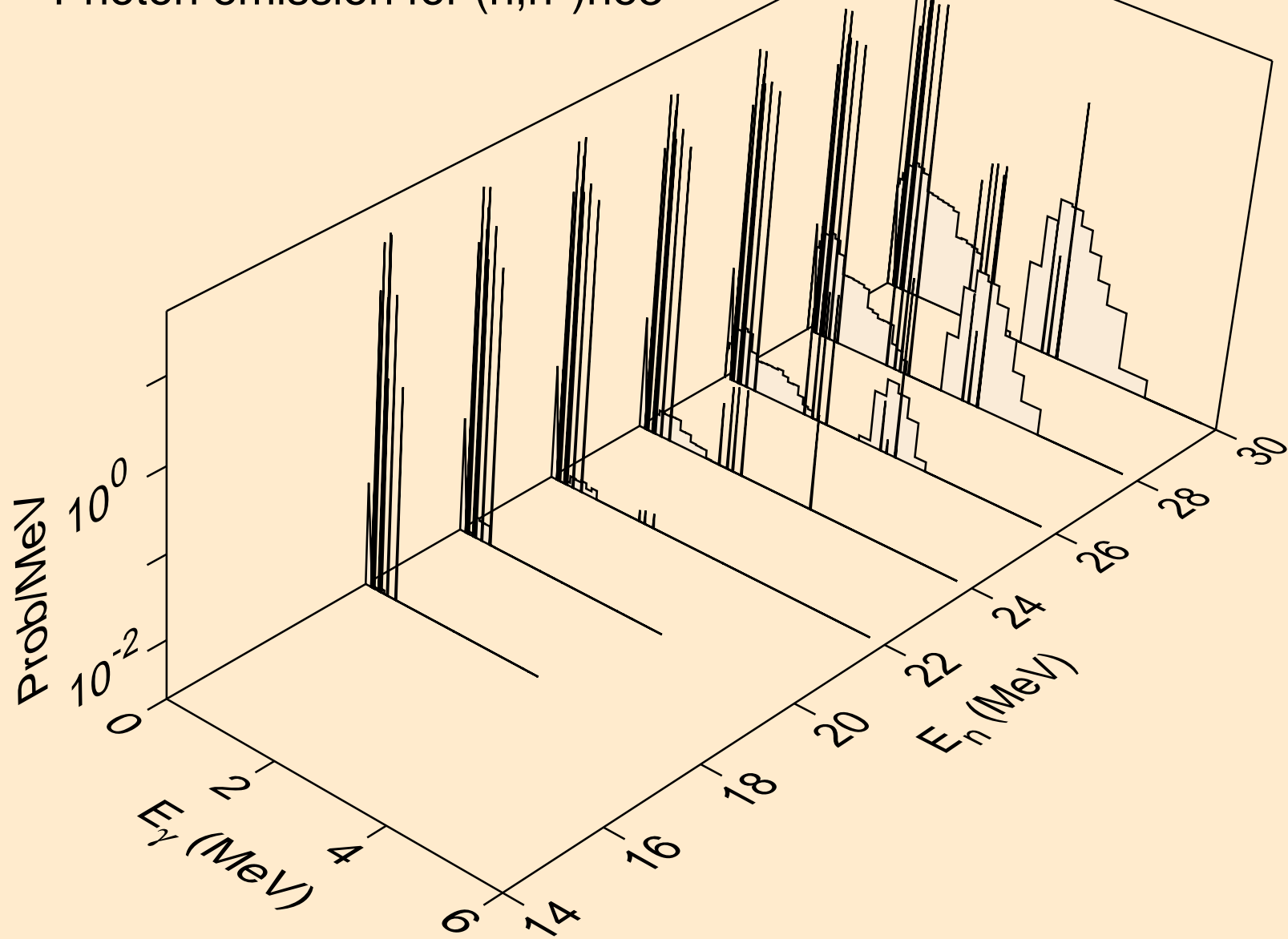

KR089 TRITON ACER TENDL-2021 LIBRARY; T=0.K  
Photon emission for (n,4n)

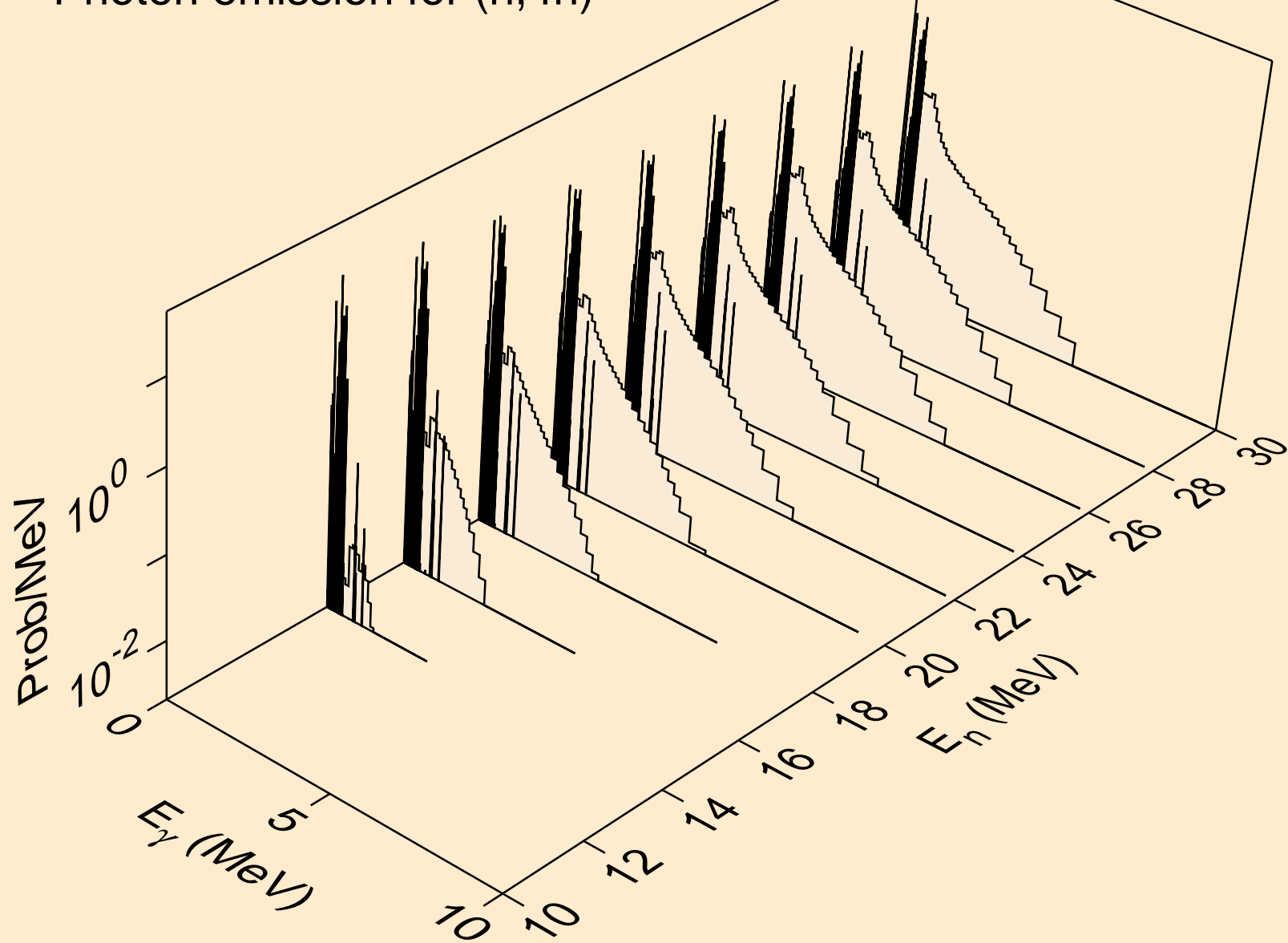

KR089 TRITON ACER TENDL-2021 LIBRARY; T=0.K  
Photon emission for (n,2np)

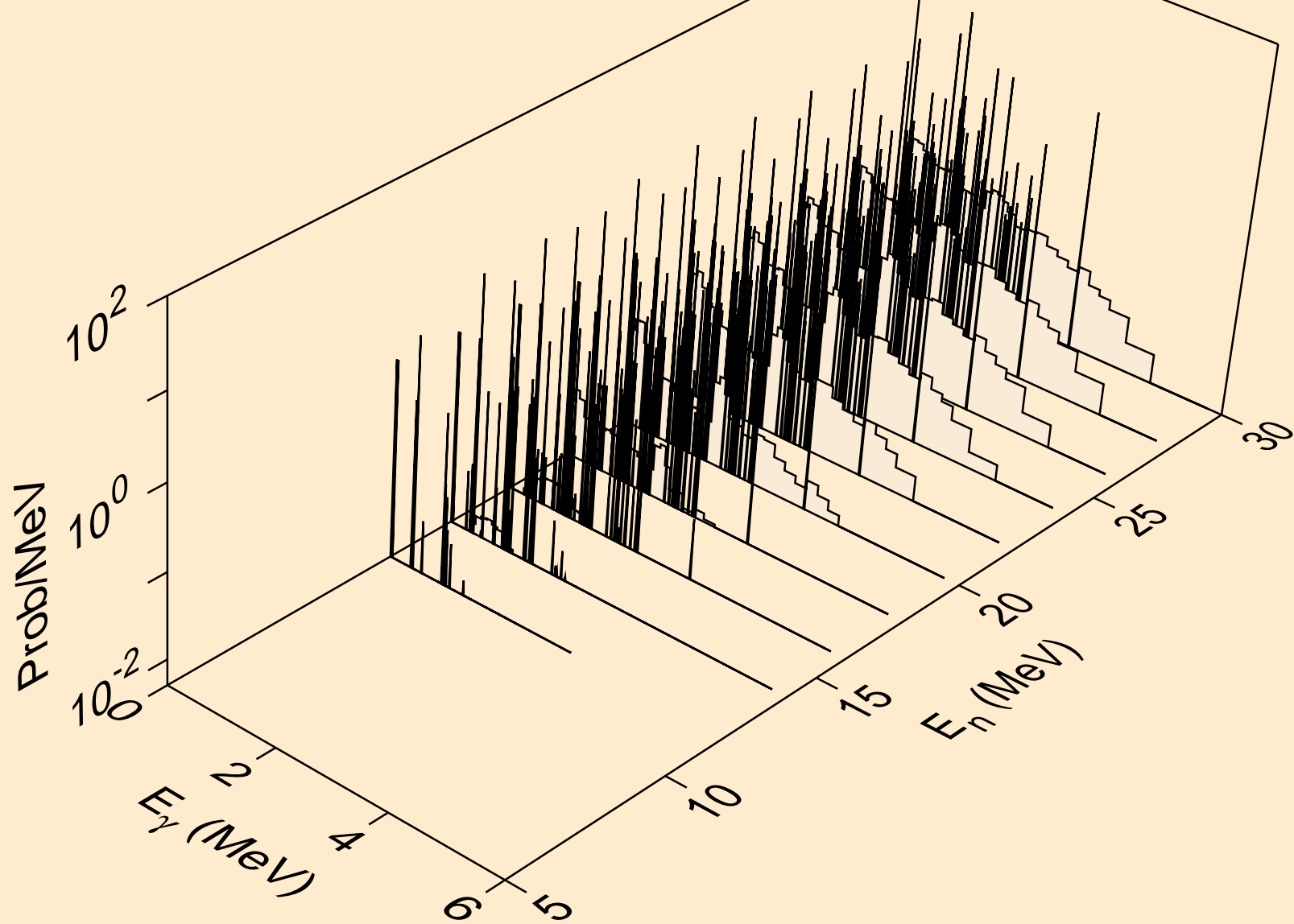

KR089 TRITON ACER TENDL-2021 LIBRARY; T=0.K  
Photon emission for (n,3np)

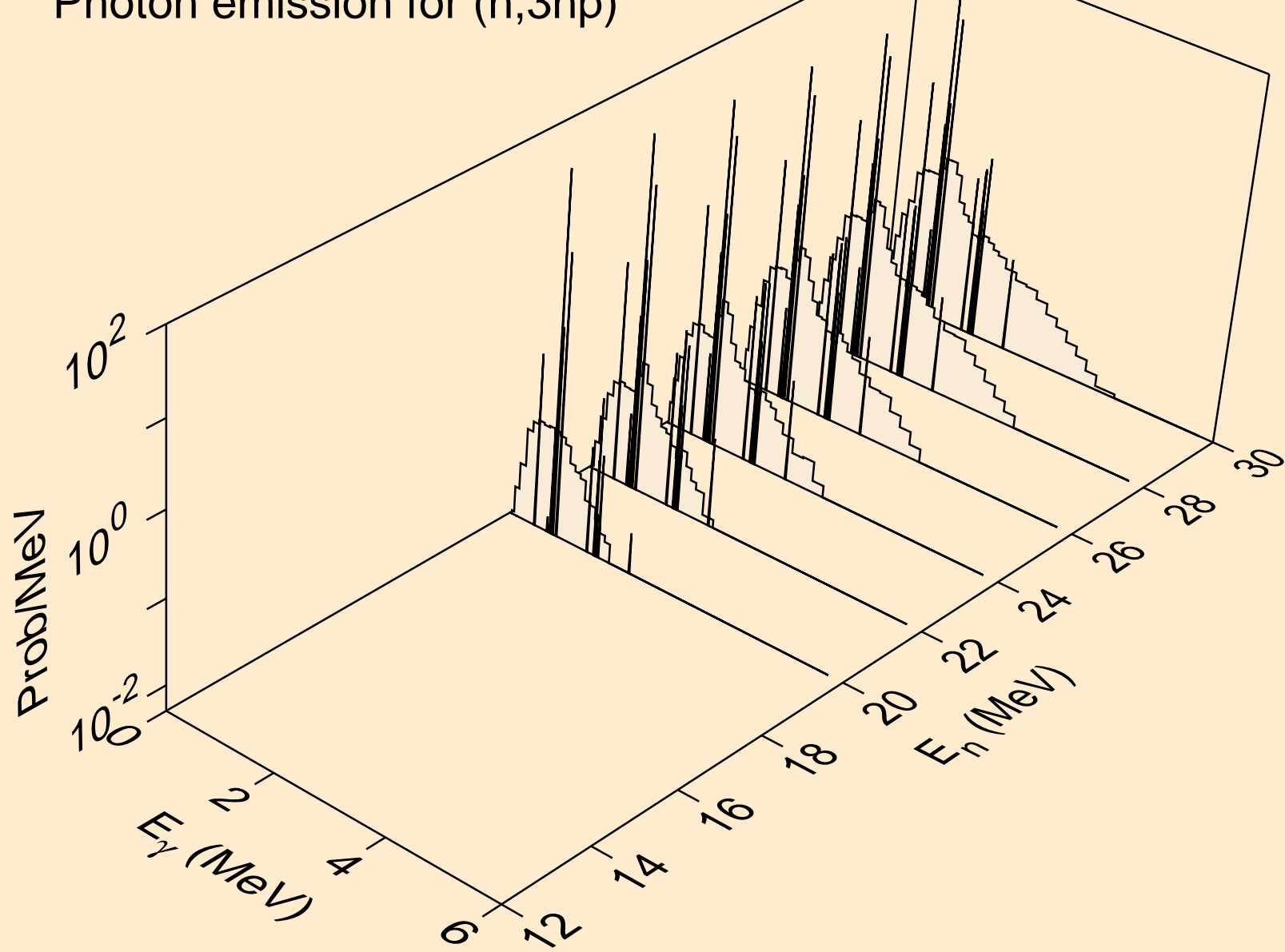

KR089 TRITON ACER TENDL-2021 LIBRARY; T=0.K  
Photon emission for (n,2np)

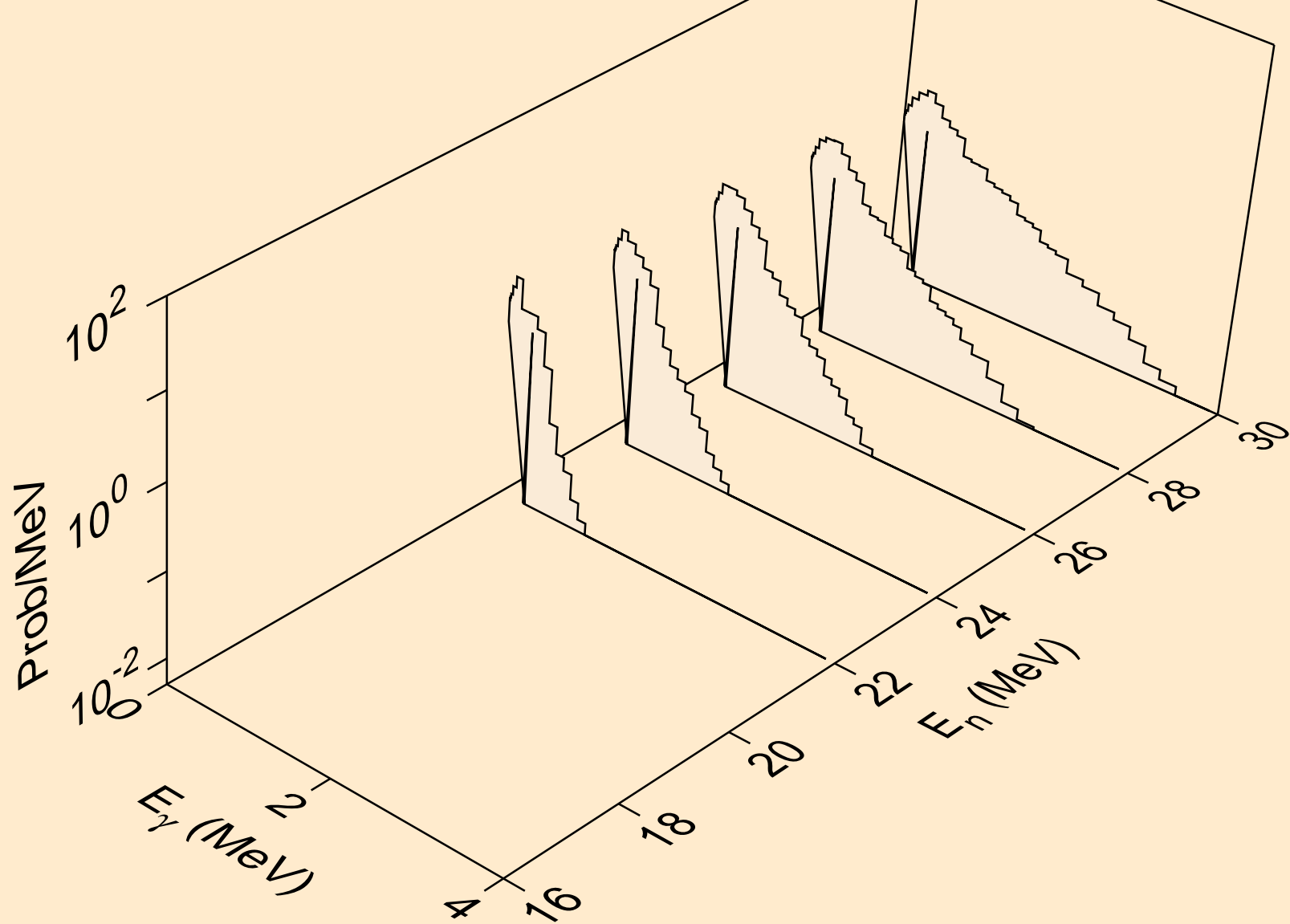

KR089 TRITON ACER TENDL-2021 LIBRARY; T=0.K  
Photon emission for (n,npa)

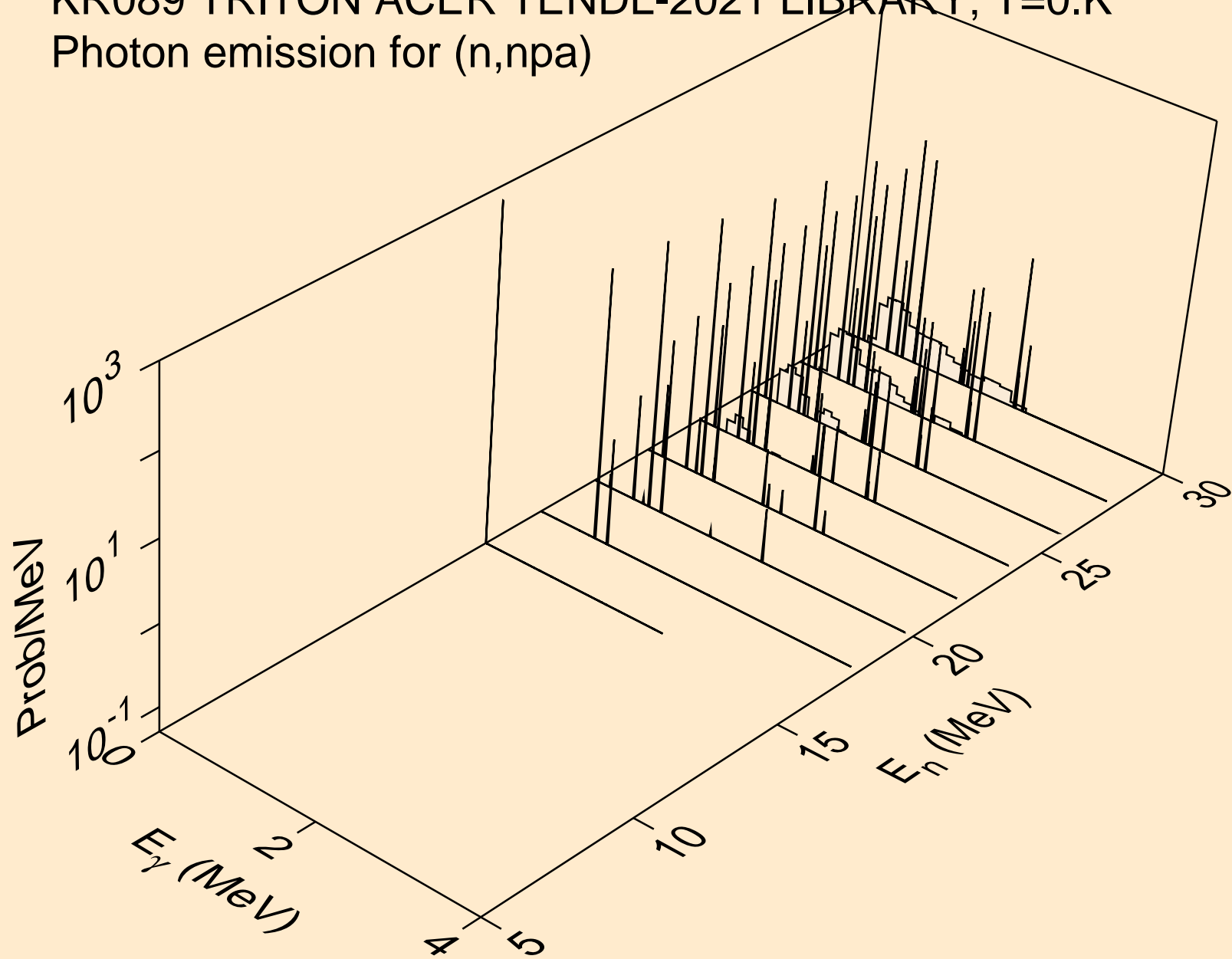

KR089 TRITON ACER TENDL-2021 LIBRARY; T=0.K  
Photon emission for (n,gma)

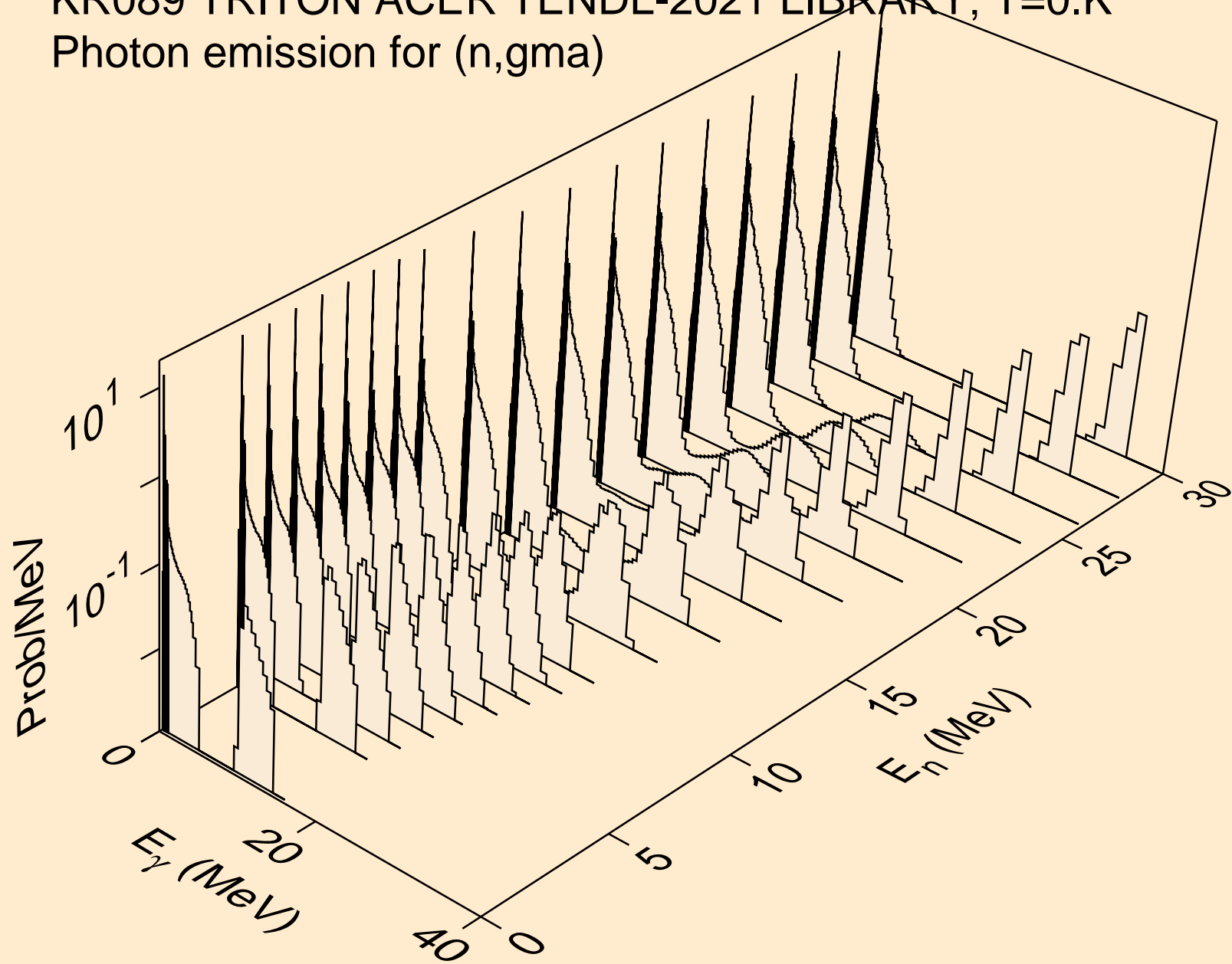



KR089 TRITON ACER TENDL-2021 LIBRARY; T=0.K  
Photon emission for (n,p)

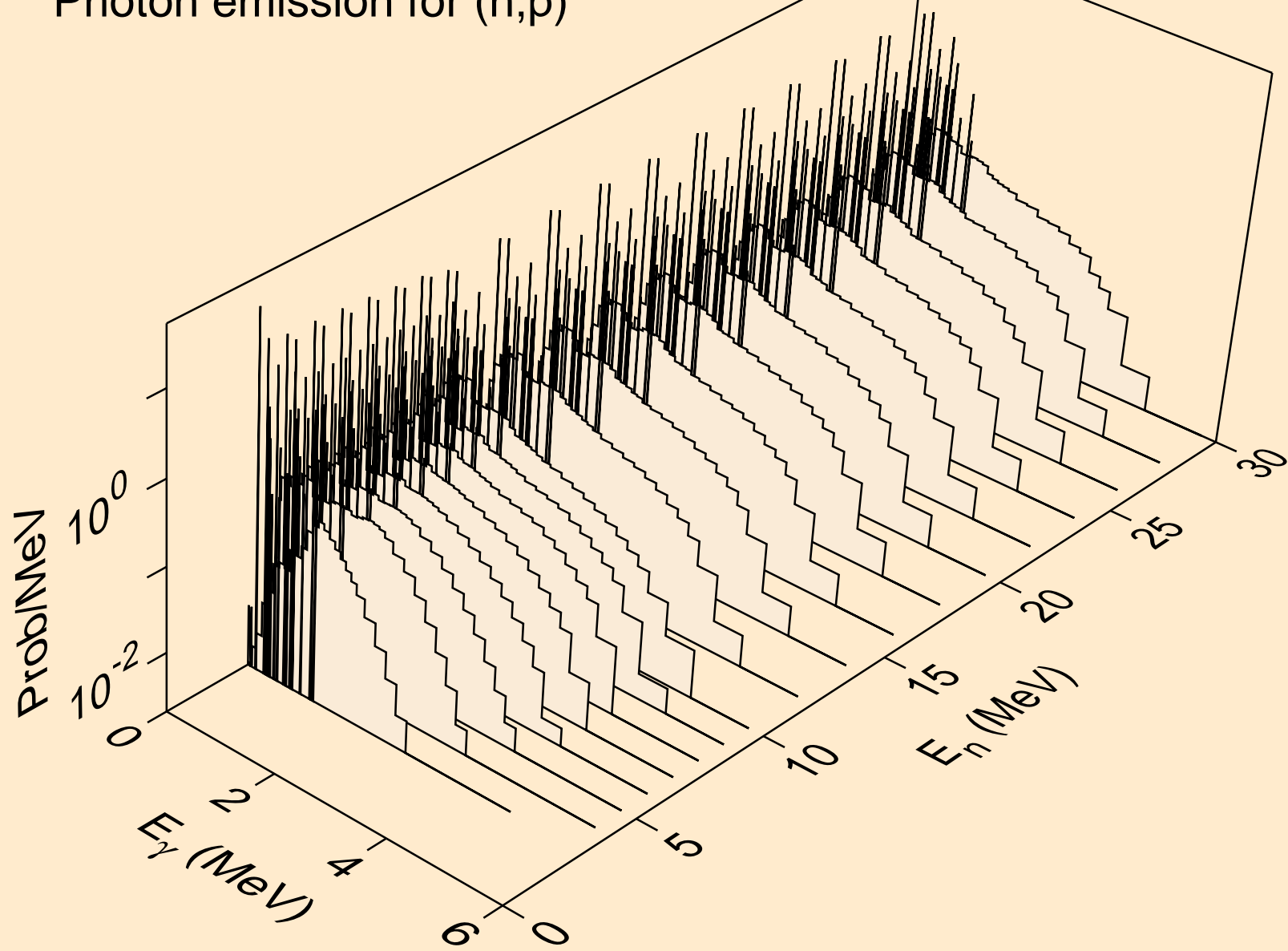

KR089 TRITON ACER TENDL-2021 LIBRARY; T=0.K  
Photon emission for (n,d)

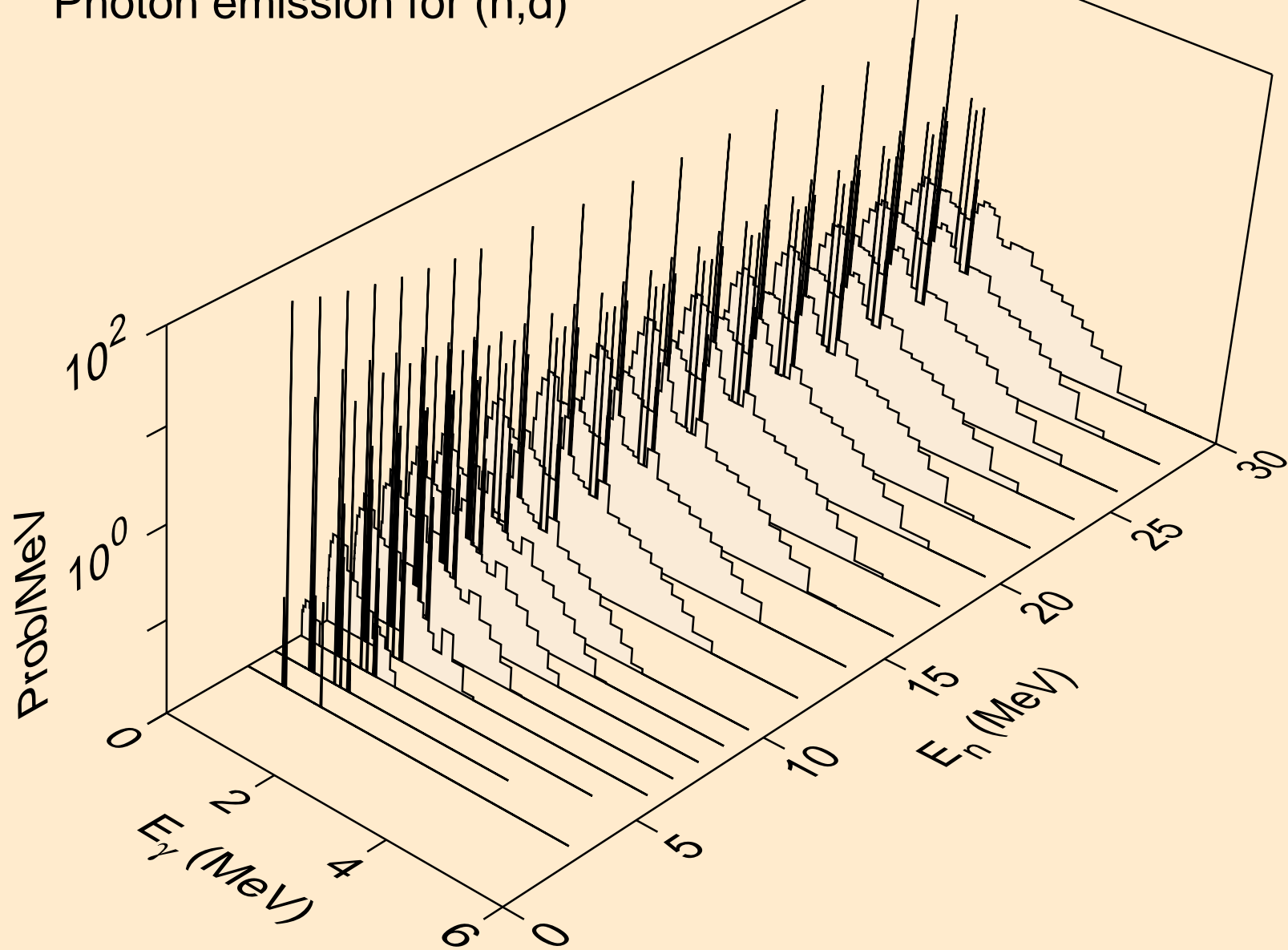

KR089 TRITON ACER TENDL-2021 LIBRARY; T=0.K  
Photon emission for inelastic

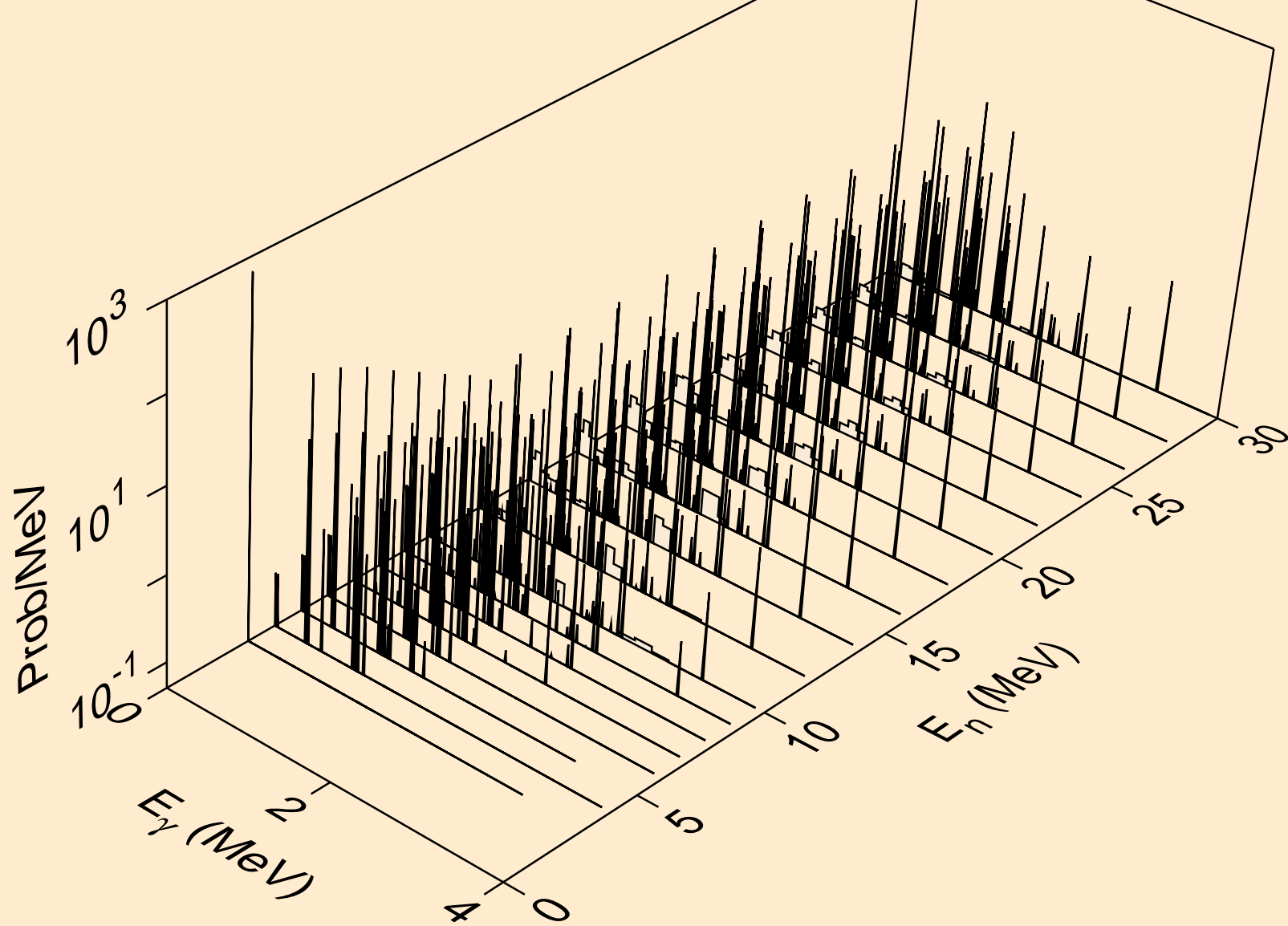

KR089 TRITON ACER TENDL-2021 LIBRARY; T=0.K  
Photon emission for (n,he3)

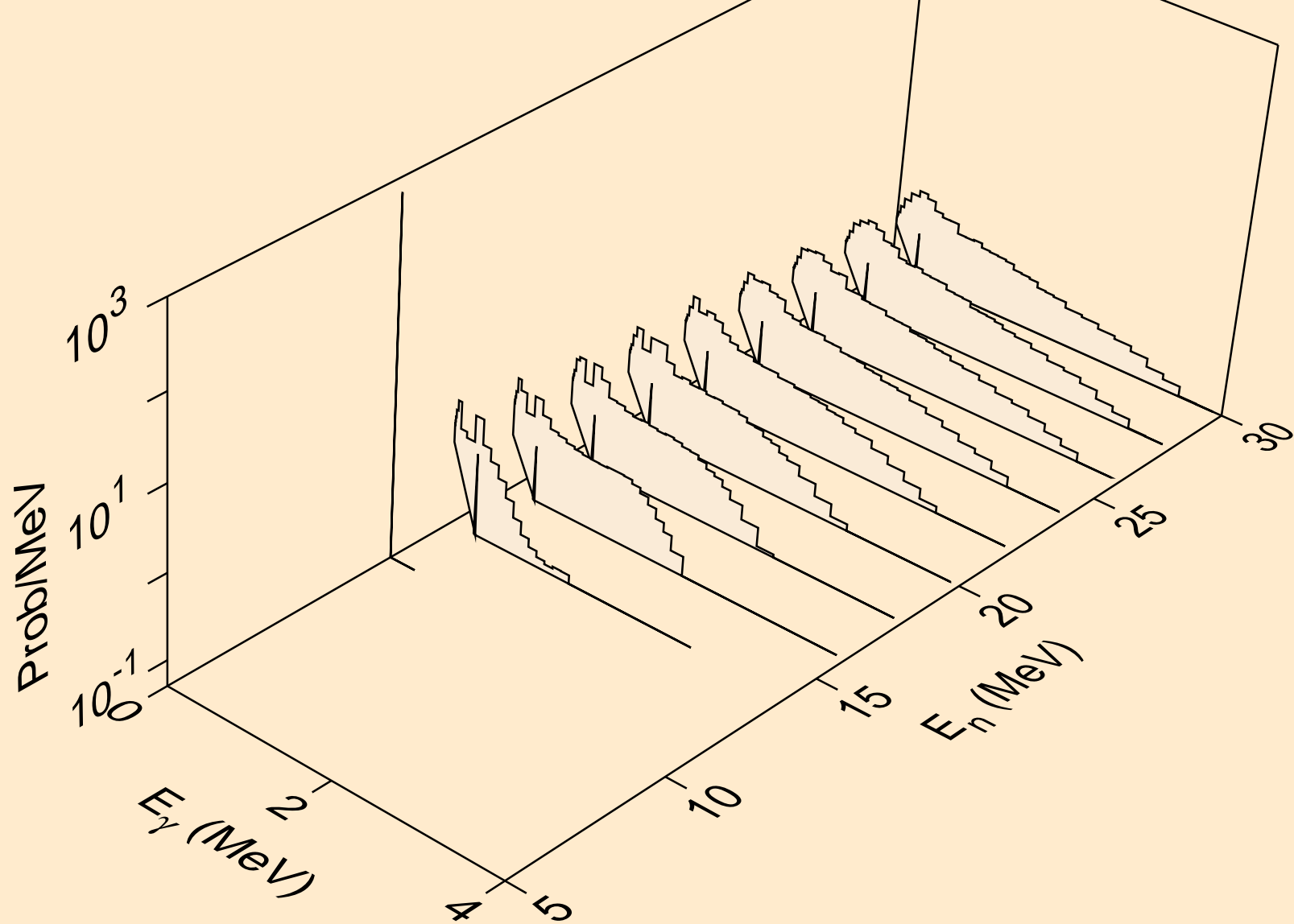

KR089 TRITON ACER TENDL-2021 LIBRARY; T=0.K  
Photon emission for (n,a)

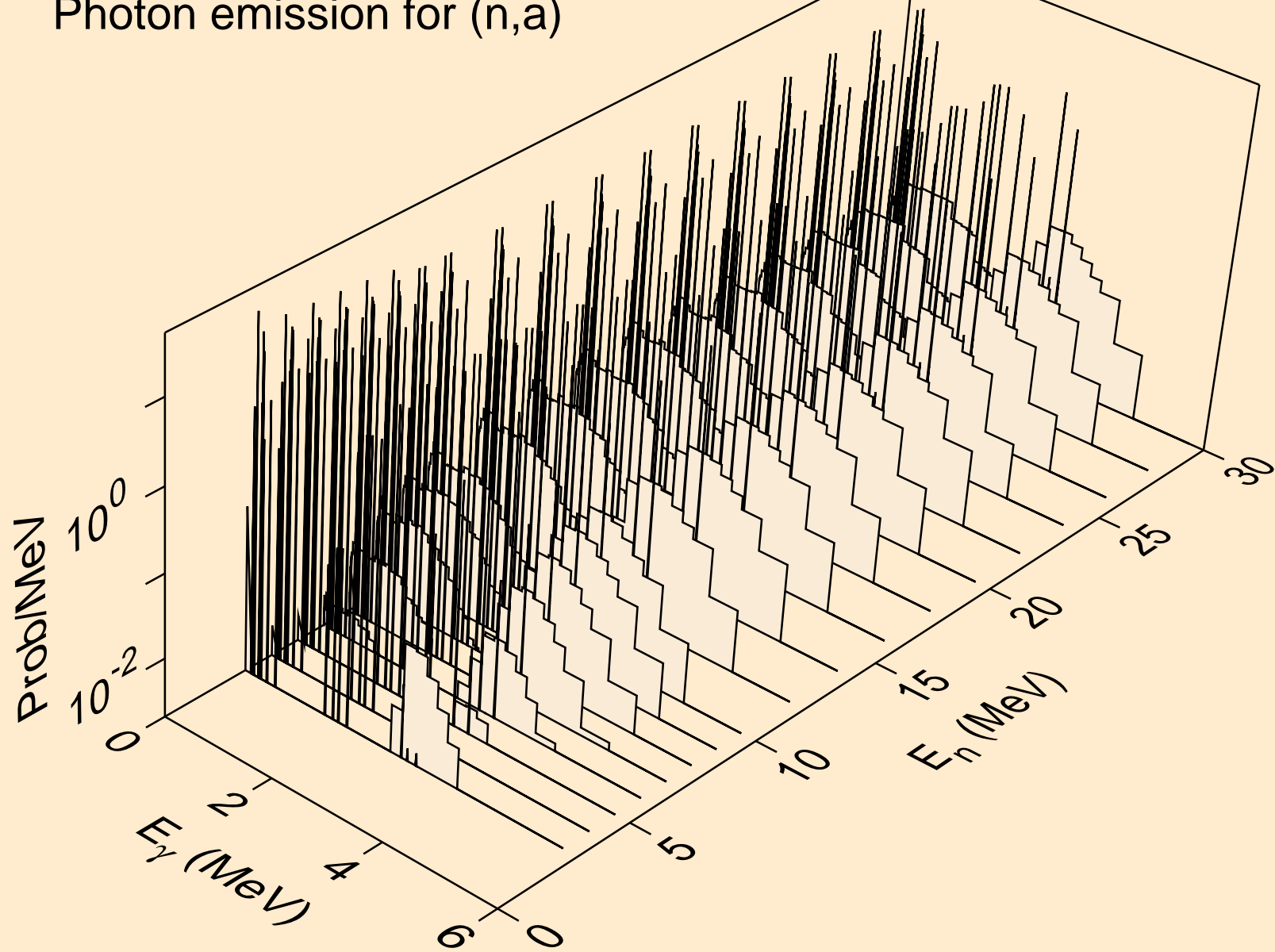

KR089 TRITON ACER TENDL-2021 LIBRARY; T=0.K  
Photon emission for (n,2a)

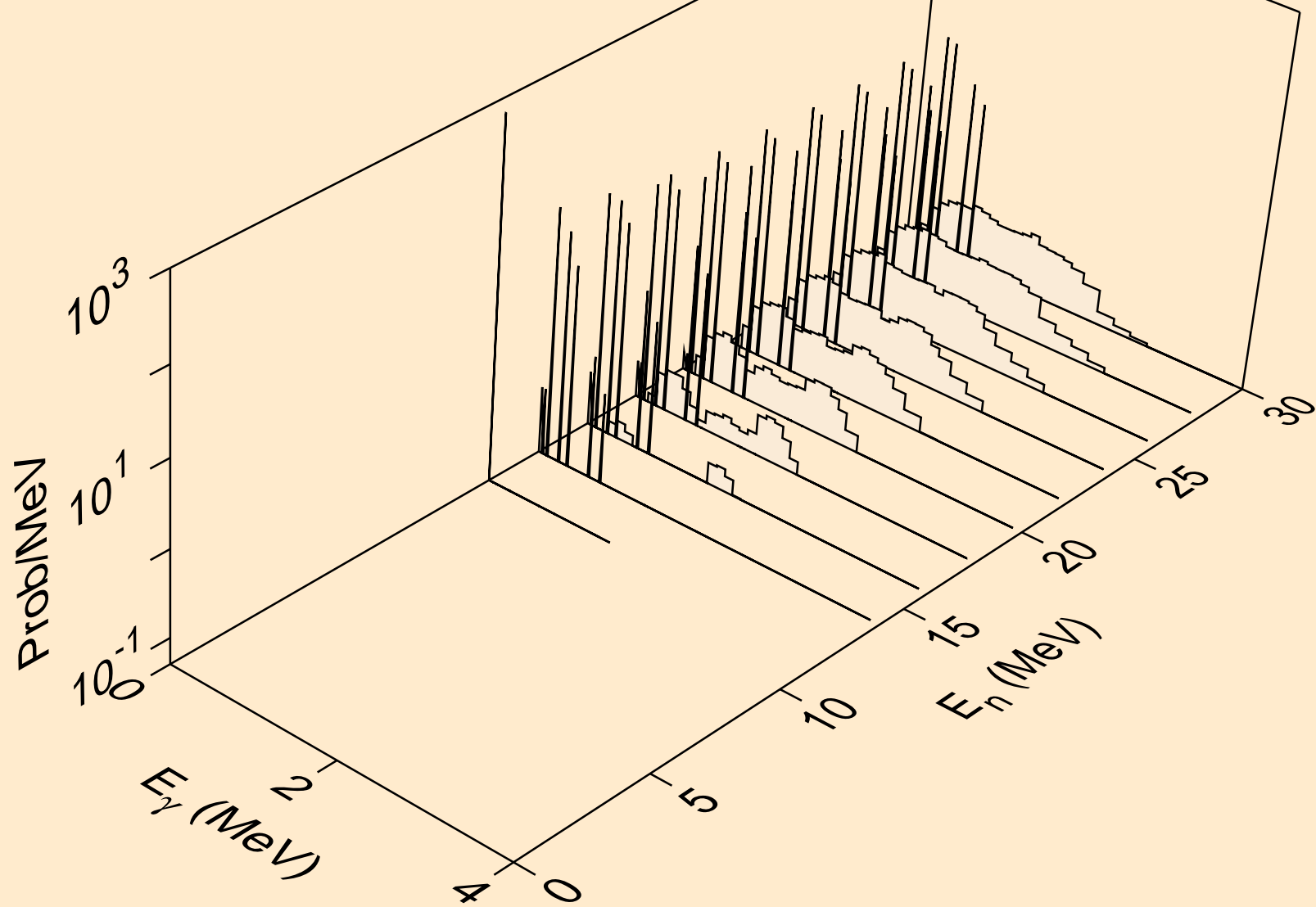

KR089 TRITON ACER TENDL-2021 LIBRARY; T=0.K  
Photon emission for (n,2p)

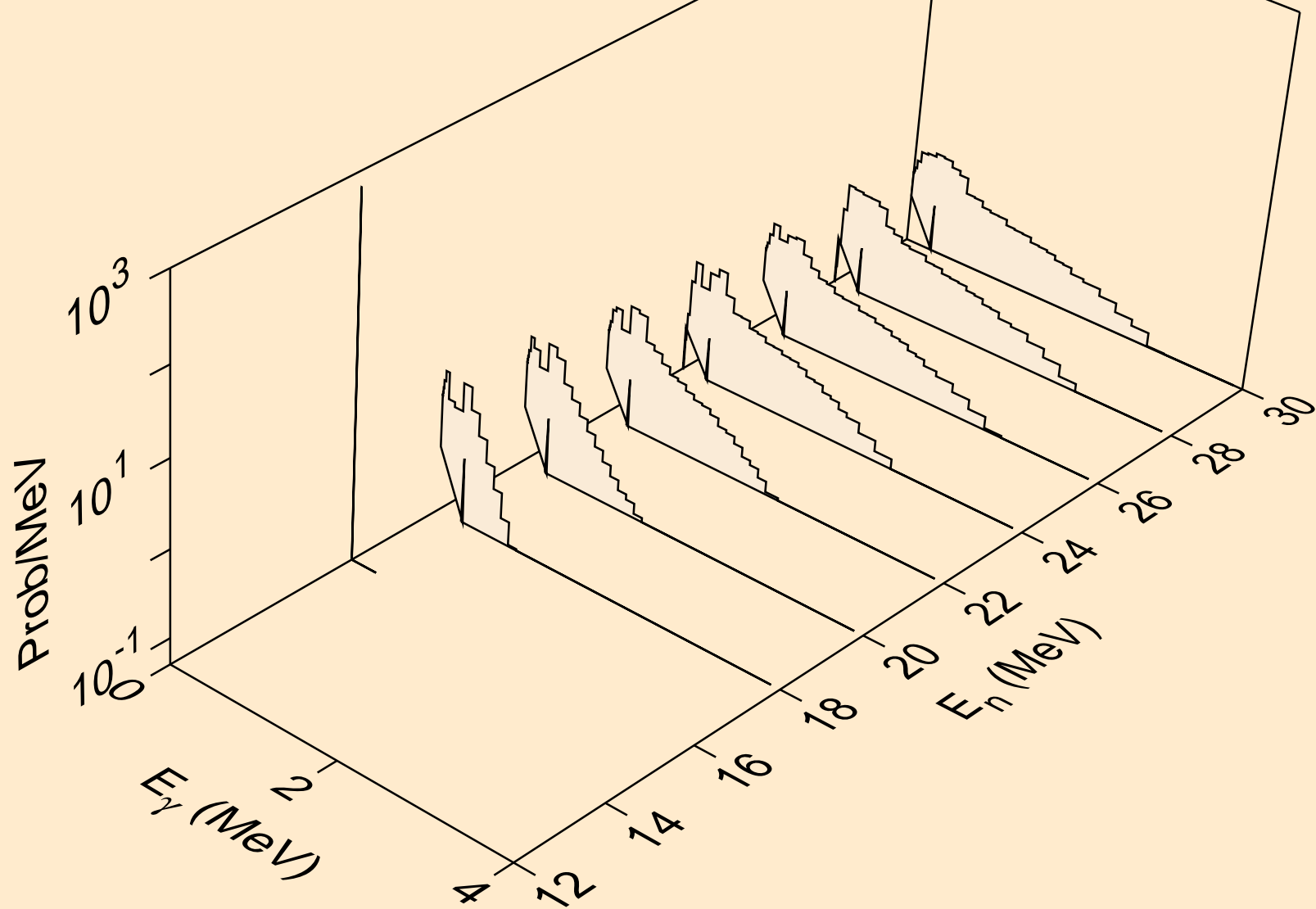

KR089 TRITON ACER TENDL-2021 LIBRARY; T=0.K  
Photon emission for (n,pa)

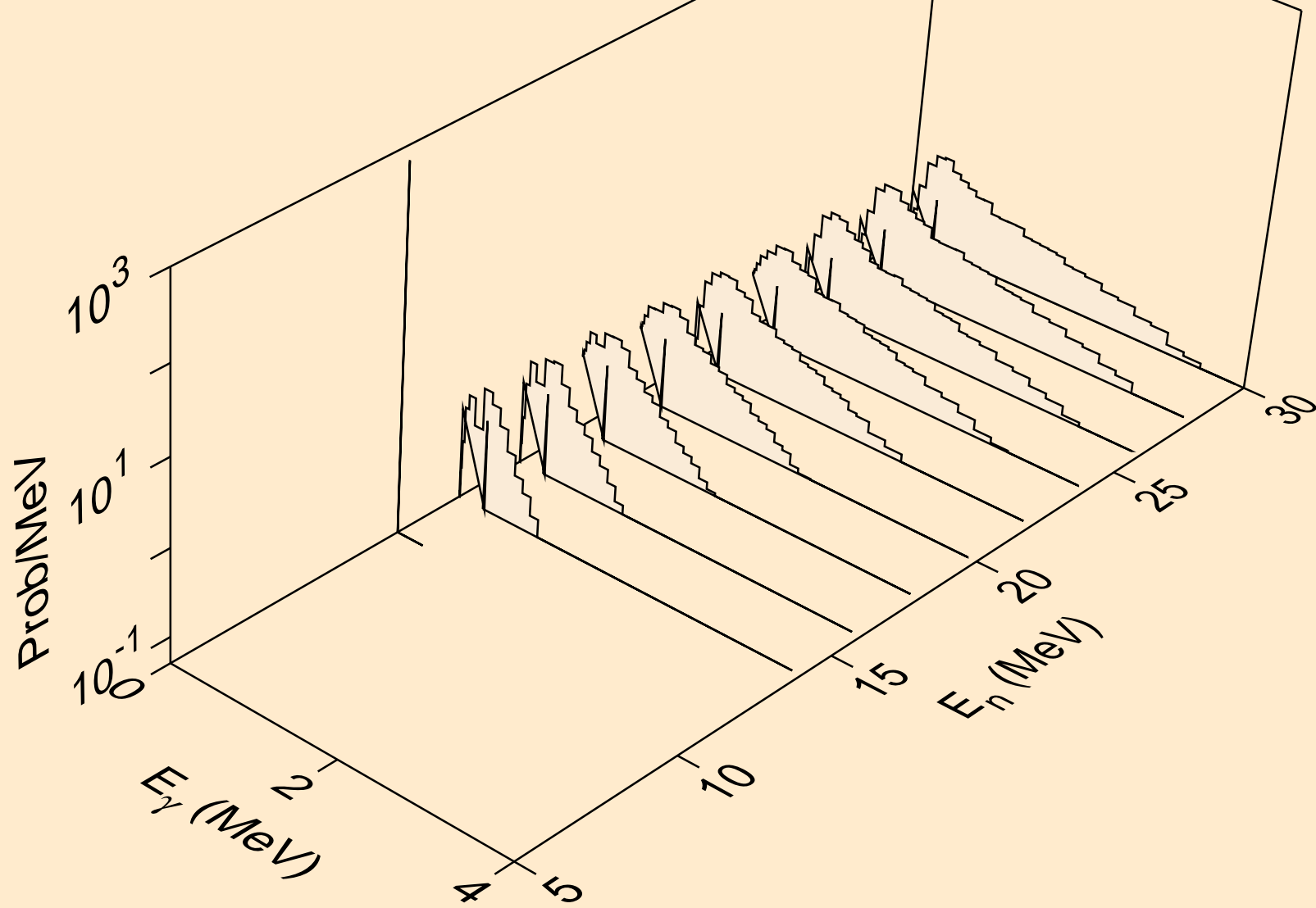



KR089 TRITON ACER TENDL-2021 LIBRARY; T=0.K  
Photon emission for (n,pd)

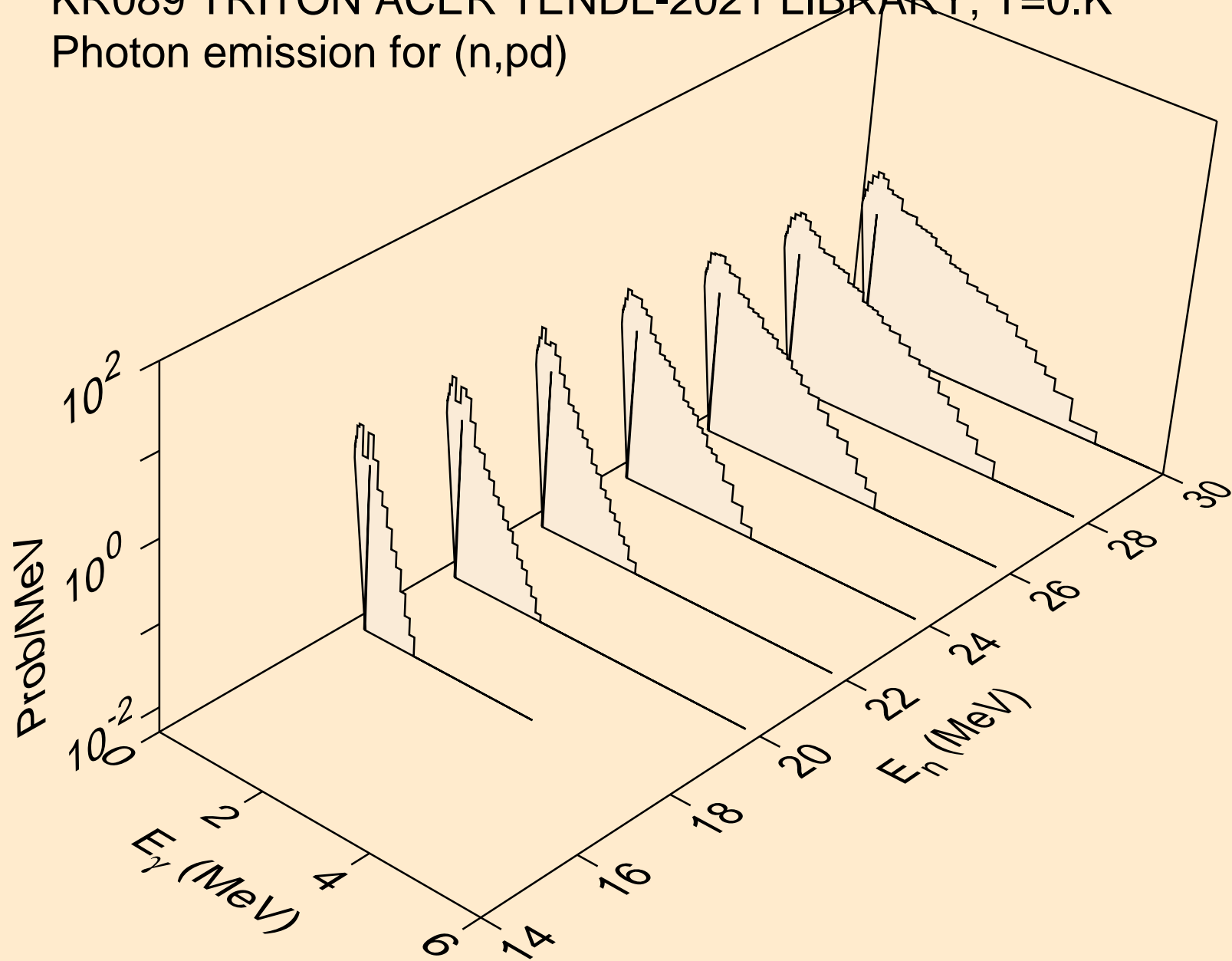

KR089 TRITON ACER TENDL-2021 LIBRARY; T=0.K  
Photon emission for (n,pt)

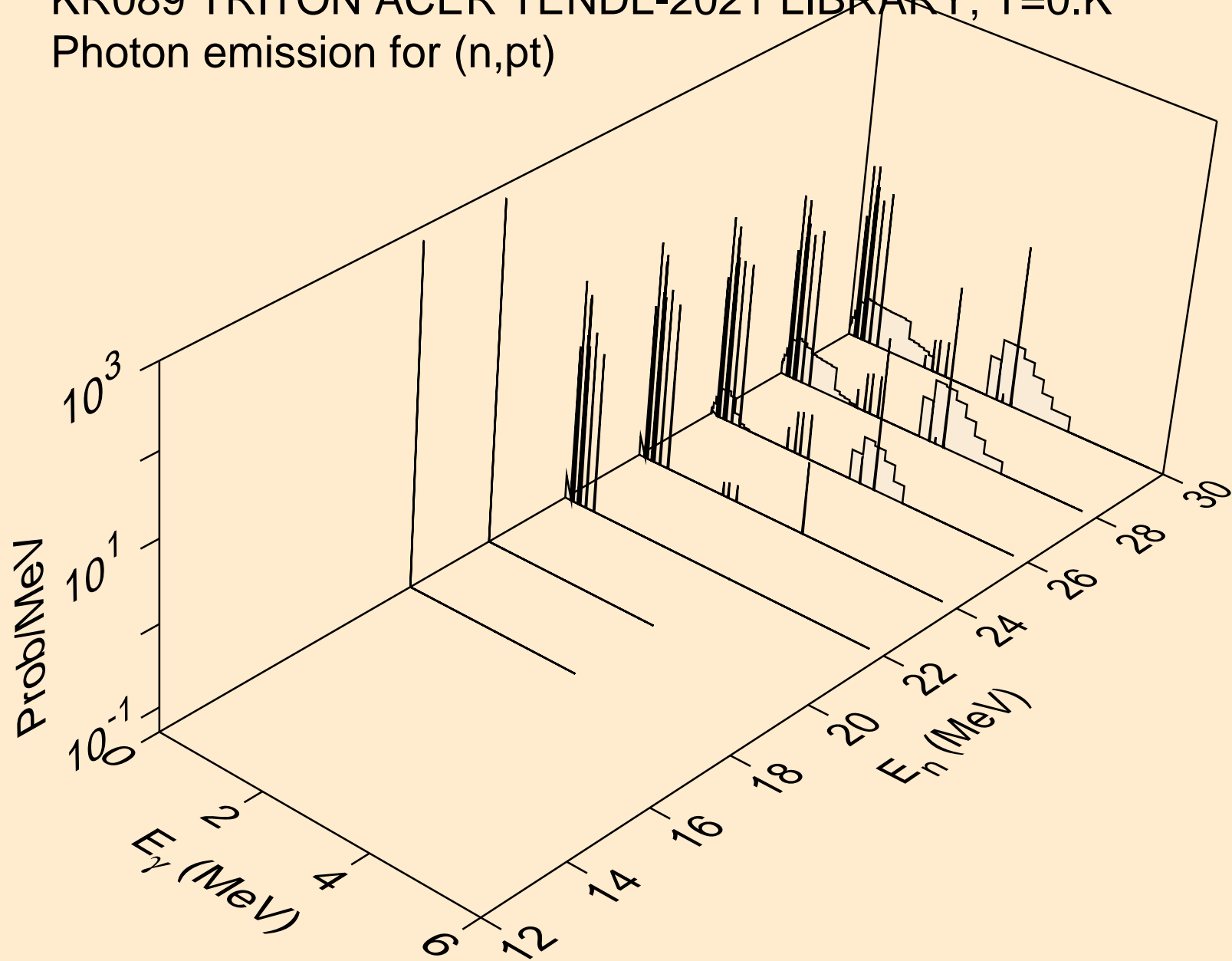

KR089 TRITON ACER TENDL-2021 LIBRARY; T=0.K  
Photon emission for (n,da)

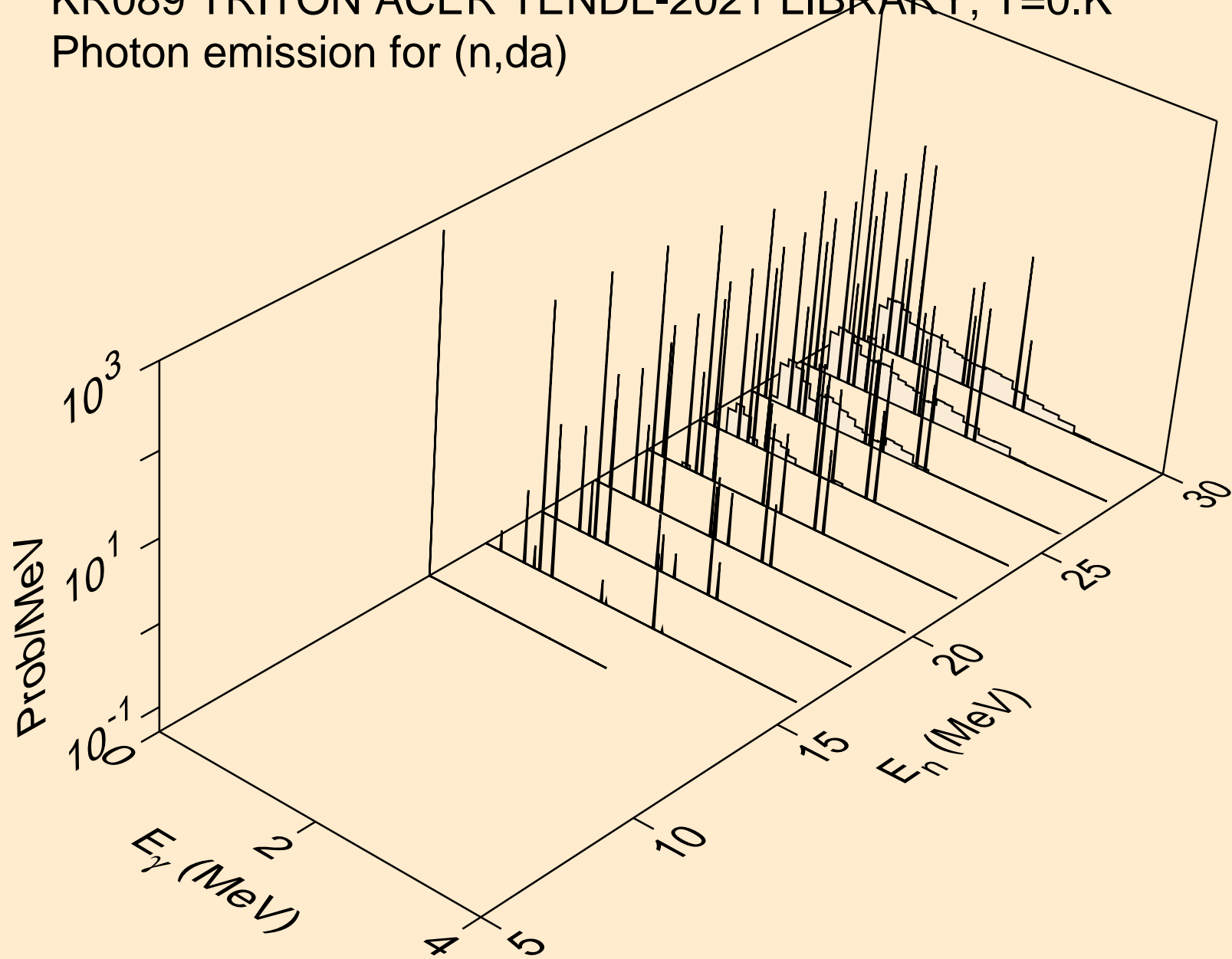

KR089 TRITON ACER TENDL-2021 LIBRARY; T=0.K  
Particle heating contributions

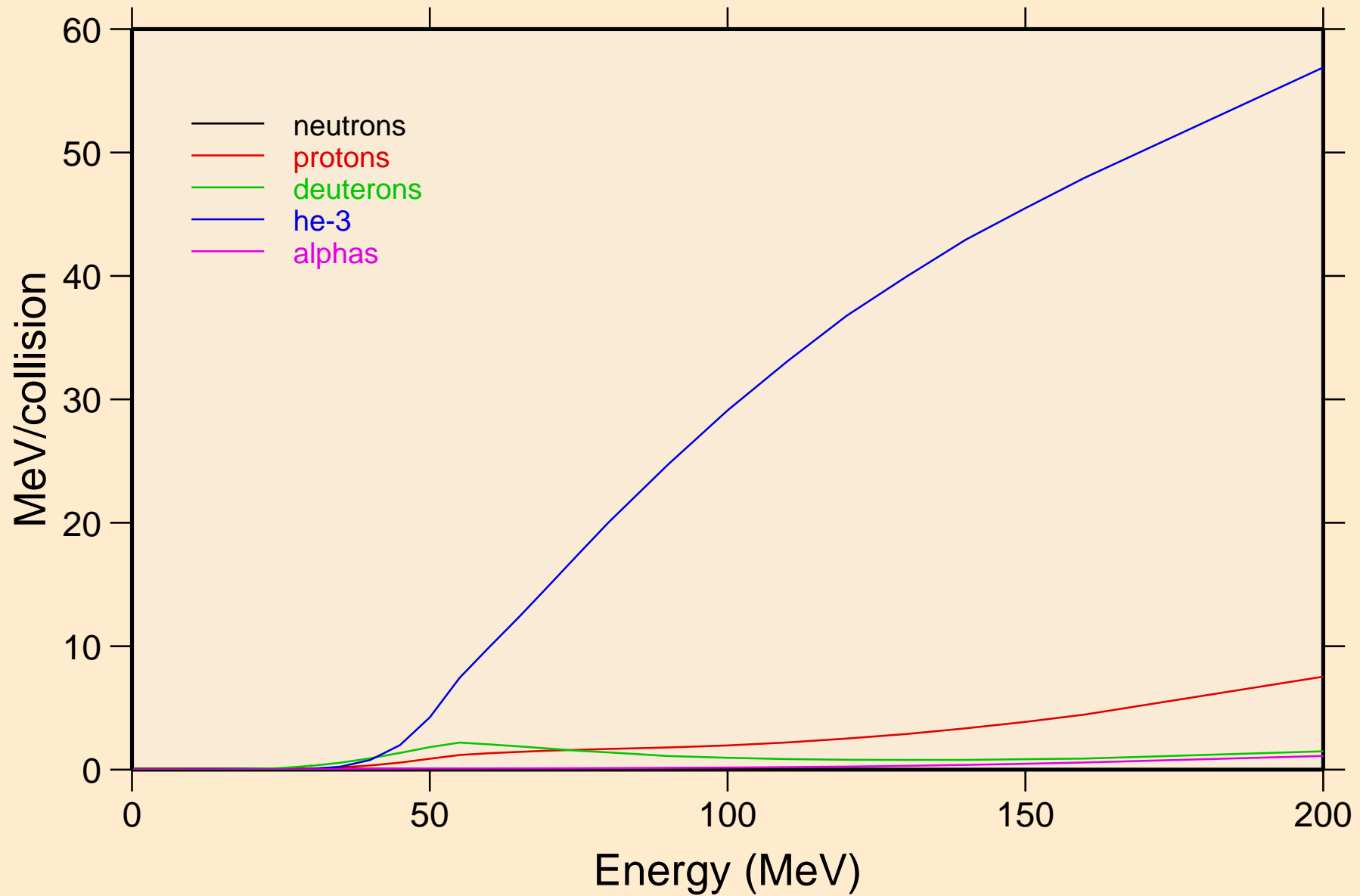

KR089 TRITON ACER TENDL-2021 LIBRARY; T=0.K  
Recoil Heating

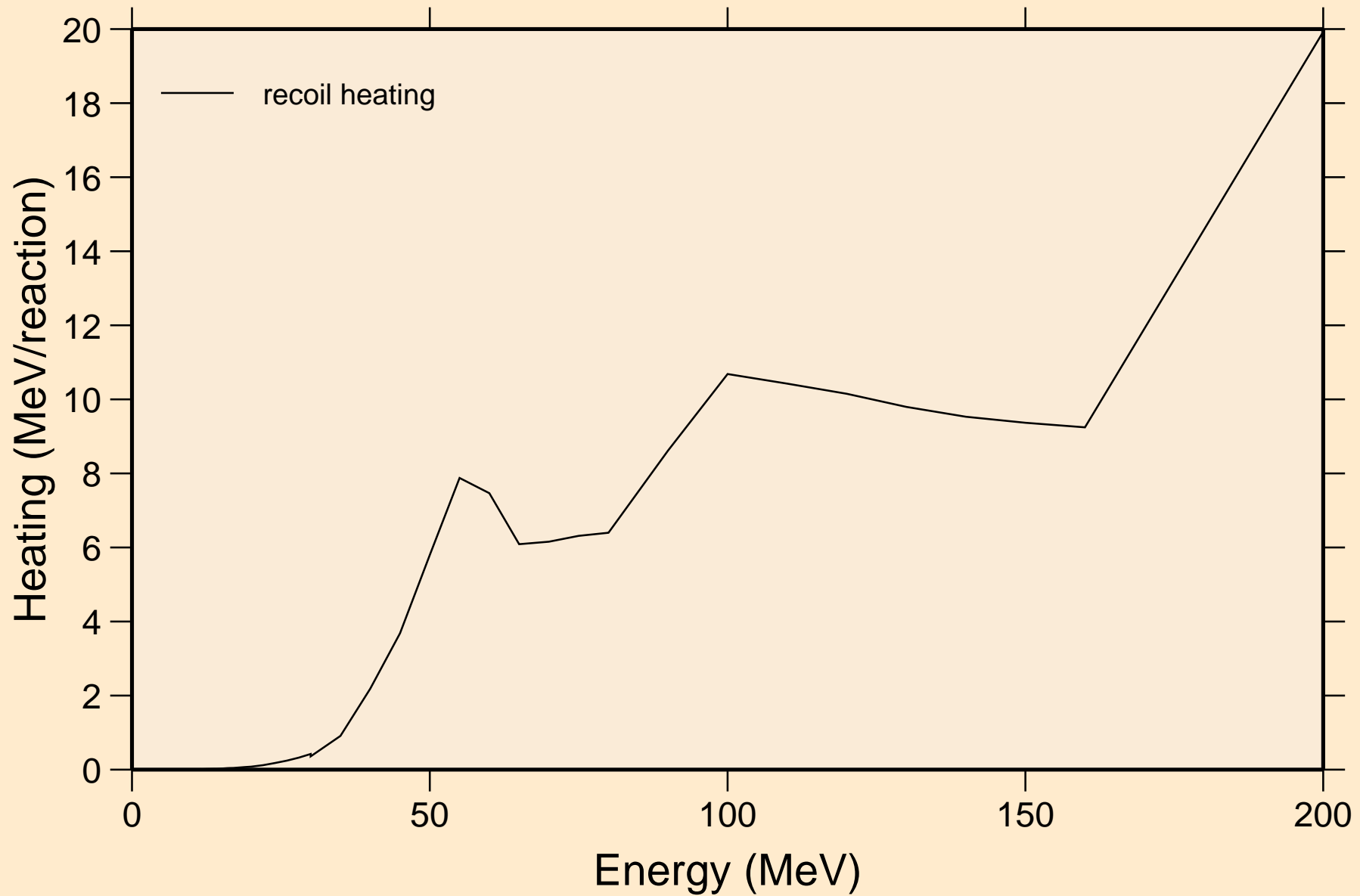

KR089 TRITON ACER TENDL-2021 LIBRARY; T=0.K  
Particle production cross sections

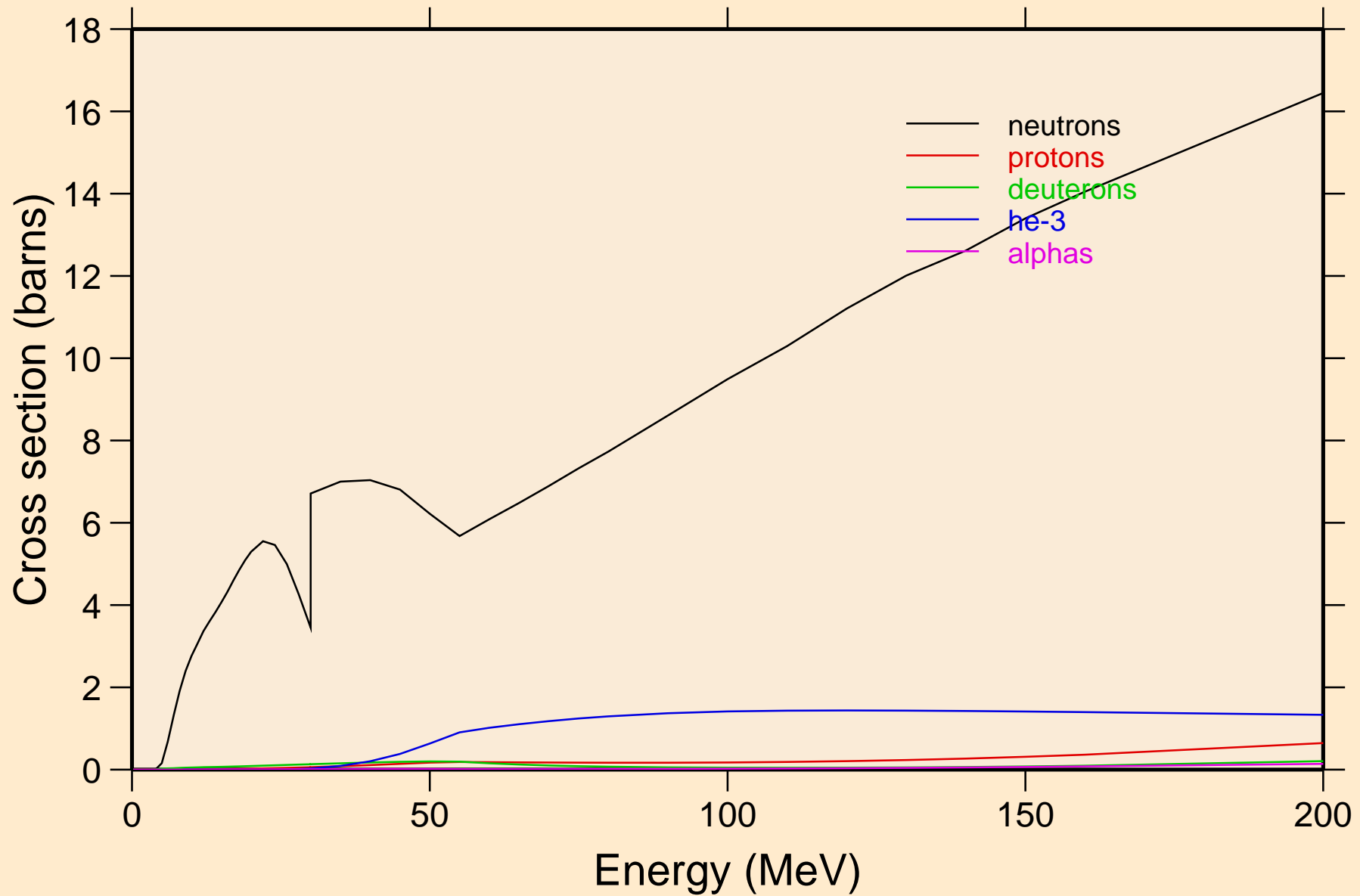

KR089 TRITON ACER TENDL-2021 LIBRARY; T=0.K  
neutrons from (t,n)

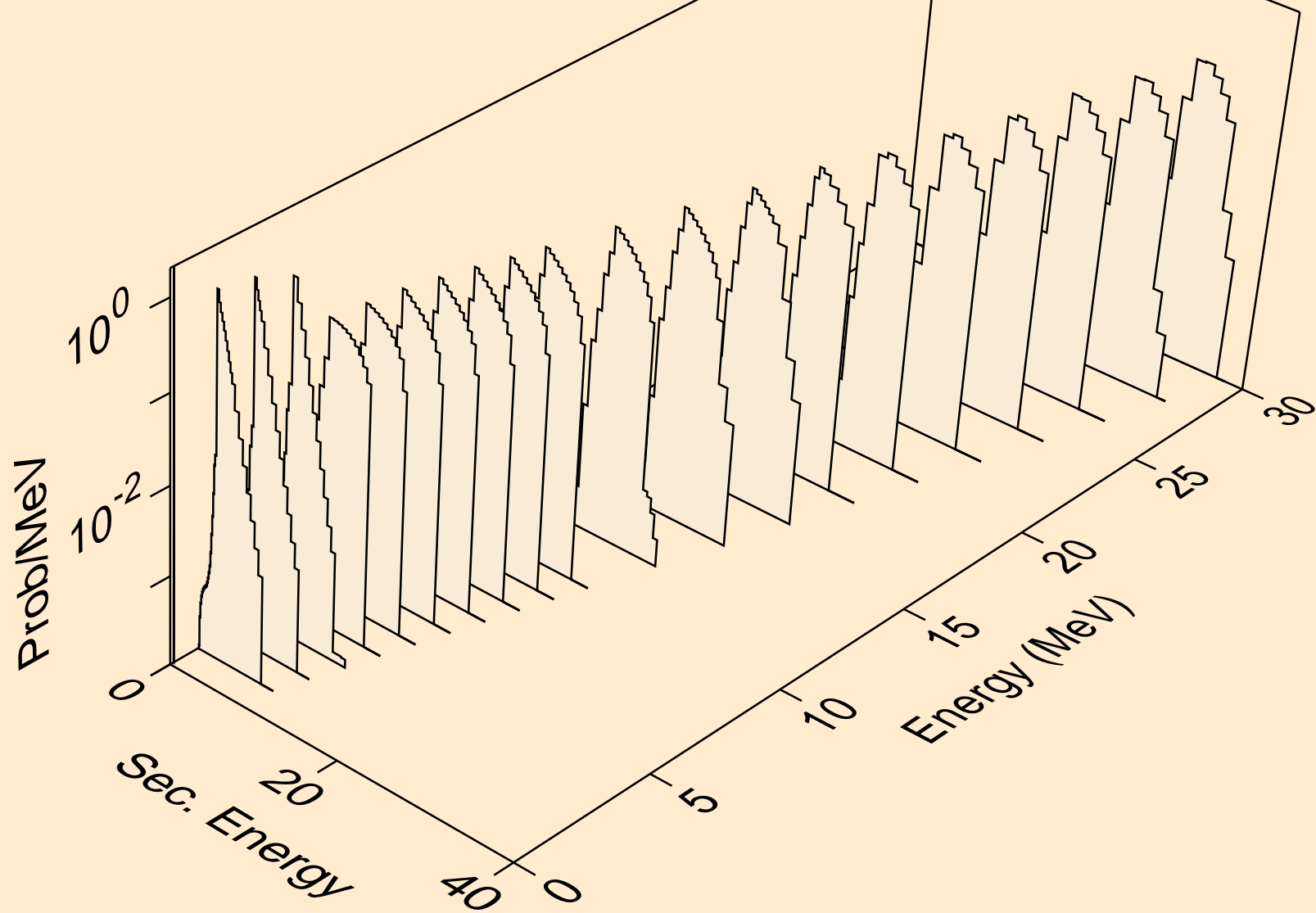

KR089 TRITON ACER TENDL-2021 LIBRARY; T=0.K  
neutrons from (t,x)

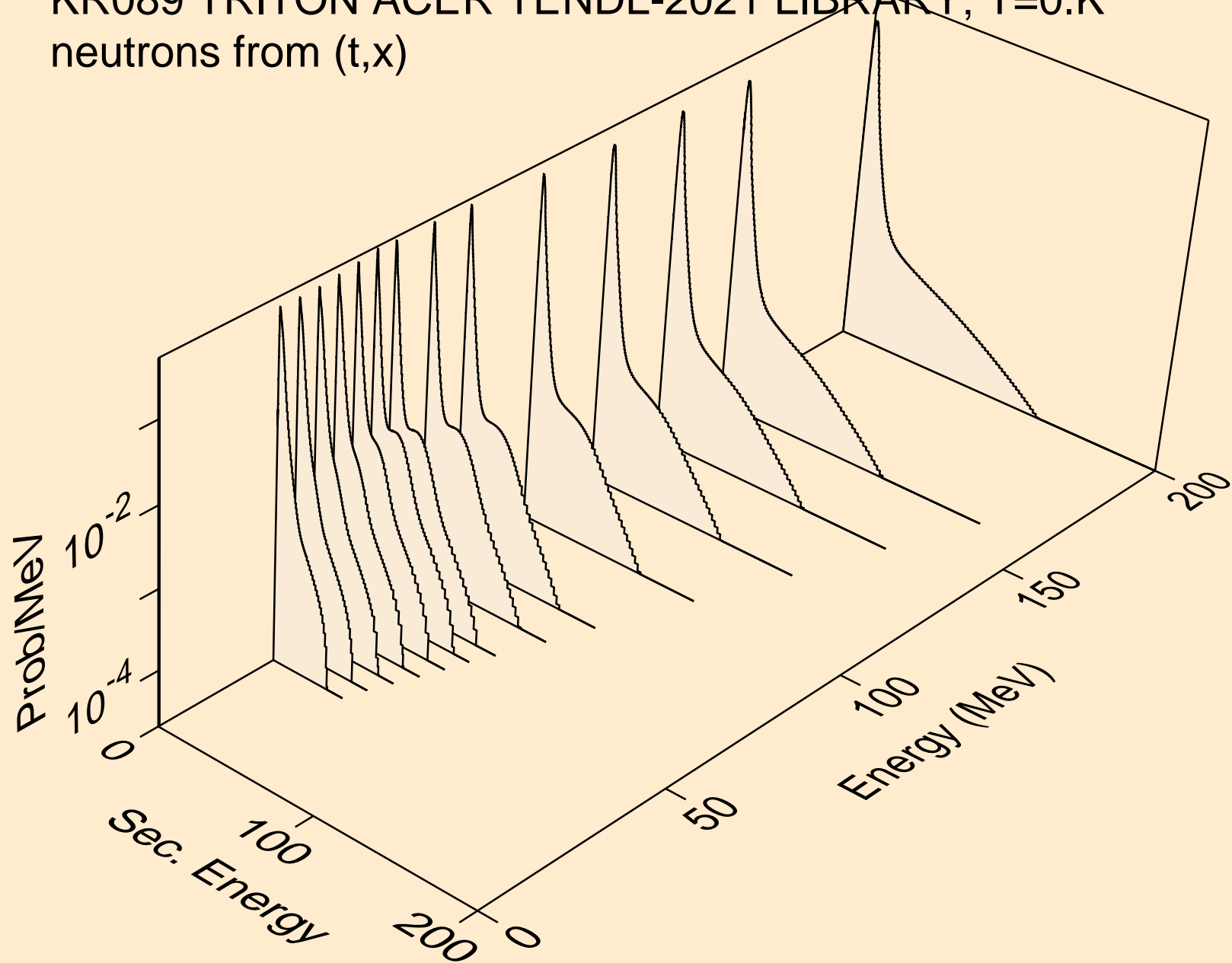



KR089 TRITON ACER TENDL-2021 LIBRARY; T=0.K  
neutrons from (t,2nd)

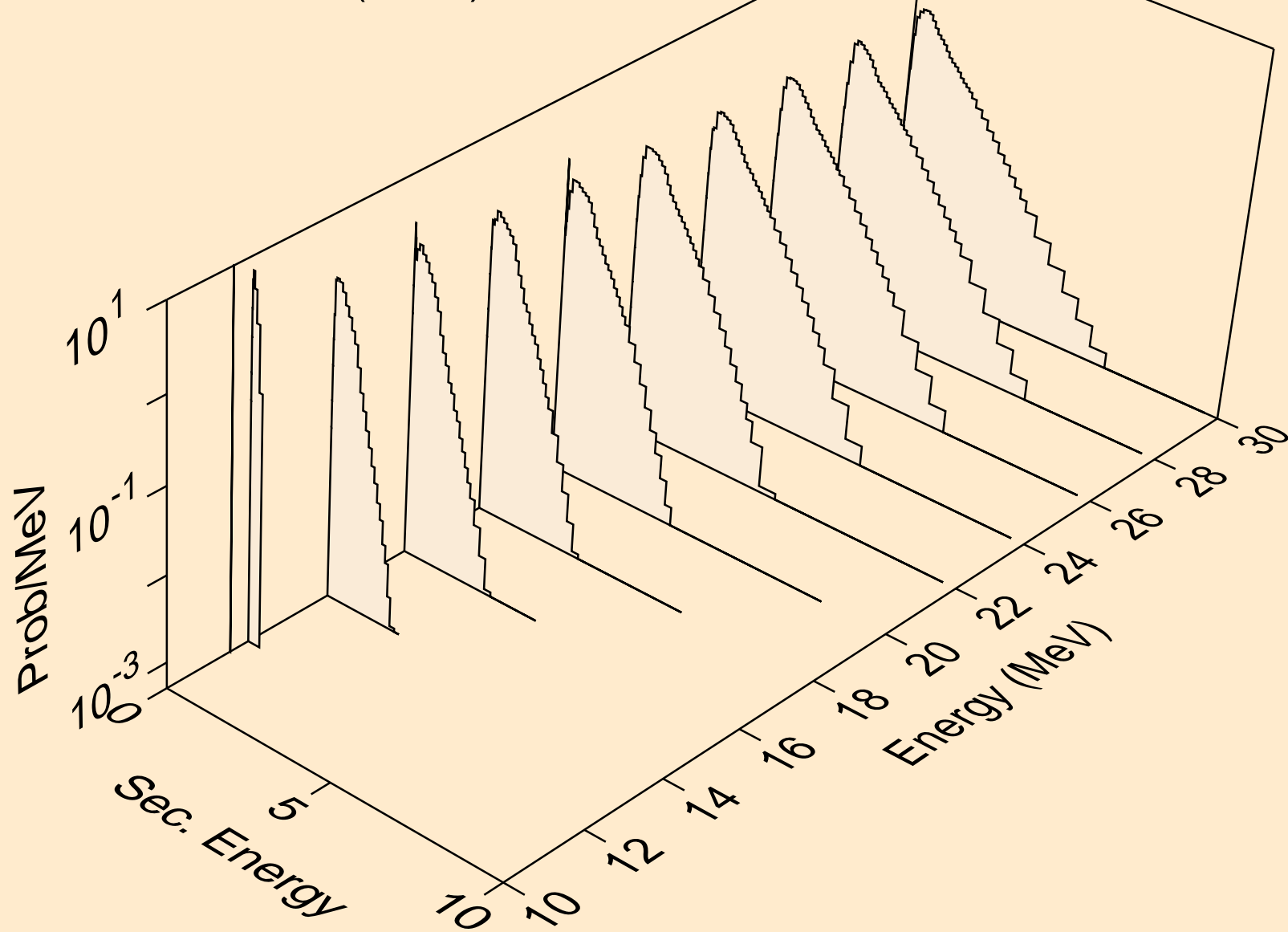

KR089 TRITON ACER TENDL-2021 LIBRARY; T=0.K  
neutrons from (t,2n)

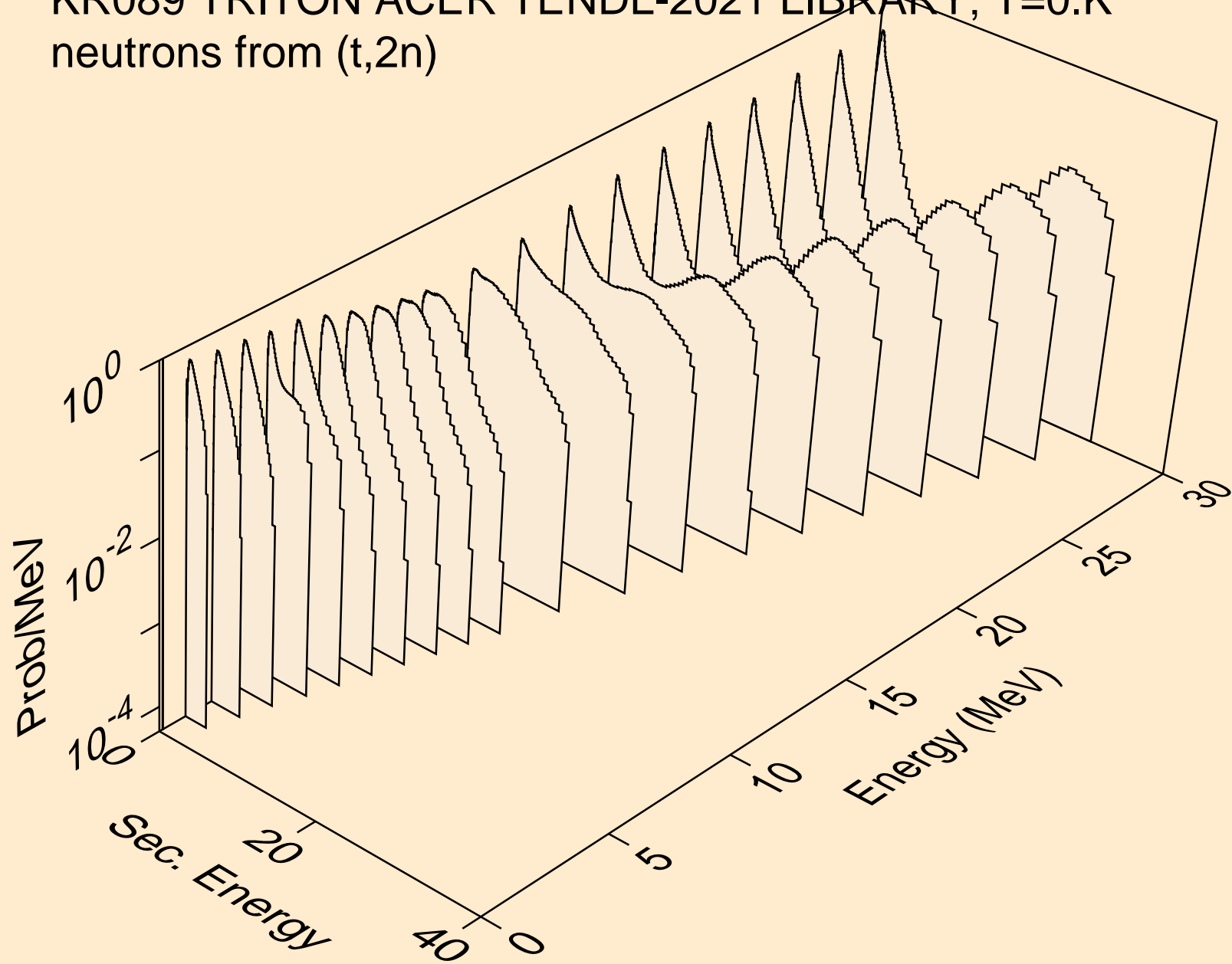

KR089 TRITON ACER TENDL-2021 LIBRARY; T=0.K  
neutrons from (t,3n)

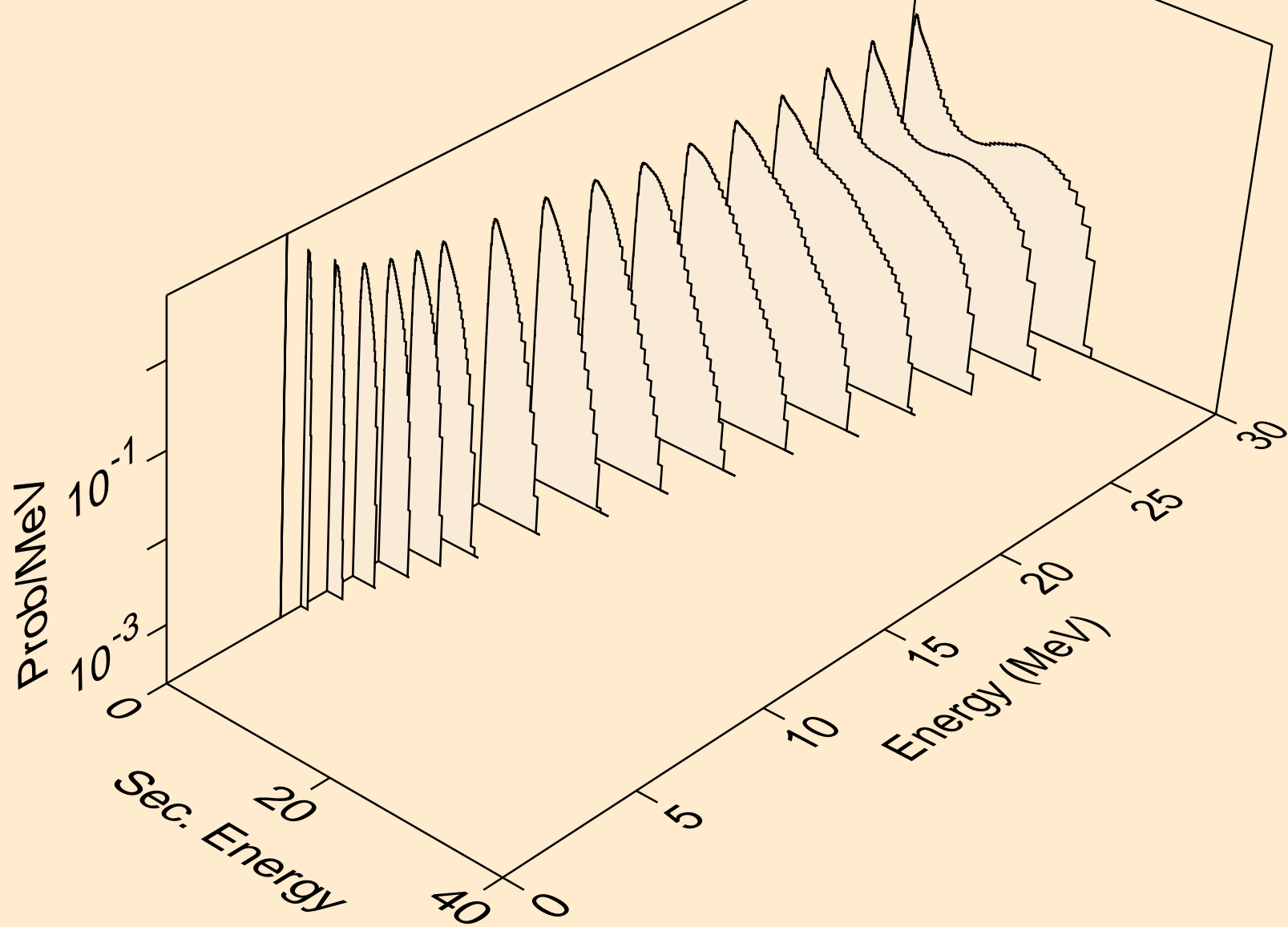

KR089 TRITON ACER TENDL-2021 LIBRARY; T=0.K  
neutrons from (t,n\*)a

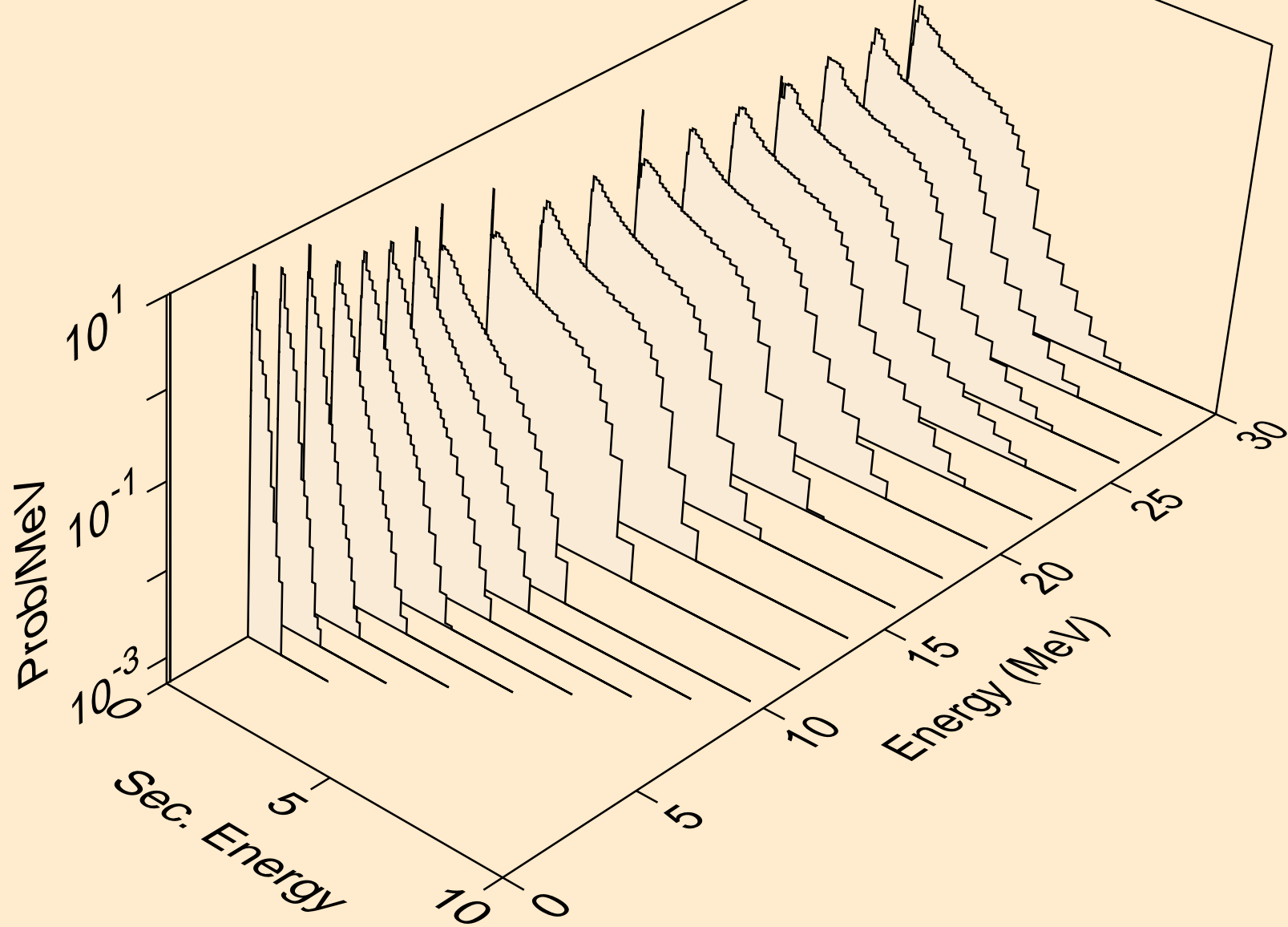

KR089 TRITON ACER TENDL-2021 LIBRARY; T=0.K  
neutrons from (t,2n)a

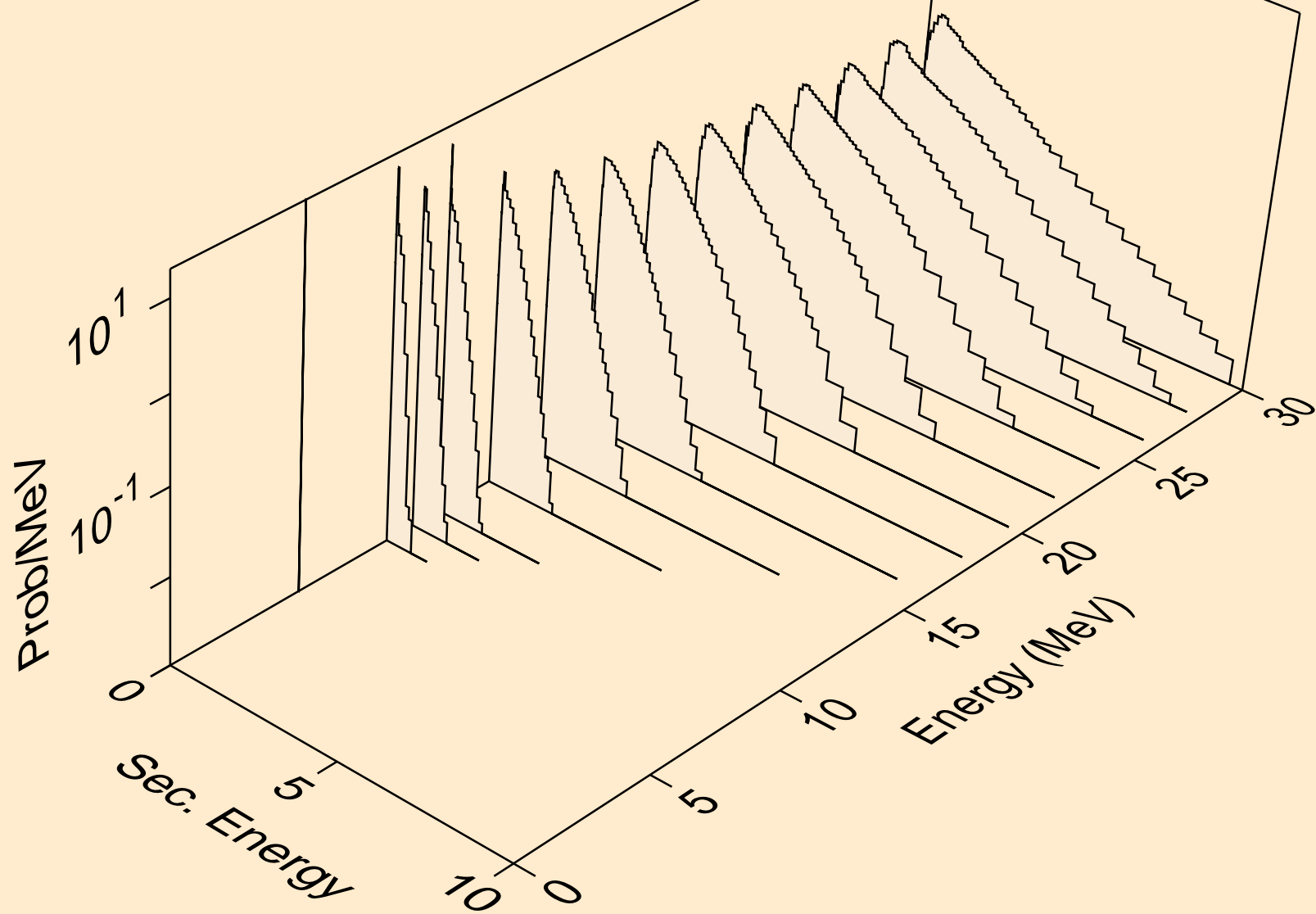

KR089 TRITON ACER TENDL-2021 LIBRARY; T=0.K  
neutrons from (t,3n)a

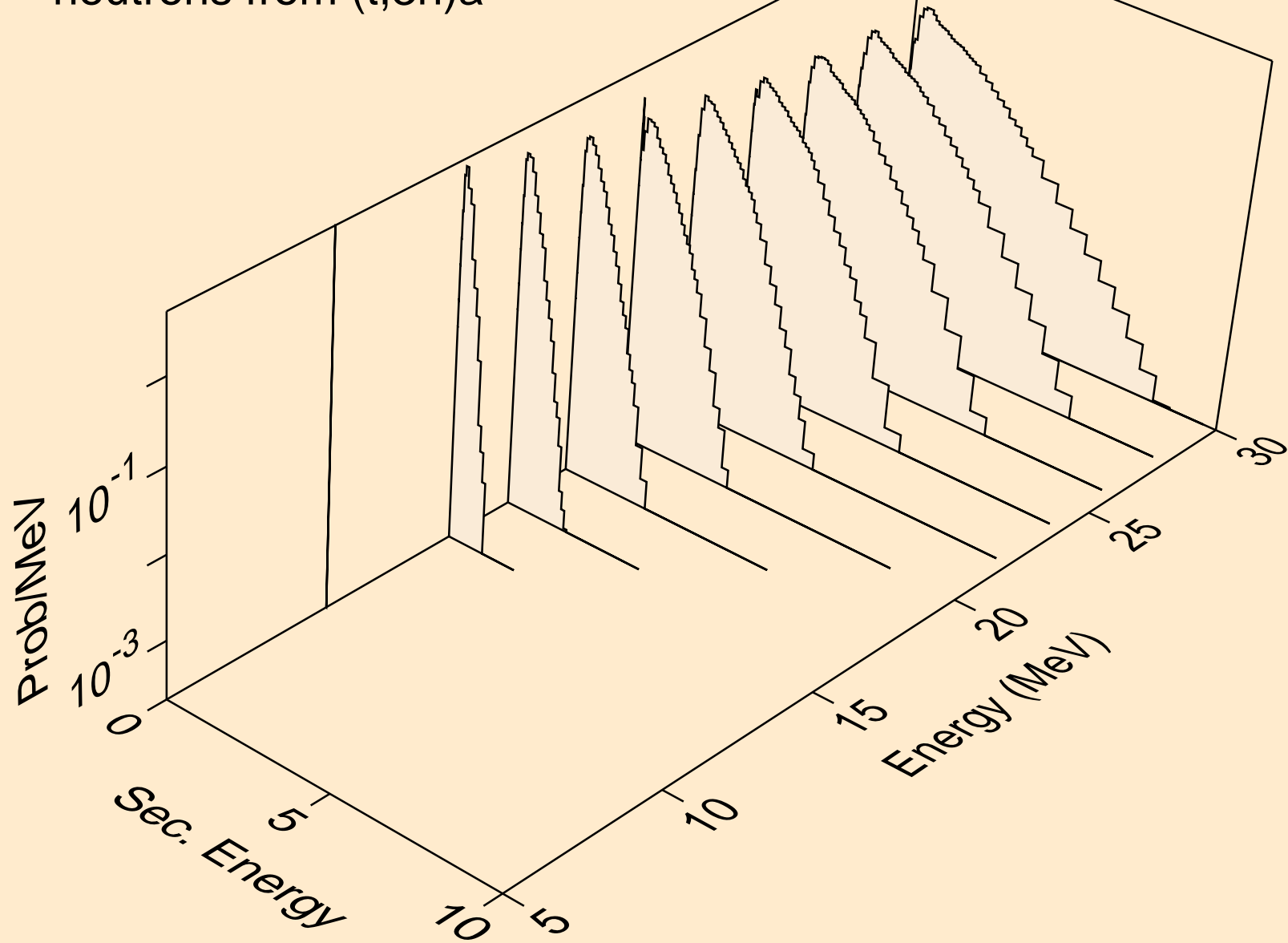

KR089 TRITON ACER TENDL-2021 LIBRARY; T=0.K  
neutrons from (t,n\*)p

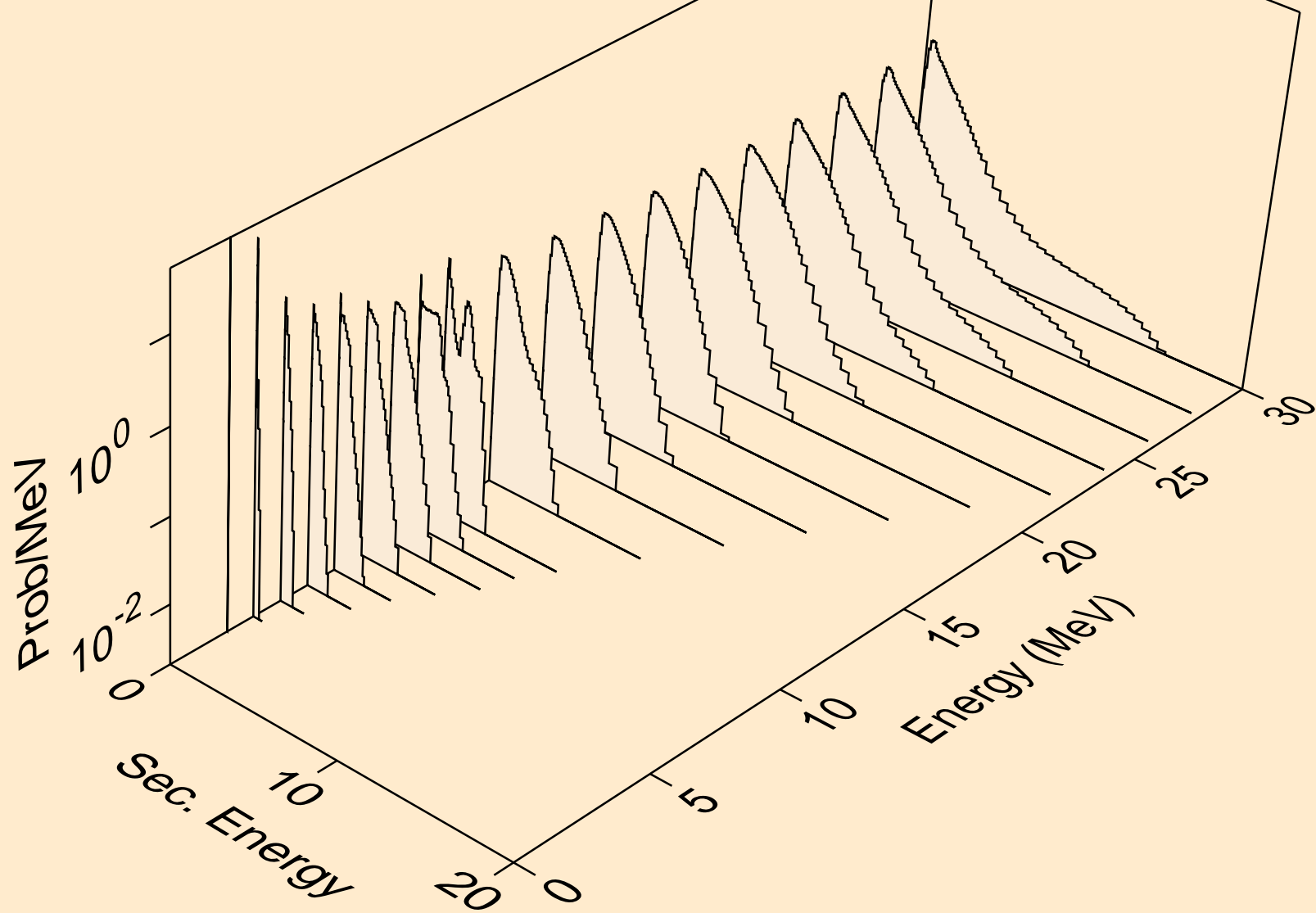

KR089 TRITON ACER TENDL-2021 LIBRARY; T=0.K  
neutrons from (t,n\*)2a

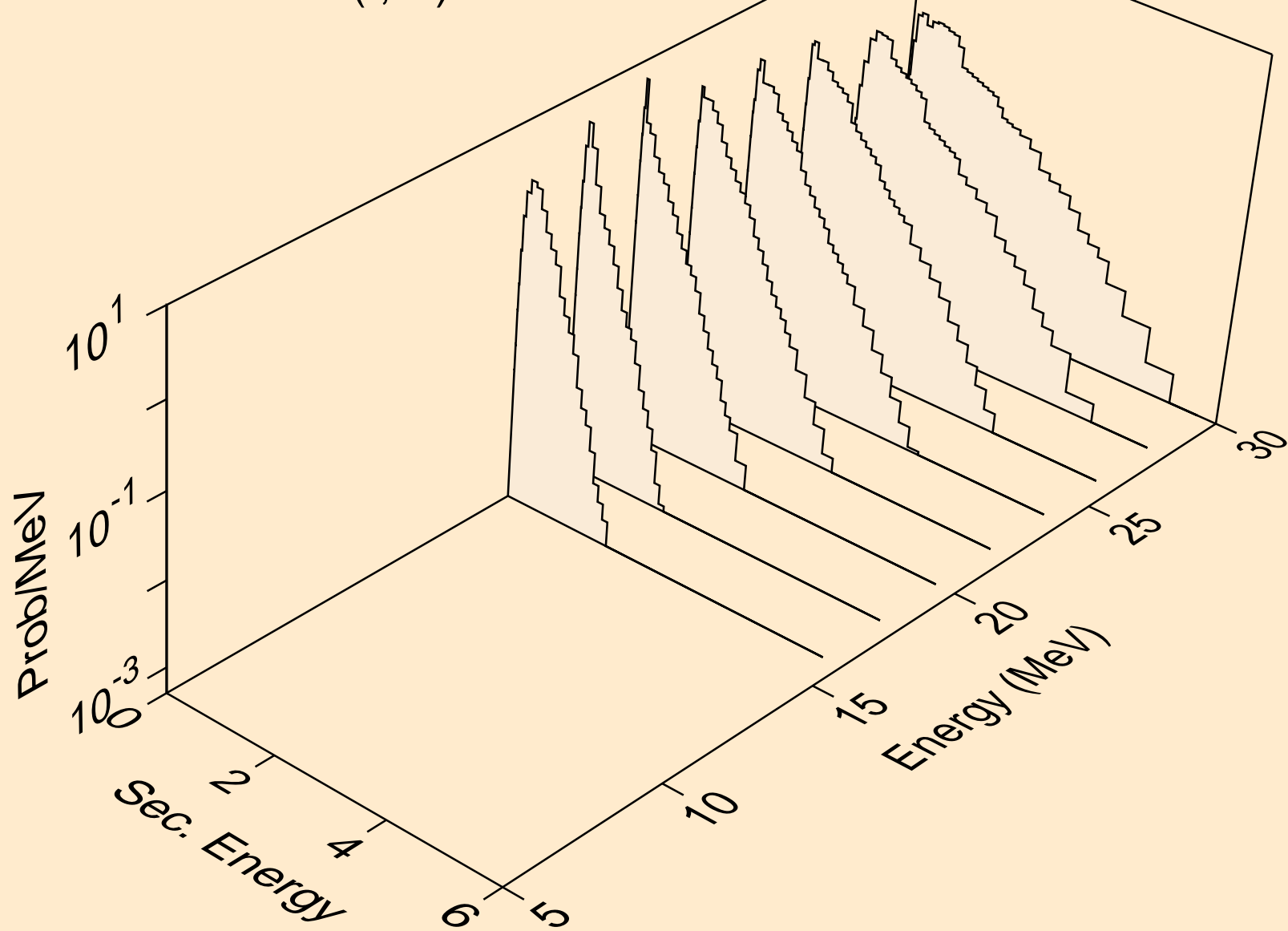



KR089 TRITON ACER TENDL-2021 LIBRARY; T=0.K  
neutrons from (t,n\*)d

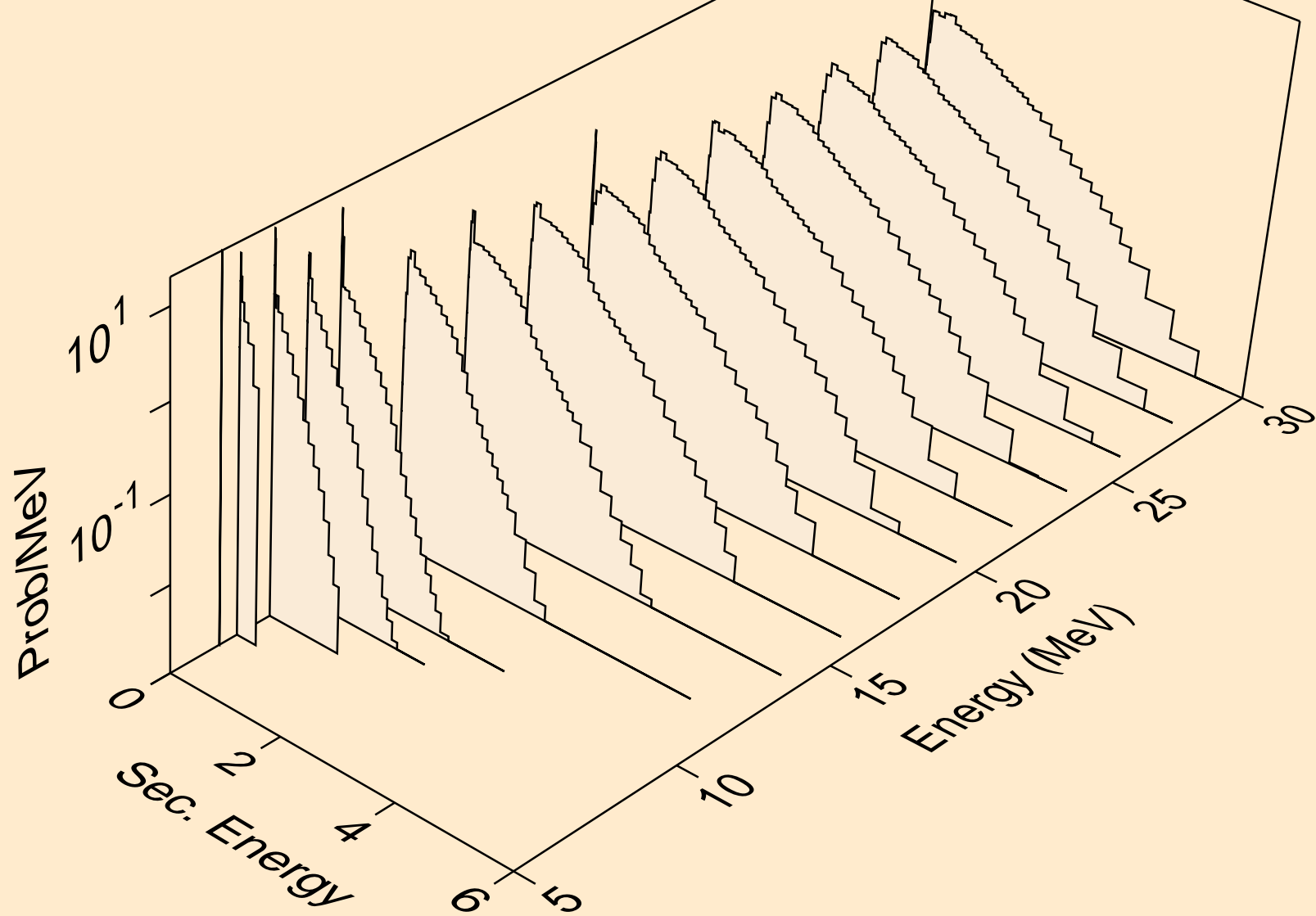

KR089 TRITON ACER TENDL-2021 LIBRARY; T=0.K  
neutrons from (t,n\*)t

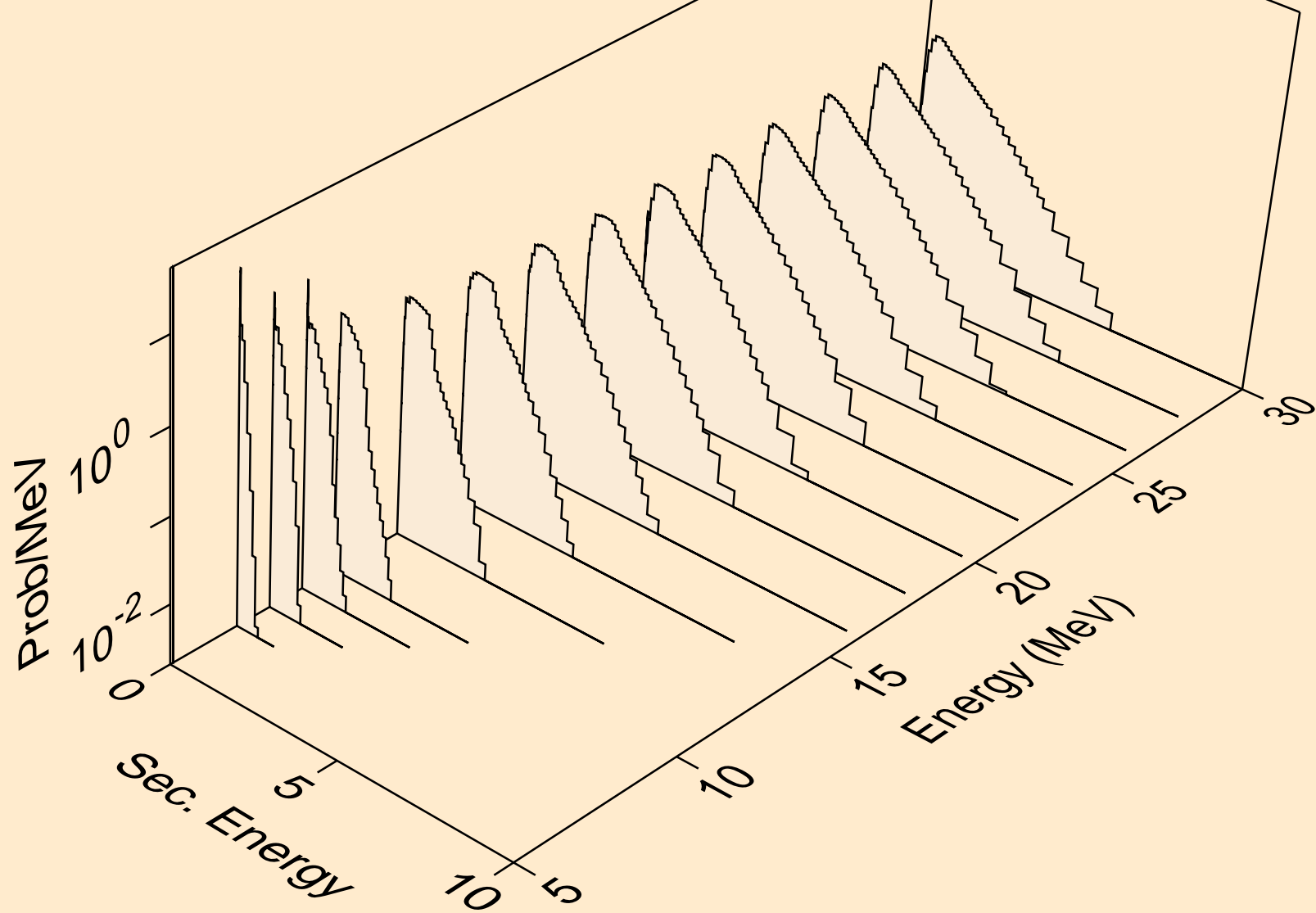

KR089 TRITON ACER TENDL-2021 LIBRARY; T=0.K  
neutrons from (t,n\*)he3

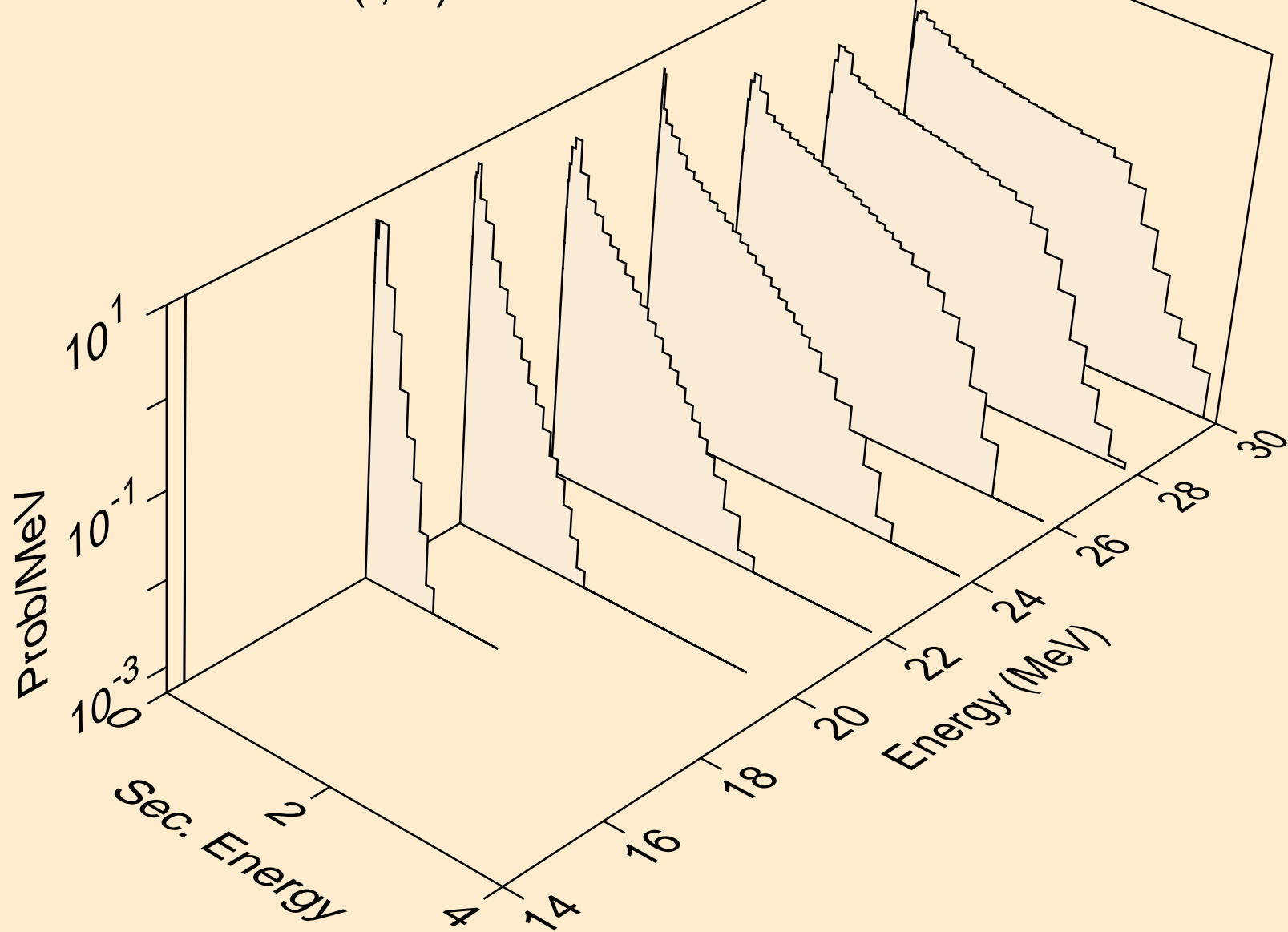

KR089 TRITON ACER TENDL-2021 LIBRARY; T=0.K  
neutrons from (t,4n)

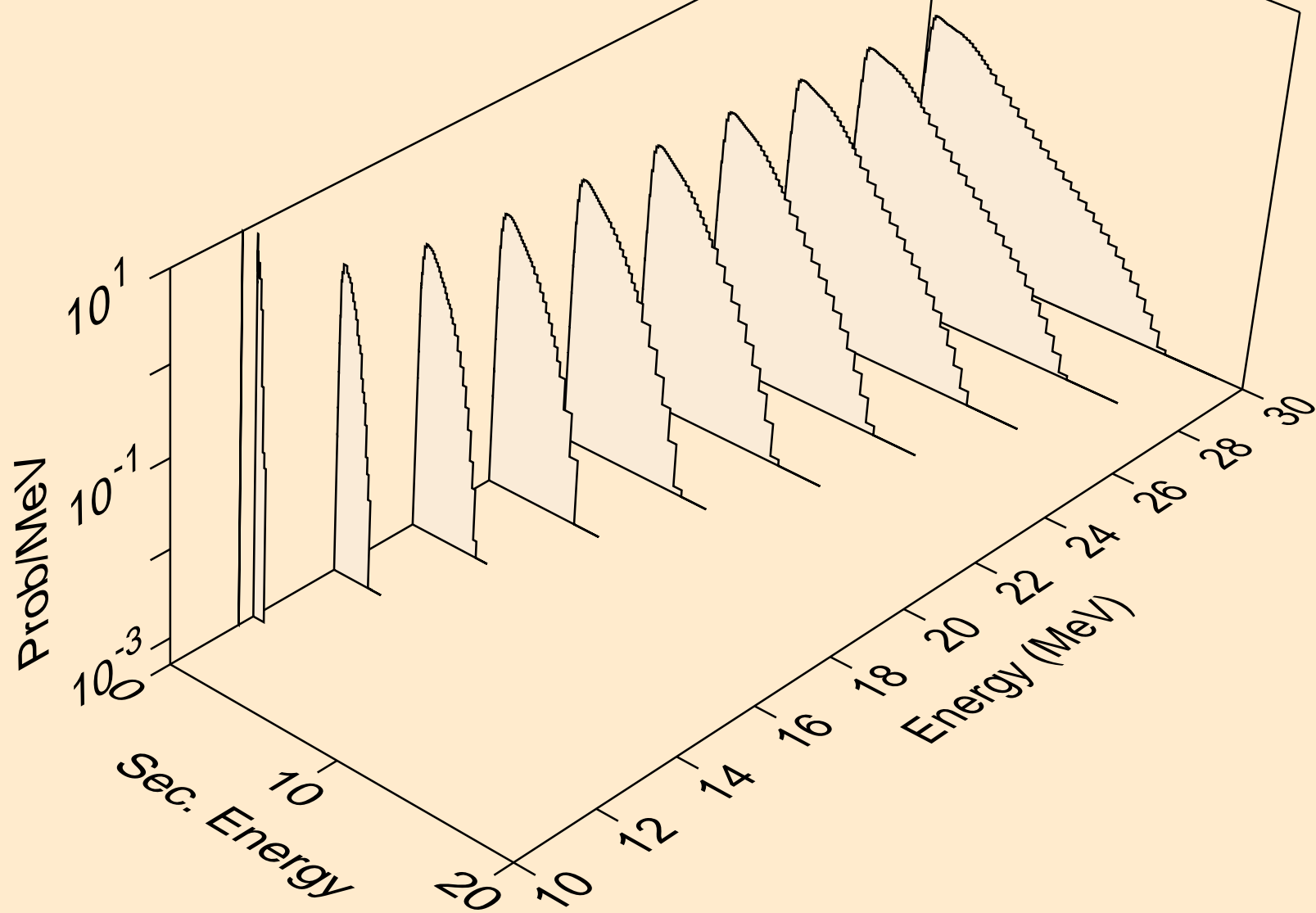

KR089 TRITON ACER TENDL-2021 LIBRARY; T=0.K  
neutrons from (t,2np)

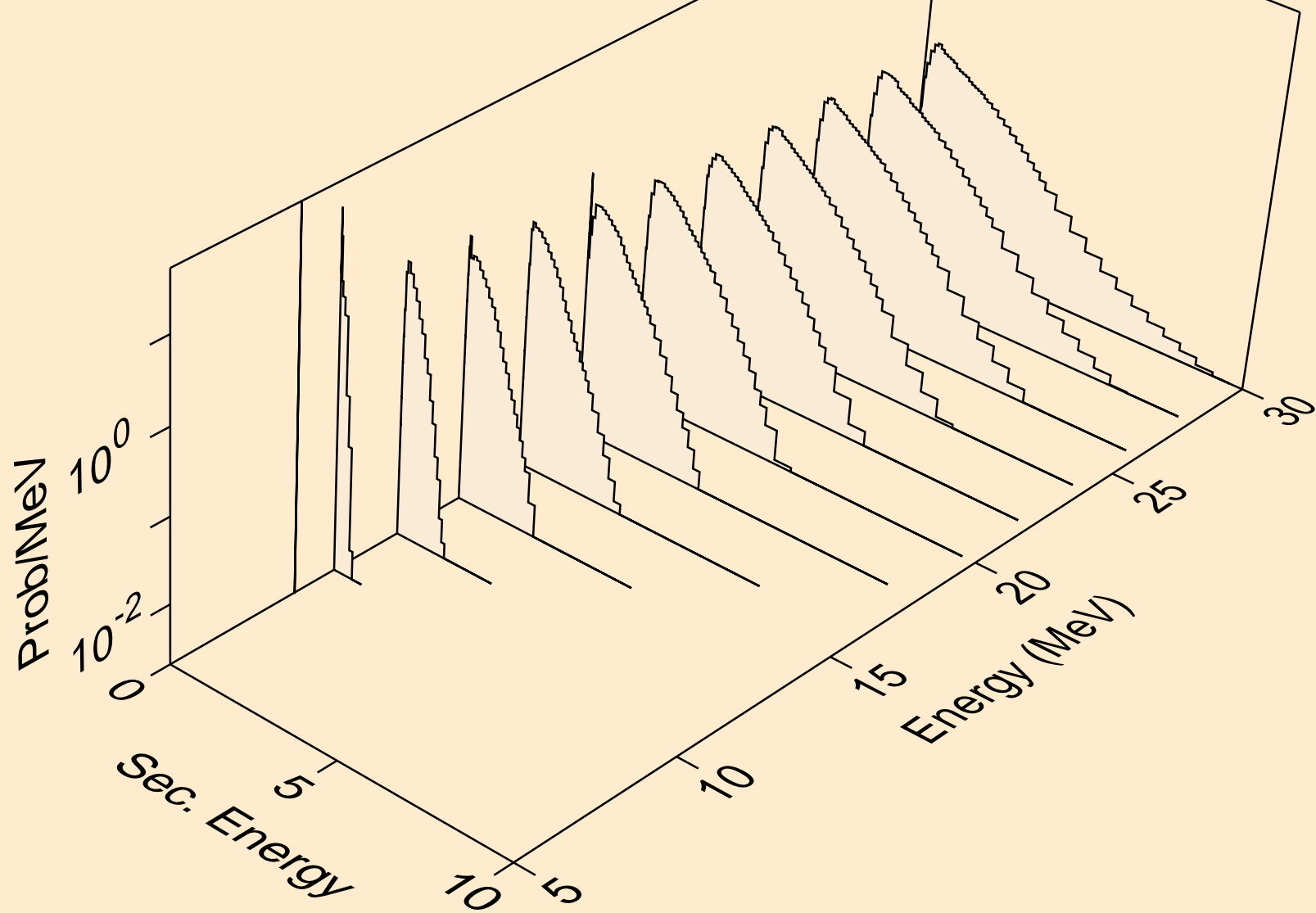

KR089 TRITON ACER TENDL-2021 LIBRARY; T=0.K  
neutrons from (t,3np)

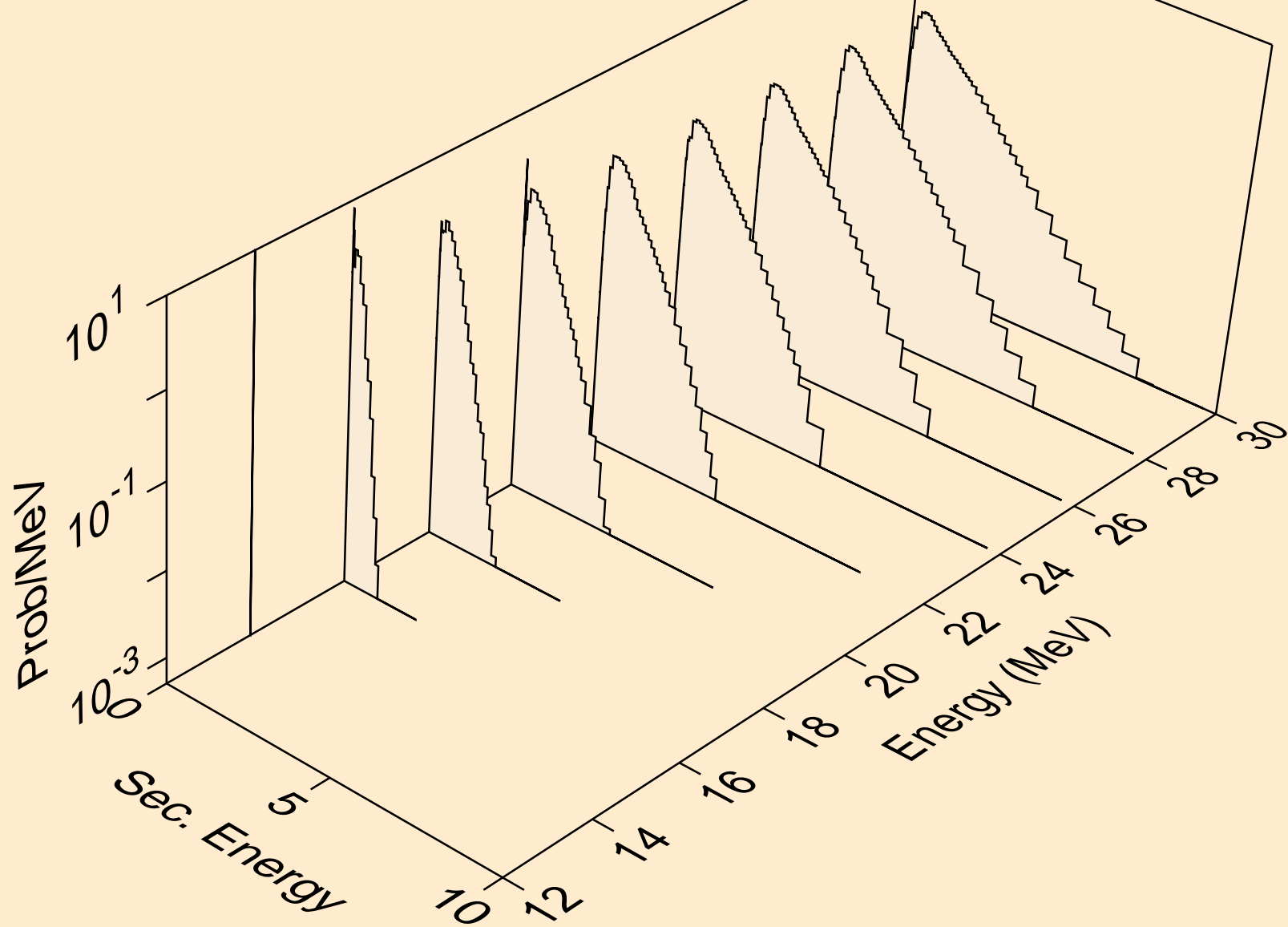

KR089 TRITON ACER TENDL-2021 LIBRARY; T=0.K  
neutrons from (t,2np)

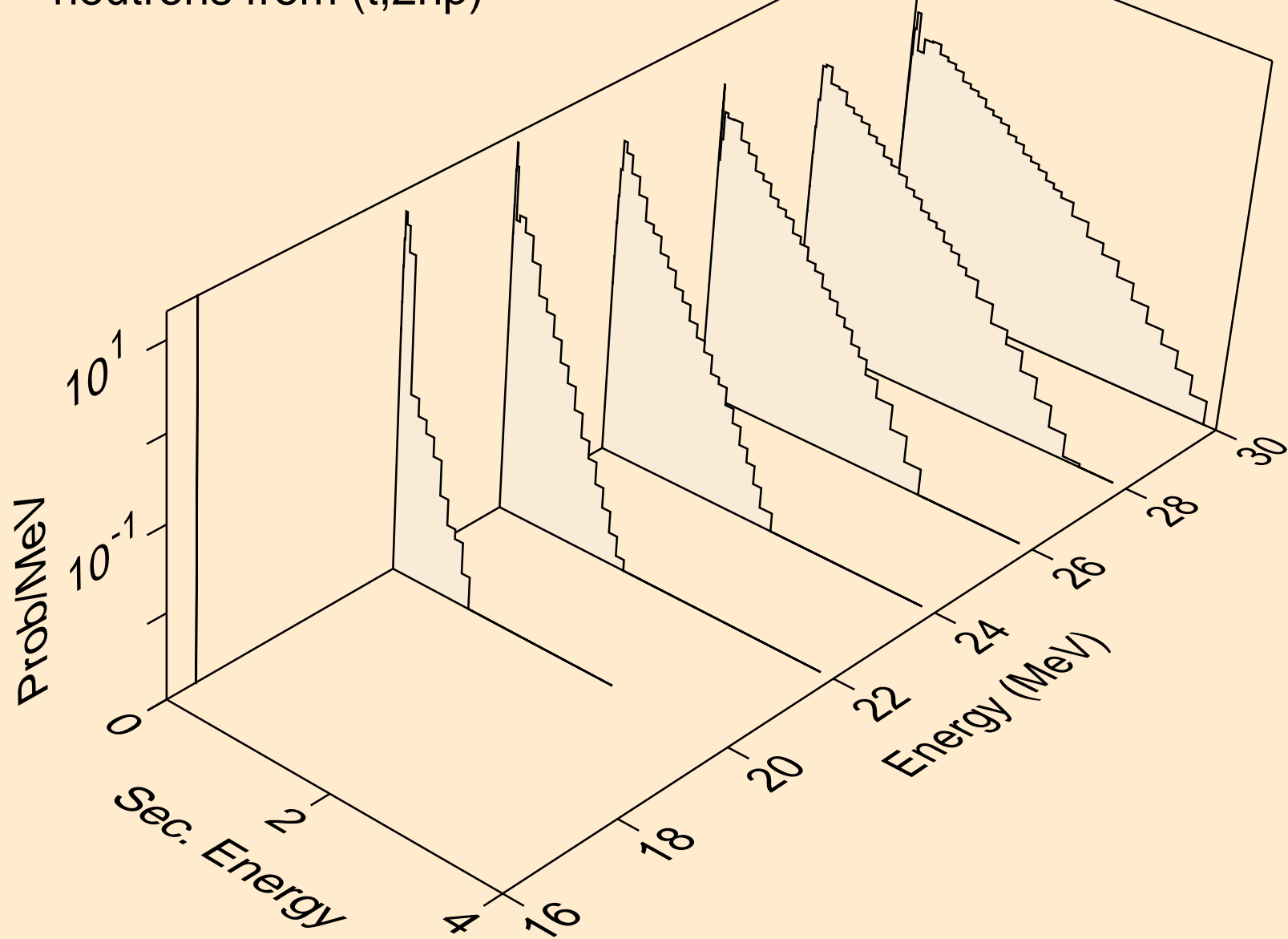

KR089 TRITON ACER TENDL-2021 LIBRARY; T=0.K  
neutrons from (t,npa)

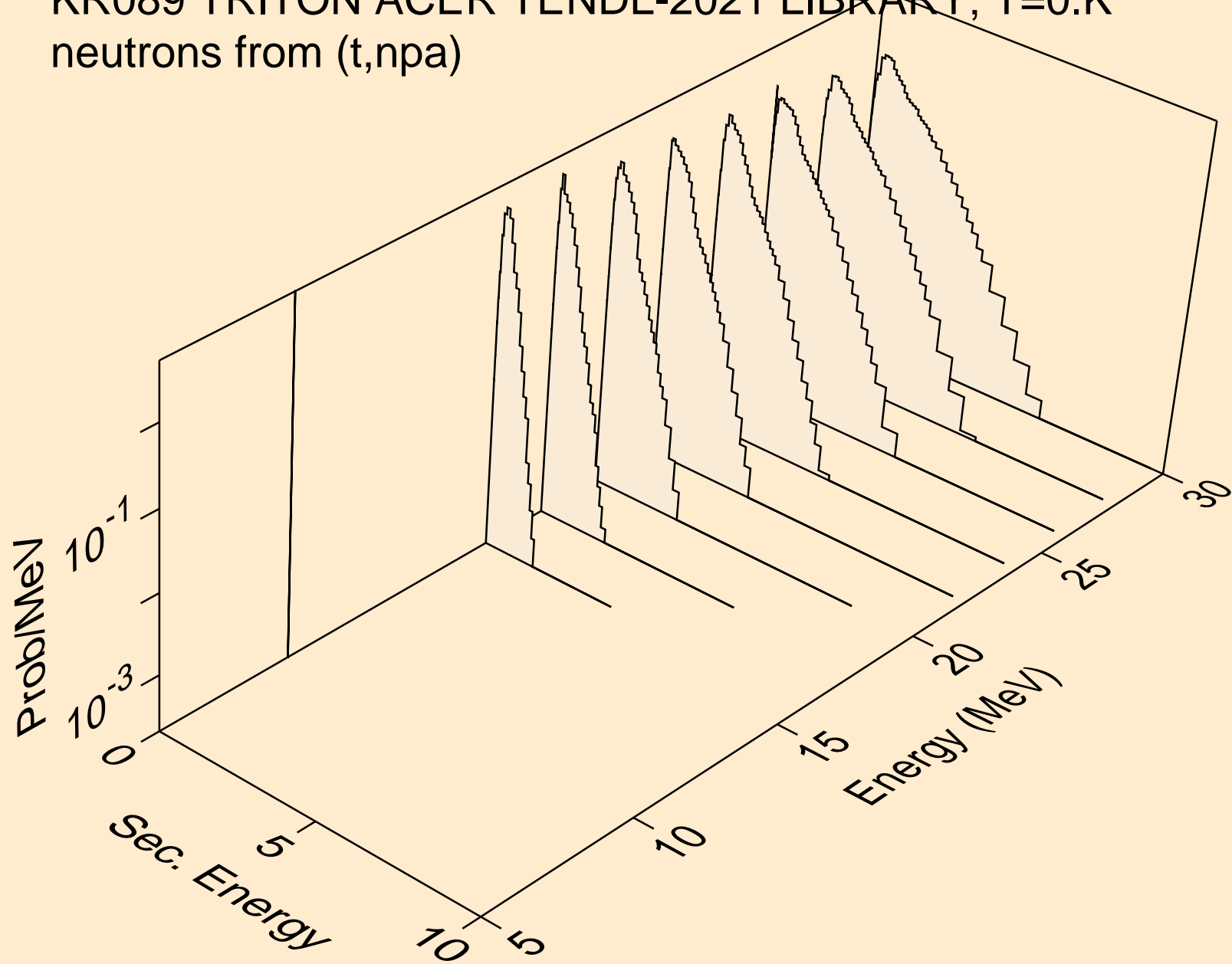



KR089 TRITON ACER TENDL-2021 LIBRARY; T=0.K  
protons from (t,x)

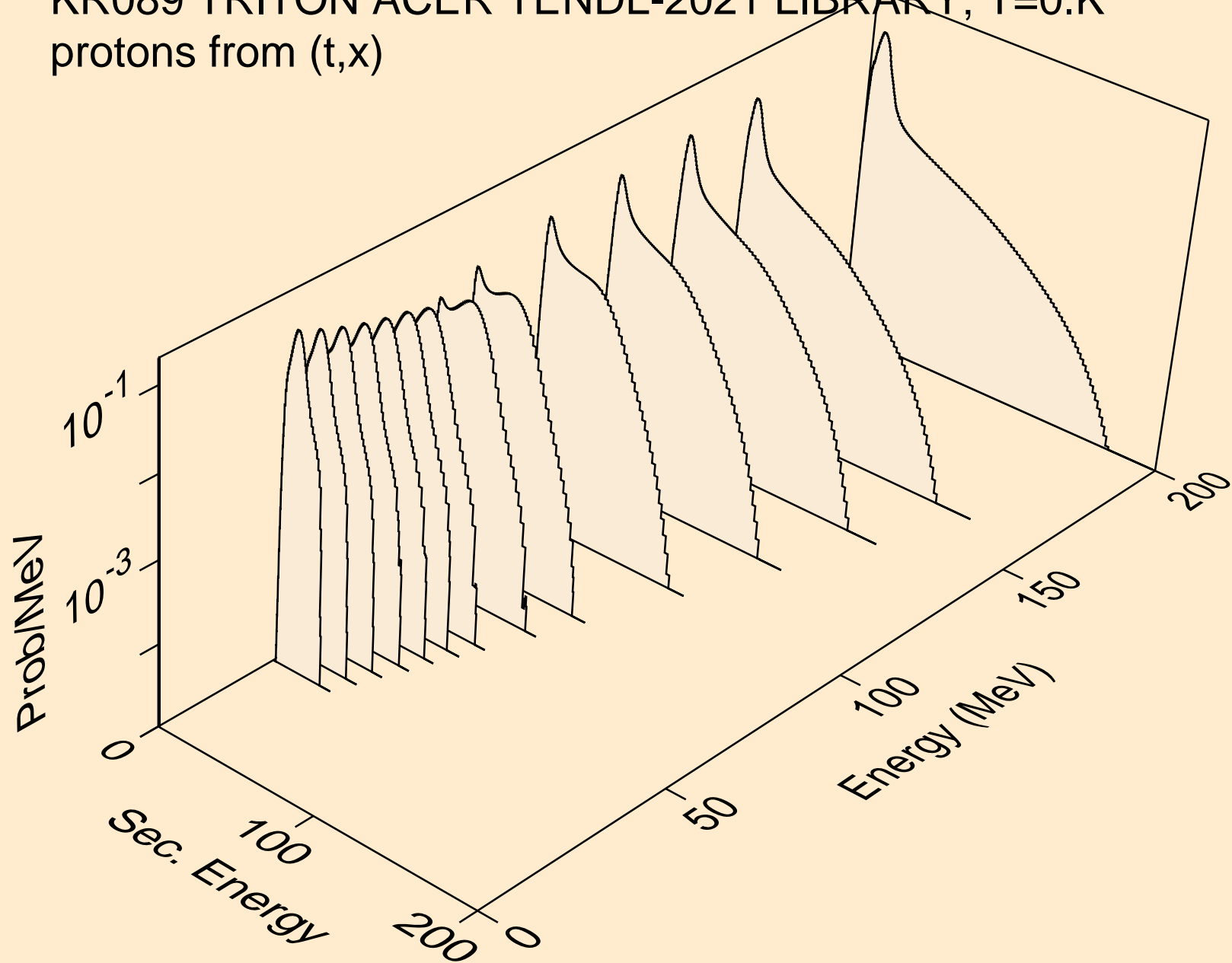

KR089 TRITON ACER TENDL-2021 LIBRARY; T=0.K  
protons from (t,n\*)p

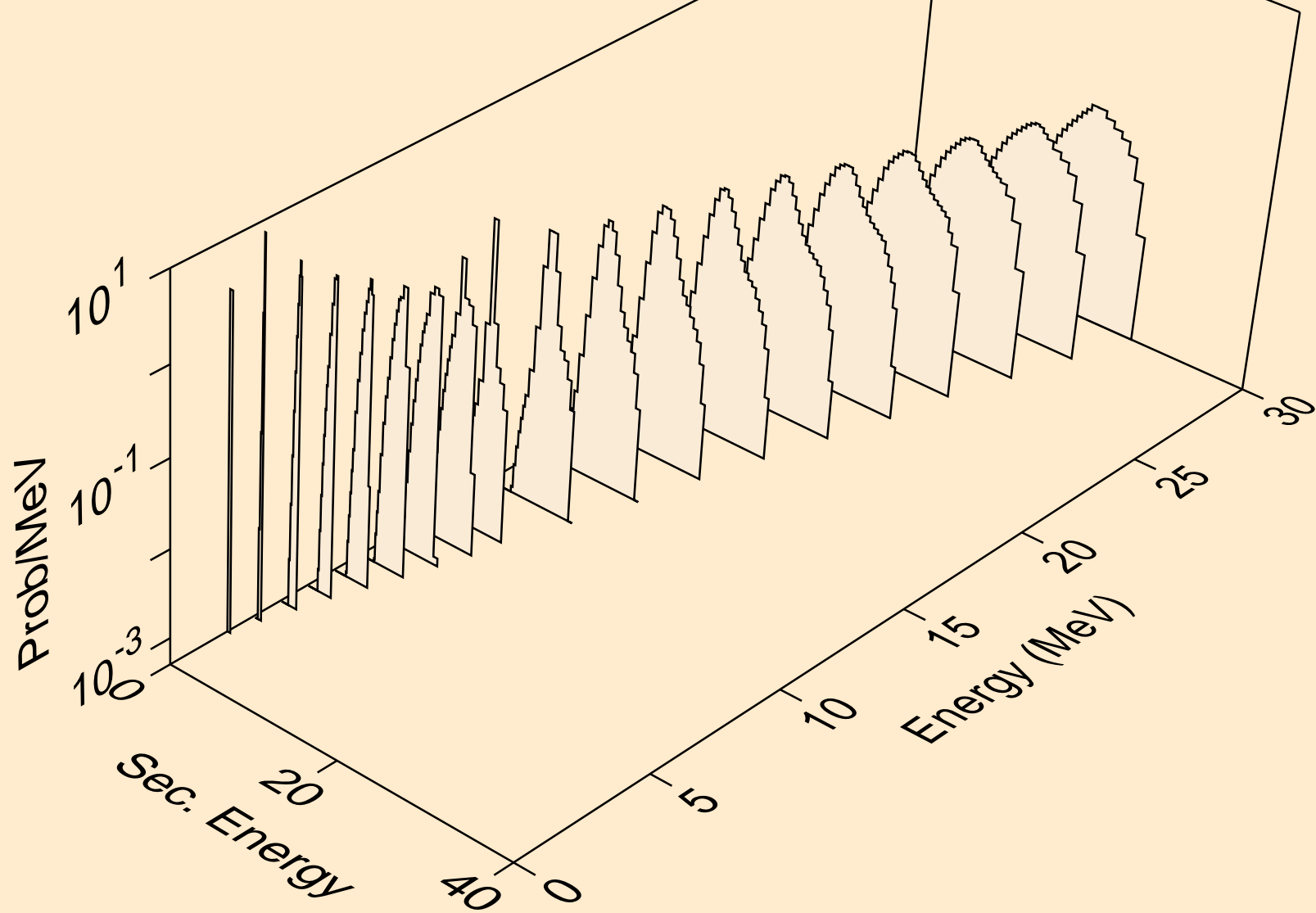

KR089 TRITON ACER TENDL-2021 LIBRARY; T=0.K  
protons from (t,2np)

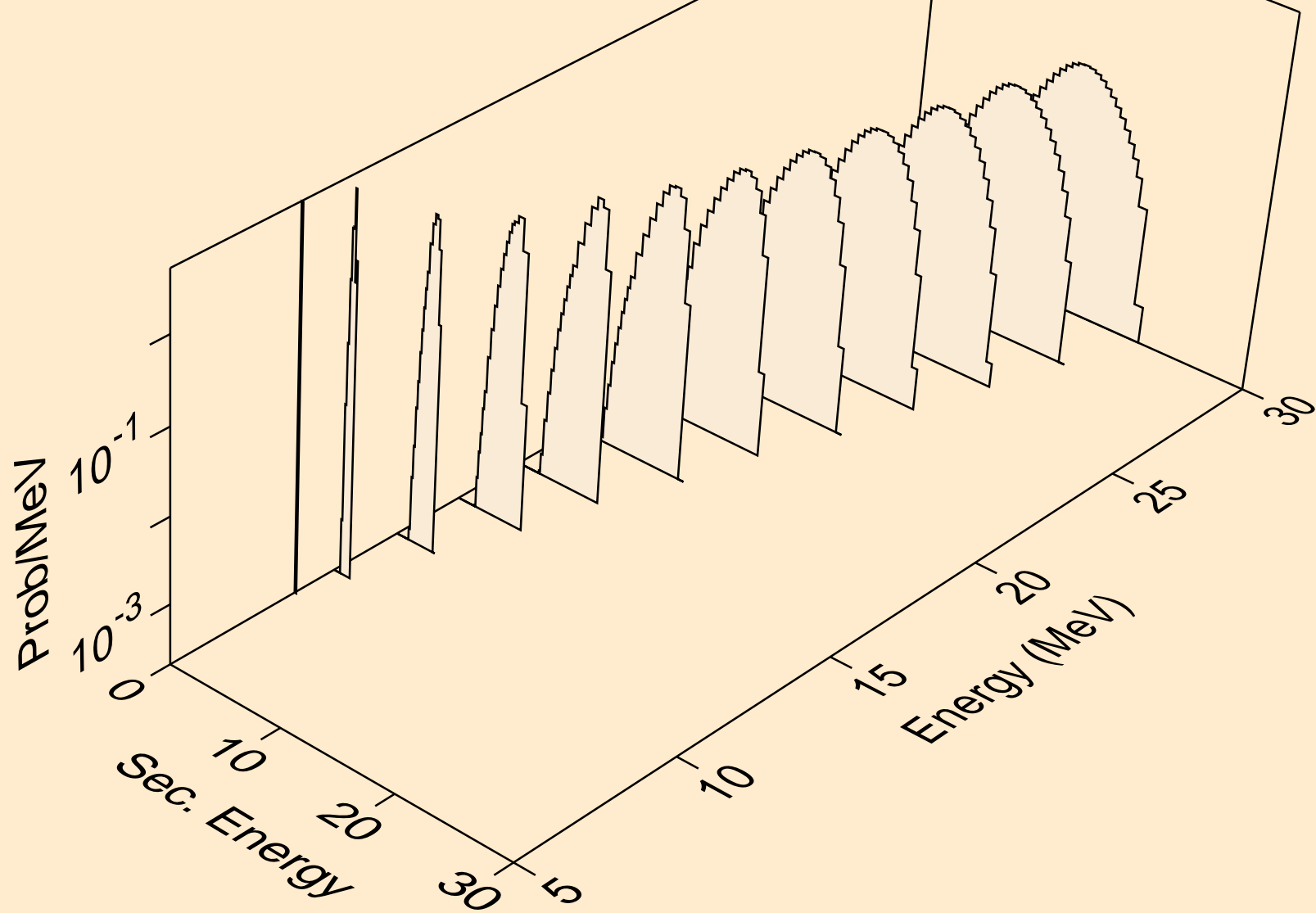

KR089 TRITON ACER TENDL-2021 LIBRARY; T=0.K  
protons from (t,3np)

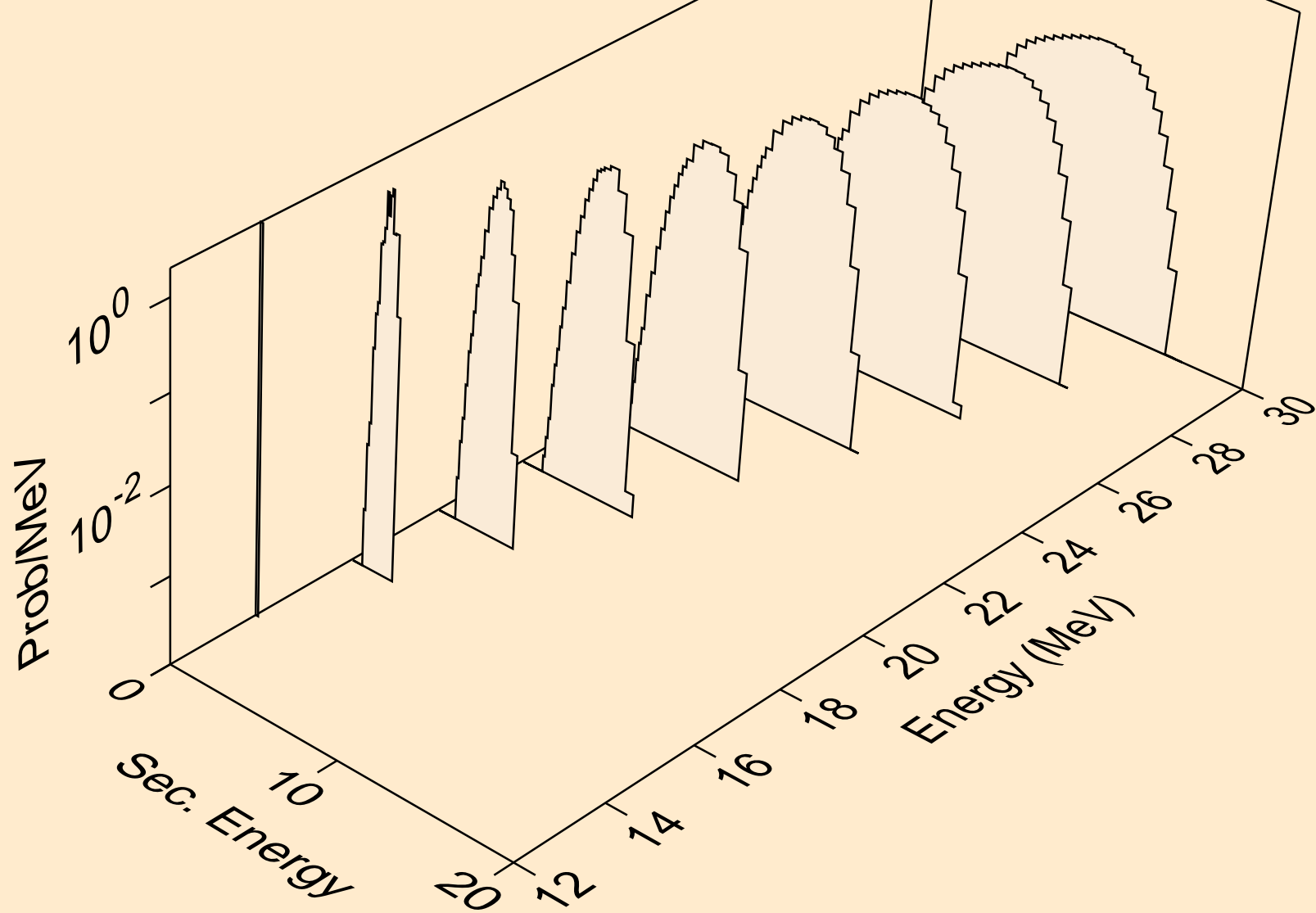

KR089 TRITON ACER TENDL-2021 LIBRARY; T=0.K  
protons from (t,2np)

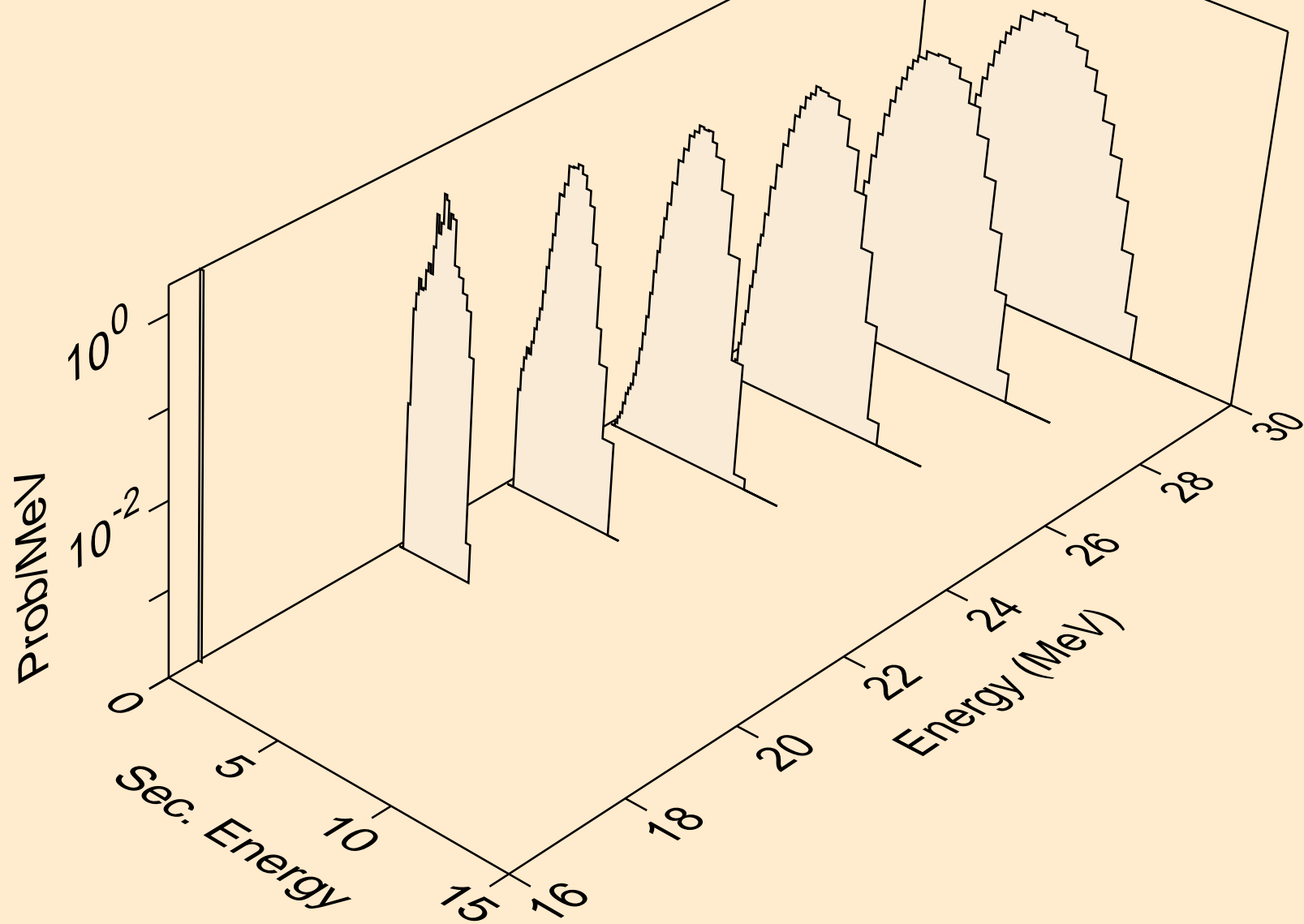

KR089 TRITON ACER TENDL-2021 LIBRARY; T=0.K  
protons from (t,npa)

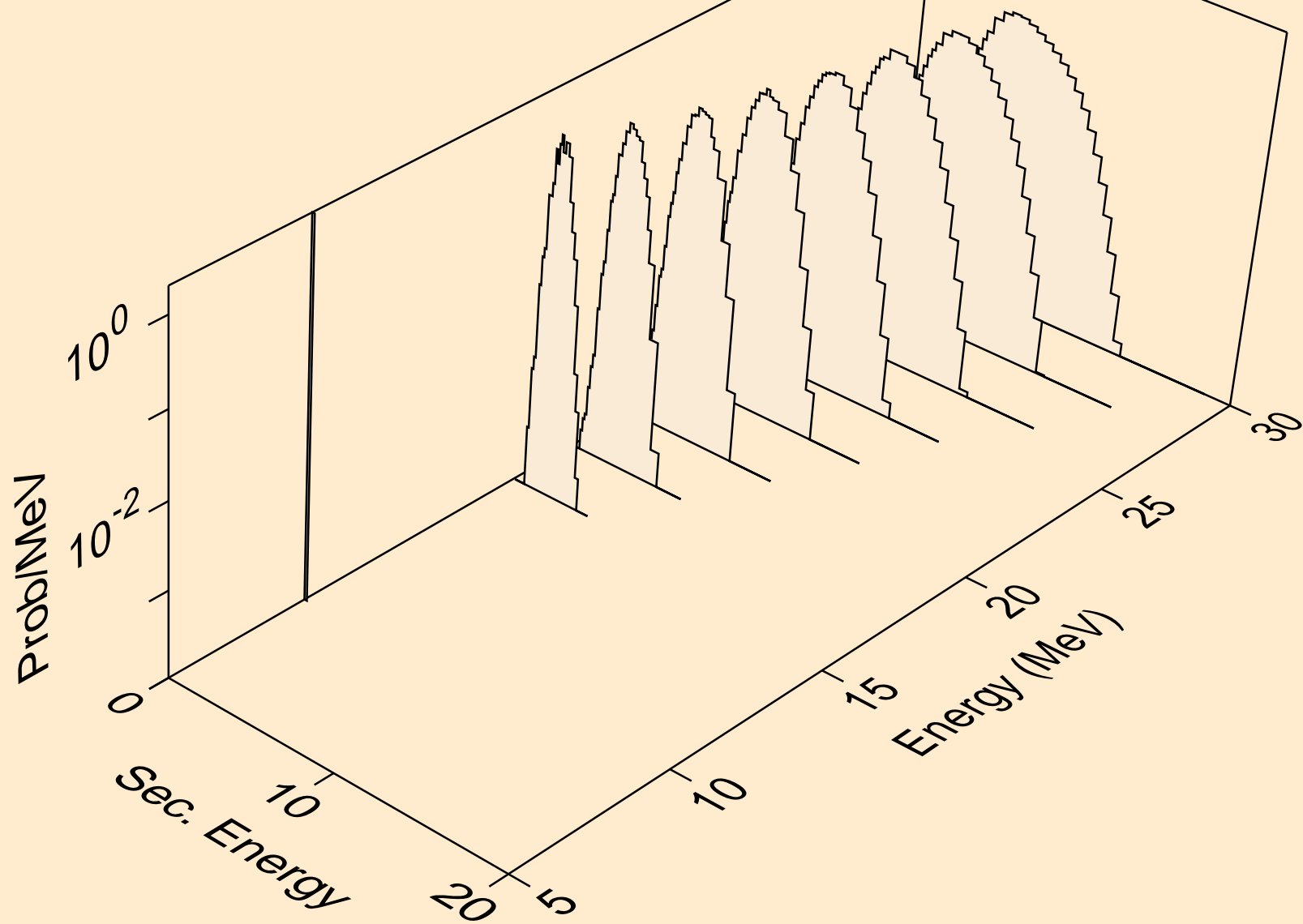

KR089 TRITON ACER TENDL-2021 LIBRARY; T=0.K  
protons from (t,p)

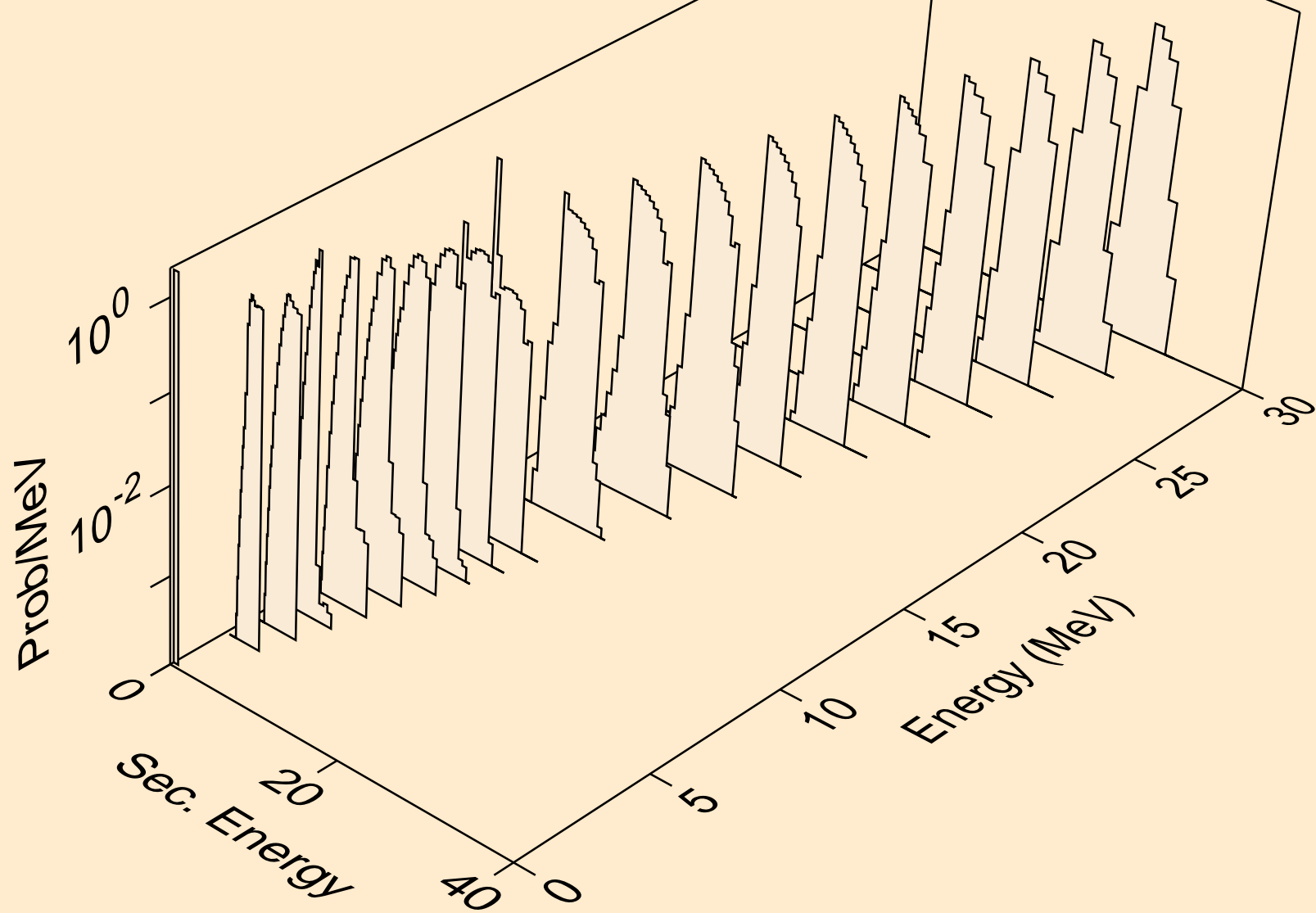

KR089 TRITON ACER TENDL-2021 LIBRARY; T=0.K  
protons from (t,2p)

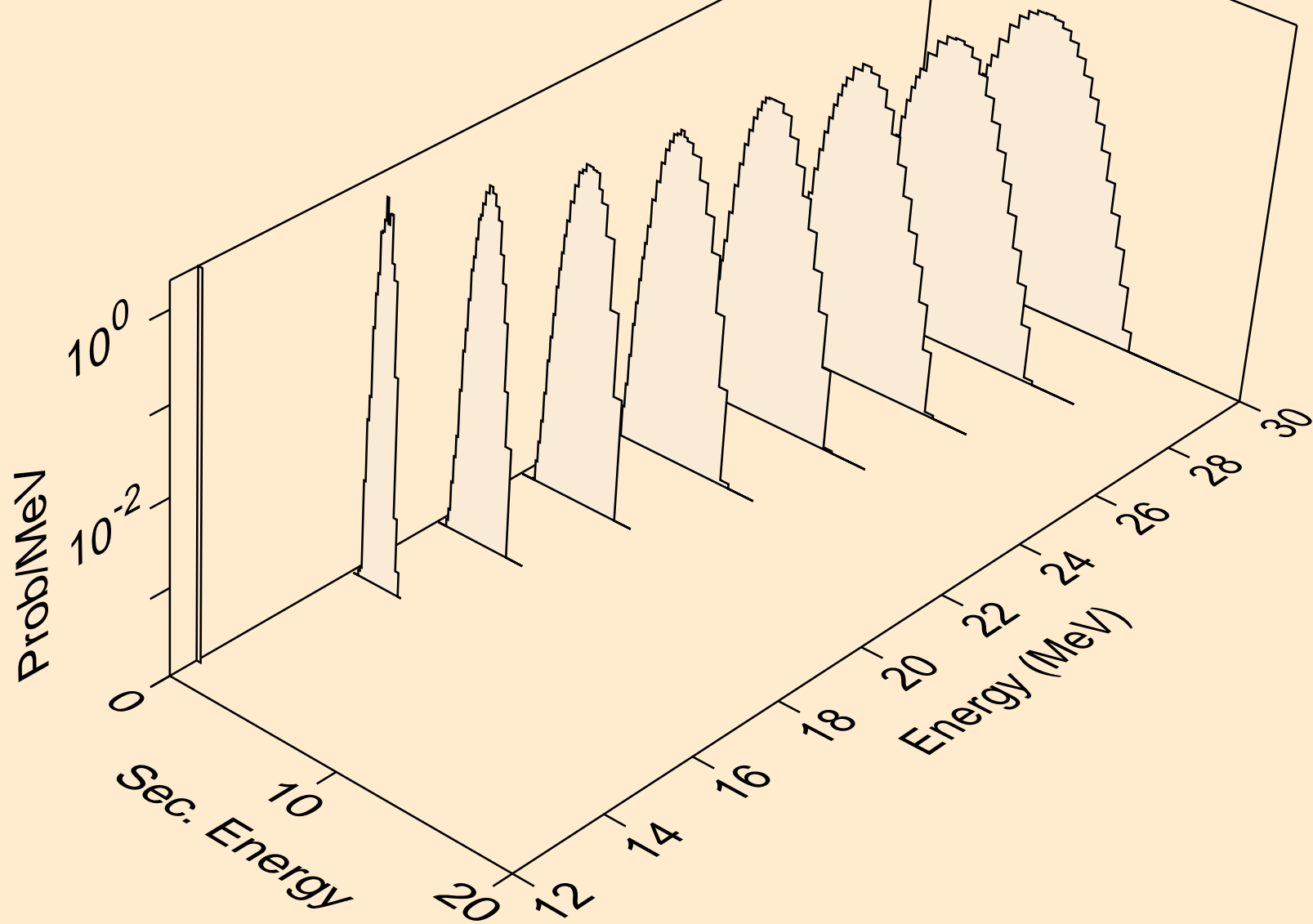



KR089 TRITON ACER TENDL-2021 LIBRARY; T=0.K  
protons from (t,pa)

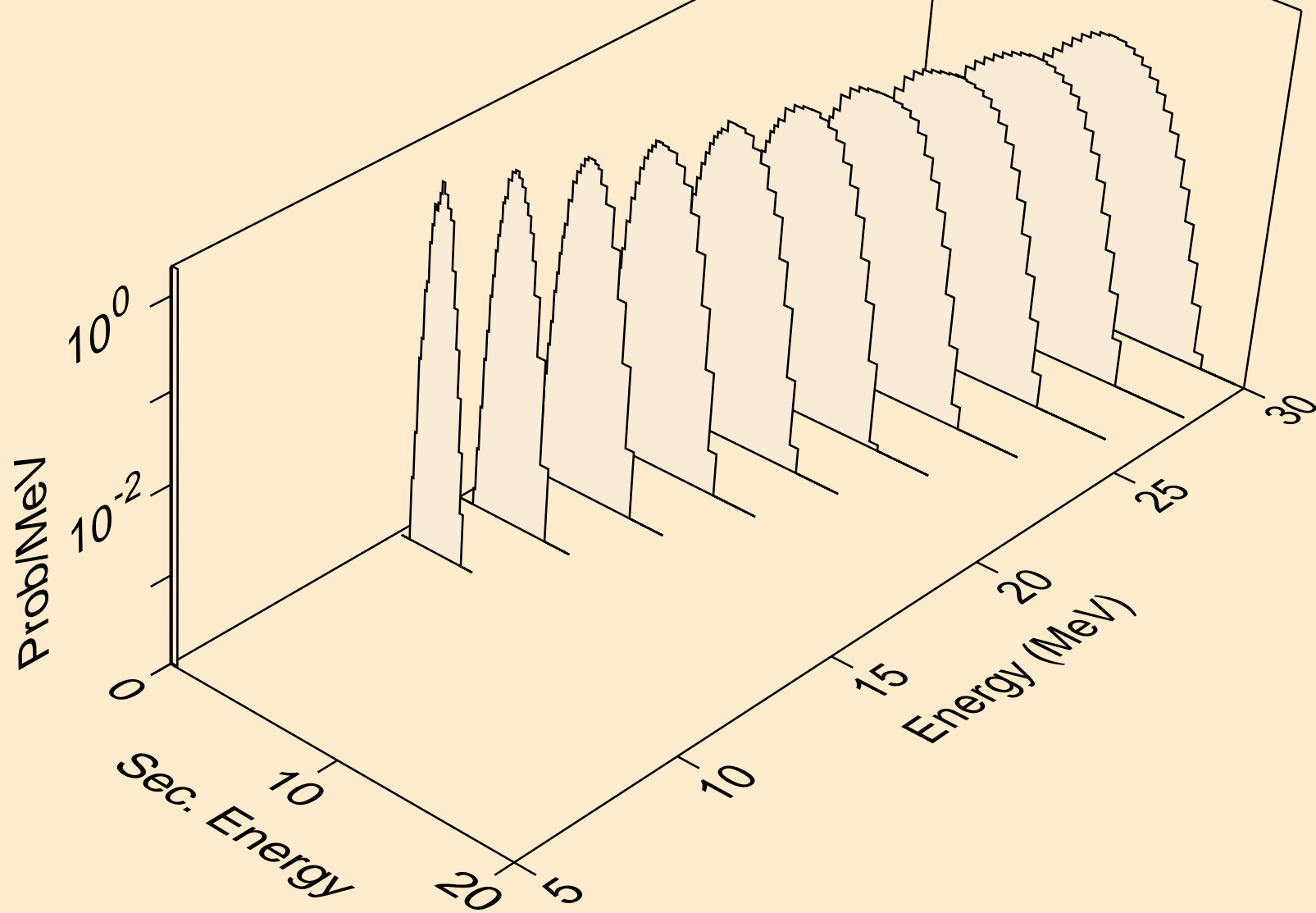

KR089 TRITON ACER TENDL-2021 LIBRARY; T=0.K  
protons from (t,pd)

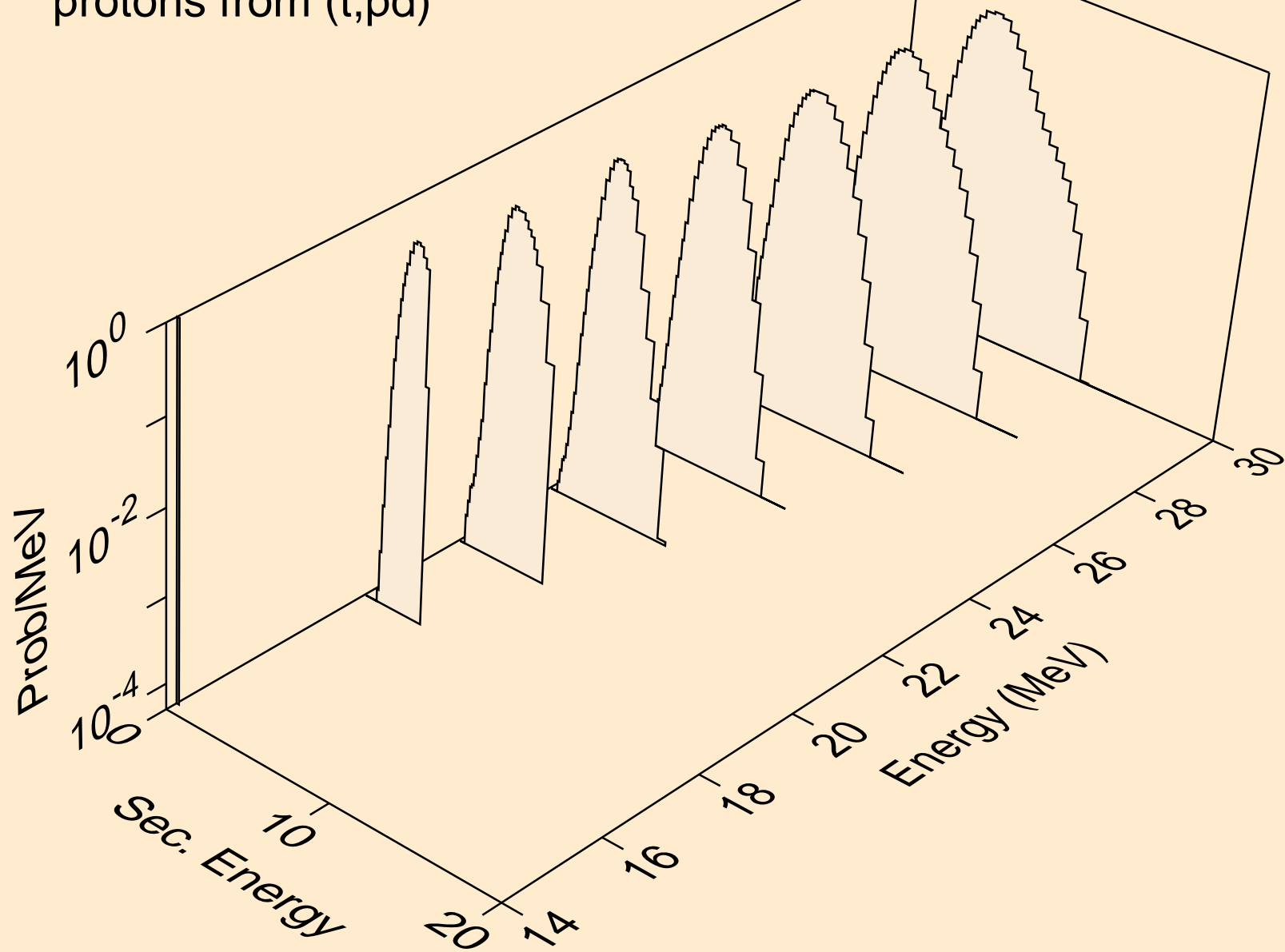

KR089 TRITON ACER TENDL-2021 LIBRARY; T=0.K  
protons from (t,pt)

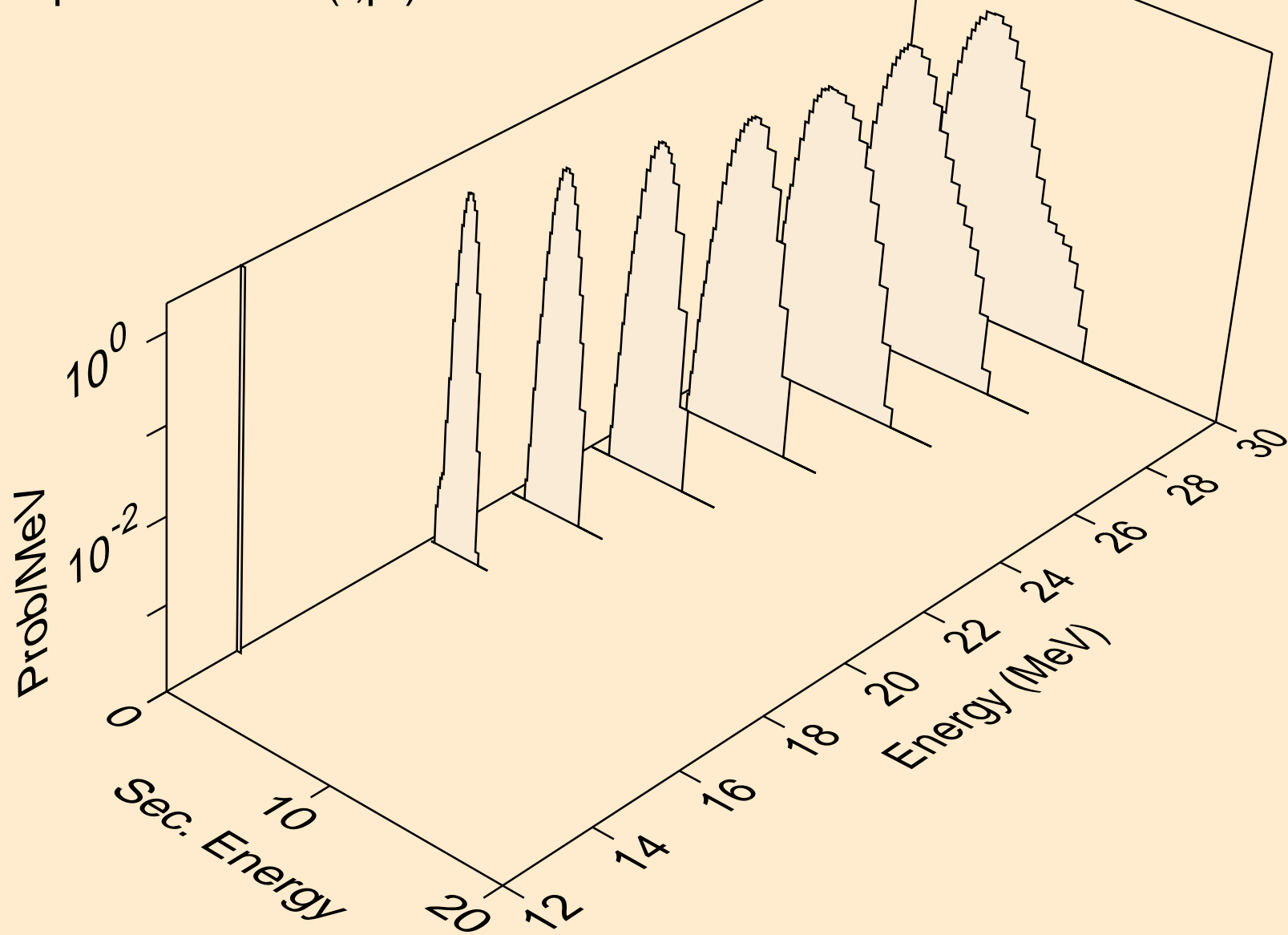

KR089 TRITON ACER TENDL-2021 LIBRARY; T=0.K  
deuterons from (t,x)

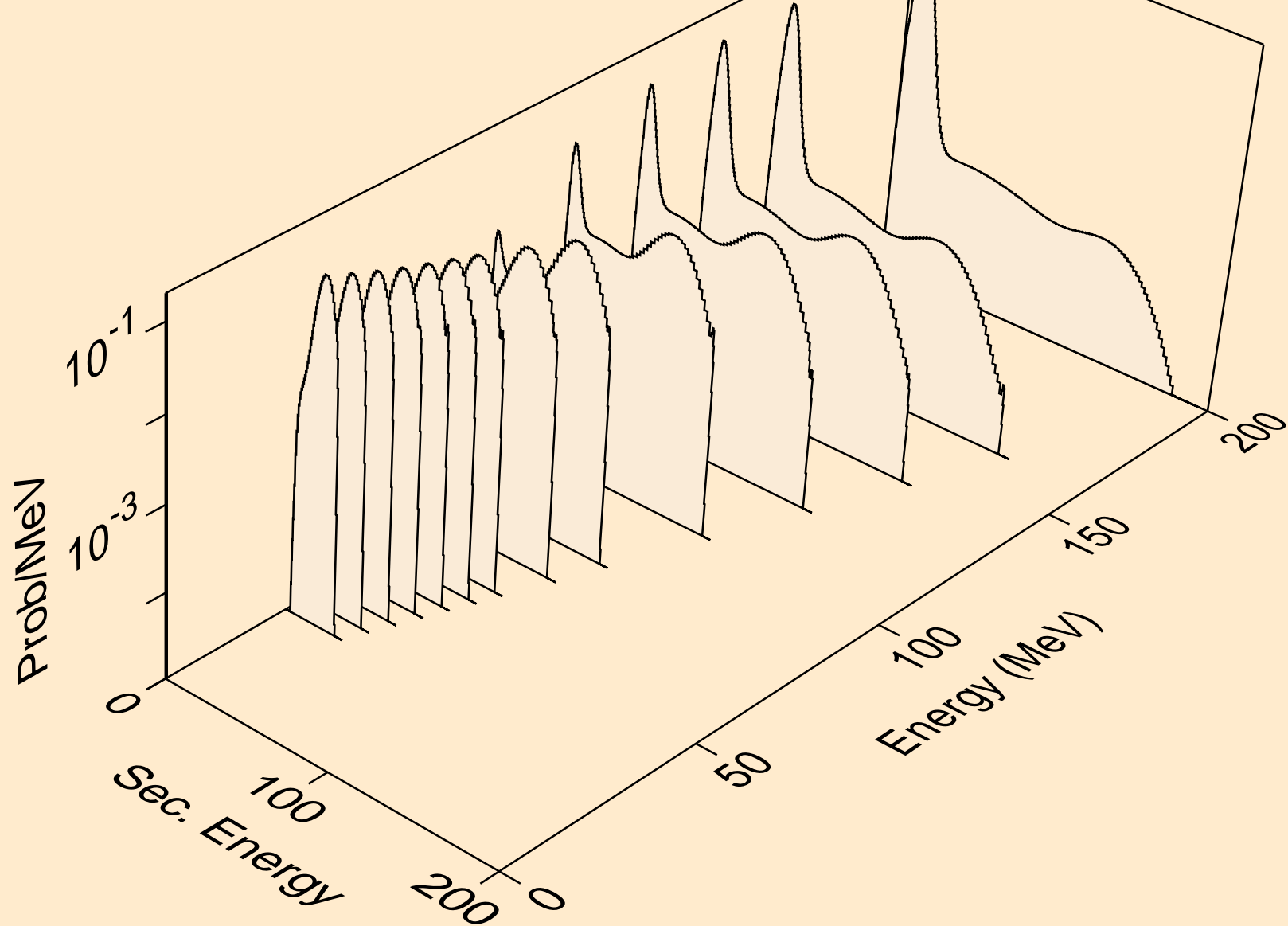

KR089 TRITON ACER TENDL-2021 LIBRARY; T=0.K  
deuterons from (t,2nd)

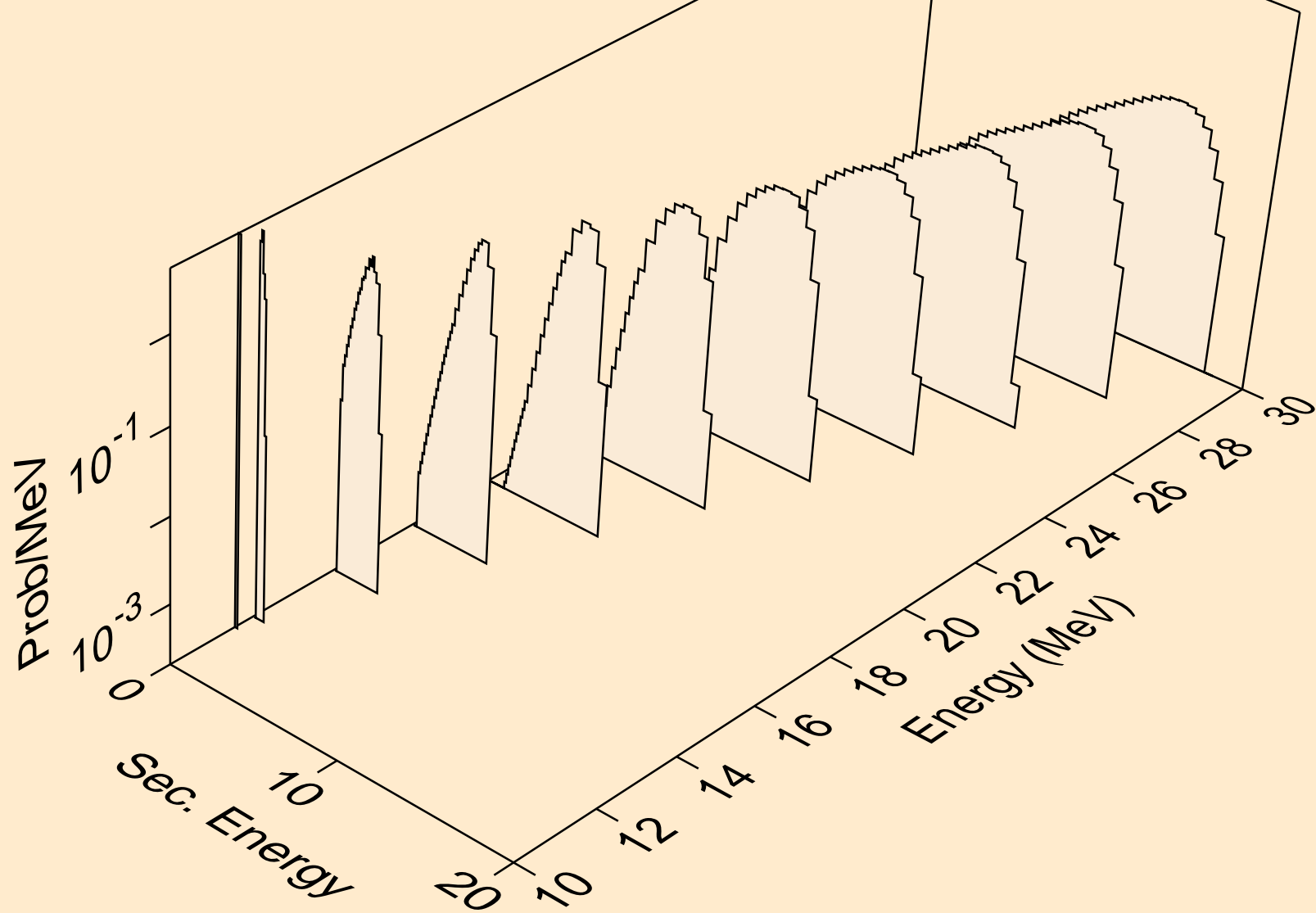

KR089 TRITON ACER TENDL-2021 LIBRARY; T=0.K  
deuterons from (t,n\*)d

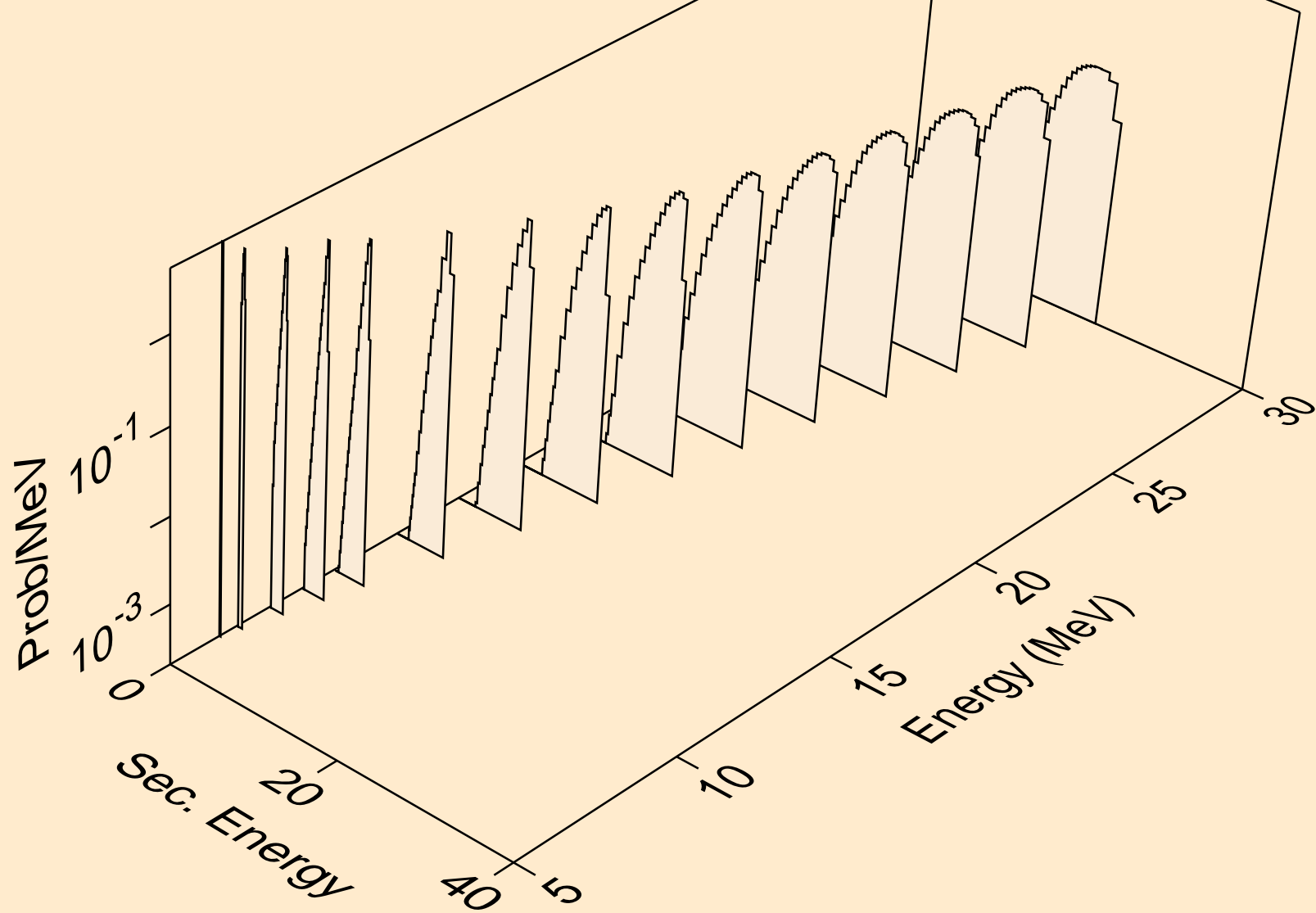

KR089 TRITON ACER TENDL-2021 LIBRARY; T=0.K  
deuterons from (t,d)

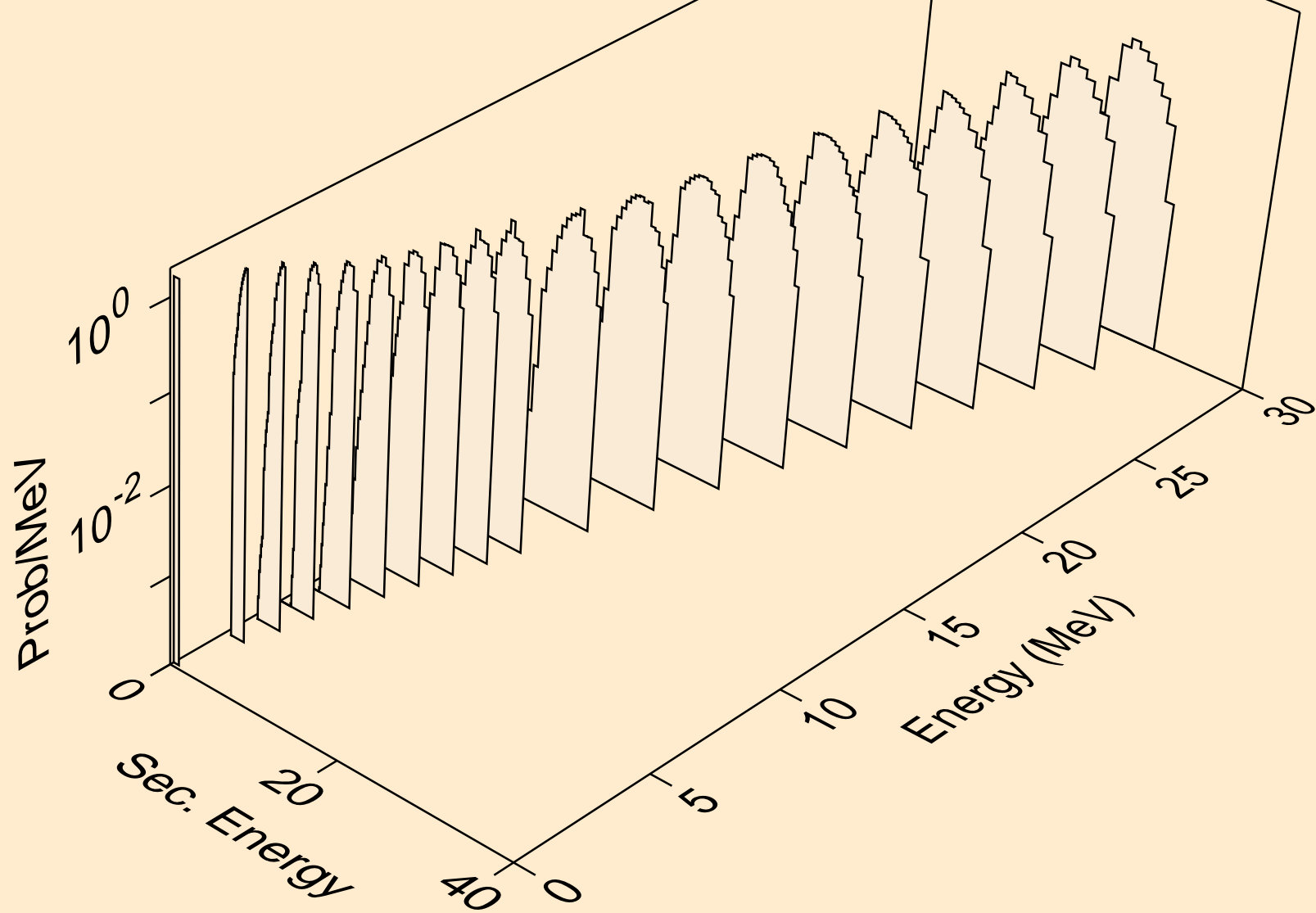

KR089 TRITON ACER TENDL-2021 LIBRARY; T=0.K  
deuterons from (t,pd)

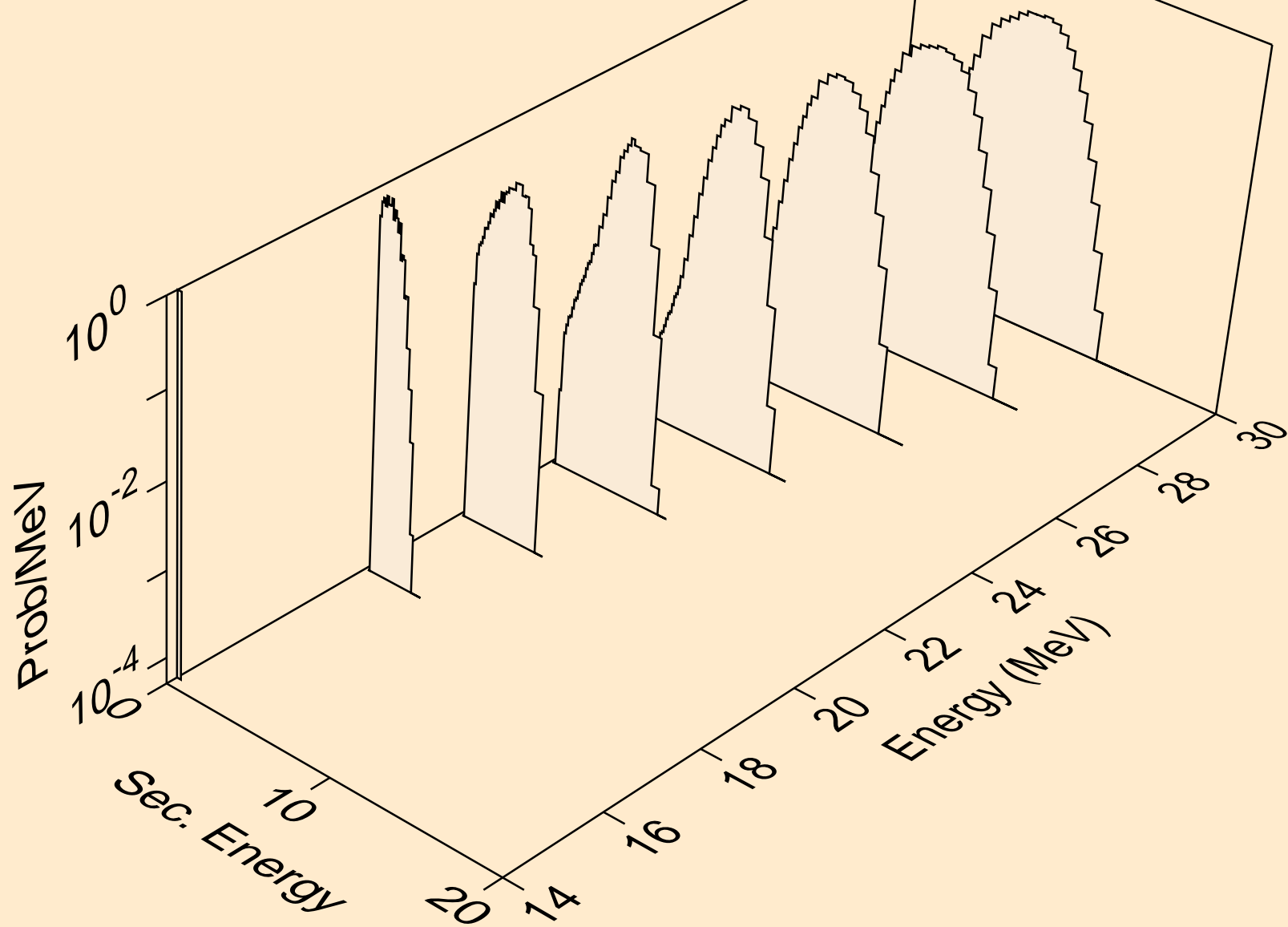



KR089 TRITON ACER TENDL-2021 LIBRARY; T=0.K  
deuterons from (t,da)

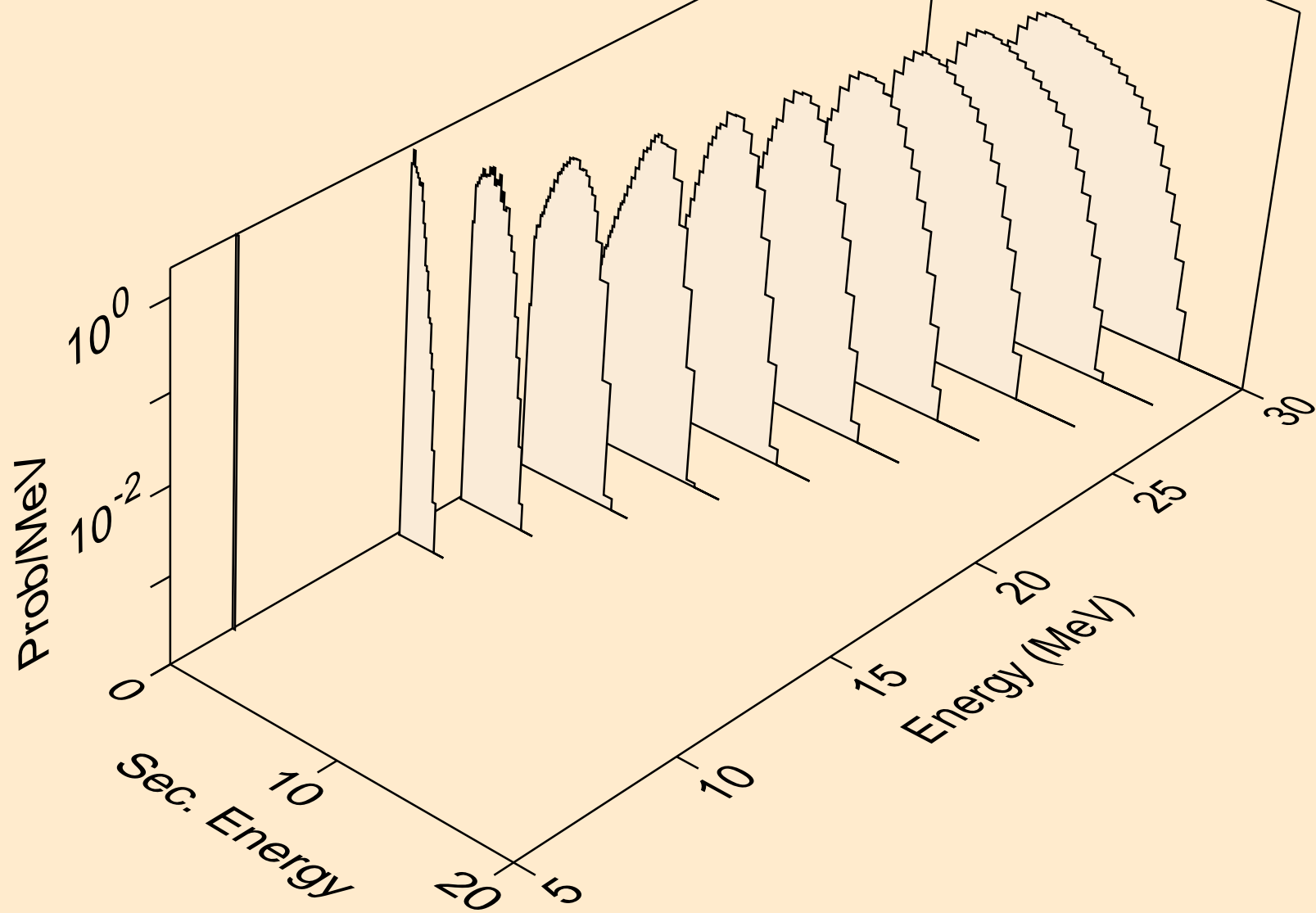

KR089 TRITON ACER TENDL-2021 LIBRARY; T=0.K  
he3s from (t,x)

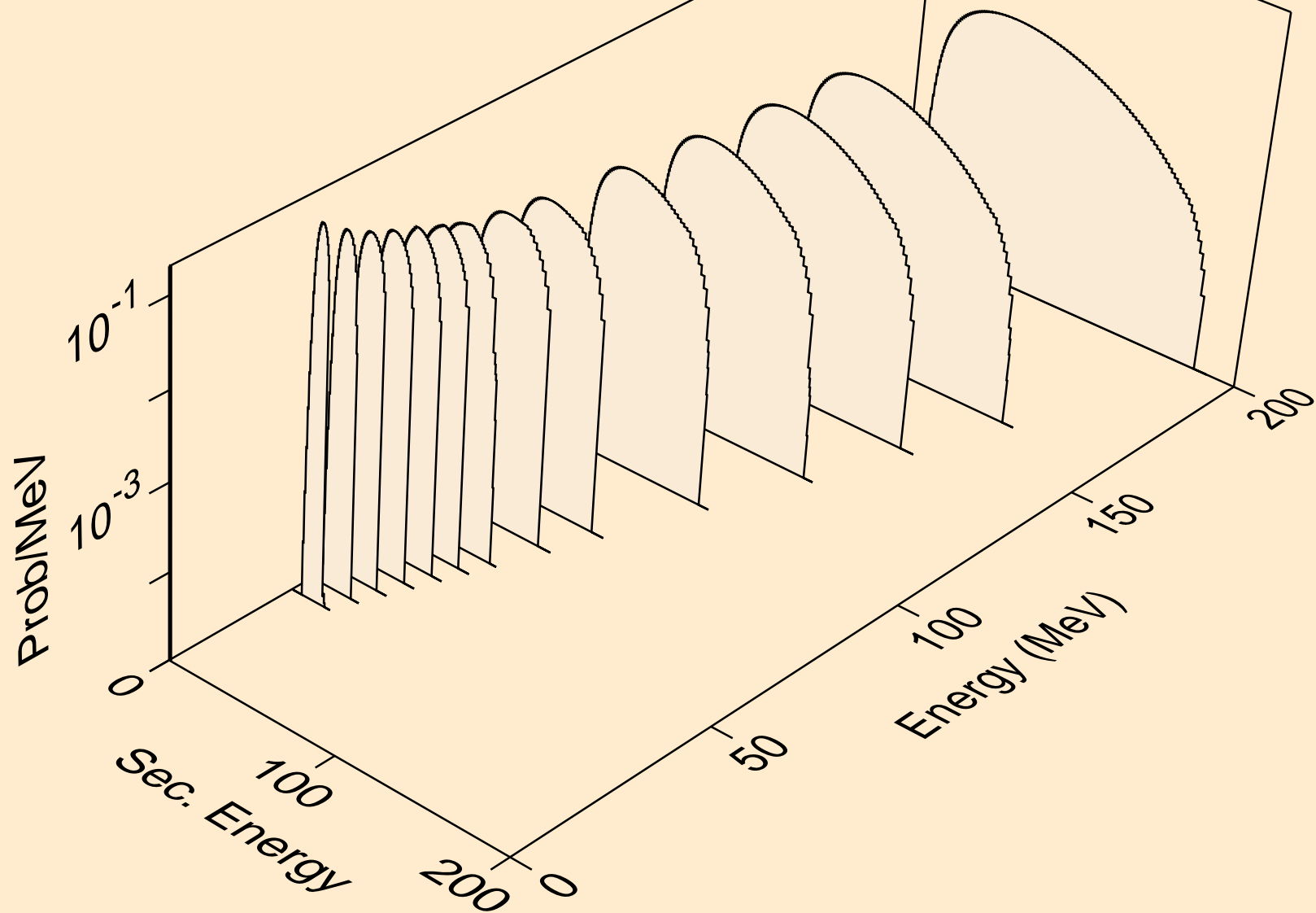

KR089 TRITON ACER TENDL-2021 LIBRARY; T=0.K  
he3s from (t,n\*)he3

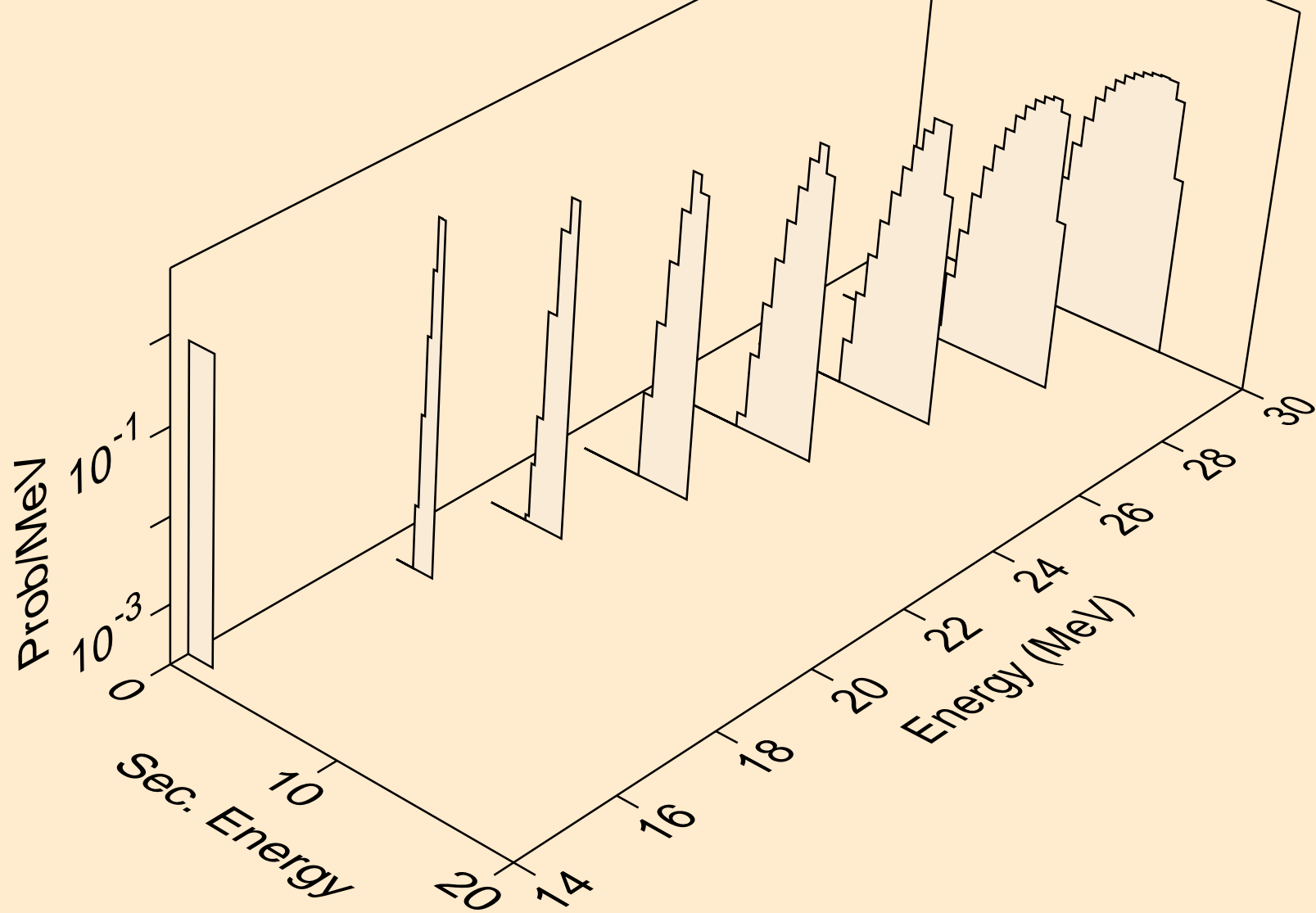

KR089 TRITON ACER TENDL-2021 LIBRARY; T=0.K  
he3s from (t,he3)

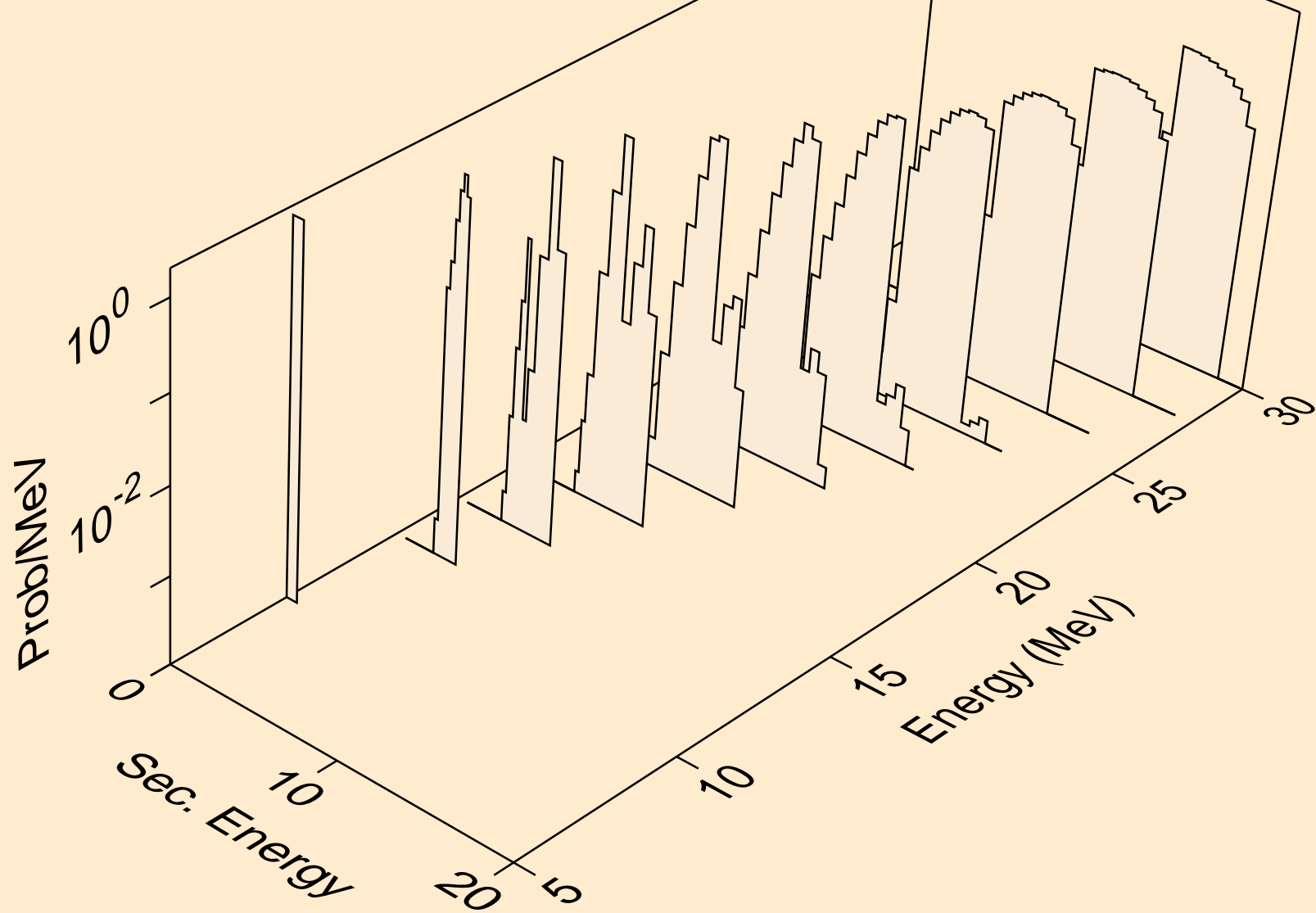

KR089 TRITON ACER TENDL-2021 LIBRARY; T=0.K  
alphas from (t,x)

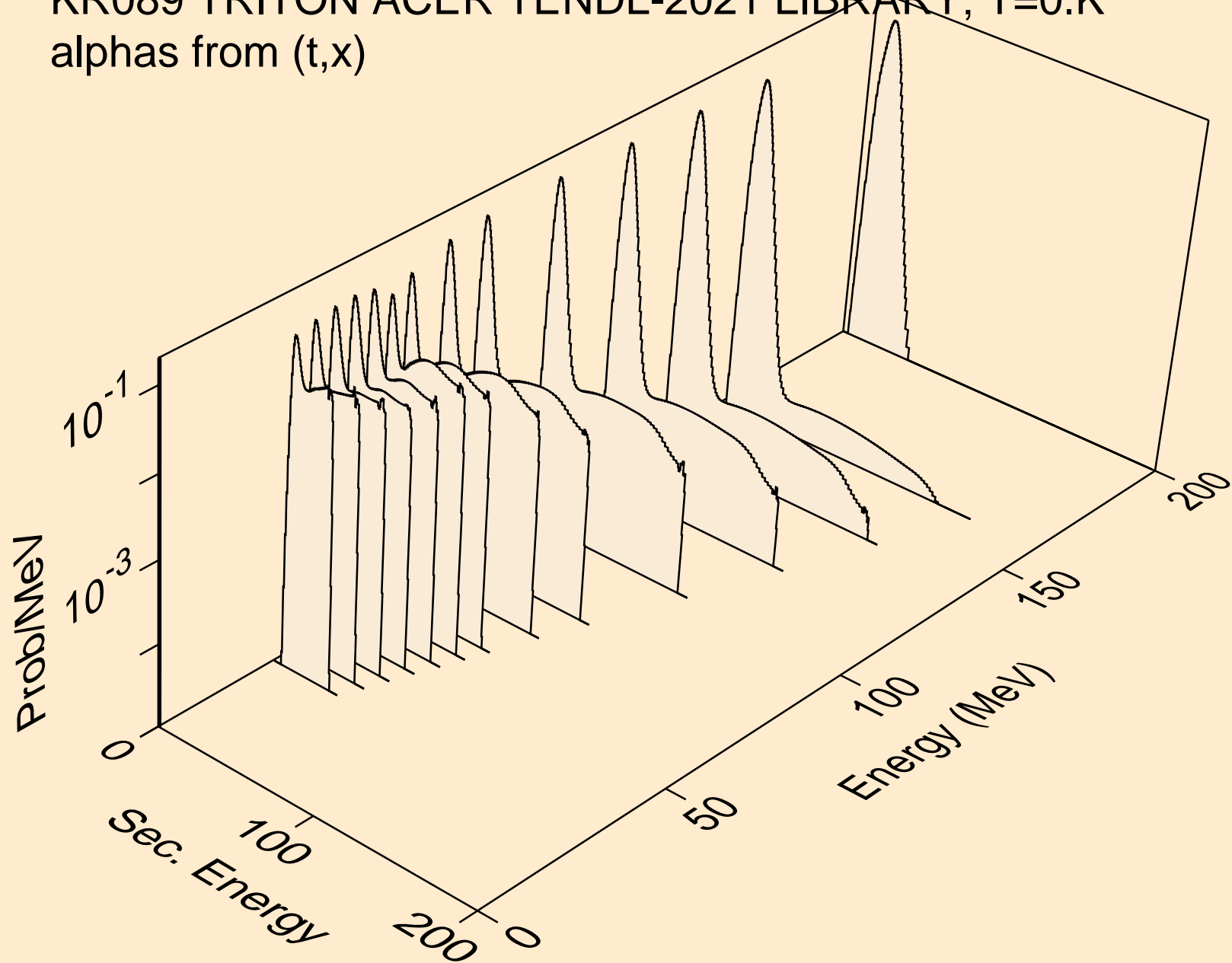

KR089 TRITON ACER TENDL-2021 LIBRARY; T=0.K  
alphas from (t,n\*)a

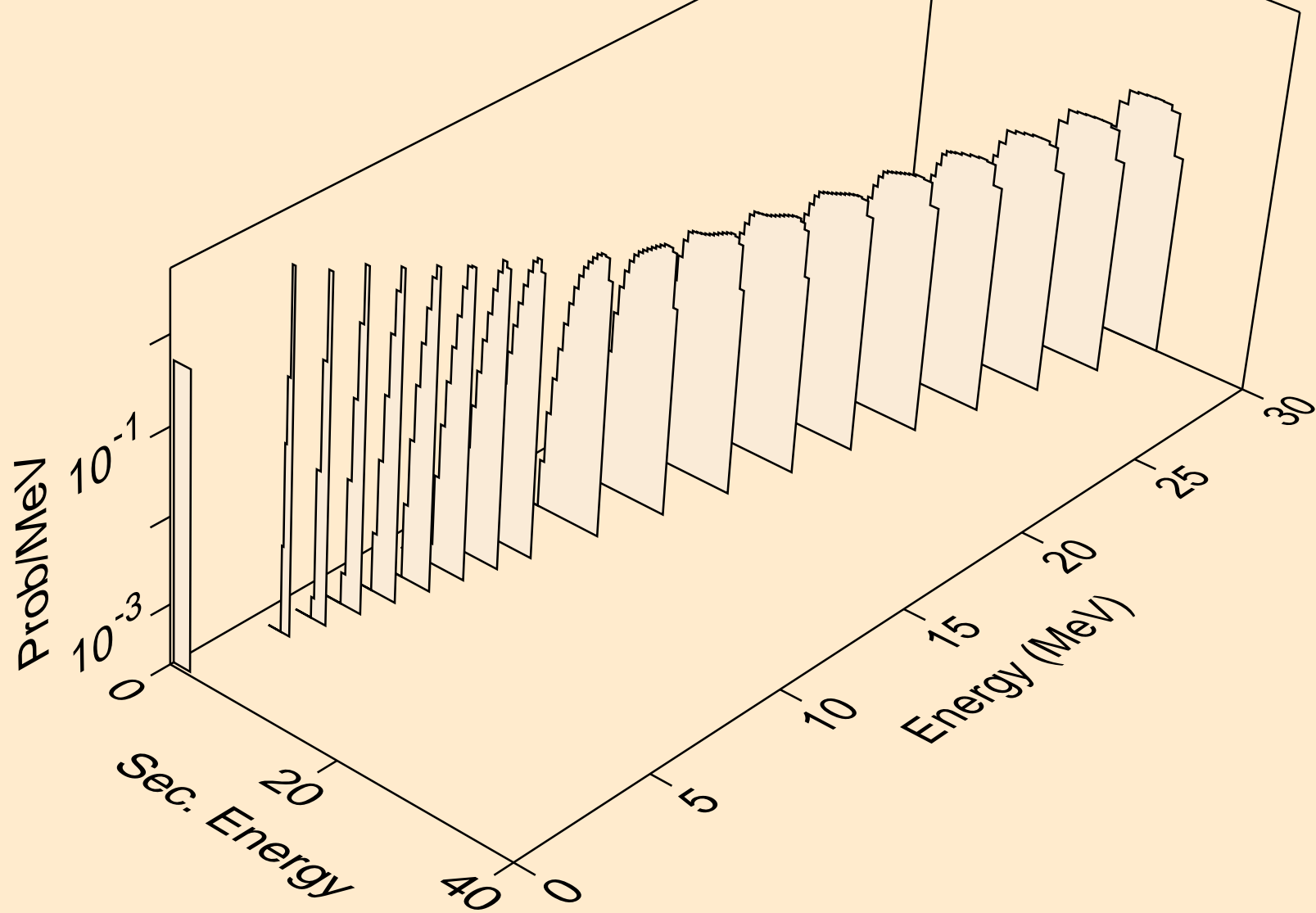

KR089 TRITON ACER TENDL-2021 LIBRARY; T=0.K  
alphas from (t,2n)a

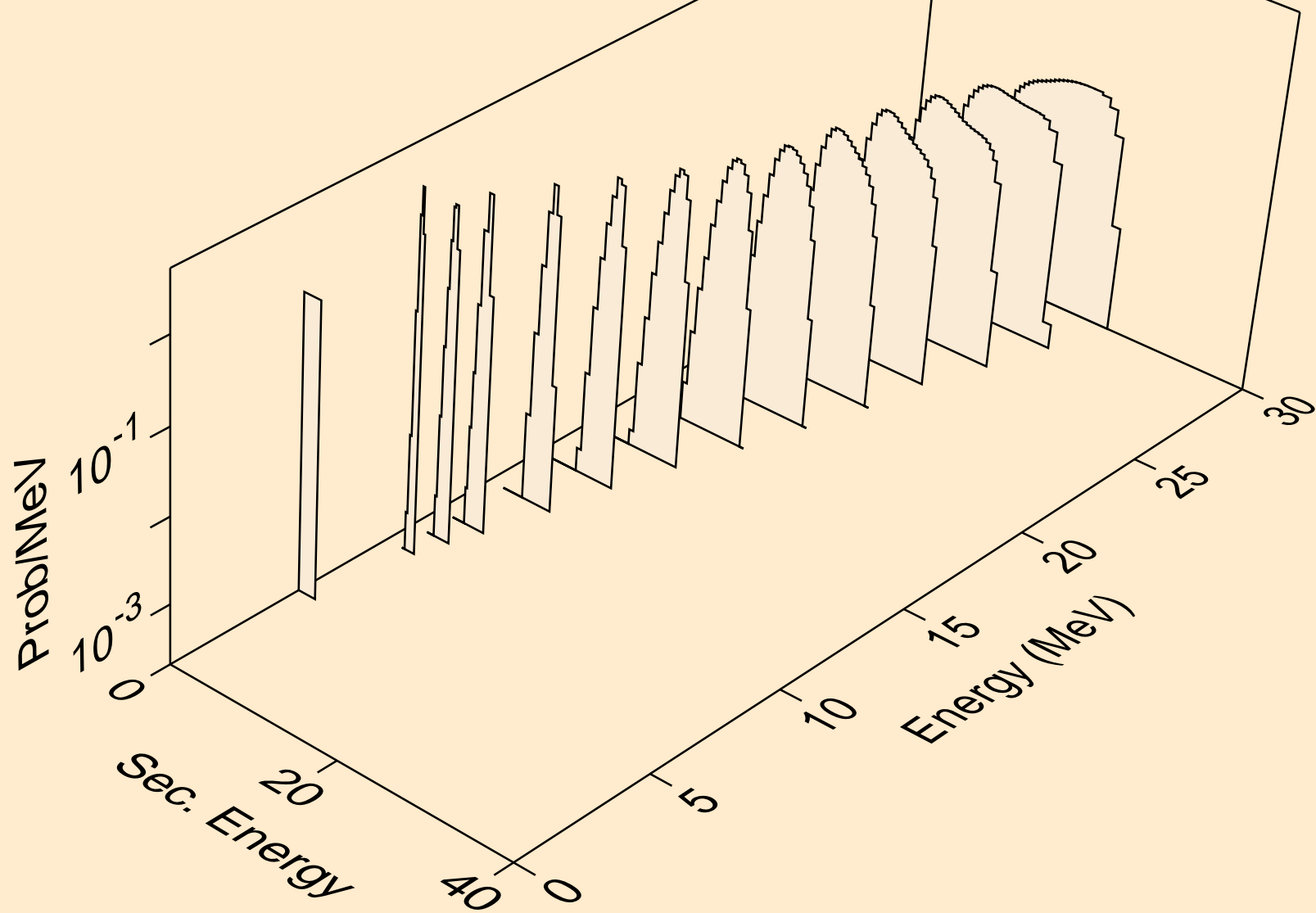

KR089 TRITON ACER TENDL-2021 LIBRARY; T=0.K  
alphas from (t,3n)a

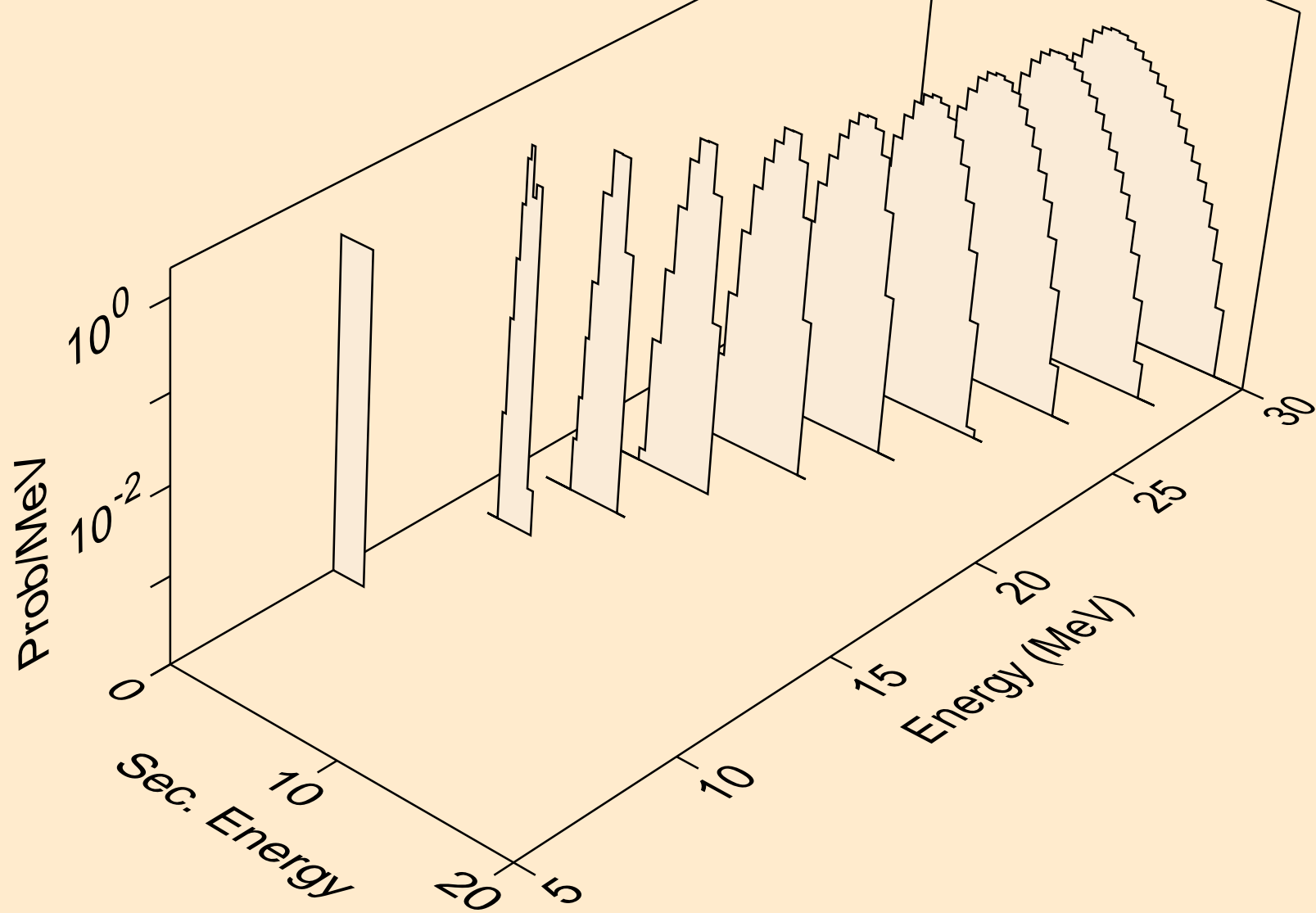



KR089 TRITON ACER TENDL-2021 LIBRARY; T=0.K  
alphas from (t,n\*)2a

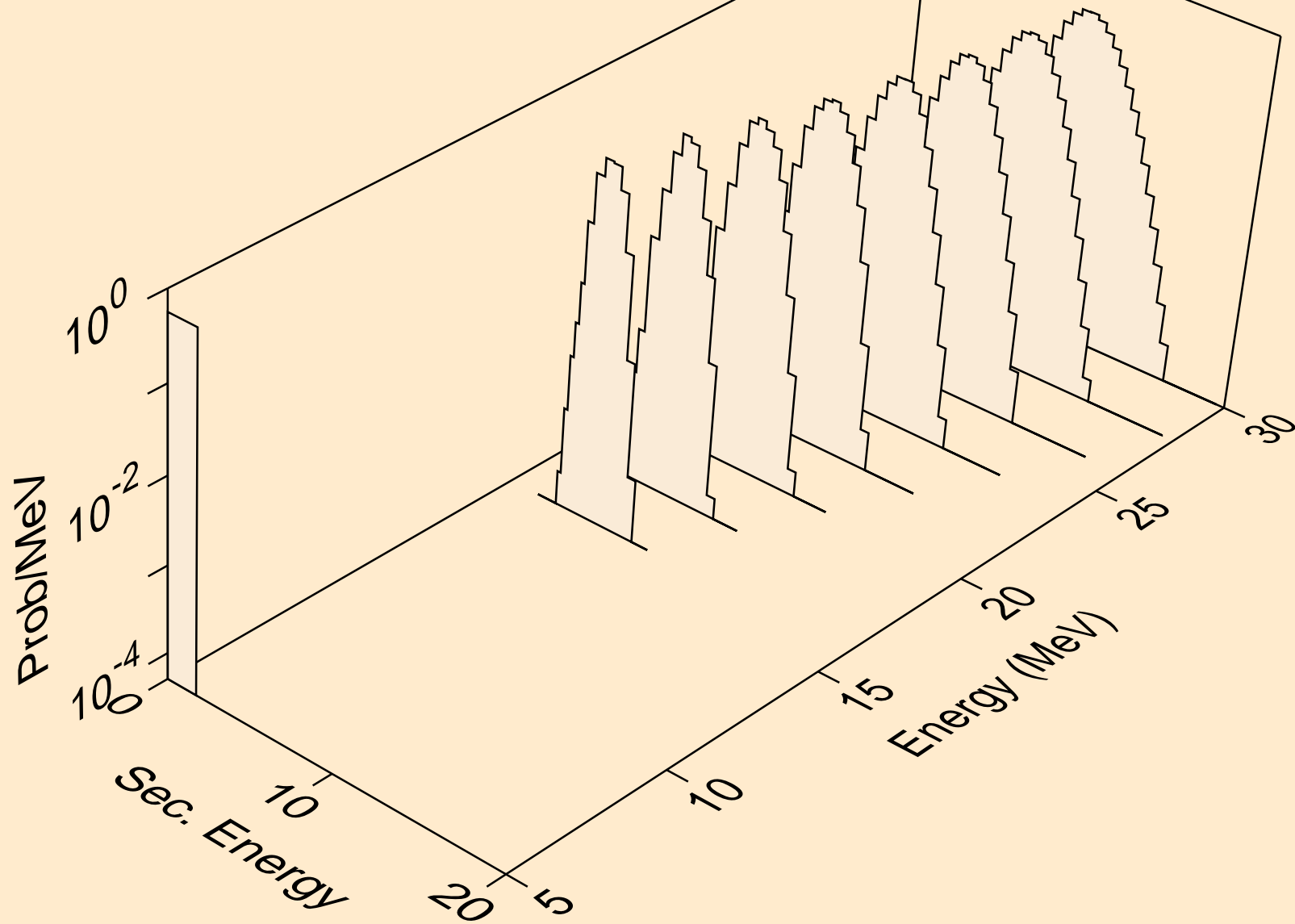

KR089 TRITON ACER TENDL-2021 LIBRARY; T=0.K  
alphas from (t,npa)

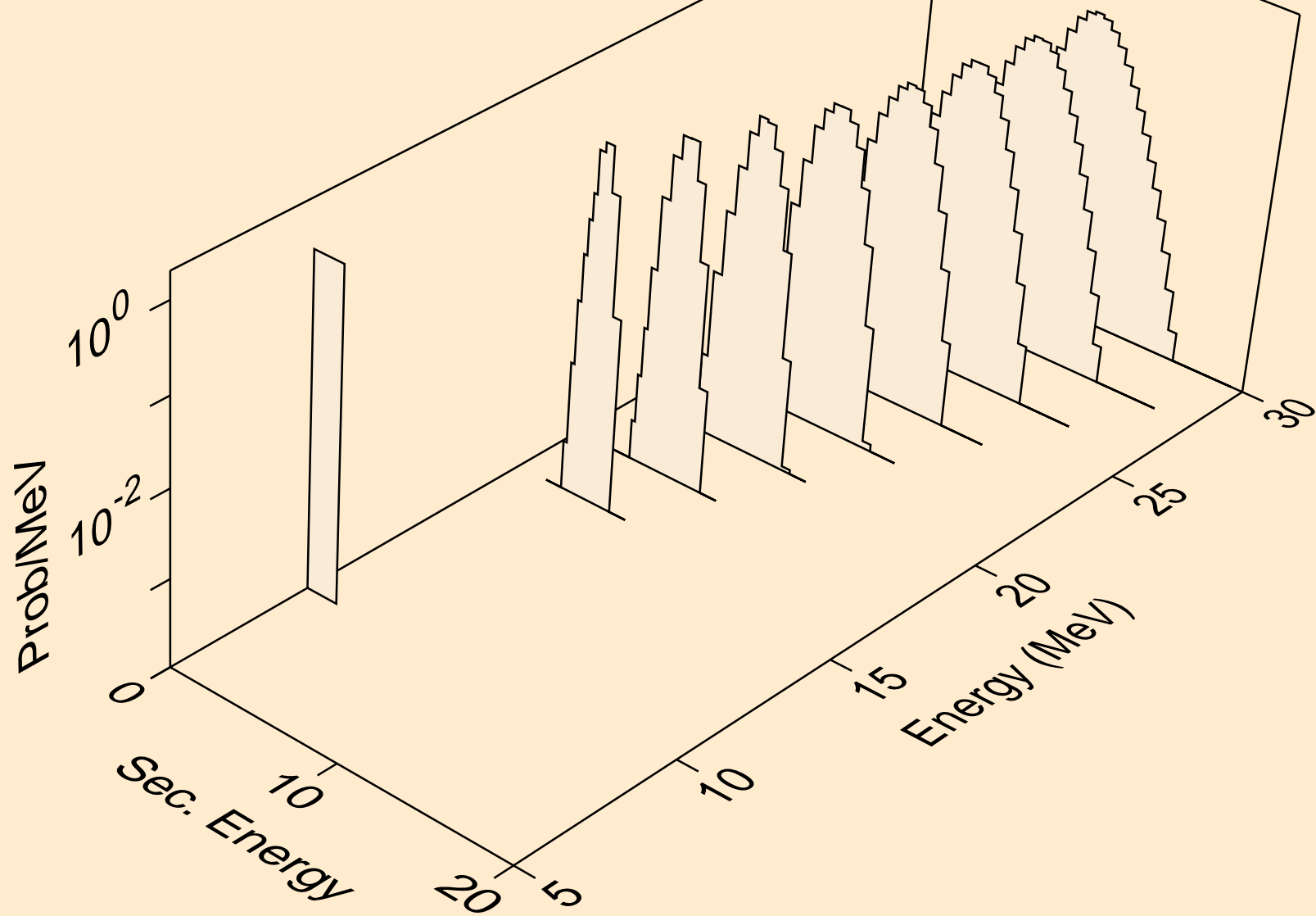

KR089 TRITON ACER TENDL-2021 LIBRARY; T=0.K  
alphas from (t,a)

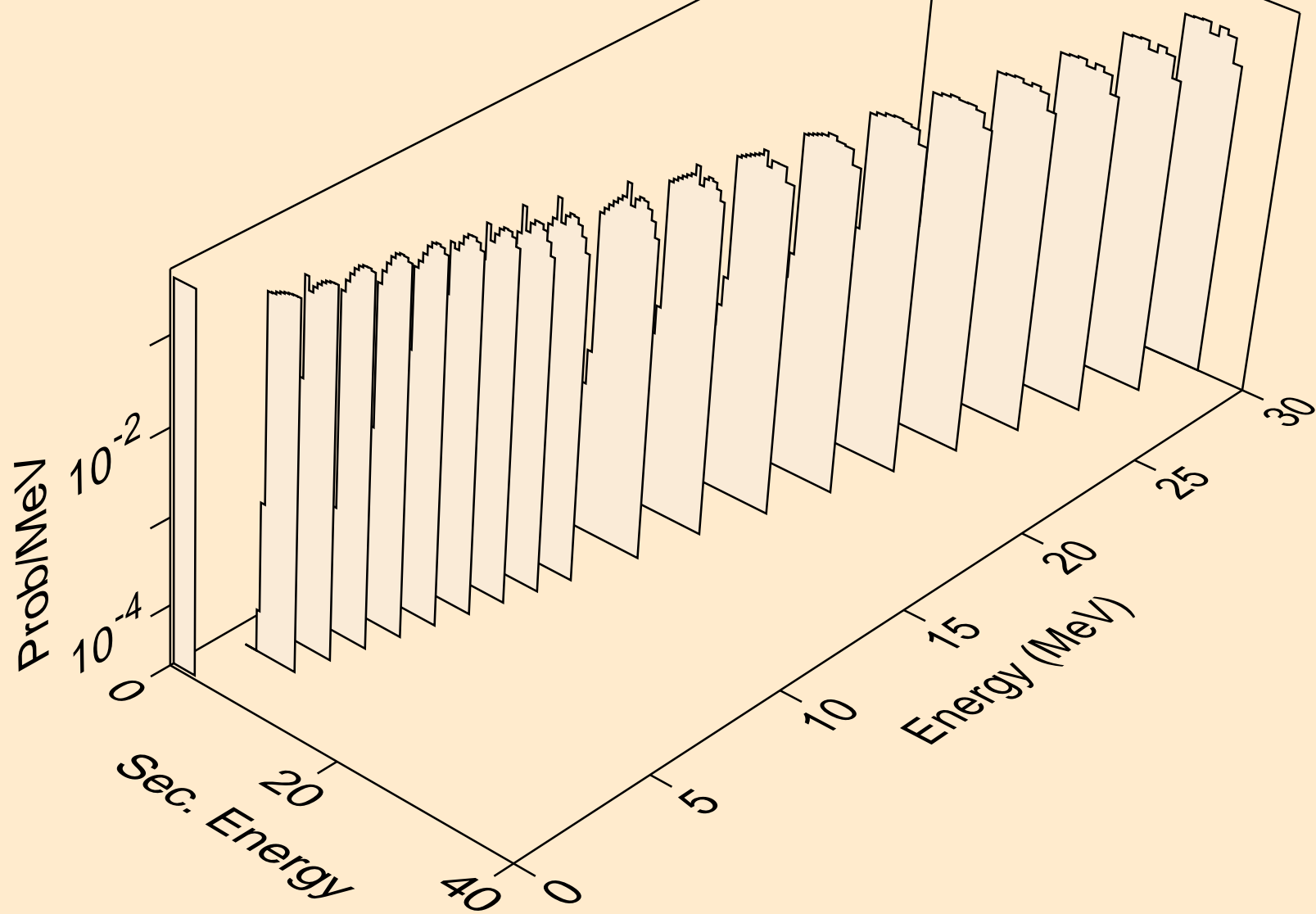

KR089 TRITON ACER TENDL-2021 LIBRARY; T=0.K  
alphas from (t,2a)

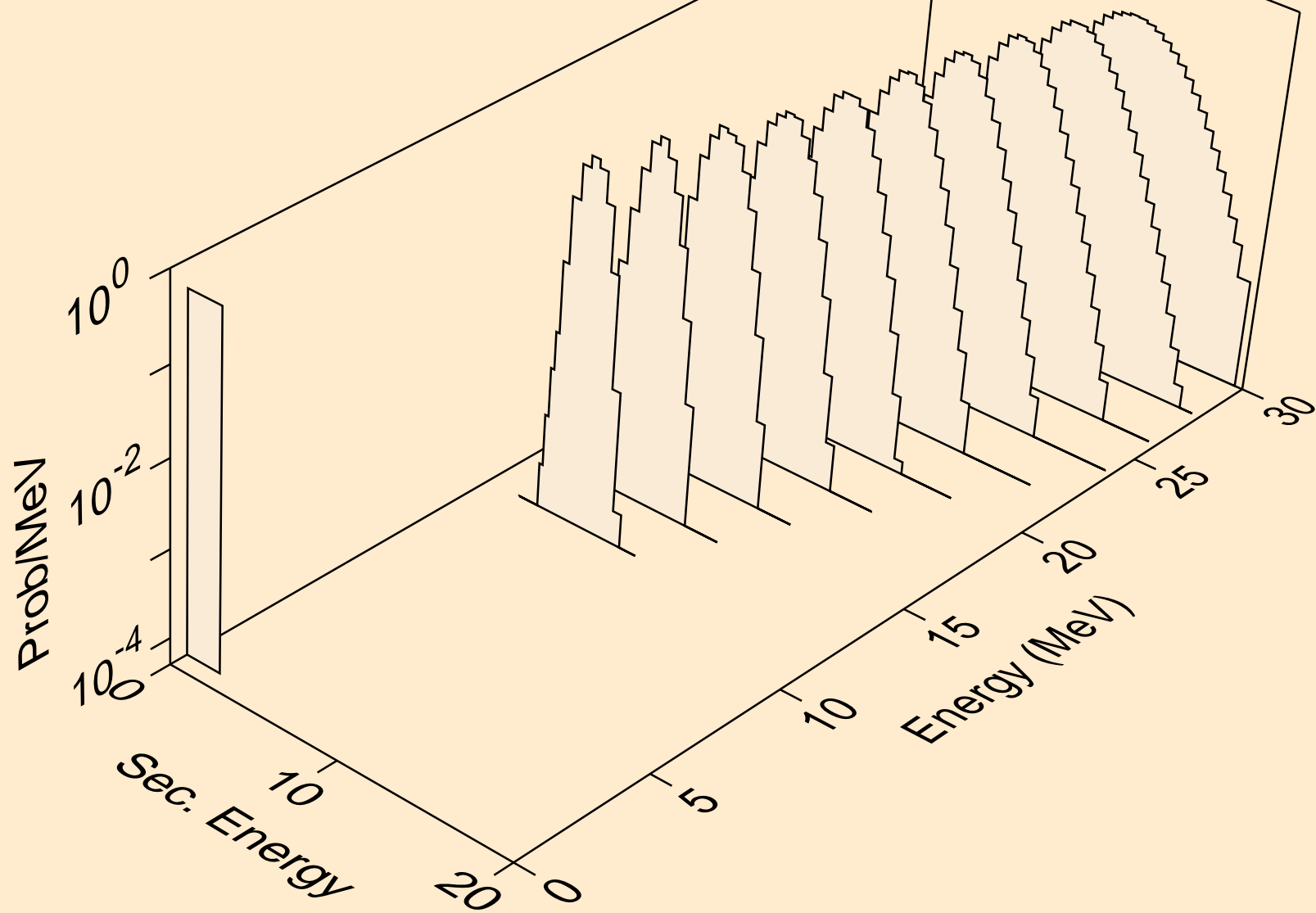

KR089 TRITON ACER TENDL-2021 LIBRARY; T=0.K  
alphas from (t,pa)

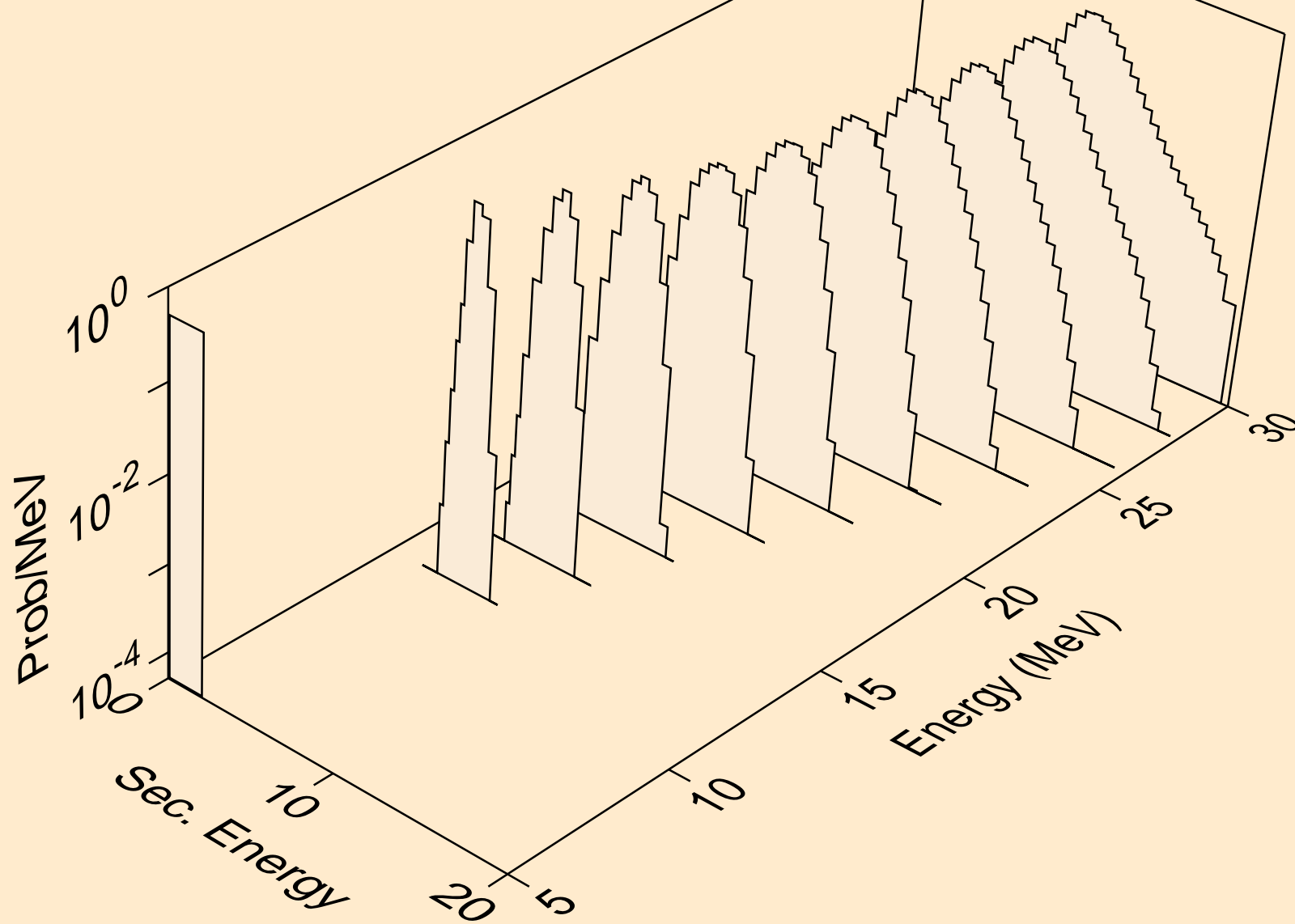

KR089 TRITON ACER TENDL-2021 LIBRARY; T=0.K  
alphas from (t,da)

