

LA141 TRITON ACER TENDL-2021 LIBRARY; T=0.K  
Principal cross sections

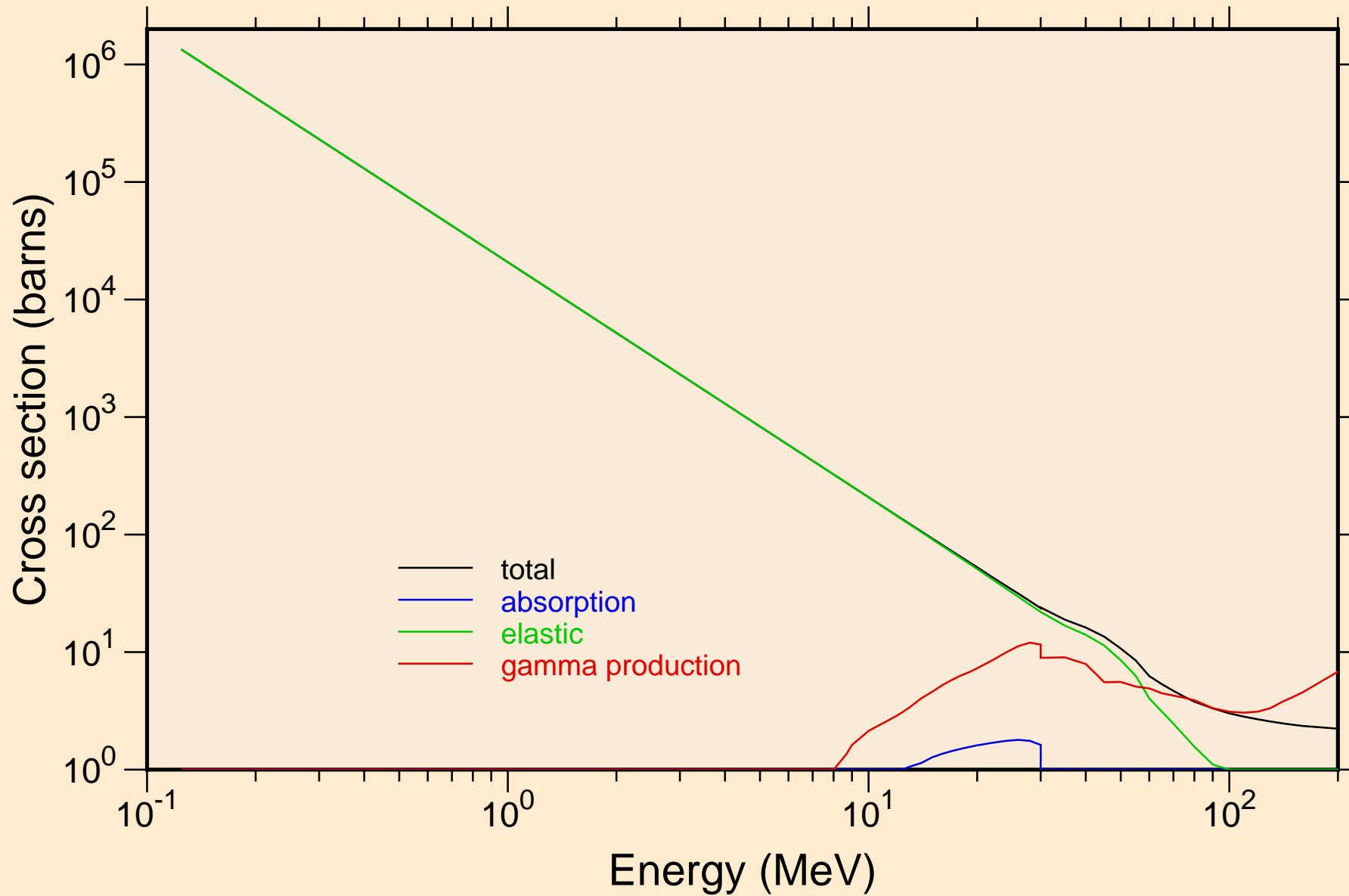

LA141 TRITON ACER TENDL-2021 LIBRARY; T=0.K

Heating

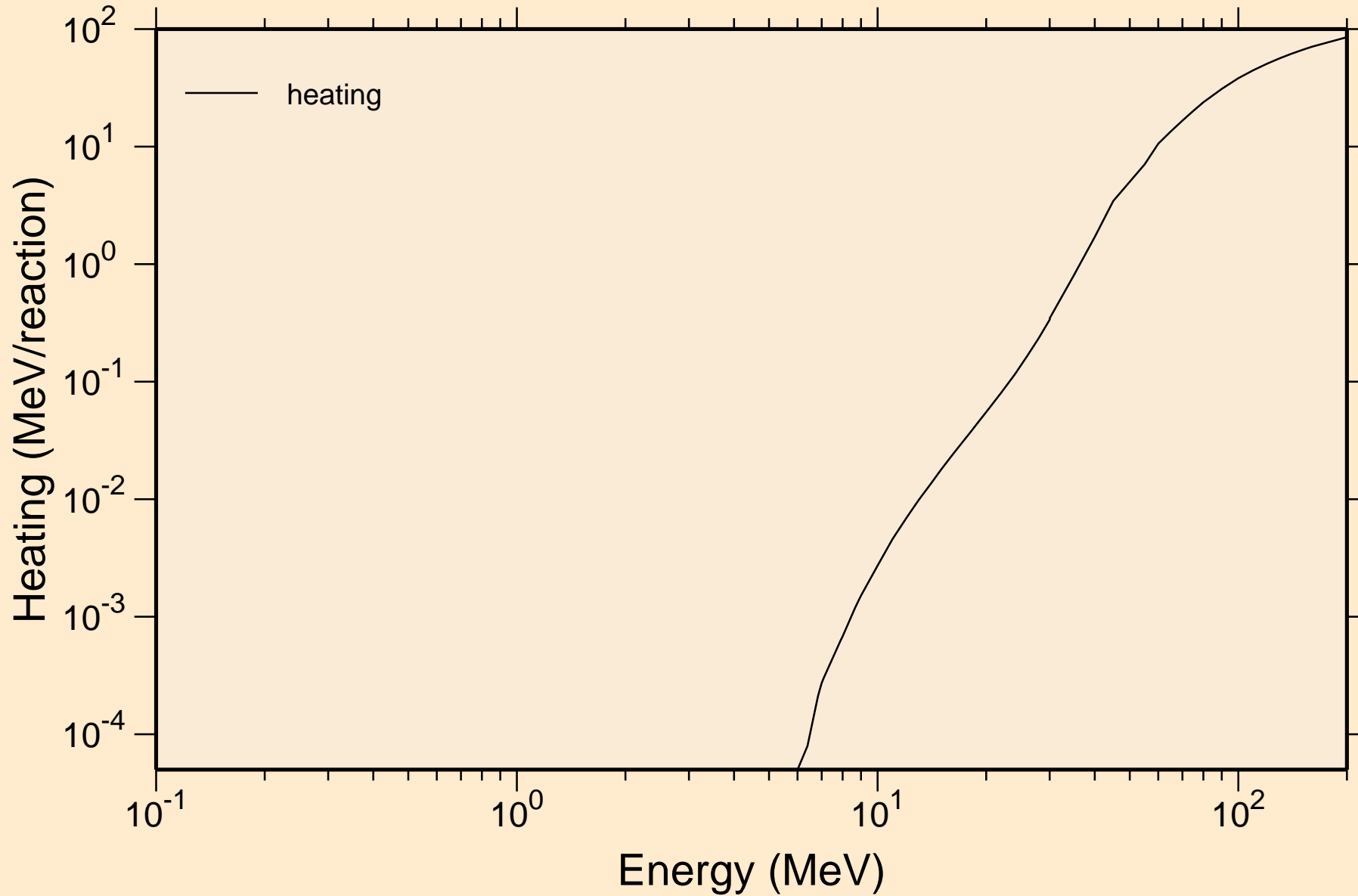

# LA141 TRITON ACER TENDL-2021 LIBRARY; T=0.K

## Principal cross sections

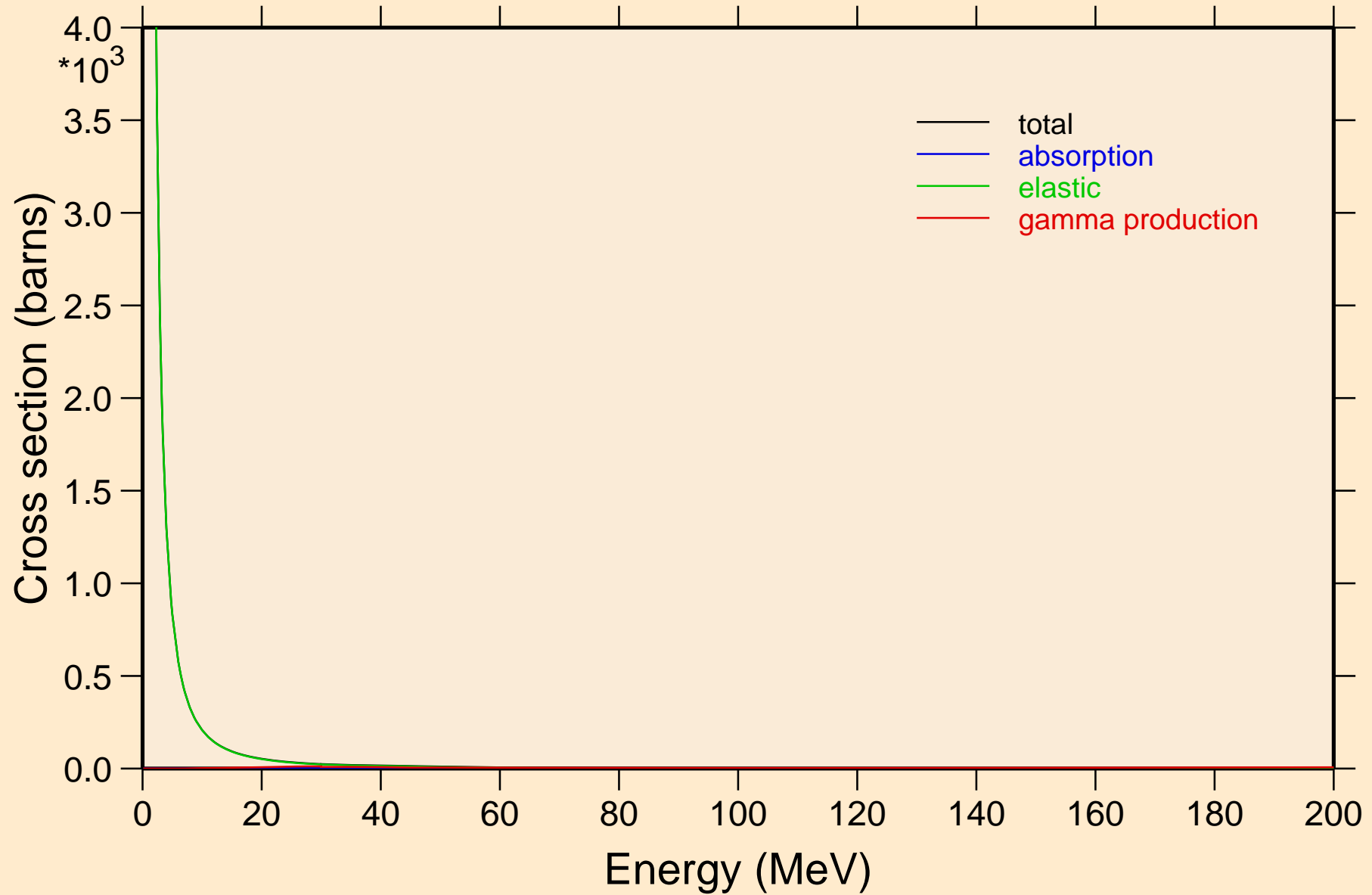

LA141 TRITON ACER TENDL-2021 LIBRARY; T=0.K

Heating

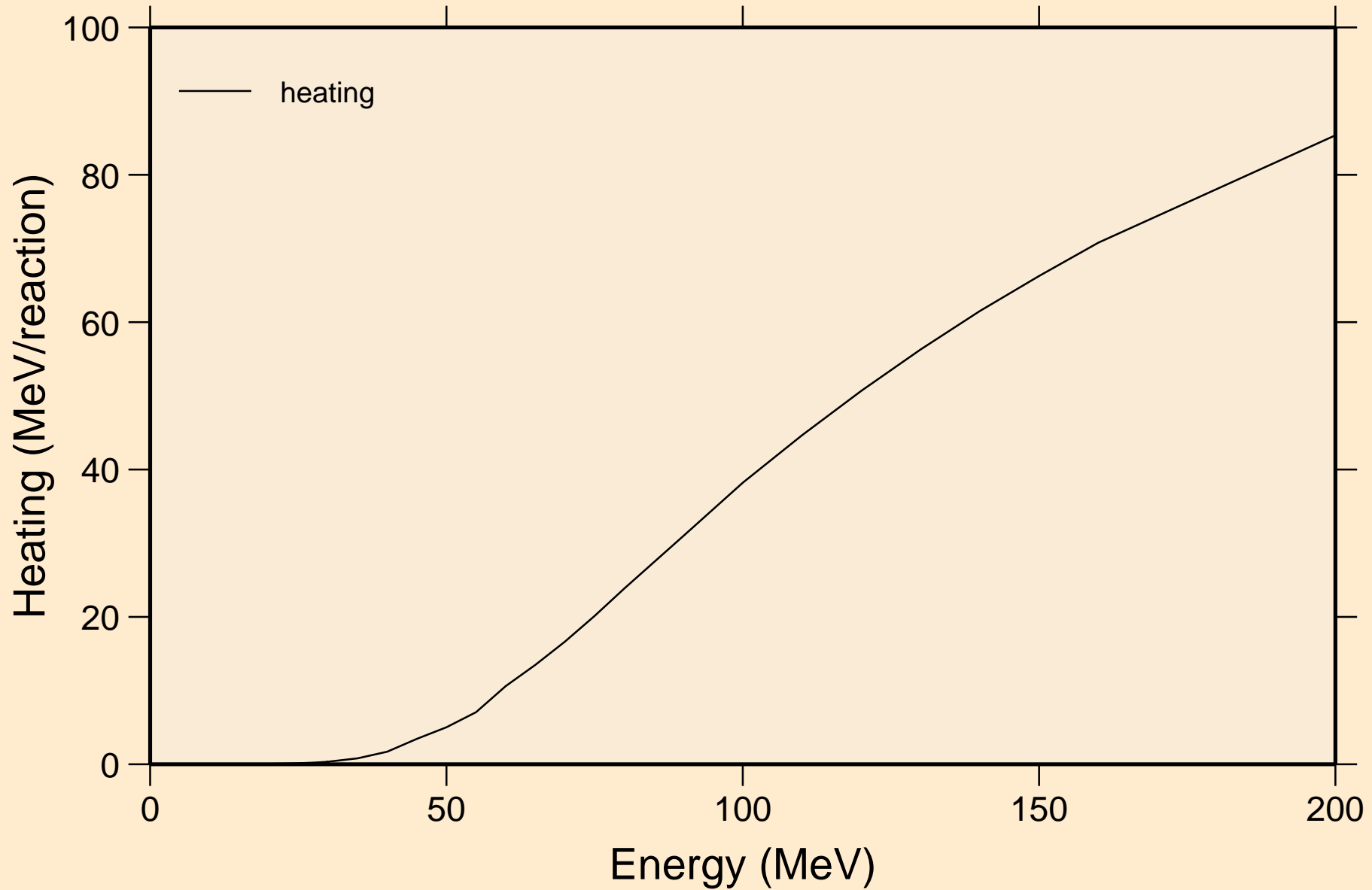

LA141 TRITON ACER TENDL-2021 LIBRARY; T=0.K  
Threshold reactions

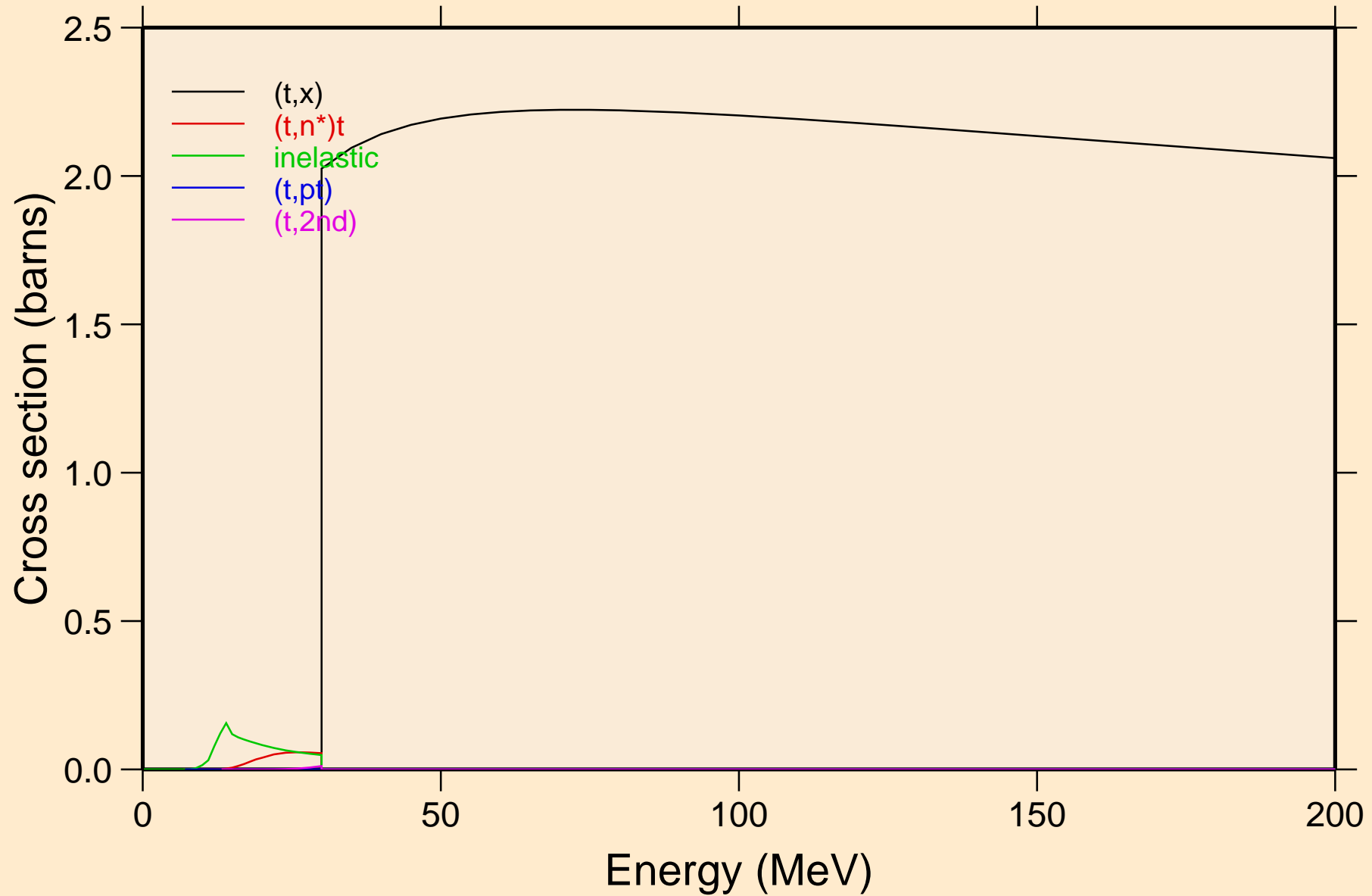

LA141 TRITON ACER TENDL-2021 LIBRARY; T=0.K  
Threshold reactions

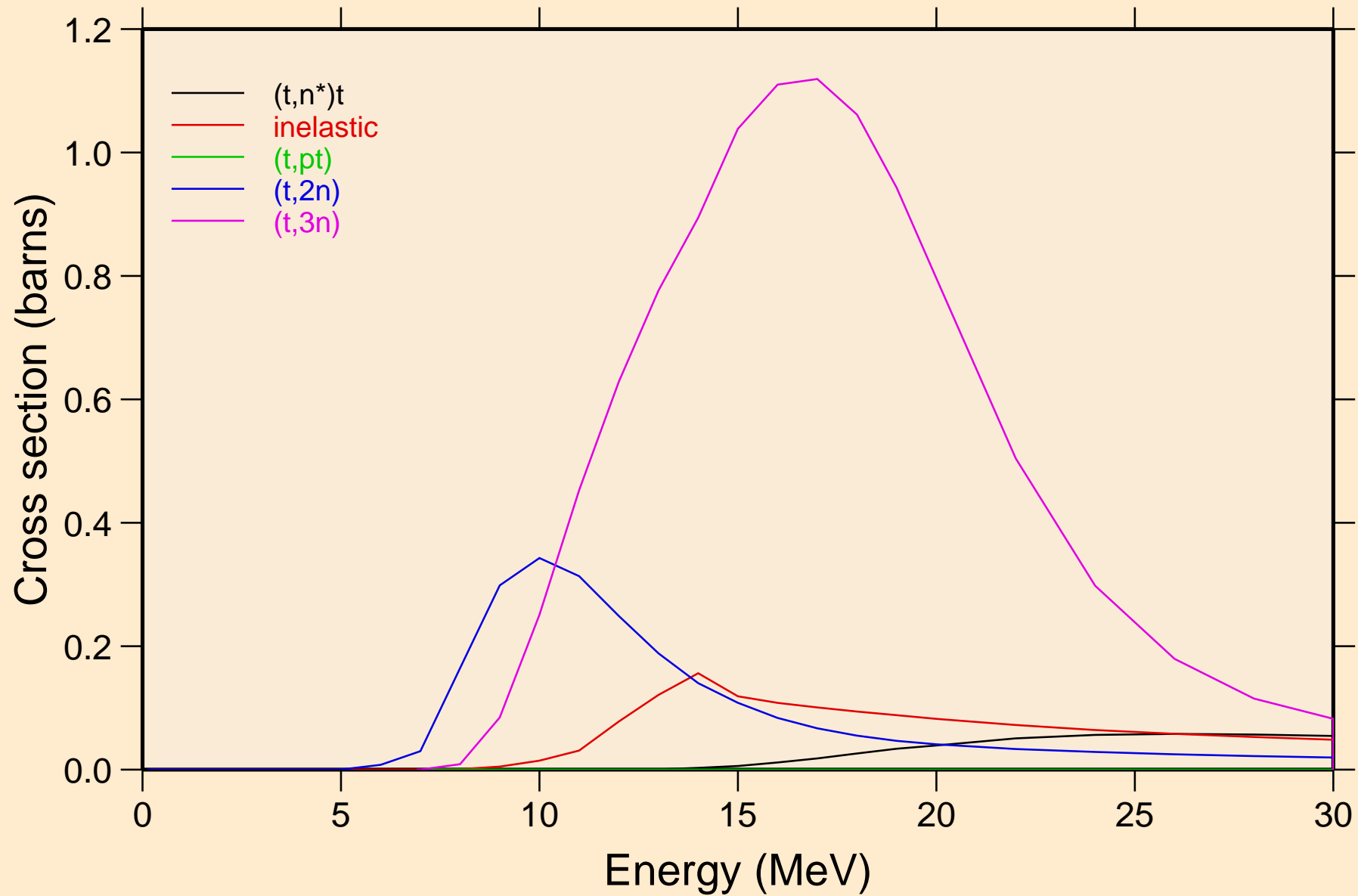

LA141 TRITON ACER TENDL-2021 LIBRARY; T=0.K  
Threshold reactions

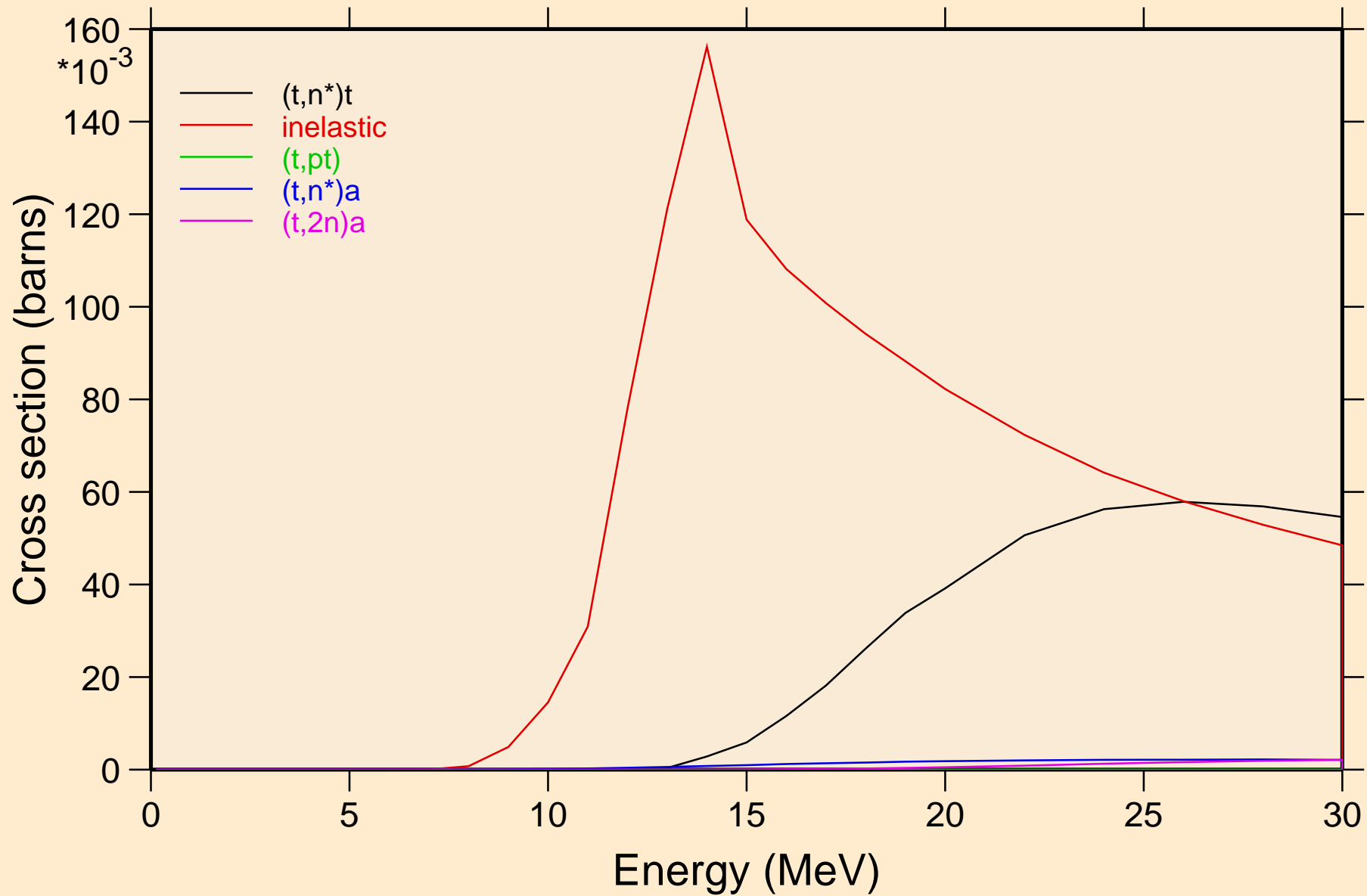

LA141 TRITON ACER TENDL-2021 LIBRARY; T=0.K  
Threshold reactions

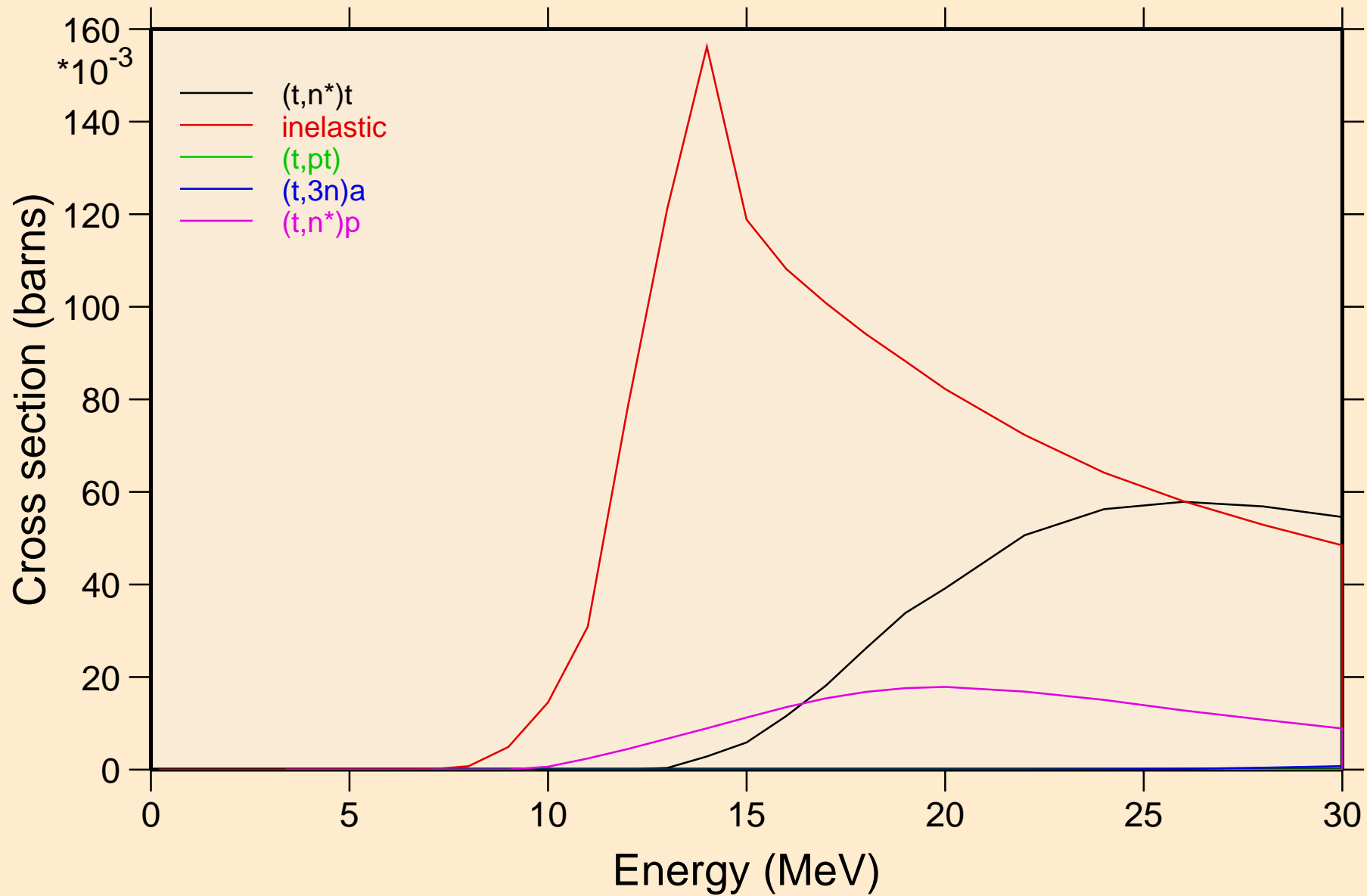



LA141 TRITON ACER TENDL-2021 LIBRARY; T=0.K  
Threshold reactions

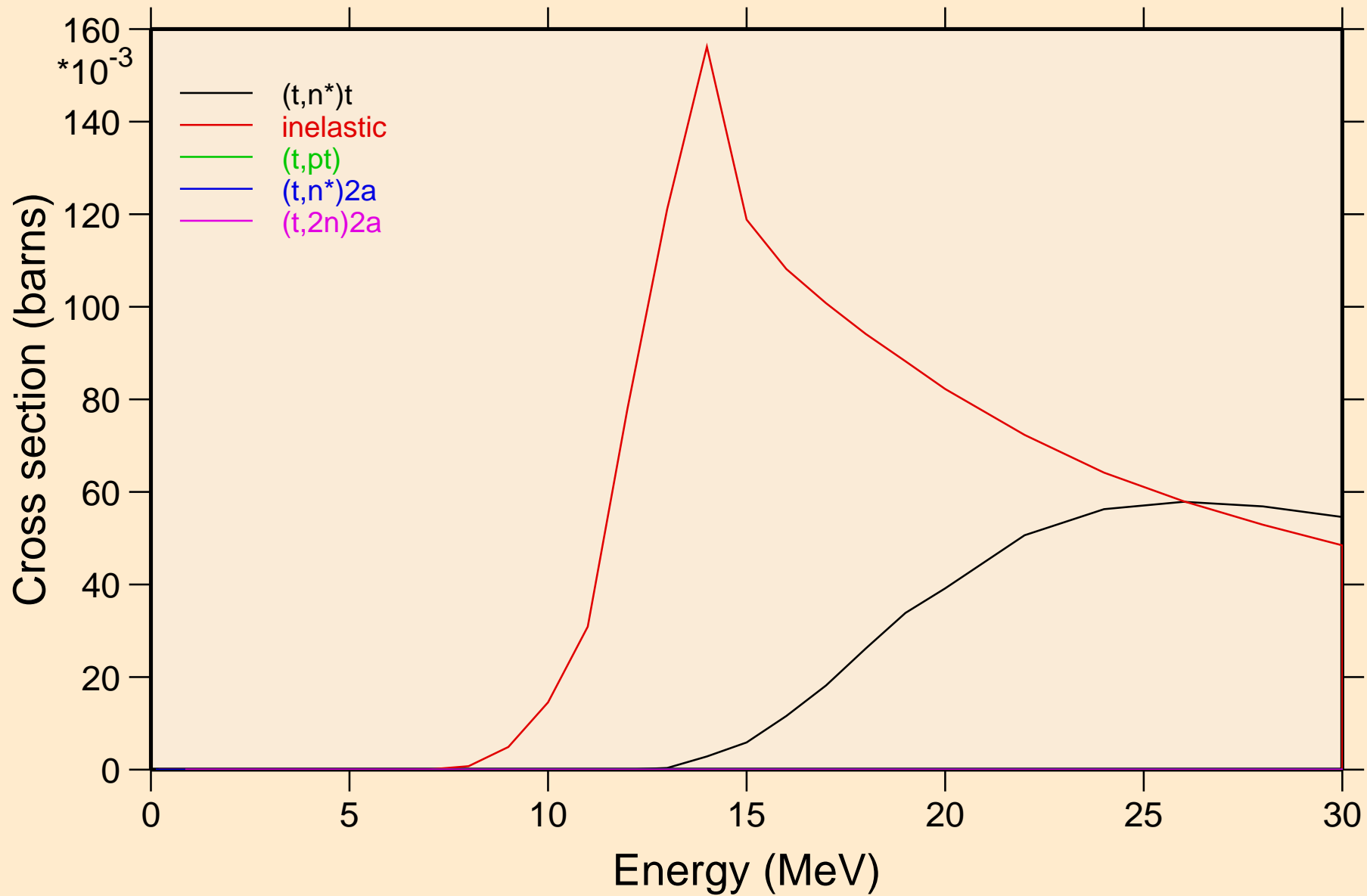

LA141 TRITON ACER TENDL-2021 LIBRARY; T=0.K  
Threshold reactions

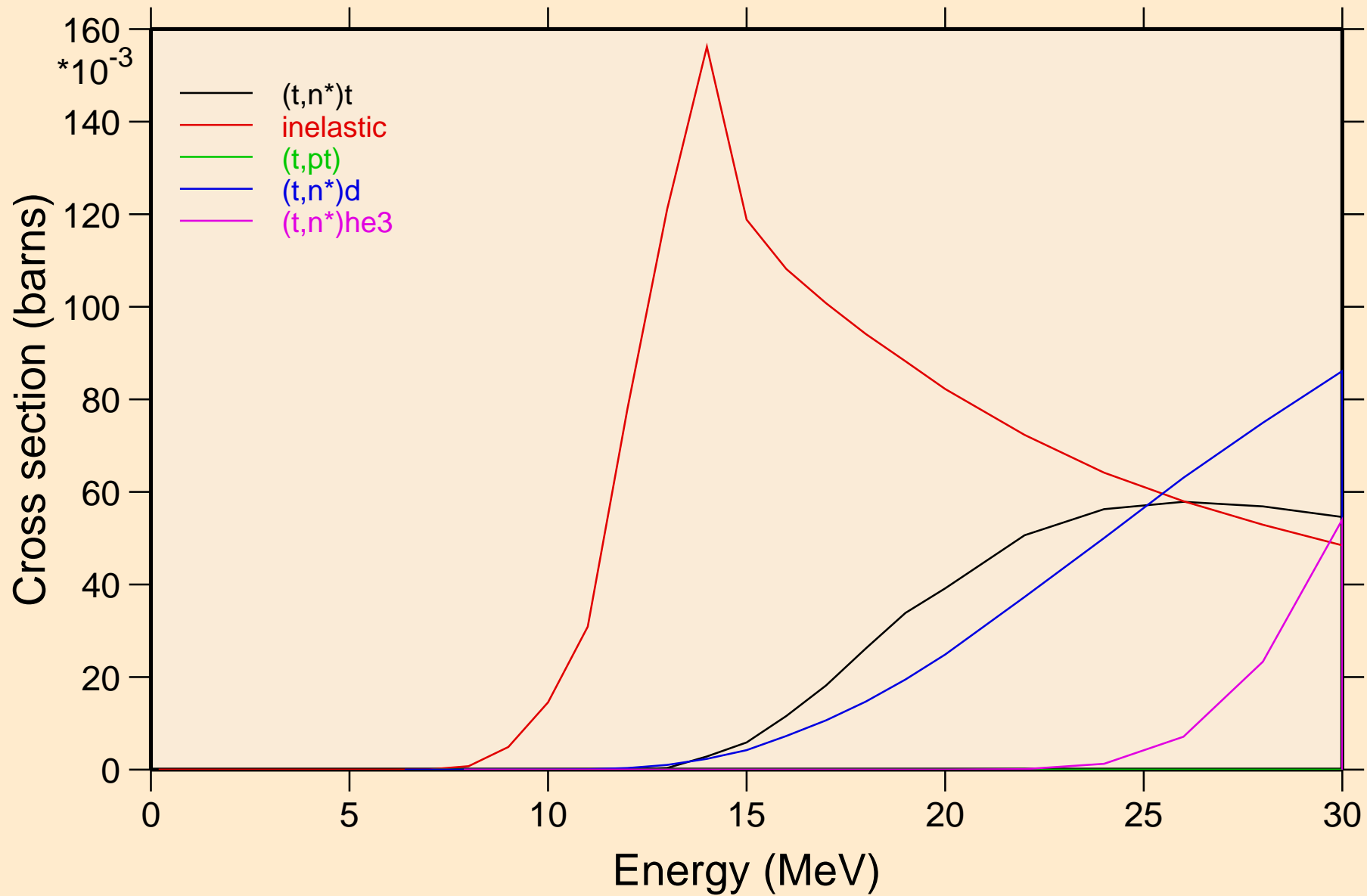

LA141 TRITON ACER TENDL-2021 LIBRARY; T=0.K  
Threshold reactions

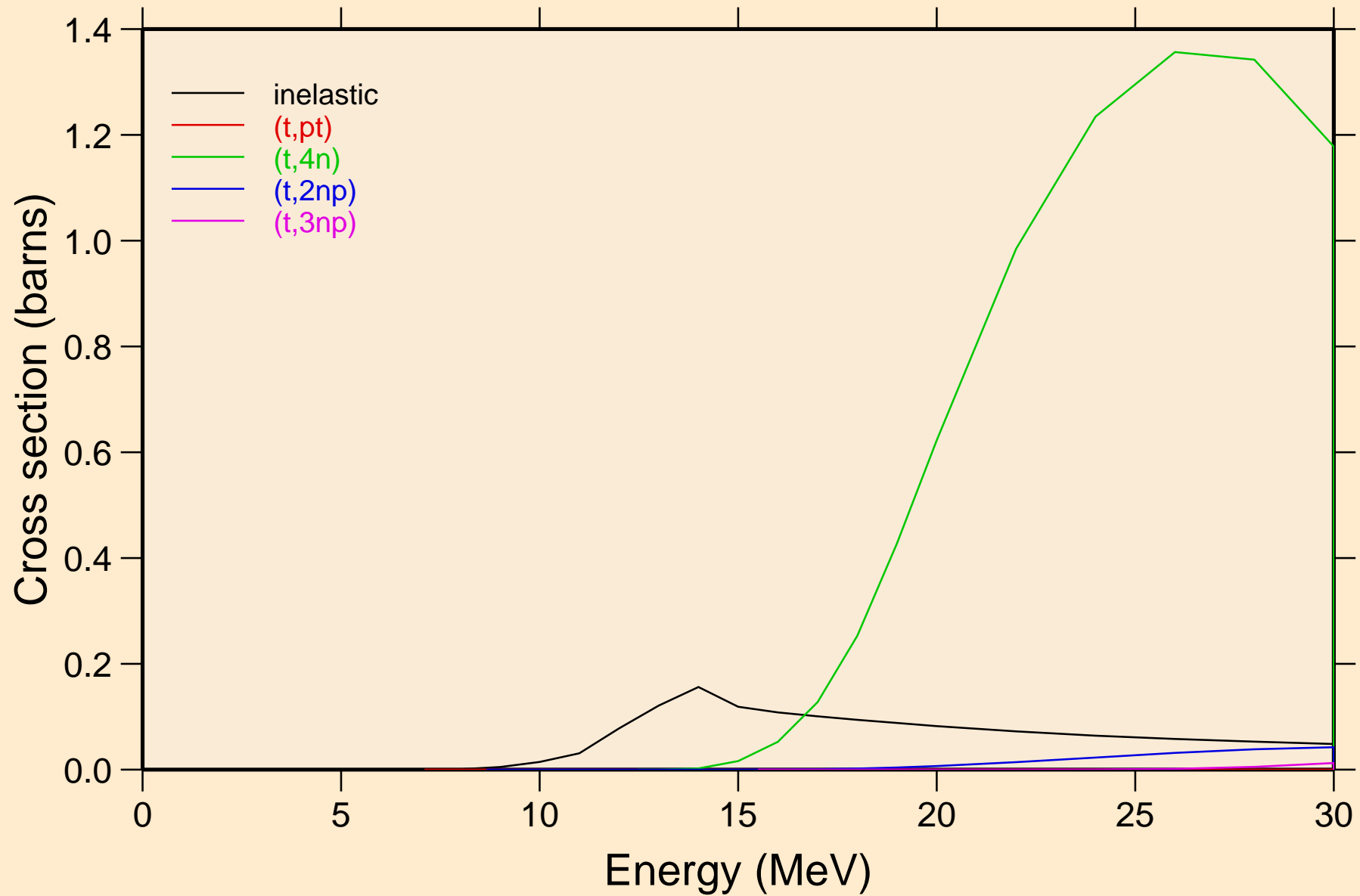

LA141 TRITON ACER TENDL-2021 LIBRARY; T=0.K  
Threshold reactions

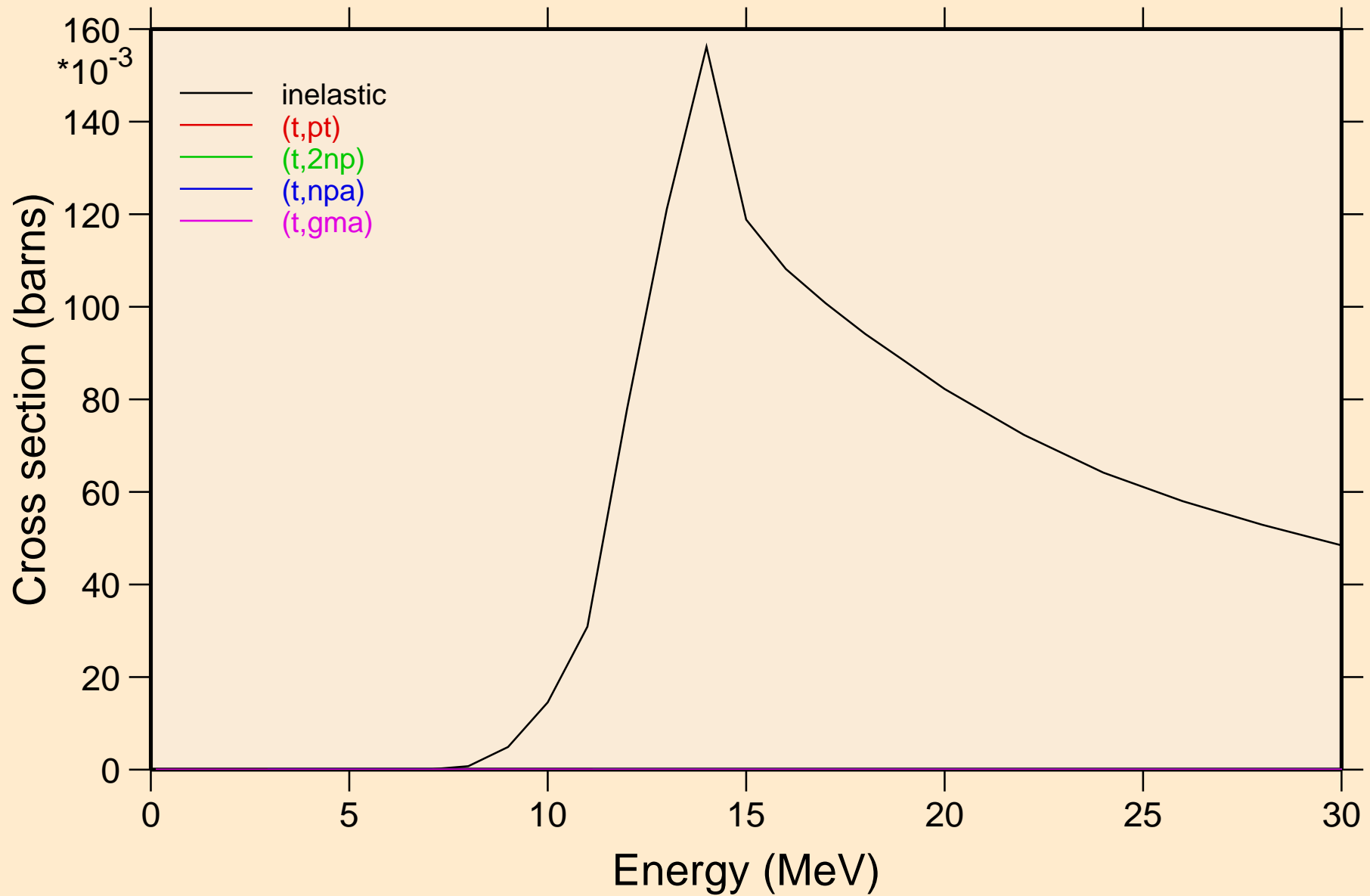

# LA141 TRITON ACER TENDL-2021 LIBRARY; T=0.K

## Threshold reactions

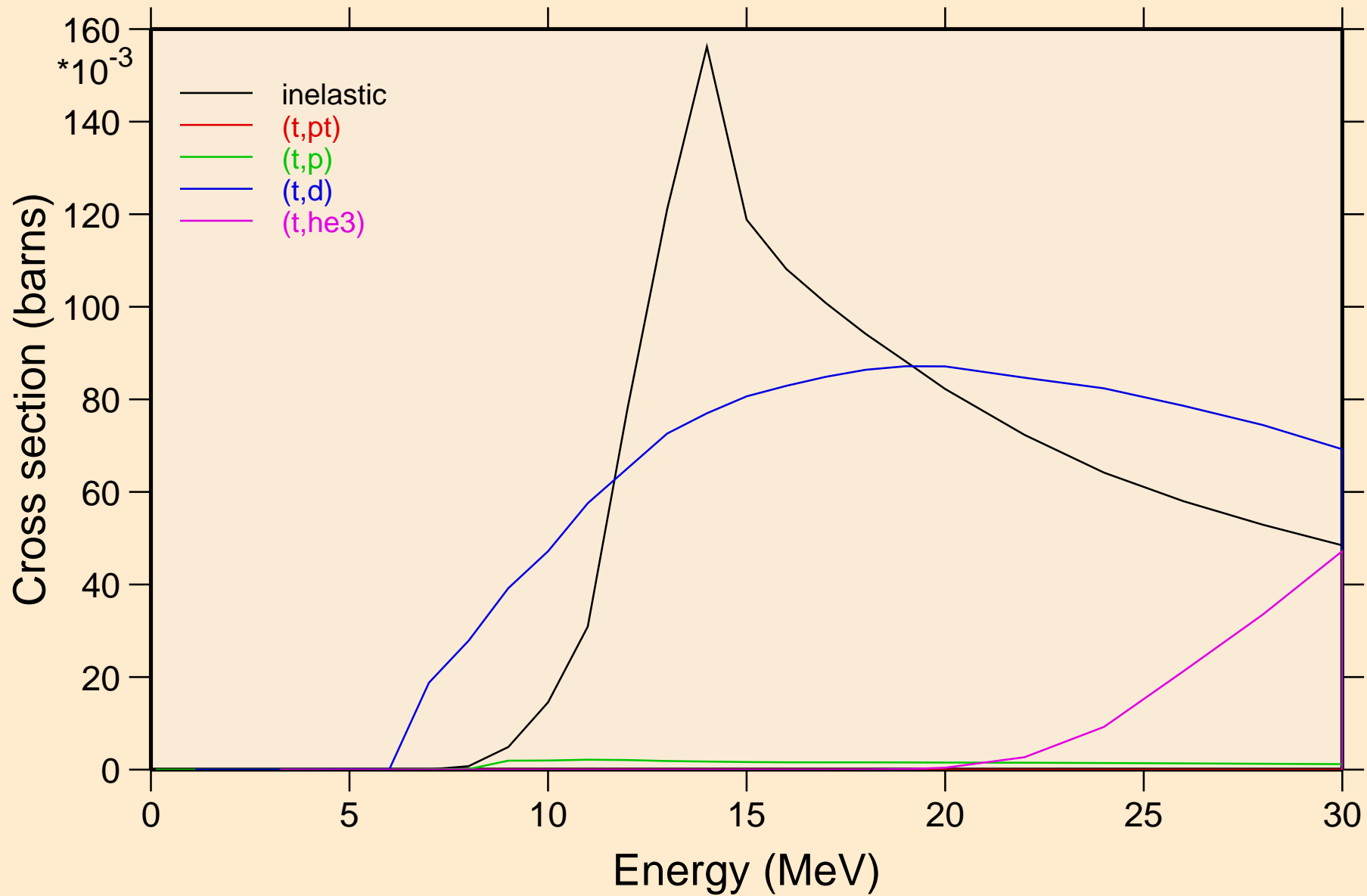

LA141 TRITON ACER TENDL-2021 LIBRARY; T=0.K  
Threshold reactions

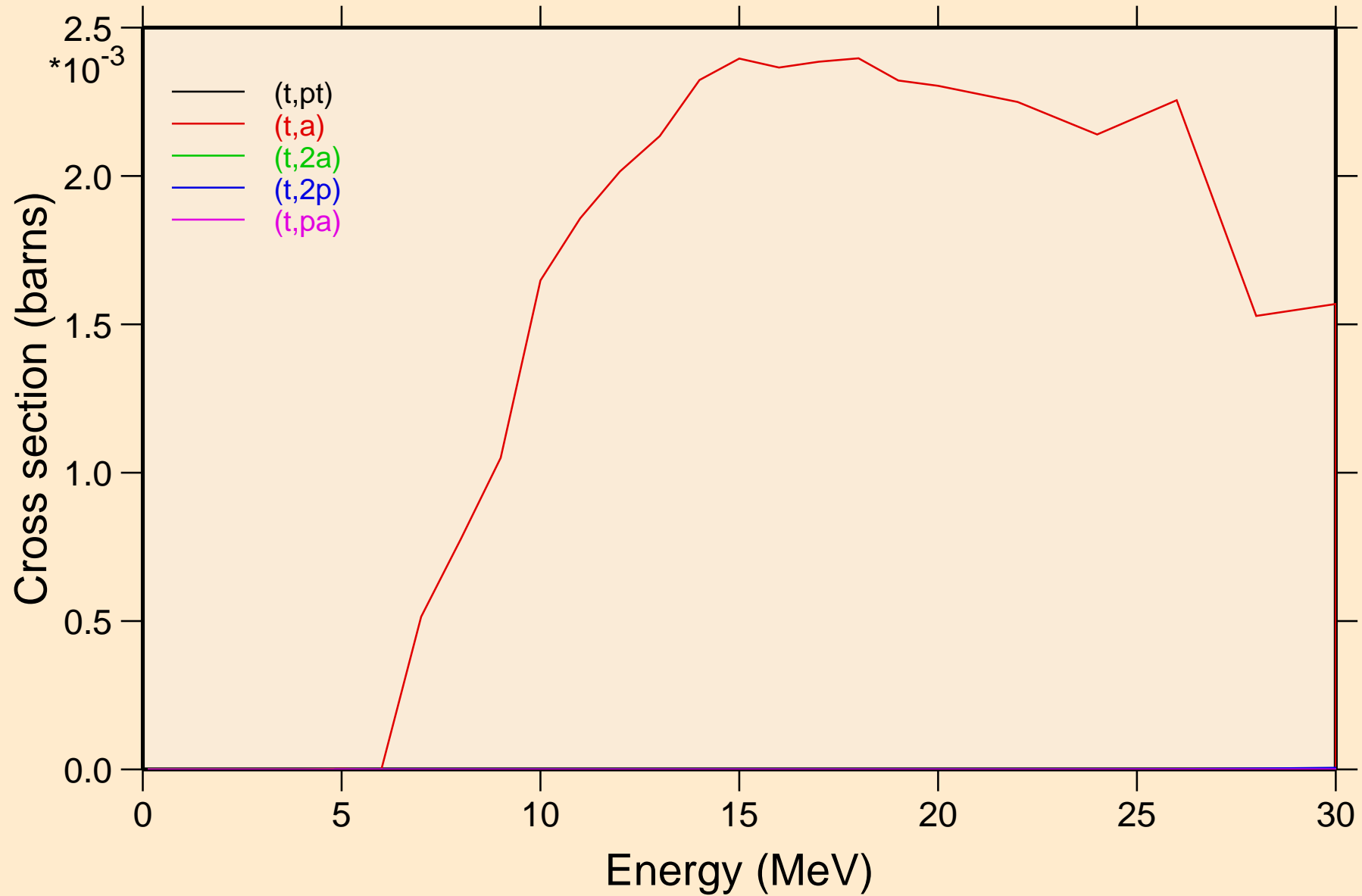

LA141 TRITON ACER TENDL-2021 LIBRARY; T=0.K  
Threshold reactions

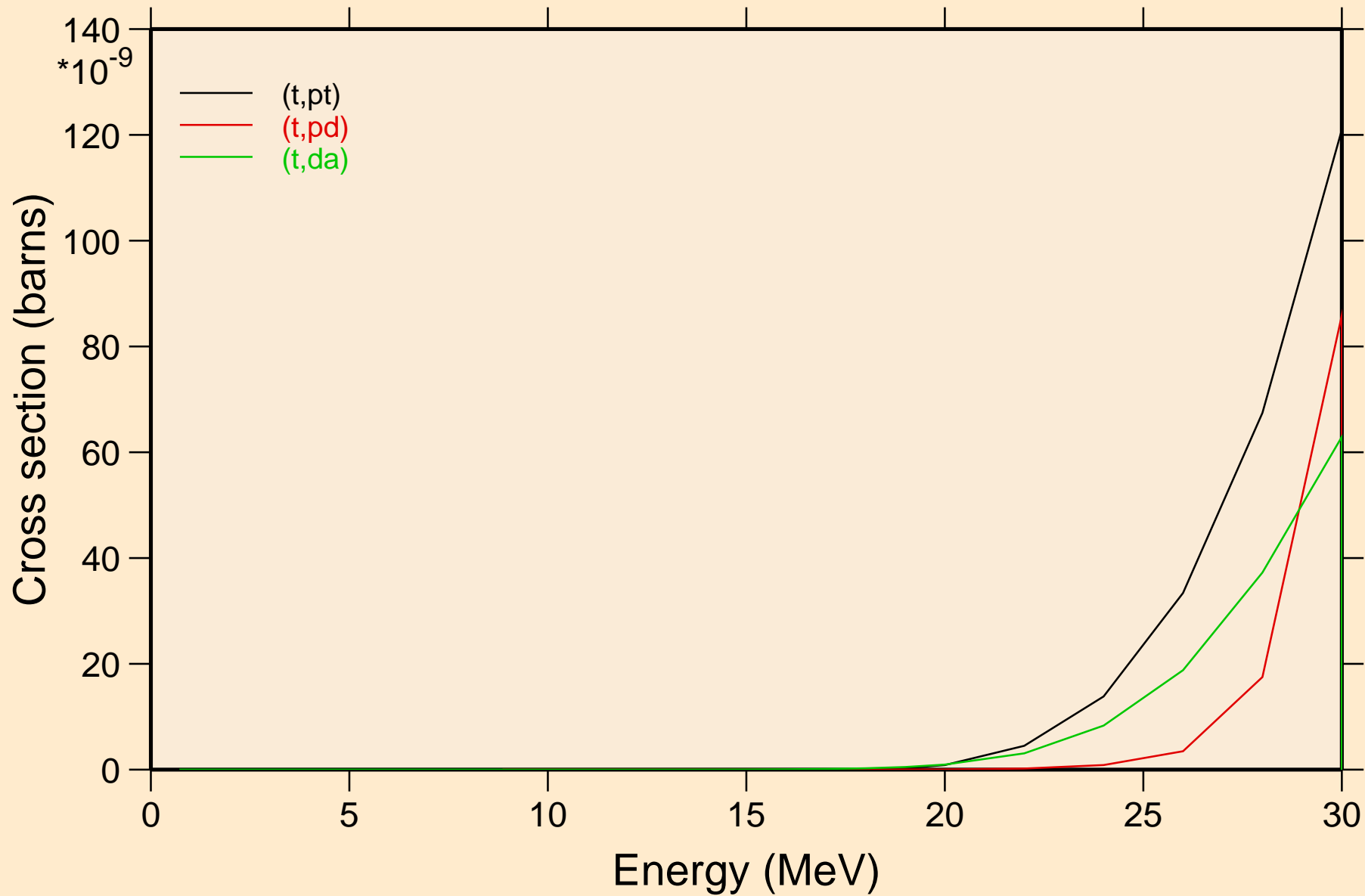

LA141 TRITON ACER TENDL-2021 LIBRARY; T=0.K  
angular distribution for elastic

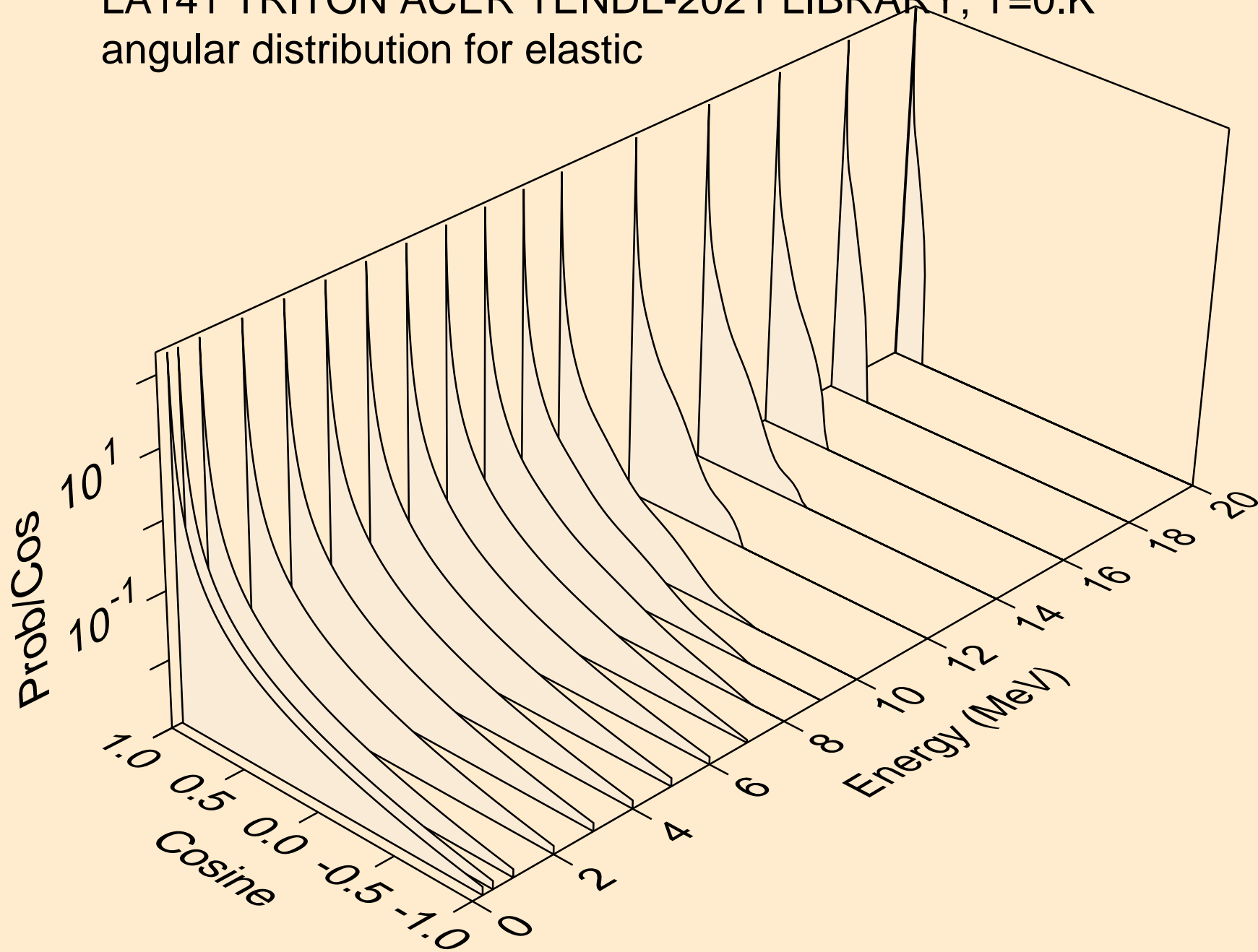



LA141 TRITON ACER TENDL-2021 LIBRARY; T=0.K  
angular distribution for elastic

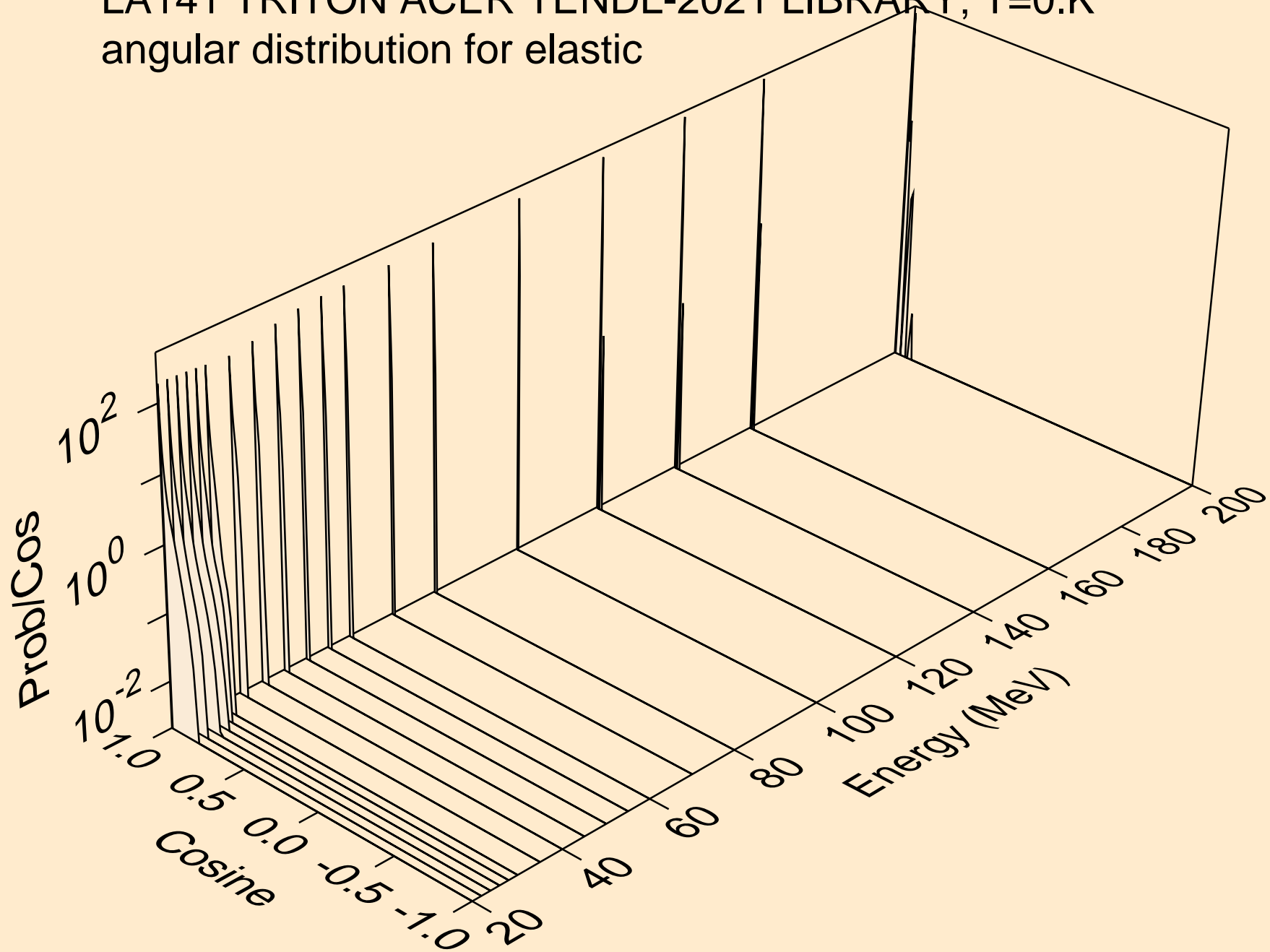

LA141 TRITON ACER TENDL-2021 LIBRARY; T=0.K  
Triton emission for (t,x)

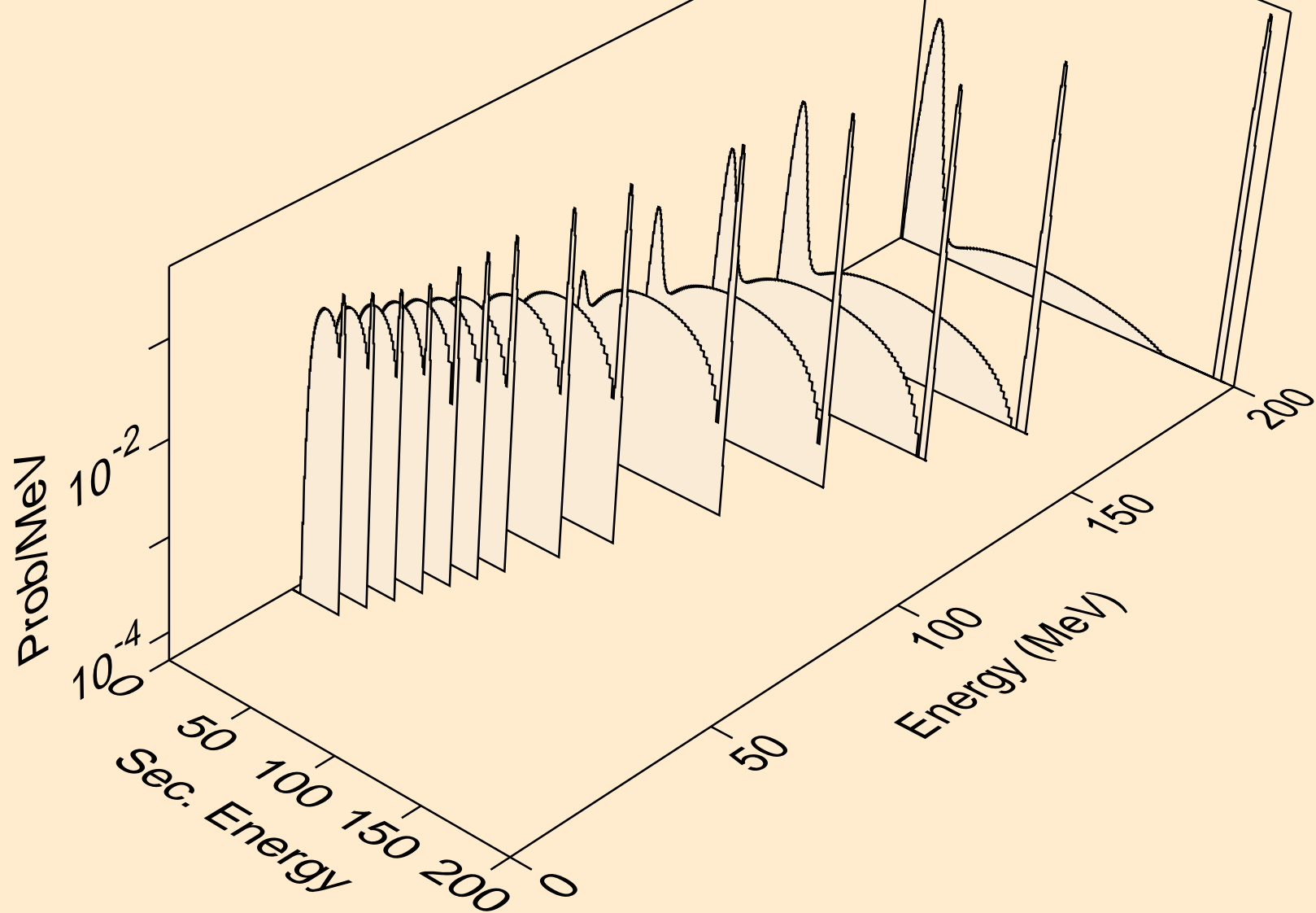

LA141 TRITON ACER TENDL-2021 LIBRARY; T=0.K  
Triton emission for (t,n\*)t

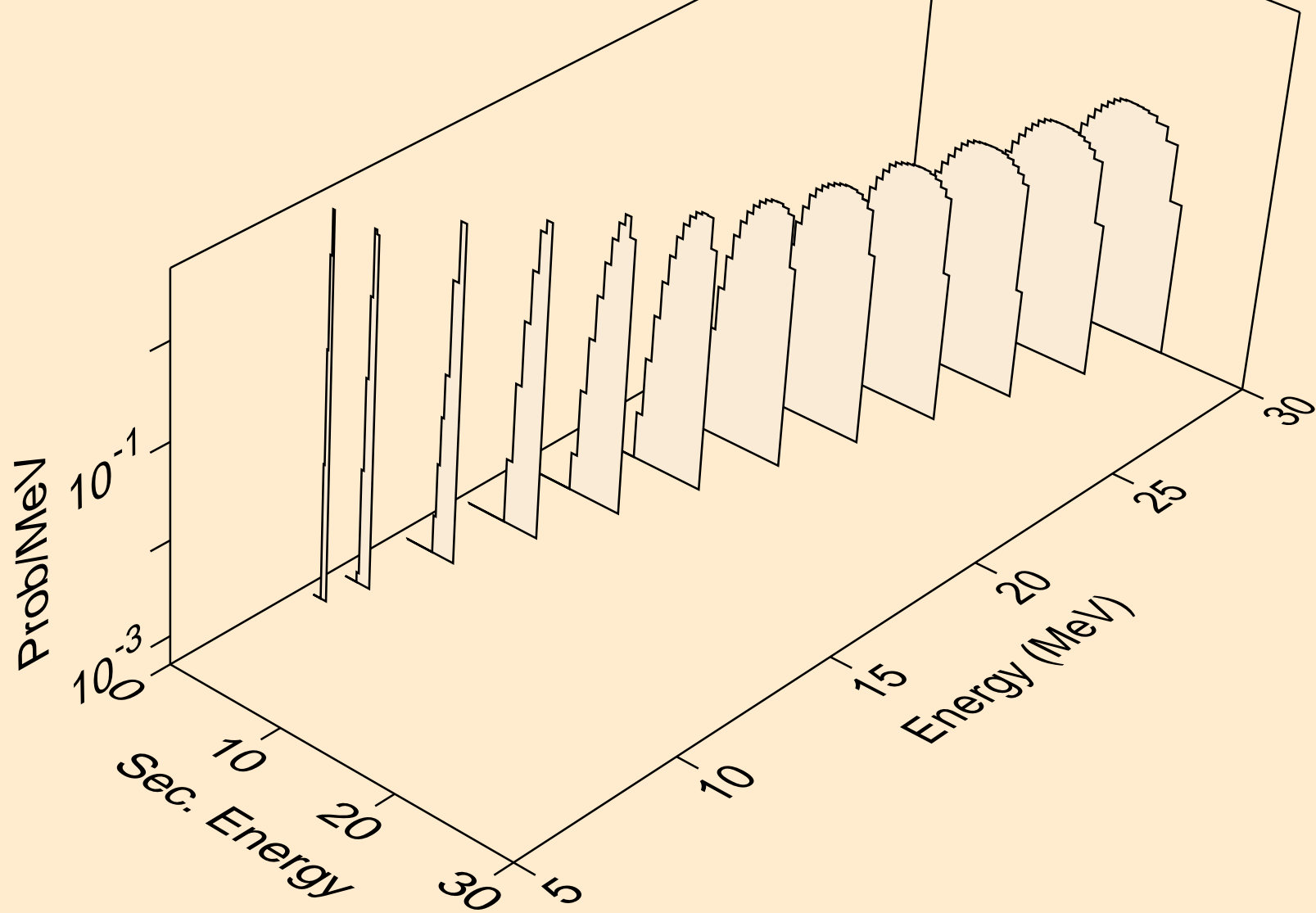

LA141 TRITON ACER TENDL-2021 LIBRARY; T=0.K  
Triton emission for inelastic

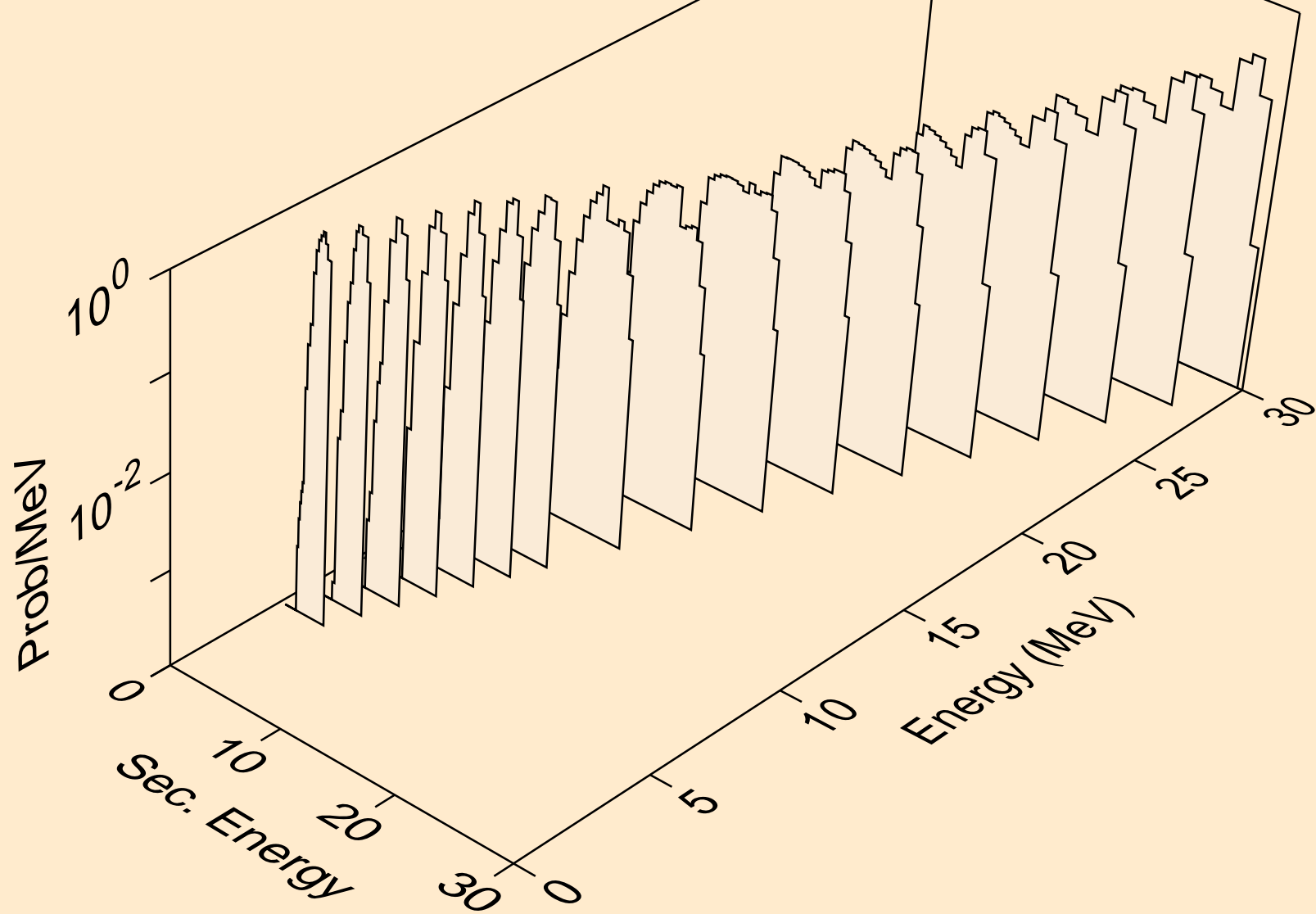

LA141 TRITON ACER TENDL-2021 LIBRARY; T=0.K  
Triton emission for (t,pt)

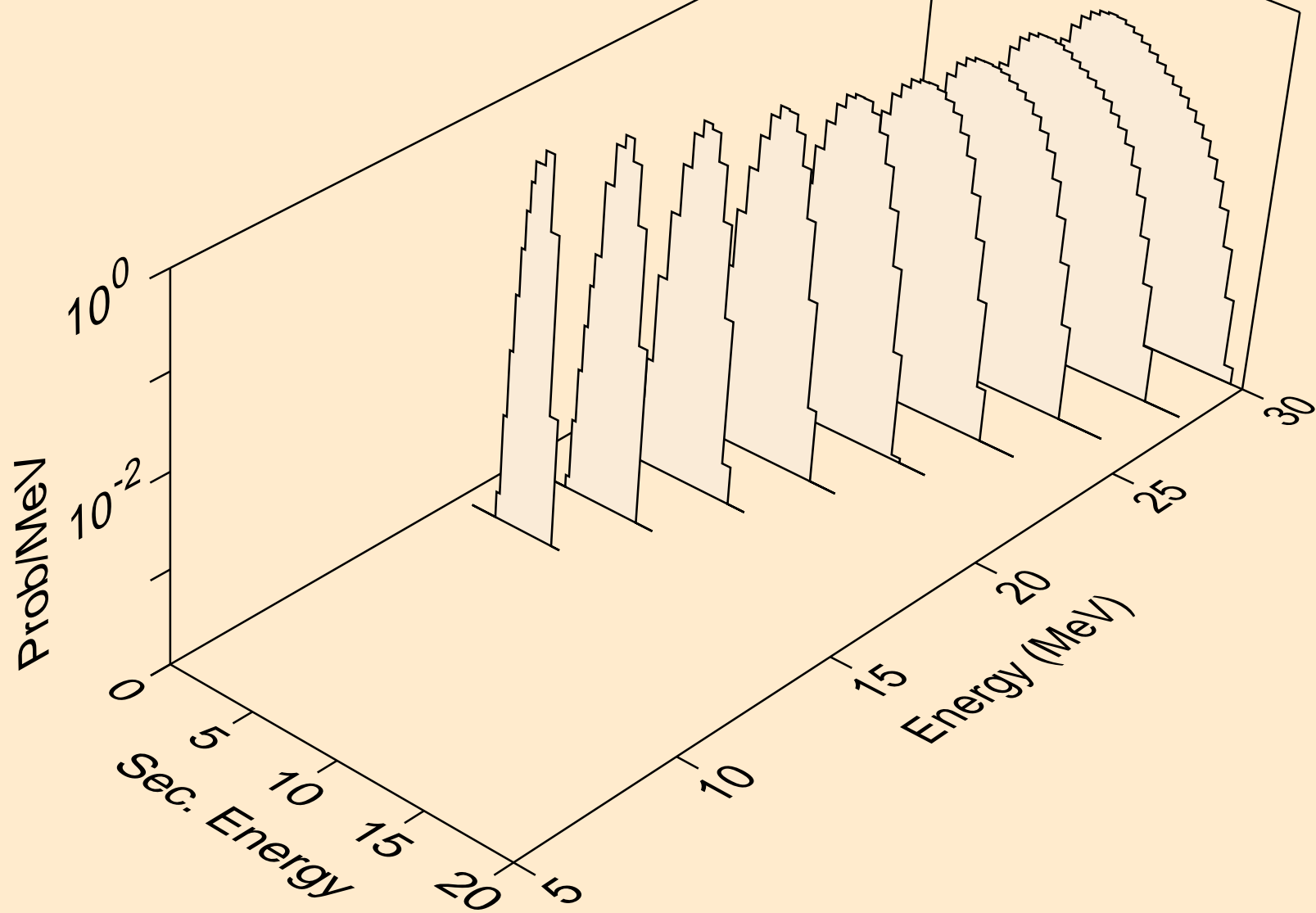

LA141 TRITON ACER TENDL-2021 LIBRARY; T=0.K  
Photon emission for (z,n)

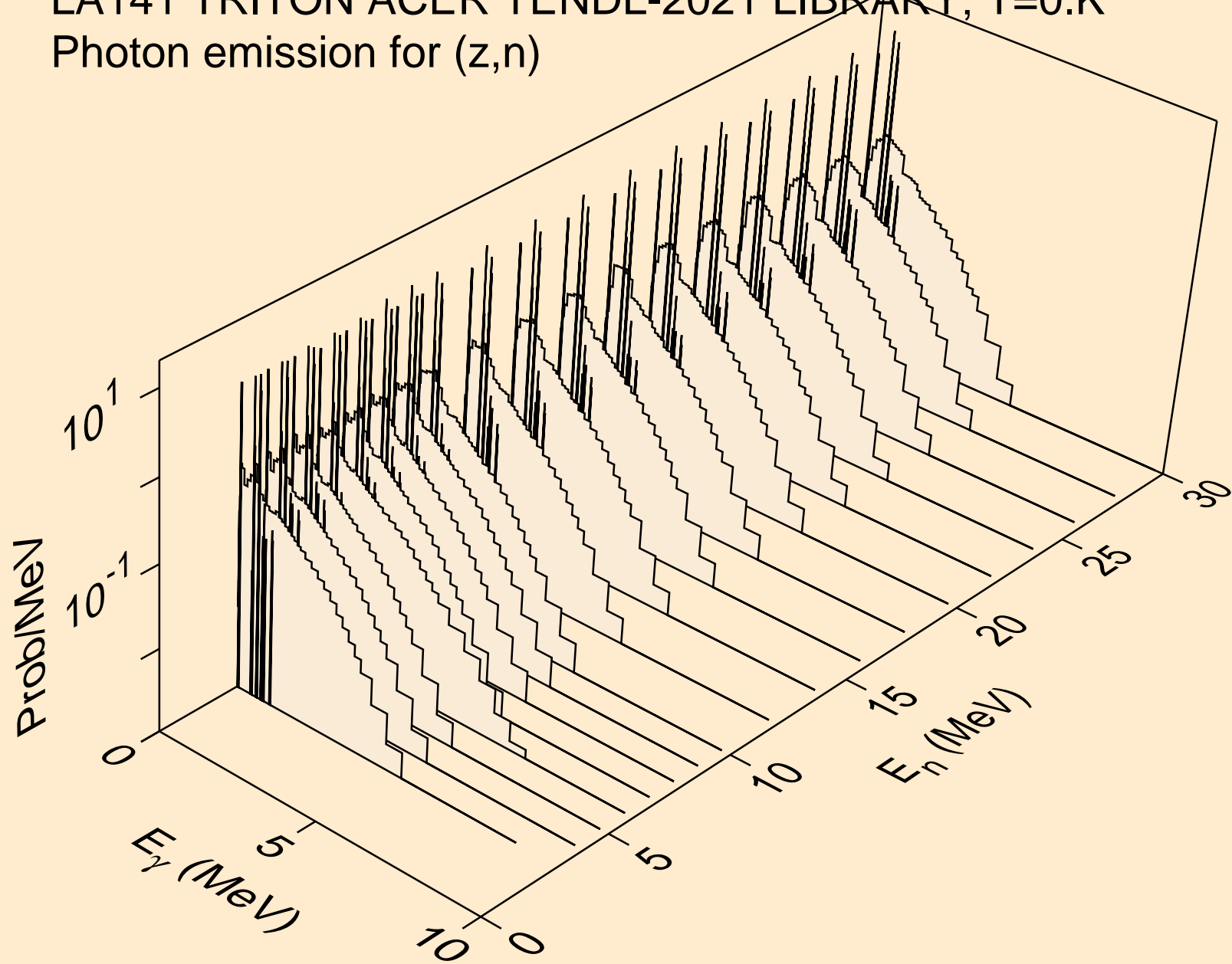

LA141 TRITON ACER TENDL-2021 LIBRARY; T=0.K  
Photon emission for (n,x)

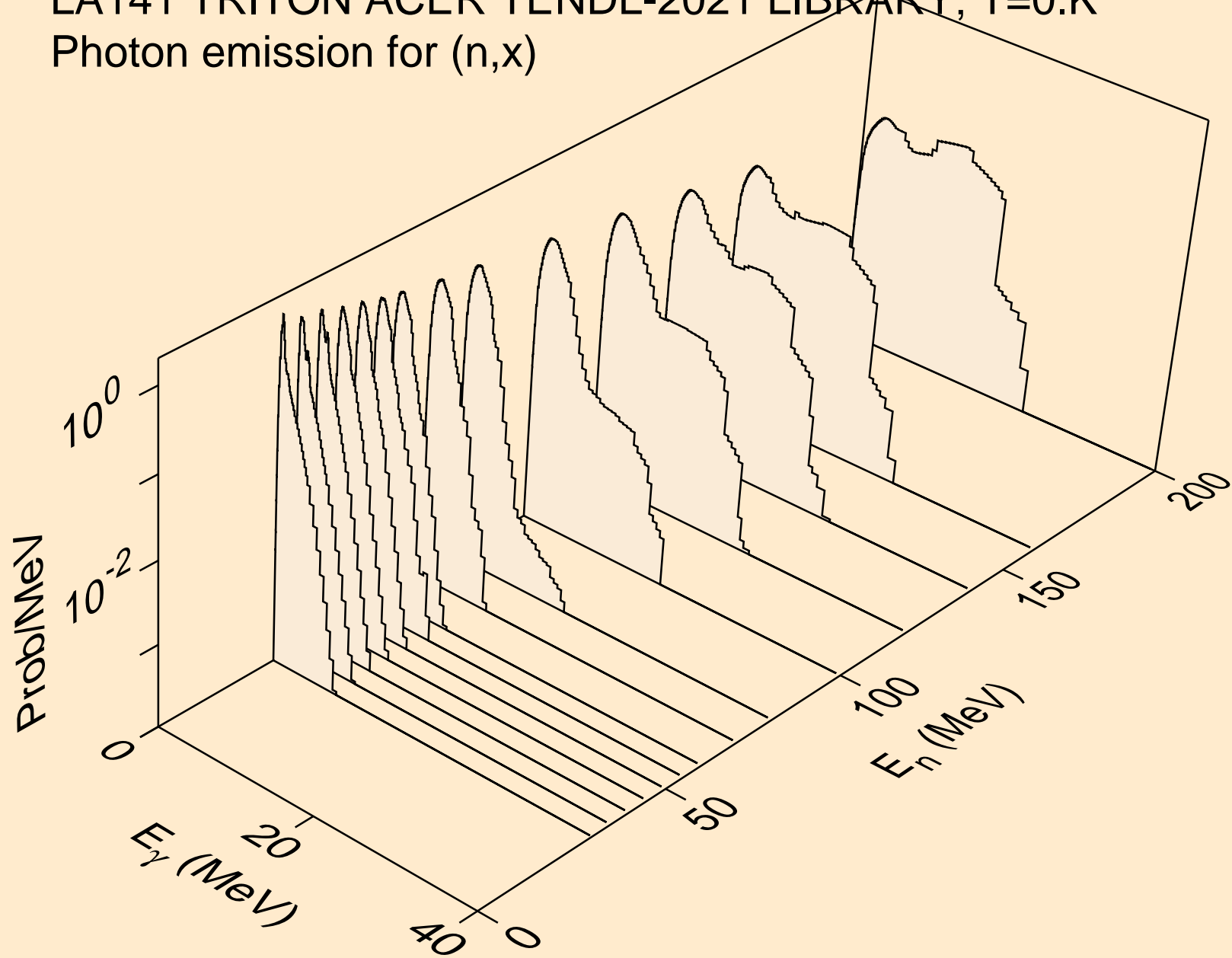

LA141 TRITON ACER TENDL-2021 LIBRARY; T=0.K  
Photon emission for (n,2nd)

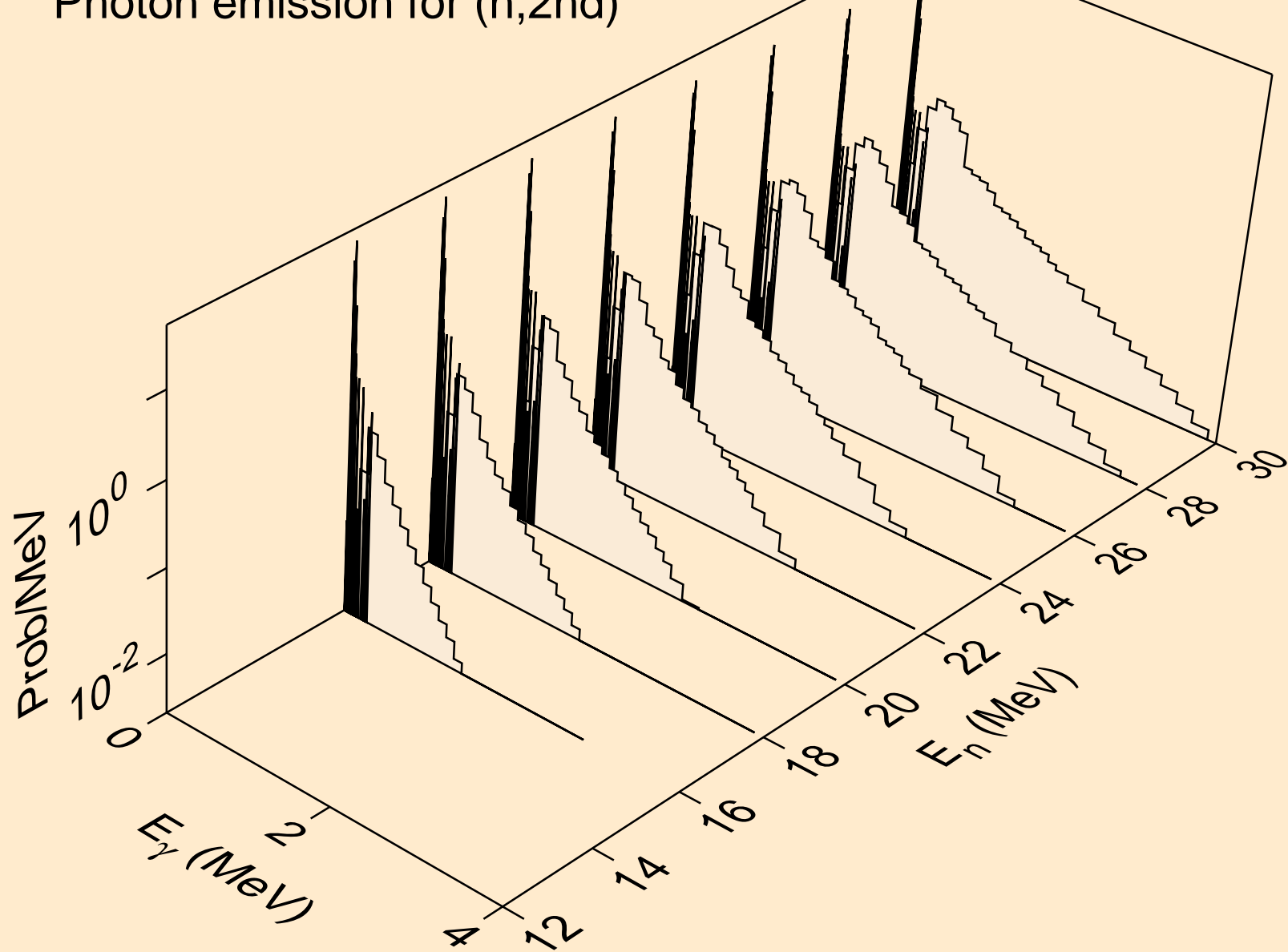



LA141 TRITON ACER TENDL-2021 LIBRARY; T=0.K  
Photon emission for (n,2n)

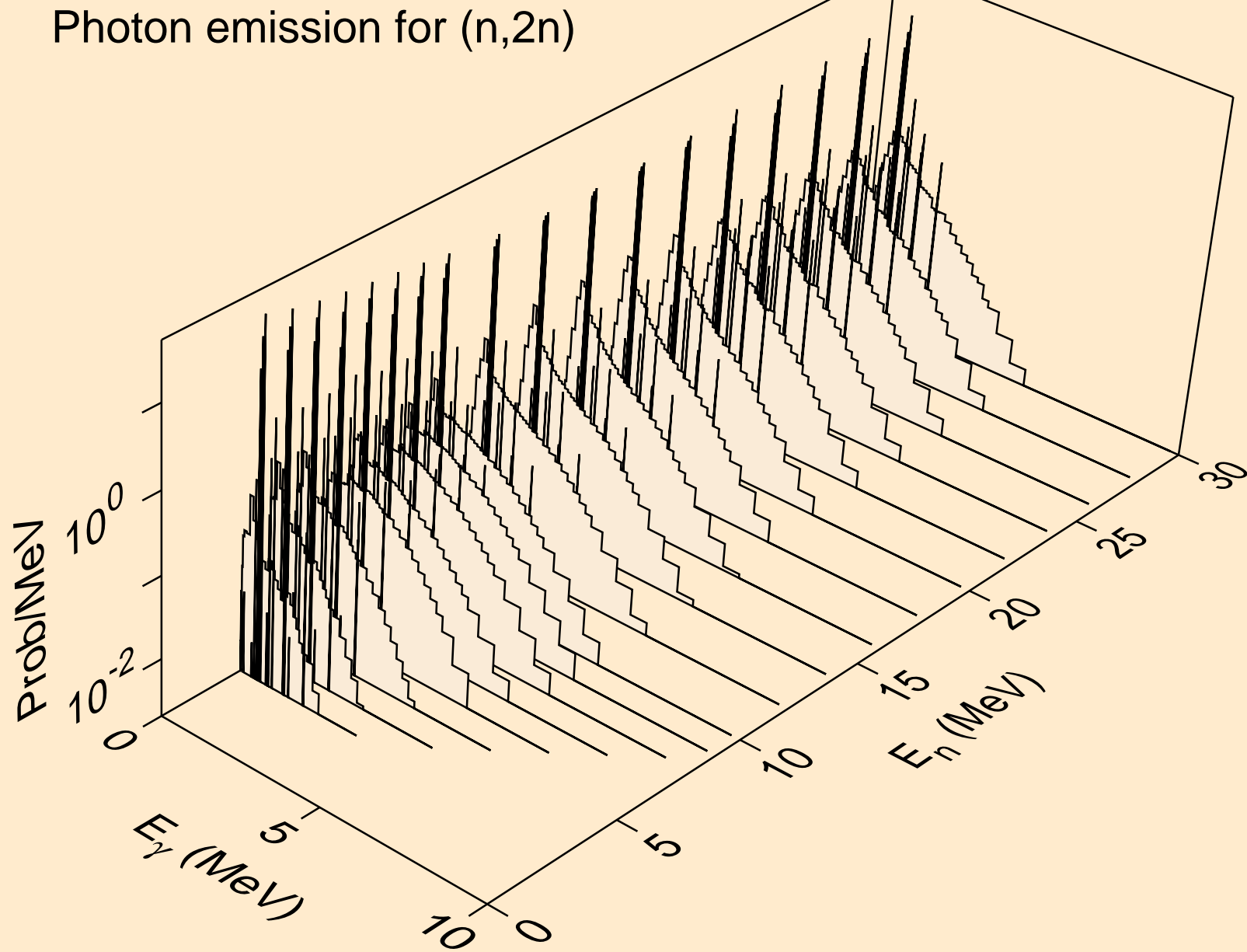

LA141 TRITON ACER TENDL-2021 LIBRARY; T=0.K  
Photon emission for (n,3n)

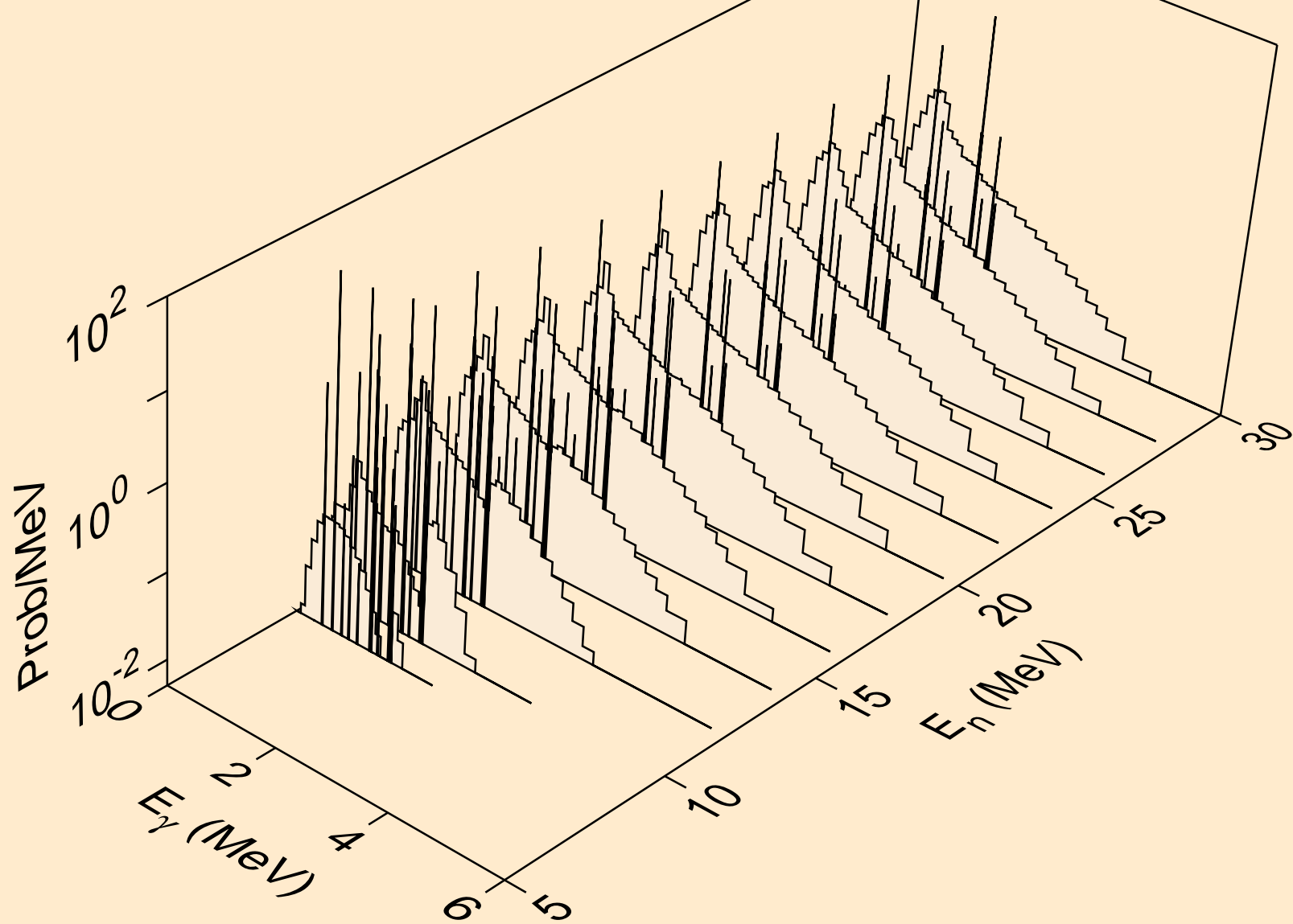

LA141 TRITON ACER TENDL-2021 LIBRARY; T=0.K  
Photon emission for (n,n\*)a

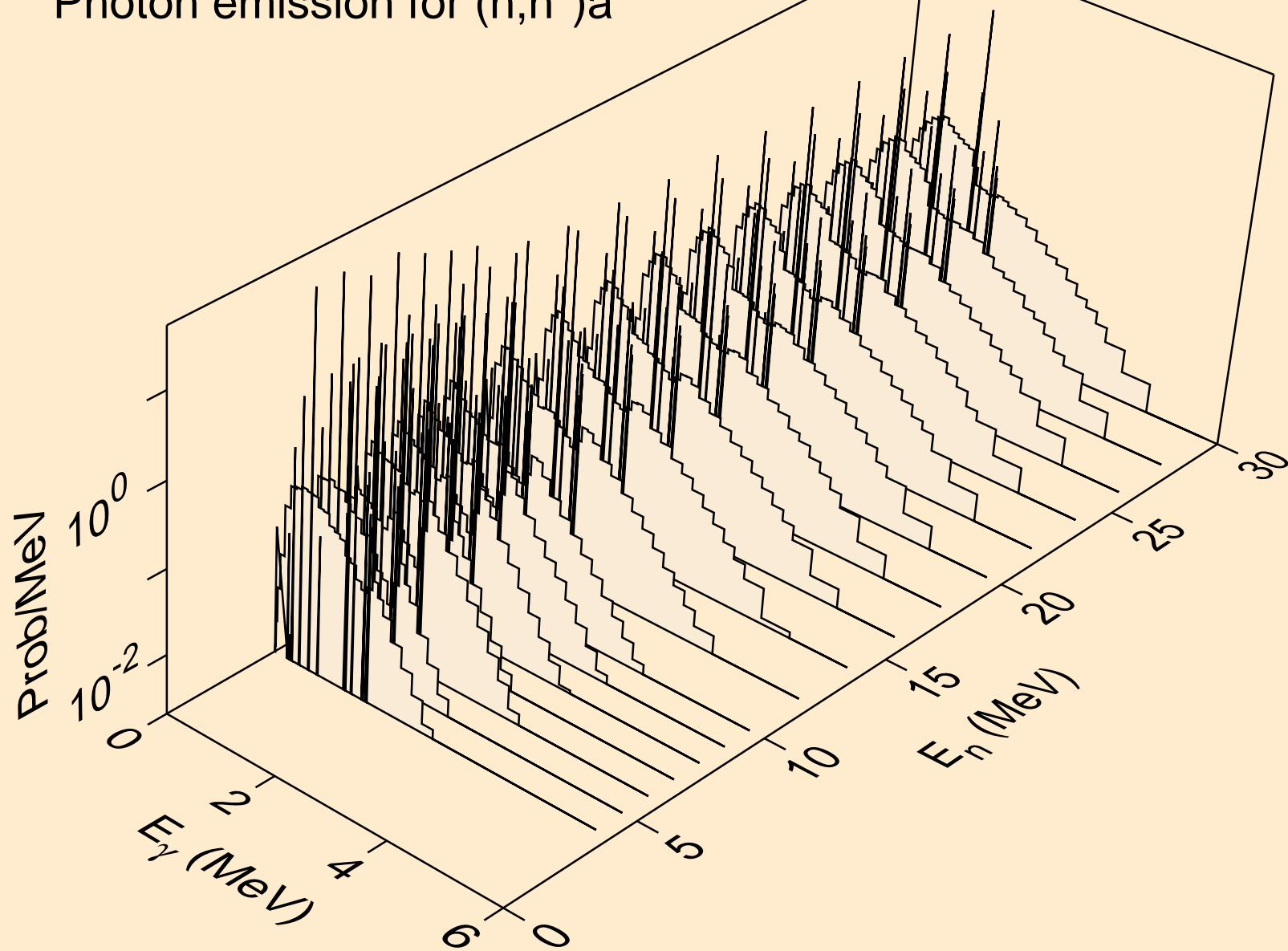

LA141 TRITON ACER TENDL-2021 LIBRARY; T=0.K  
Photon emission for (n,2n)a

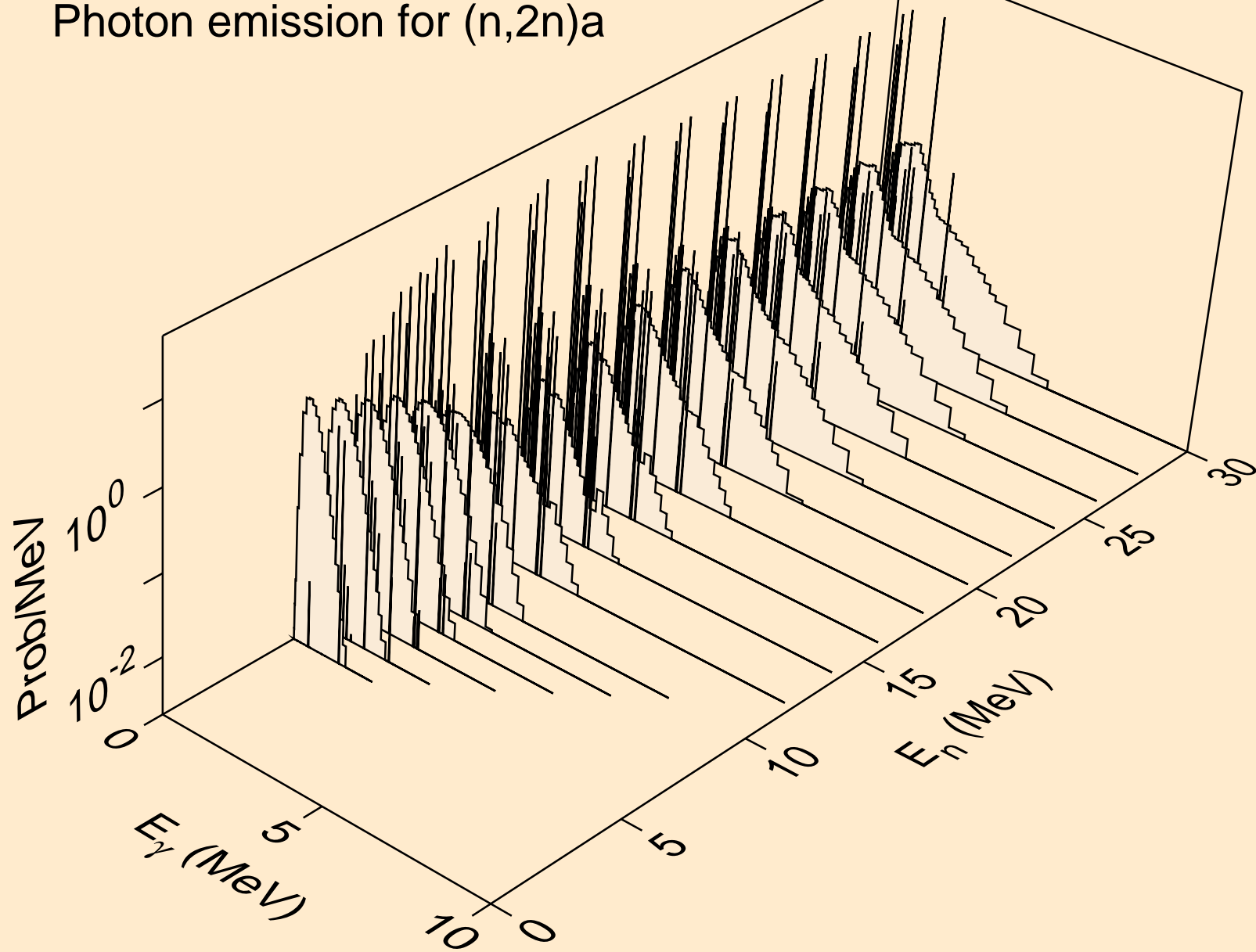

LA141 TRITON ACER TENDL-2021 LIBRARY; T=0.K  
Photon emission for (n,3n)a

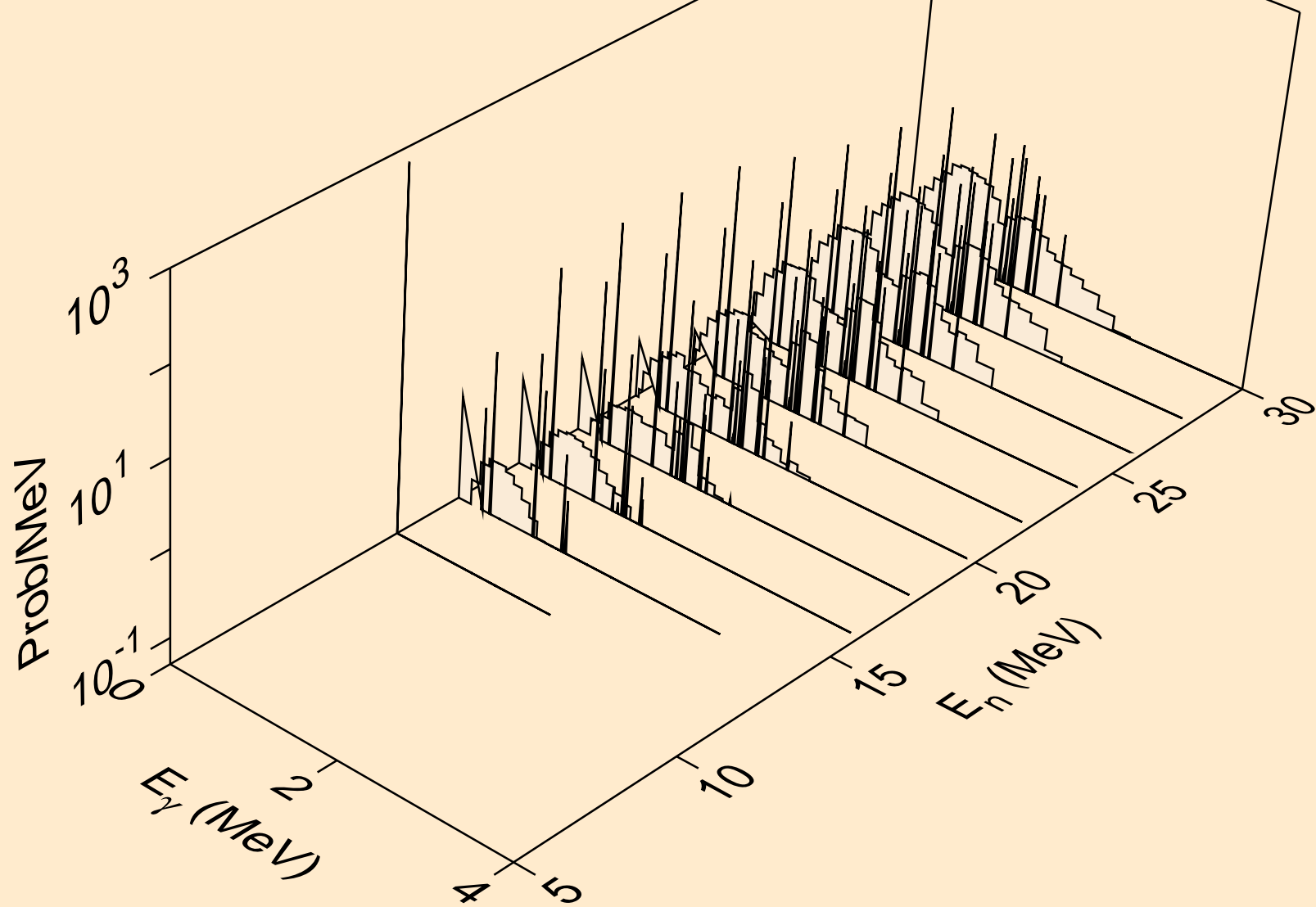

LA141 TRITON ACER TENDL-2021 LIBRARY; T=0.K  
Photon emission for (n,n\*)p

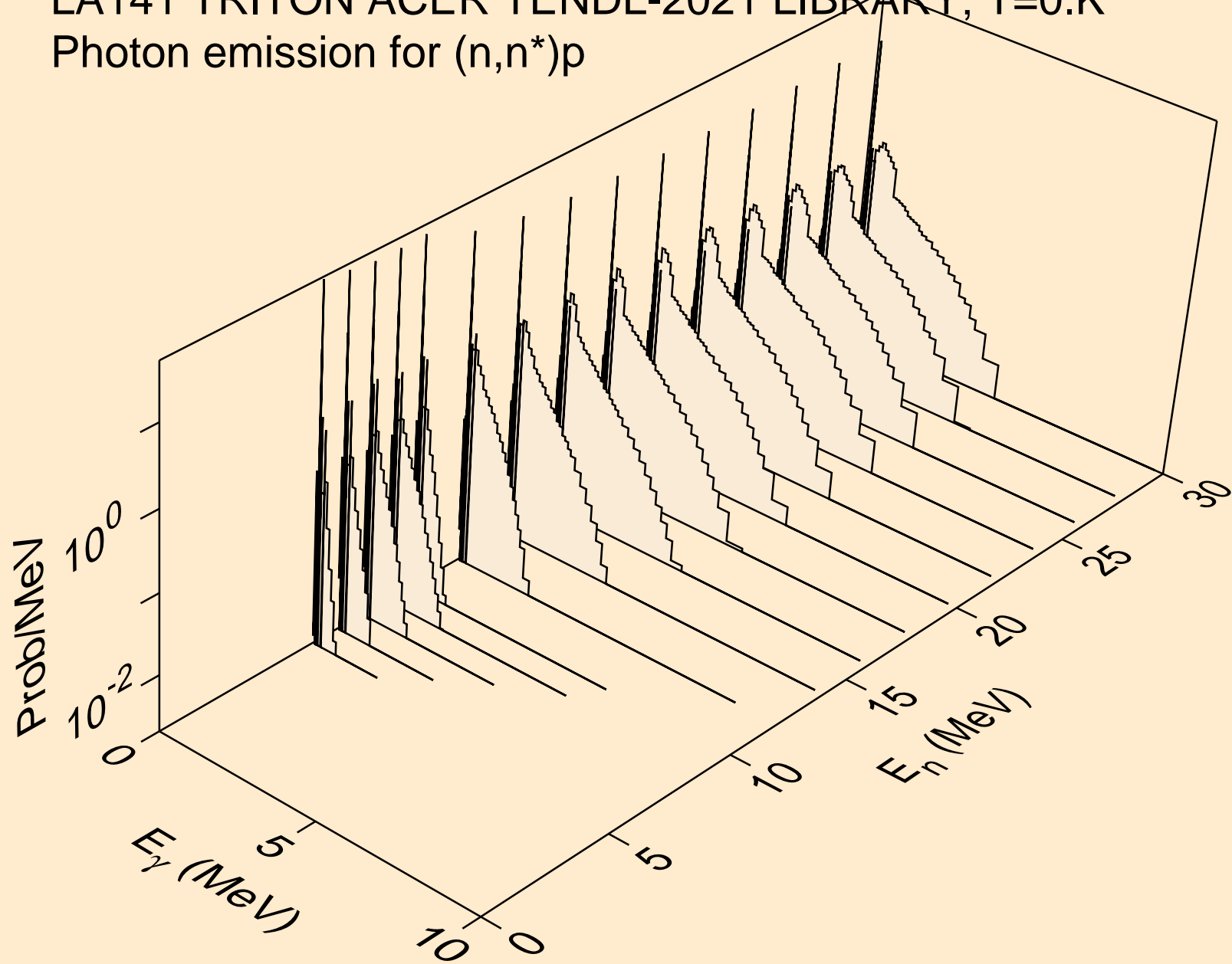

LA141 TRITON ACER TENDL-2021 LIBRARY; T=0.K  
Photon emission for (n,n\*)2a

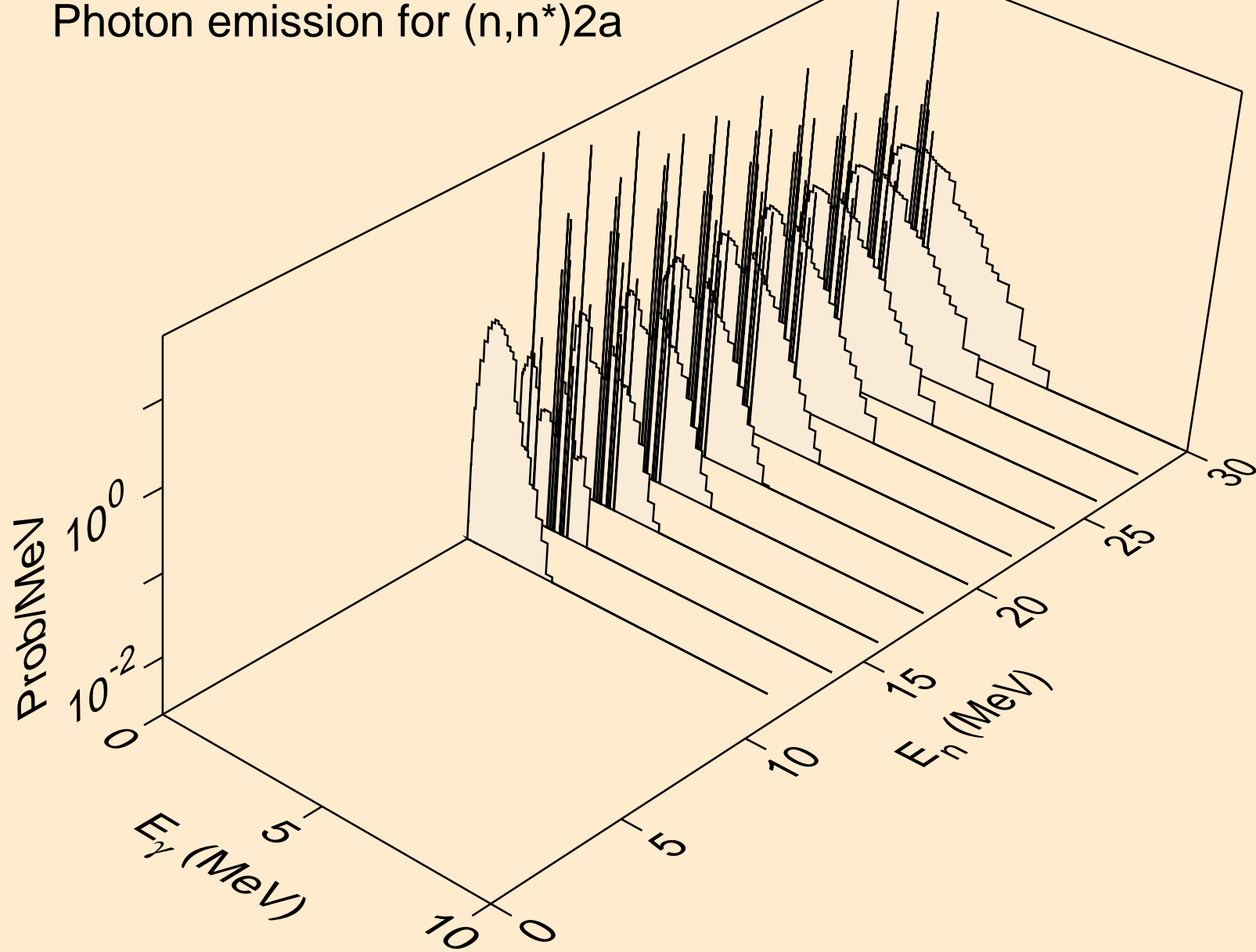

LA141 TRITON ACER TENDL-2021 LIBRARY; T=0.K  
Photon emission for (n,2n)2a

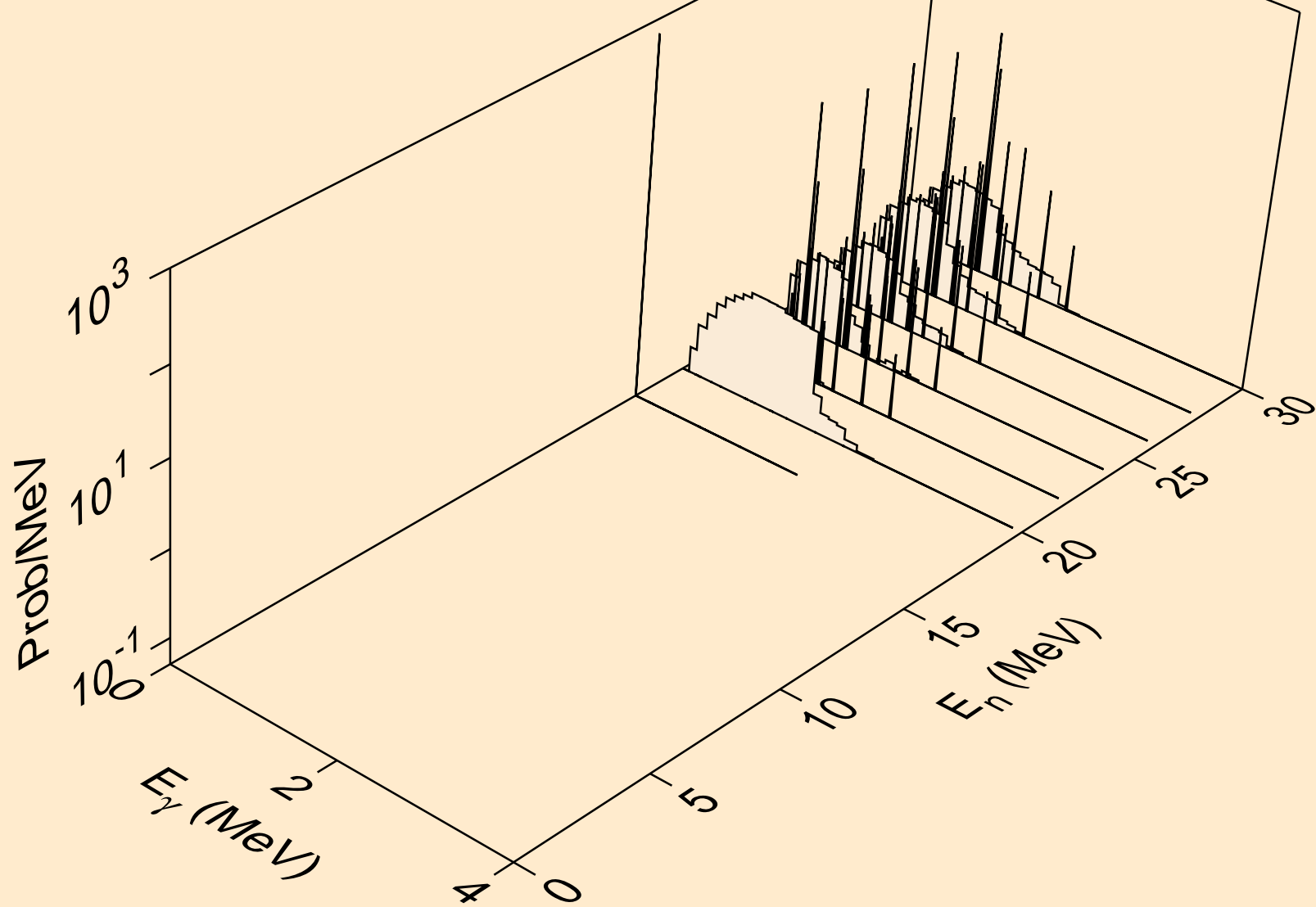



LA141 TRITON ACER TENDL-2021 LIBRARY; T=0.K  
Photon emission for (n,n\*)d

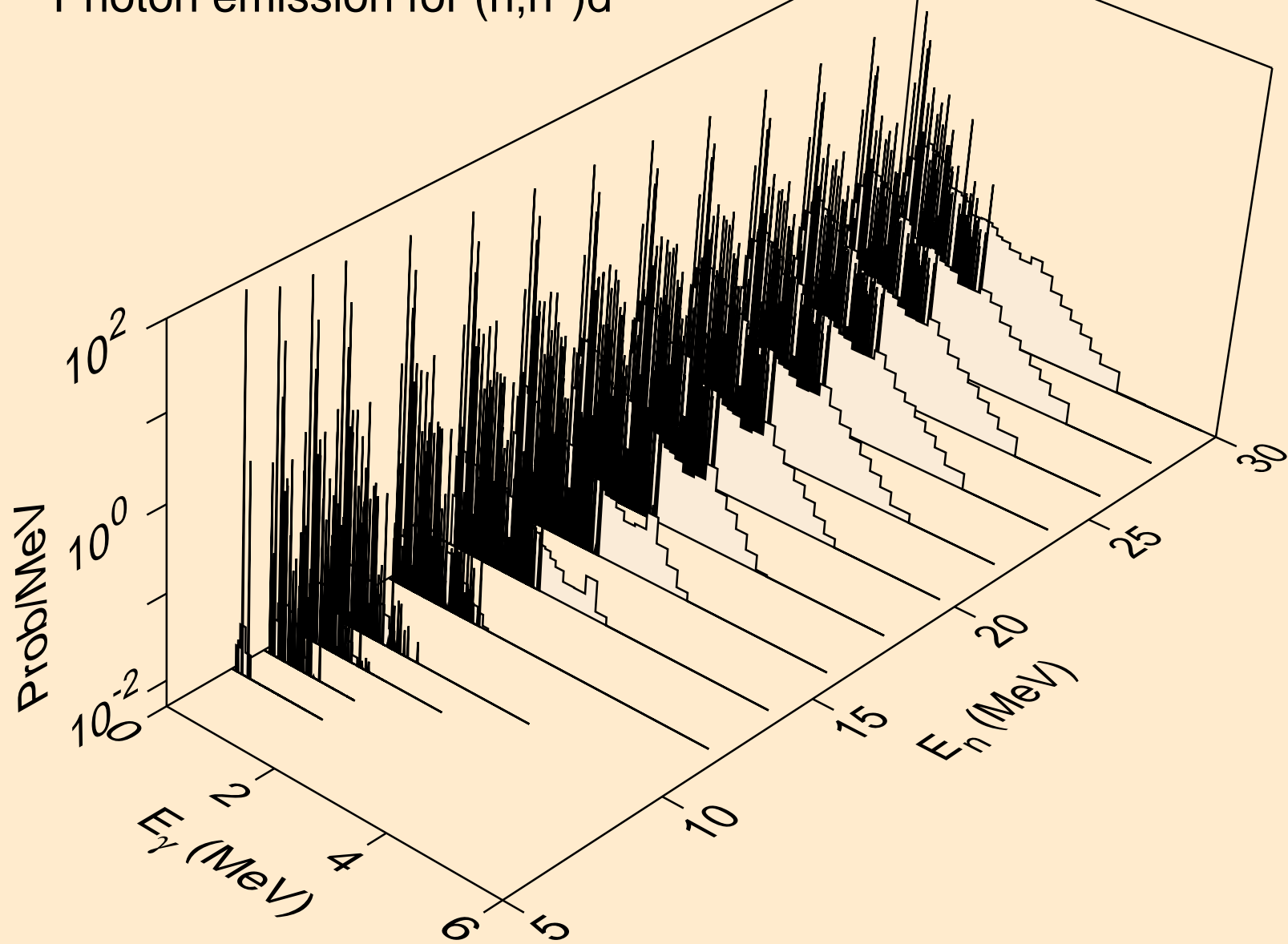

LA141 TRITON ACER TENDL-2021 LIBRARY; T=0.K  
Photon emission for (n,n\*)t

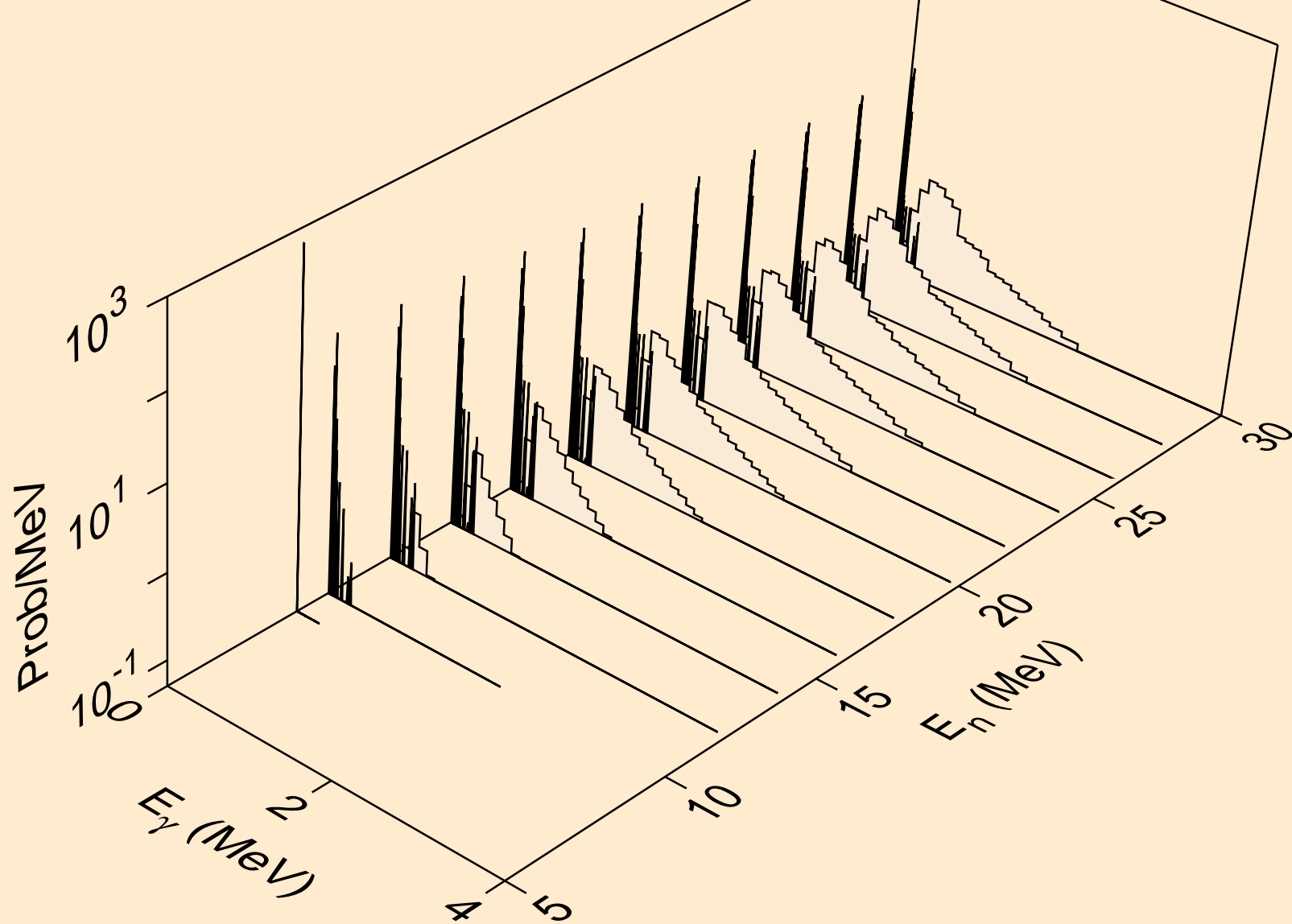

LA141 TRITON ACER TENDL-2021 LIBRARY; T=0.K  
Photon emission for (n,n\*)he3

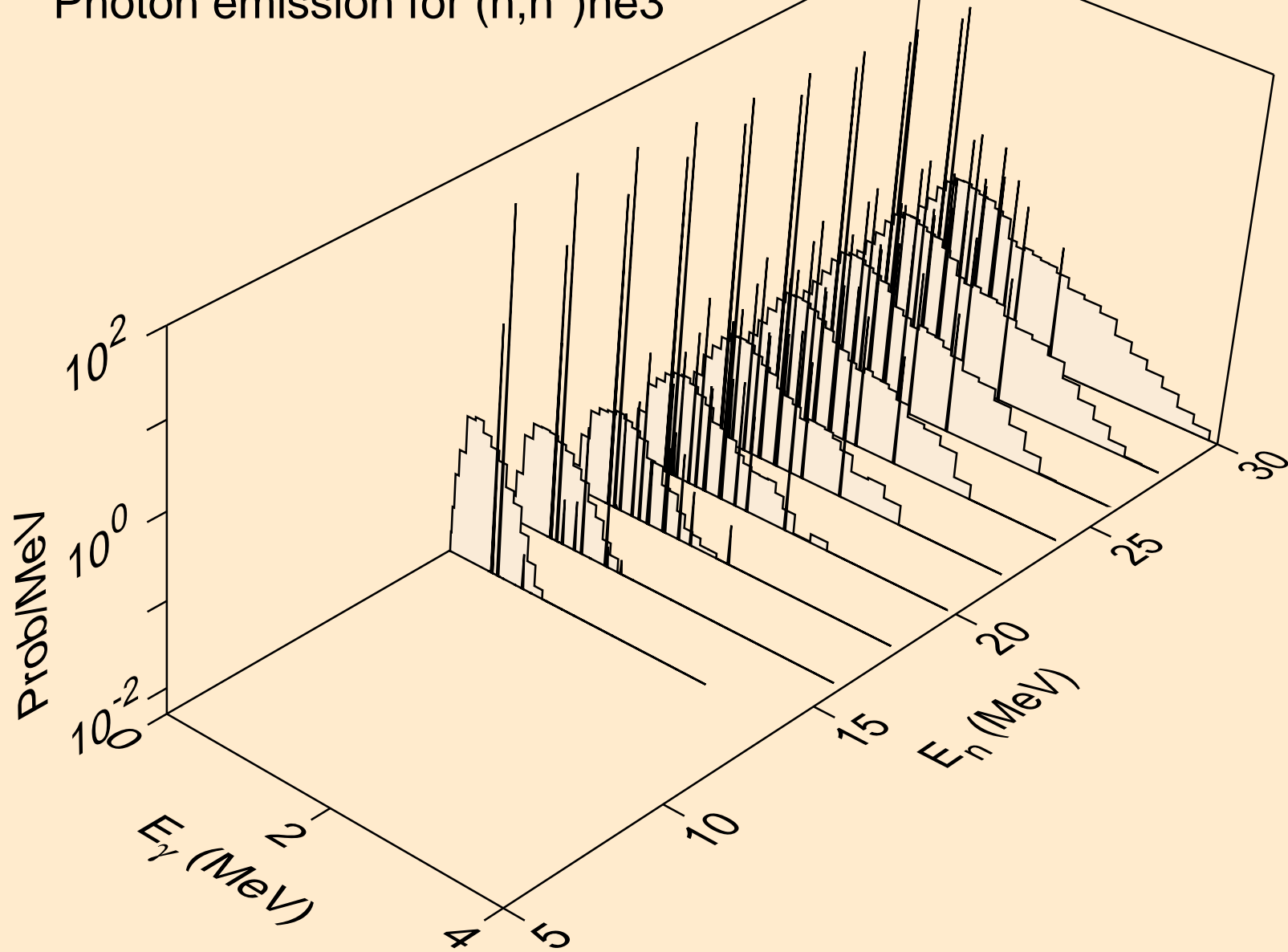

LA141 TRITON ACER TENDL-2021 LIBRARY; T=0.K  
Photon emission for (n,4n)

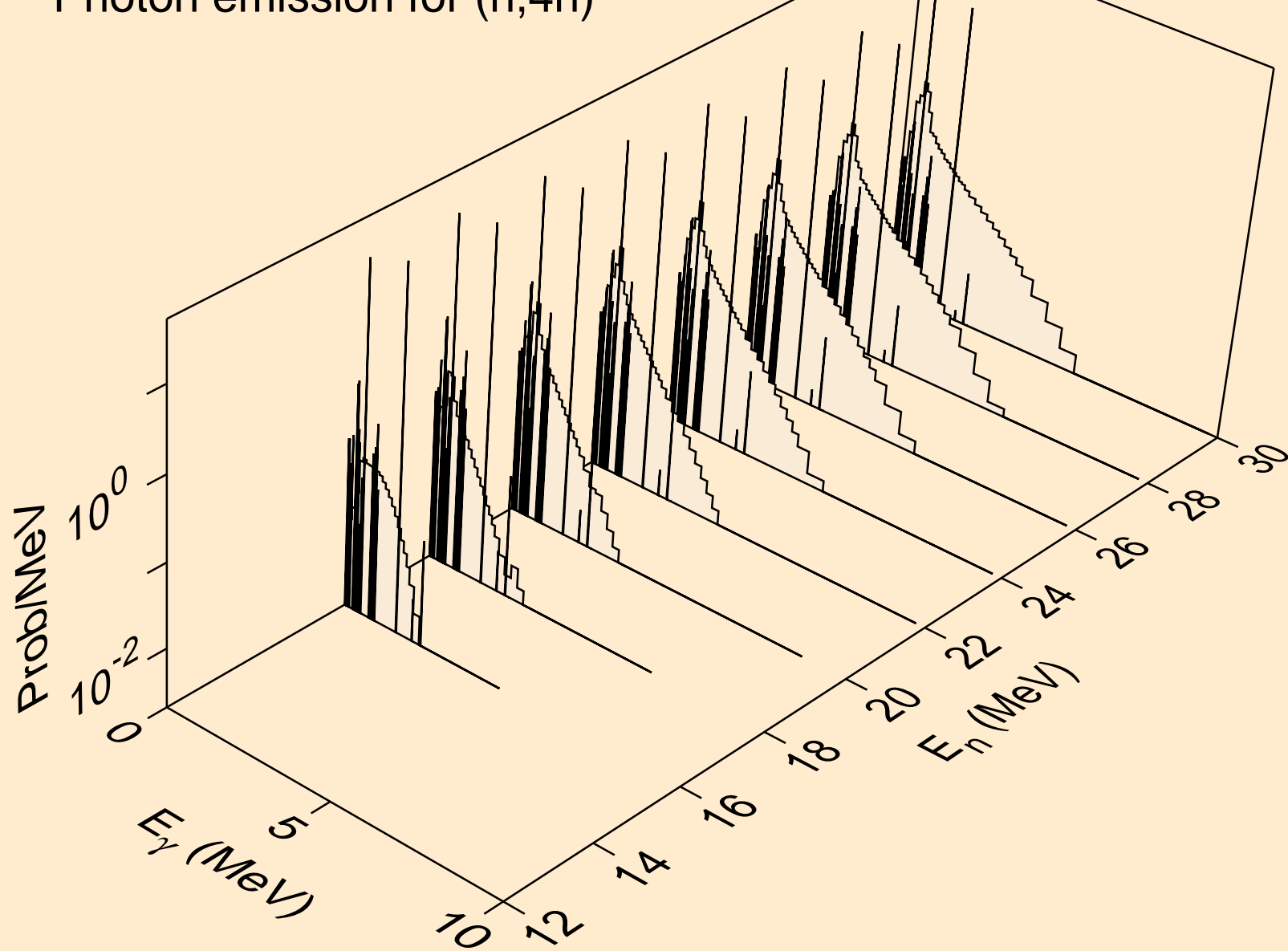

LA141 TRITON ACER TENDL-2021 LIBRARY; T=0.K  
Photon emission for (n,2np)

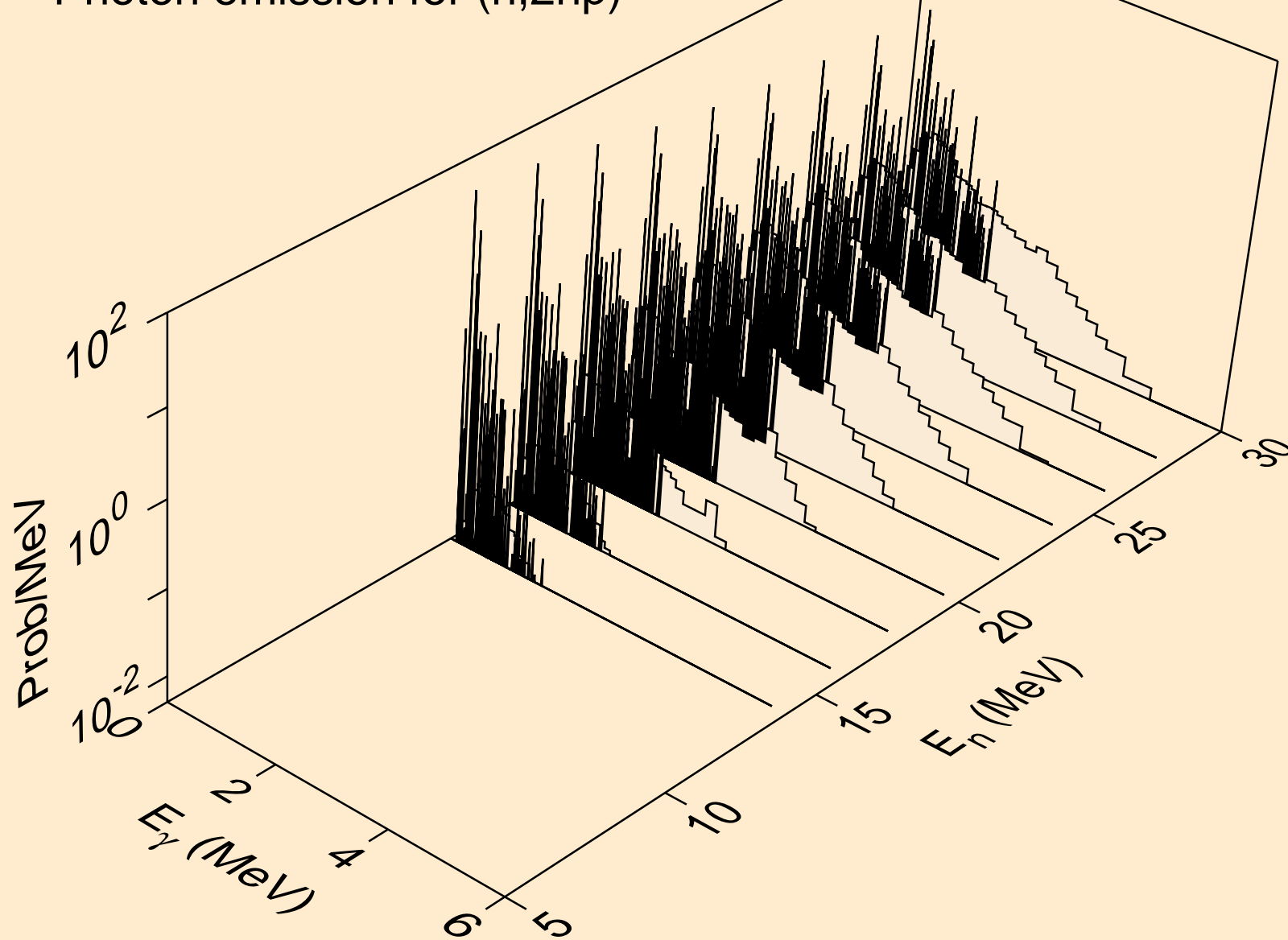

LA141 TRITON ACER TENDL-2021 LIBRARY; T=0.K  
Photon emission for (n,3np)

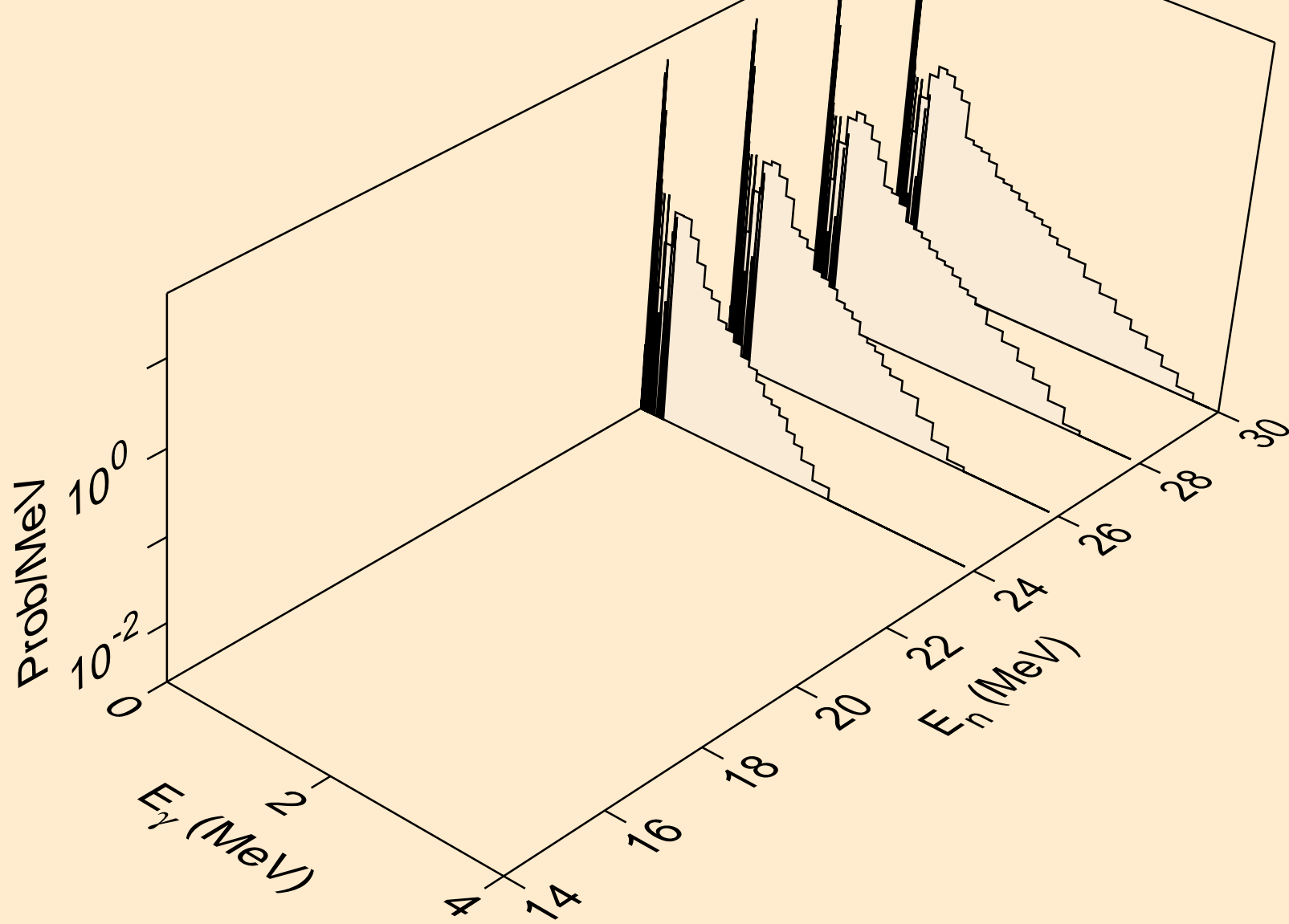

LA141 TRITON ACER TENDL-2021 LIBRARY; T=0.K  
Photon emission for (n,2np)

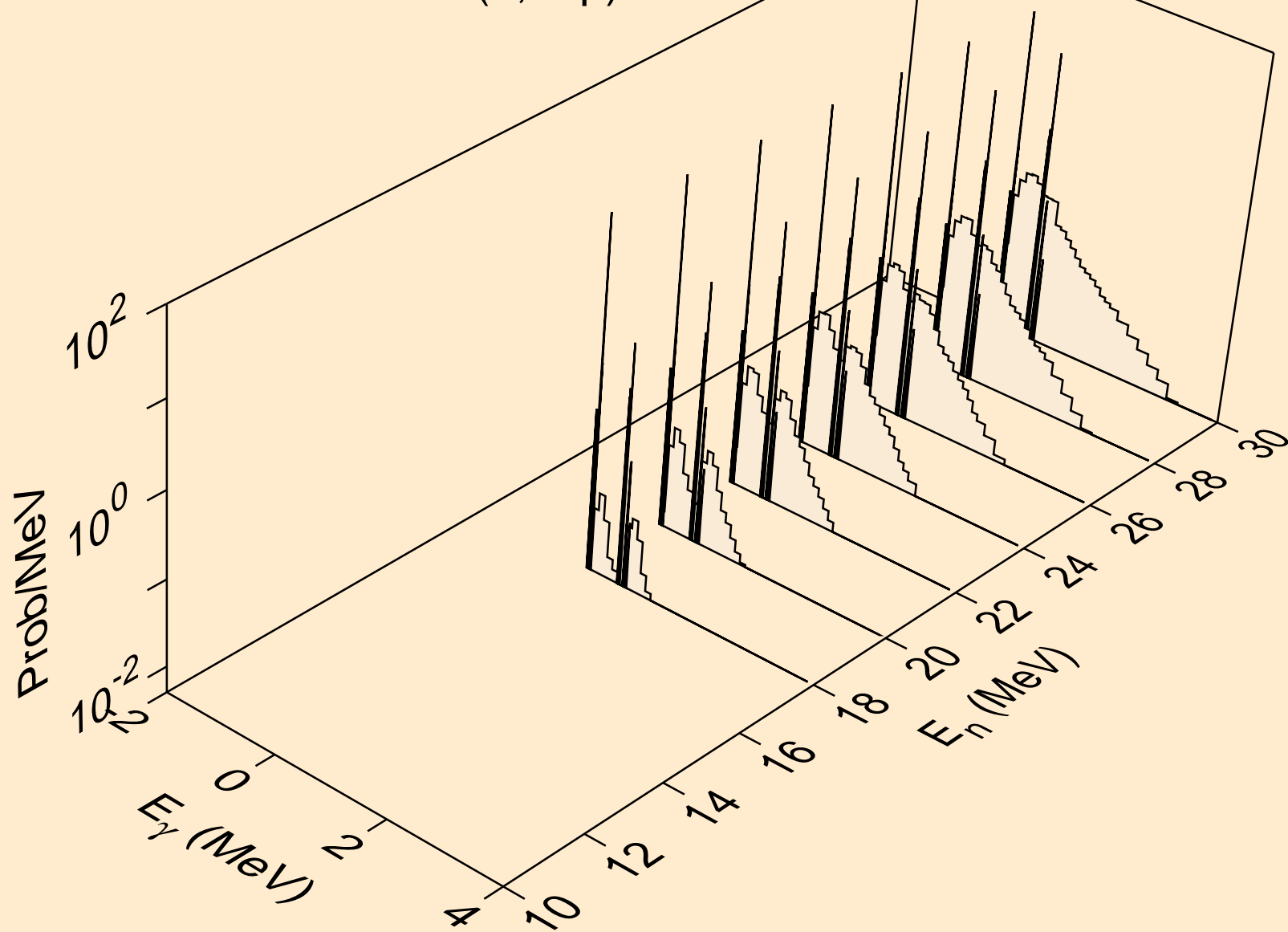

LA141 TRITON ACER TENDL-2021 LIBRARY; T=0.K  
Photon emission for (n,npa)

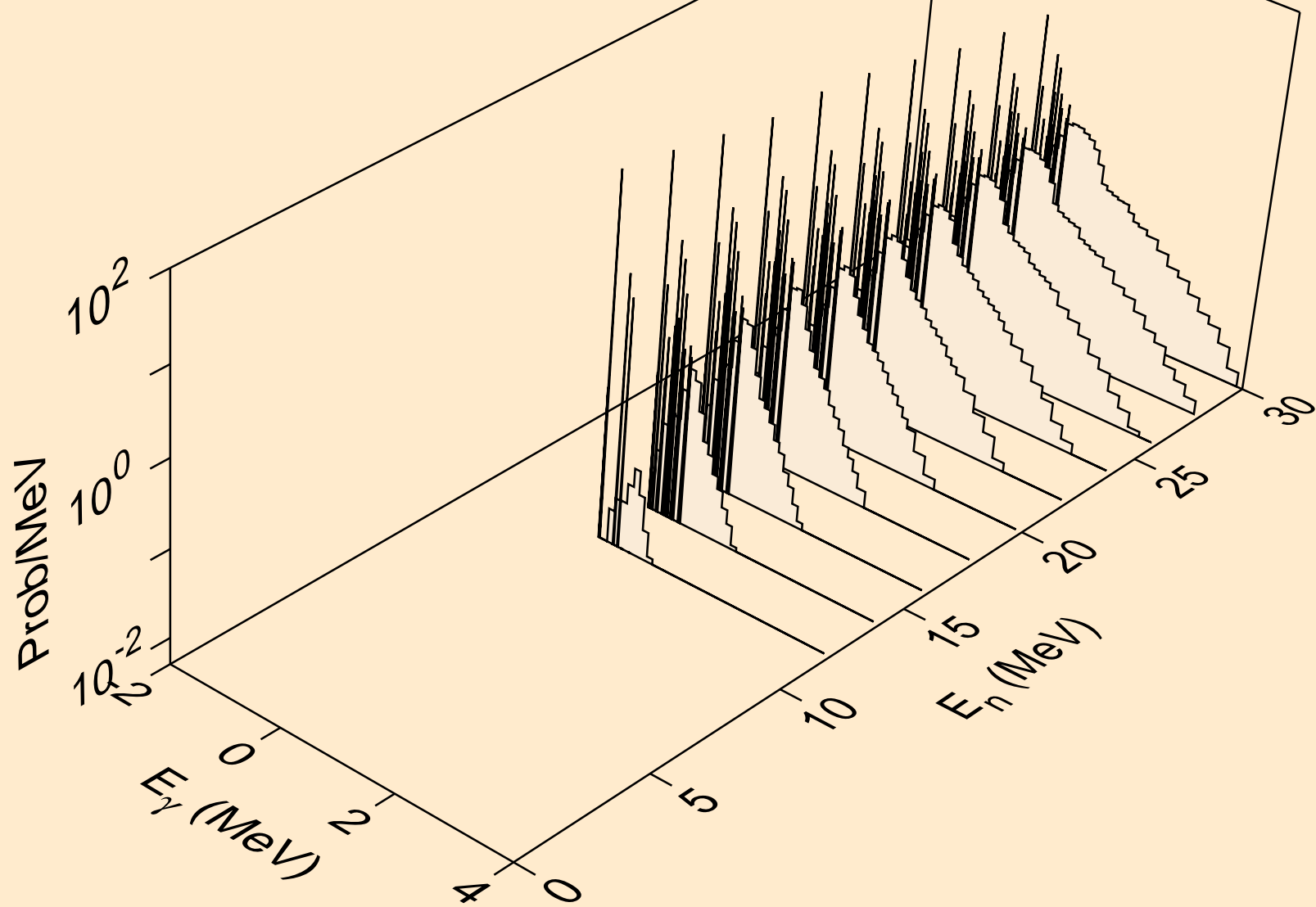



LA141 TRITON ACER TENDL-2021 LIBRARY; T=0.K  
Photon emission for (n,gma)

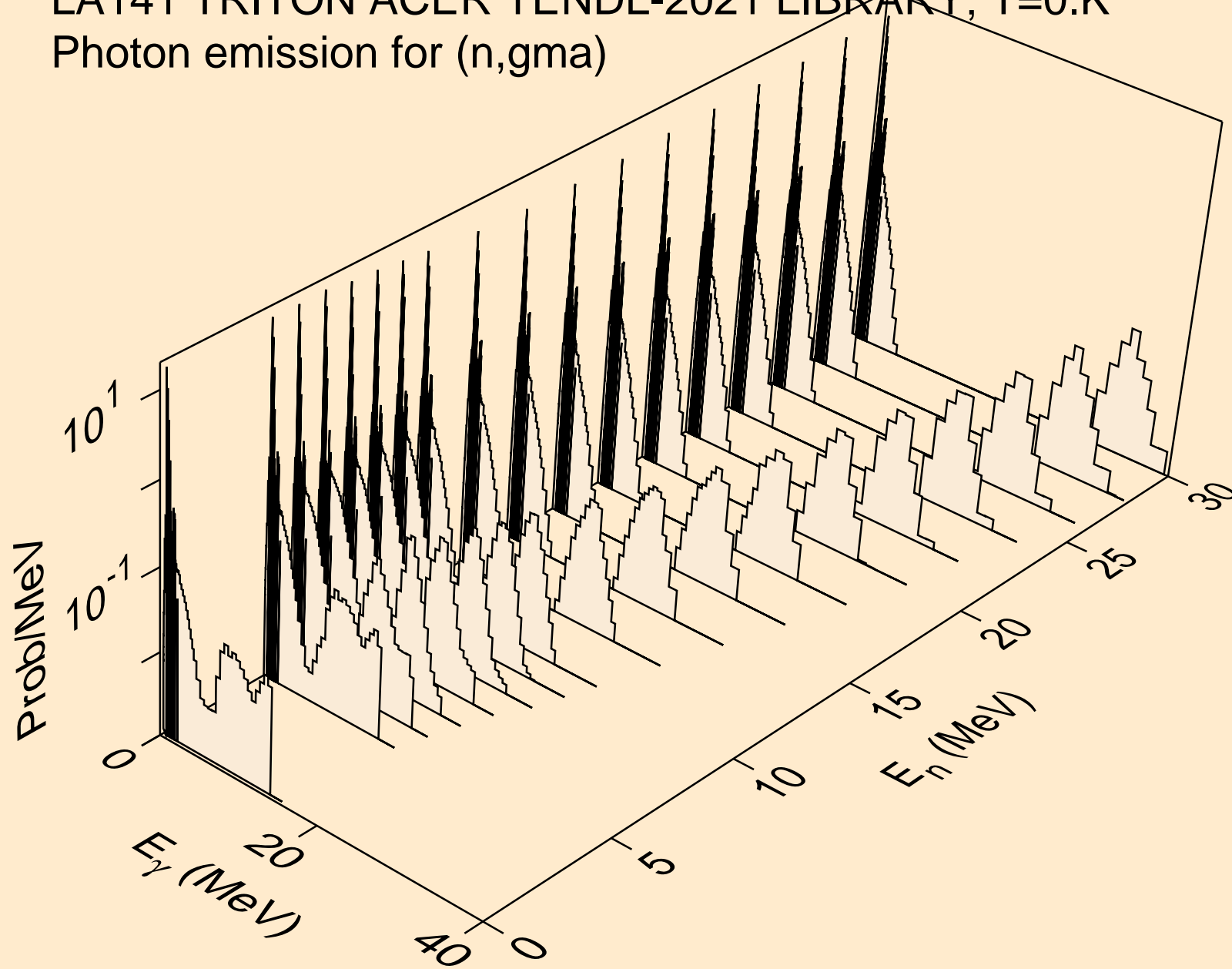

LA141 TRITON ACER TENDL-2021 LIBRARY; T=0.K  
Photon emission for (n,p)

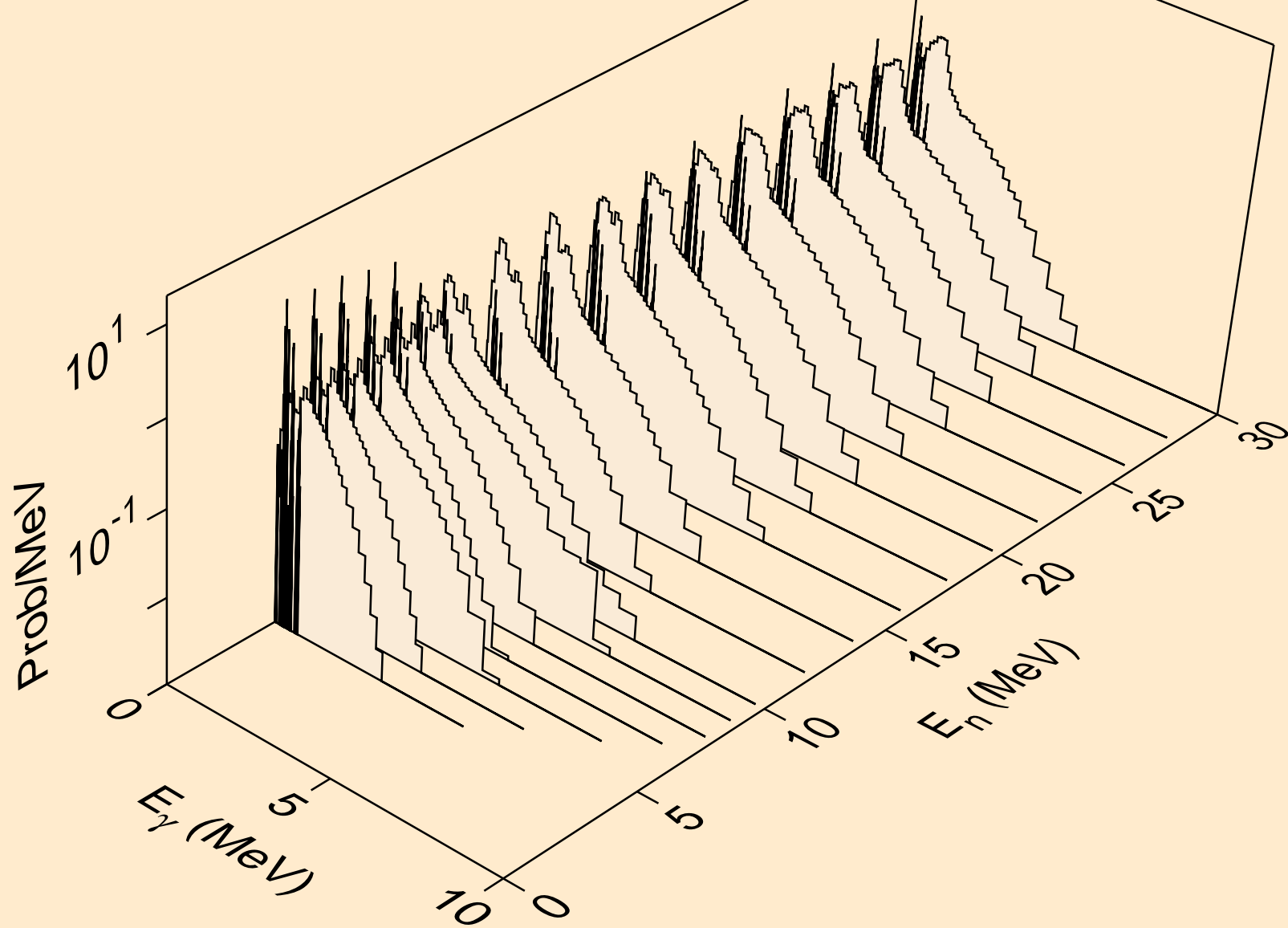

LA141 TRITON ACER TENDL-2021 LIBRARY; T=0.K  
Photon emission for (n,d)

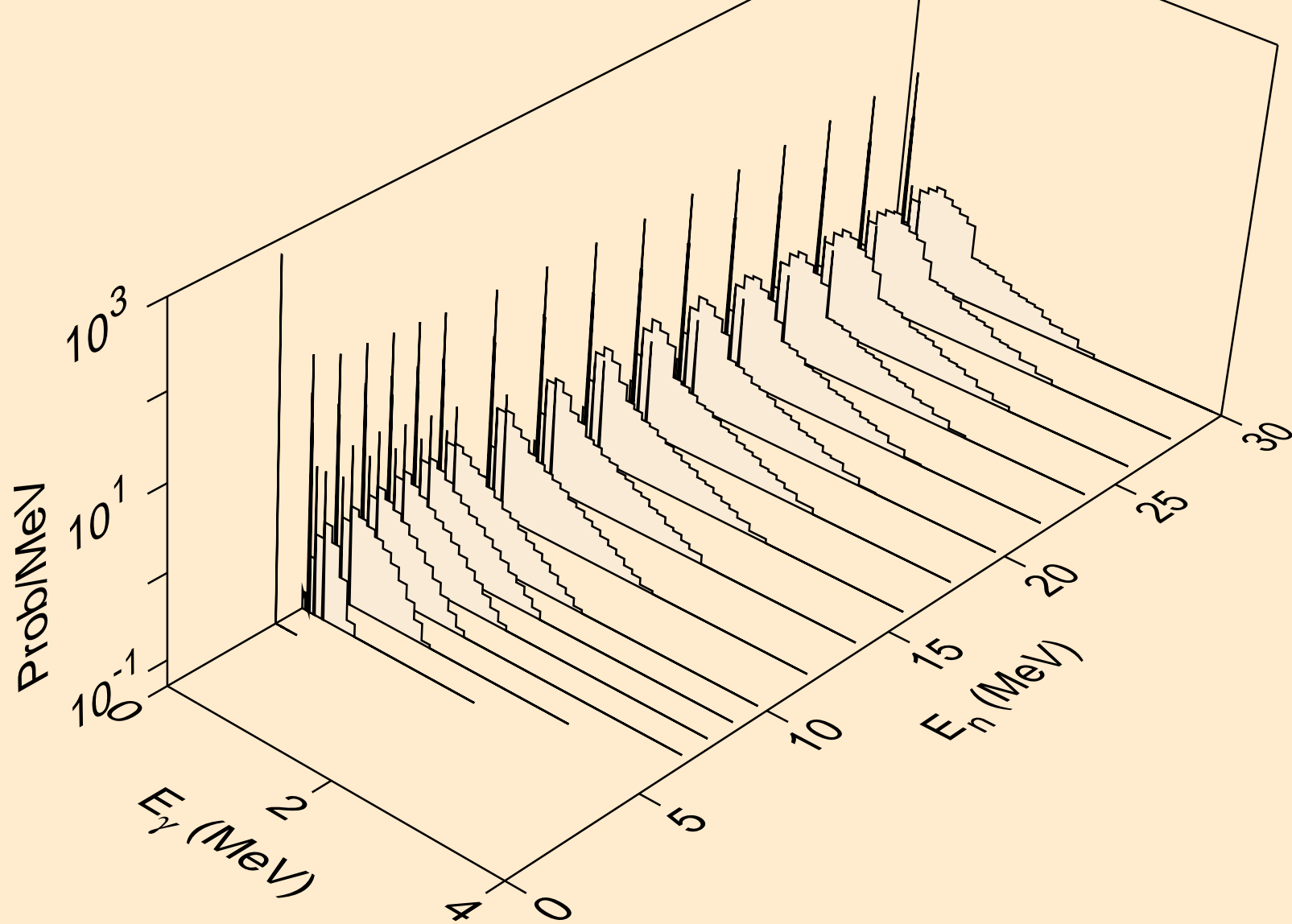

LA141 TRITON ACER TENDL-2021 LIBRARY; T=0.K  
Photon emission for inelastic

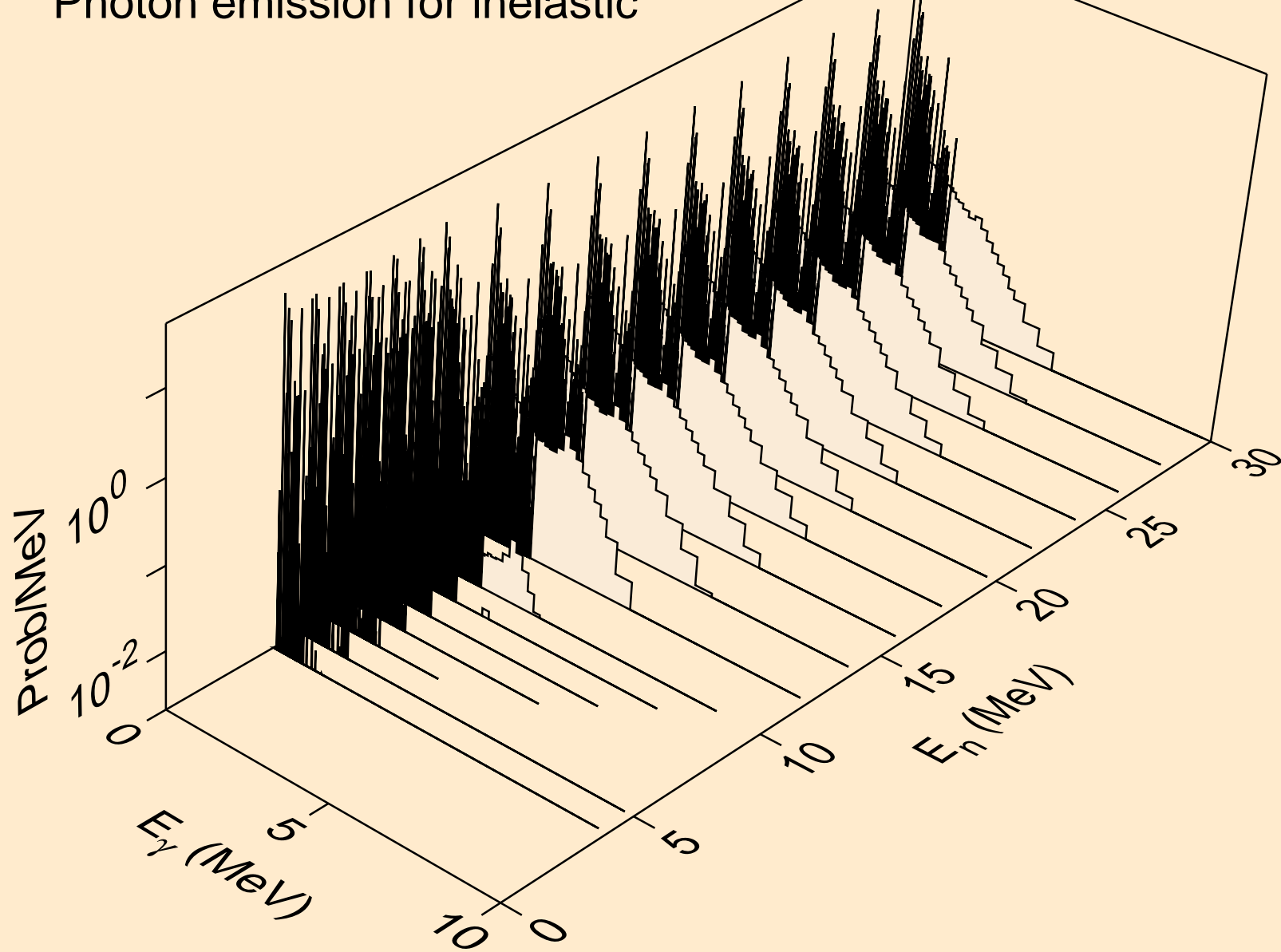

LA141 TRITON ACER TENDL-2021 LIBRARY; T=0.K  
Photon emission for (n,he3)

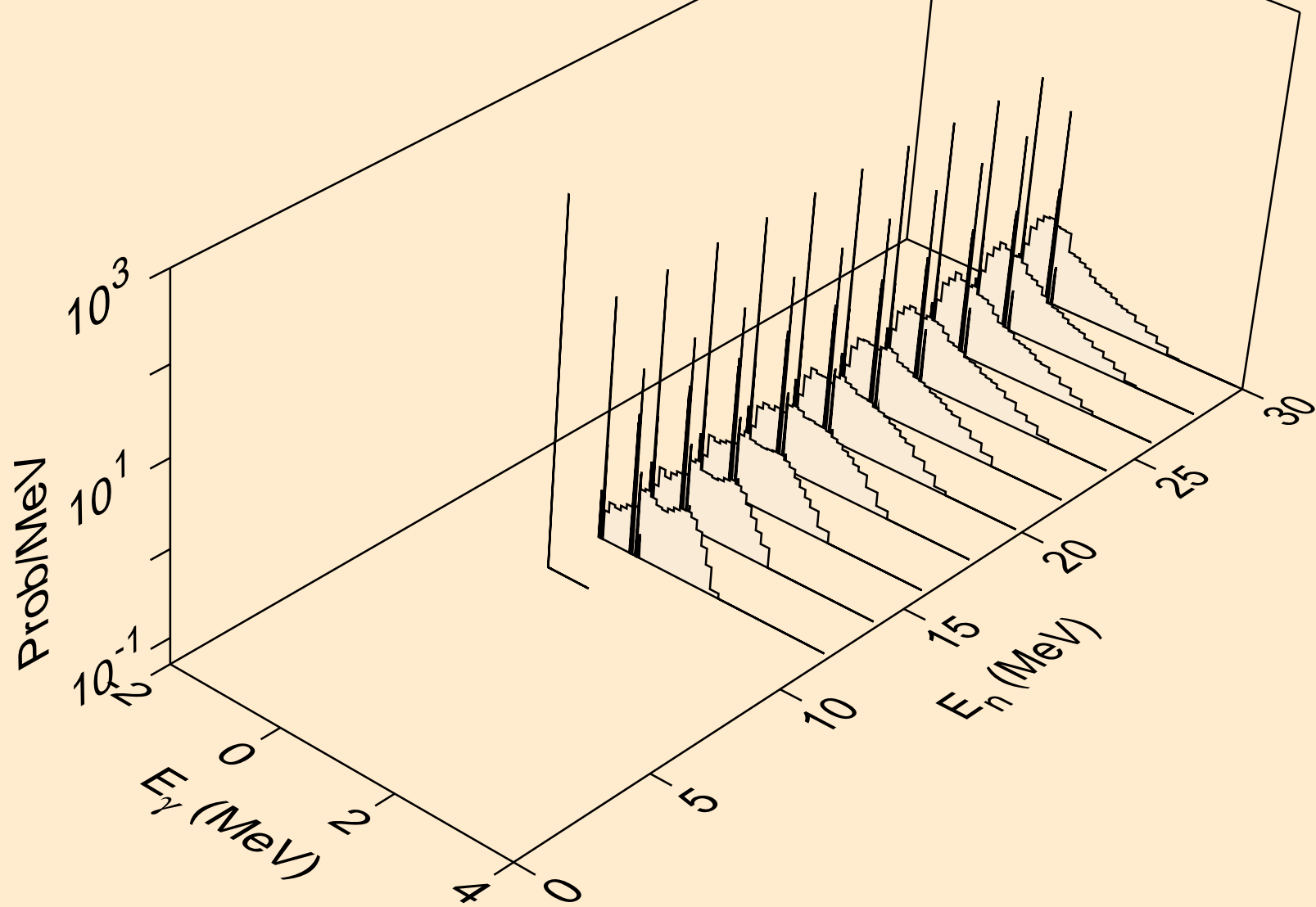

LA141 TRITON ACER TENDL-2021 LIBRARY; T=0.K  
Photon emission for (n,a)

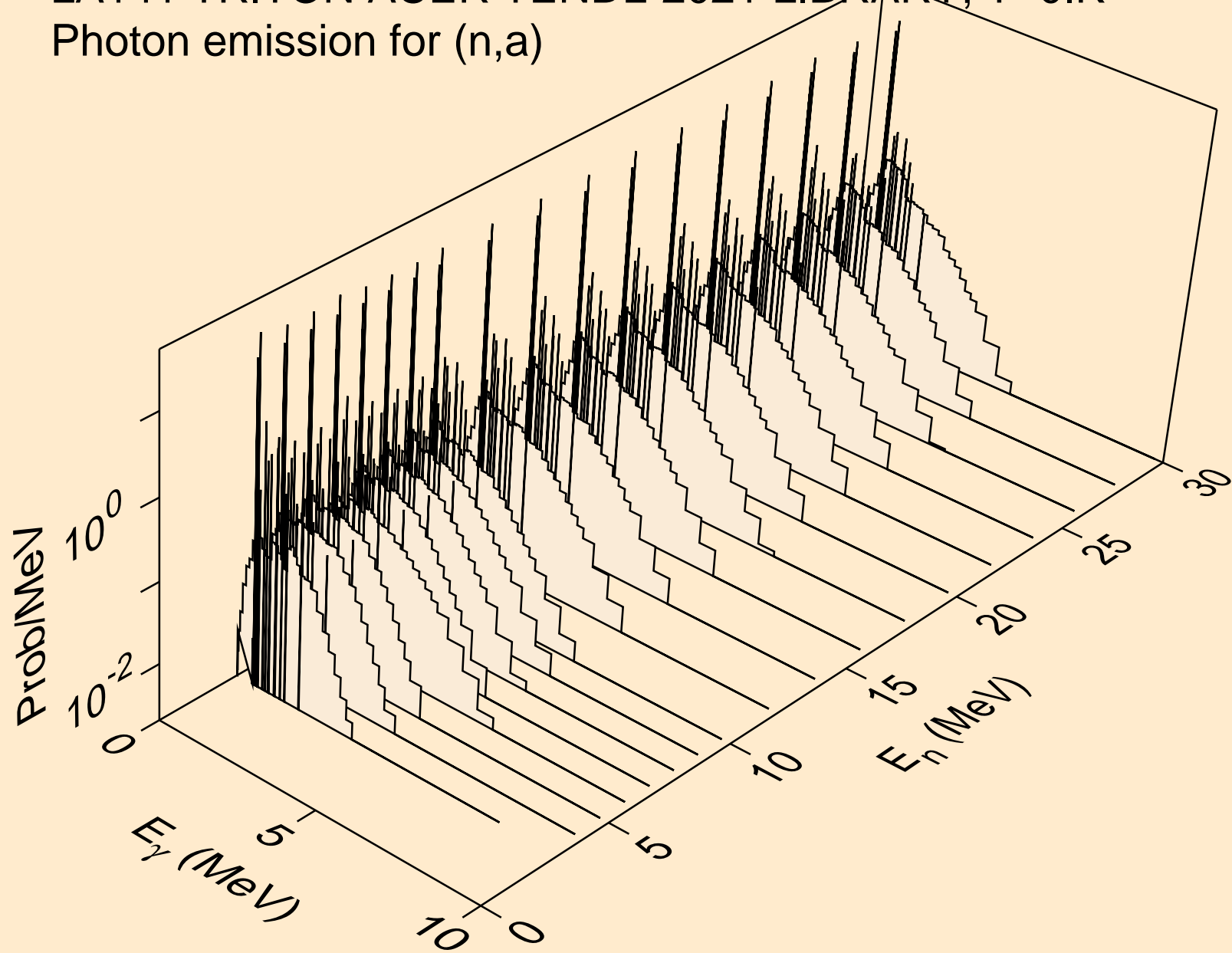

LA141 TRITON ACER TENDL-2021 LIBRARY; T=0.K  
Photon emission for (n,2a)

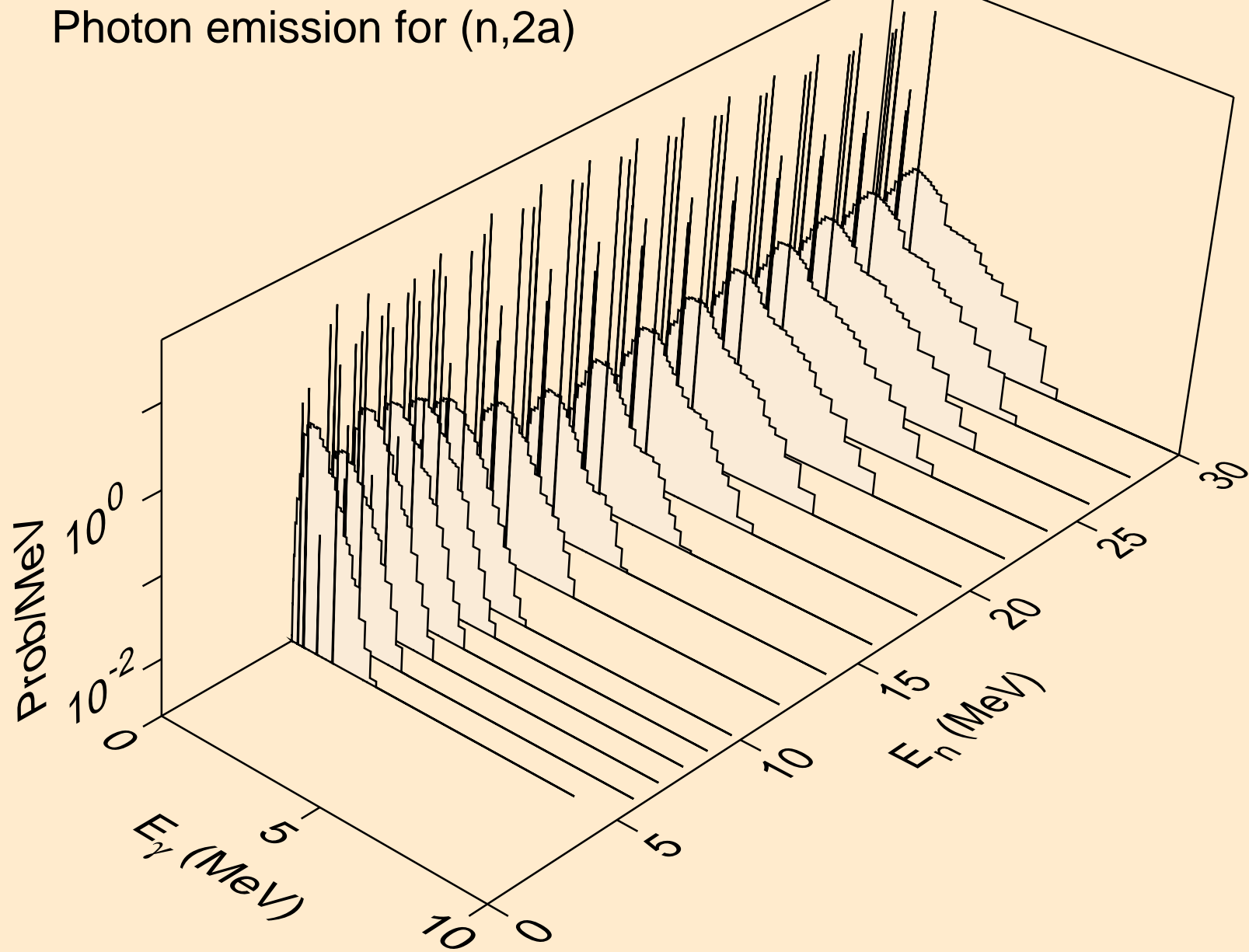

LA141 TRITON ACER TENDL-2021 LIBRARY; T=0.K  
Photon emission for (n,2p)

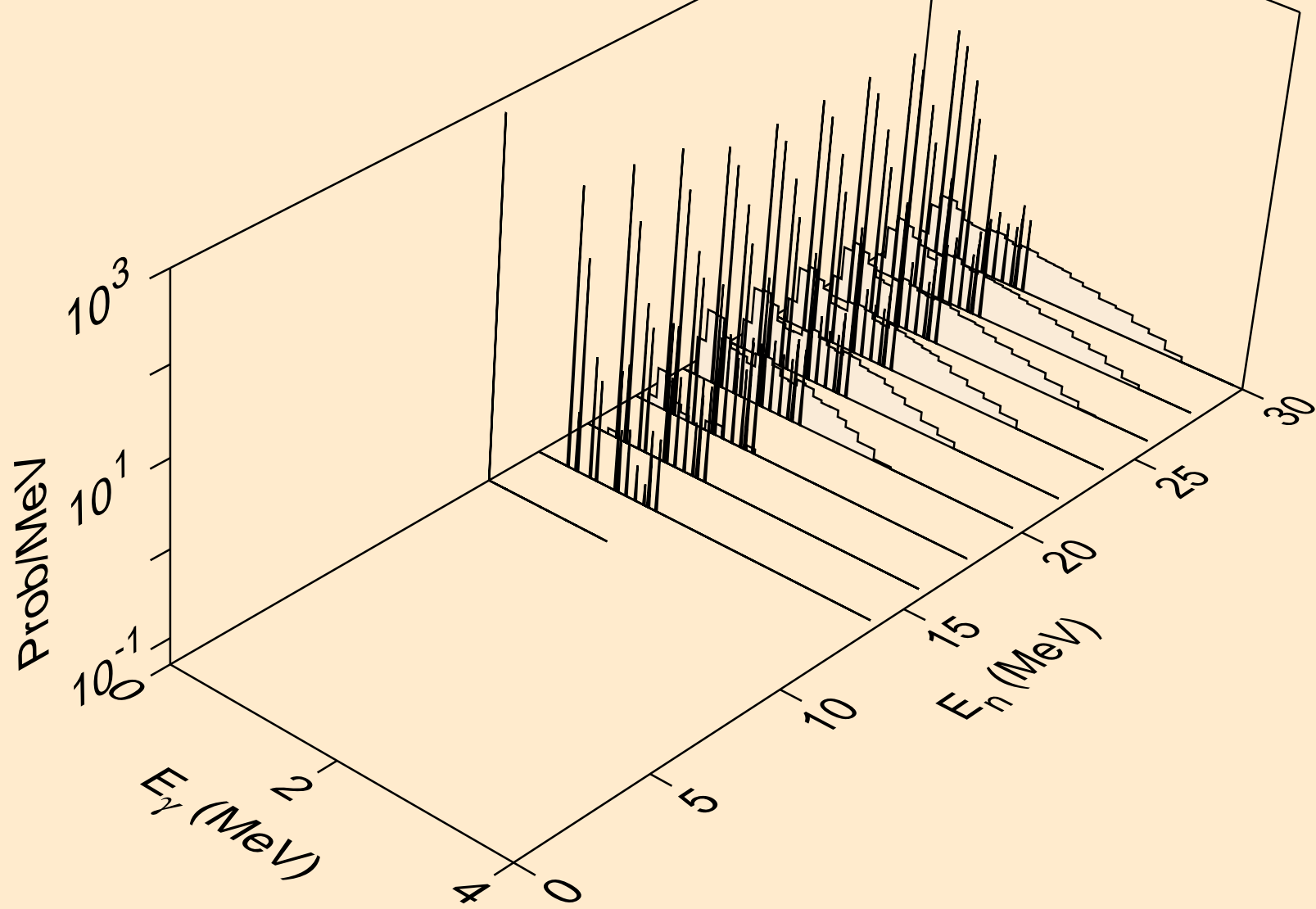



LA141 TRITON ACER TENDL-2021 LIBRARY; T=0.K  
Photon emission for (n,pa)

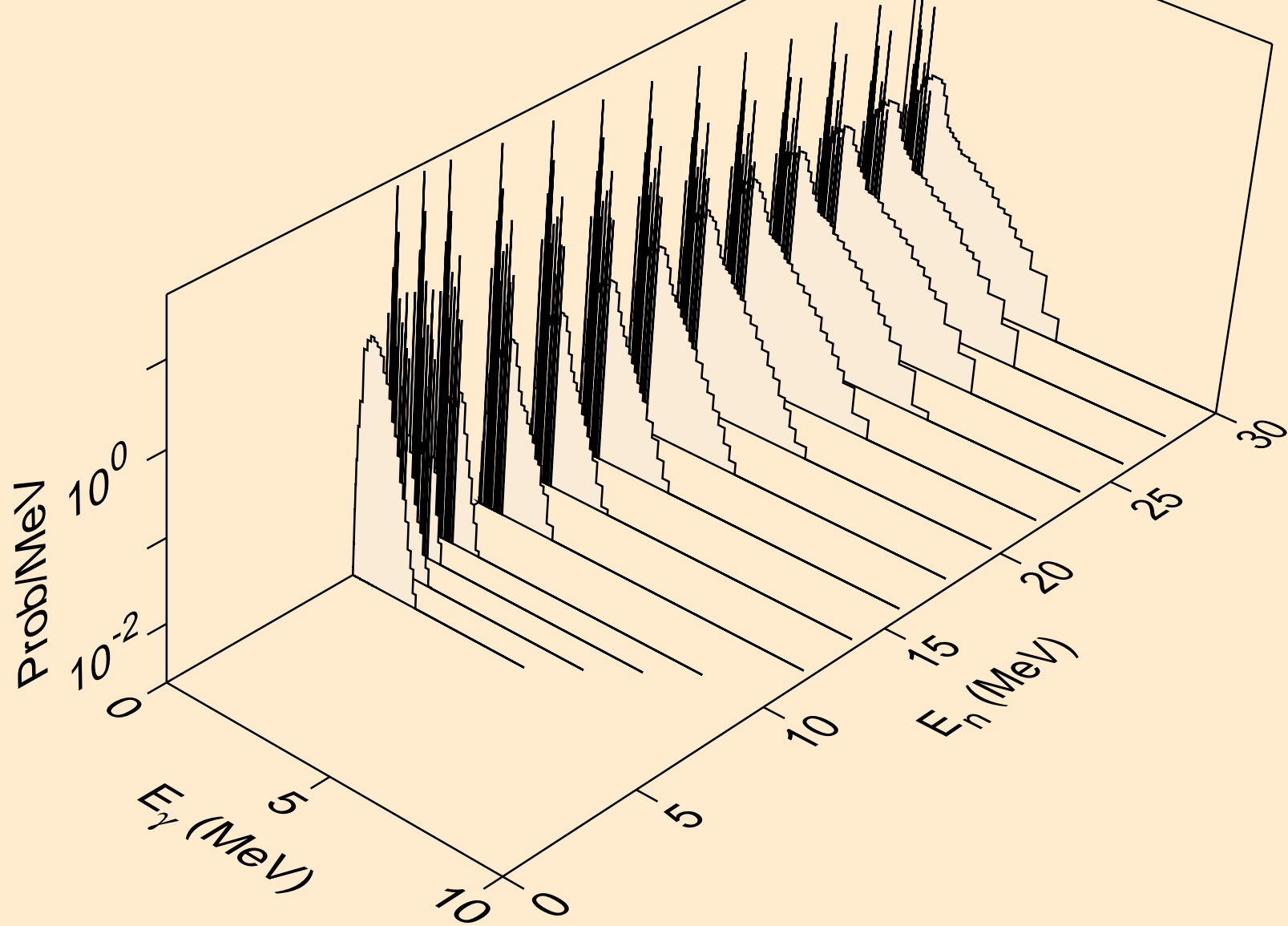

LA141 TRITON ACER TENDL-2021 LIBRARY; T=0.K  
Photon emission for (n,pd)

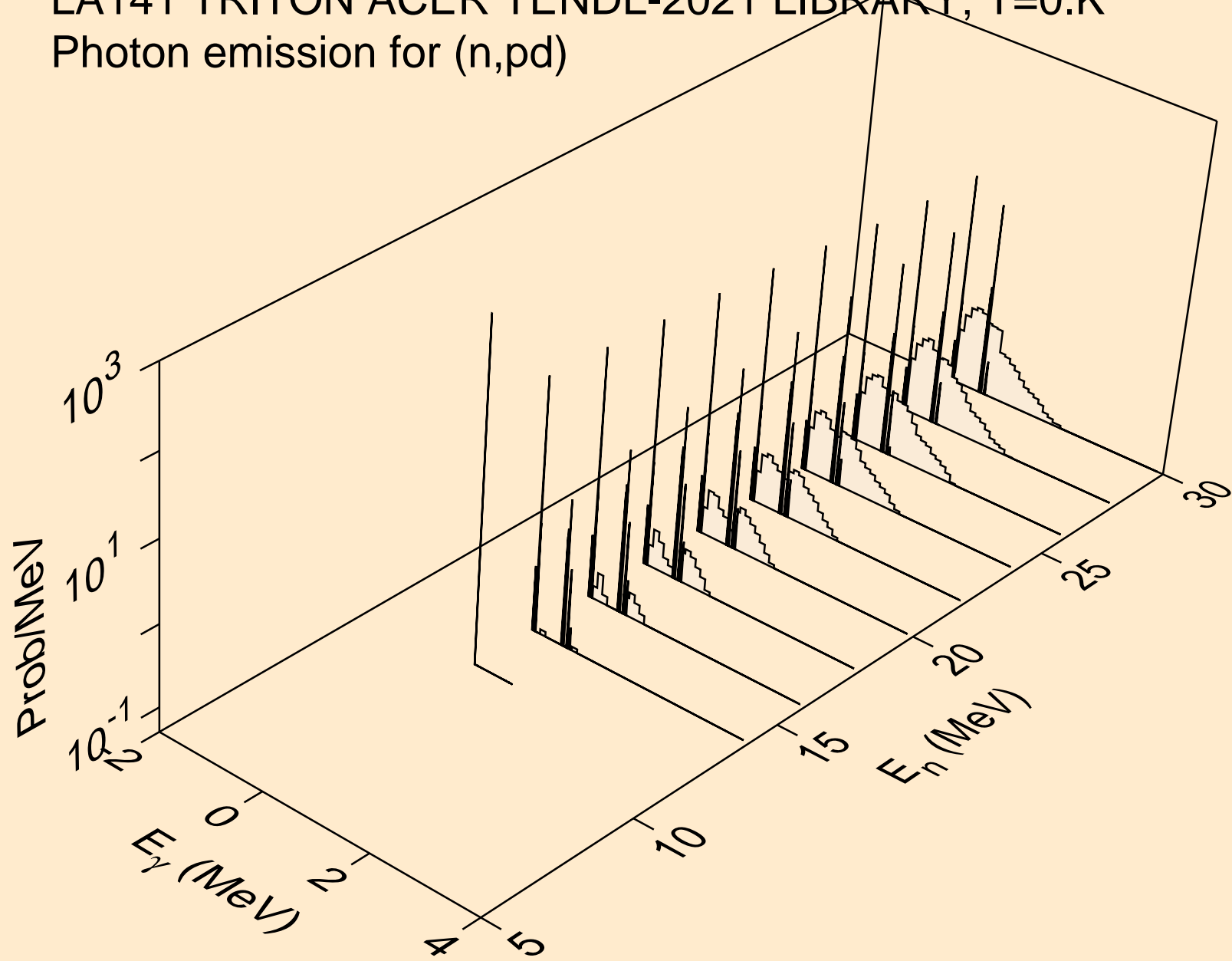

LA141 TRITON ACER TENDL-2021 LIBRARY; T=0.K  
Photon emission for (n,pt)

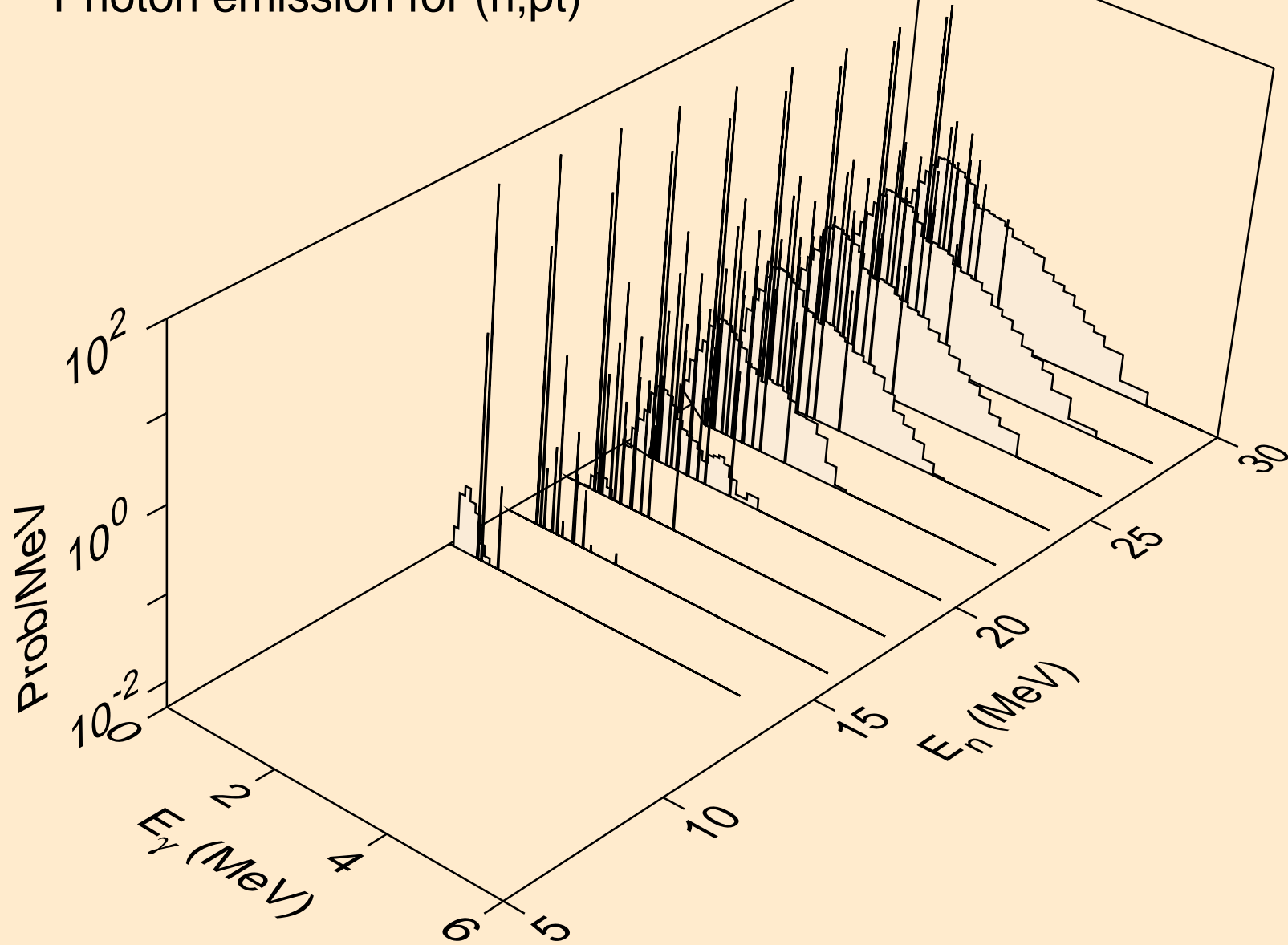

LA141 TRITON ACER TENDL-2021 LIBRARY; T=0.K  
Photon emission for (n,da)

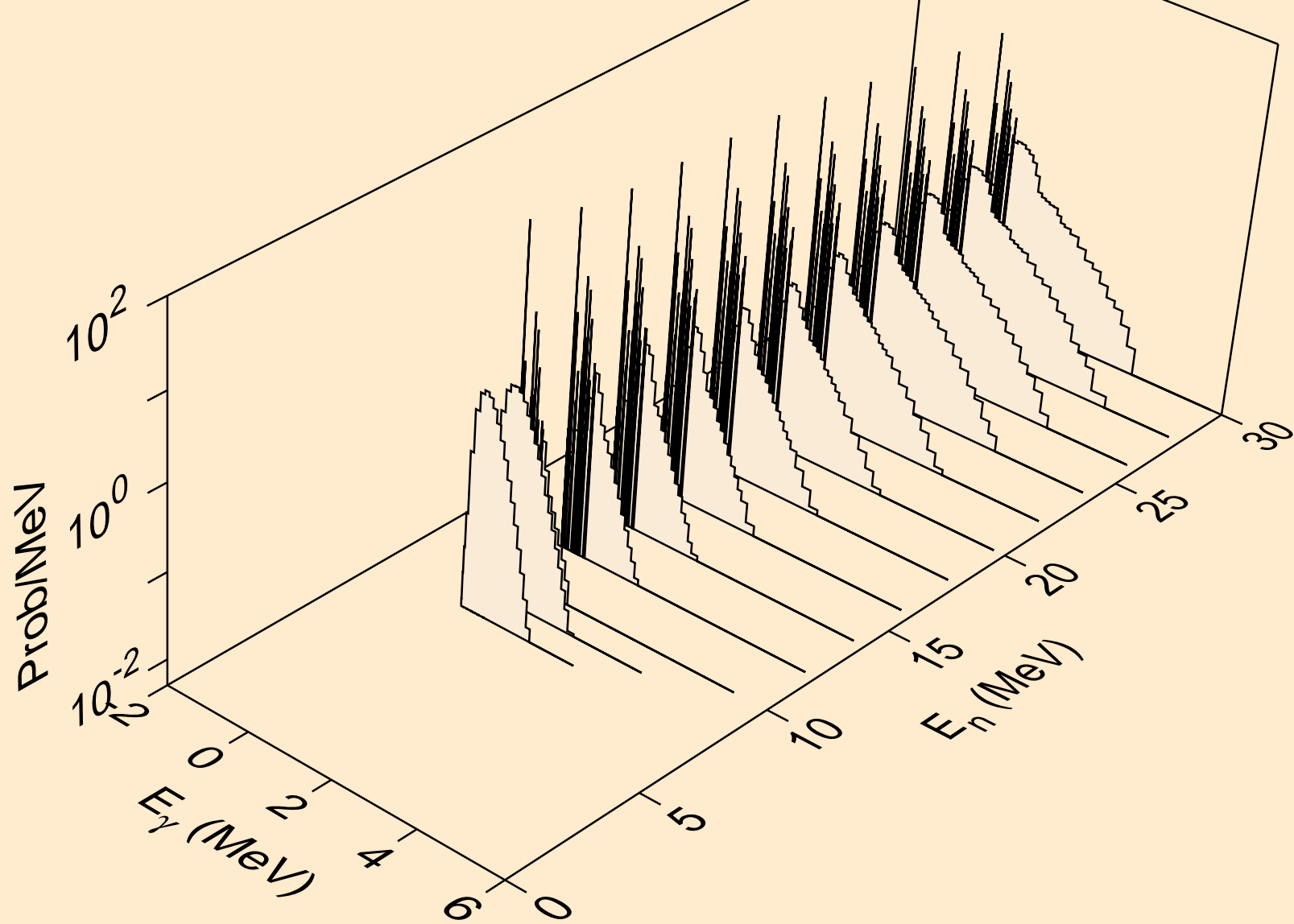

LA141 TRITON ACER TENDL-2021 LIBRARY; T=0.K  
Particle heating contributions

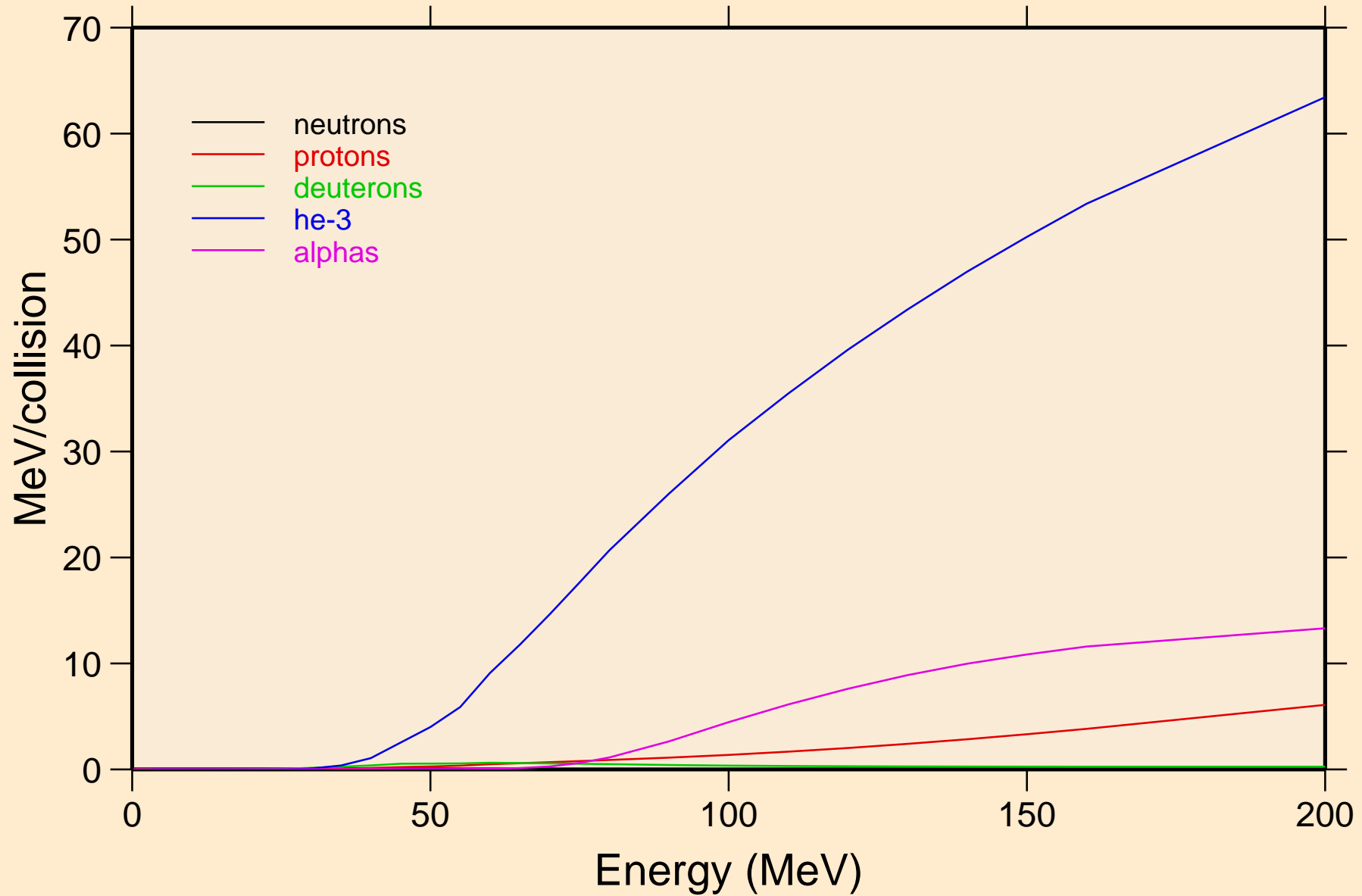

LA141 TRITON ACER TENDL-2021 LIBRARY; T=0.K  
Recoil Heating

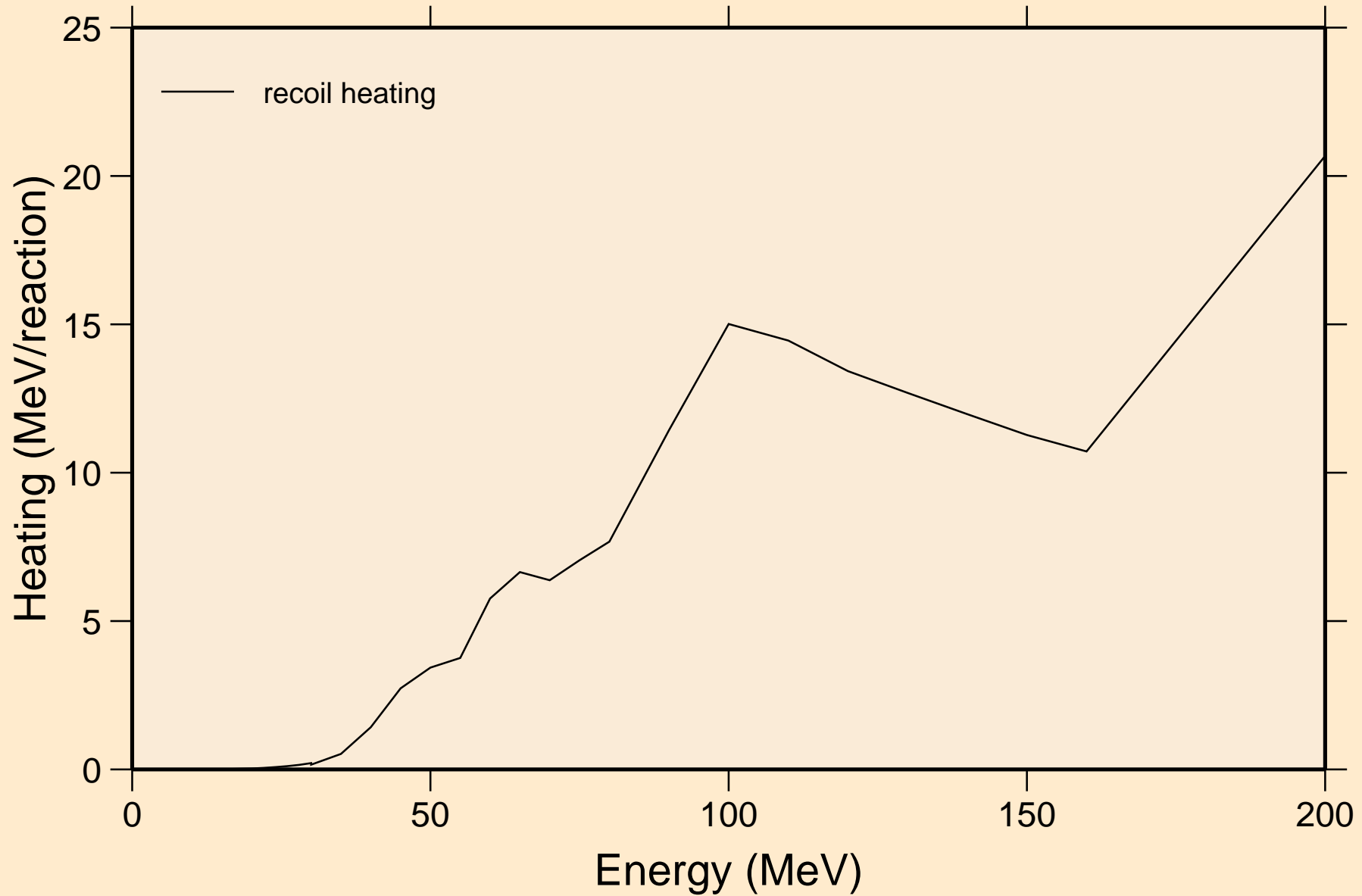

LA141 TRITON ACER TENDL-2021 LIBRARY; T=0.K  
Particle production cross sections

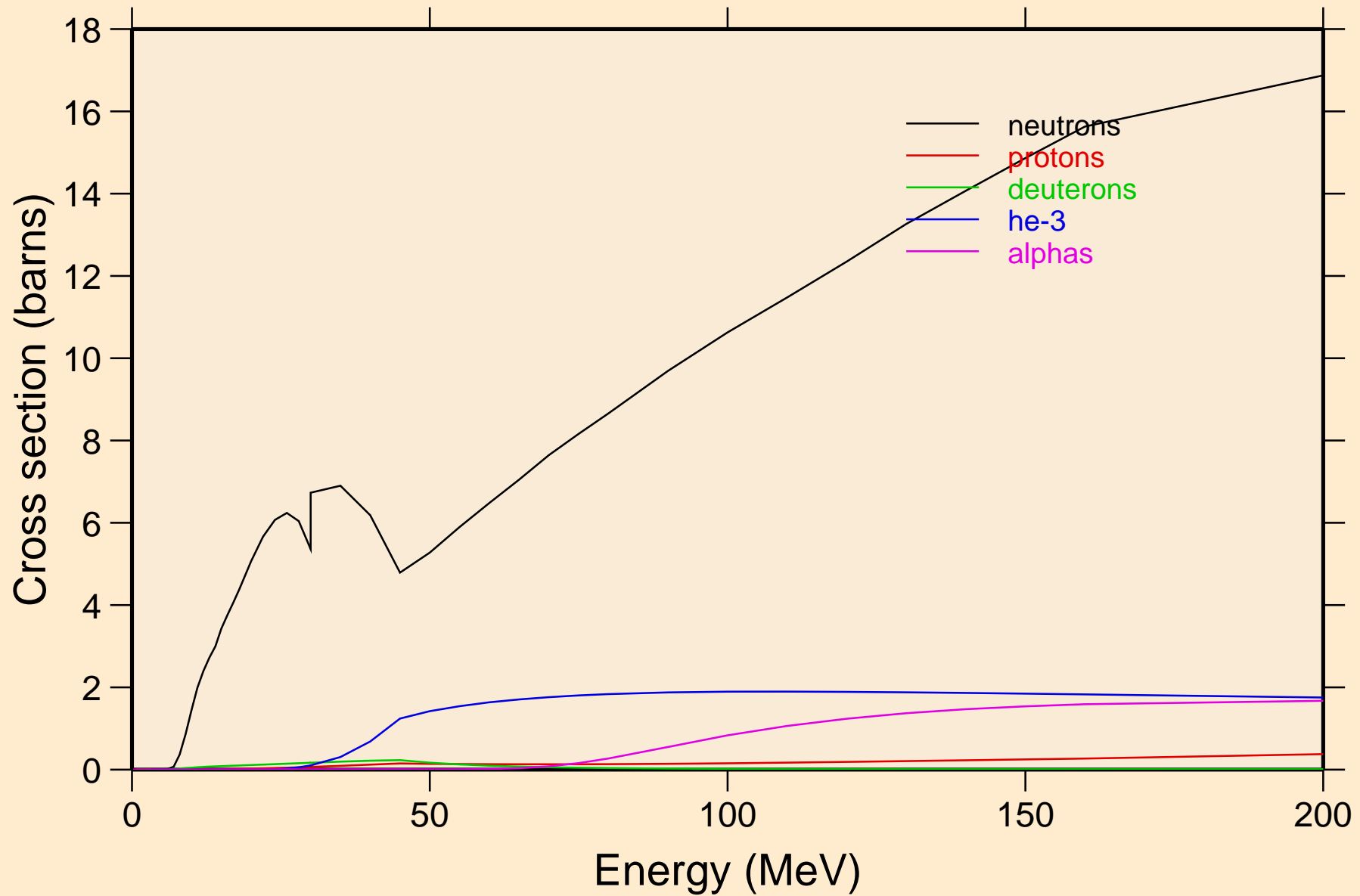

LA141 TRITON ACER TENDL-2021 LIBRARY; T=0.K  
neutrons from (t,n)

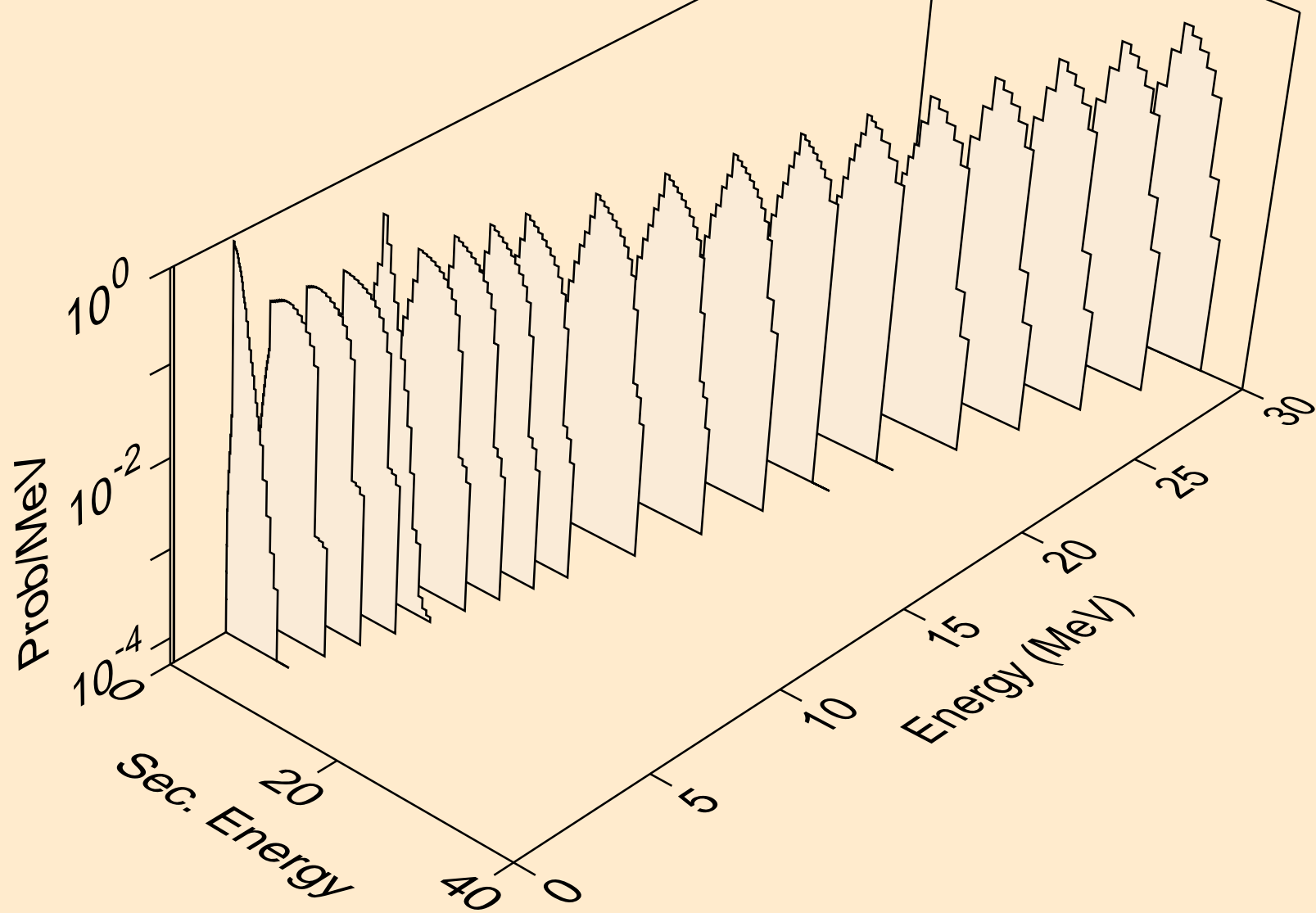



LA141 TRITON ACER TENDL-2021 LIBRARY; T=0.K  
neutrons from (t,x)

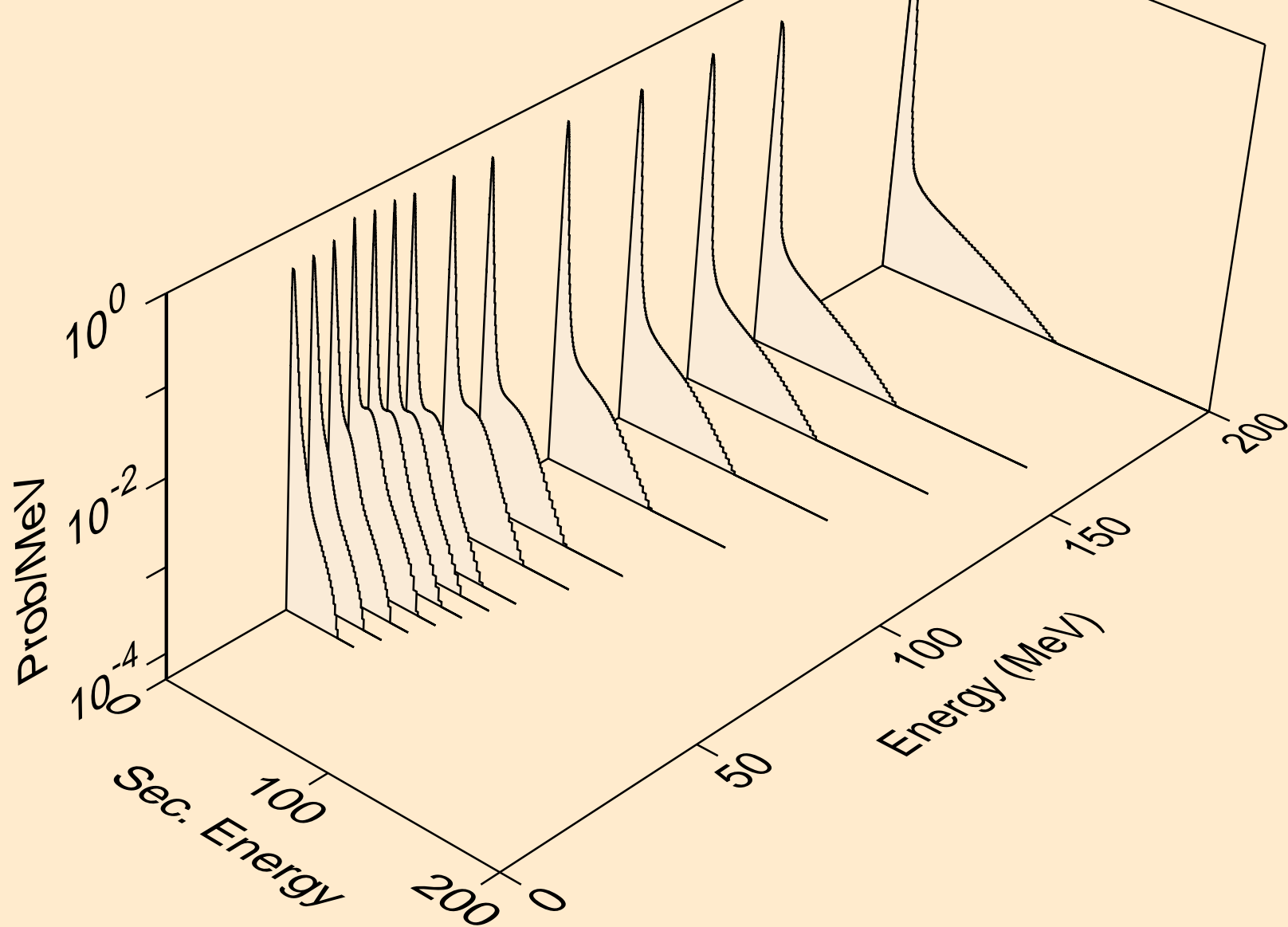

LA141 TRITON ACER TENDL-2021 LIBRARY; T=0.K  
neutrons from (t,2nd)

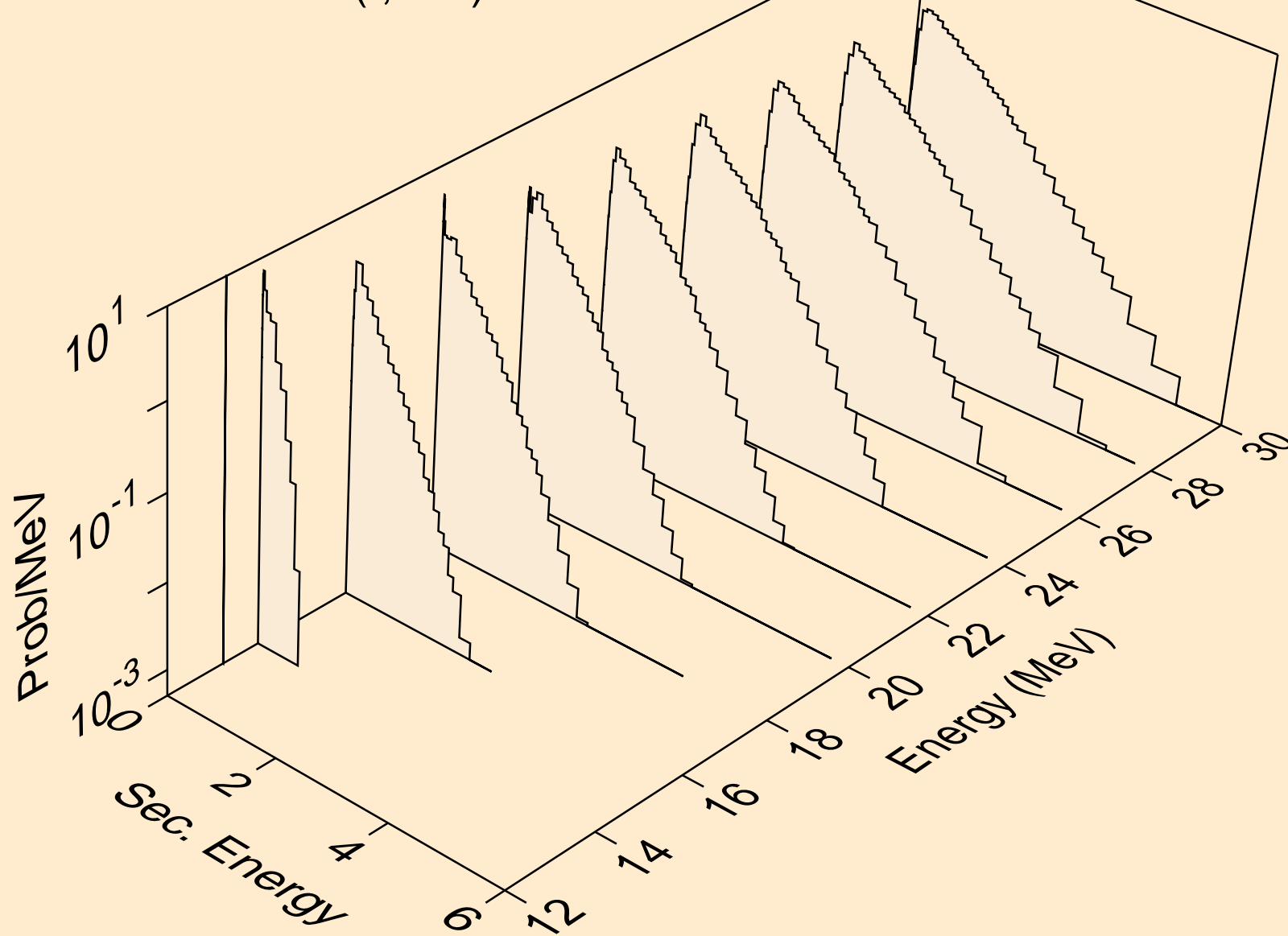

LA141 TRITON ACER TENDL-2021 LIBRARY; T=0.K  
neutrons from (t,2n)

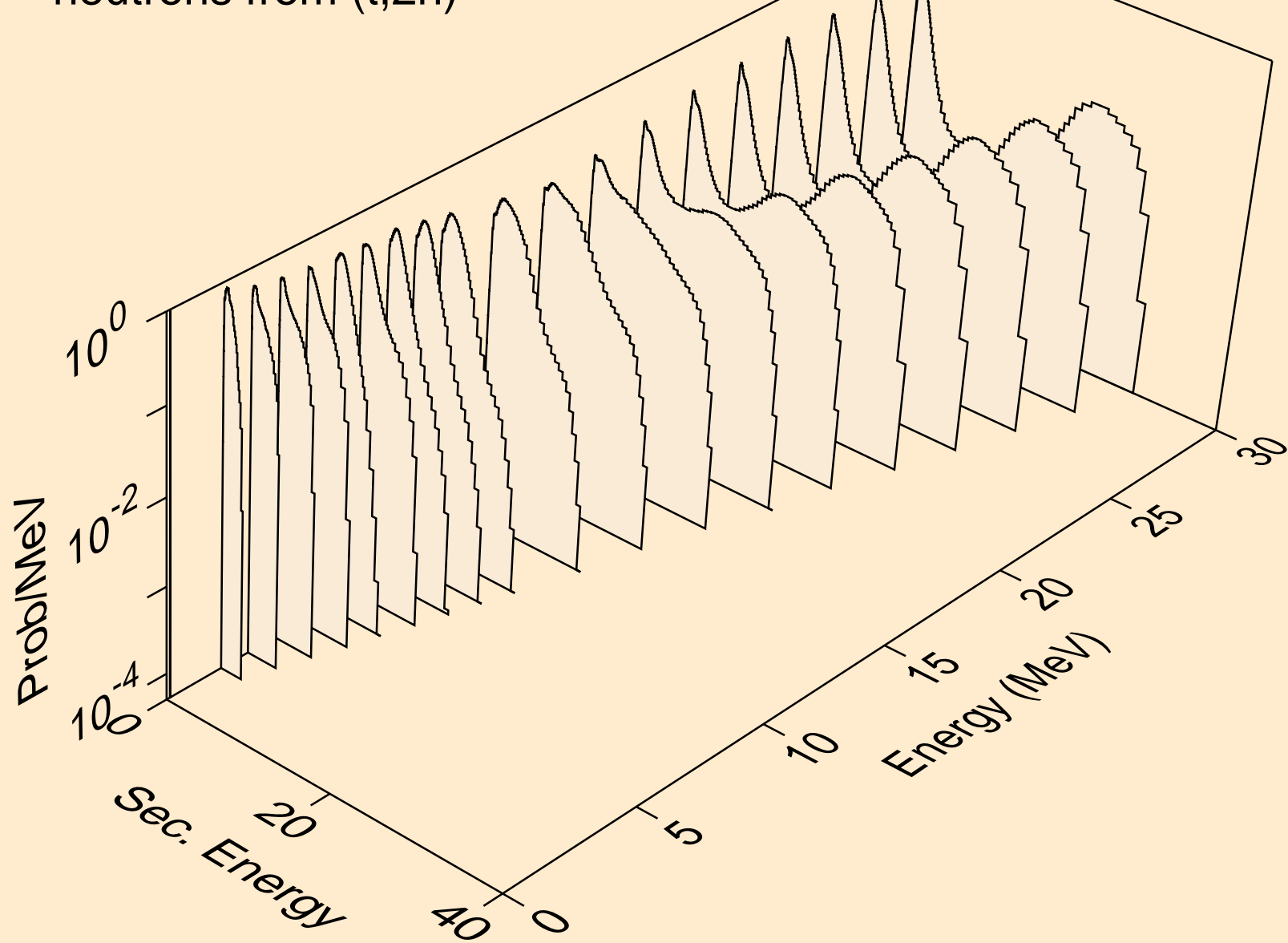

LA141 TRITON ACER TENDL-2021 LIBRARY; T=0.K  
neutrons from (t,3n)

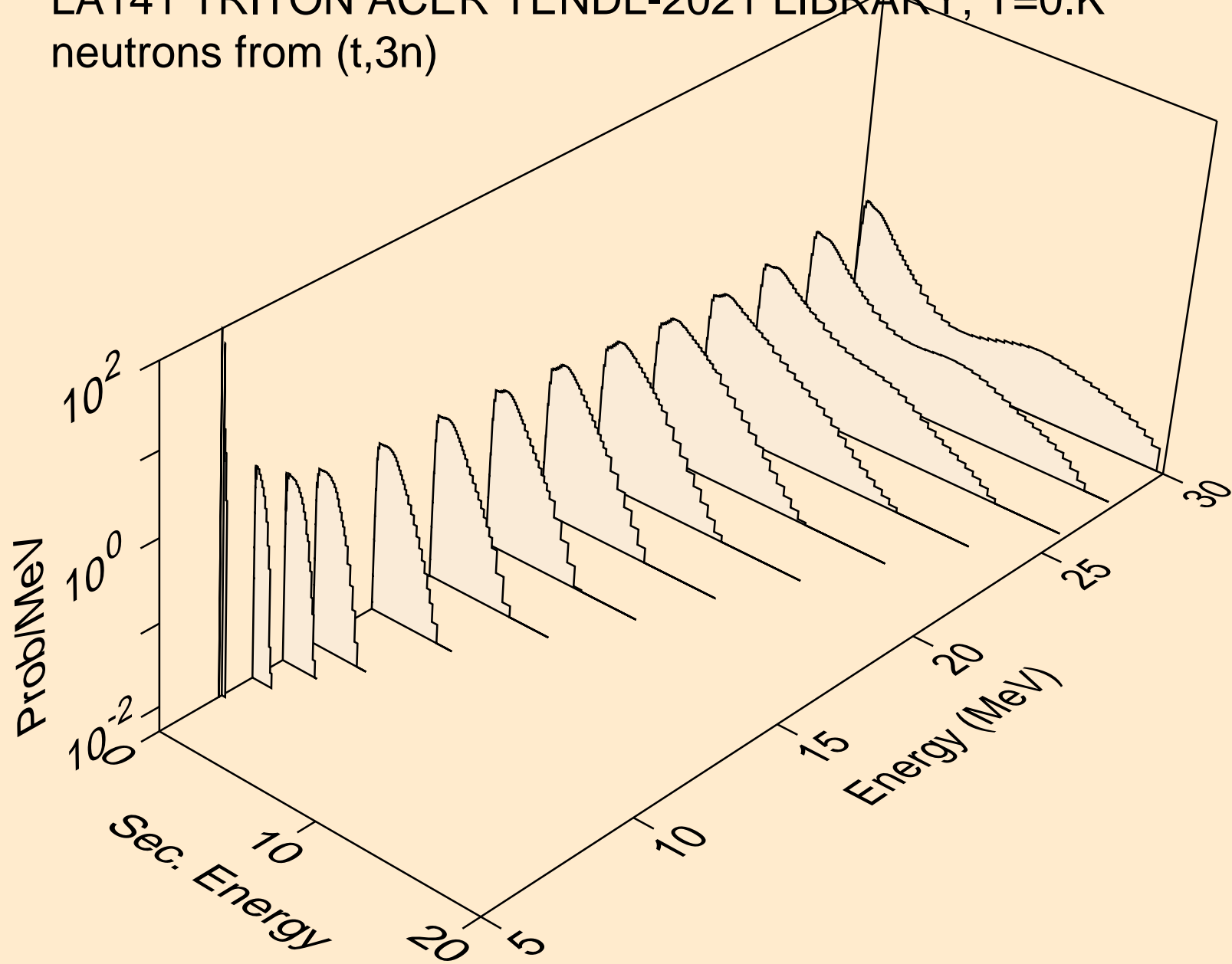

LA141 TRITON ACER TENDL-2021 LIBRARY; T=0.K  
neutrons from (t,n\*)a

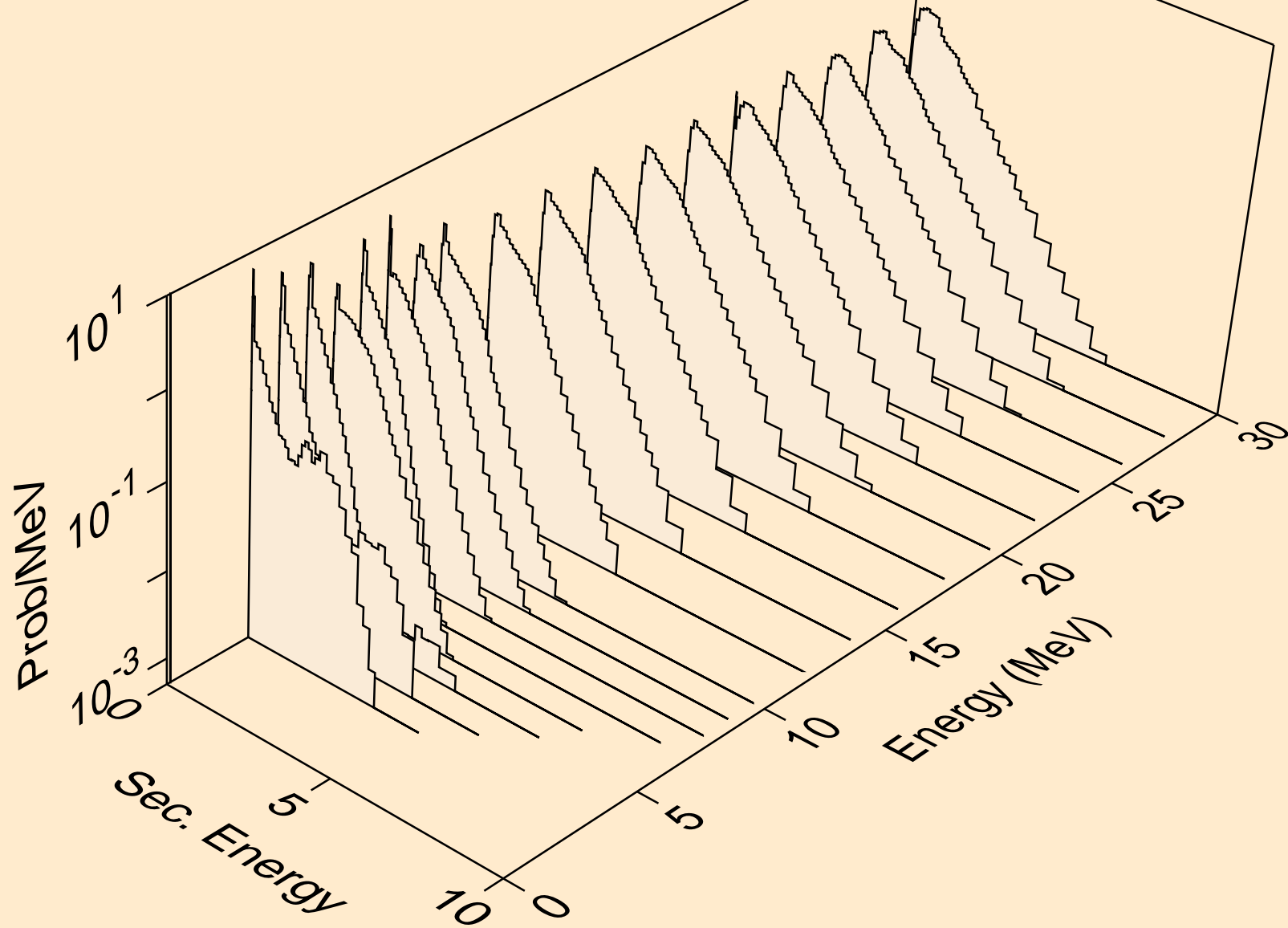

LA141 TRITON ACER TENDL-2021 LIBRARY; T=0.K  
neutrons from (t,2n)a

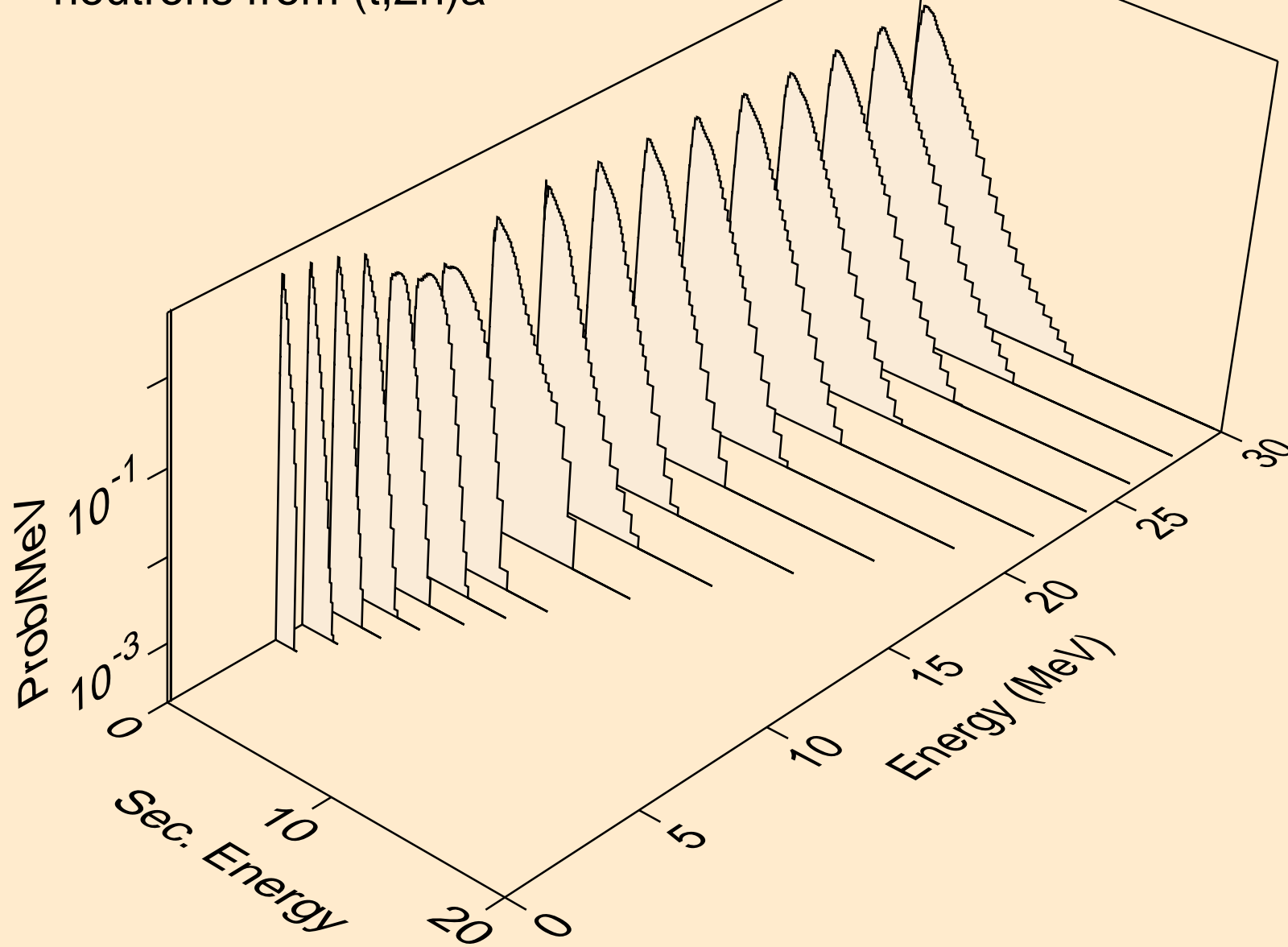

LA141 TRITON ACER TENDL-2021 LIBRARY; T=0.K  
neutrons from (t,3n)a

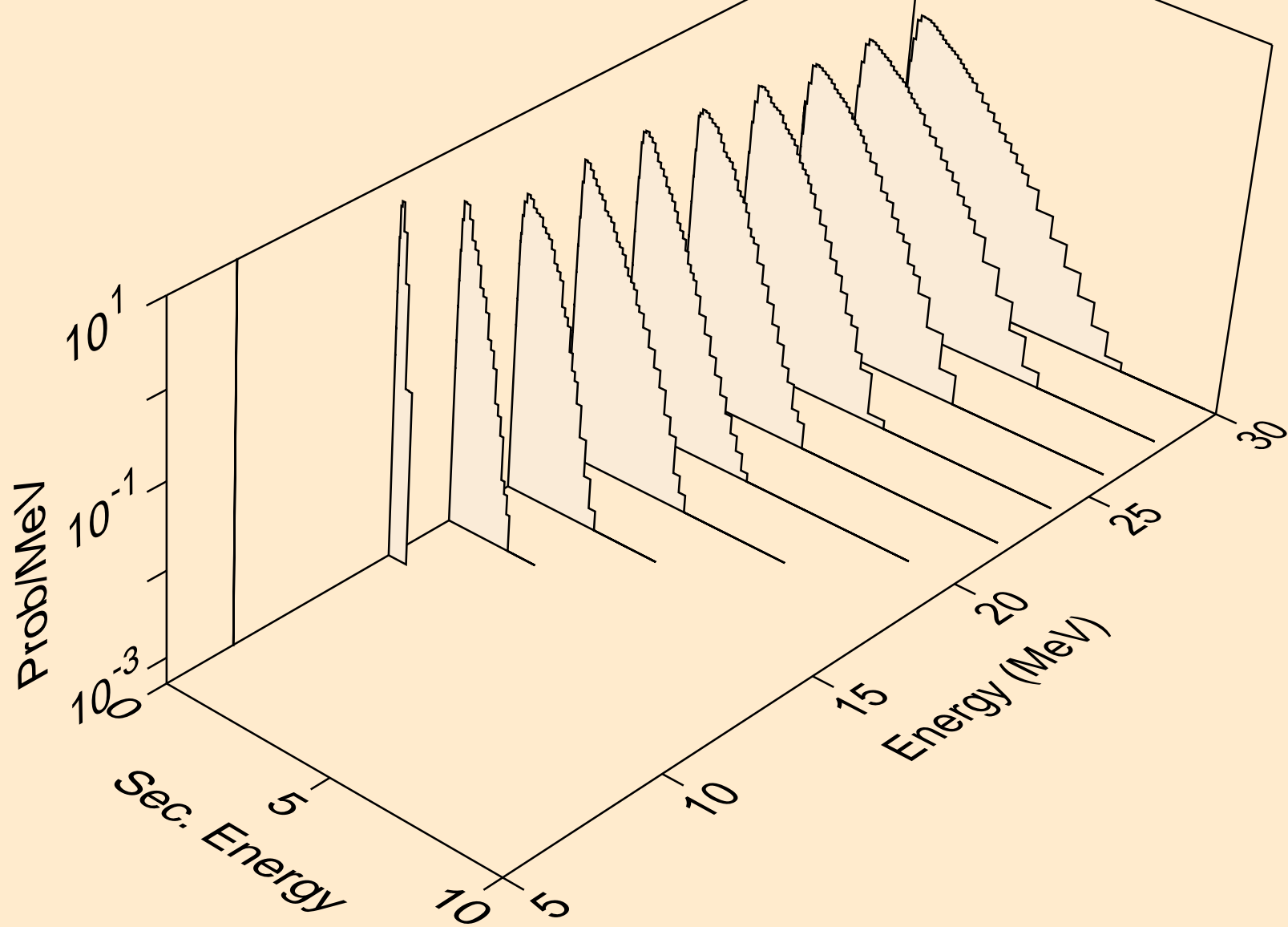

LA141 TRITON ACER TENDL-2021 LIBRARY; T=0.K  
neutrons from (t,n\*)p

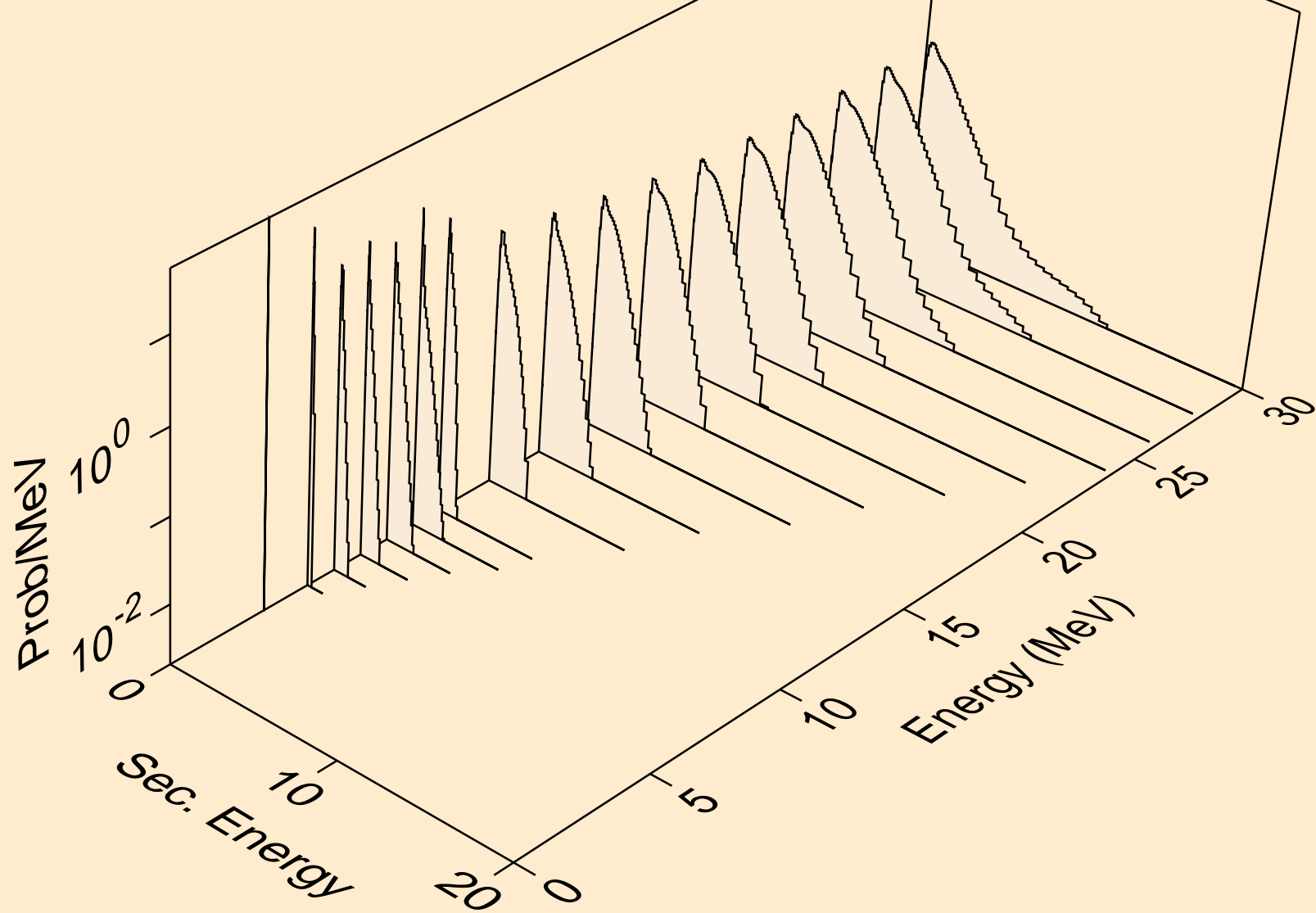



LA141 TRITON ACER TENDL-2021 LIBRARY; T=0.K  
neutrons from (t,n\*)2a

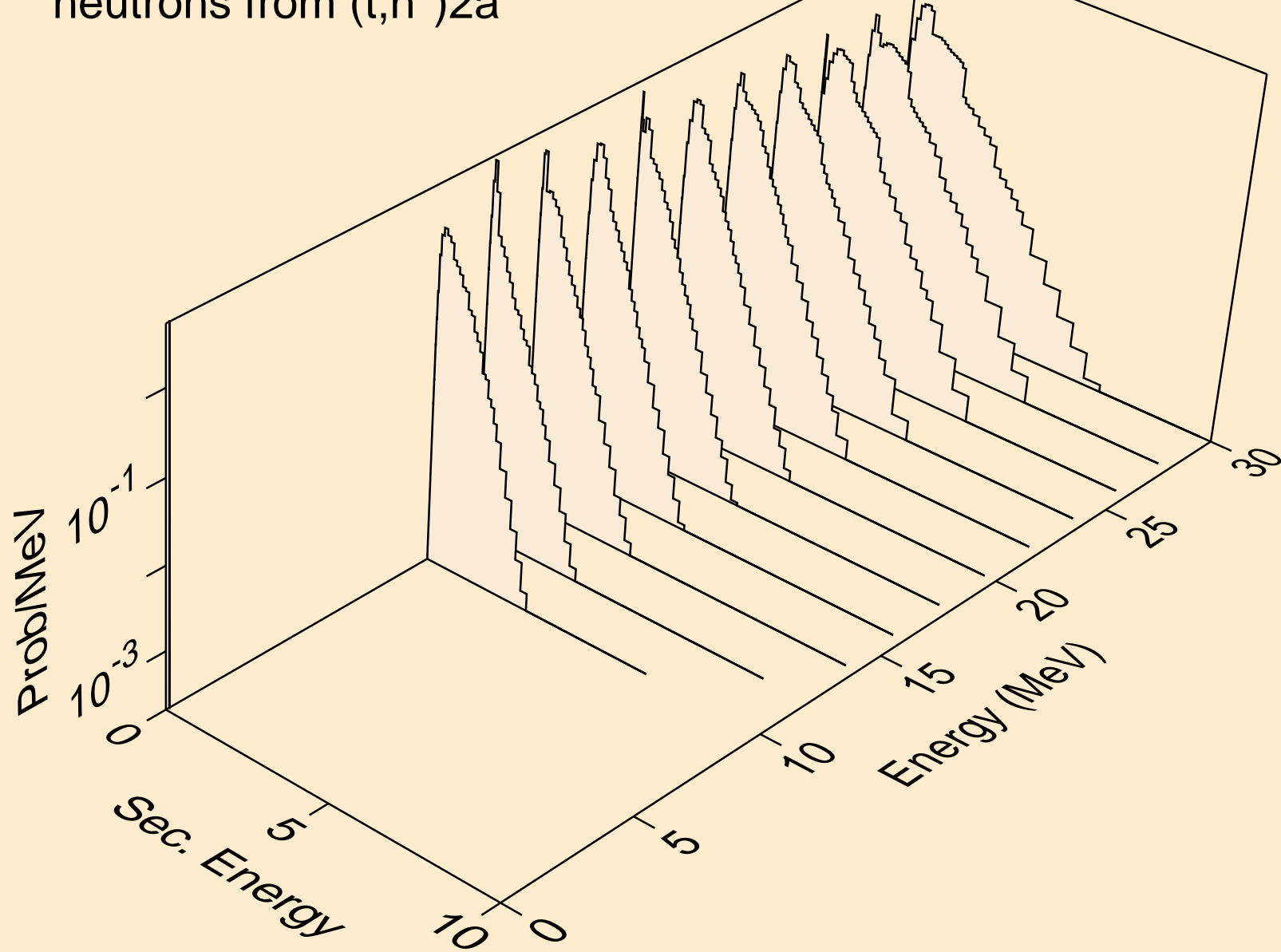

LA141 TRITON ACER TENDL-2021 LIBRARY; T=0.K  
neutrons from (t,2n)2a

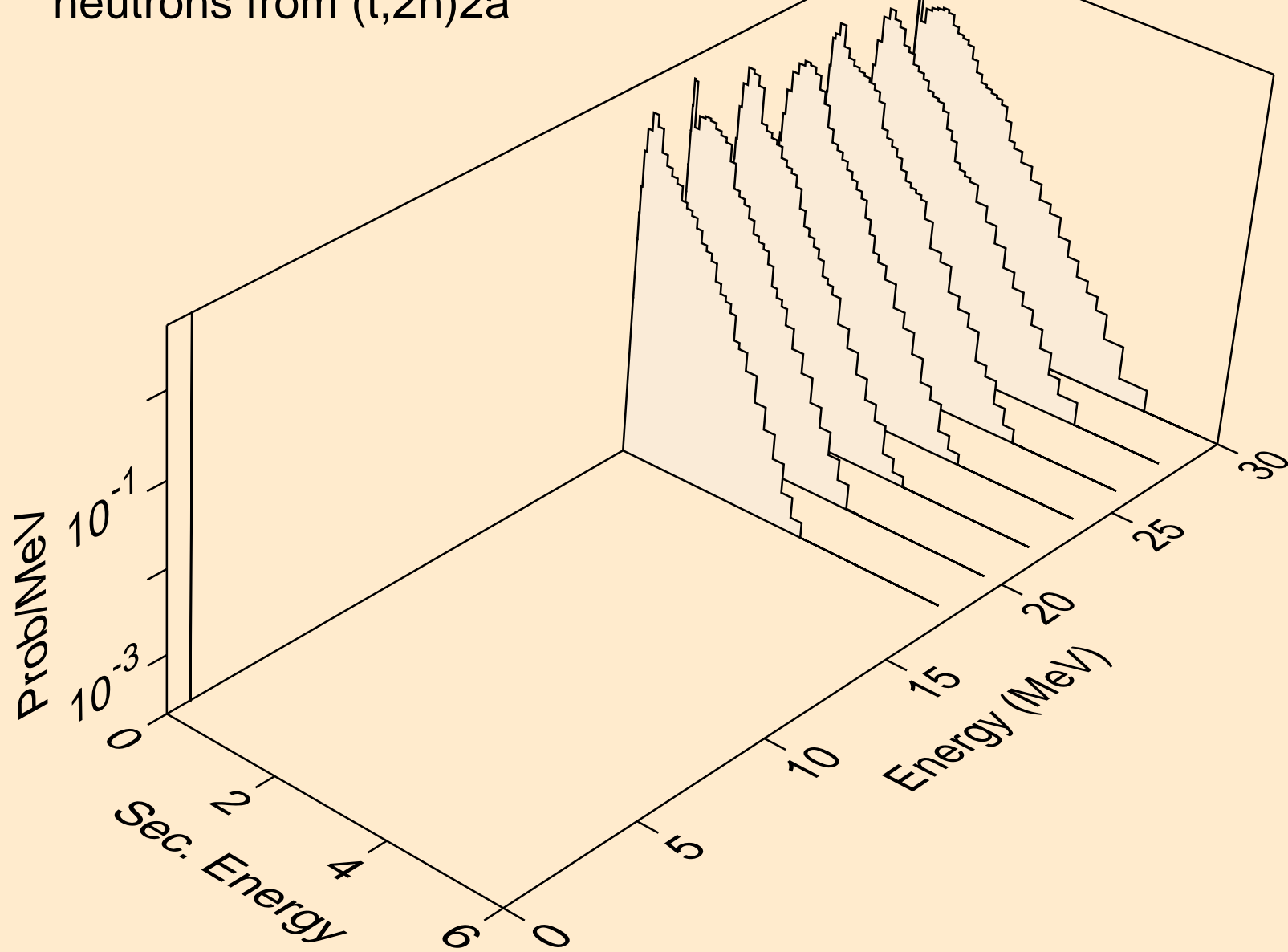

LA141 TRITON ACER TENDL-2021 LIBRARY; T=0.K  
neutrons from (t,n\*)d

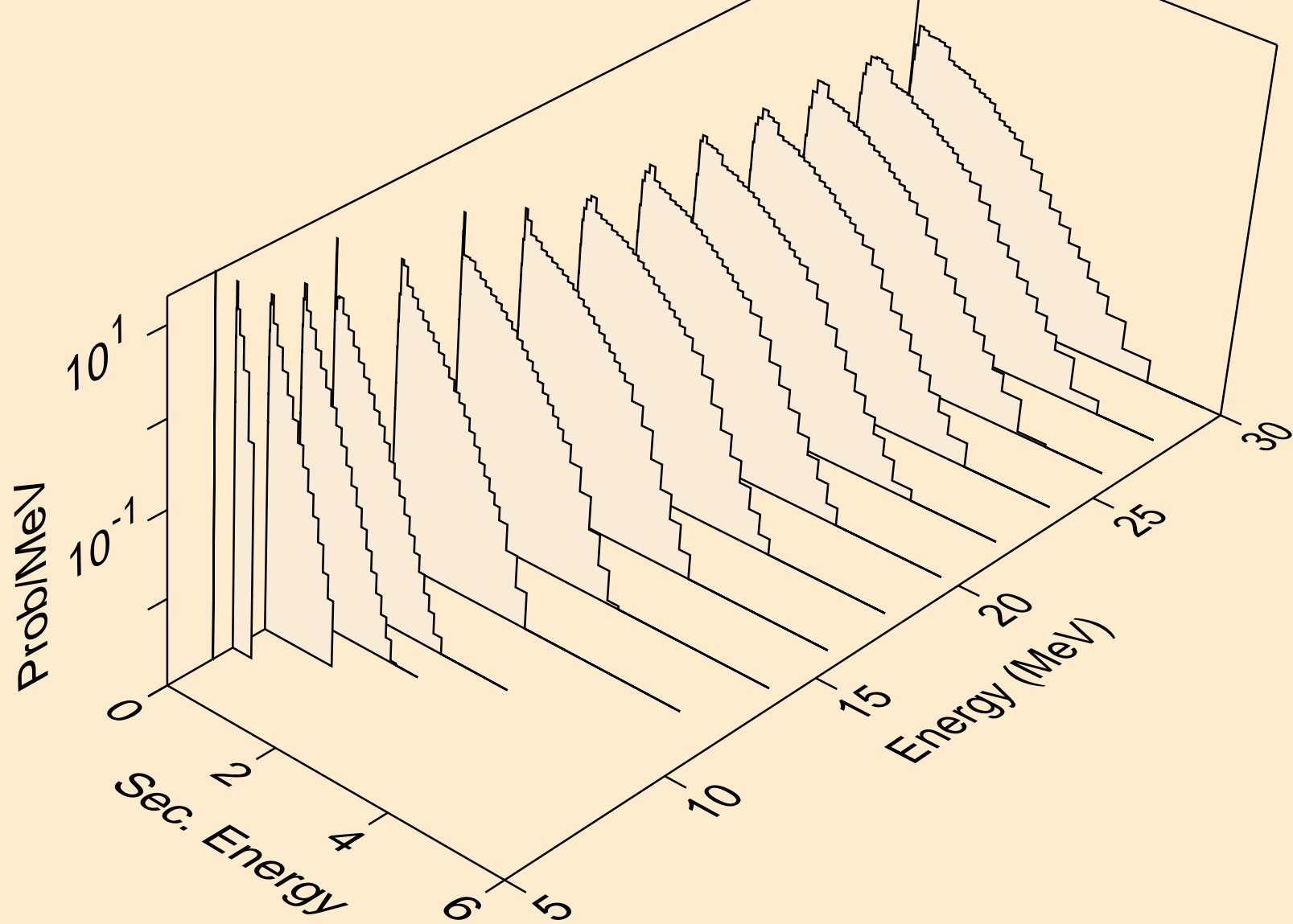

LA141 TRITON ACER TENDL-2021 LIBRARY; T=0.K  
neutrons from (t,n\*)t

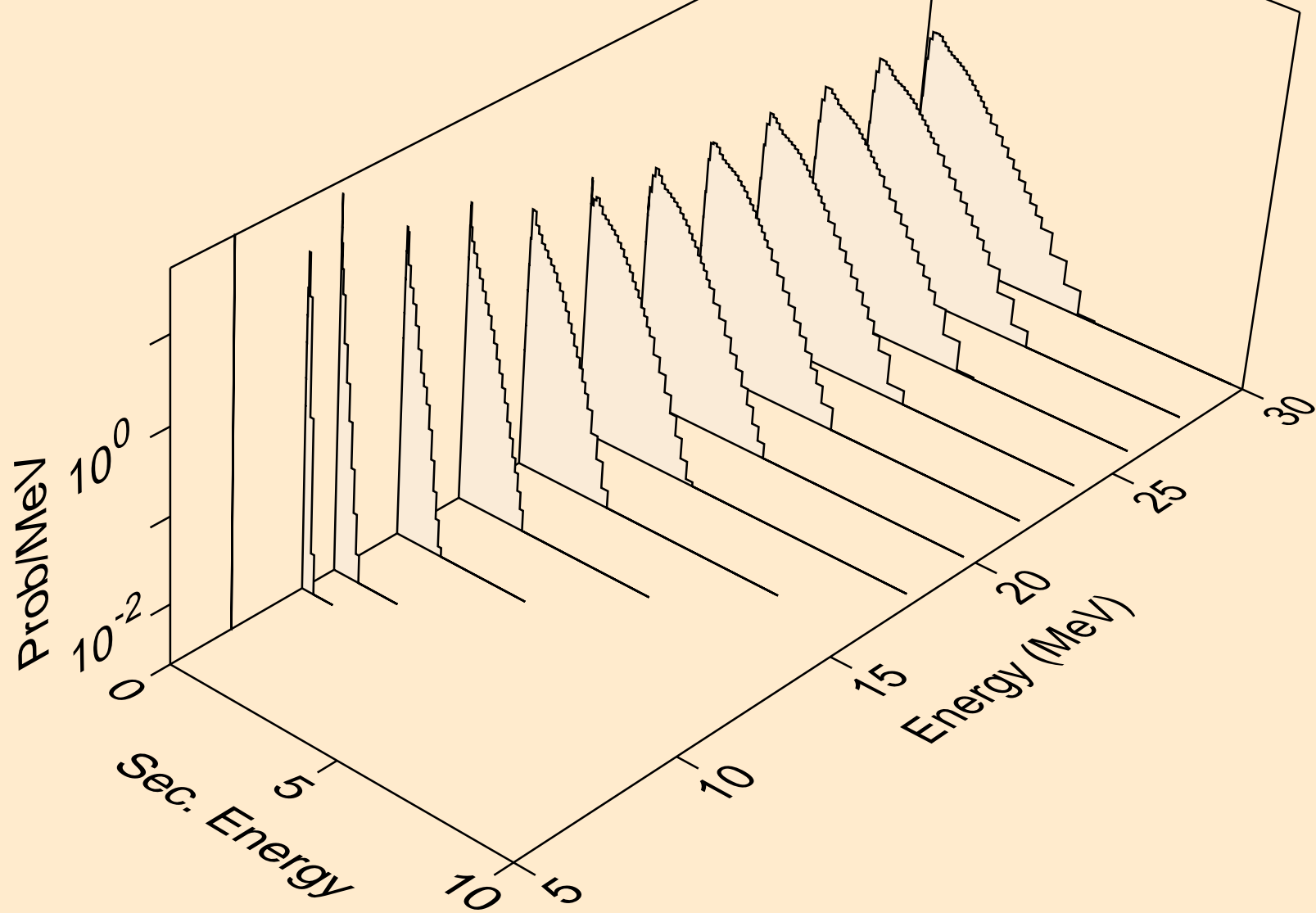

LA141 TRITON ACER TENDL-2021 LIBRARY; T=0.K  
neutrons from (t,n\*)he3

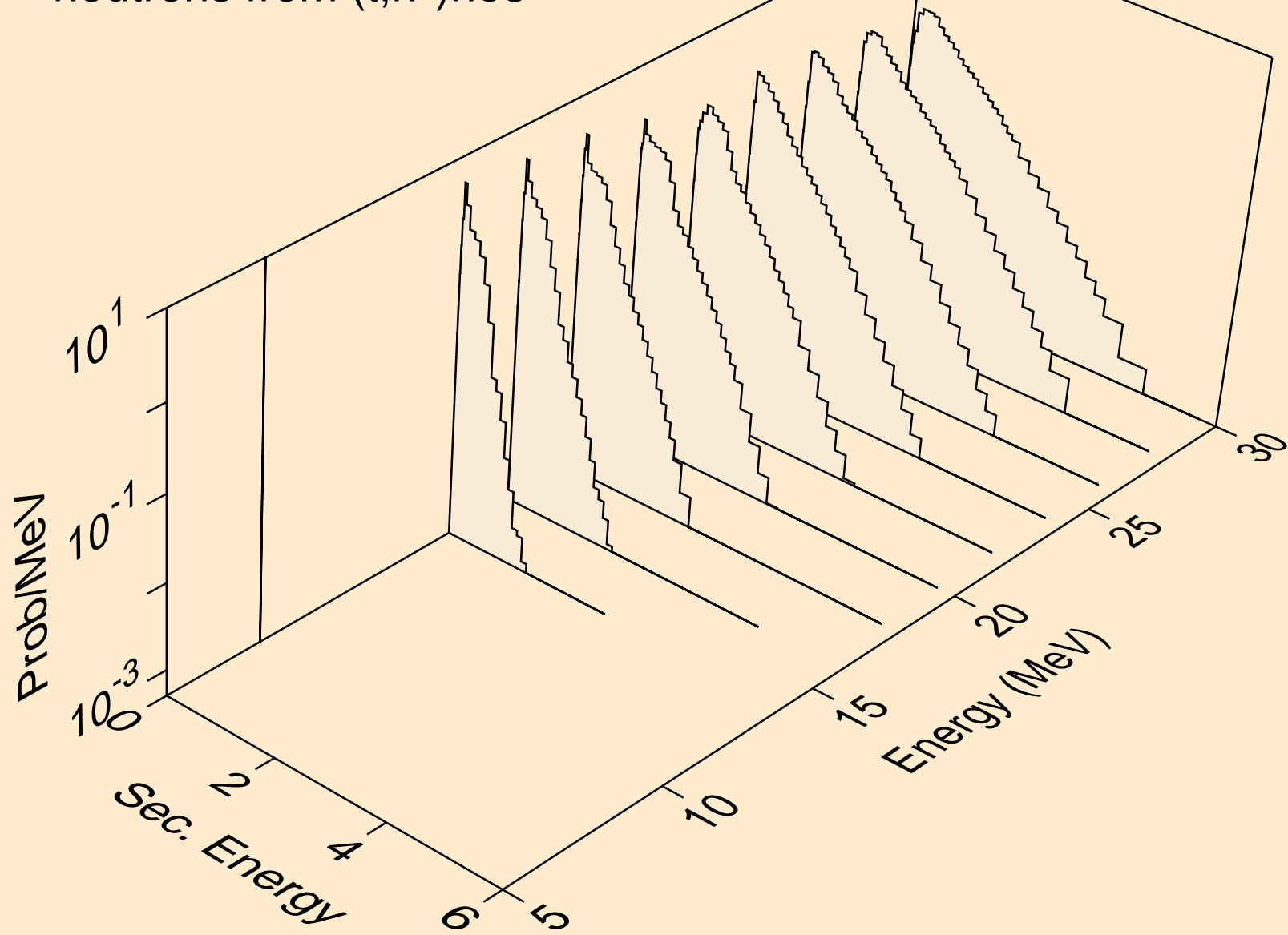

LA141 TRITON ACER TENDL-2021 LIBRARY; T=0.K  
neutrons from (t,4n)

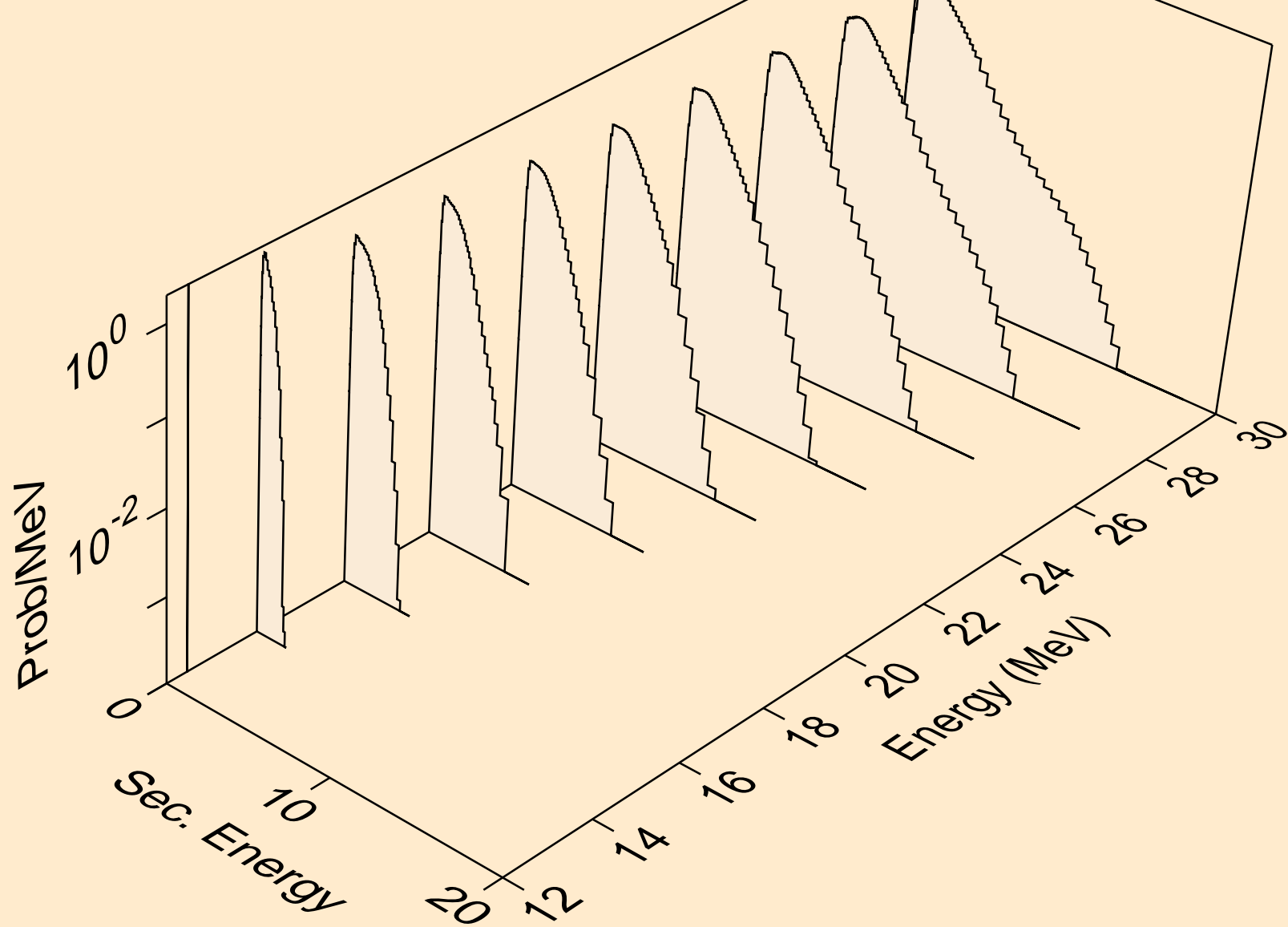

LA141 TRITON ACER TENDL-2021 LIBRARY; T=0.K  
neutrons from (t,2np)

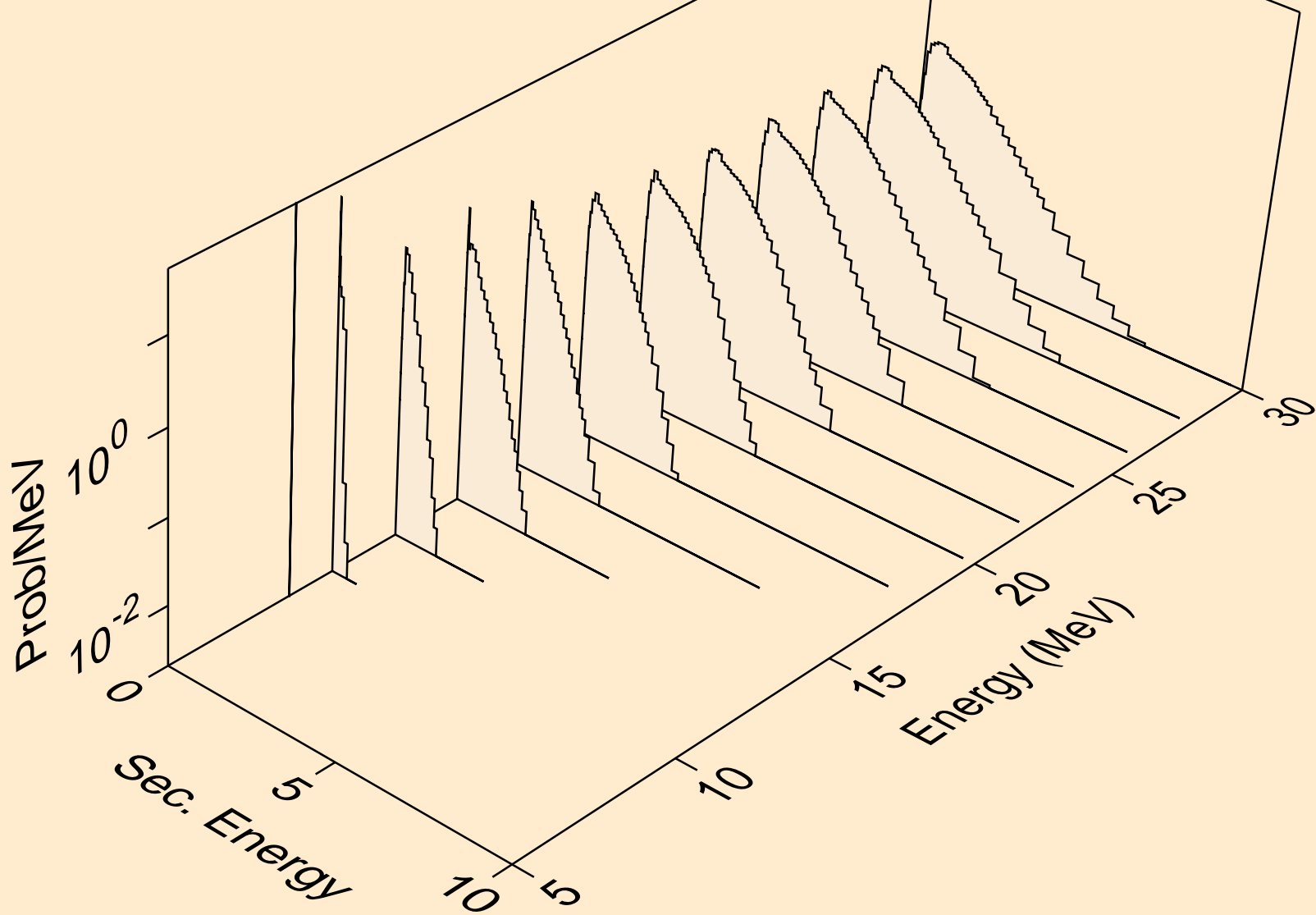

LA141 TRITON ACER TENDL-2021 LIBRARY; T=0.K  
neutrons from (t,3np)

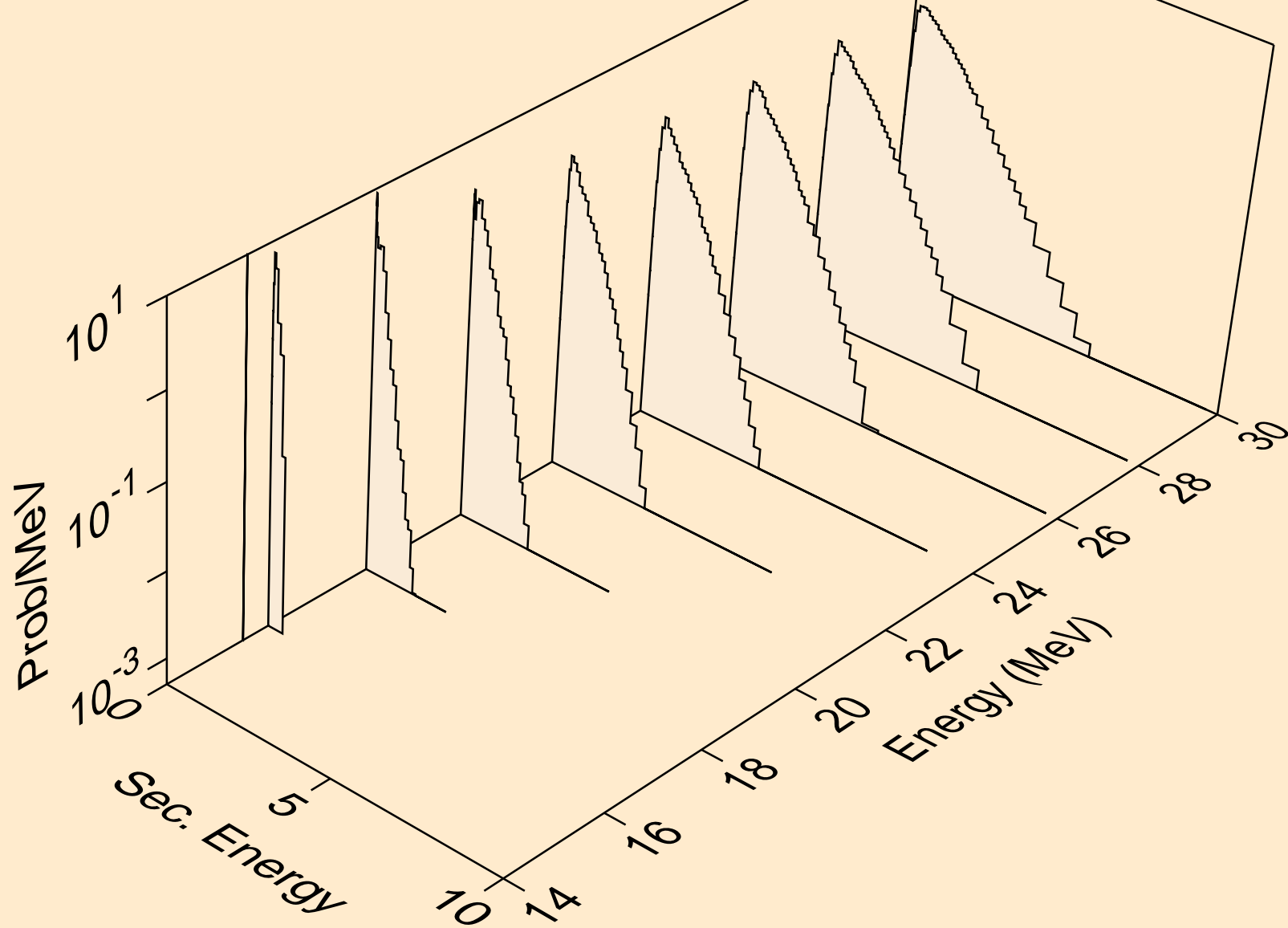



LA141 TRITON ACER TENDL-2021 LIBRARY; T=0.K  
neutrons from (t,2np)

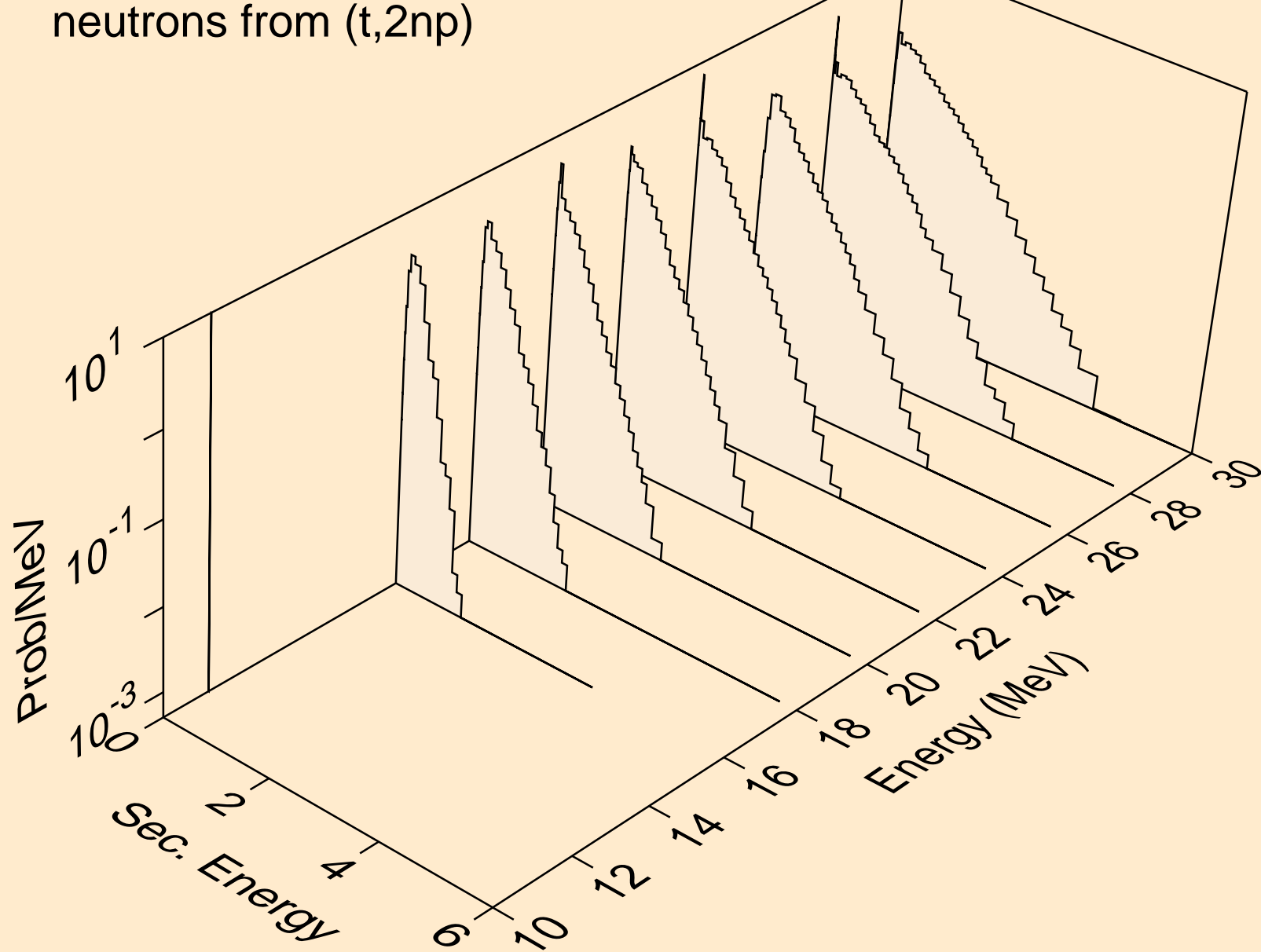

LA141 TRITON ACER TENDL-2021 LIBRARY; T=0.K  
neutrons from (t,npa)

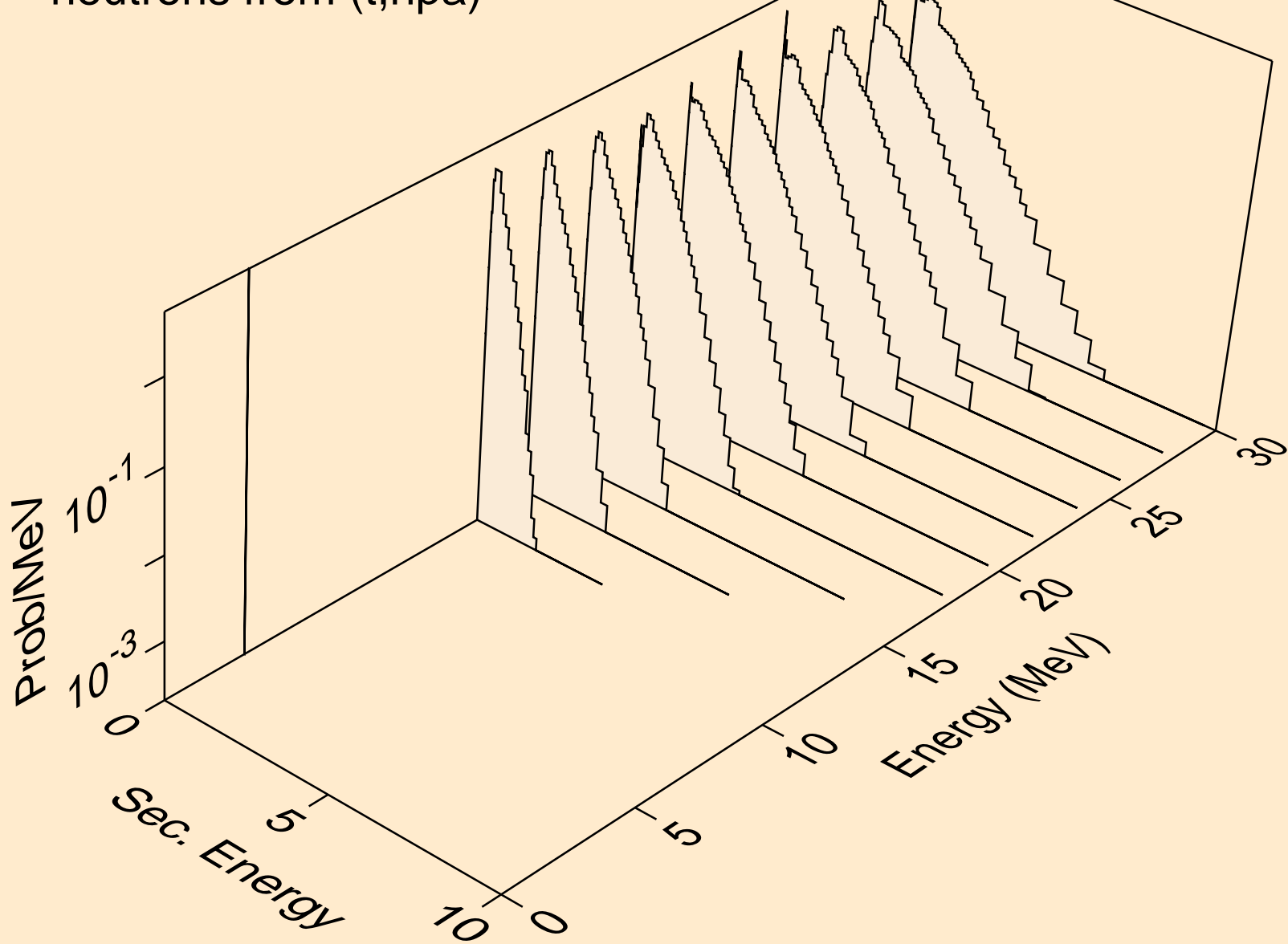

LA141 TRITON ACER TENDL-2021 LIBRARY; T=0.K  
protons from (t,x)

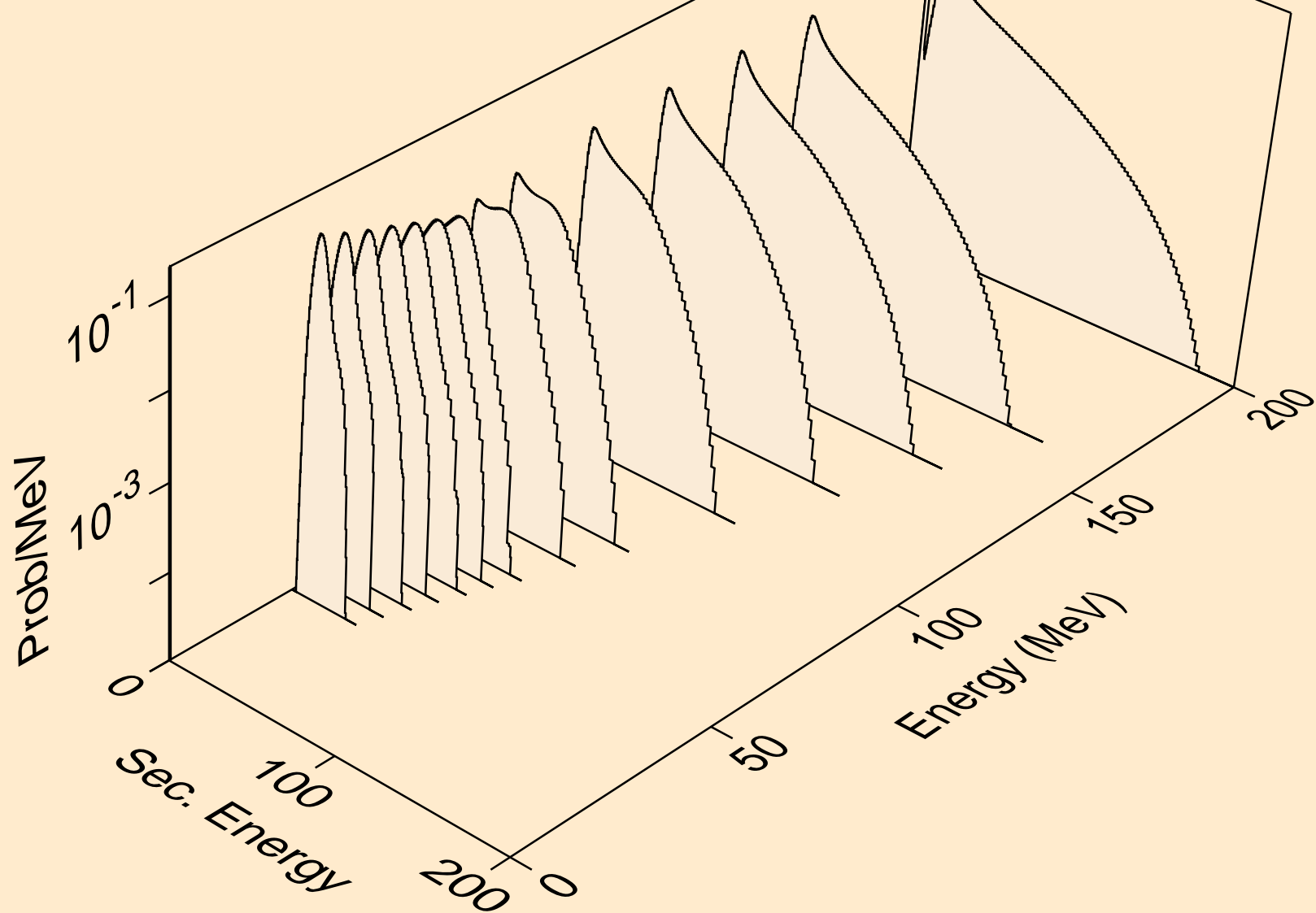

LA141 TRITON ACER TENDL-2021 LIBRARY; T=0.K  
protons from (t,n\*)p

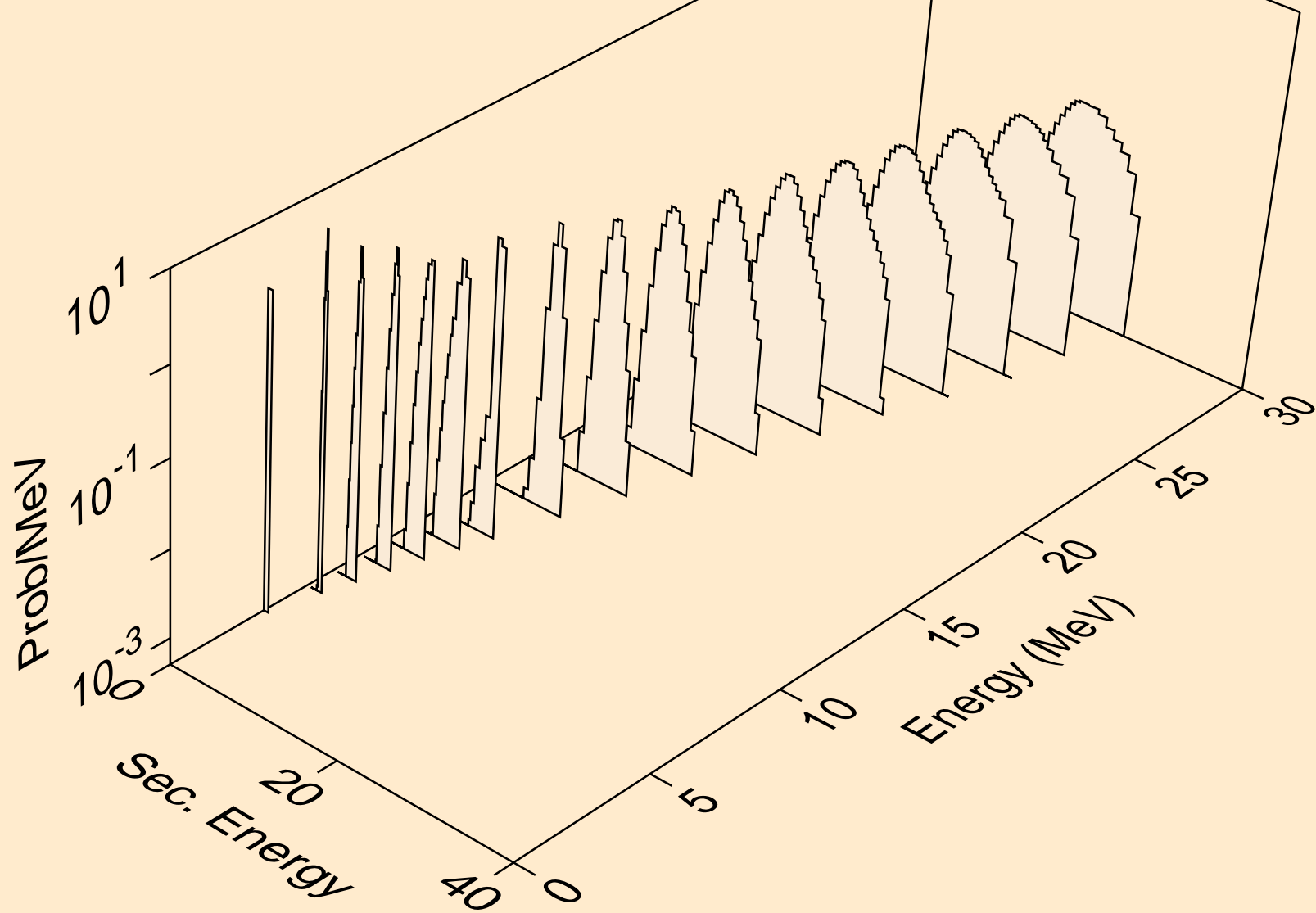

LA141 TRITON ACER TENDL-2021 LIBRARY; T=0.K  
protons from (t,2np)

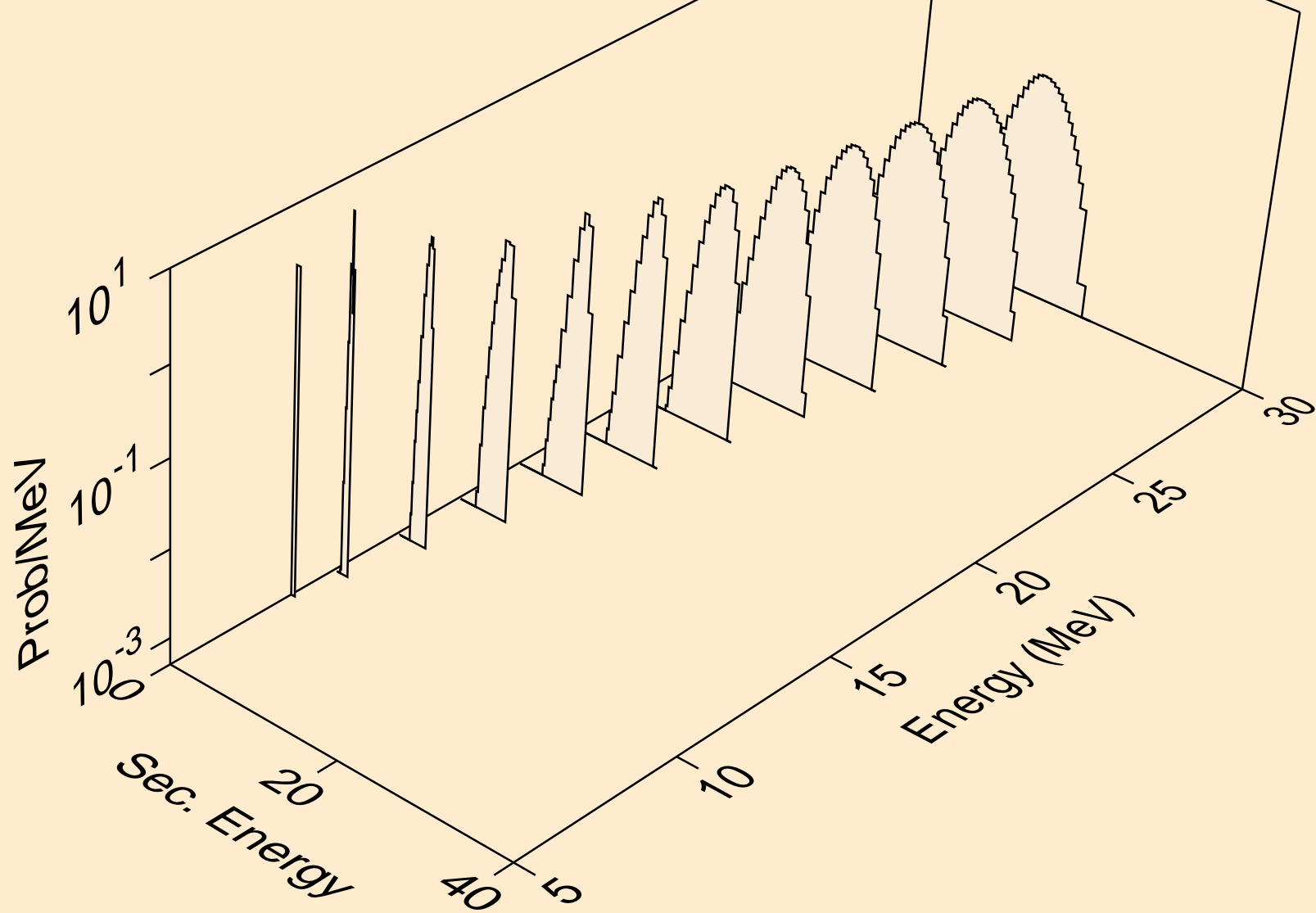

LA141 TRITON ACER TENDL-2021 LIBRARY; T=0.K  
protons from (t,3np)

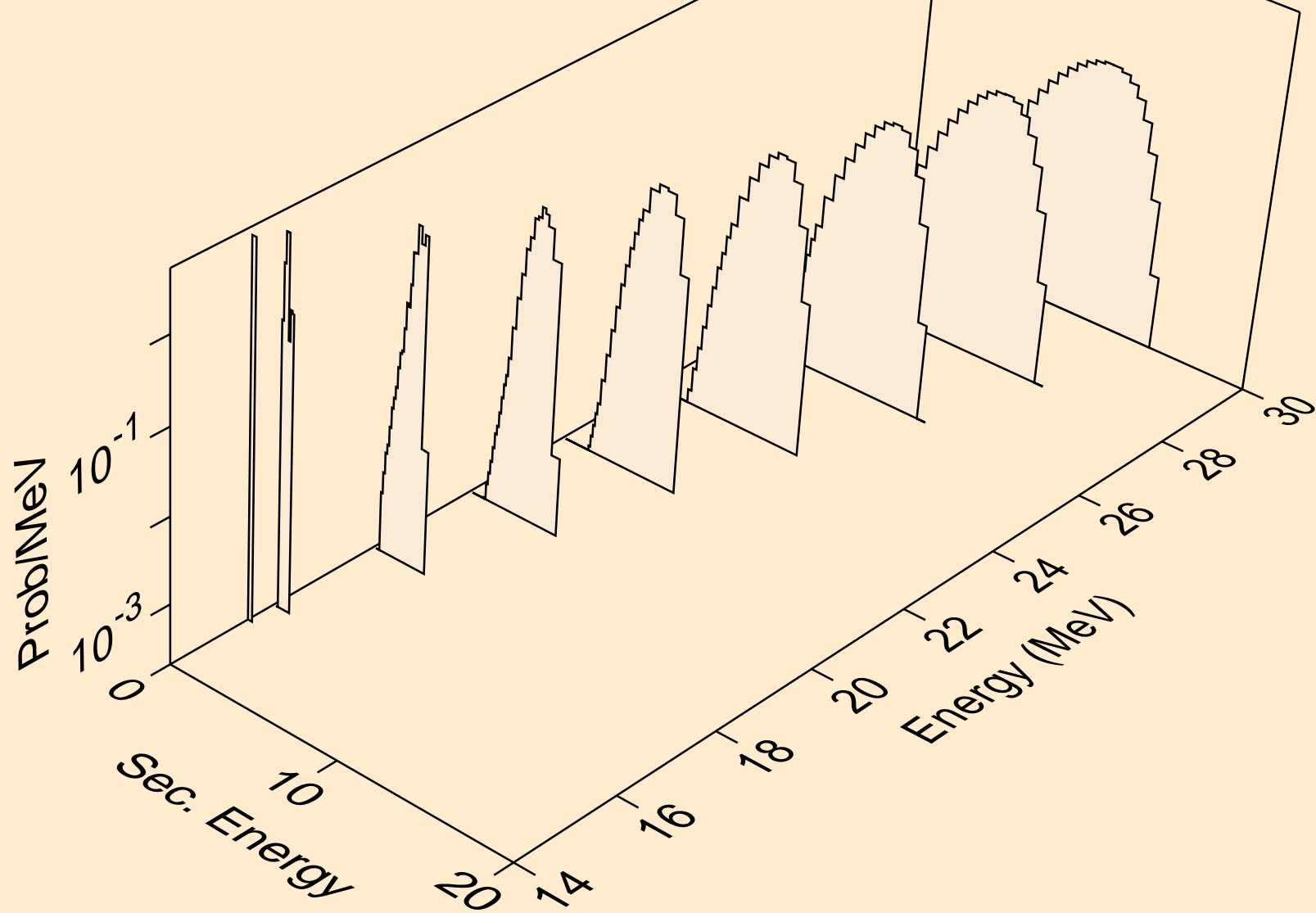

LA141 TRITON ACER TENDL-2021 LIBRARY; T=0.K  
protons from (t,2np)

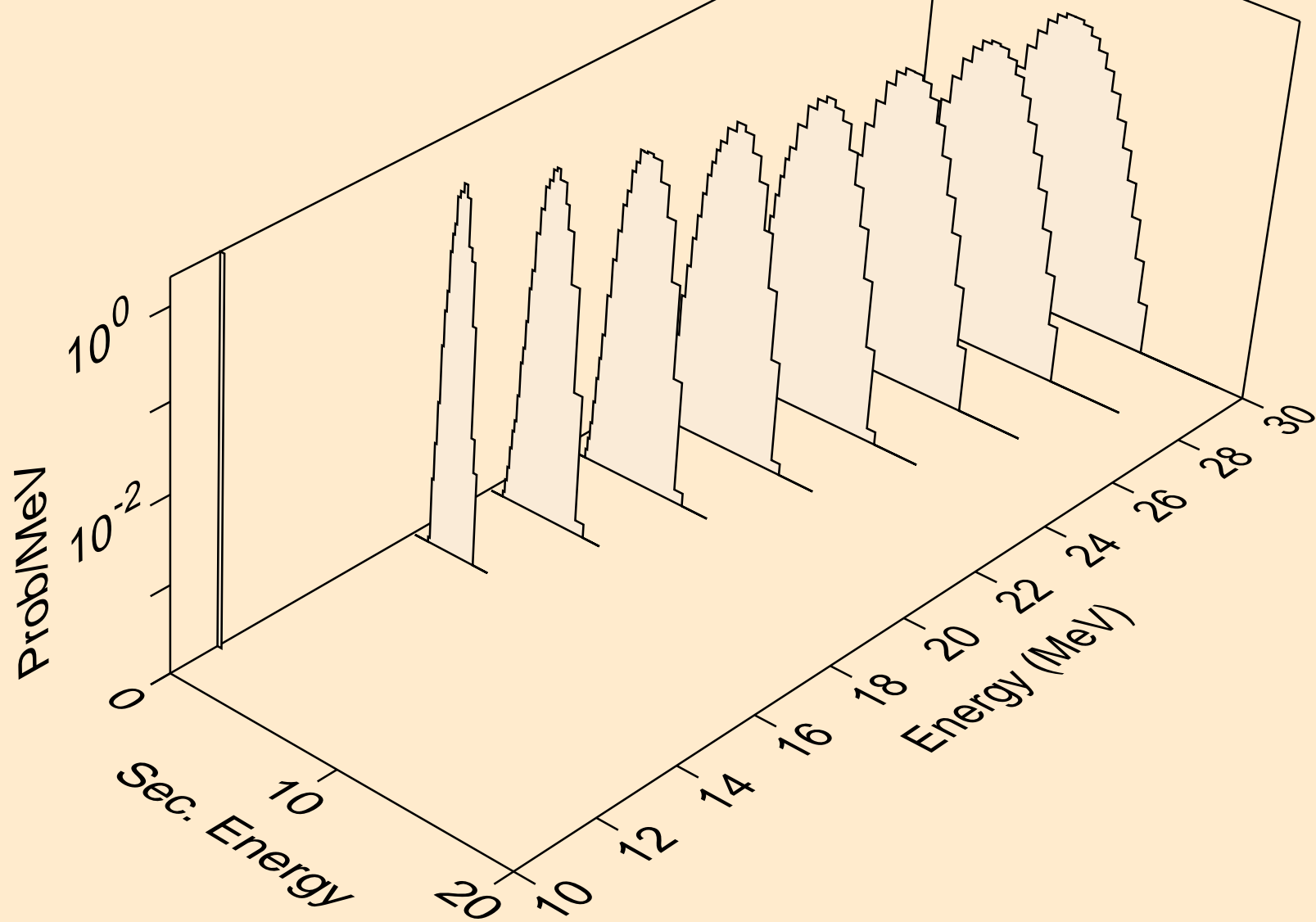

LA141 TRITON ACER TENDL-2021 LIBRARY; T=0.K  
protons from (t,npa)

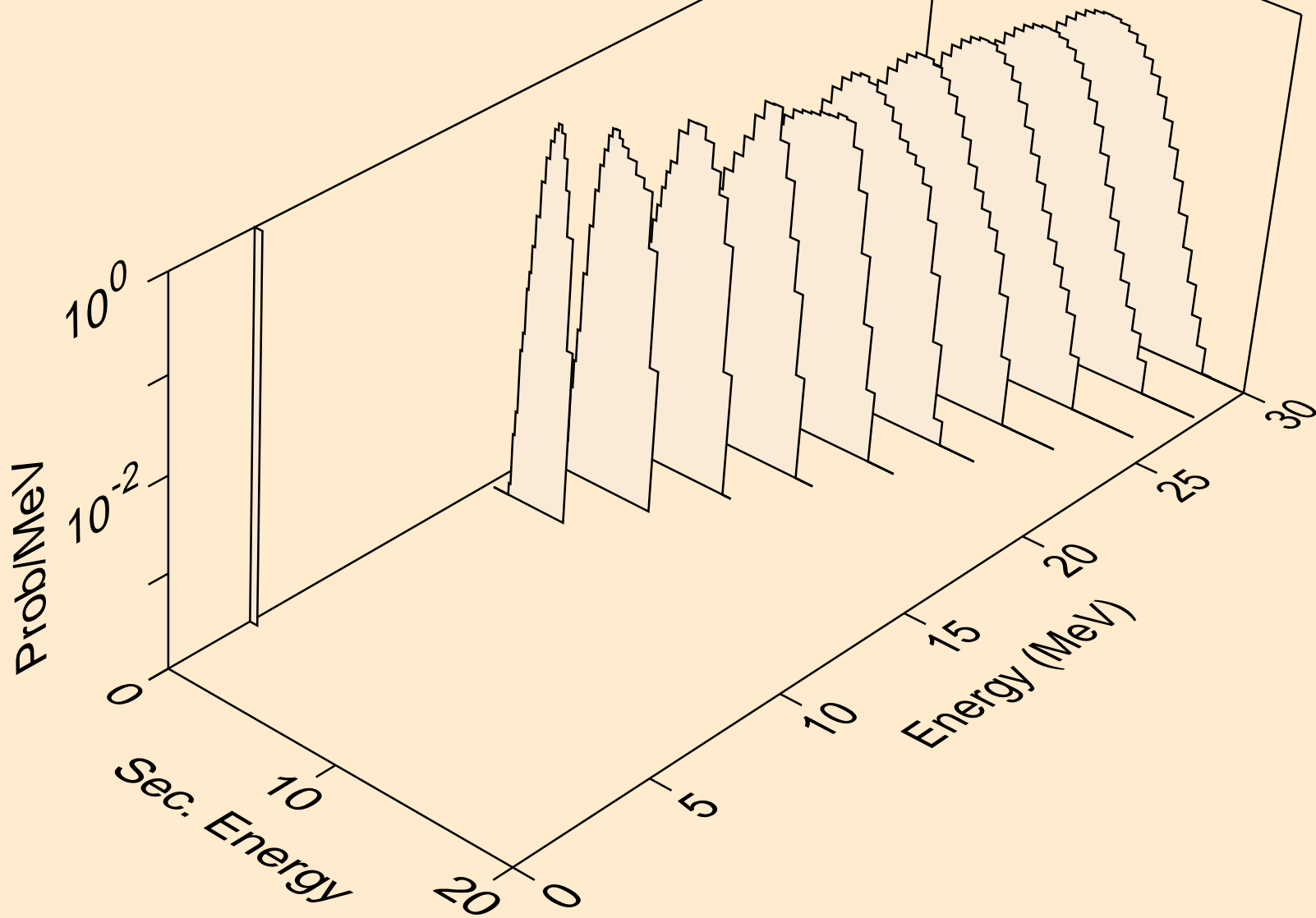



LA141 TRITON ACER TENDL-2021 LIBRARY; T=0.K  
protons from (t,p)

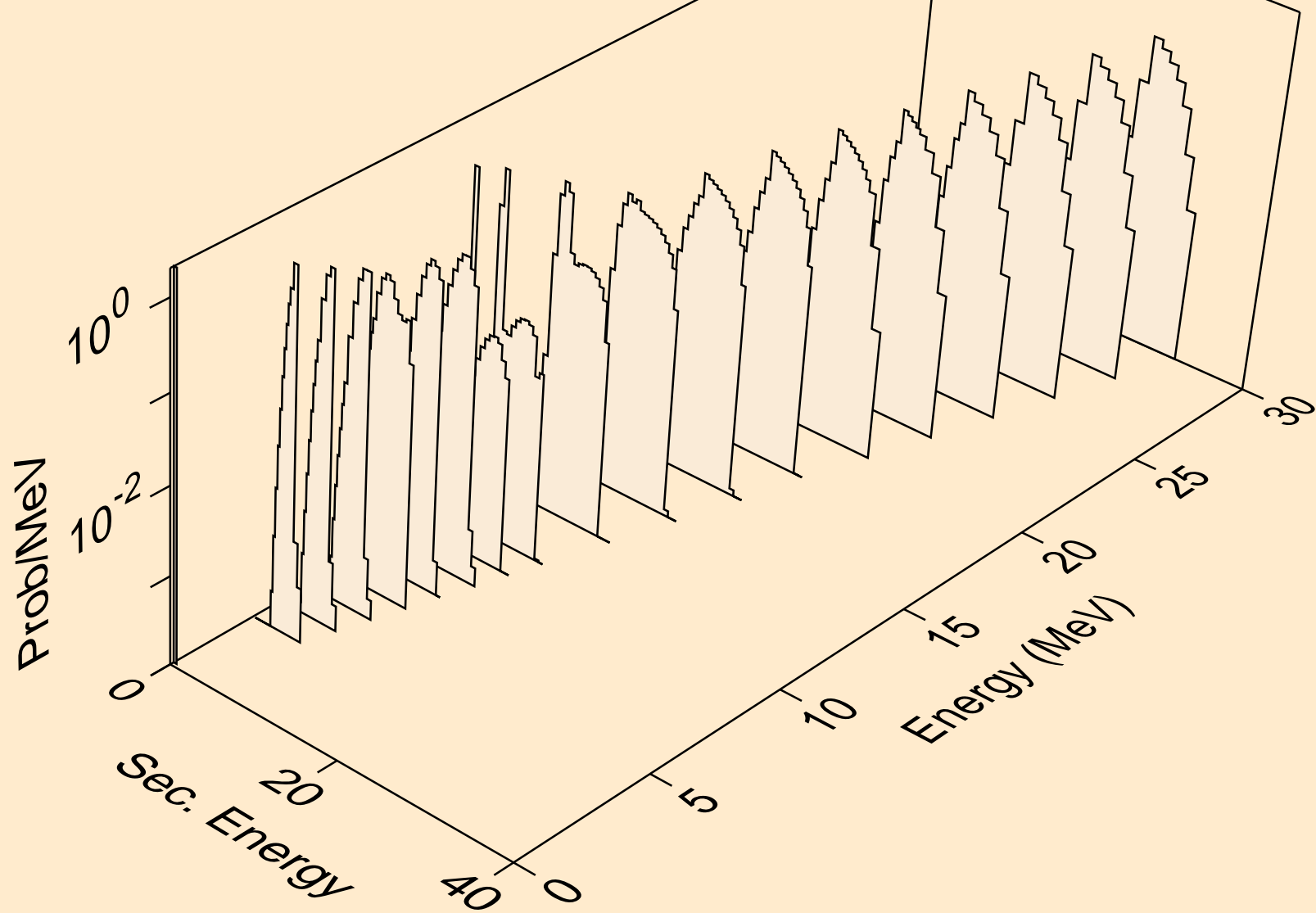

LA141 TRITON ACER TENDL-2021 LIBRARY; T=0.K  
protons from (t,2p)

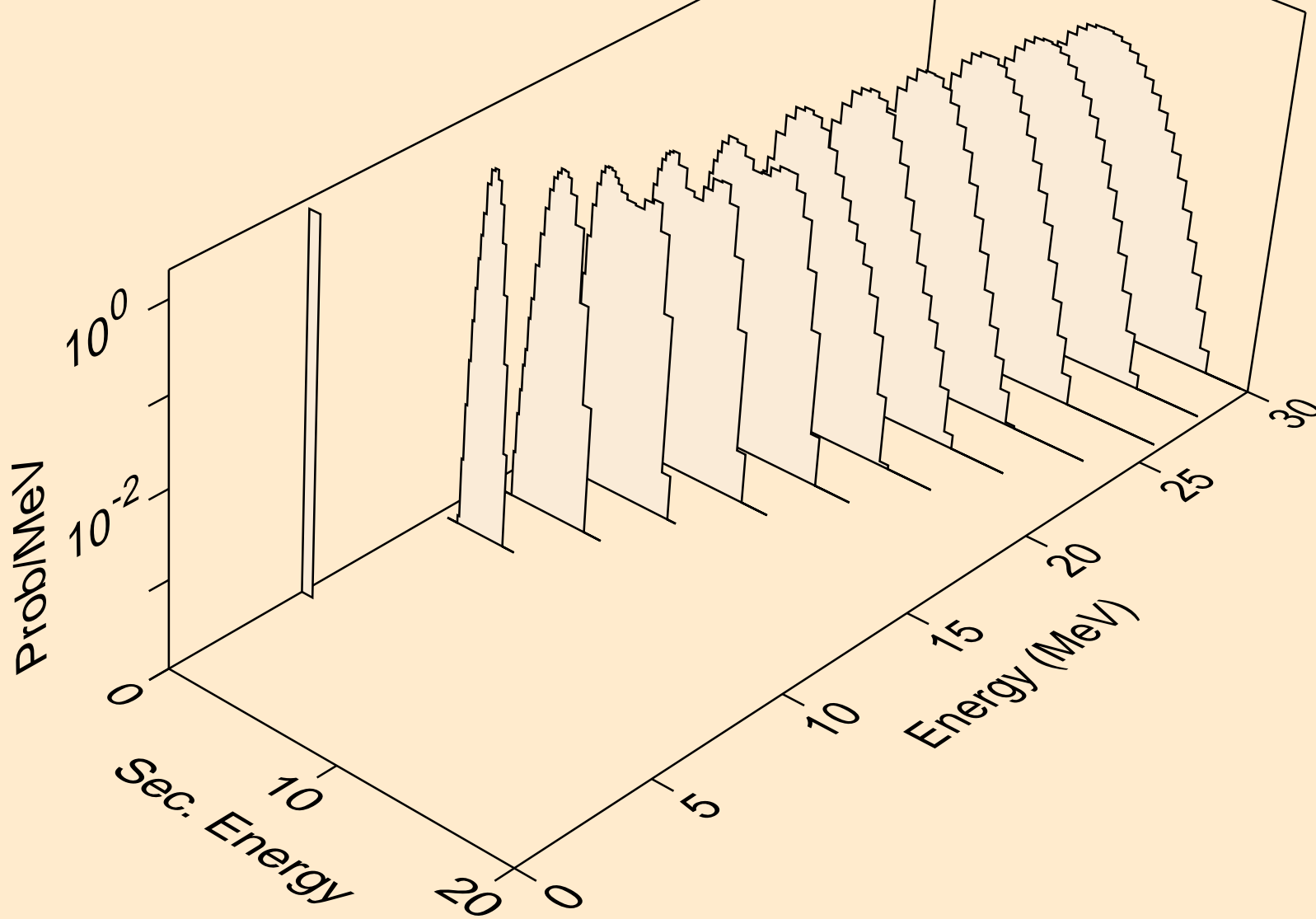

LA141 TRITON ACER TENDL-2021 LIBRARY; T=0.K  
protons from (t,pa)

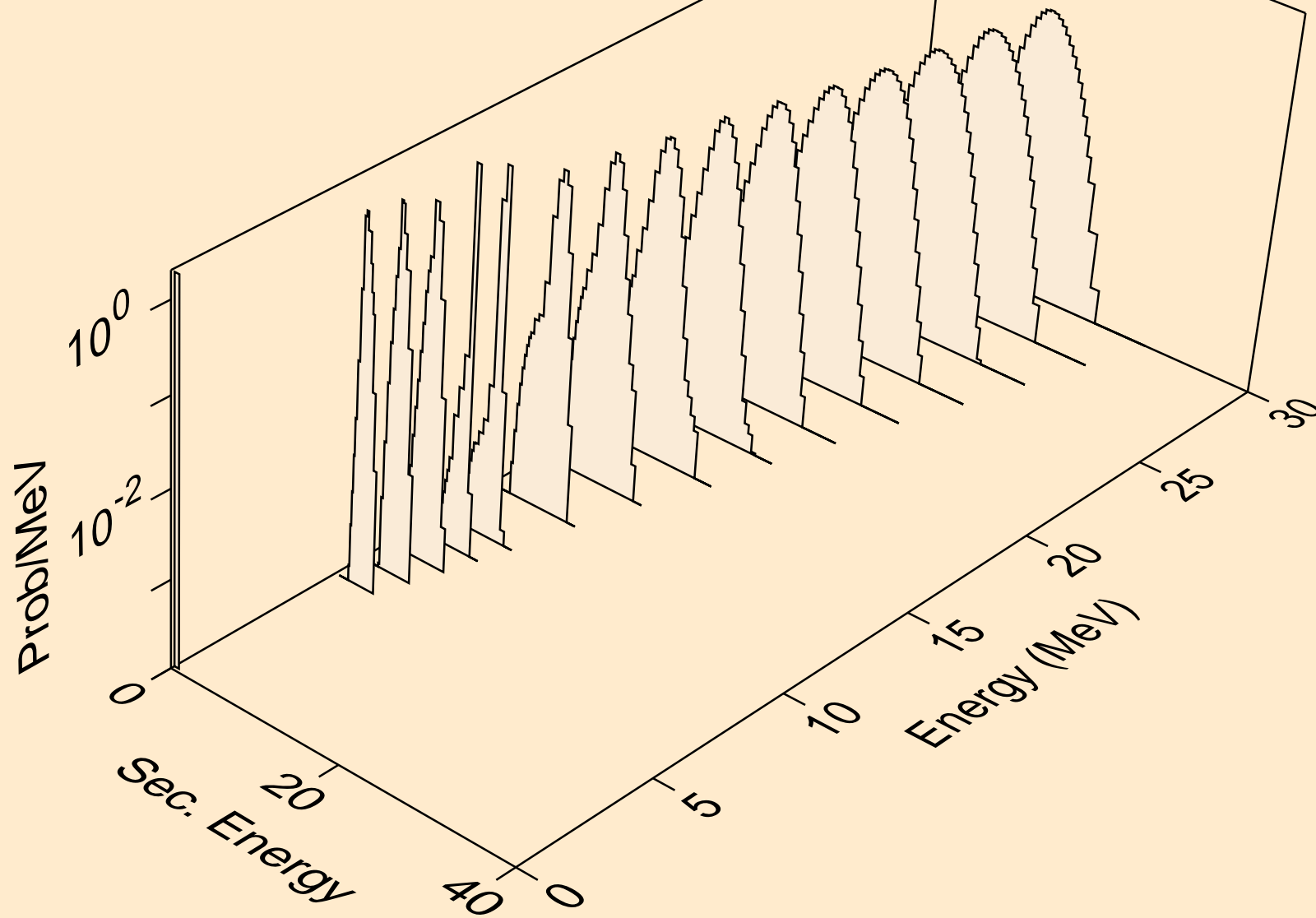

LA141 TRITON ACER TENDL-2021 LIBRARY; T=0.K  
protons from (t,pd)

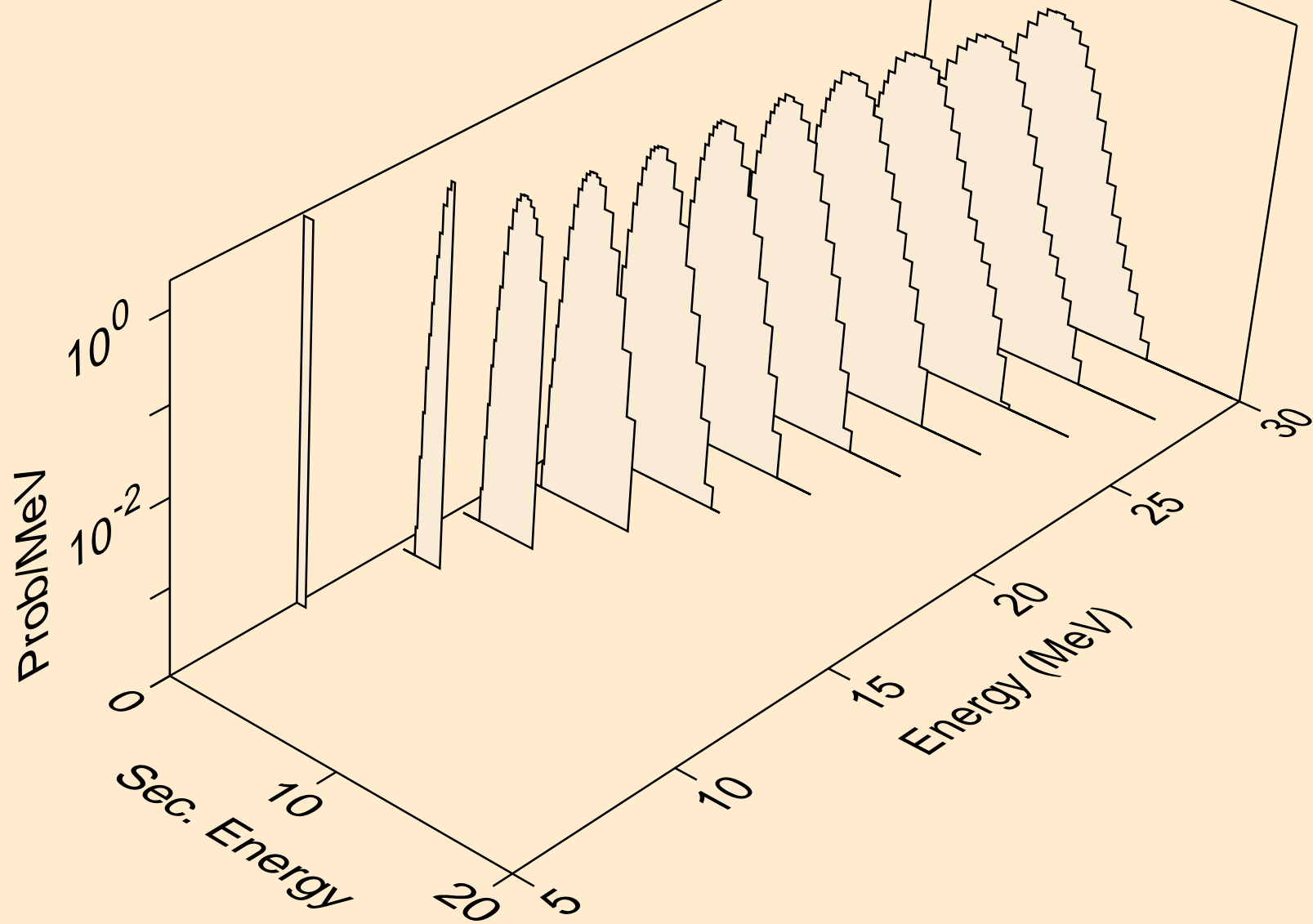

LA141 TRITON ACER TENDL-2021 LIBRARY; T=0.K  
protons from (t,pt)

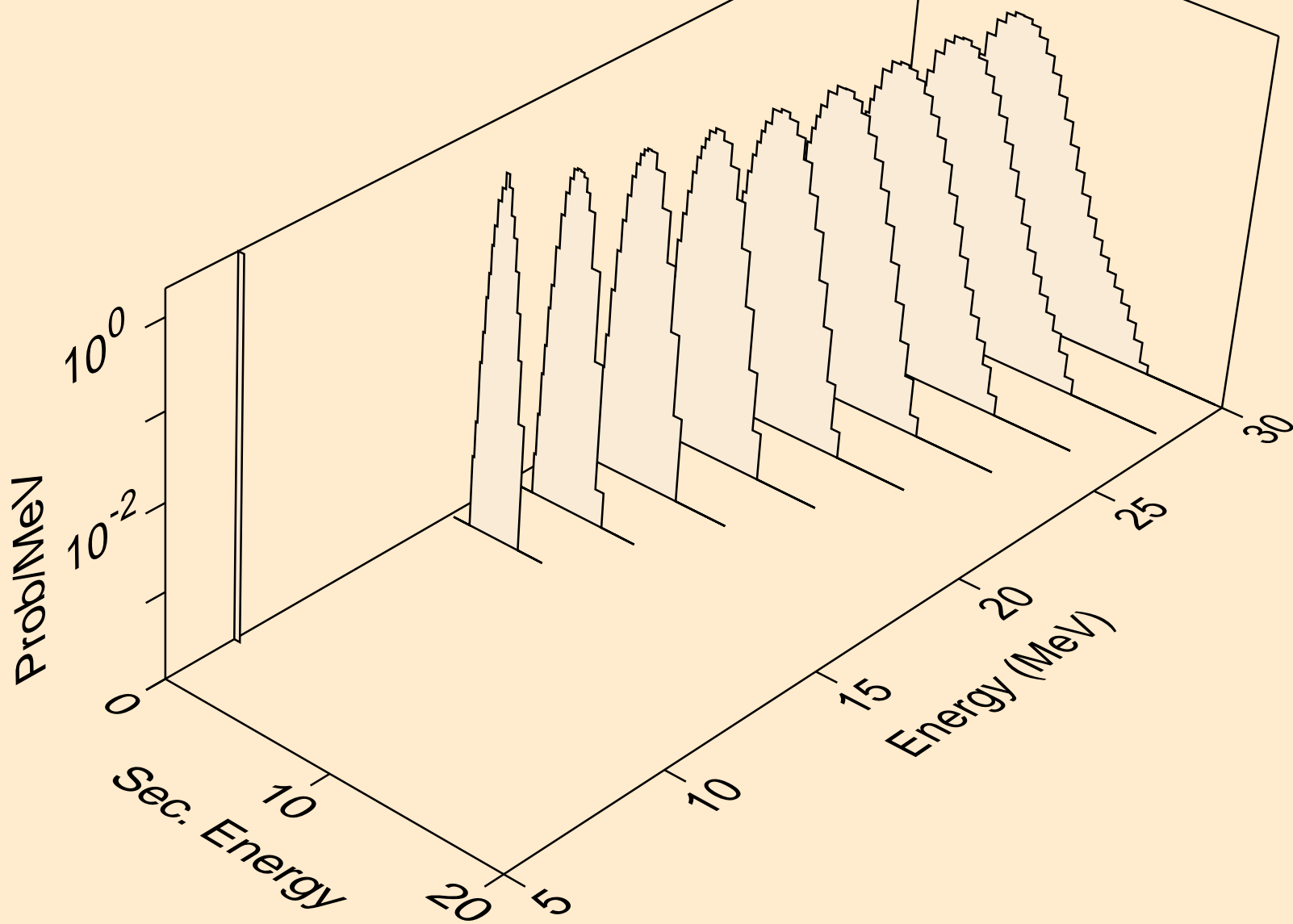

LA141 TRITON ACER TENDL-2021 LIBRARY; T=0.K  
deuterons from (t,x)

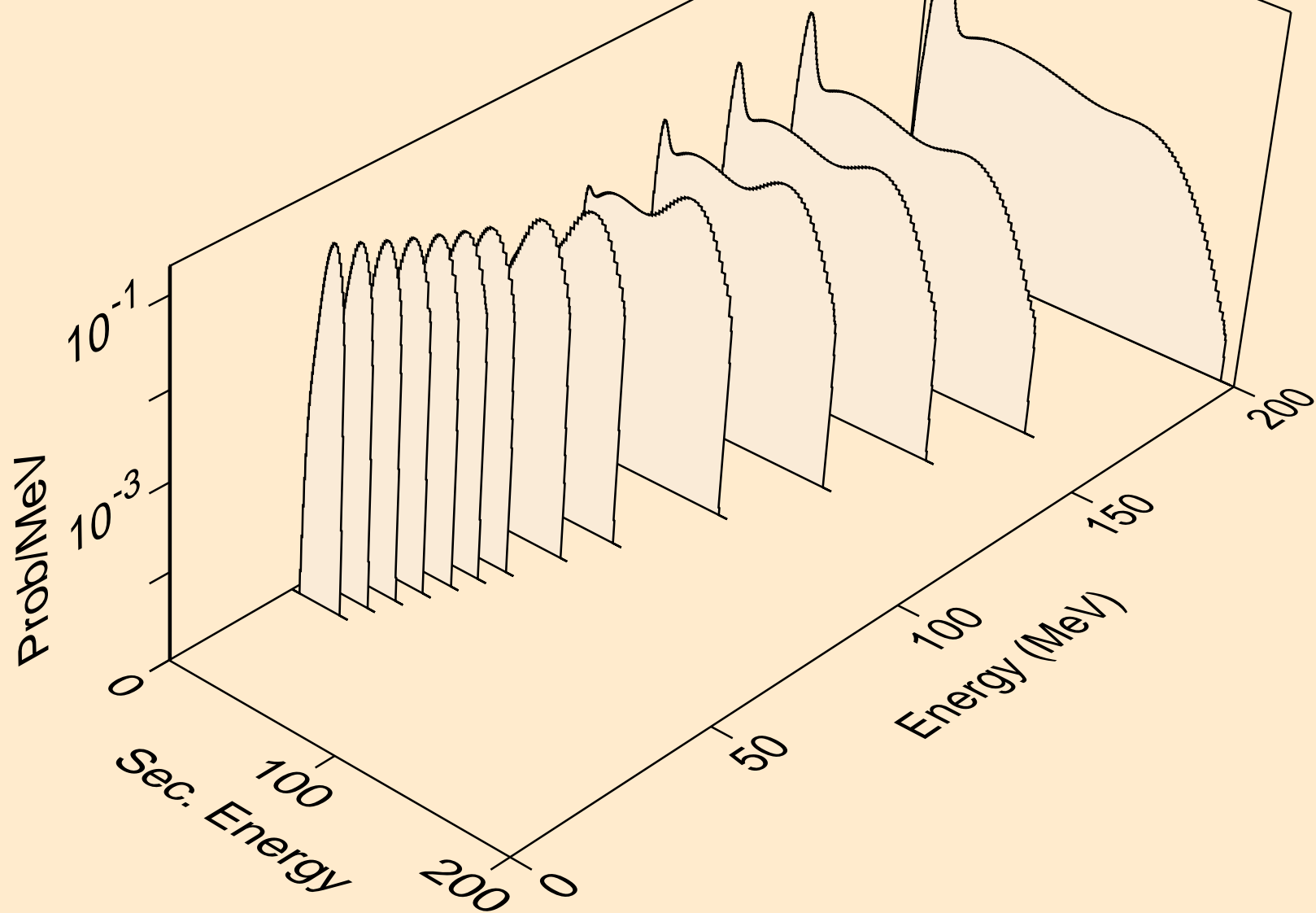

LA141 TRITON ACER TENDL-2021 LIBRARY; T=0.K  
deuterons from (t,2nd)

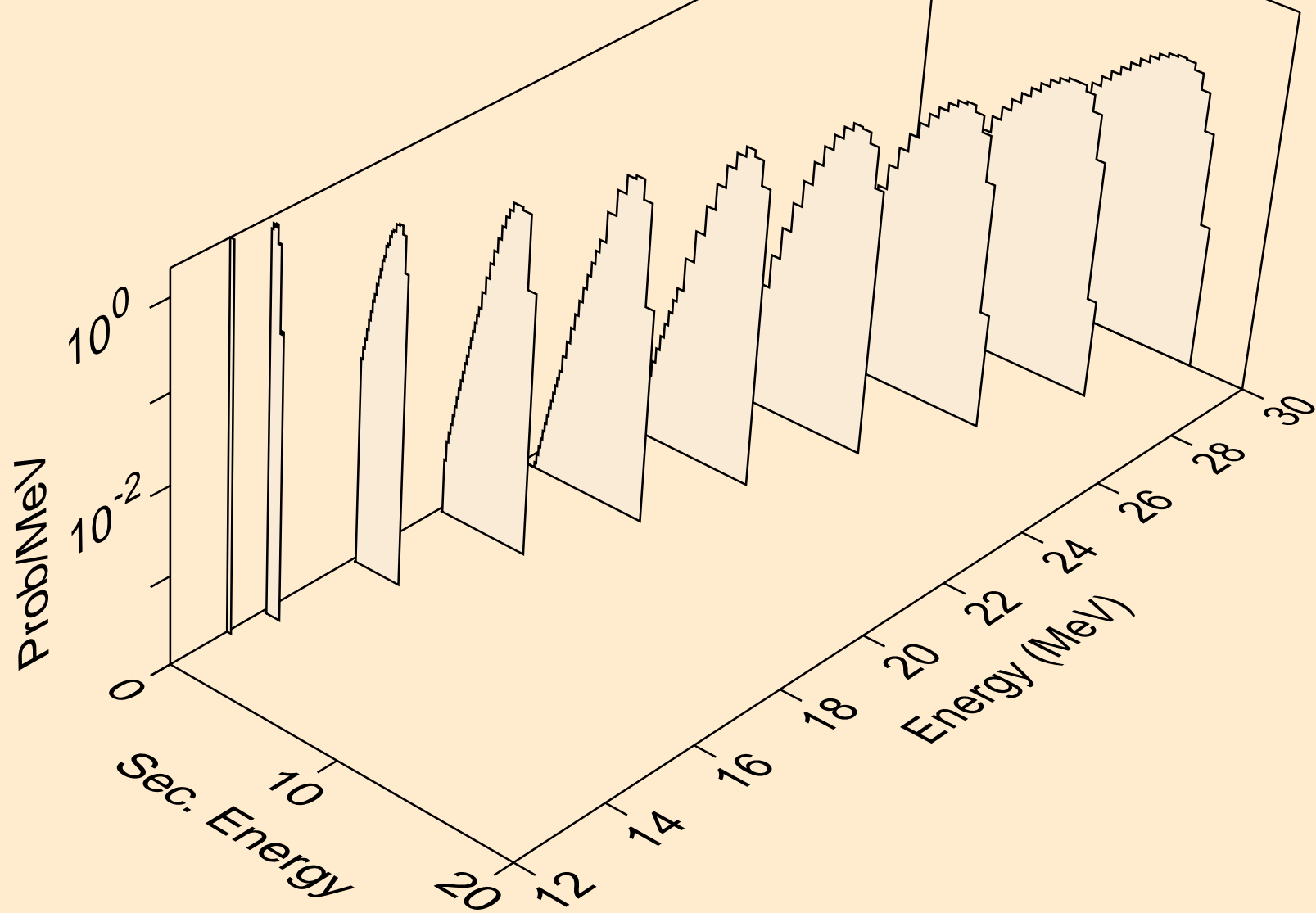

LA141 TRITON ACER TENDL-2021 LIBRARY; T=0.K  
deuterons from (t,n\*)d

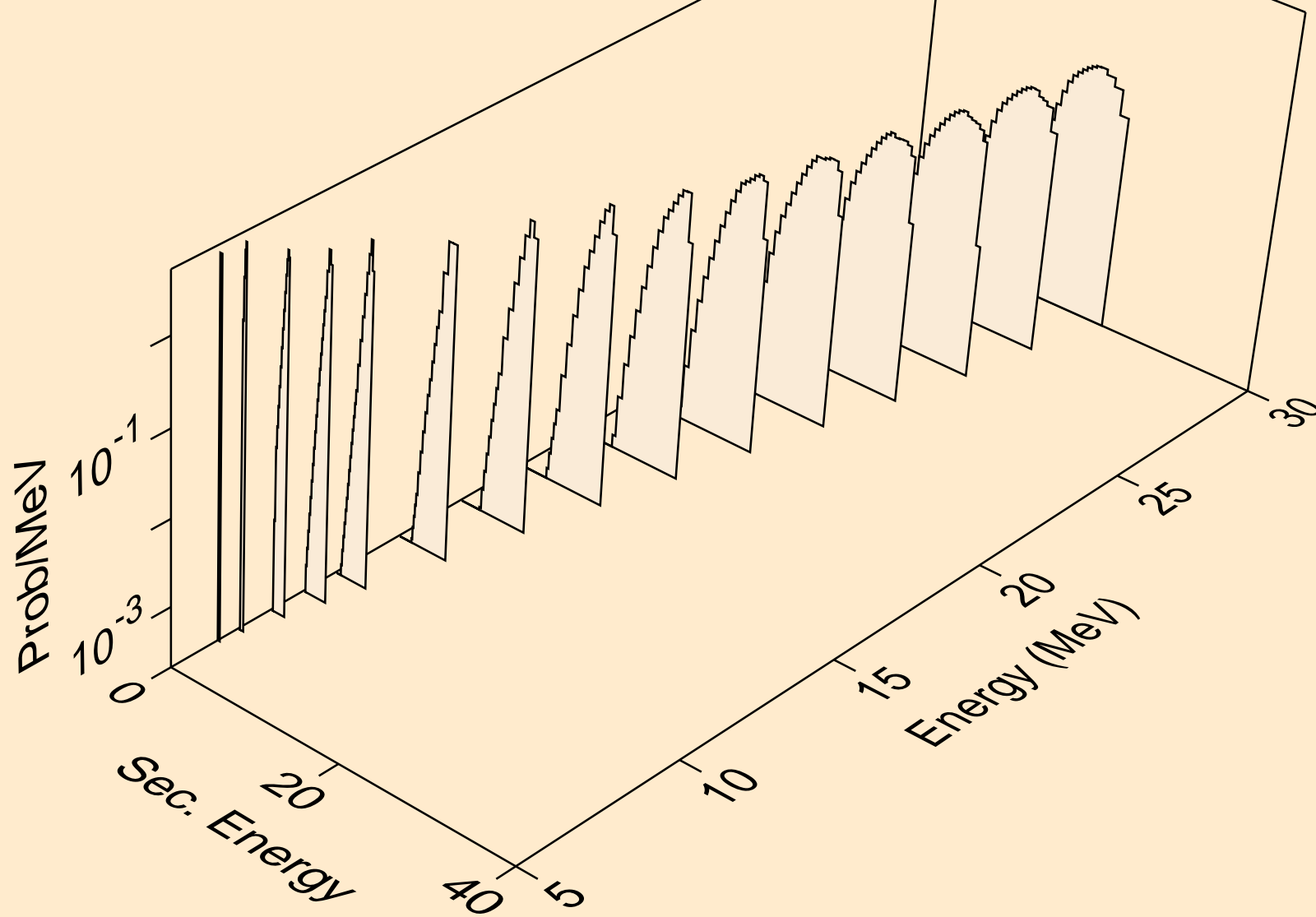



LA141 TRITON ACER TENDL-2021 LIBRARY; T=0.K  
deuterons from (t,d)

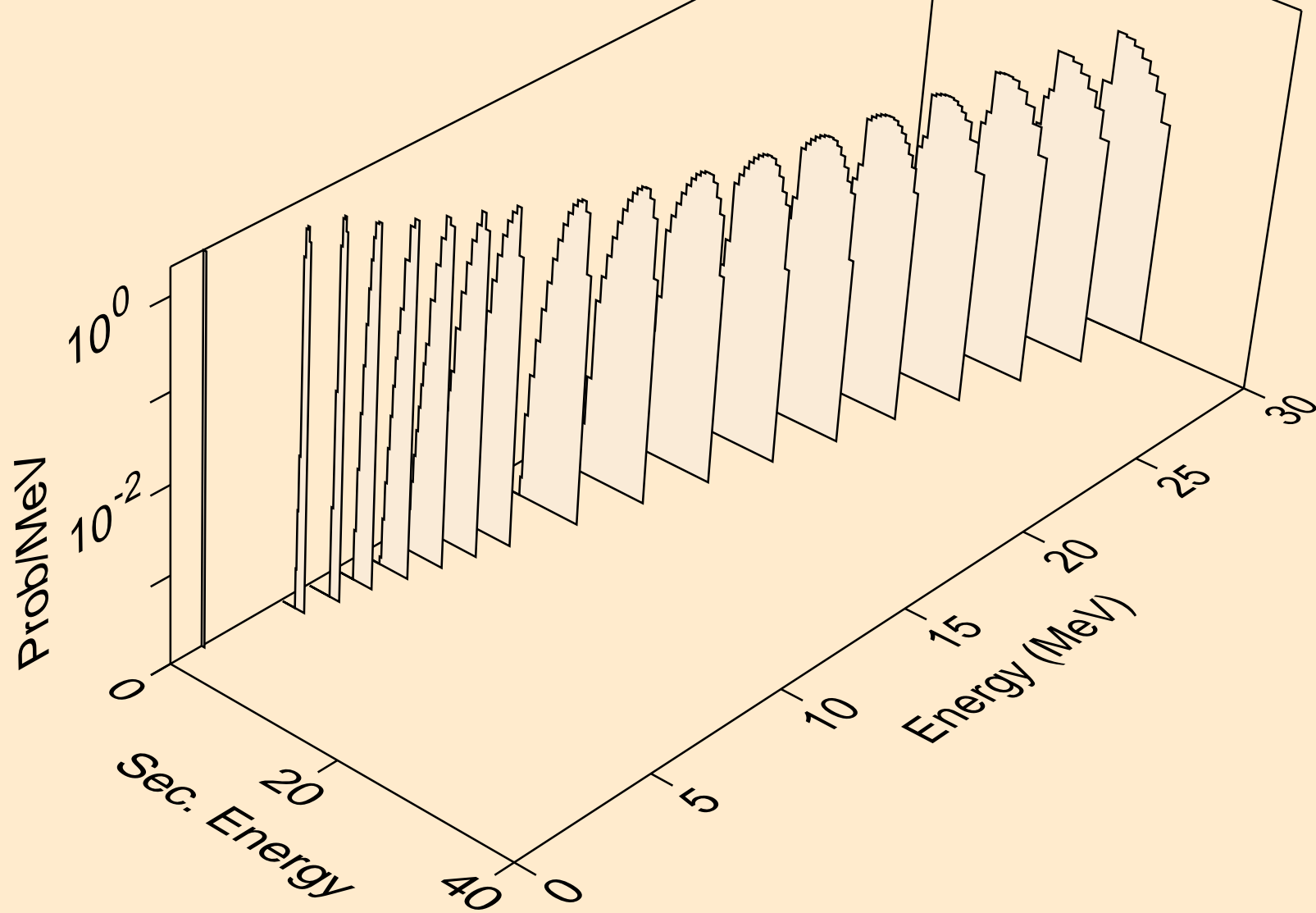

LA141 TRITON ACER TENDL-2021 LIBRARY; T=0.K  
deuterons from (t,pd)

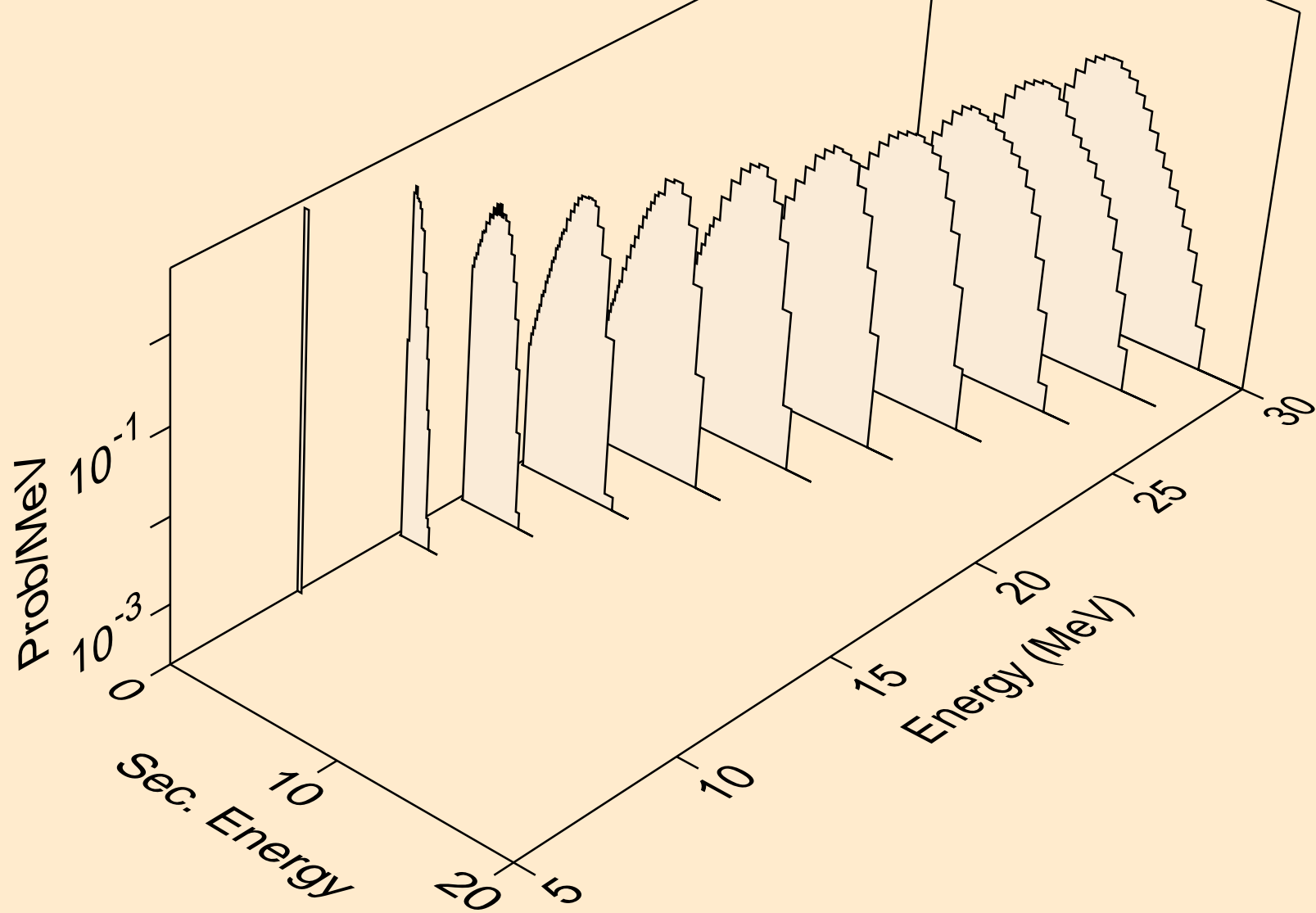

LA141 TRITON ACER TENDL-2021 LIBRARY; T=0.K  
deuterons from (t,da)

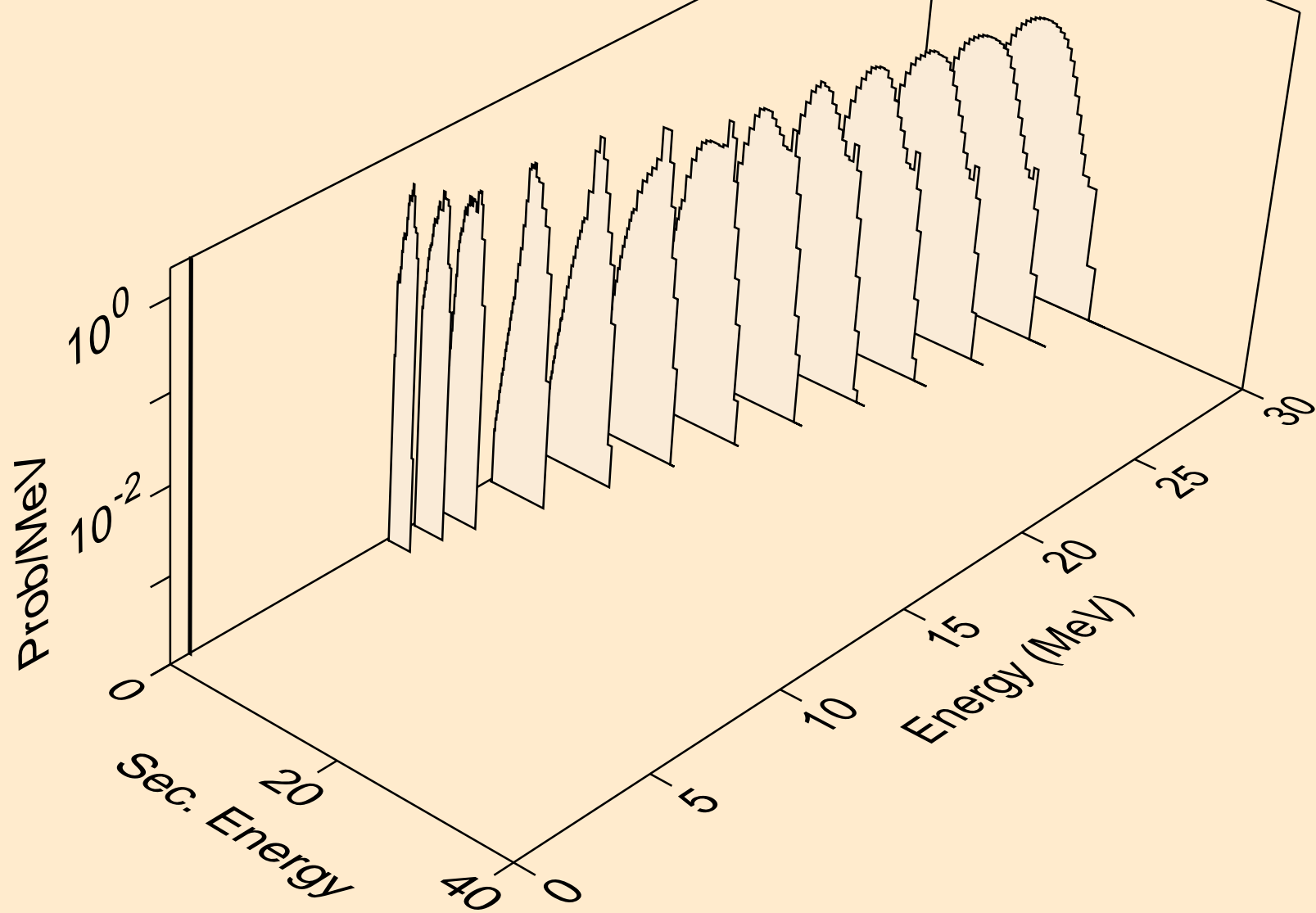

LA141 TRITON ACER TENDL-2021 LIBRARY; T=0.K  
he3s from (t,x)

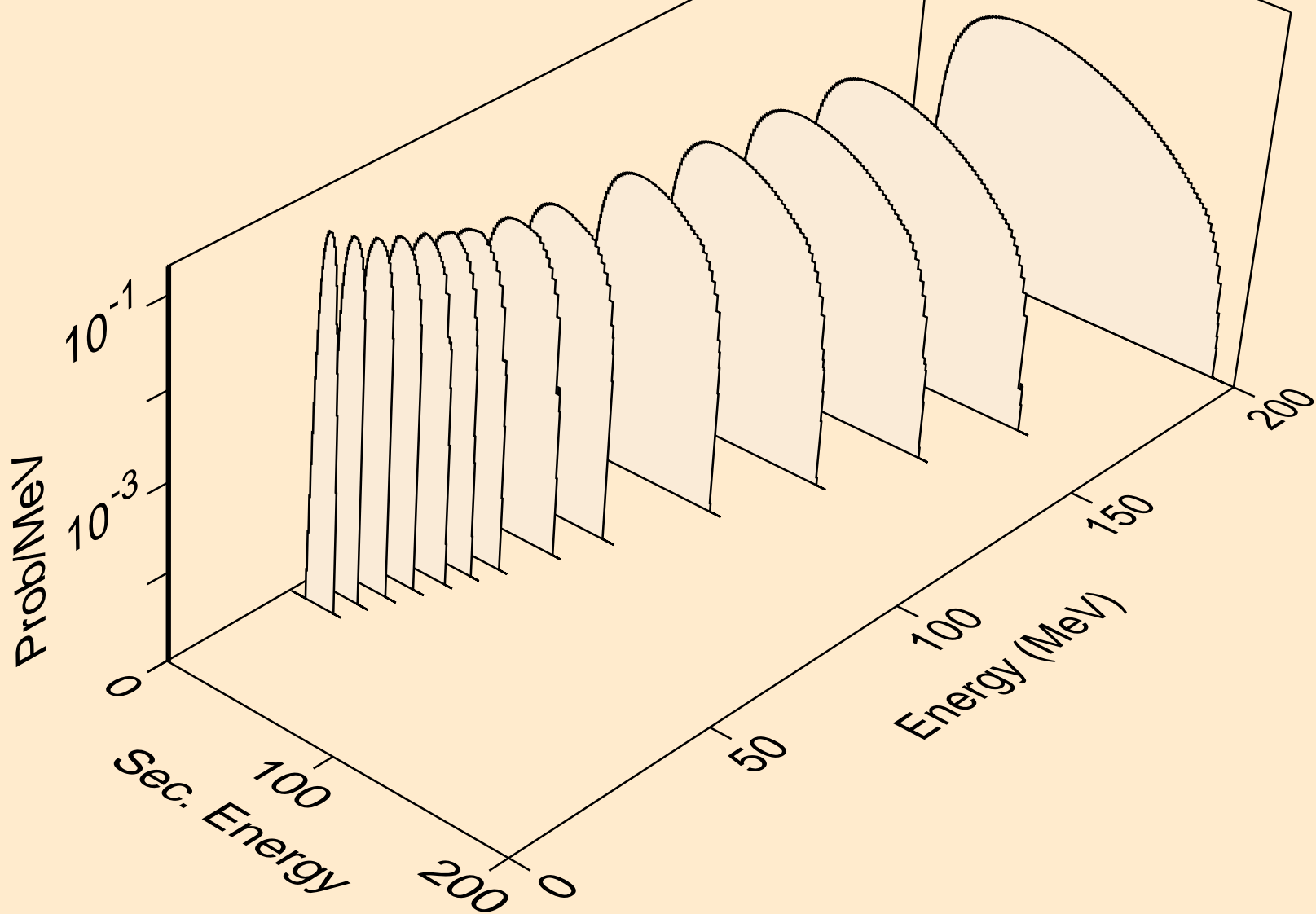

LA141 TRITON ACER TENDL-2021 LIBRARY; T=0.K  
he3s from (t,n\*)he3

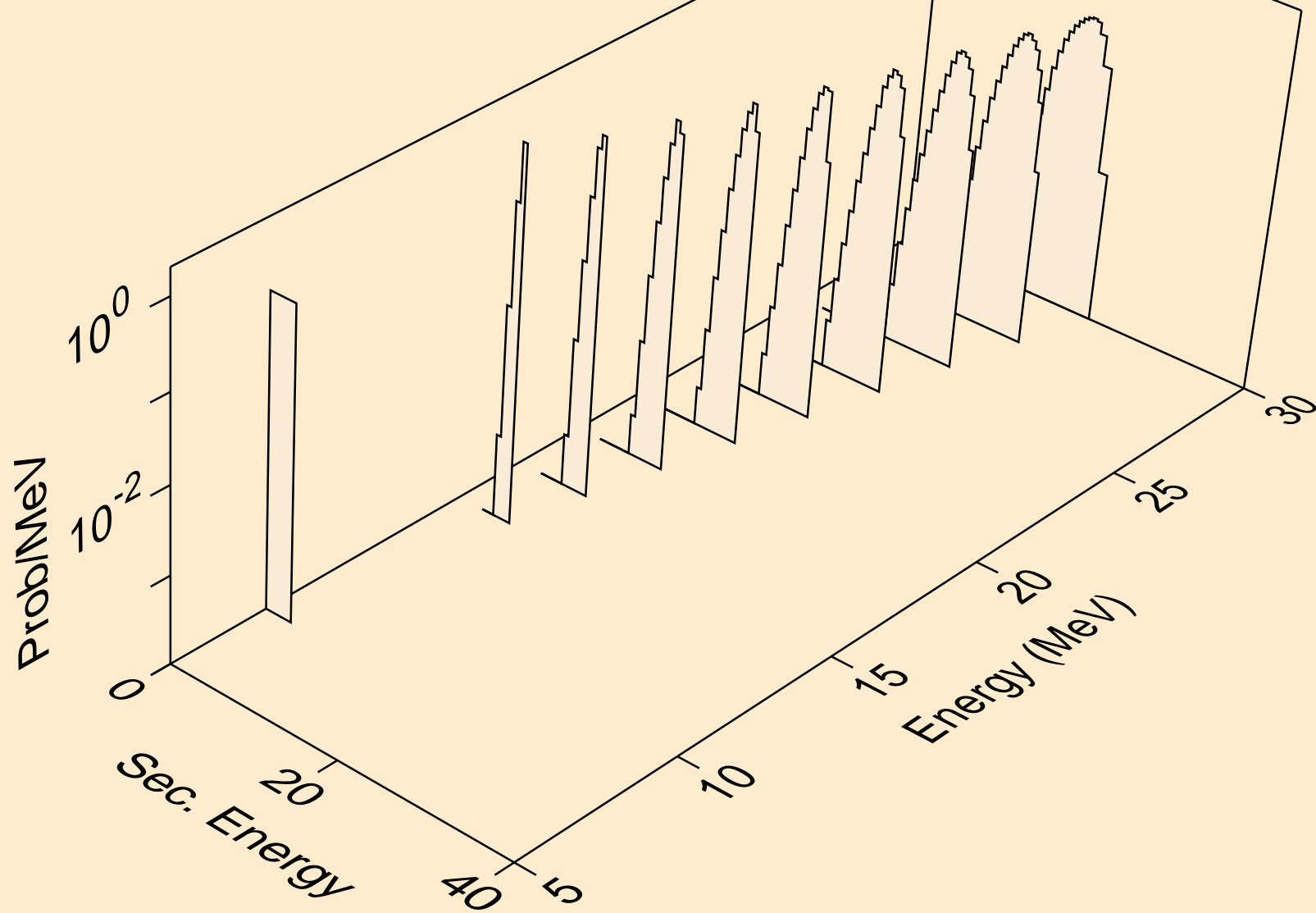

LA141 TRITON ACER TENDL-2021 LIBRARY; T=0.K  
he3s from (t,he3)

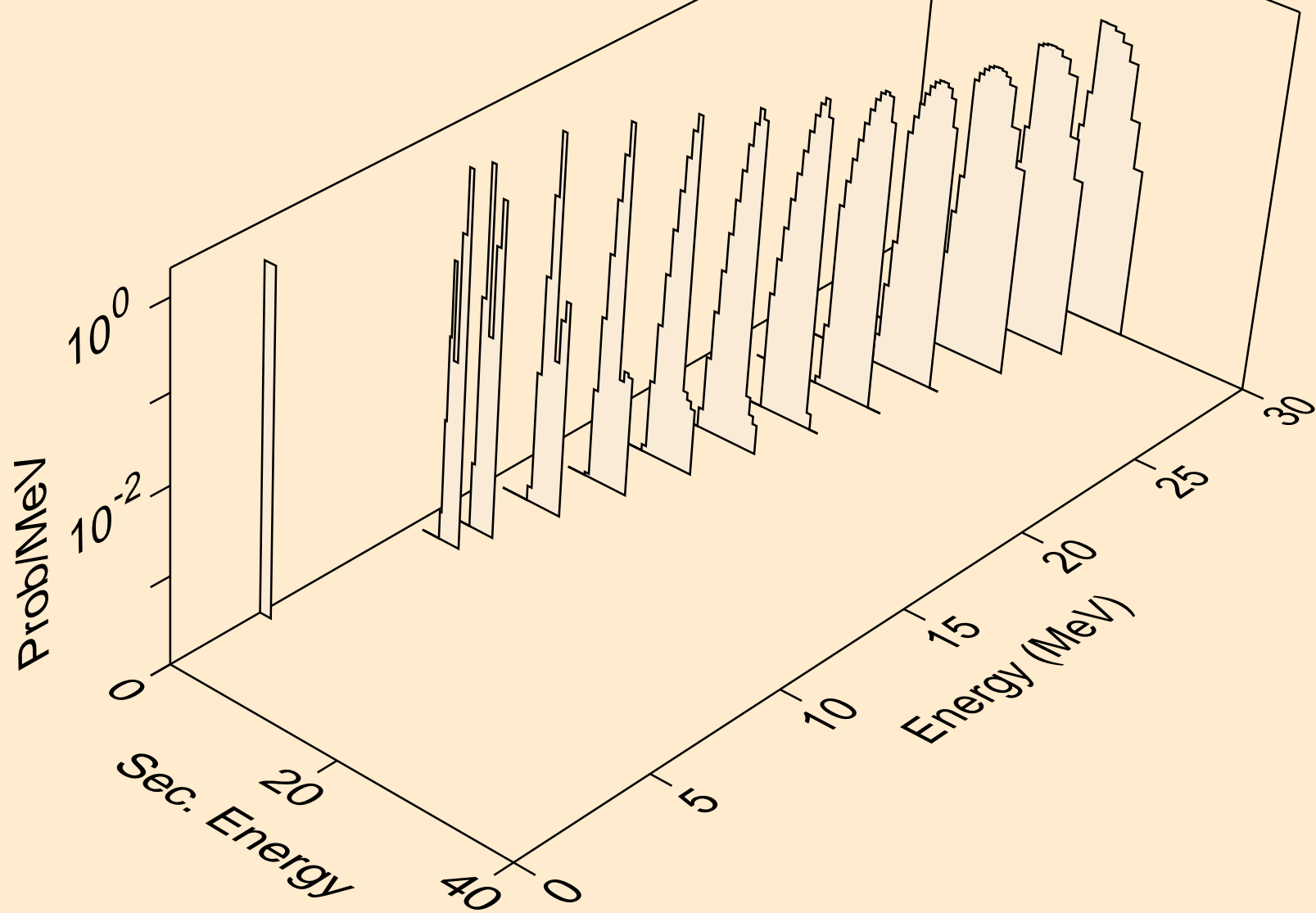

LA141 TRITON ACER TENDL-2021 LIBRARY; T=0.K  
alphas from (t,x)

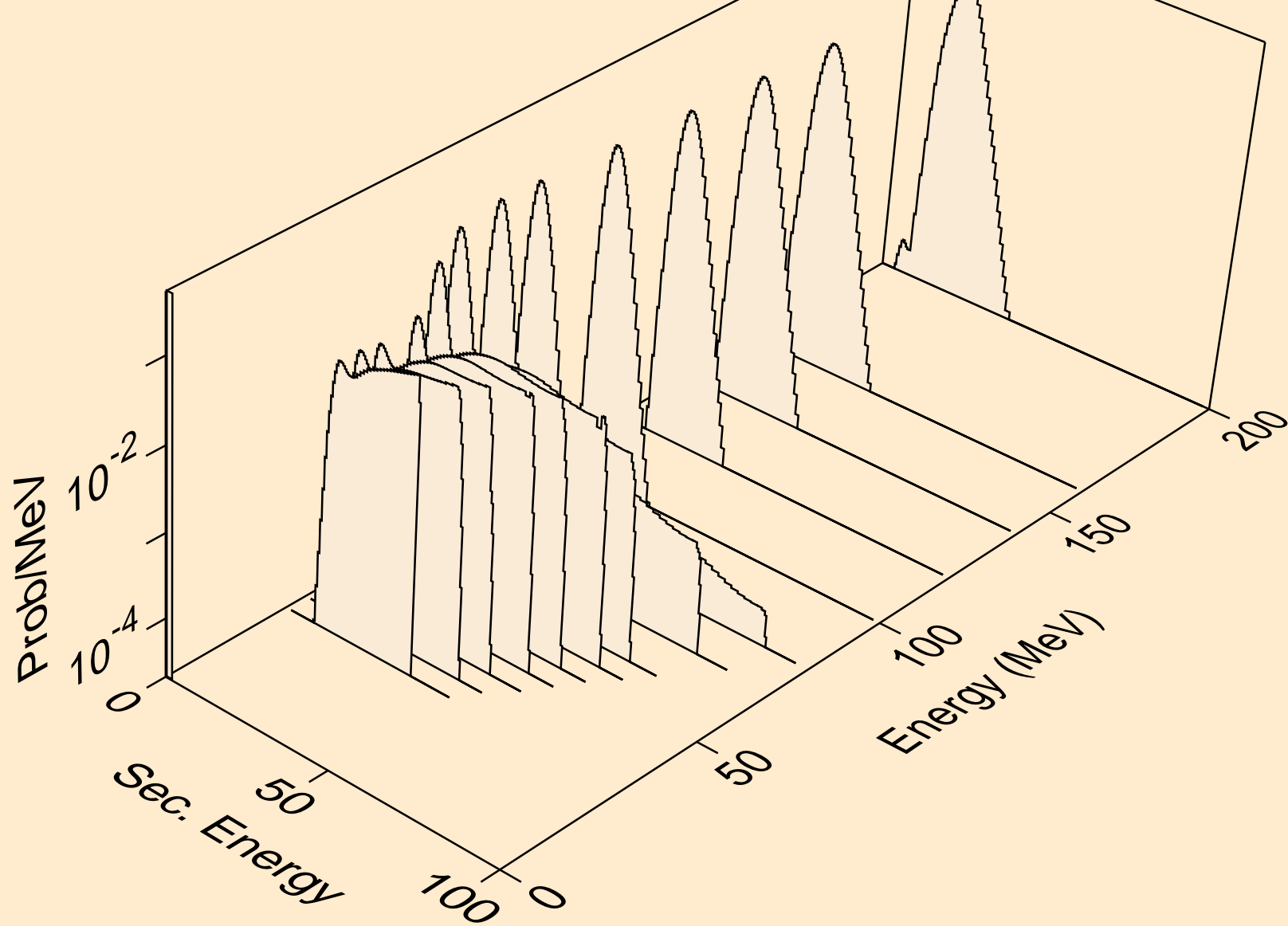

LA141 TRITON ACER TENDL-2021 LIBRARY; T=0.K  
alphas from (t,n\*)a

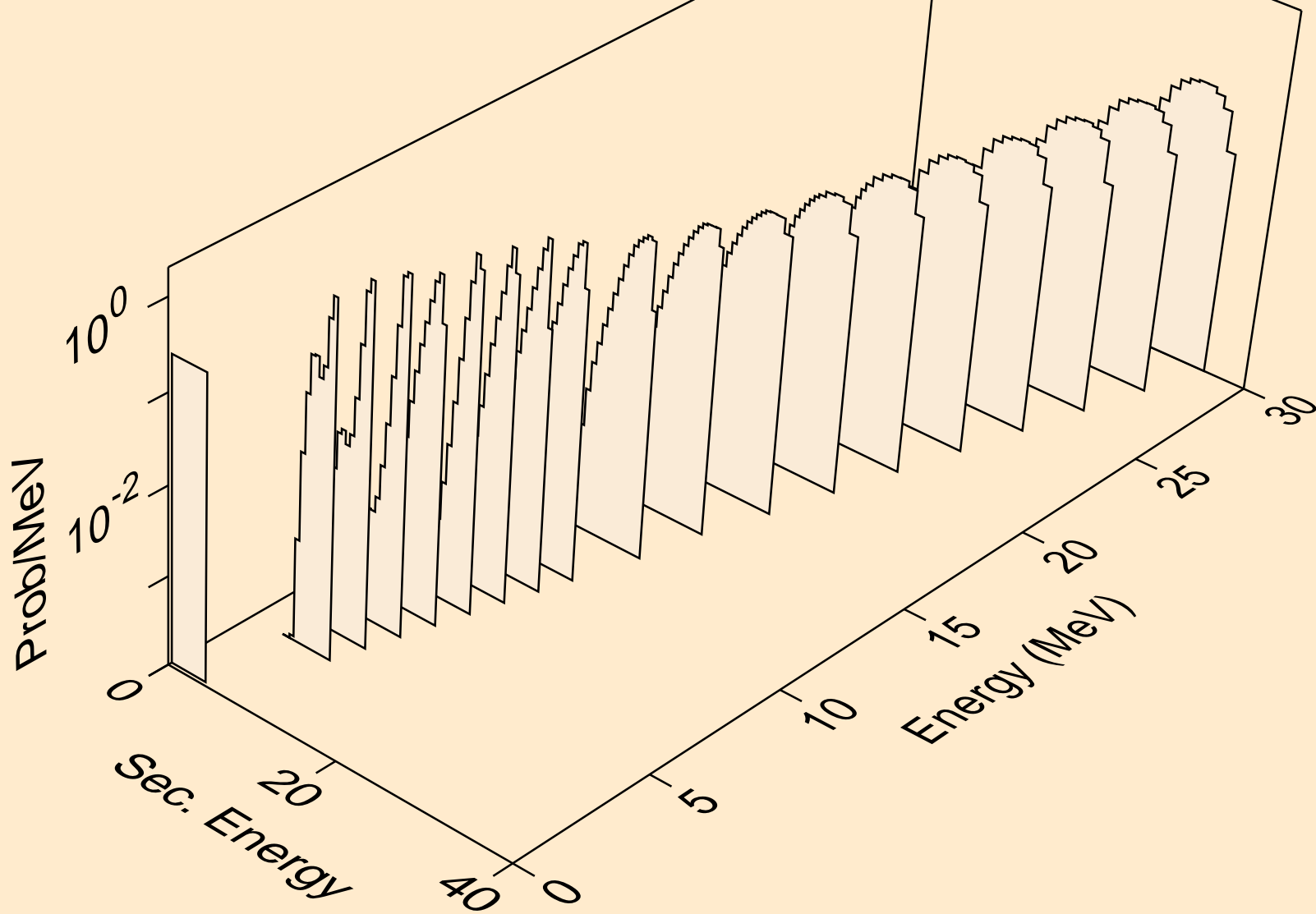



LA141 TRITON ACER TENDL-2021 LIBRARY; T=0.K  
alphas from (t,2n)a

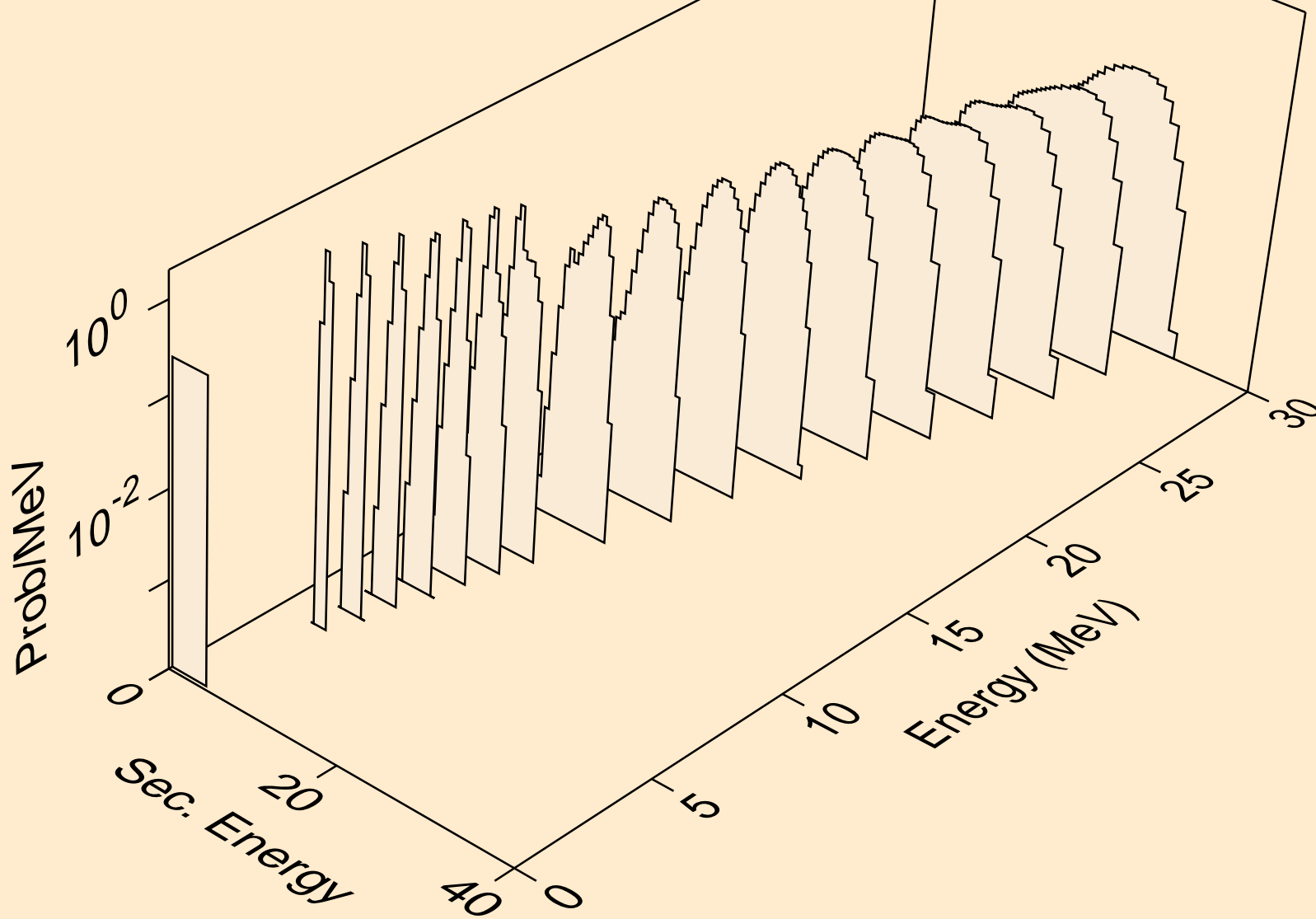

LA141 TRITON ACER TENDL-2021 LIBRARY; T=0.K  
alphas from (t,3n)a

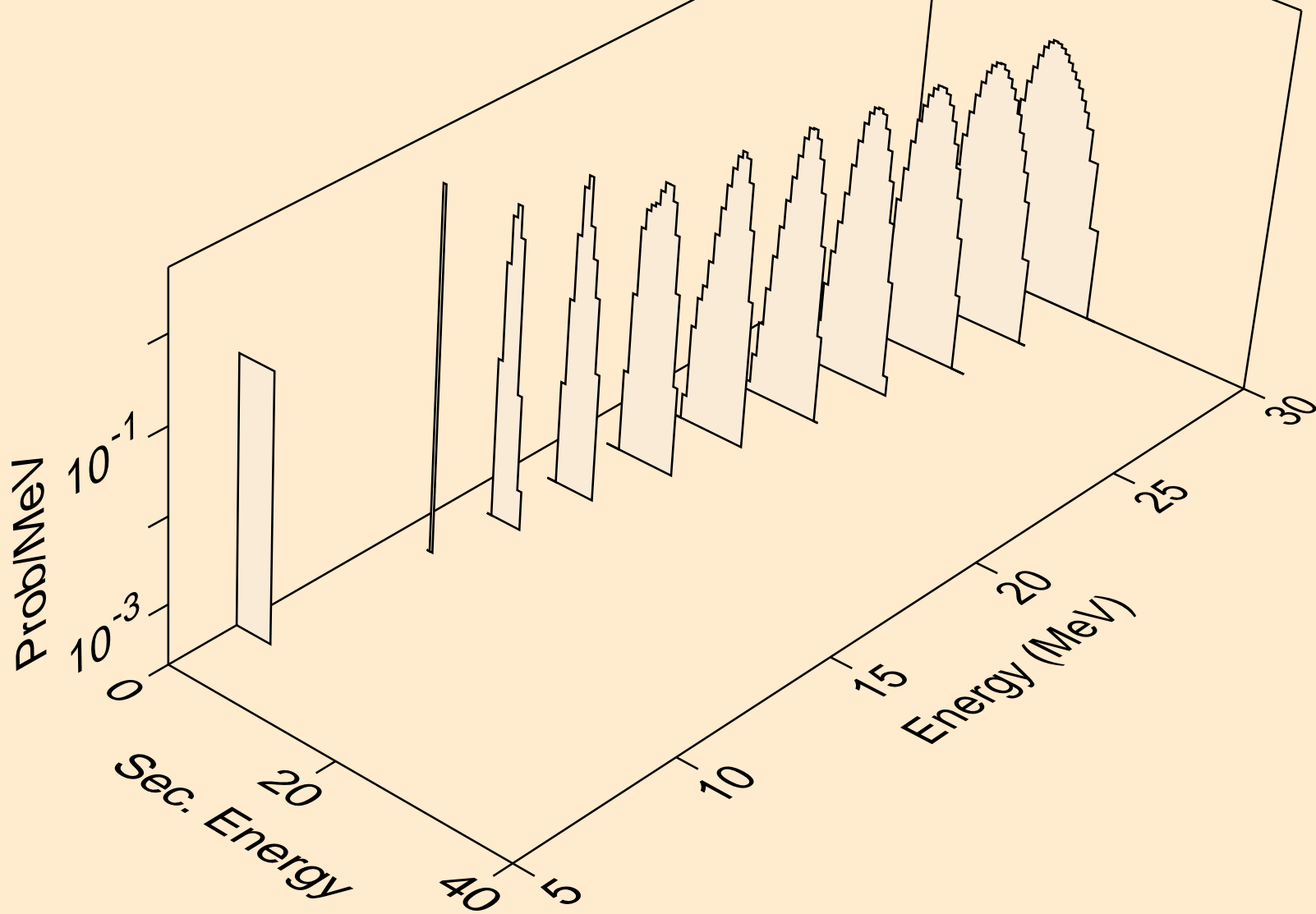

LA141 TRITON ACER TENDL-2021 LIBRARY; T=0.K  
alphas from (t,n\*)2a

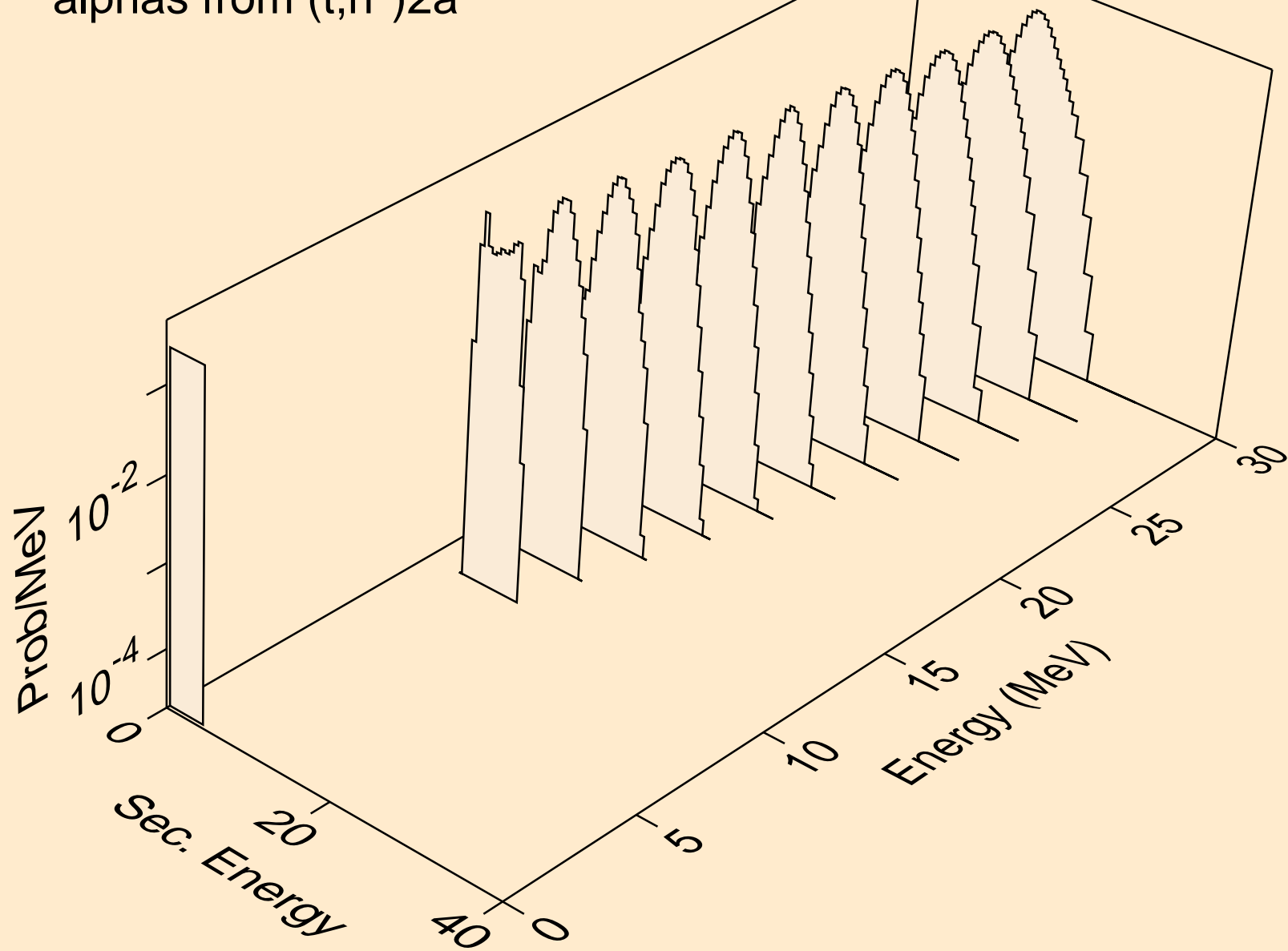

LA141 TRITON ACER TENDL-2021 LIBRARY; T=0.K  
alphas from (t,2n)2a

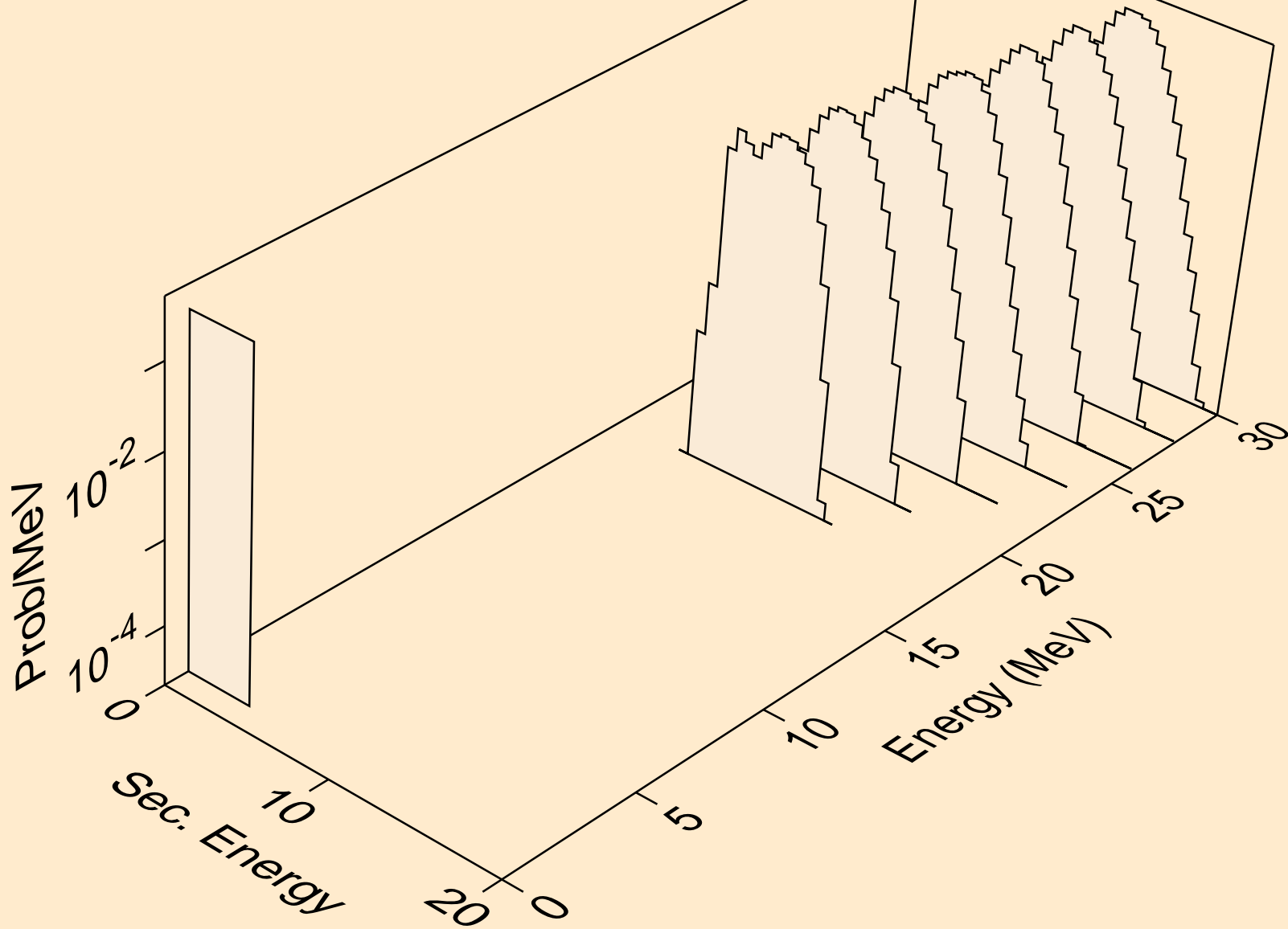

LA141 TRITON ACER TENDL-2021 LIBRARY; T=0.K  
alphas from (t,npa)

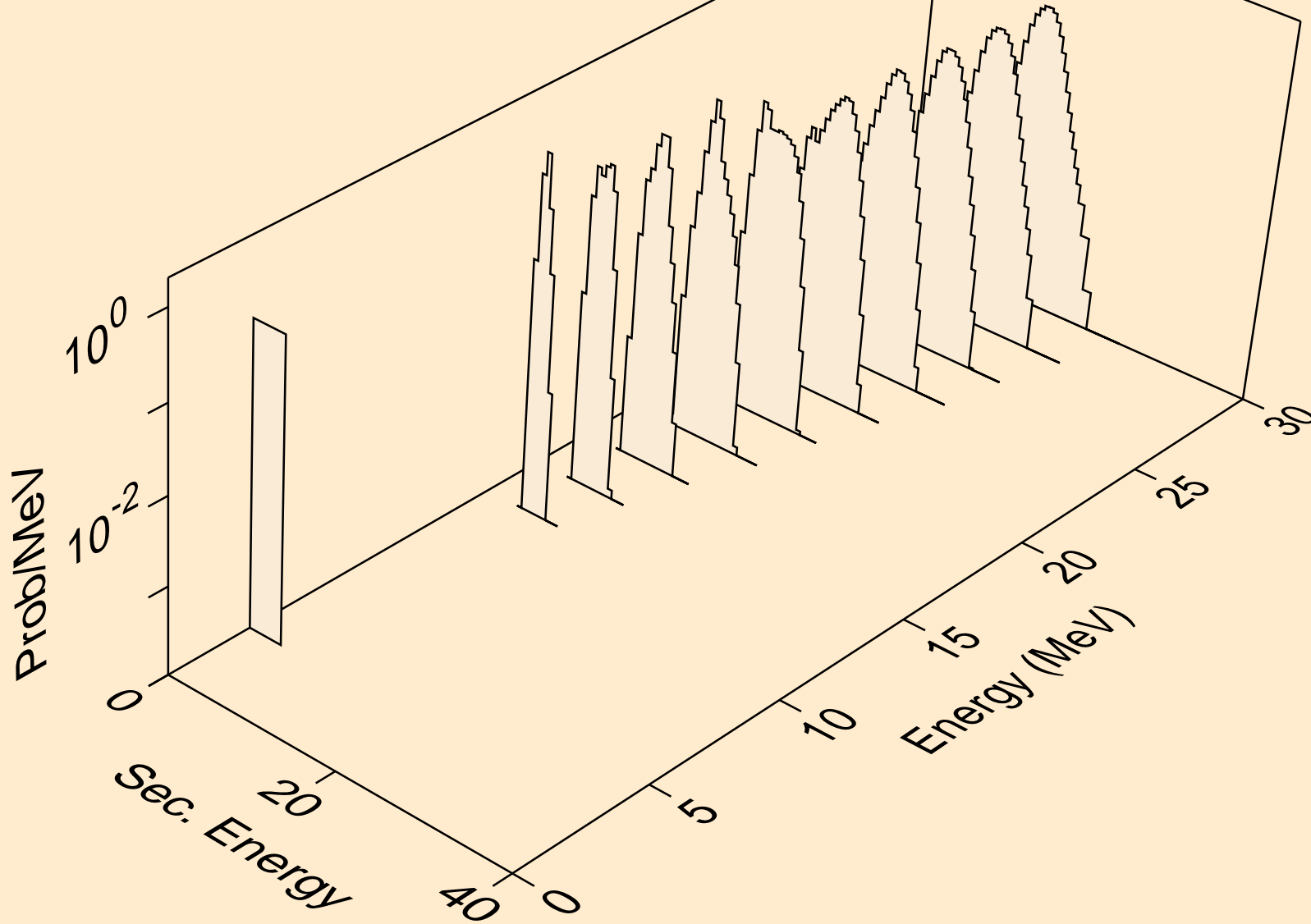

LA141 TRITON ACER TENDL-2021 LIBRARY; T=0.K  
alphas from (t,a)

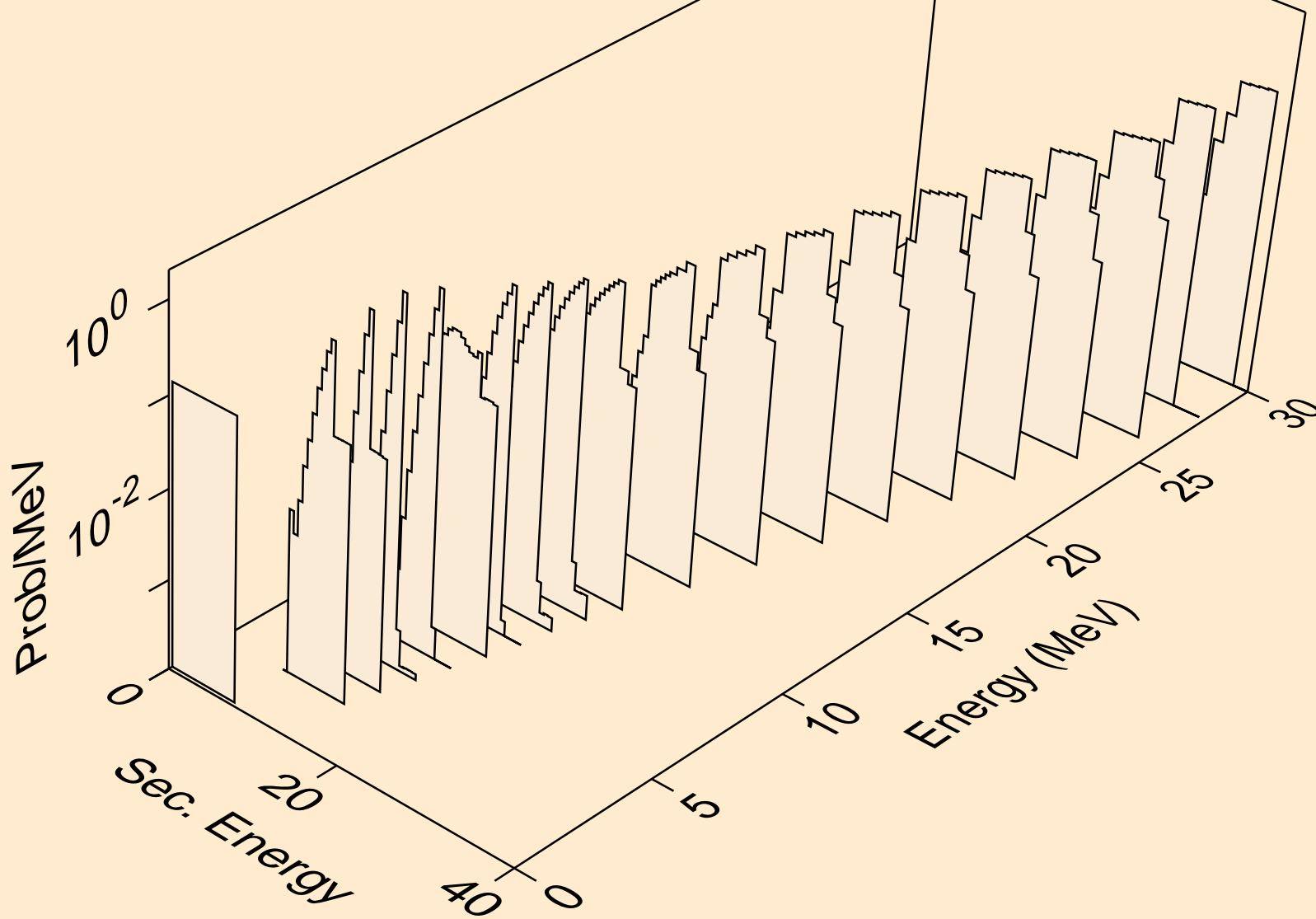

LA141 TRITON ACER TENDL-2021 LIBRARY; T=0.K  
alphas from (t,2a)

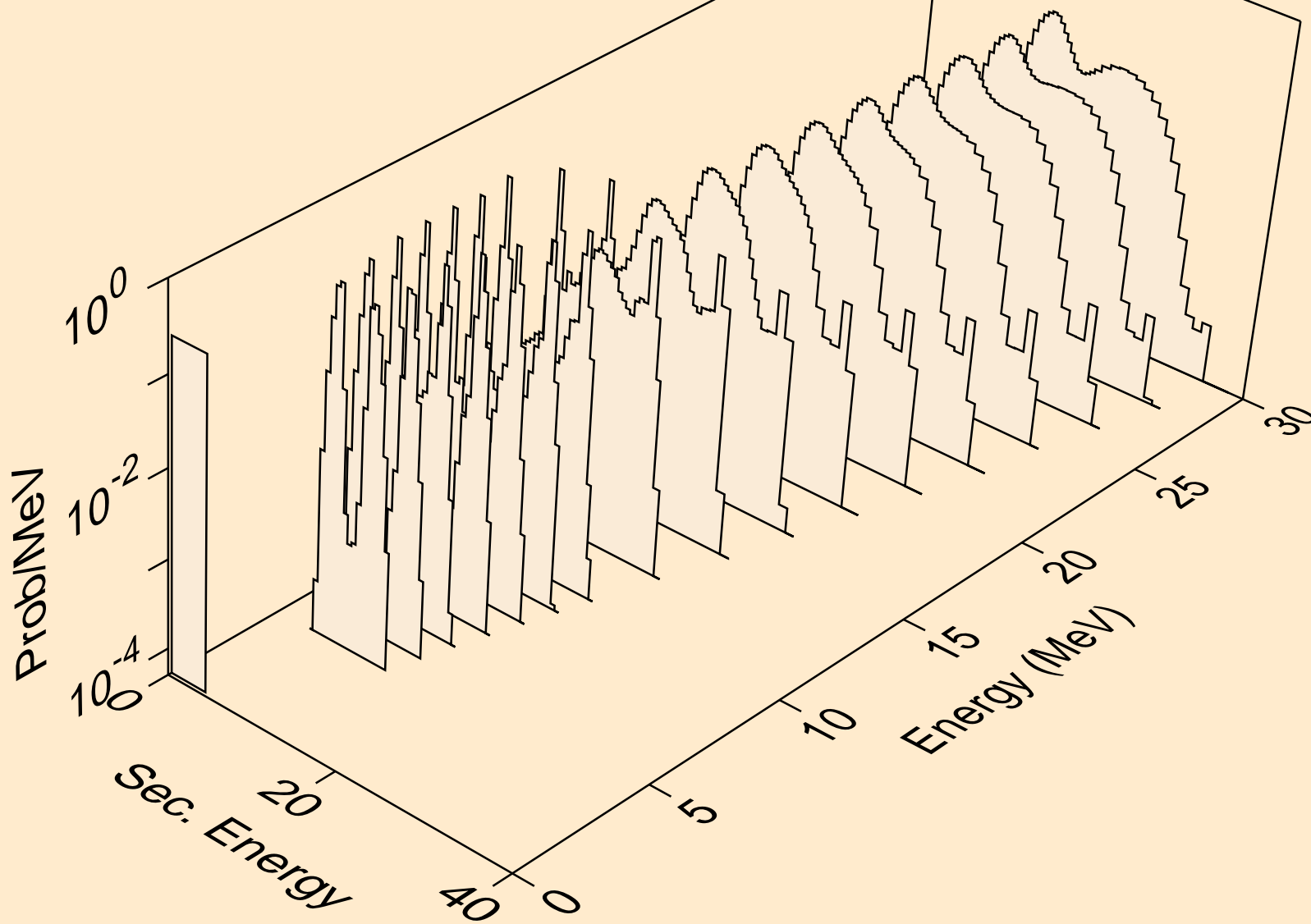

LA141 TRITON ACER TENDL-2021 LIBRARY; T=0.K  
alphas from (t,pa)

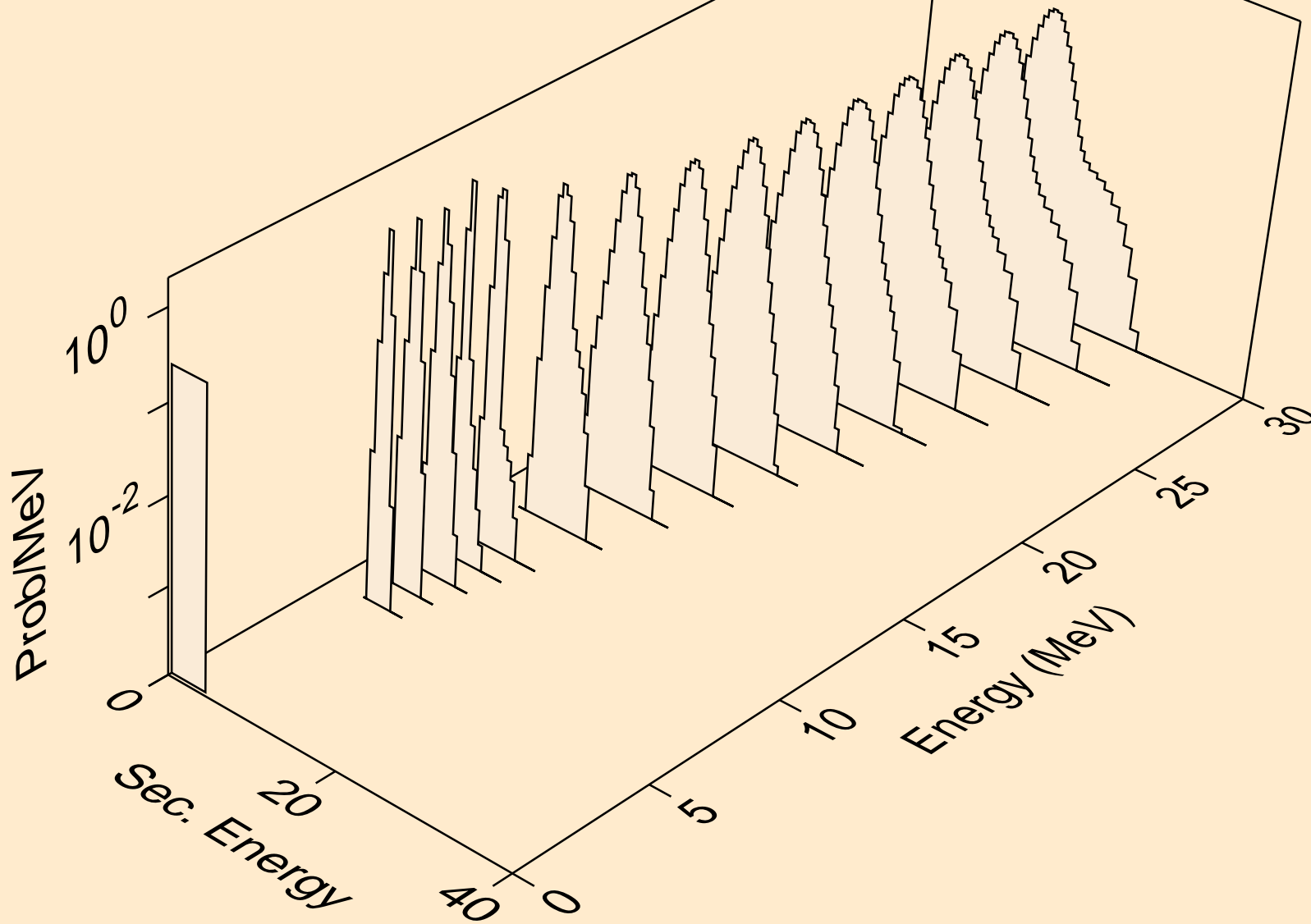



LA141 TRITON ACER TENDL-2021 LIBRARY; T=0.K  
alphas from (t,da)

