

LR259 TRITON ACER TENDL-2021 LIBRARY; T=0.K  
Principal cross sections

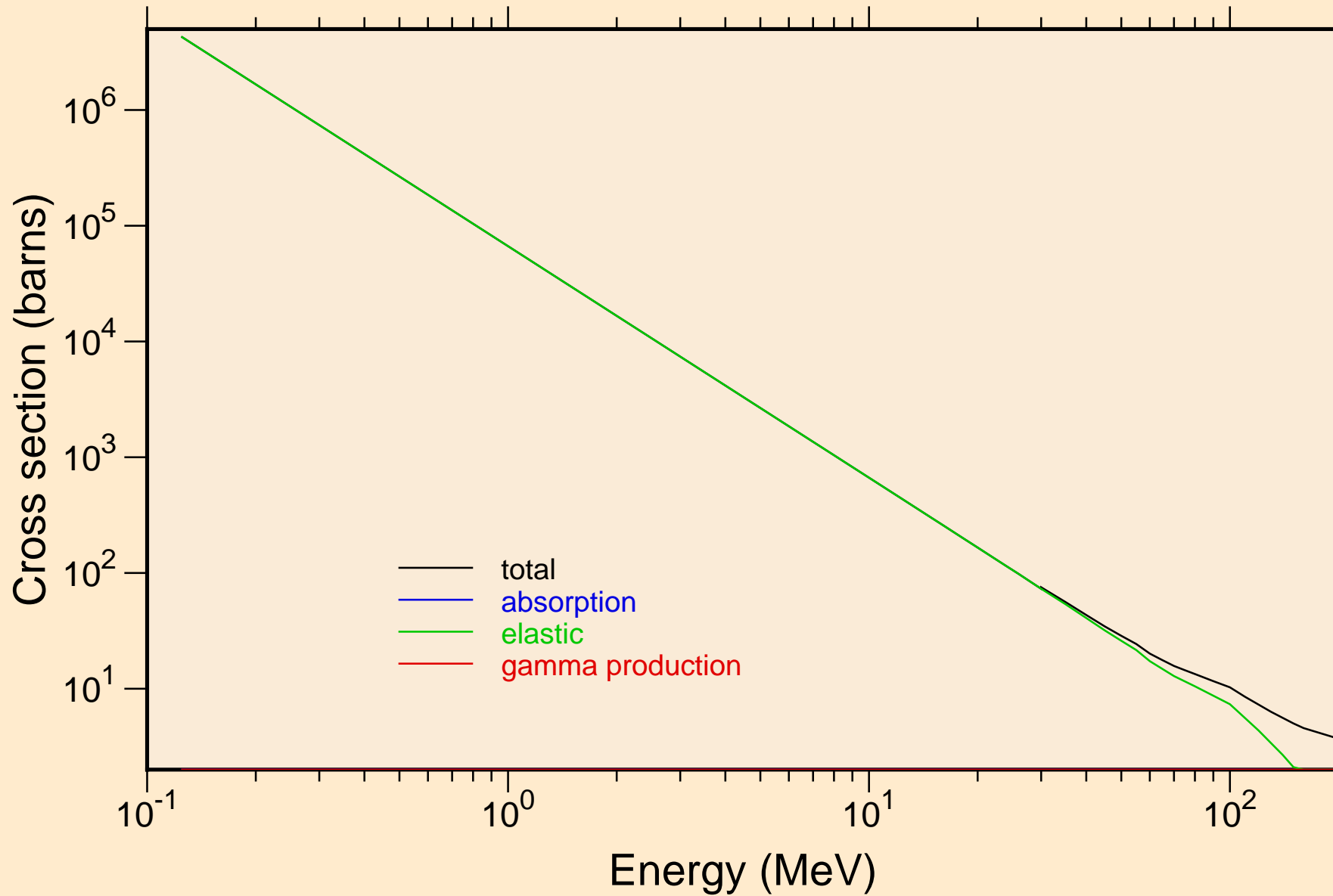

LR259 TRITON ACER TENDL-2021 LIBRARY; T=0.K

Heating

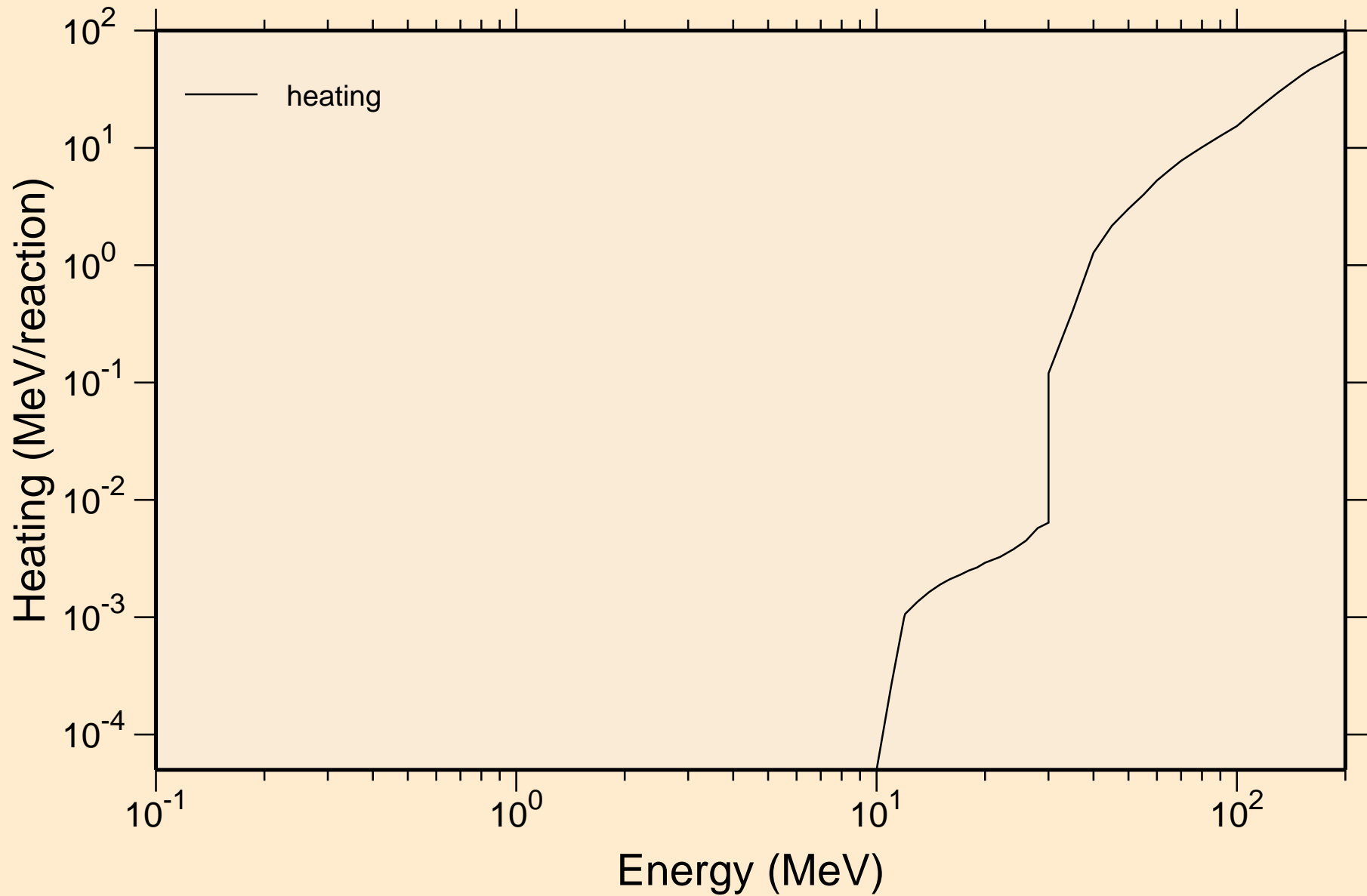

# LR259 TRITON ACER TENDL-2021 LIBRARY; T=0.K

## Principal cross sections

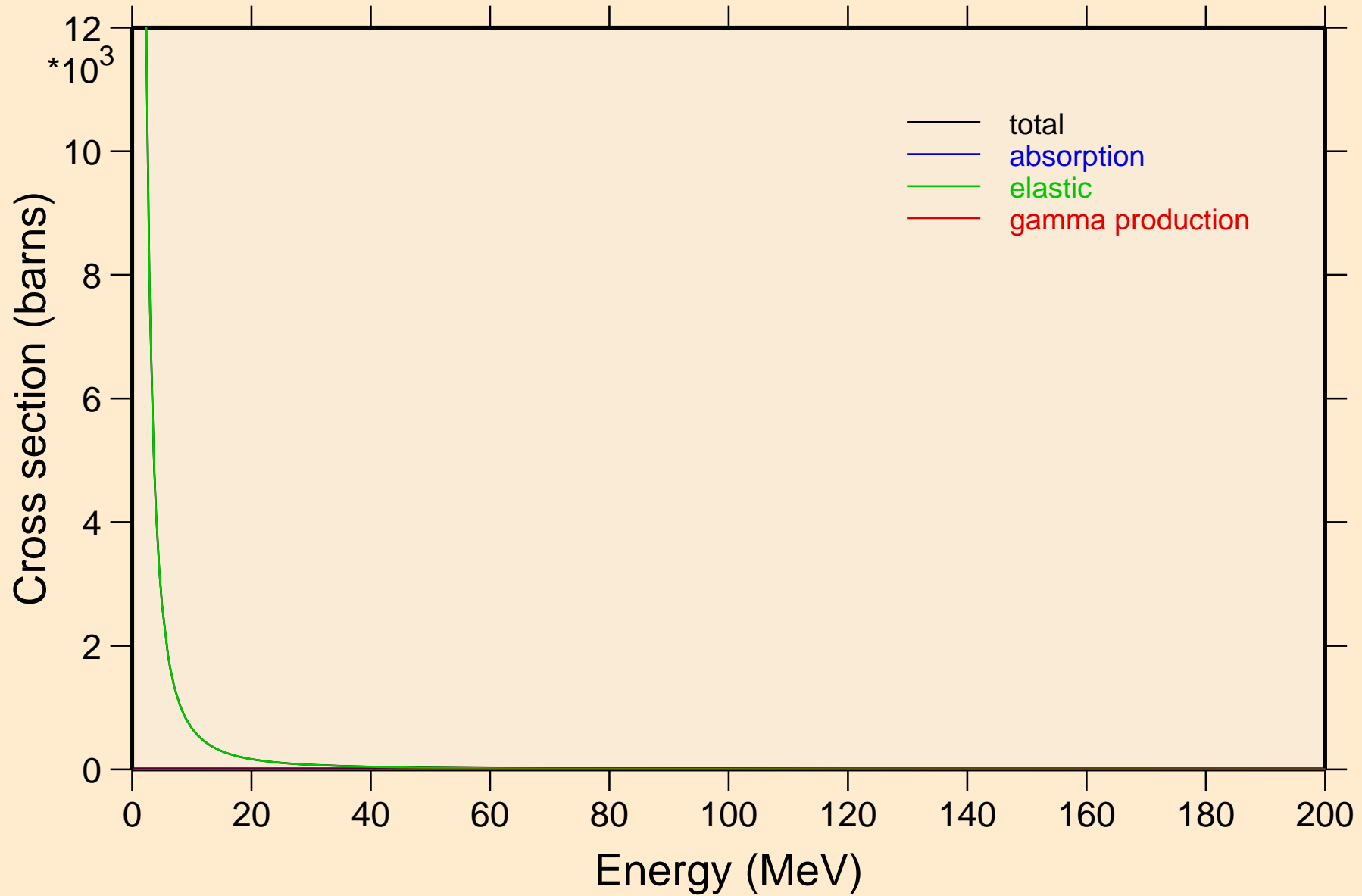

LR259 TRITON ACER TENDL-2021 LIBRARY; T=0.K

Heating

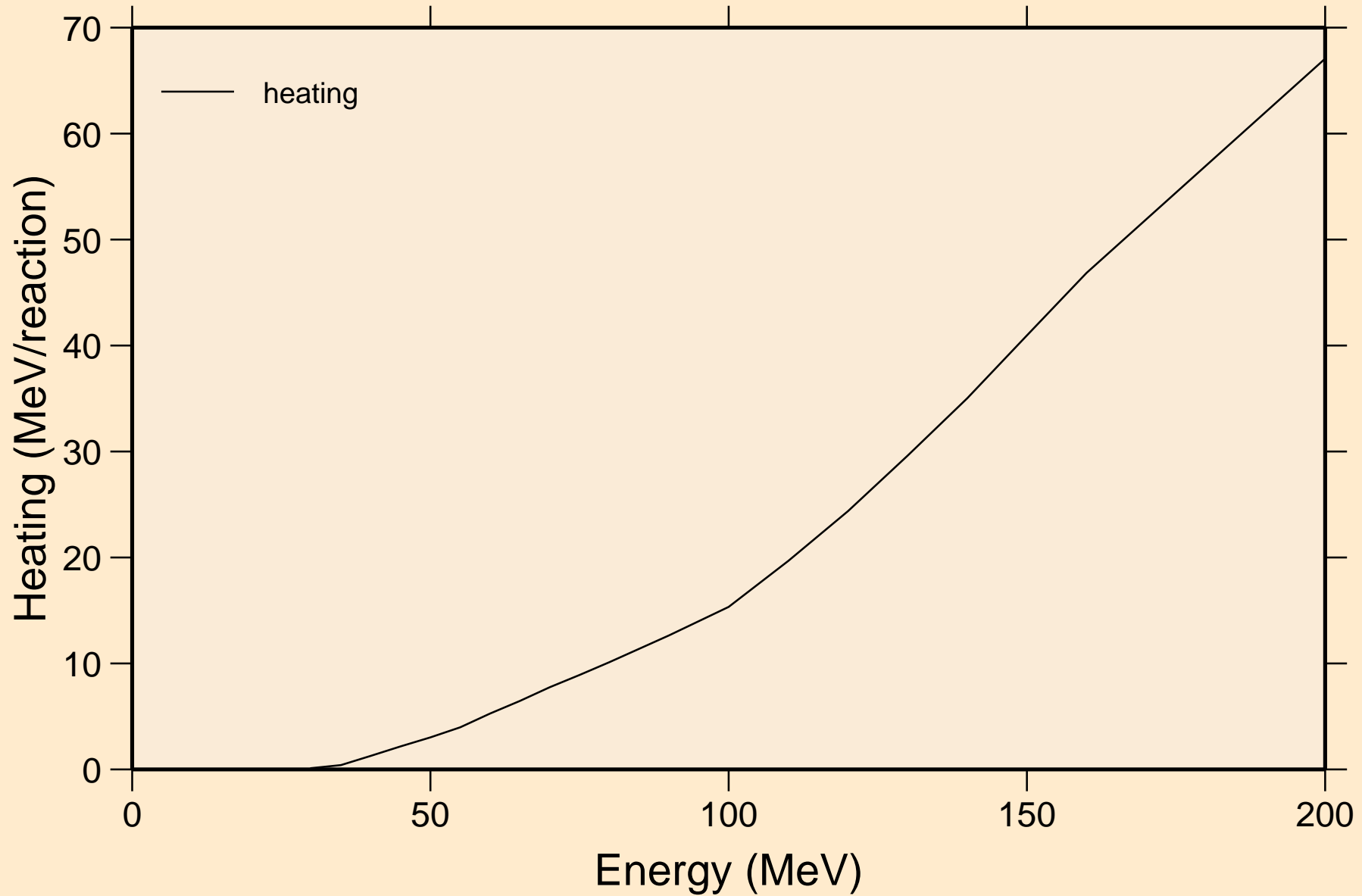

LR259 TRITON ACER TENDL-2021 LIBRARY; T=0.K  
Threshold reactions

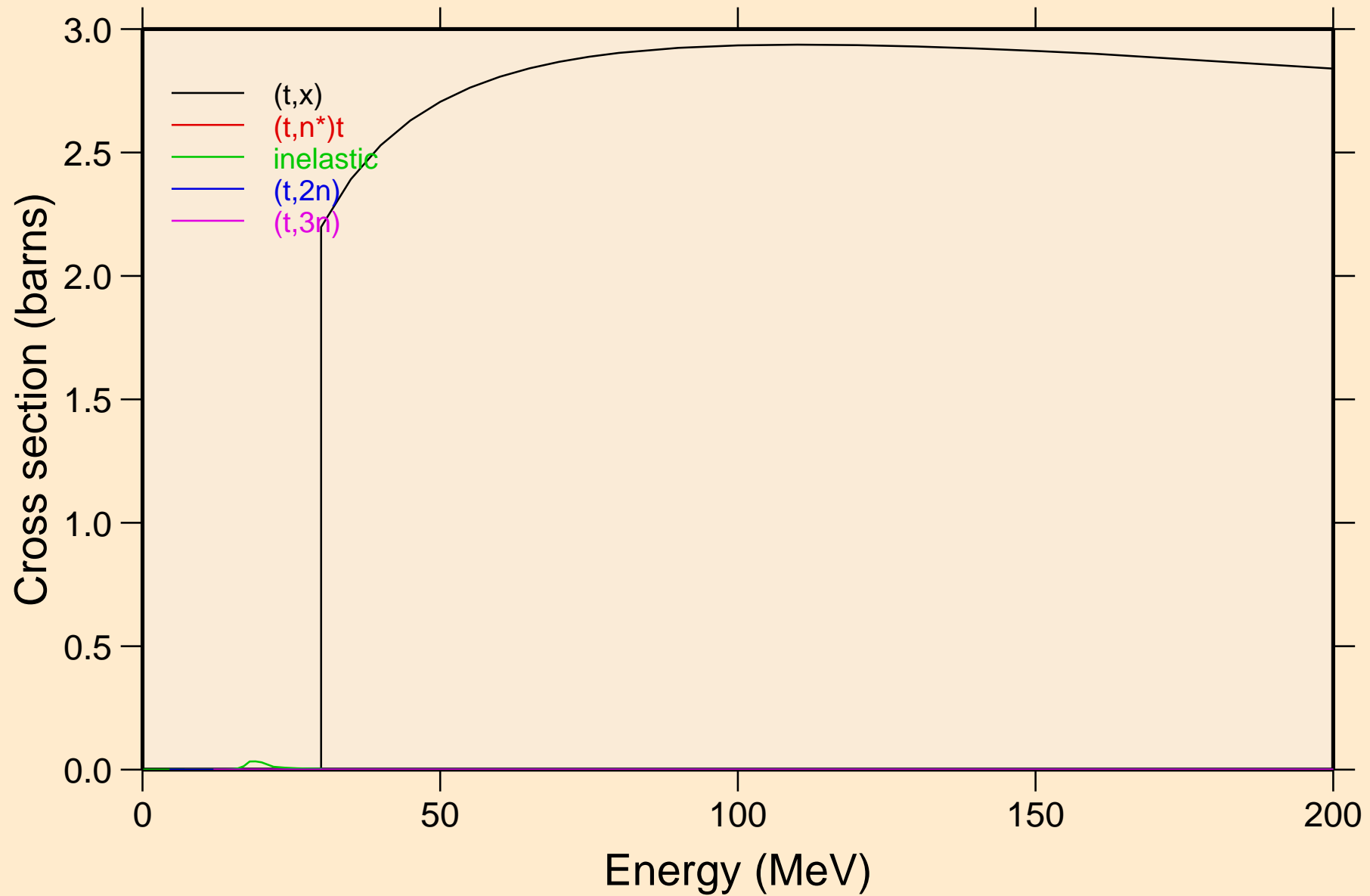

LR259 TRITON ACER TENDL-2021 LIBRARY; T=0.K  
Threshold reactions

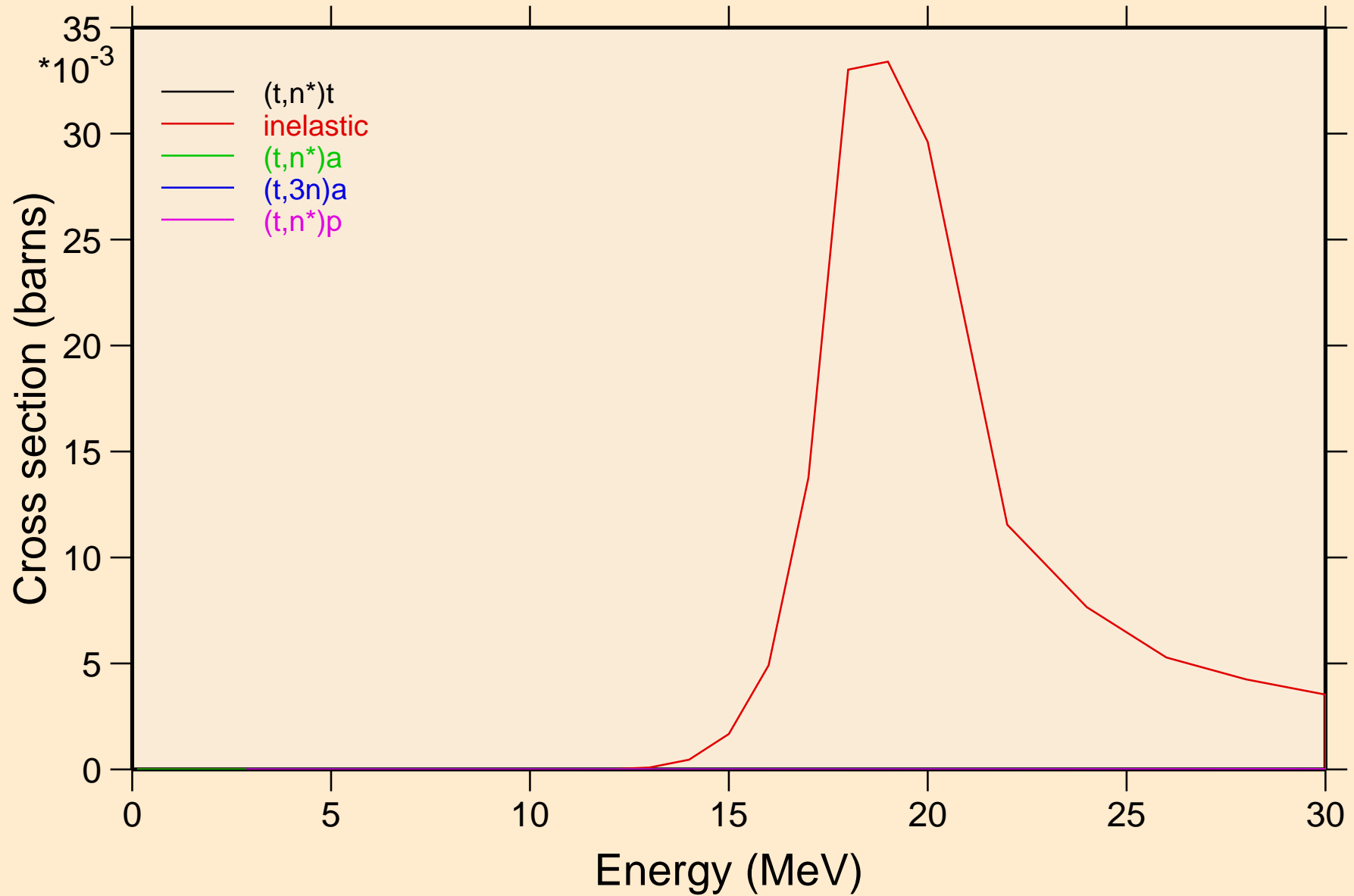

LR259 TRITON ACER TENDL-2021 LIBRARY; T=0.K  
Threshold reactions

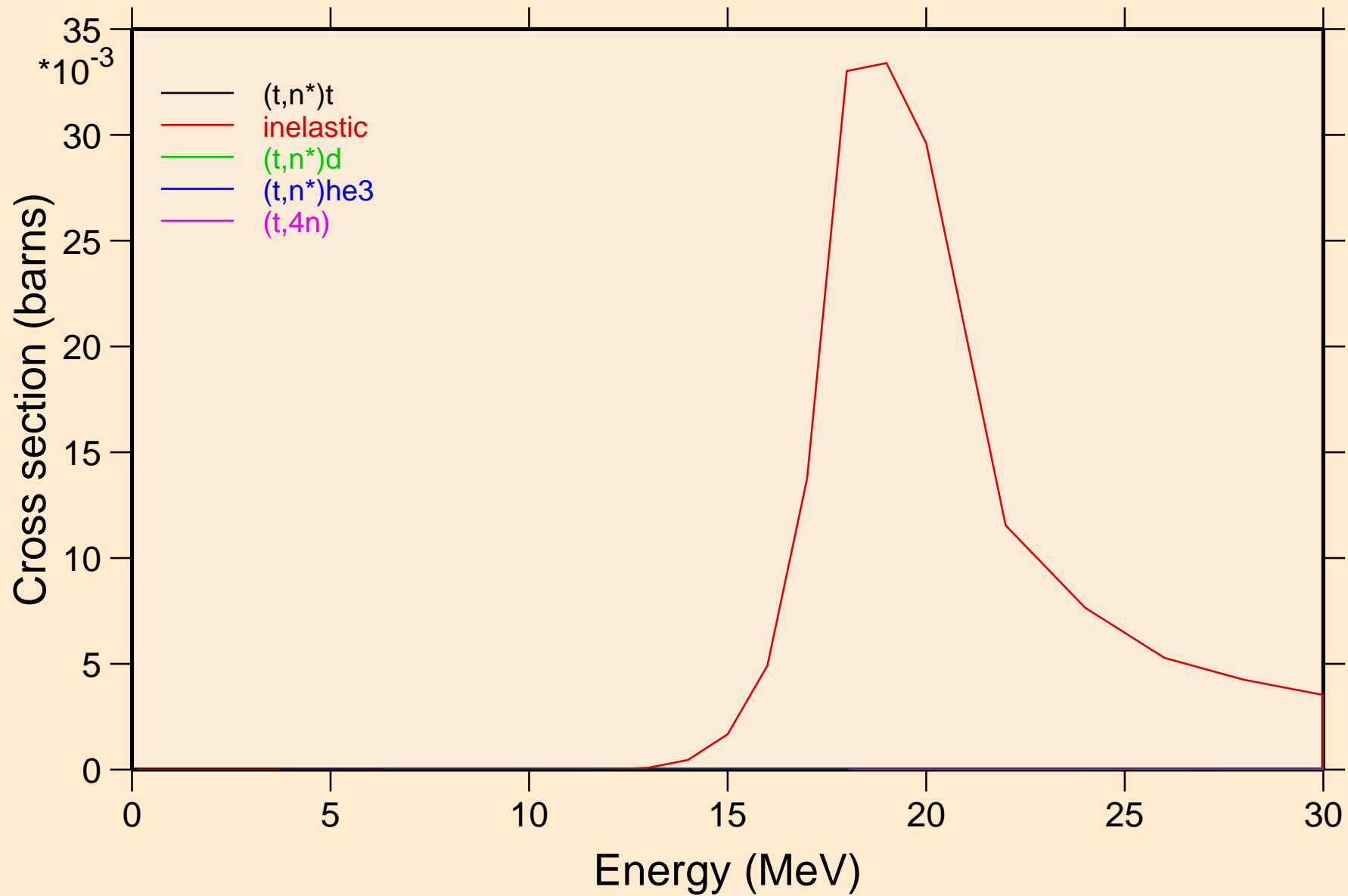

LR259 TRITON ACER TENDL-2021 LIBRARY; T=0.K  
Threshold reactions

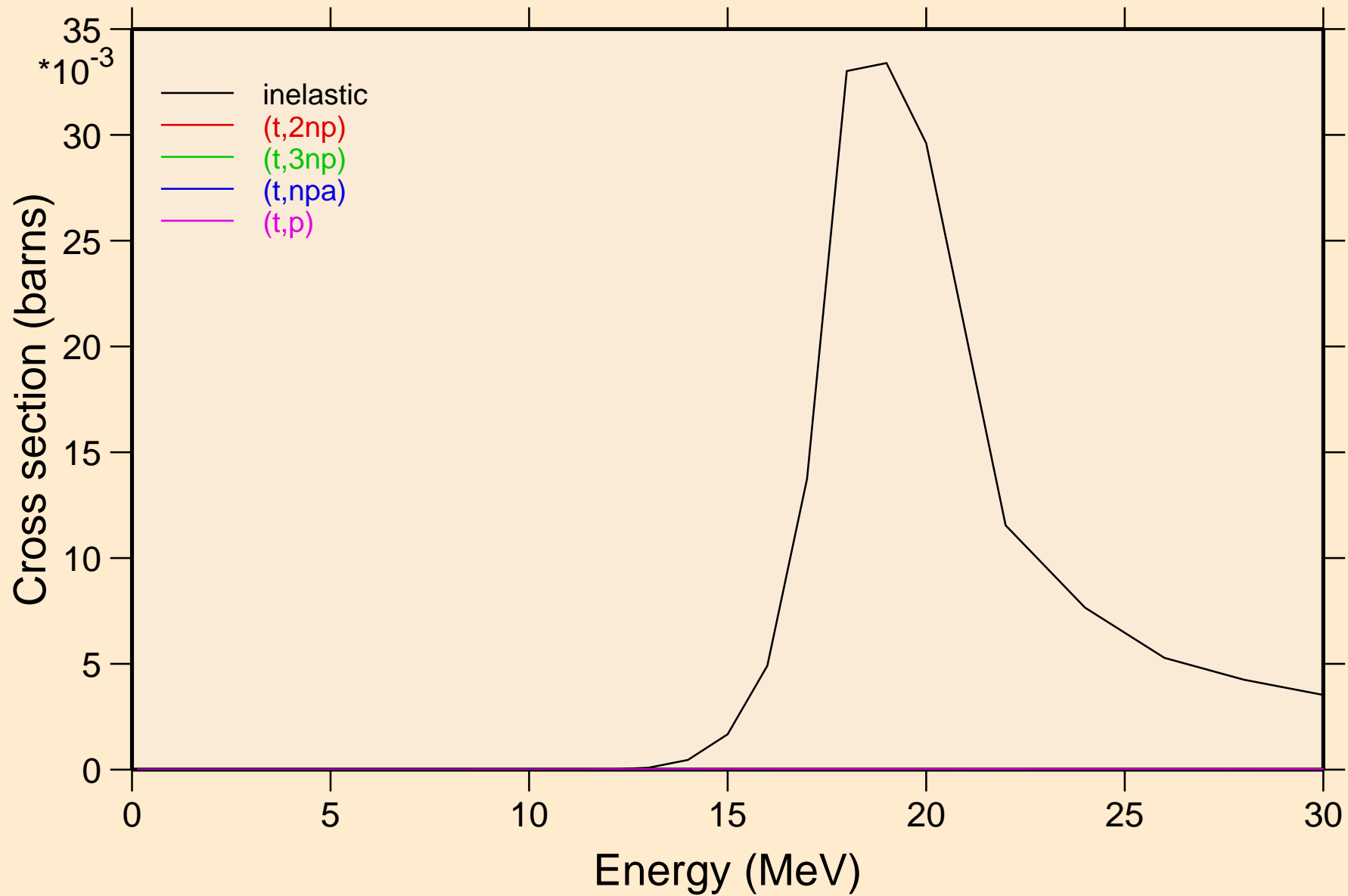



LR259 TRITON ACER TENDL-2021 LIBRARY; T=0.K  
Threshold reactions

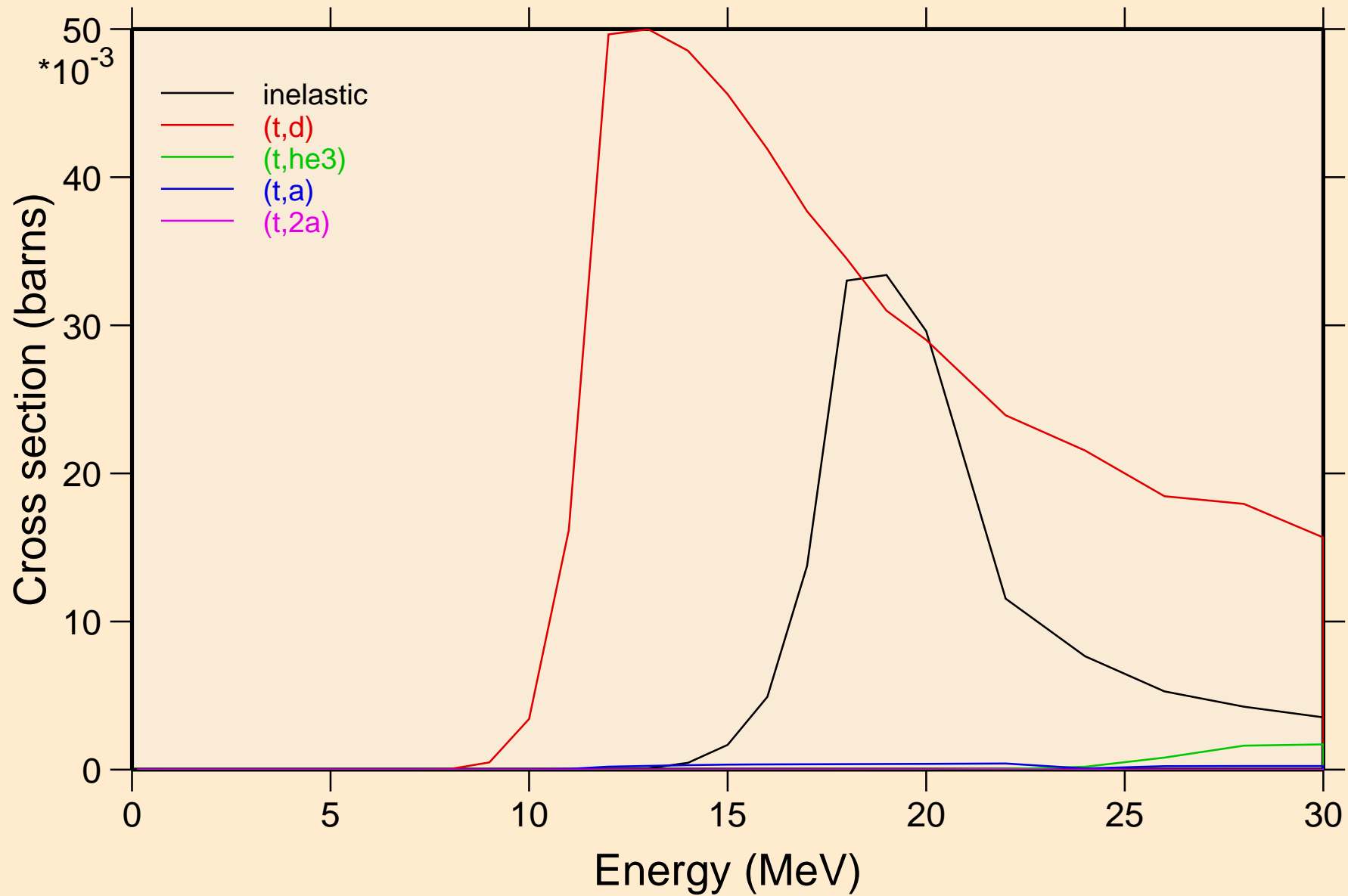

LR259 TRITON ACER TENDL-2021 LIBRARY; T=0.K  
Threshold reactions

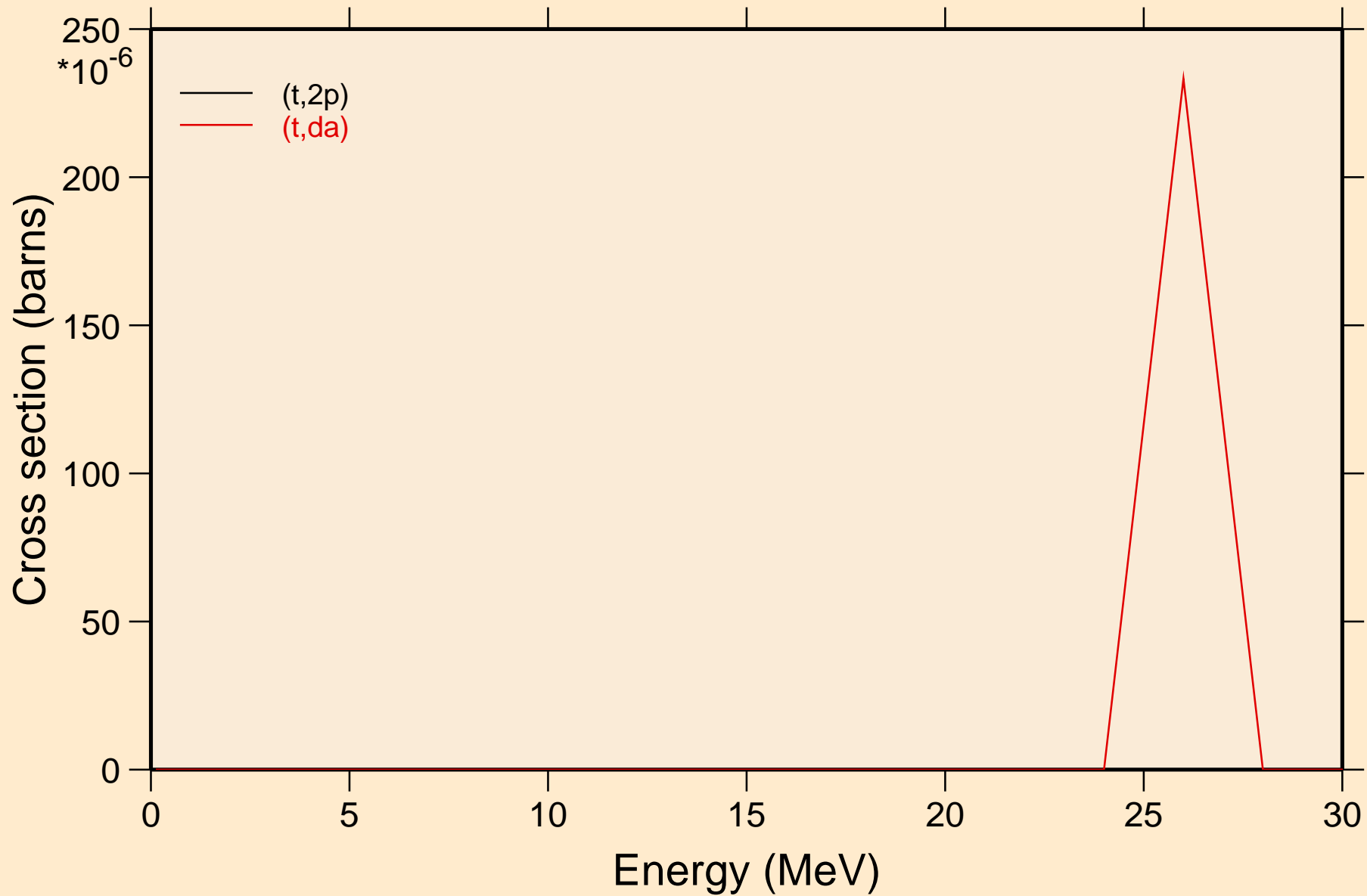

LR259 TRITON ACER TENDL-2021 LIBRARY; T=0.K  
angular distribution for elastic

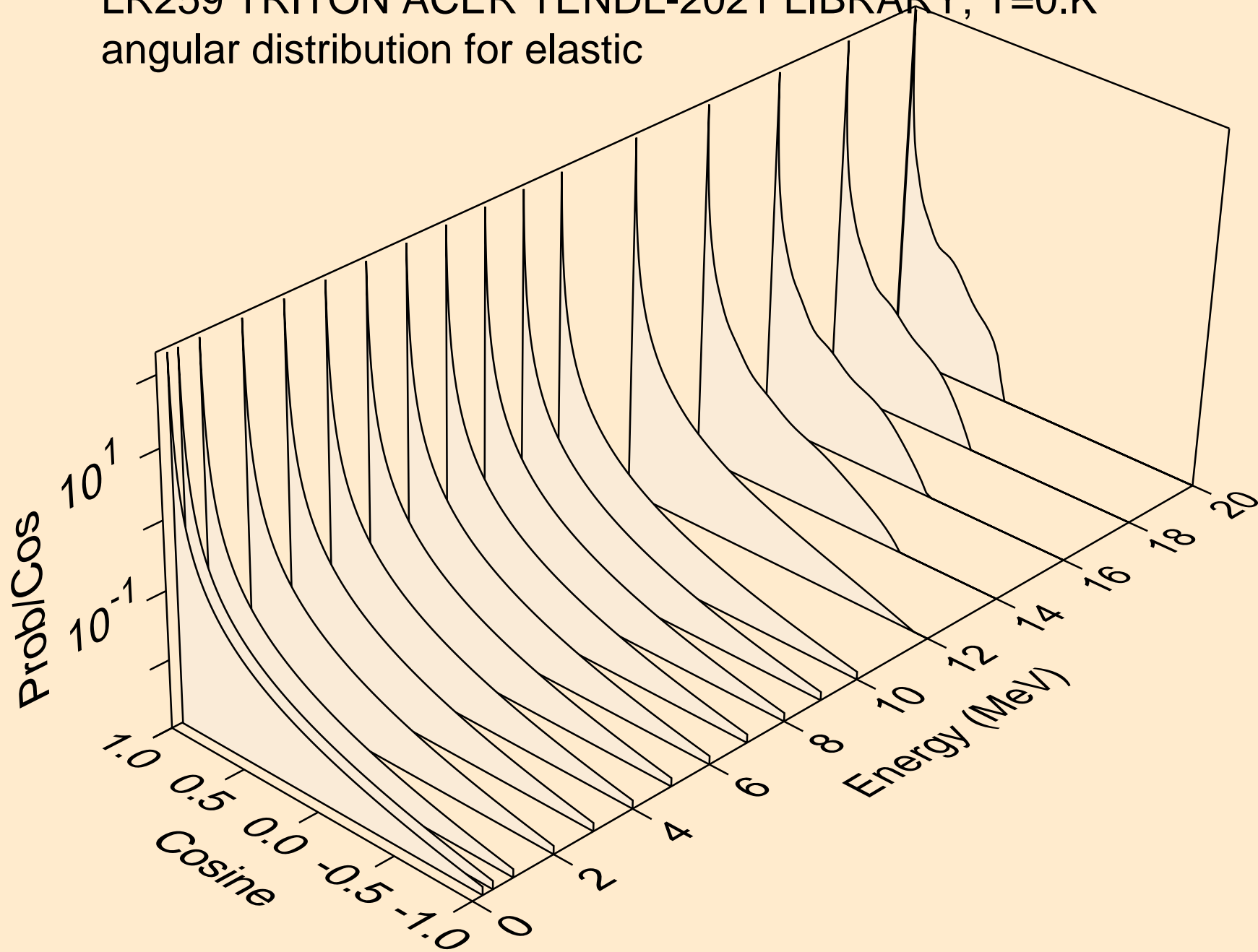

LR259 TRITON ACER TENDL-2021 LIBRARY; T=0.K  
angular distribution for elastic

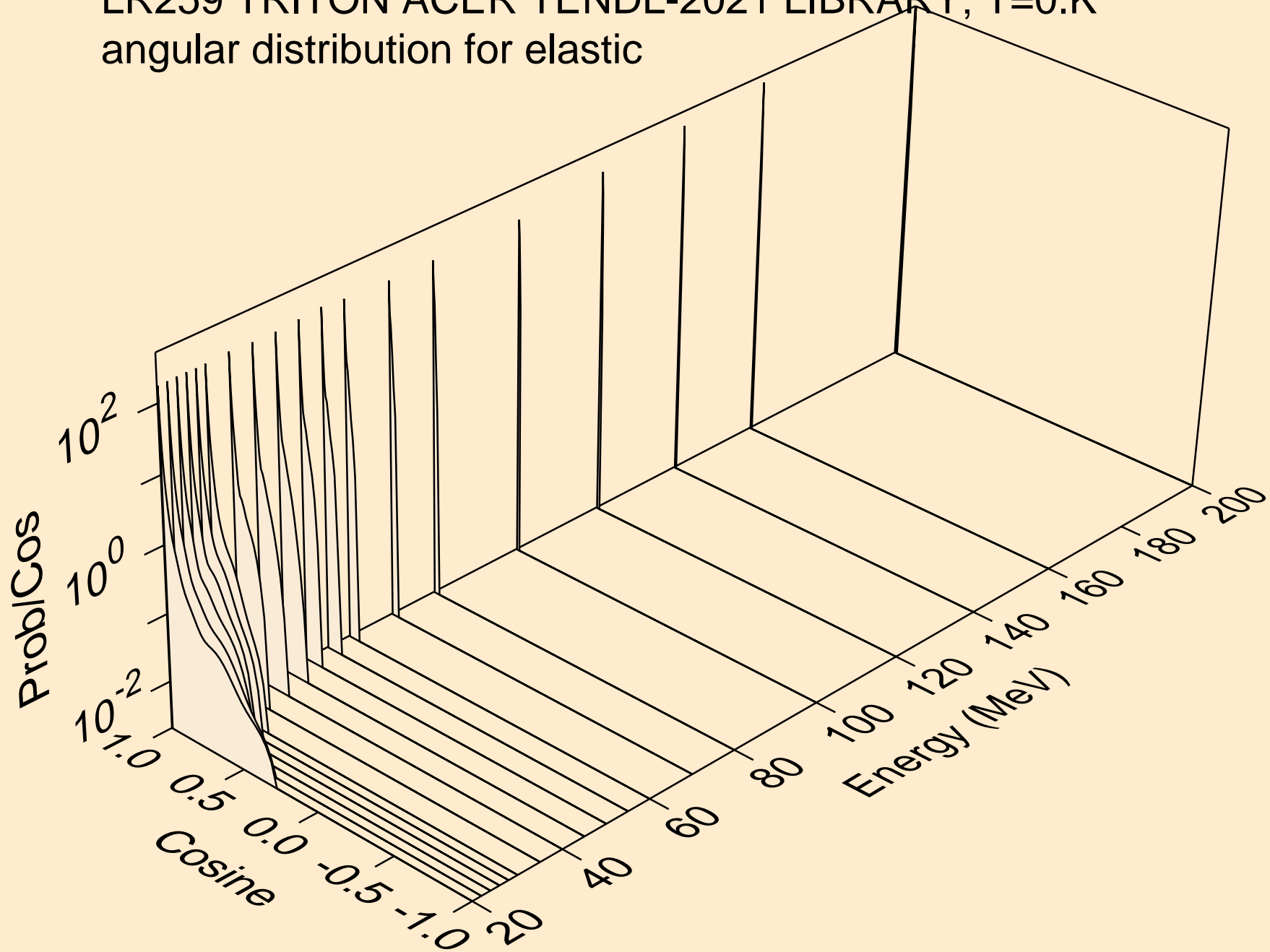

LR259 TRITON ACER TENDL-2021 LIBRARY; T=0.K  
Triton emission for (t,x)

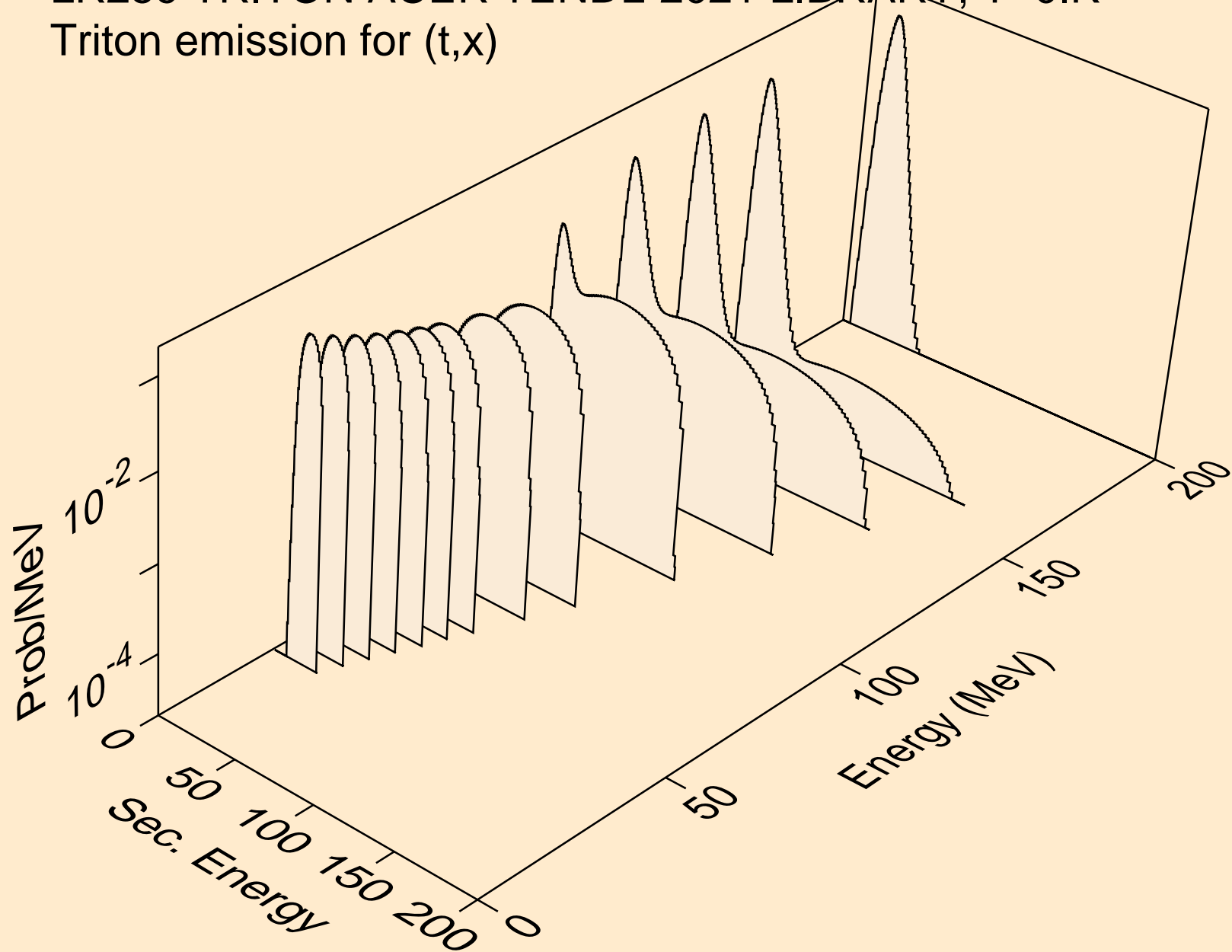

LR259 TRITON ACER TENDL-2021 LIBRARY; T=0.K  
Triton emission for (t,n\*)t

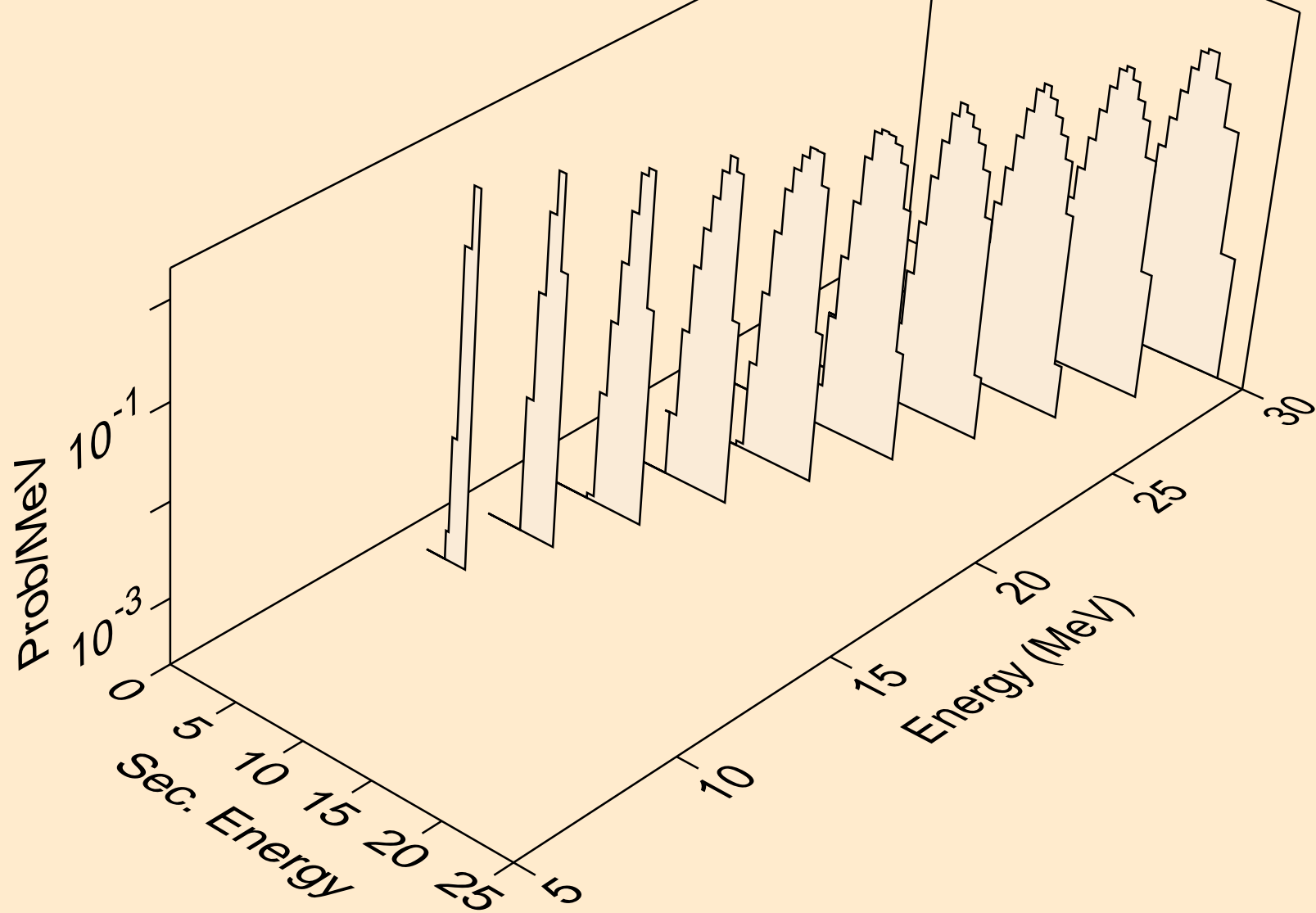

LR259 TRITON ACER TENDL-2021 LIBRARY; T=0.K  
Triton emission for inelastic

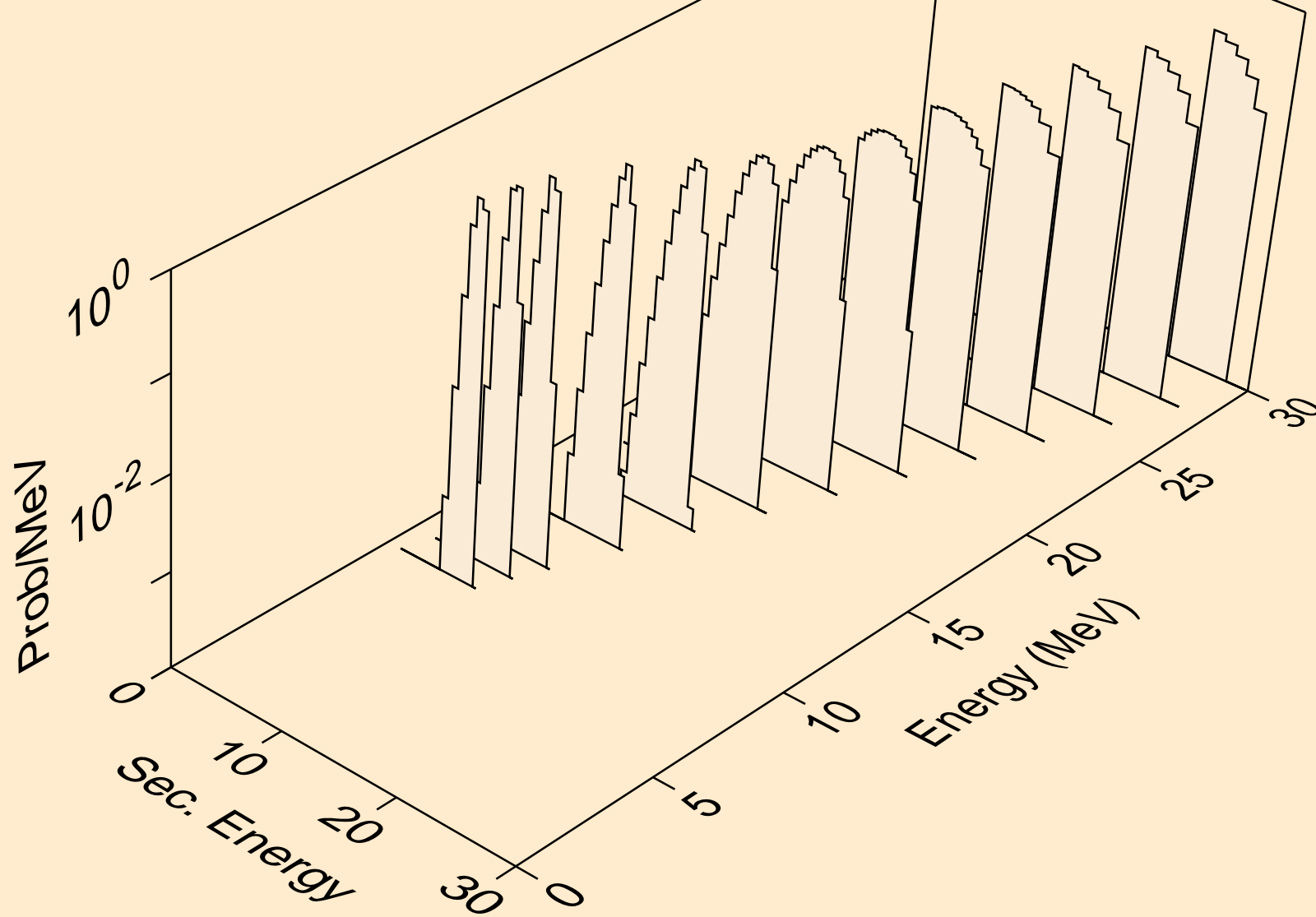

LR259 TRITON ACER TENDL-2021 LIBRARY; T=0.K  
Photon emission for (z,n)

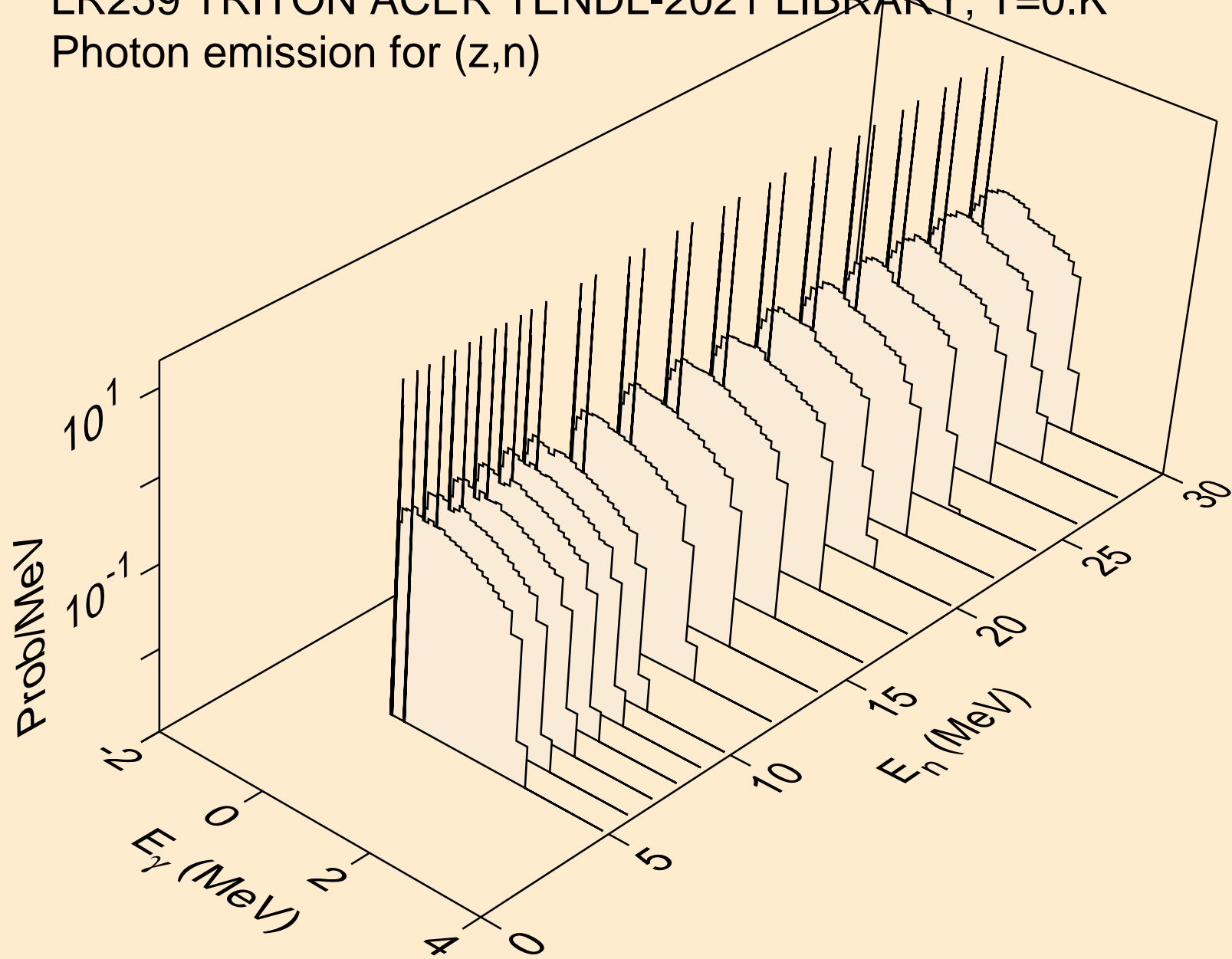



LR259 TRITON ACER TENDL-2021 LIBRARY; T=0.K  
Photon emission for (n,x)

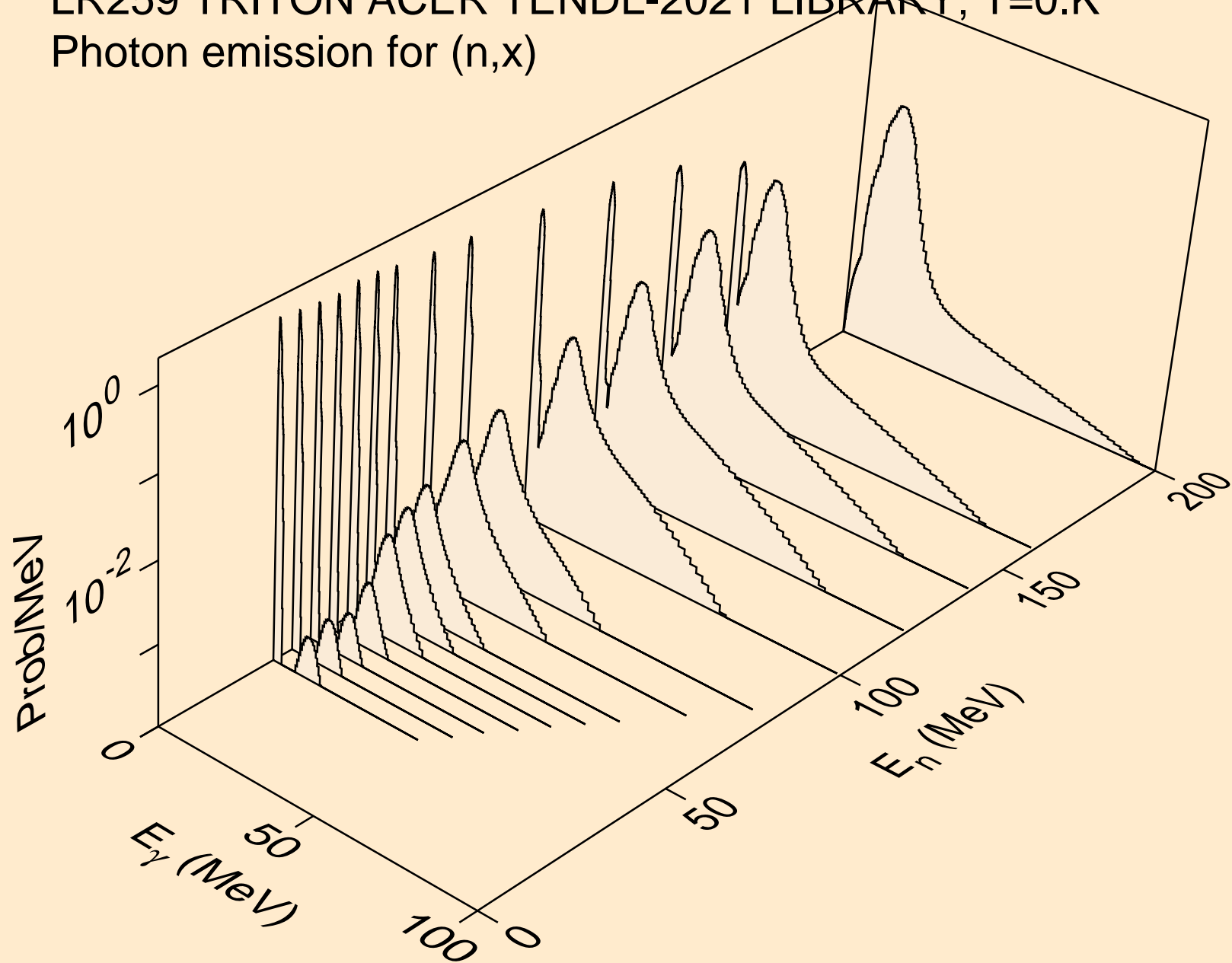

LR259 TRITON ACER TENDL-2021 LIBRARY; T=0.K  
Photon emission for (n,2n)

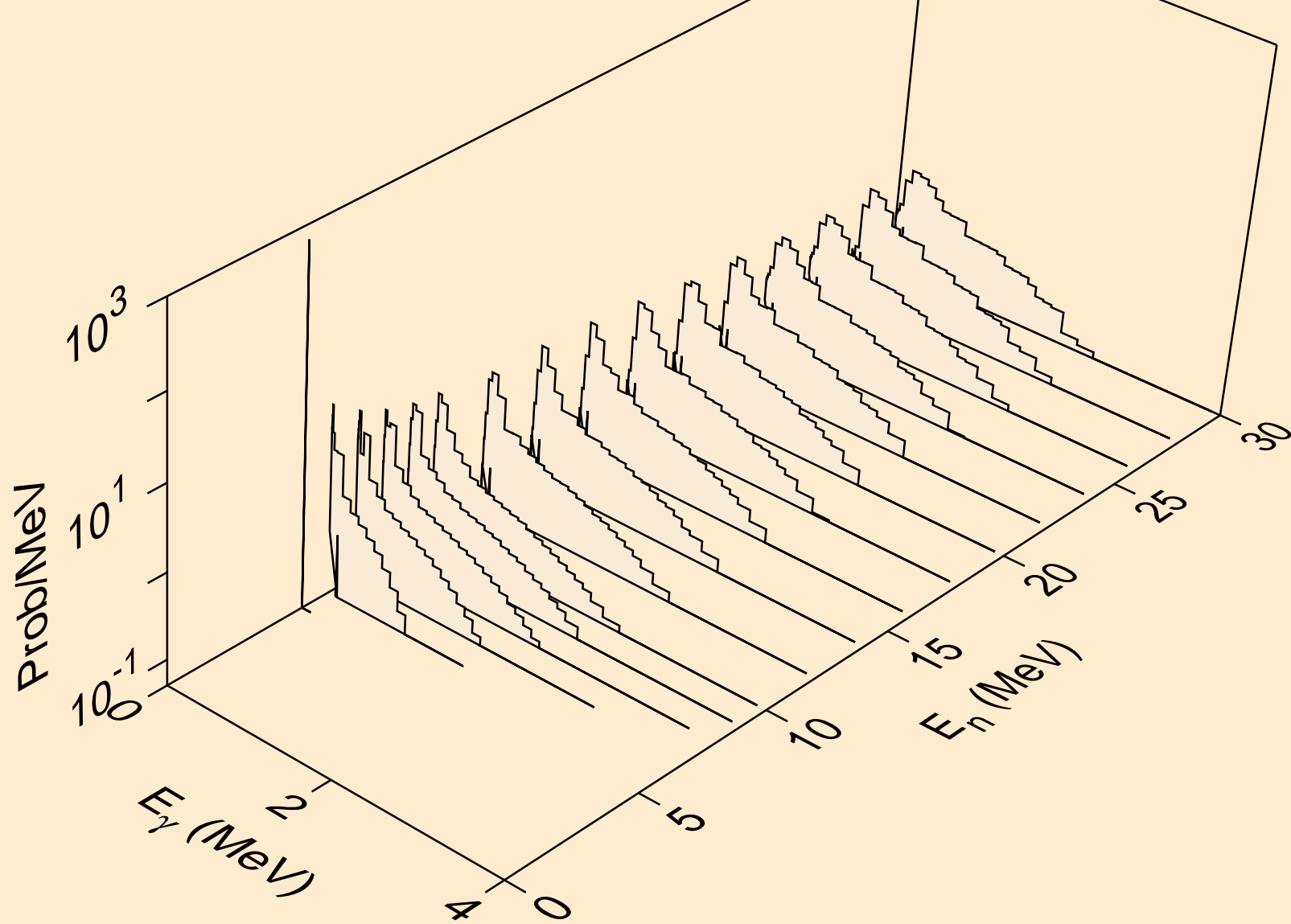

LR259 TRITON ACER TENDL-2021 LIBRARY; T=0.K  
Photon emission for (n,3n)

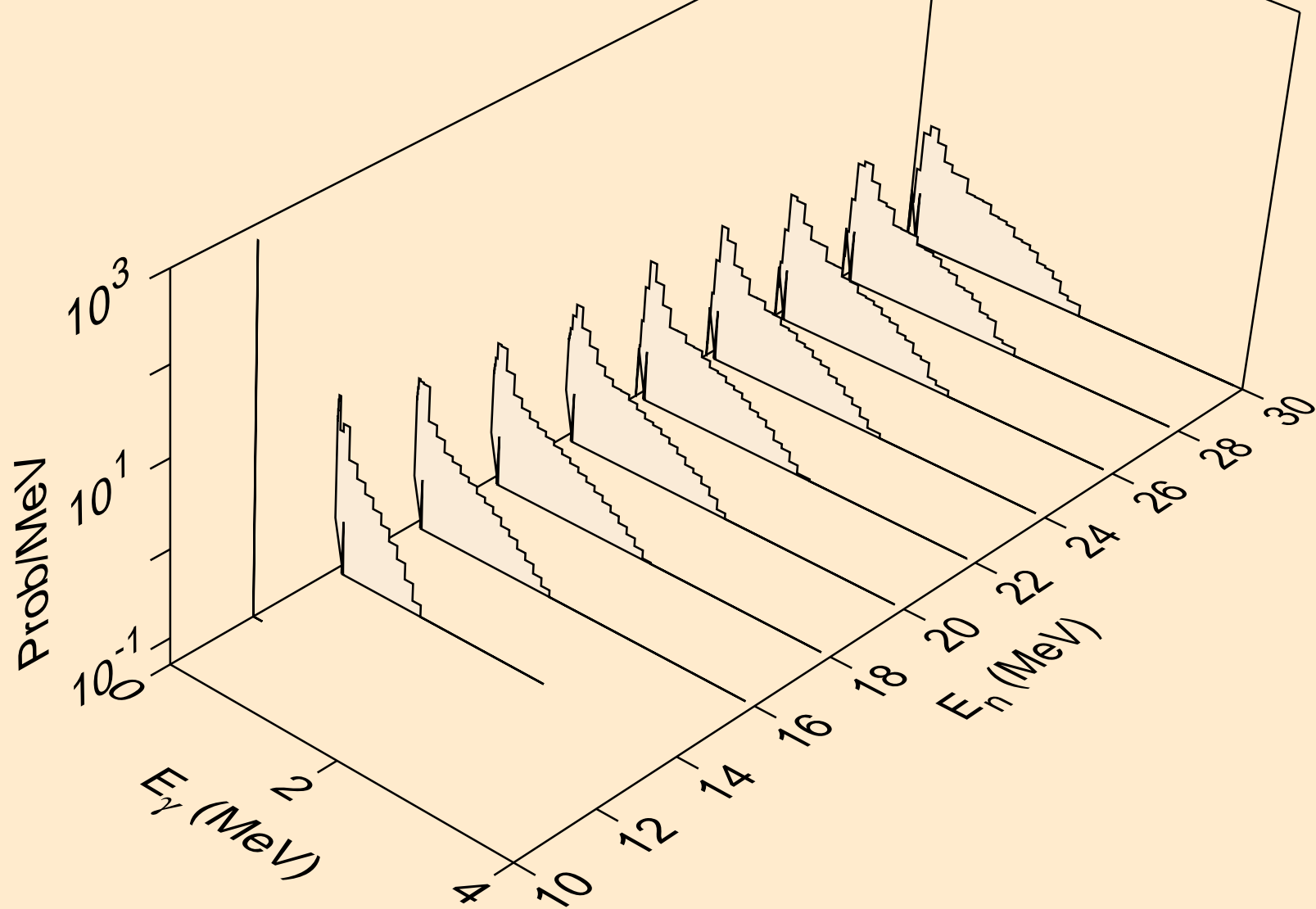

LR259 TRITON ACER TENDL-2021 LIBRARY; T=0.K  
Photon emission for (n,n\*)a

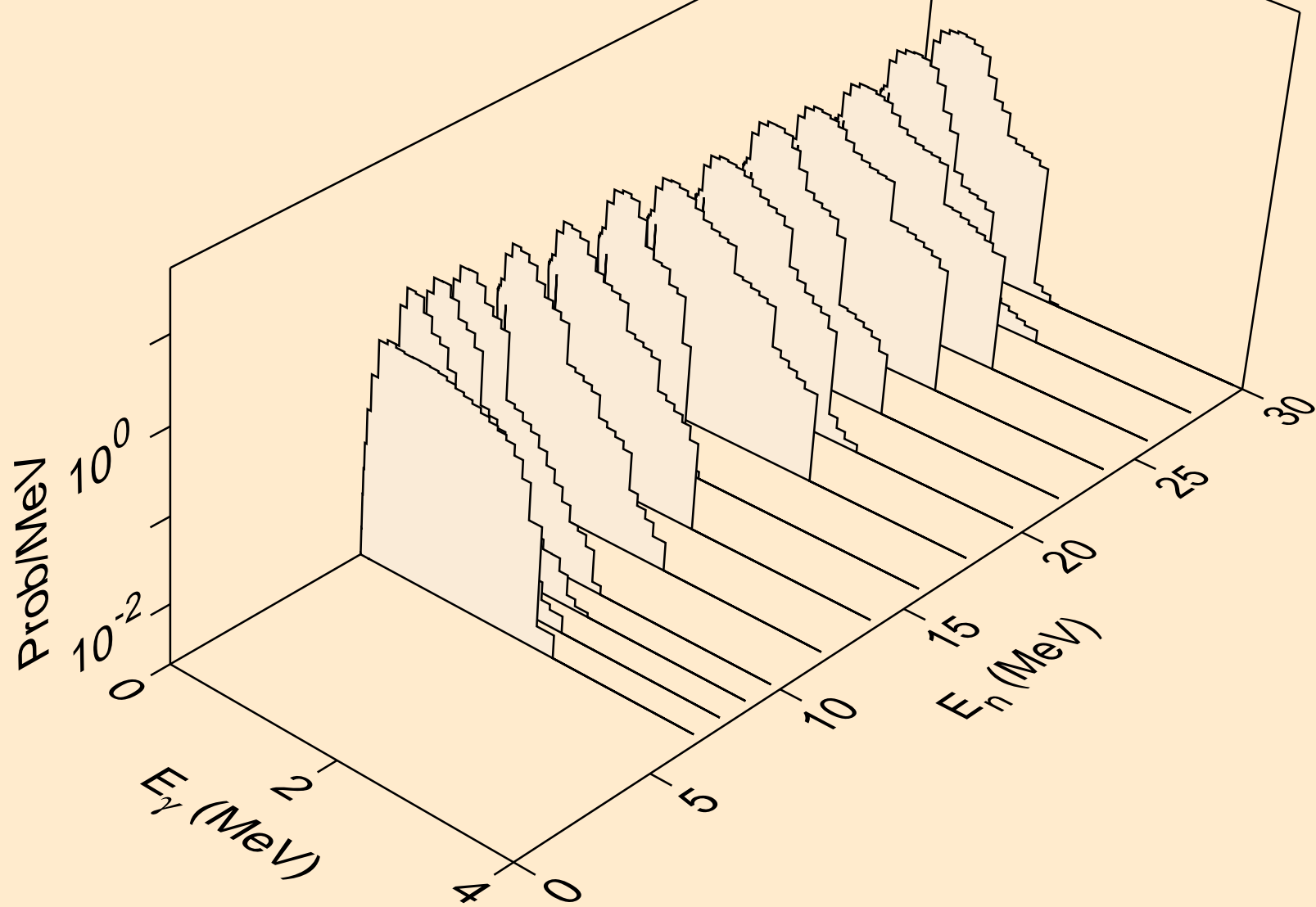

LR259 TRITON ACER TENDL-2021 LIBRARY; T=0.K  
Photon emission for (n,3n)a

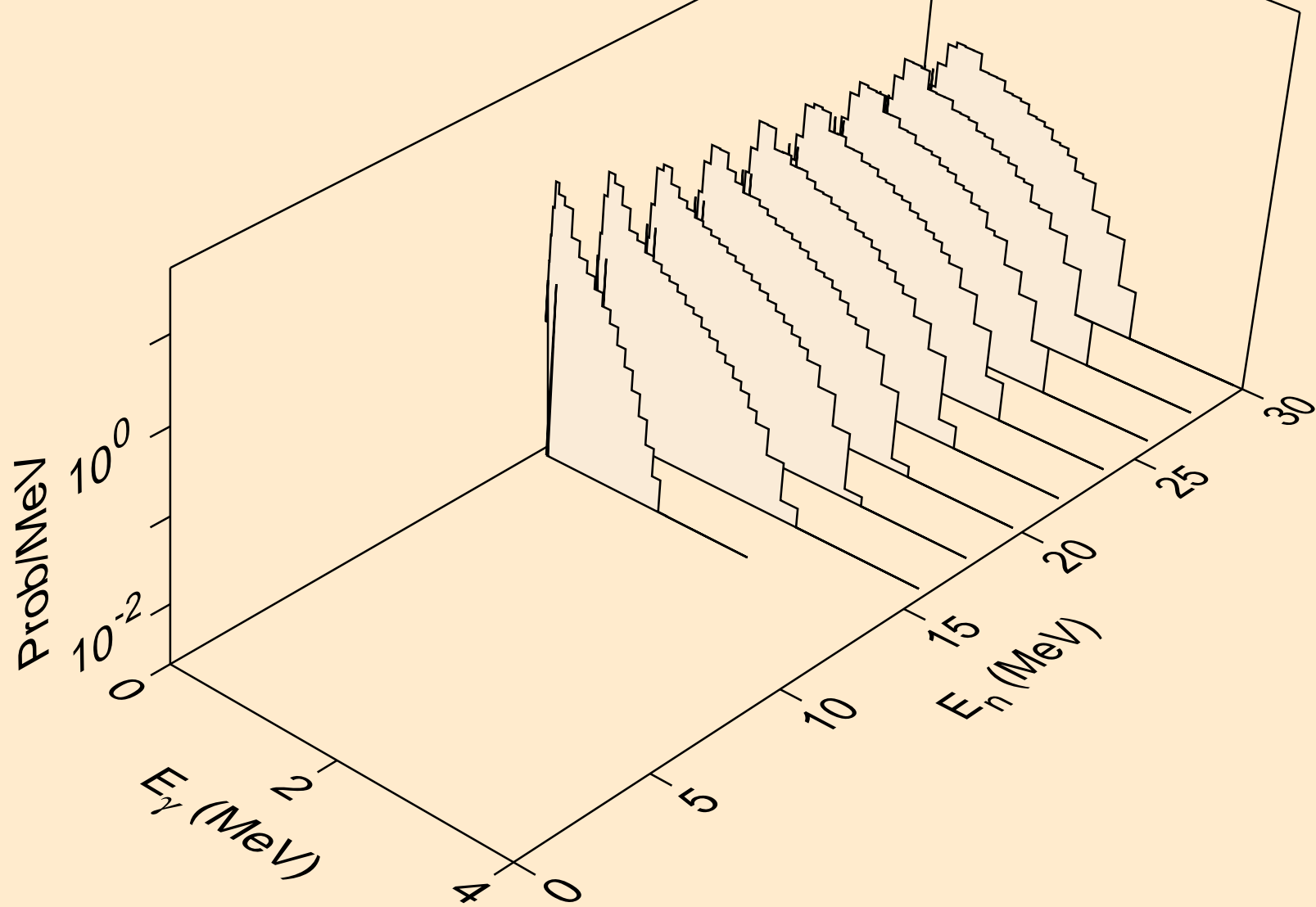

LR259 TRITON ACER TENDL-2021 LIBRARY; T=0.K  
Photon emission for (n,n\*)p

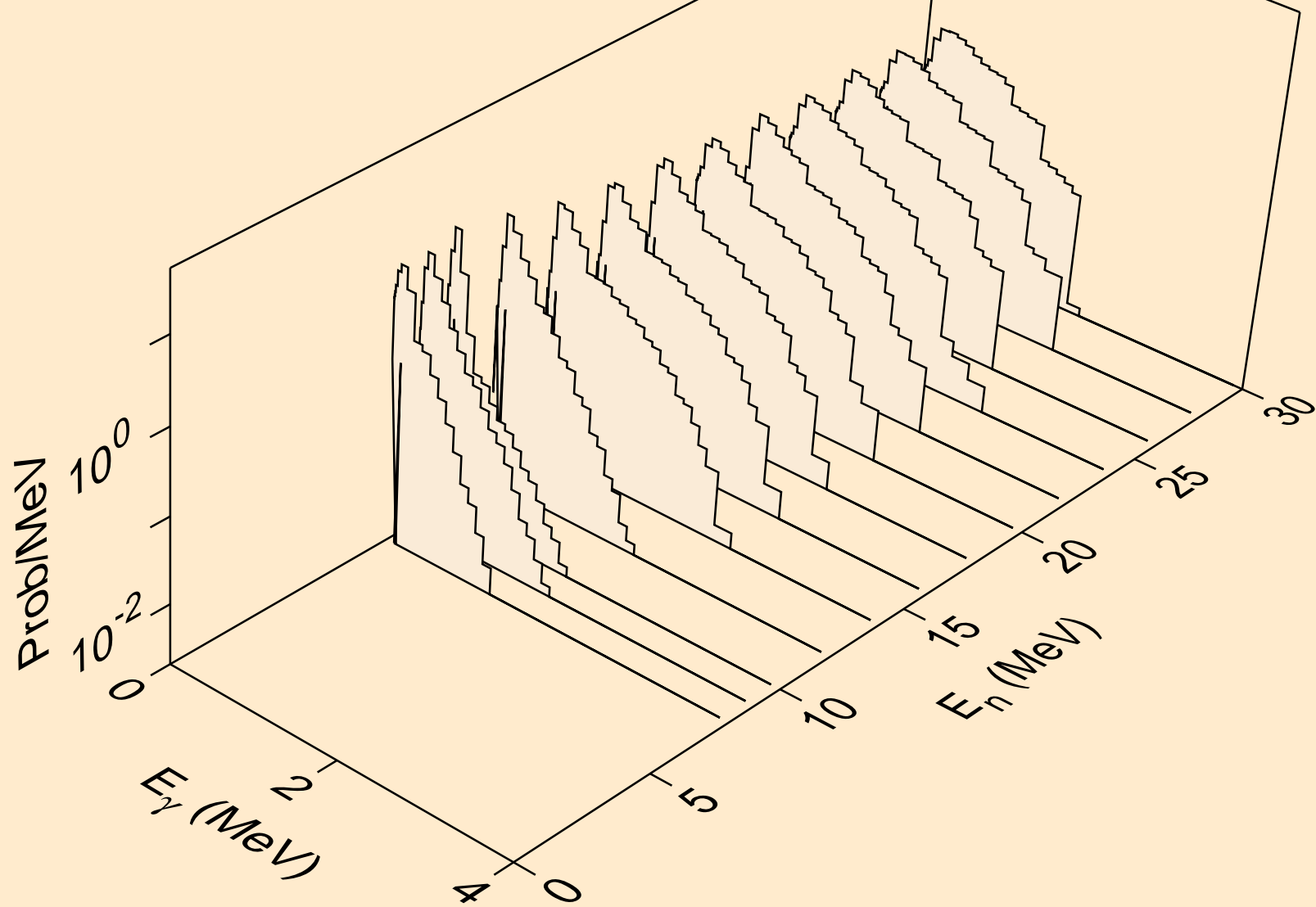

LR259 TRITON ACER TENDL-2021 LIBRARY; T=0.K  
Photon emission for (n,n\*)d

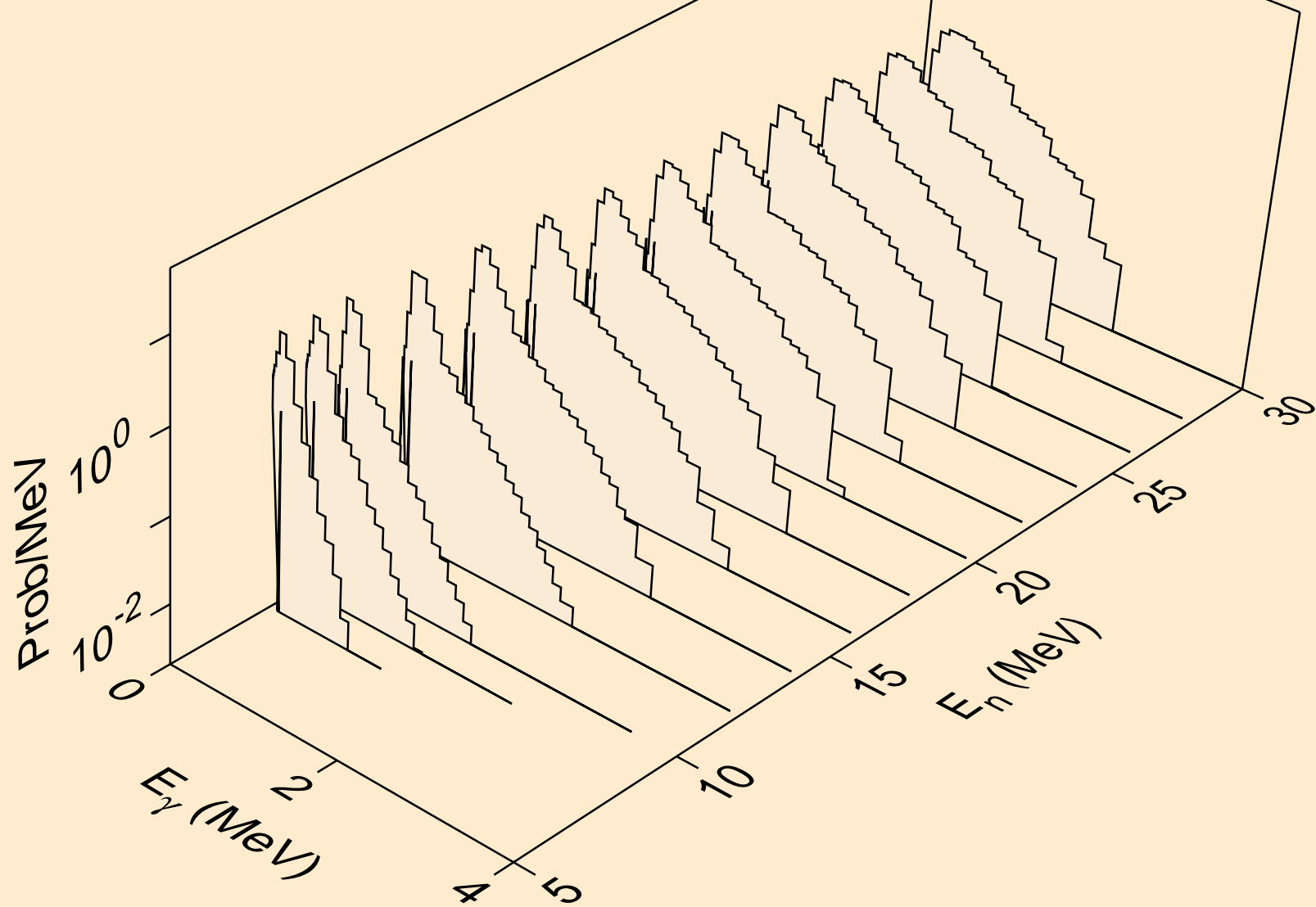

LR259 TRITON ACER TENDL-2021 LIBRARY; T=0.K  
Photon emission for (n,n\*)t

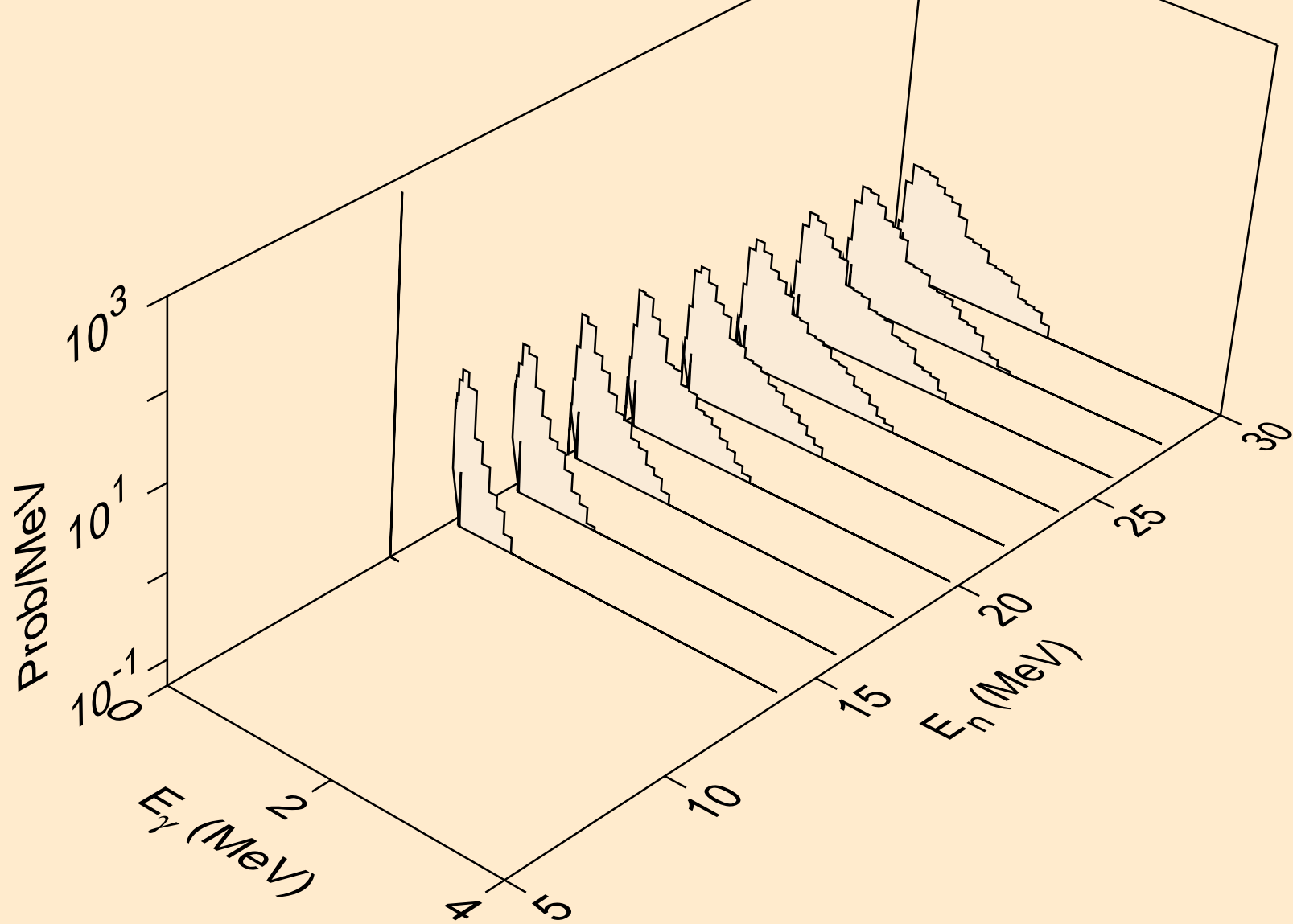



LR259 TRITON ACER TENDL-2021 LIBRARY; T=0.K  
Photon emission for (n,n\*)he3

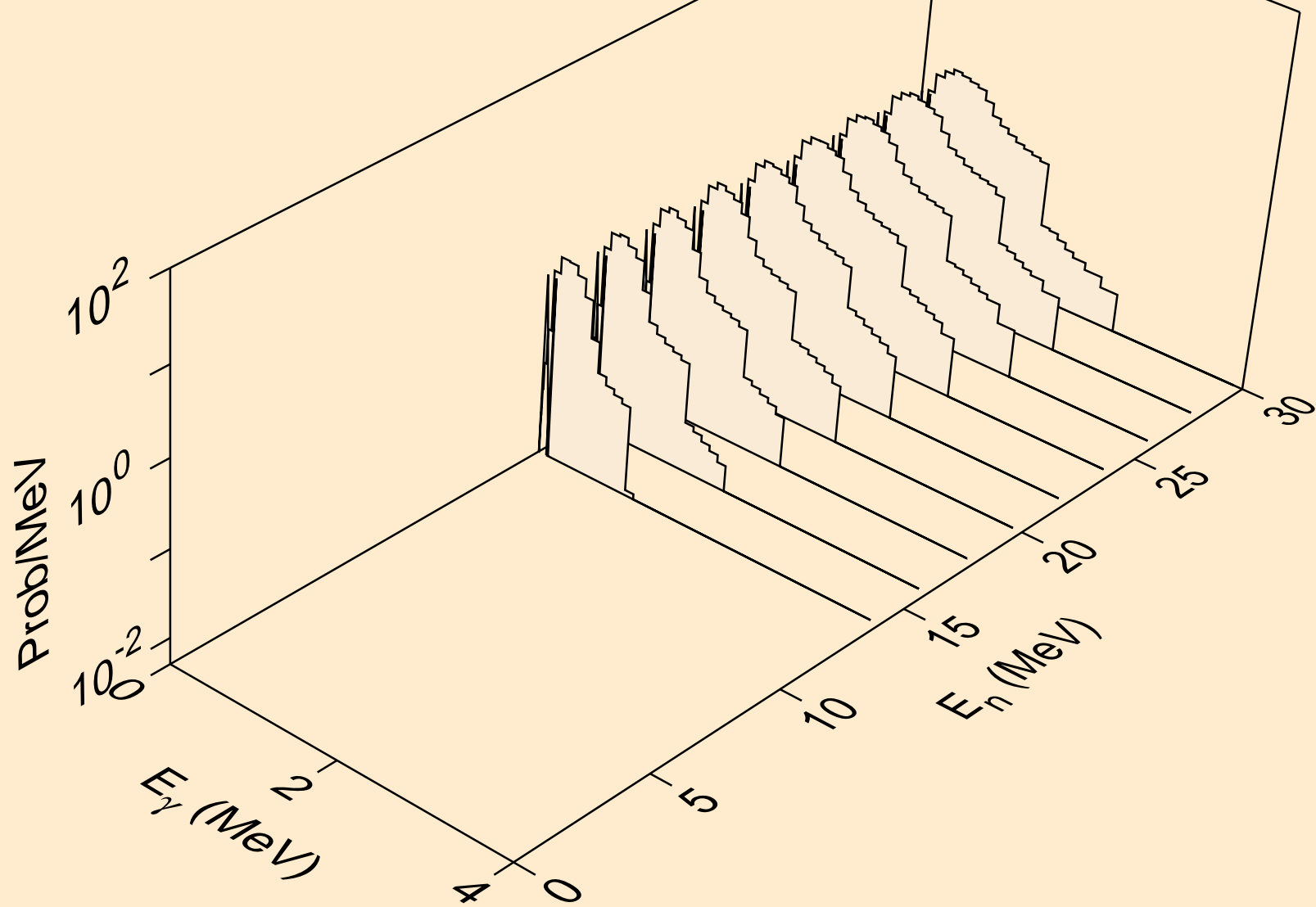

LR259 TRITON ACER TENDL-2021 LIBRARY; T=0.K  
Photon emission for (n,4n)

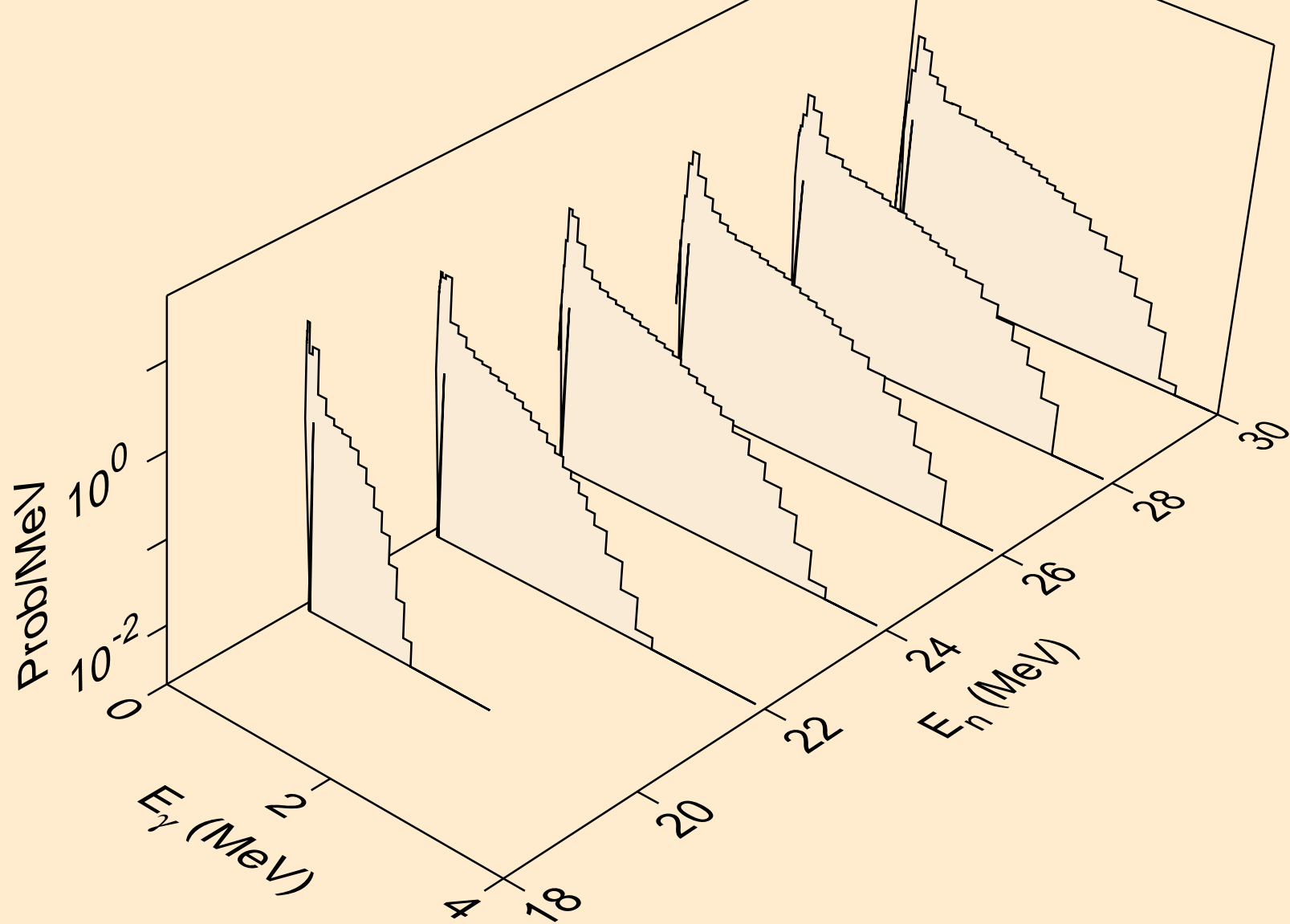

LR259 TRITON ACER TENDL-2021 LIBRARY; T=0.K  
Photon emission for (n,2np)

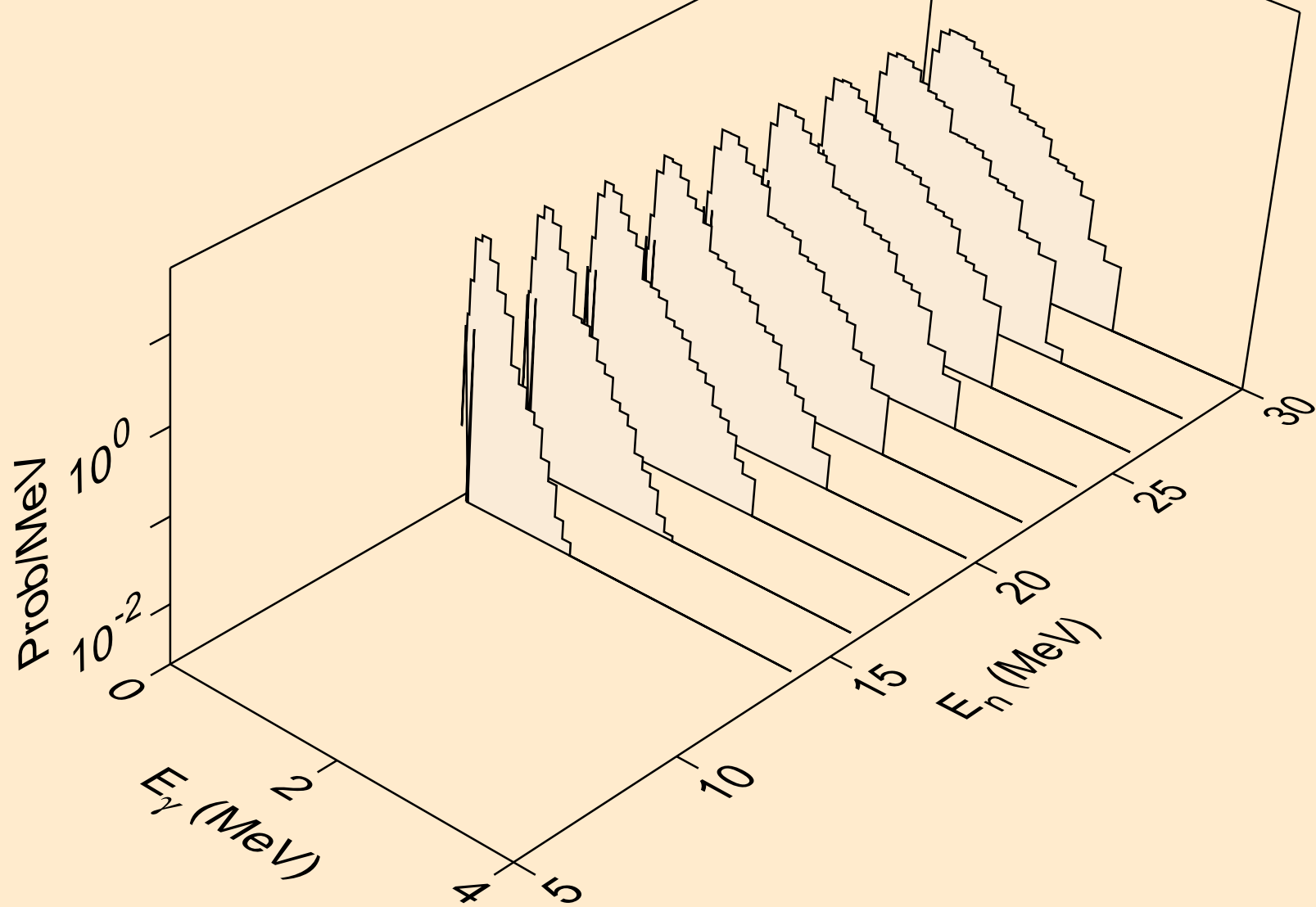

LR259 TRITON ACER TENDL-2021 LIBRARY; T=0.K  
Photon emission for (n,3np)

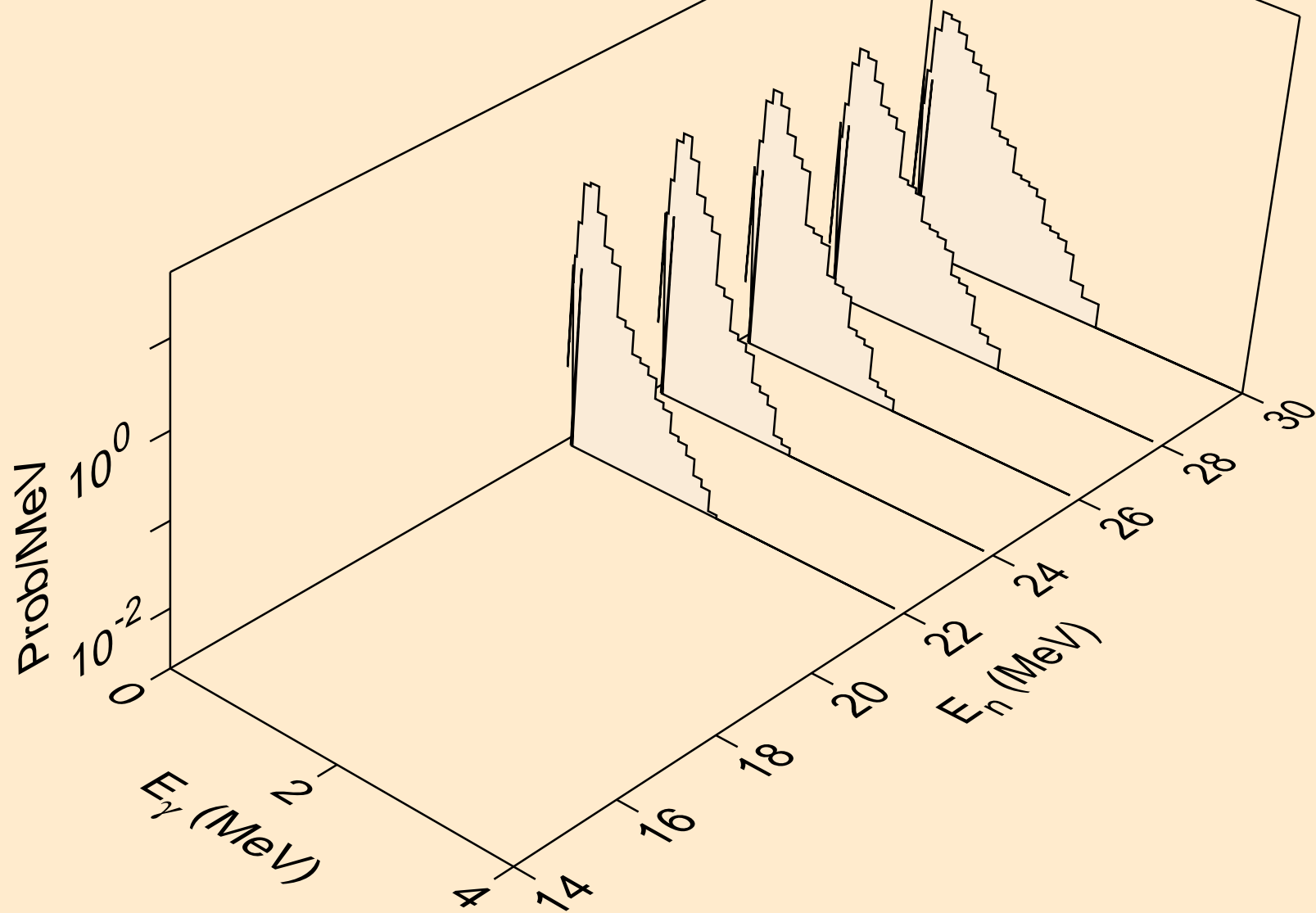

LR259 TRITON ACER TENDL-2021 LIBRARY; T=0.K  
Photon emission for (n,npa)

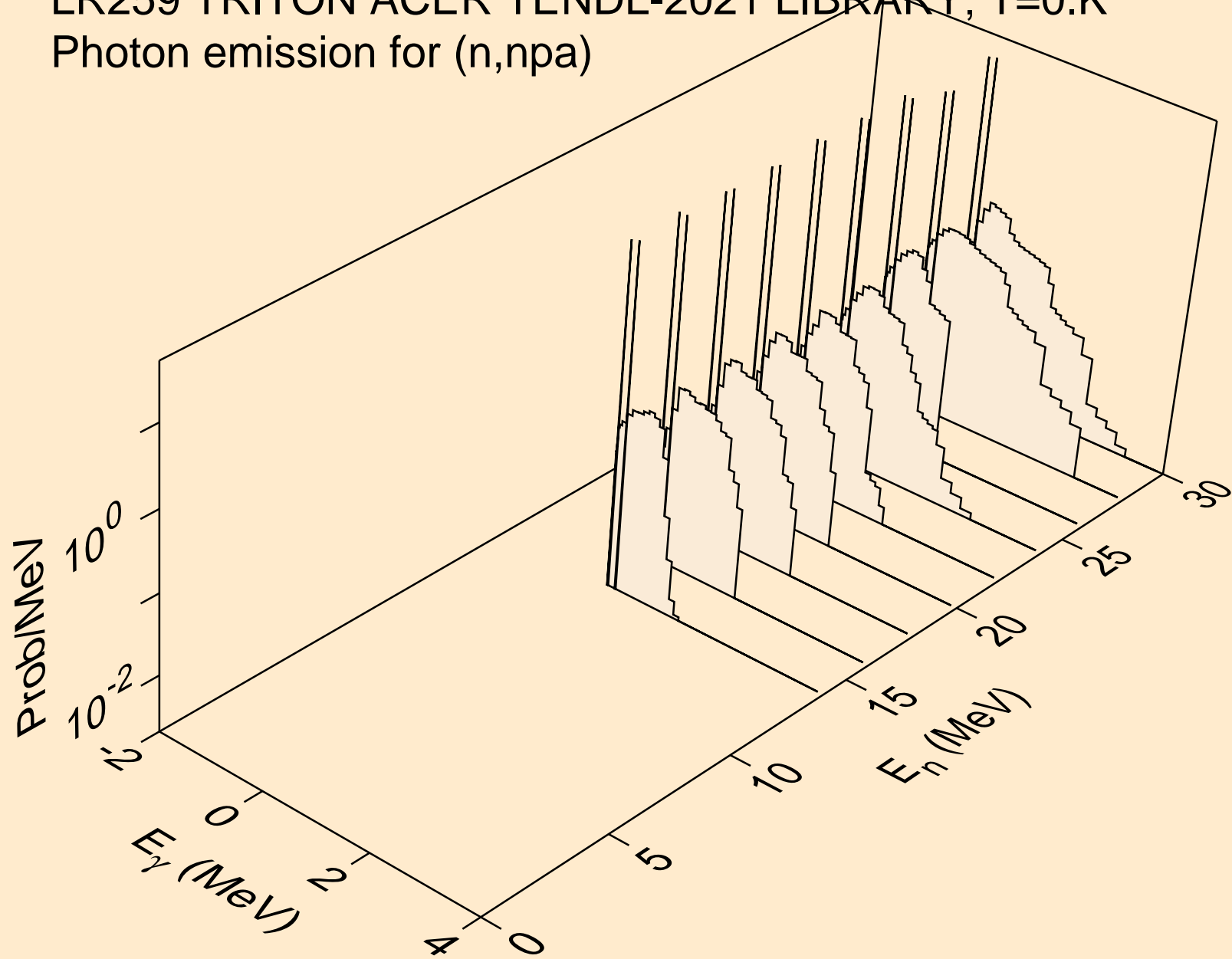

LR259 TRITON ACER TENDL-2021 LIBRARY; T=0.K  
Photon emission for (n,p)

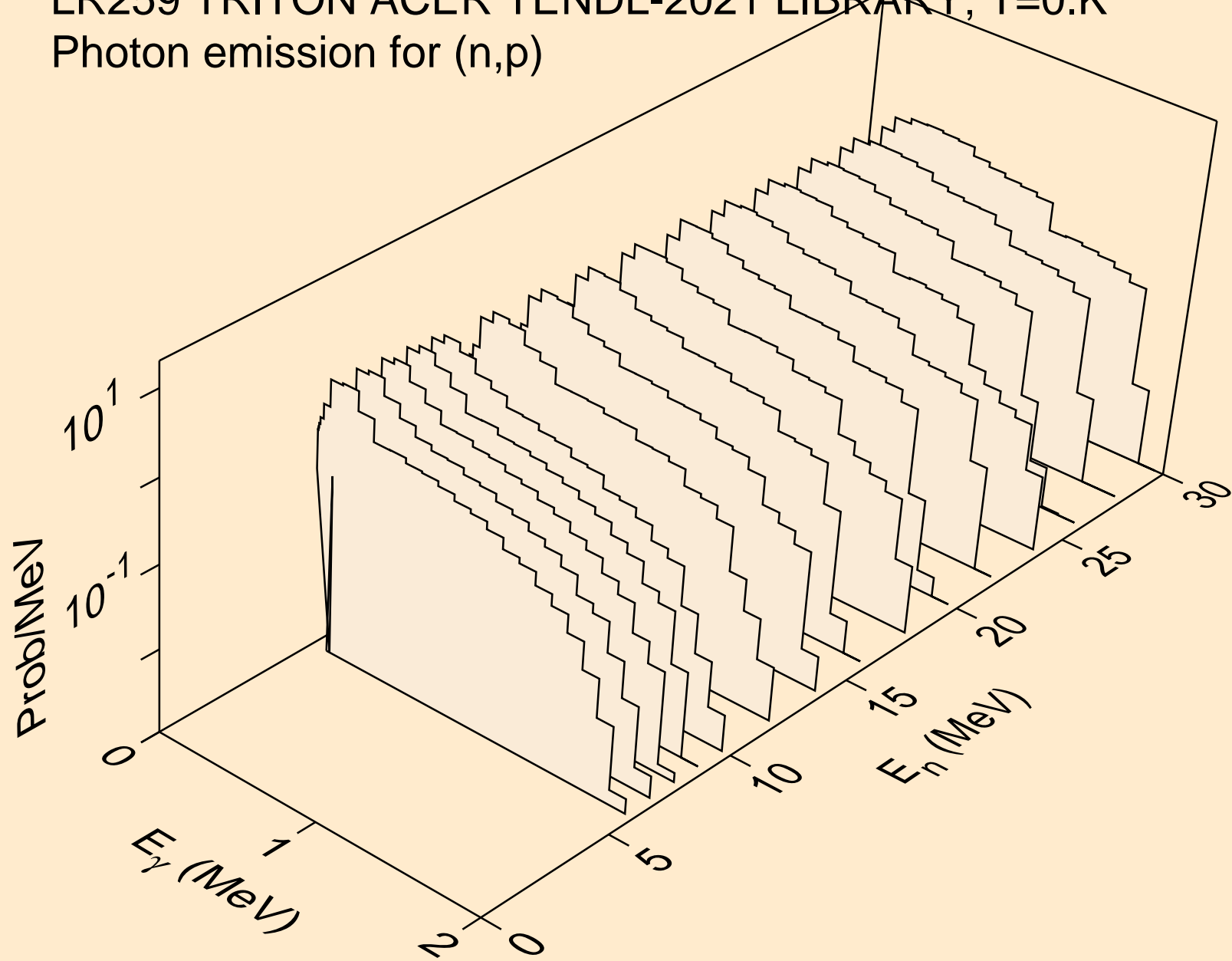

LR259 TRITON ACER TENDL-2021 LIBRARY; T=0.K  
Photon emission for (n,d)

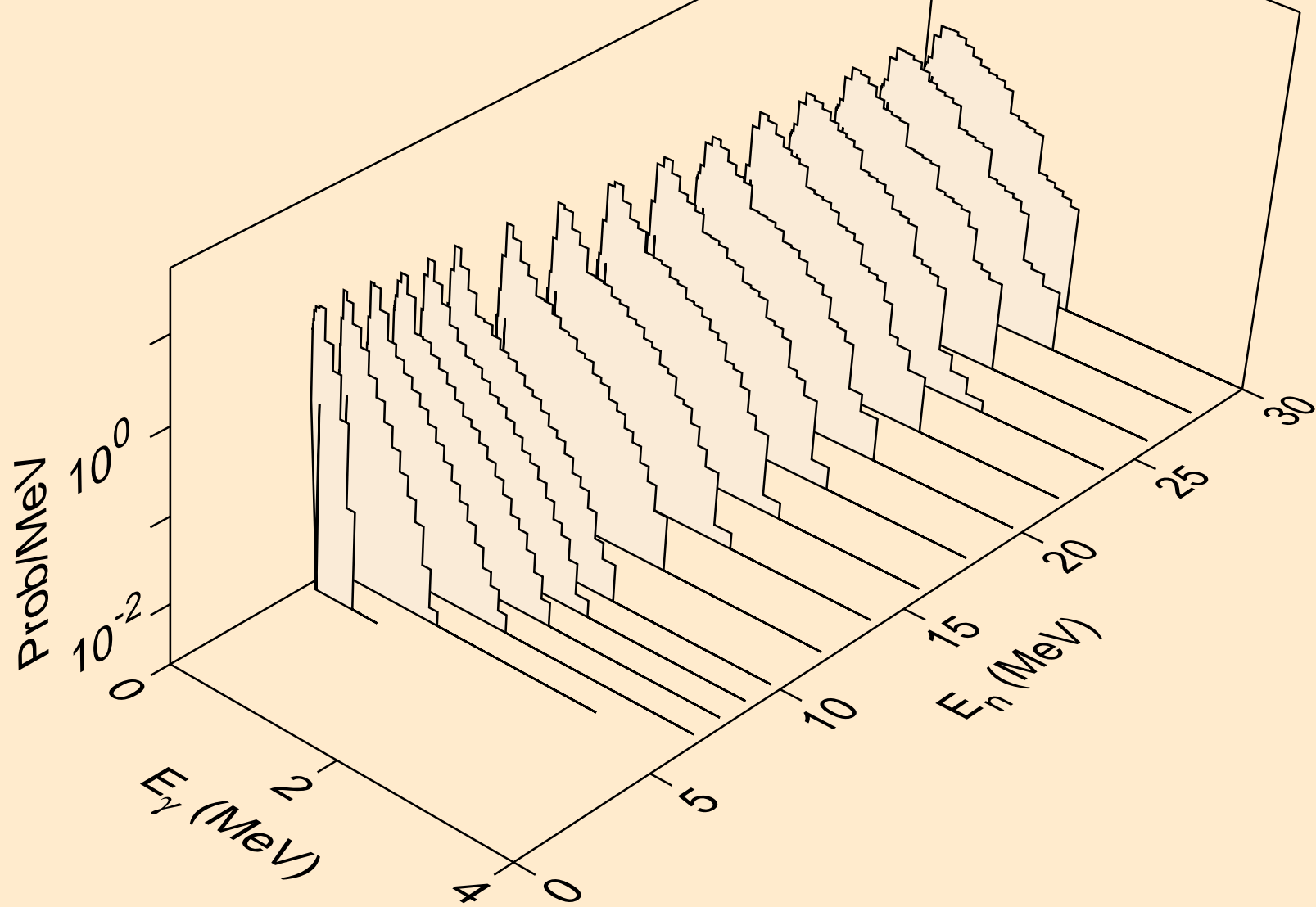

LR259 TRITON ACER TENDL-2021 LIBRARY; T=0.K  
Photon emission for inelastic

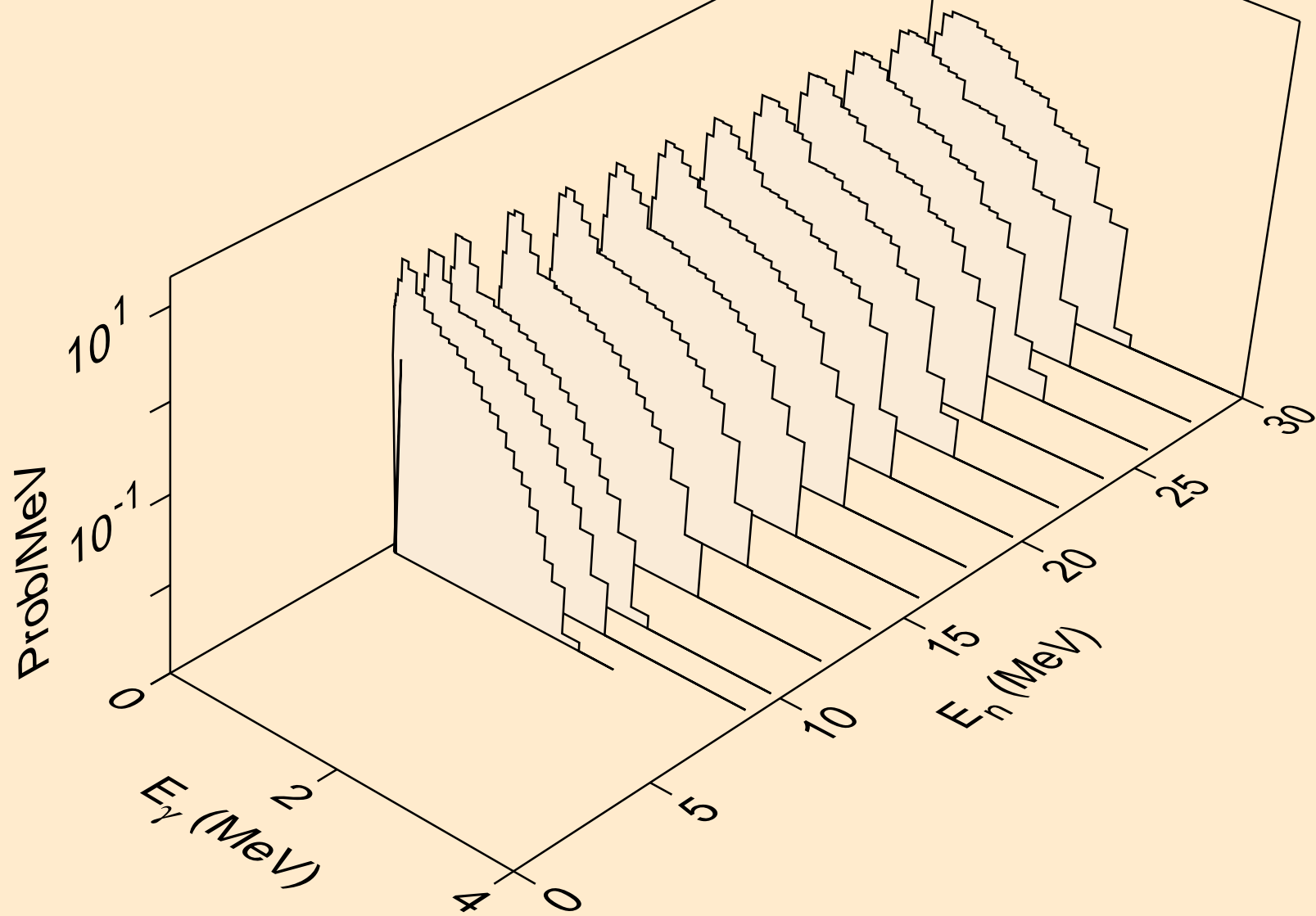



LR259 TRITON ACER TENDL-2021 LIBRARY; T=0.K  
Photon emission for (n,he3)

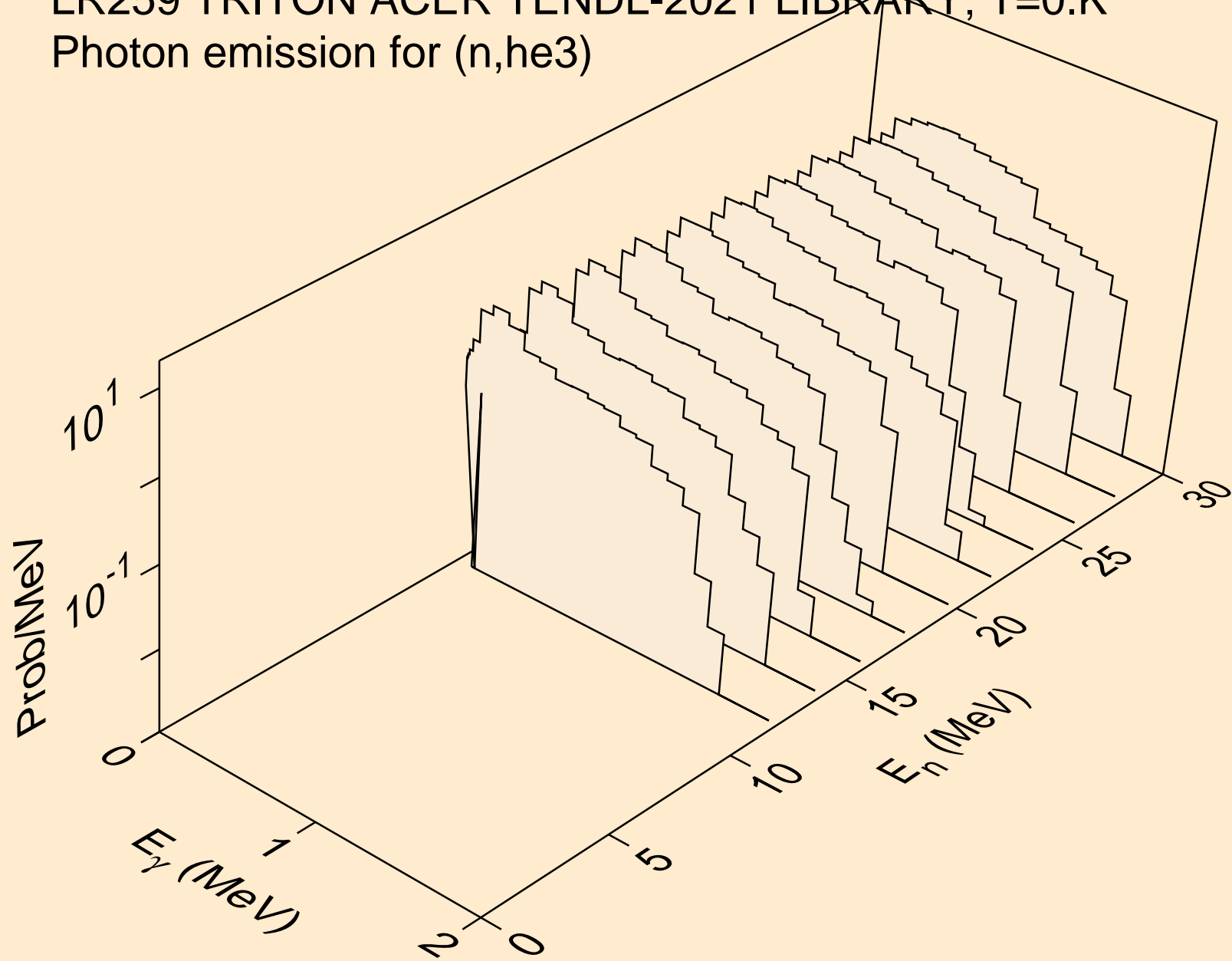

LR259 TRITON ACER TENDL-2021 LIBRARY; T=0.K  
Photon emission for (n,a)

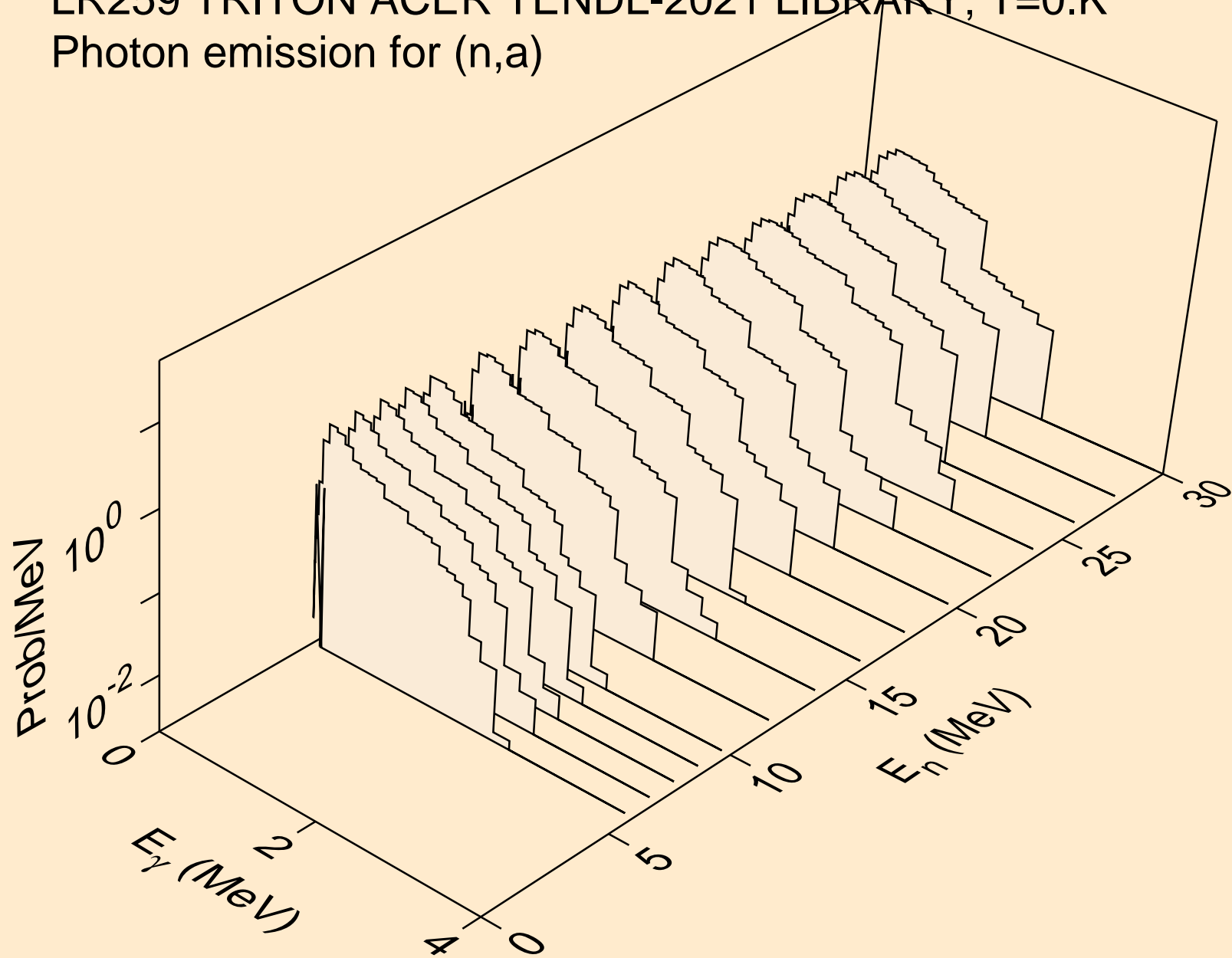

LR259 TRITON ACER TENDL-2021 LIBRARY; T=0.K  
Photon emission for (n,2a)

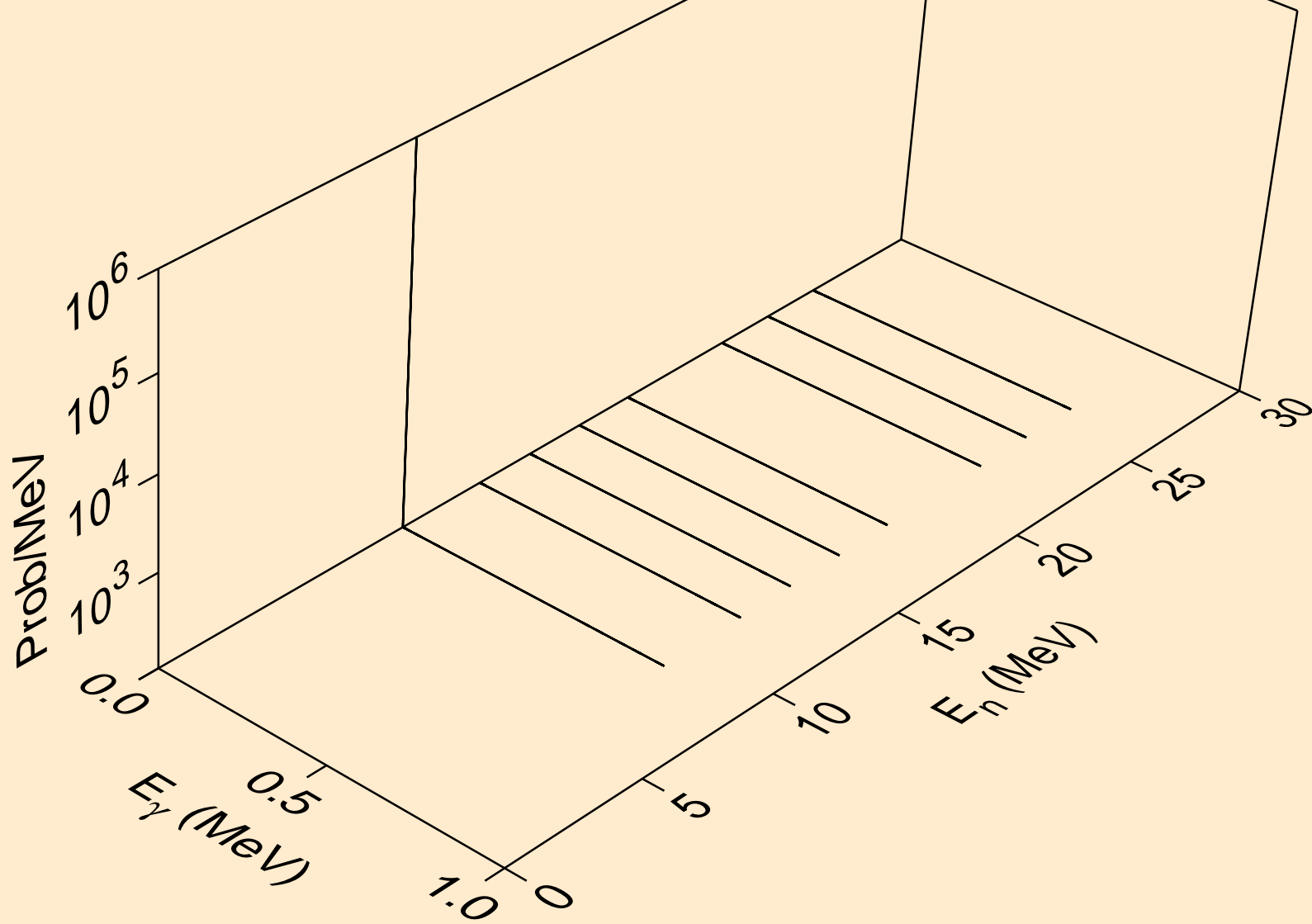

LR259 TRITON ACER TENDL-2021 LIBRARY; T=0.K  
Photon emission for (n,2p)

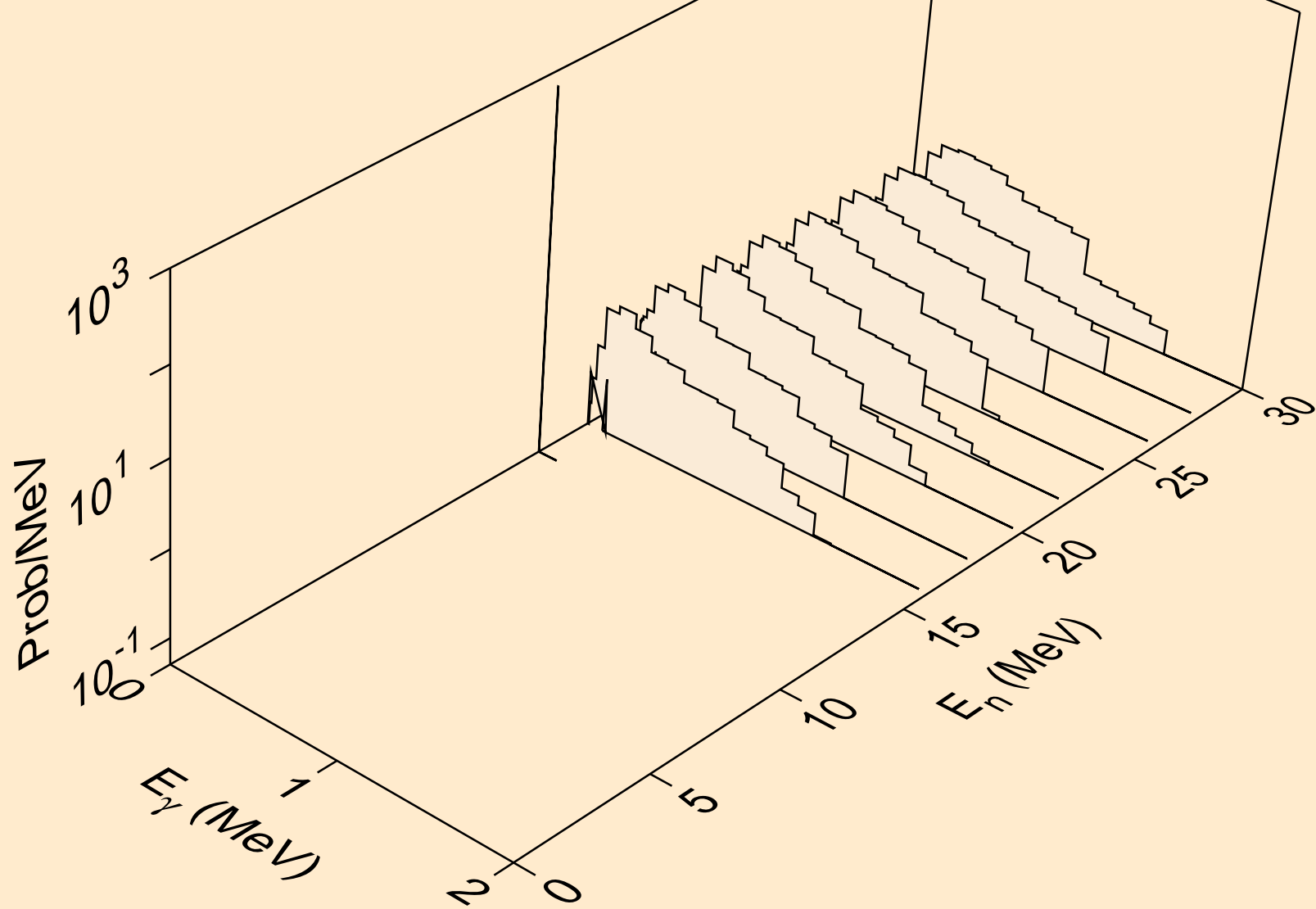

LR259 TRITON ACER TENDL-2021 LIBRARY; T=0.K  
Photon emission for (n,da)

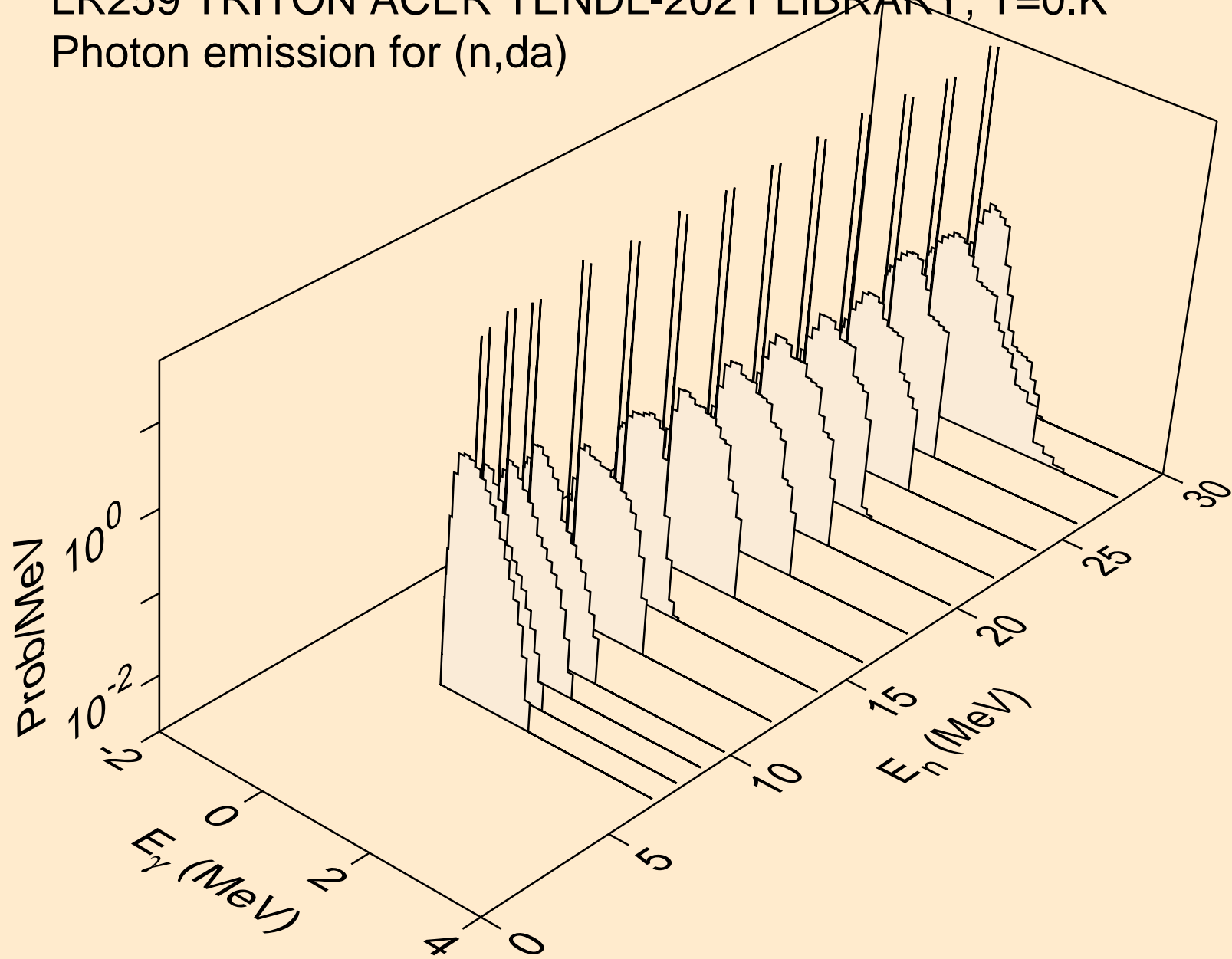

LR259 TRITON ACER TENDL-2021 LIBRARY; T=0.K  
Particle heating contributions

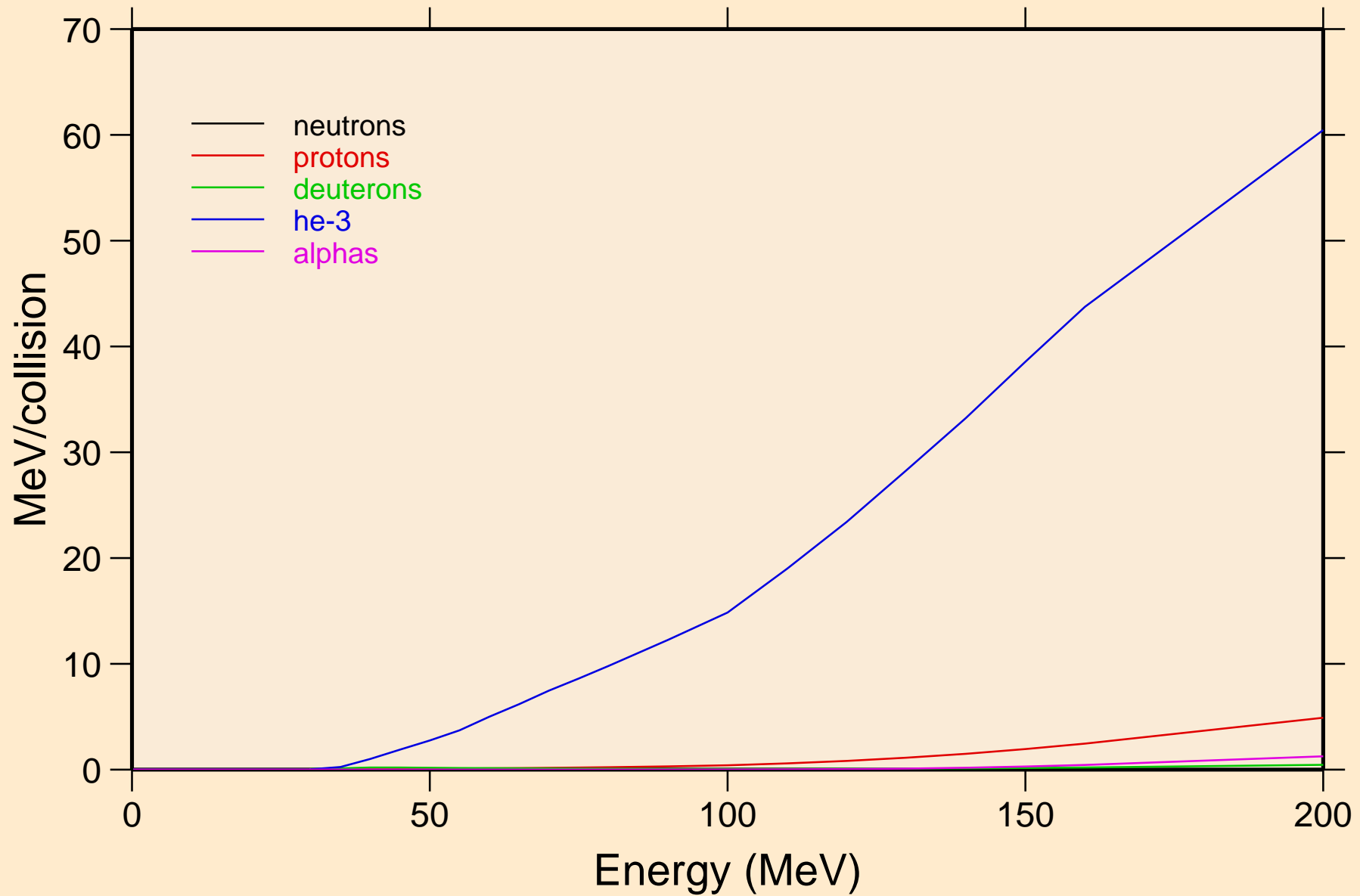

LR259 TRITON ACER TENDL-2021 LIBRARY; T=0.K  
Recoil Heating

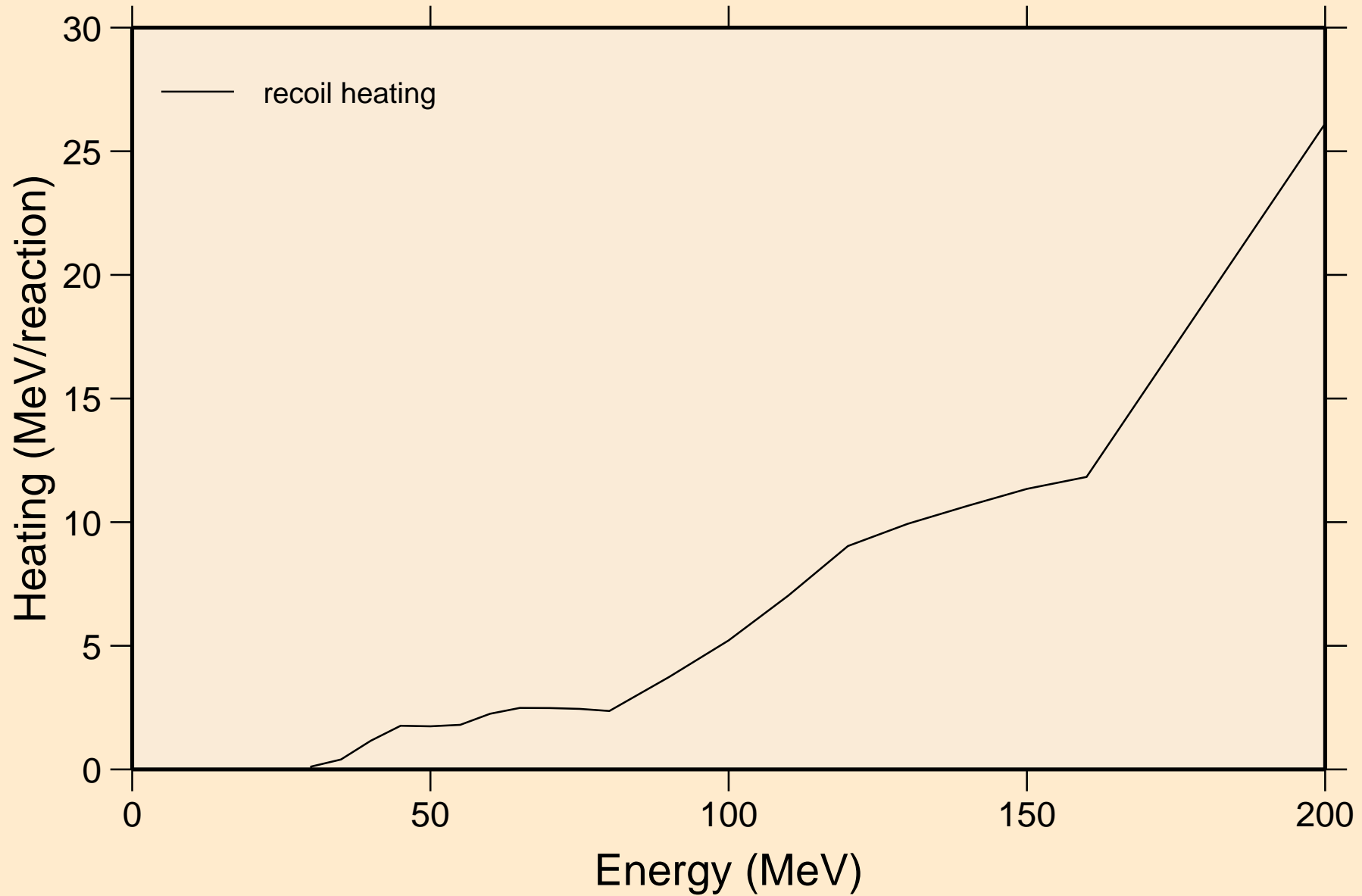

LR259 TRITON ACER TENDL-2021 LIBRARY; T=0.K  
Particle production cross sections

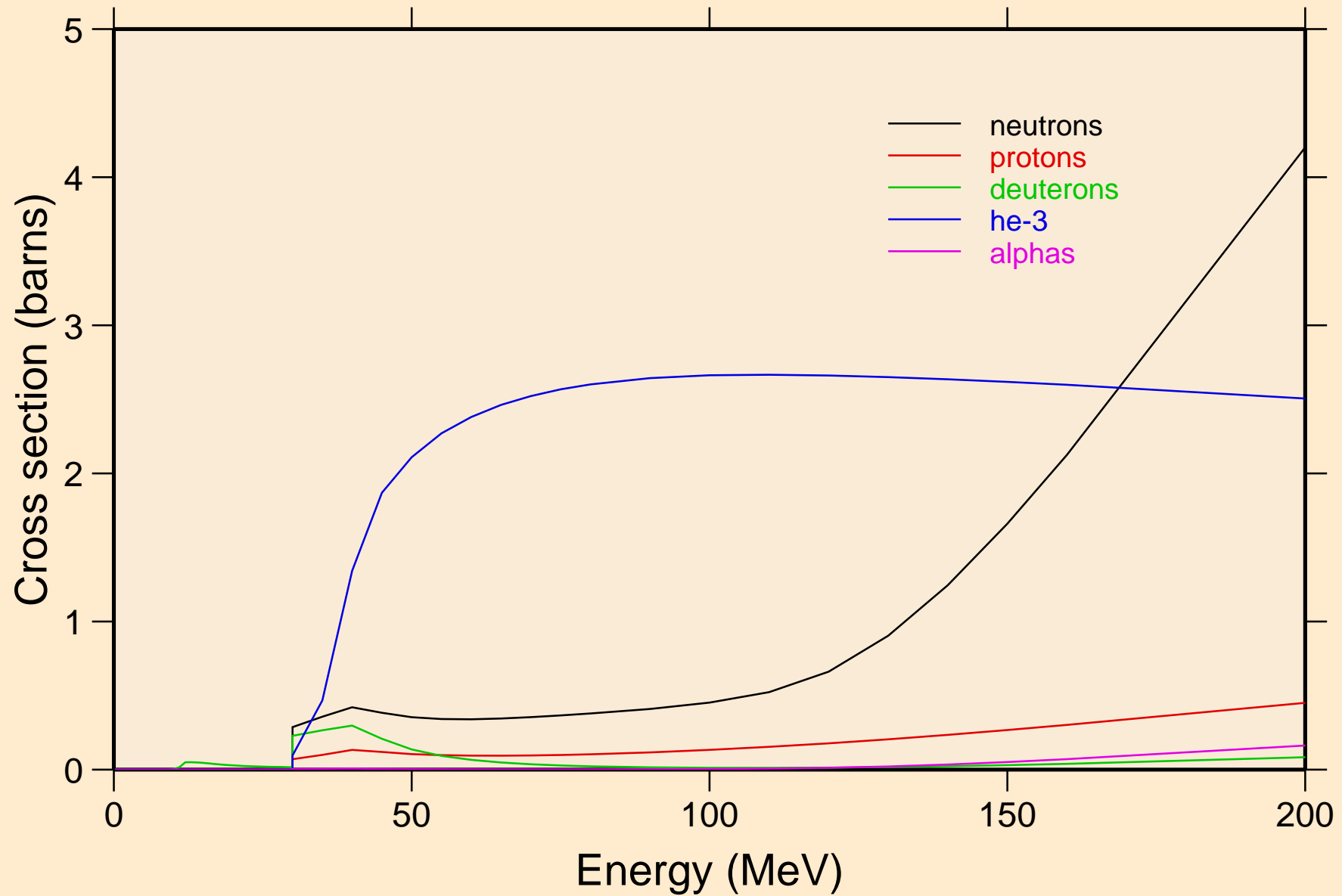



LR259 TRITON ACER TENDL-2021 LIBRARY; T=0.K  
neutrons from (t,n)

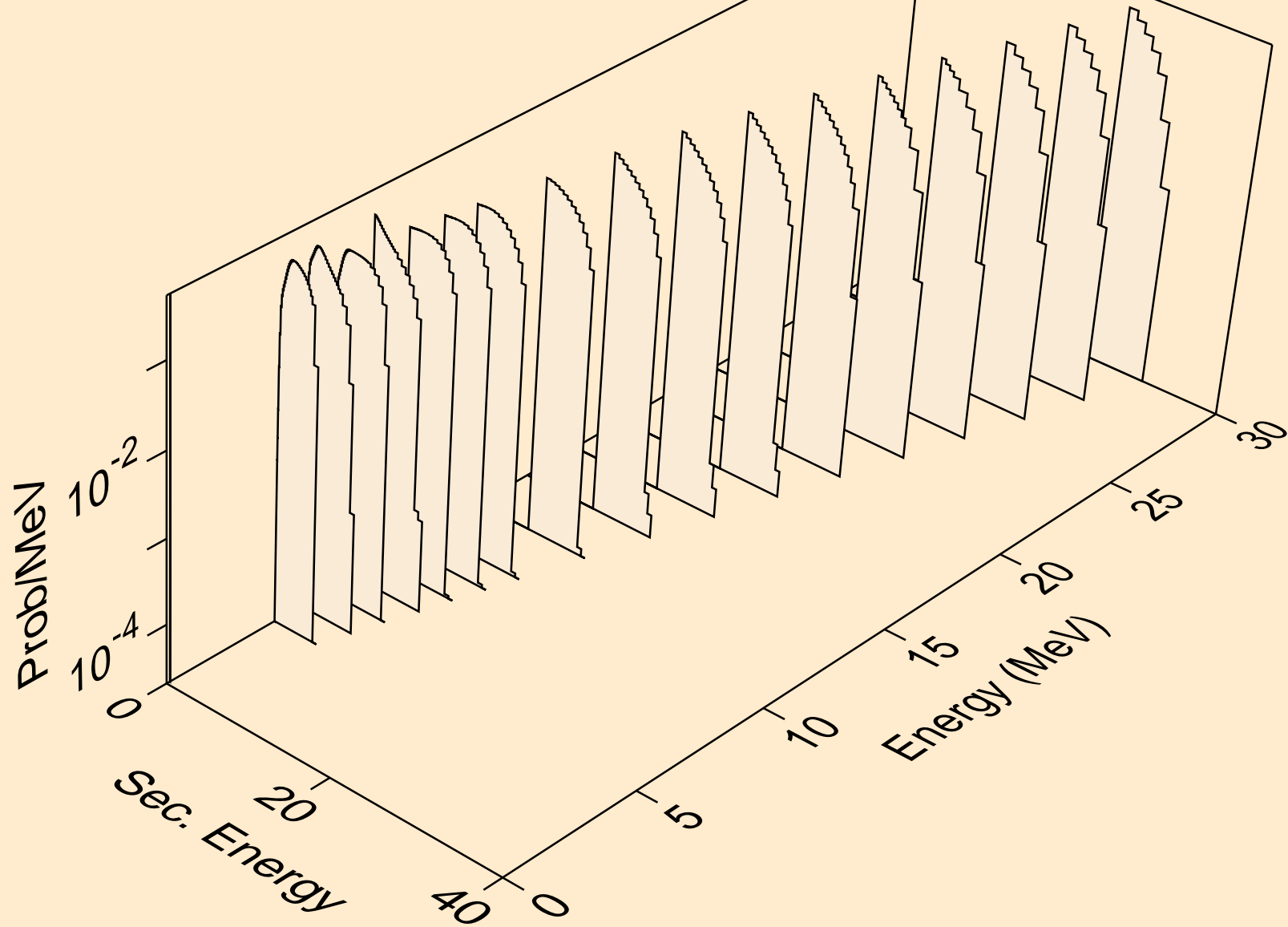

LR259 TRITON ACER TENDL-2021 LIBRARY; T=0.K  
neutrons from (t,x)

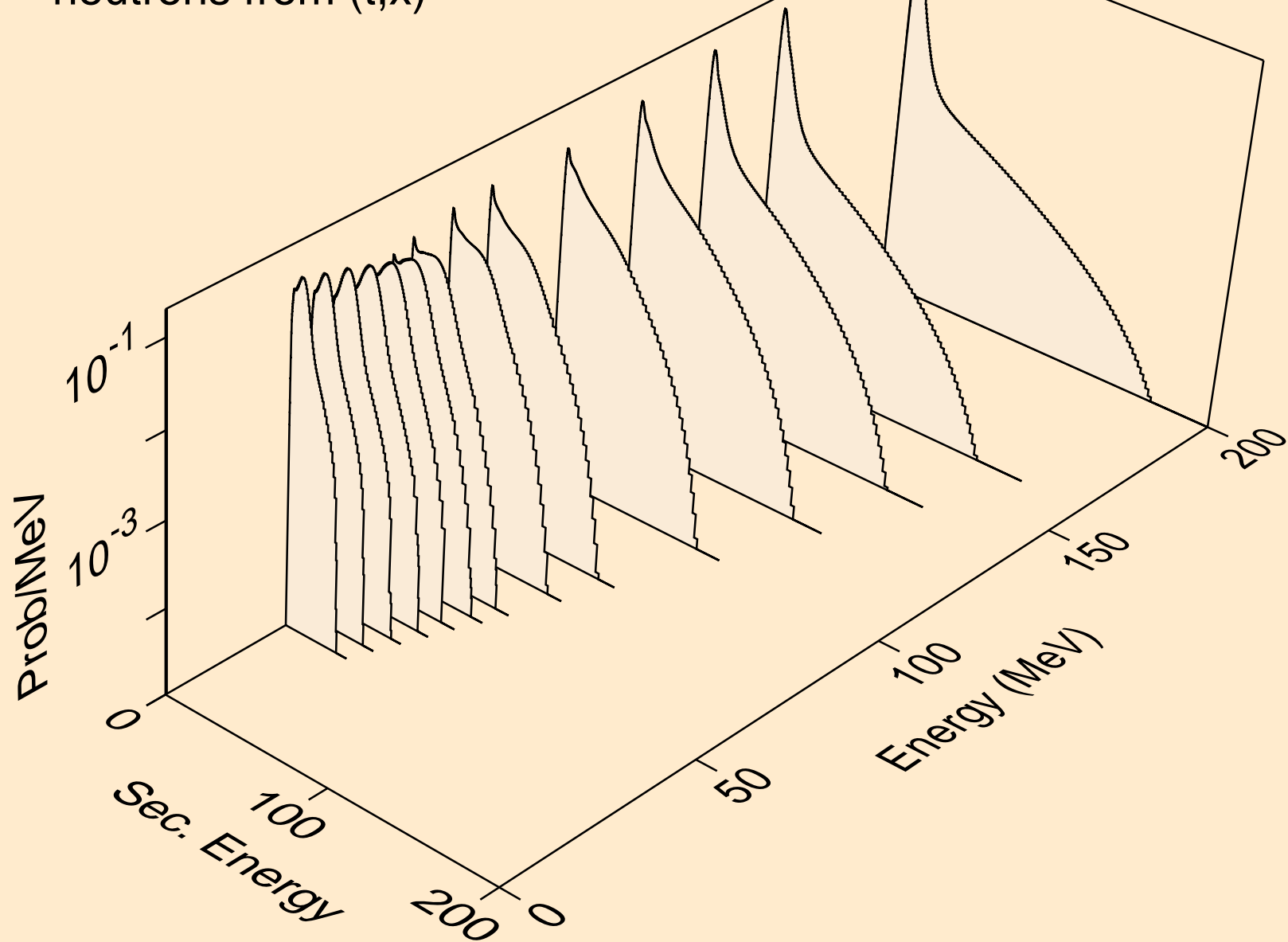

LR259 TRITON ACER TENDL-2021 LIBRARY; T=0.K  
neutrons from (t,2n)

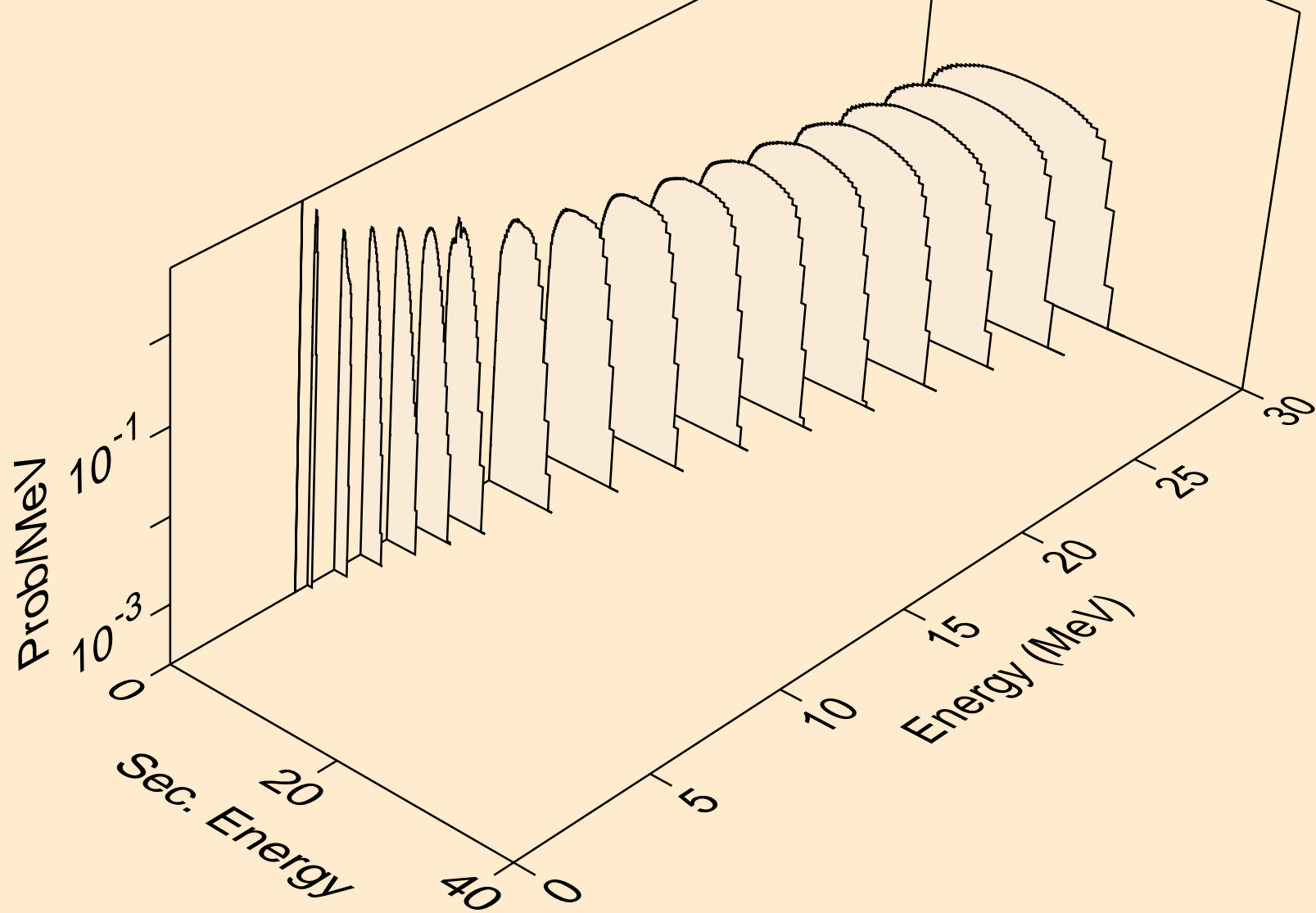

LR259 TRITON ACER TENDL-2021 LIBRARY; T=0.K  
neutrons from (t,3n)

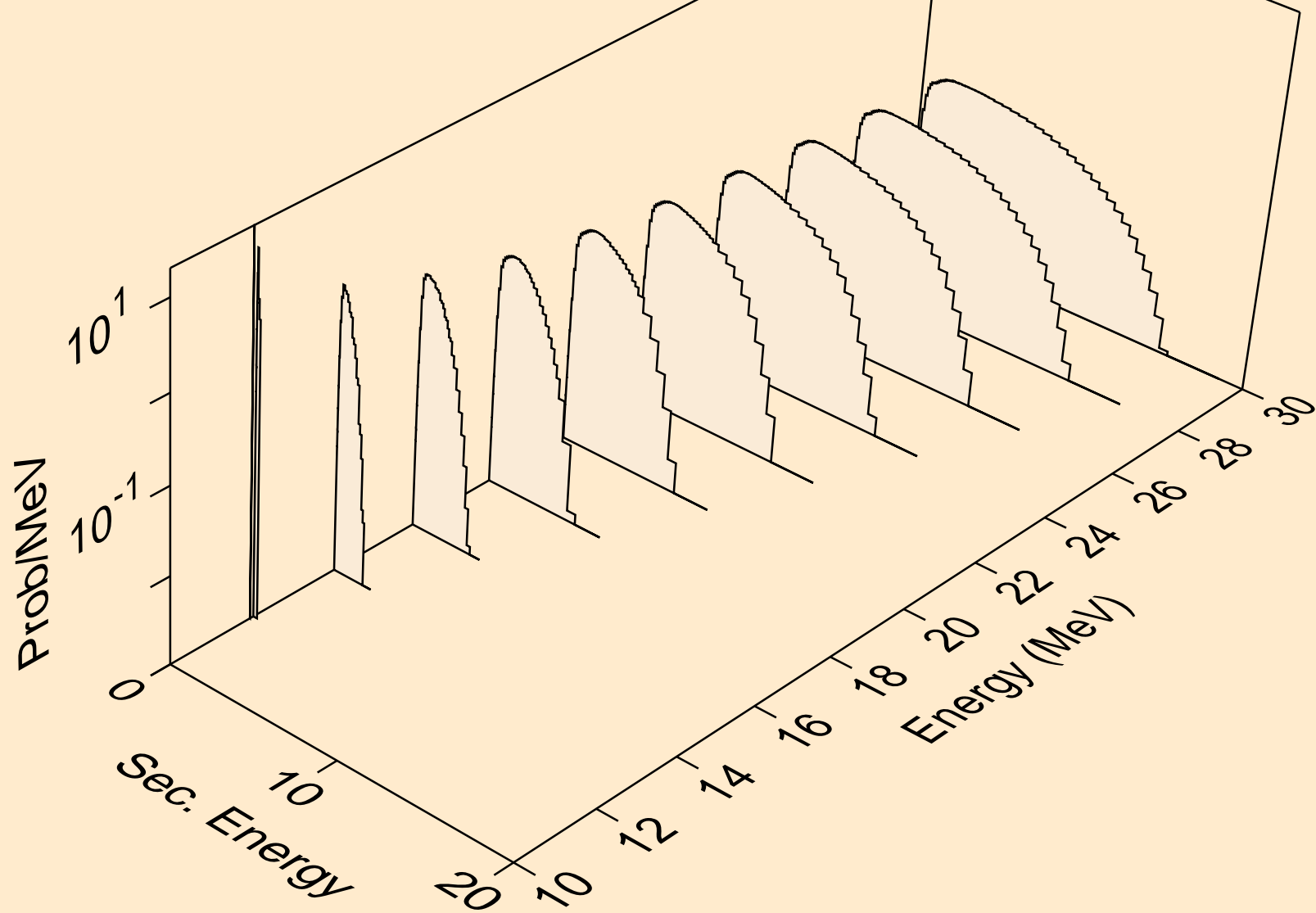

LR259 TRITON ACER TENDL-2021 LIBRARY; T=0.K  
neutrons from (t,n\*)a

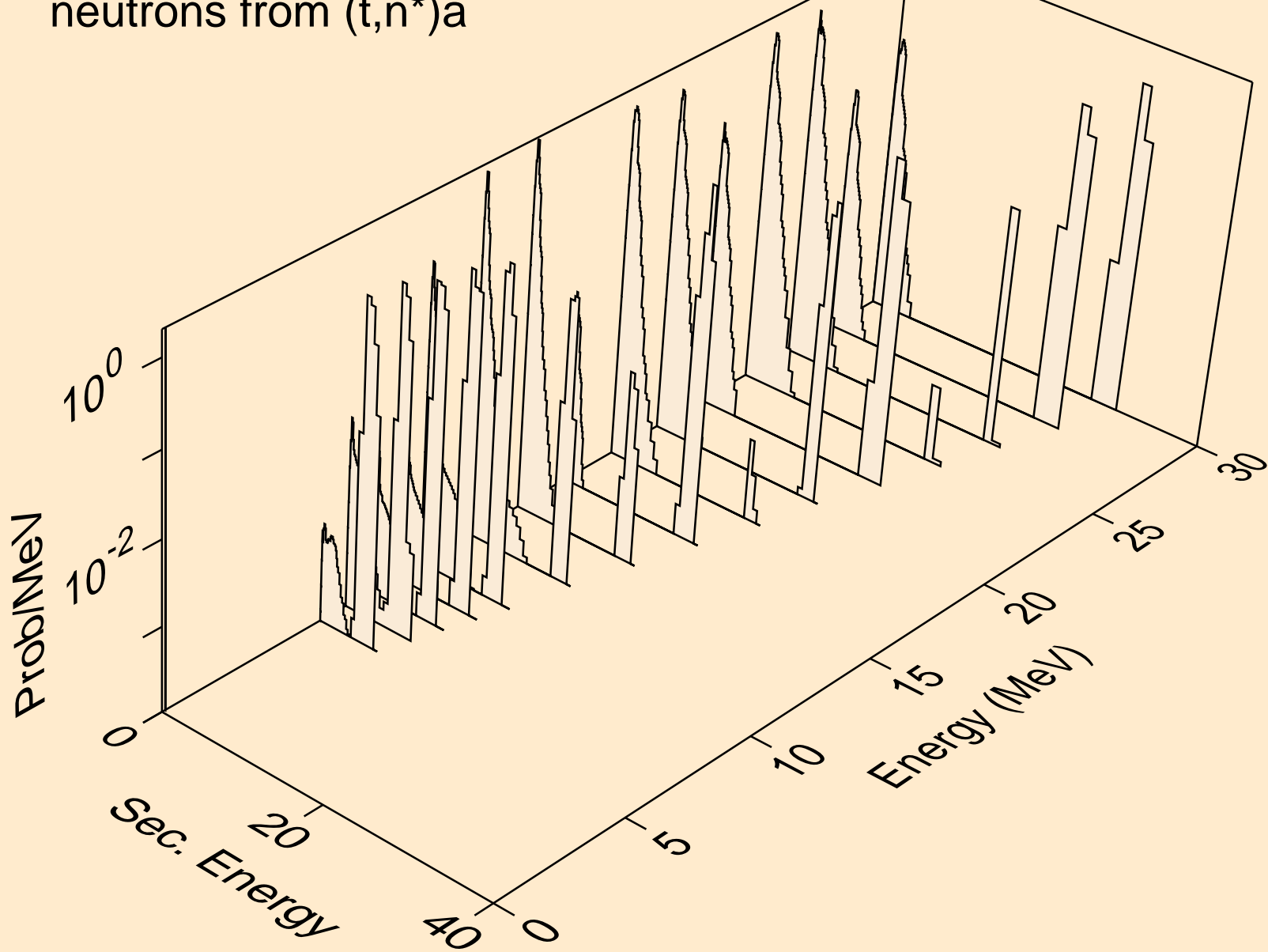

LR259 TRITON ACER TENDL-2021 LIBRARY; T=0.K  
neutrons from (t,3n)a

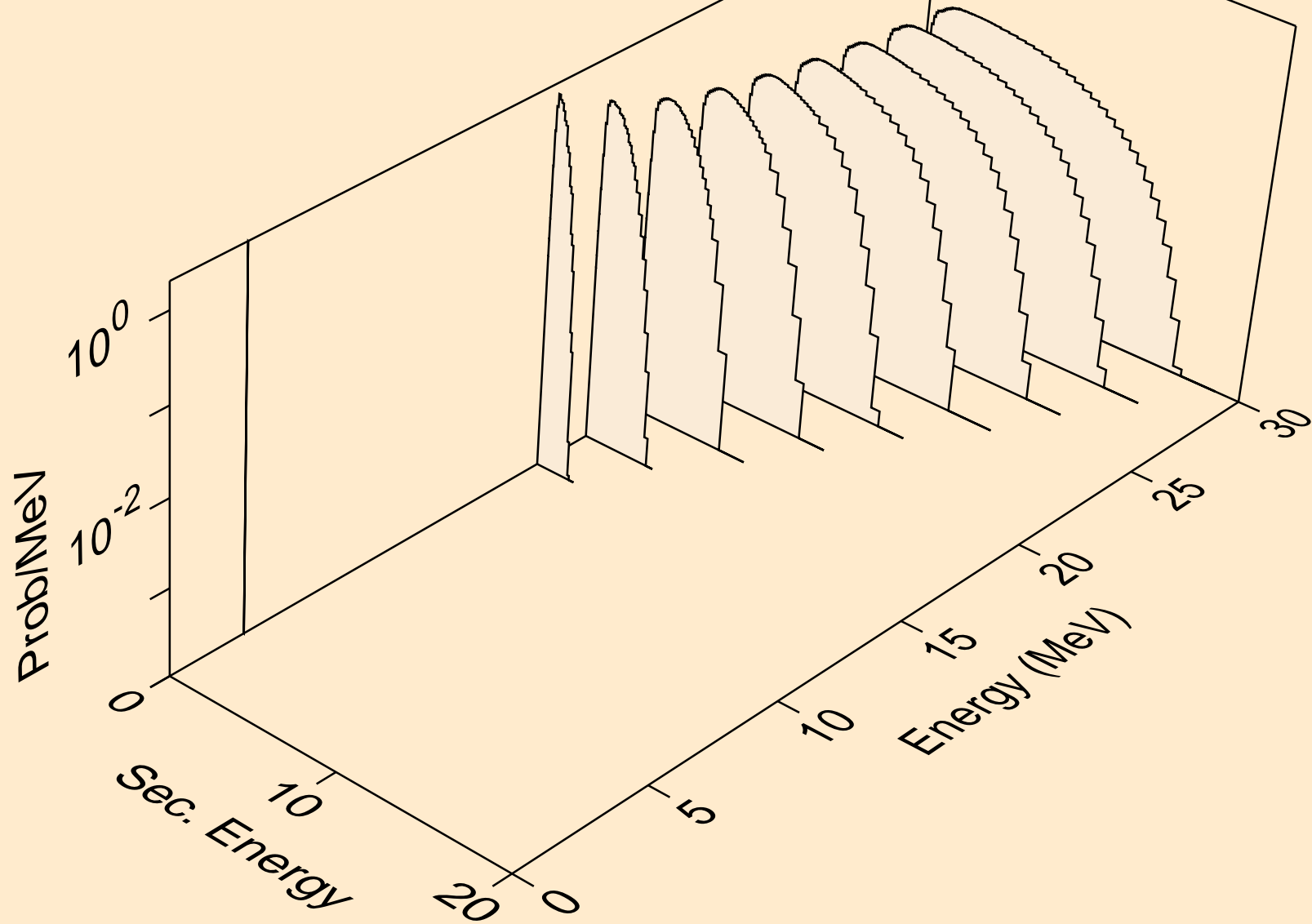

LR259 TRITON ACER TENDL-2021 LIBRARY; T=0.K  
neutrons from (t,n\*)p

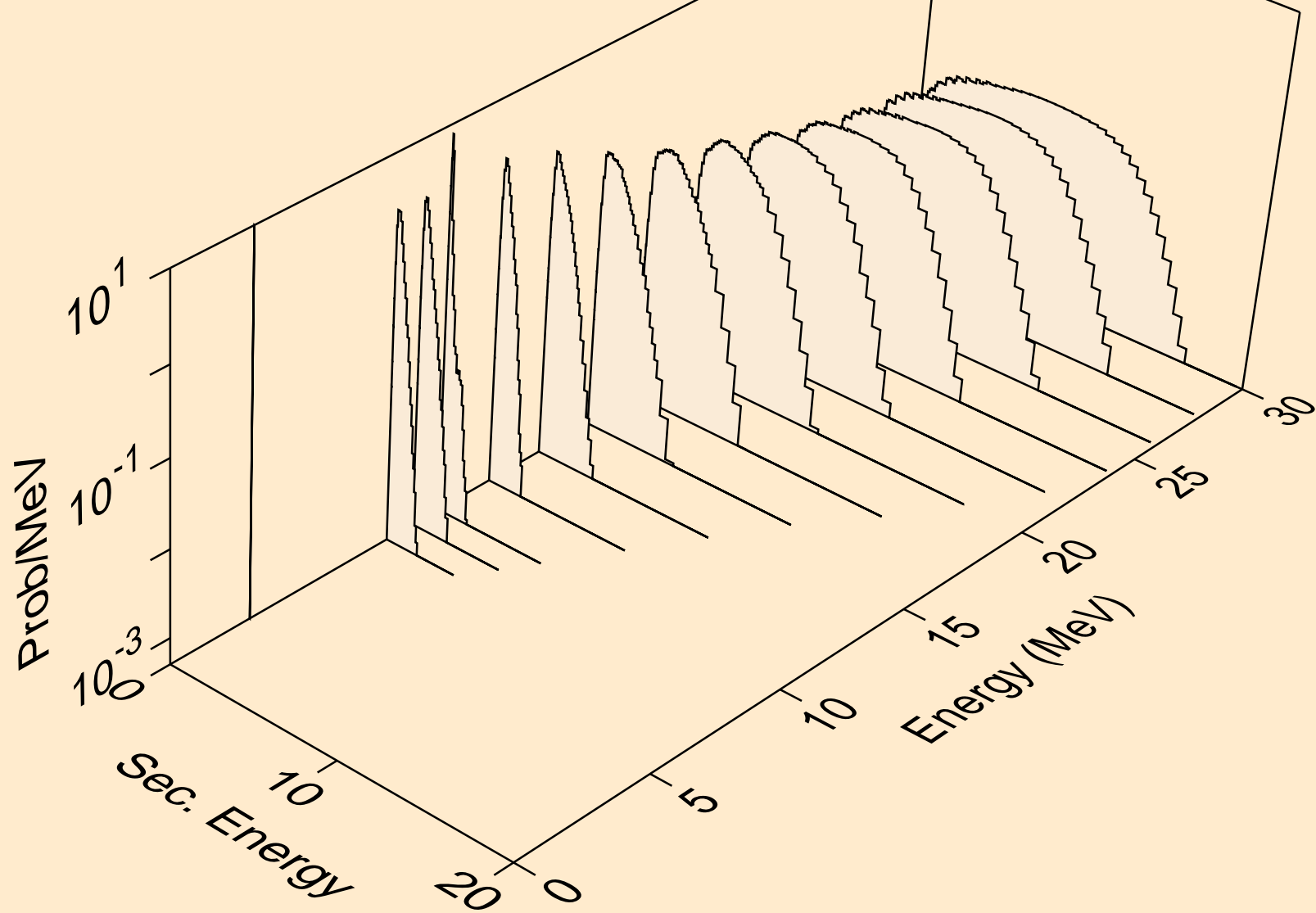

LR259 TRITON ACER TENDL-2021 LIBRARY; T=0.K  
neutrons from (t,n\*)d

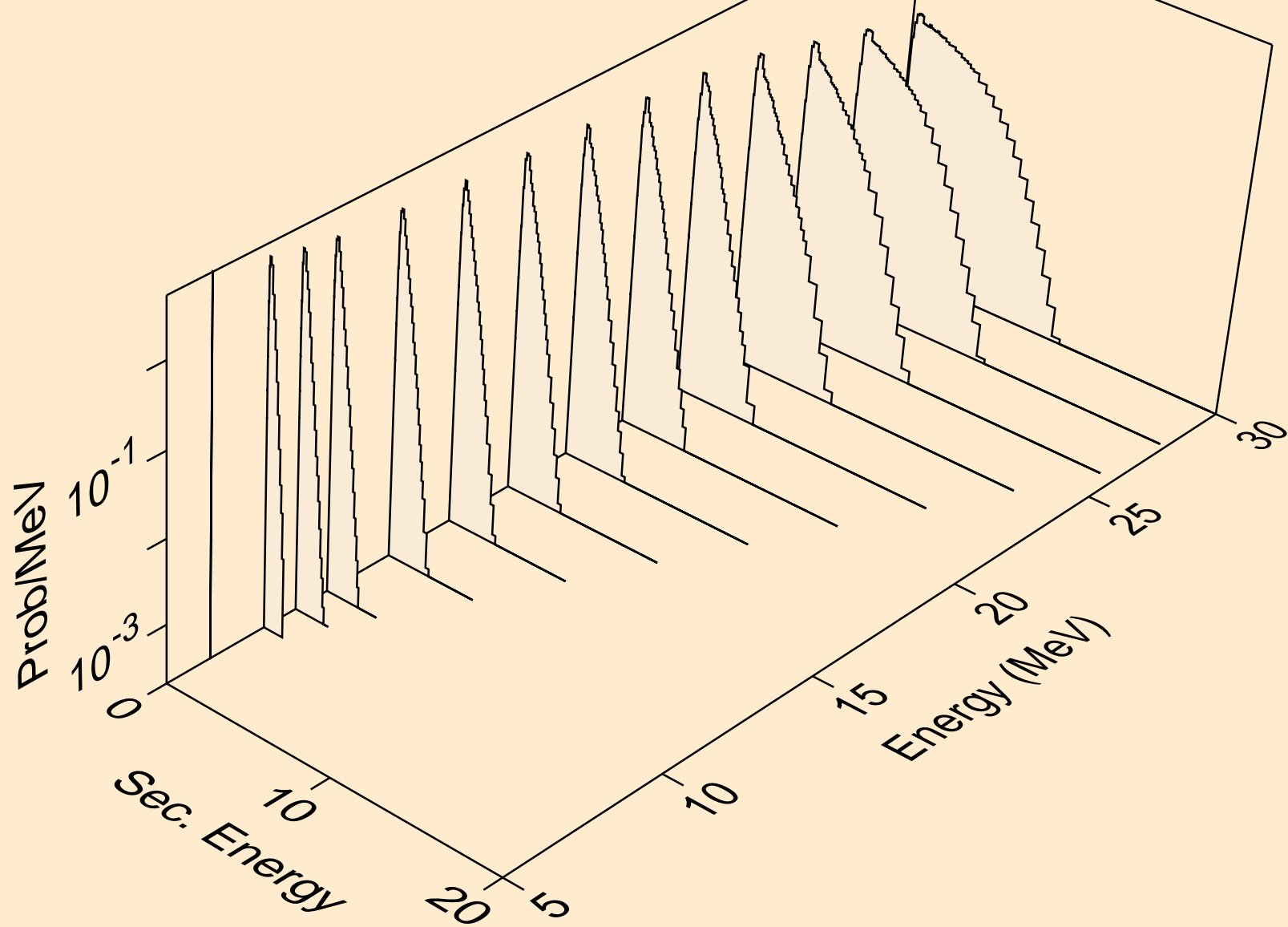



LR259 TRITON ACER TENDL-2021 LIBRARY; T=0.K  
neutrons from (t,n\*)t

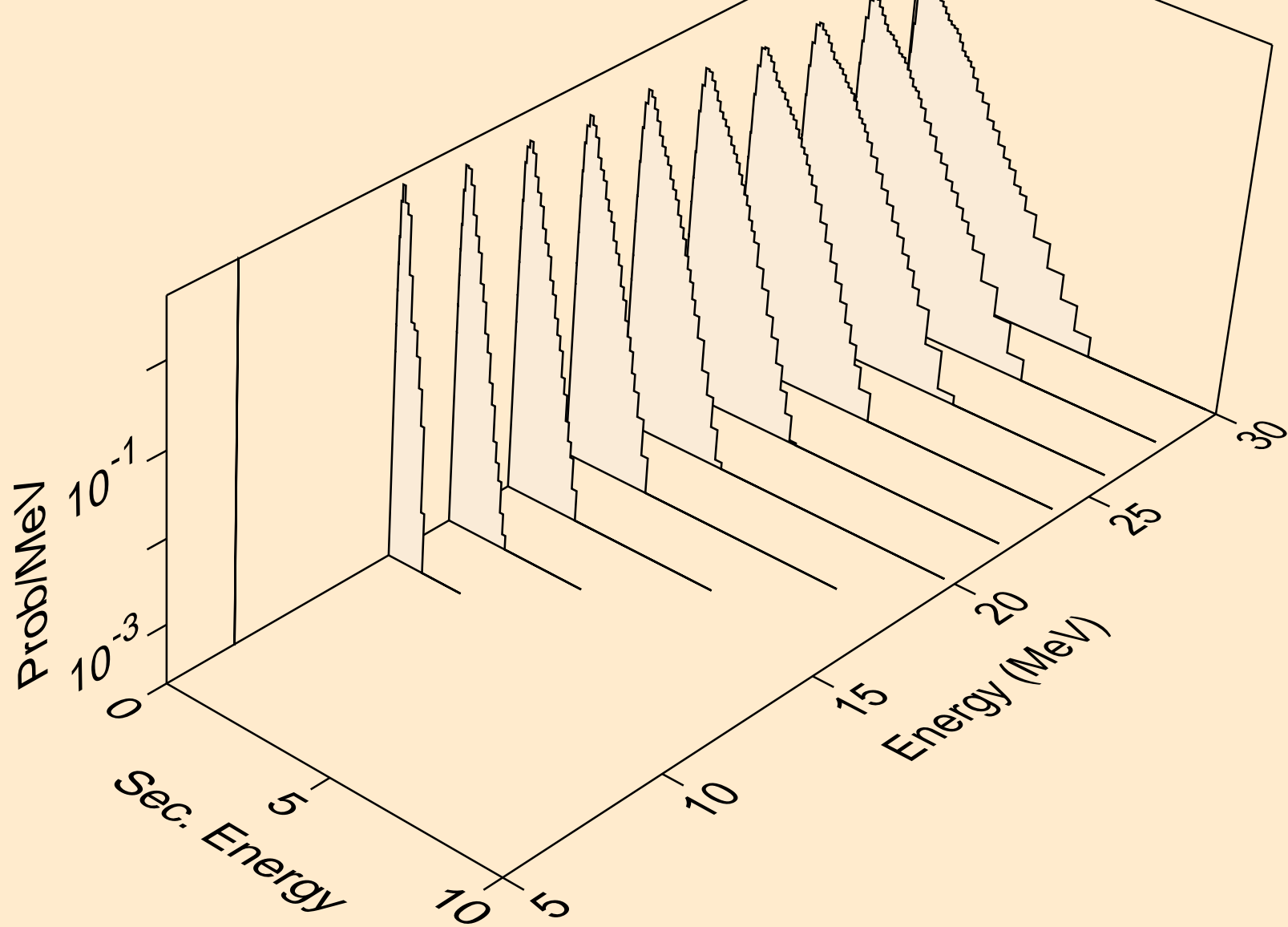

LR259 TRITON ACER TENDL-2021 LIBRARY; T=0.K  
neutrons from (t,n\*)he3

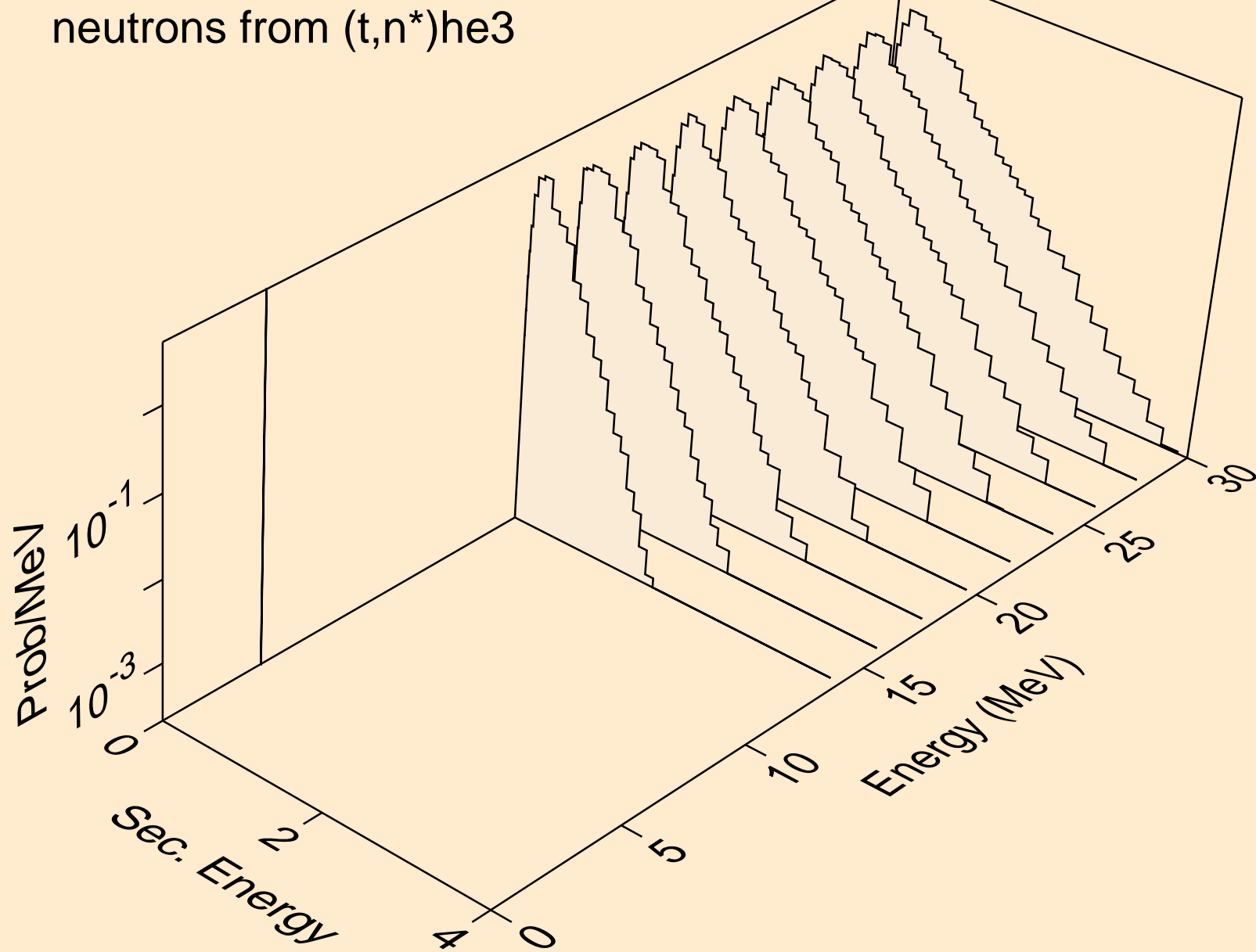

LR259 TRITON ACER TENDL-2021 LIBRARY; T=0.K  
neutrons from (t,4n)

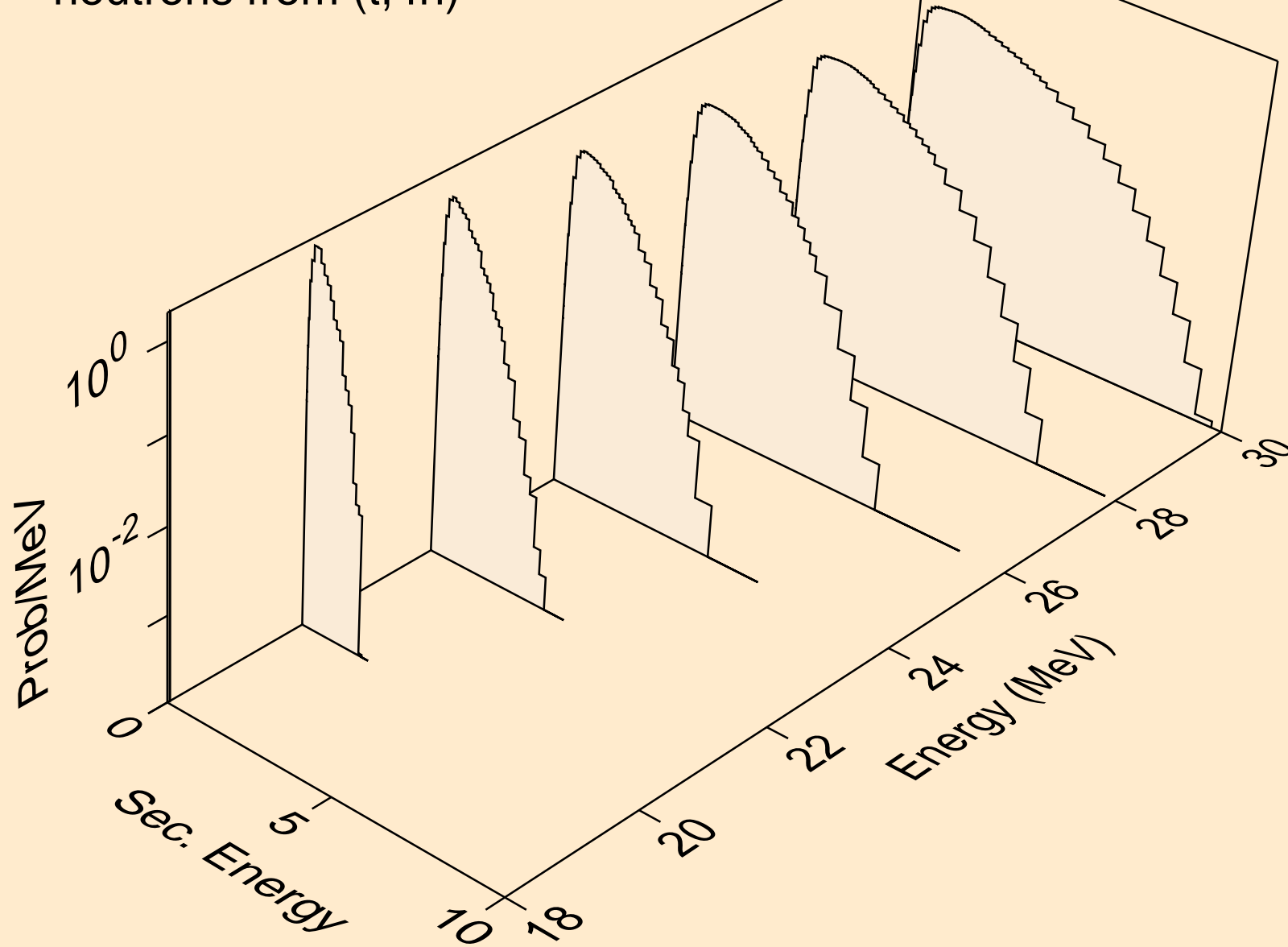

LR259 TRITON ACER TENDL-2021 LIBRARY; T=0.K  
neutrons from (t,2np)

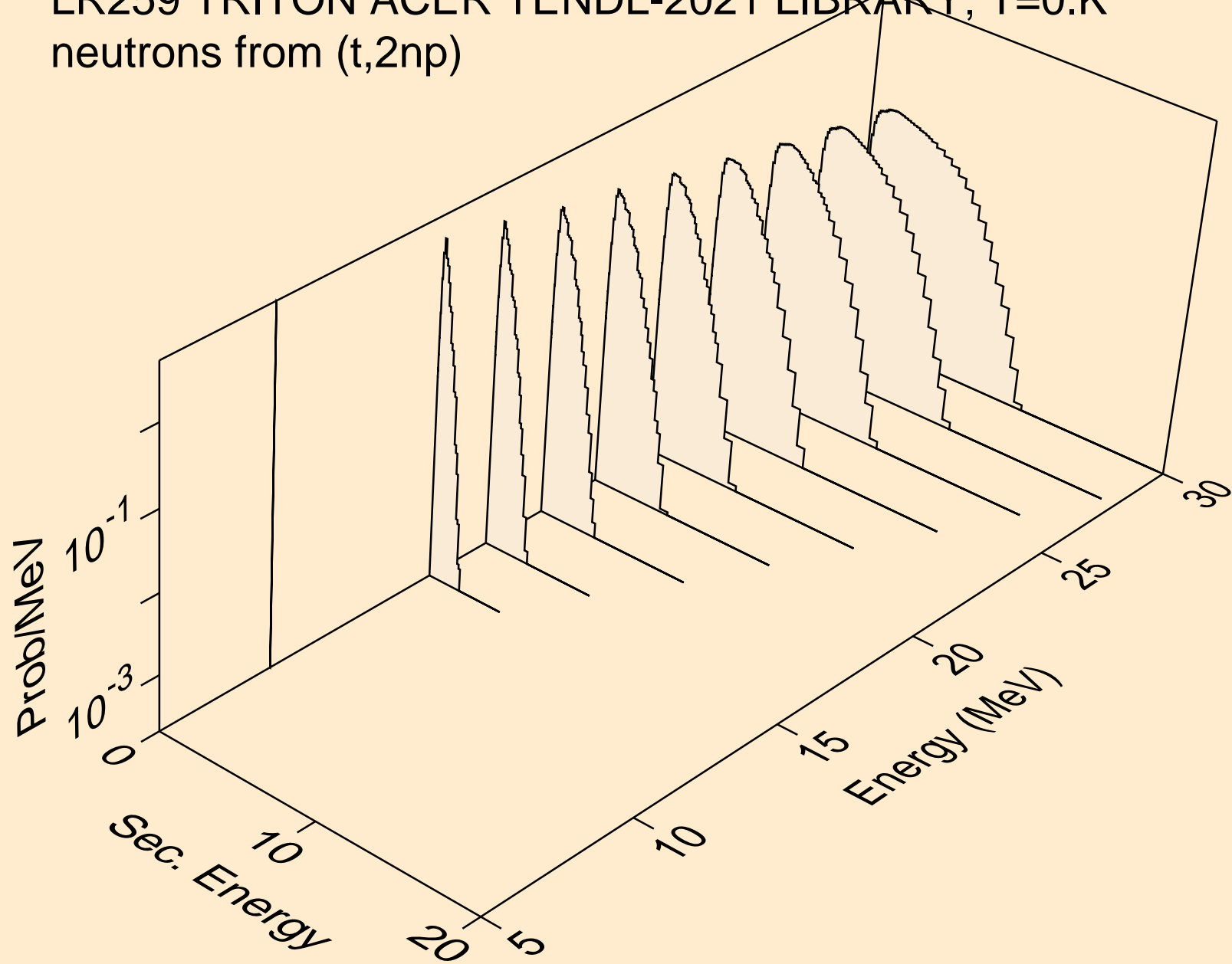

LR259 TRITON ACER TENDL-2021 LIBRARY; T=0.K  
neutrons from (t,3np)

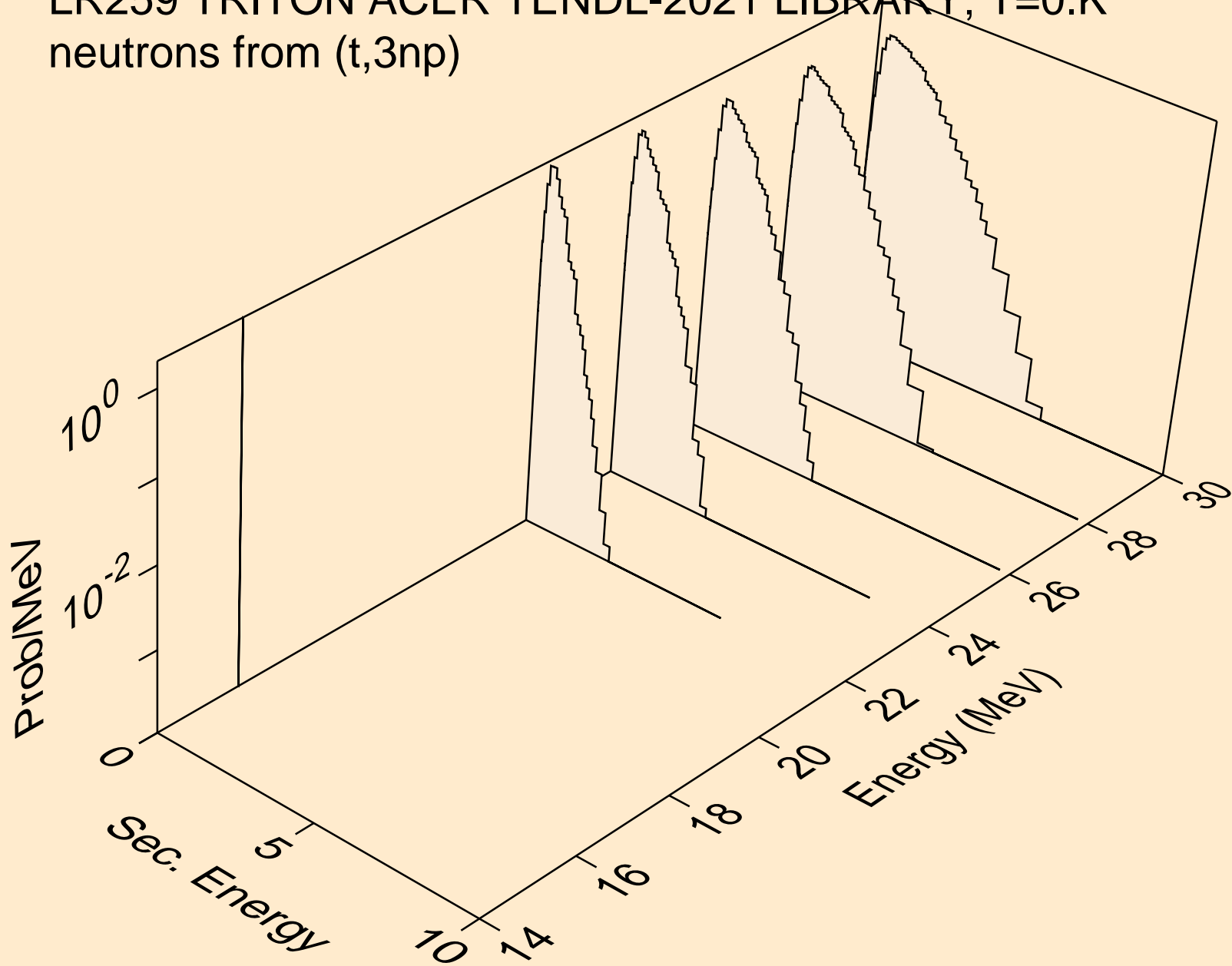

LR259 TRITON ACER TENDL-2021 LIBRARY; T=0.K  
neutrons from (t,npa)

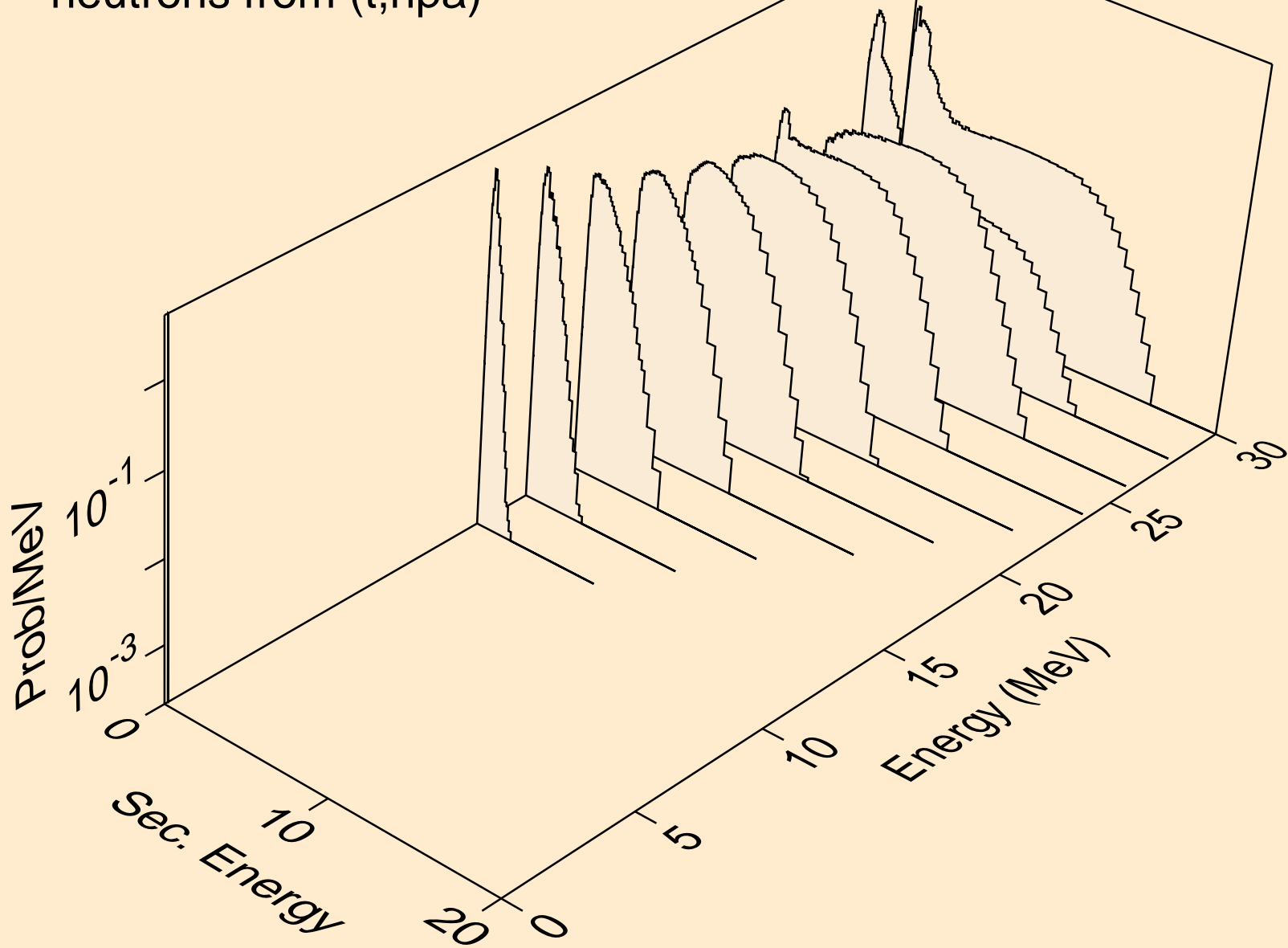

LR259 TRITON ACER TENDL-2021 LIBRARY; T=0.K  
protons from (t,x)

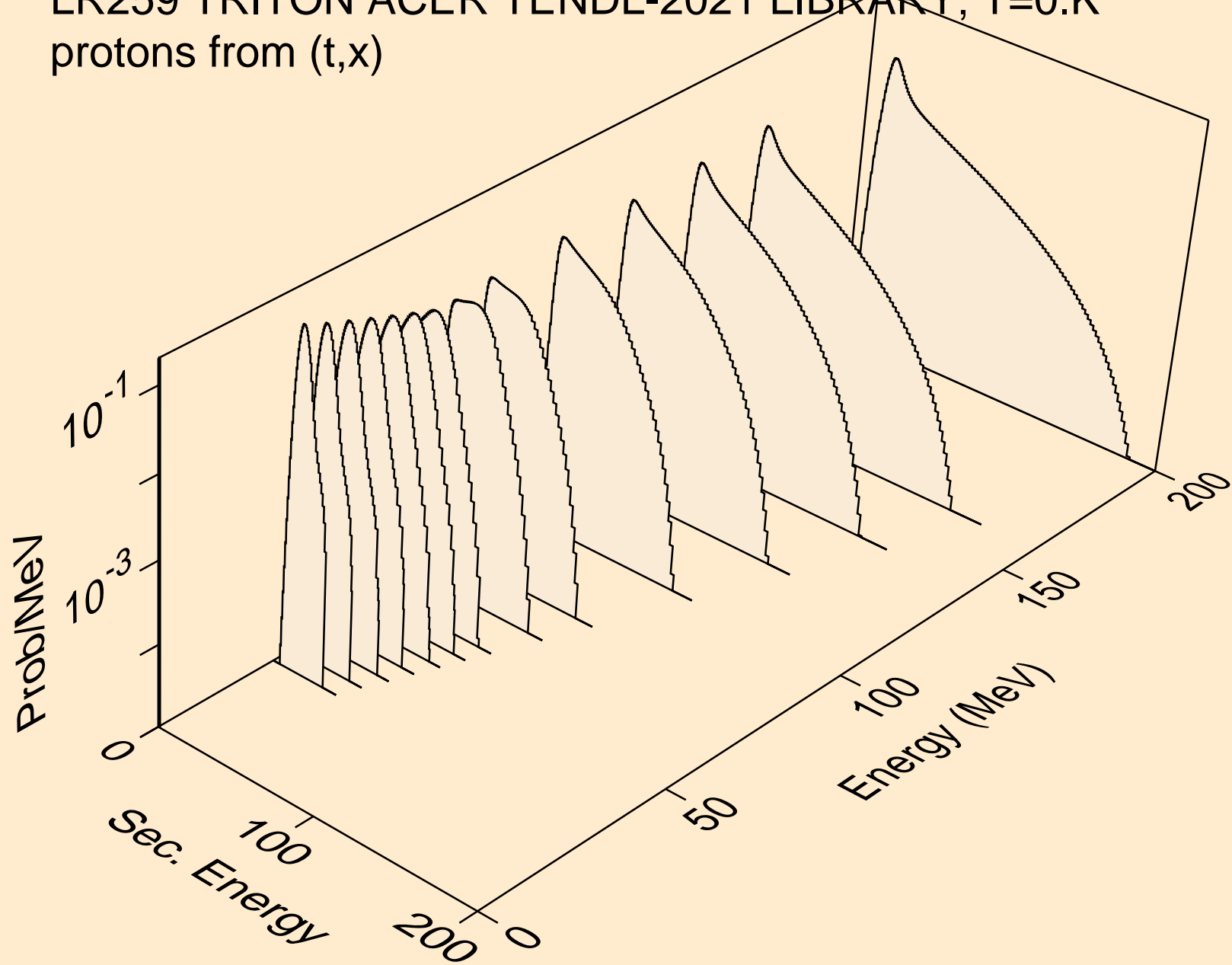

LR259 TRITON ACER TENDL-2021 LIBRARY; T=0.K  
protons from (t,n\*)p

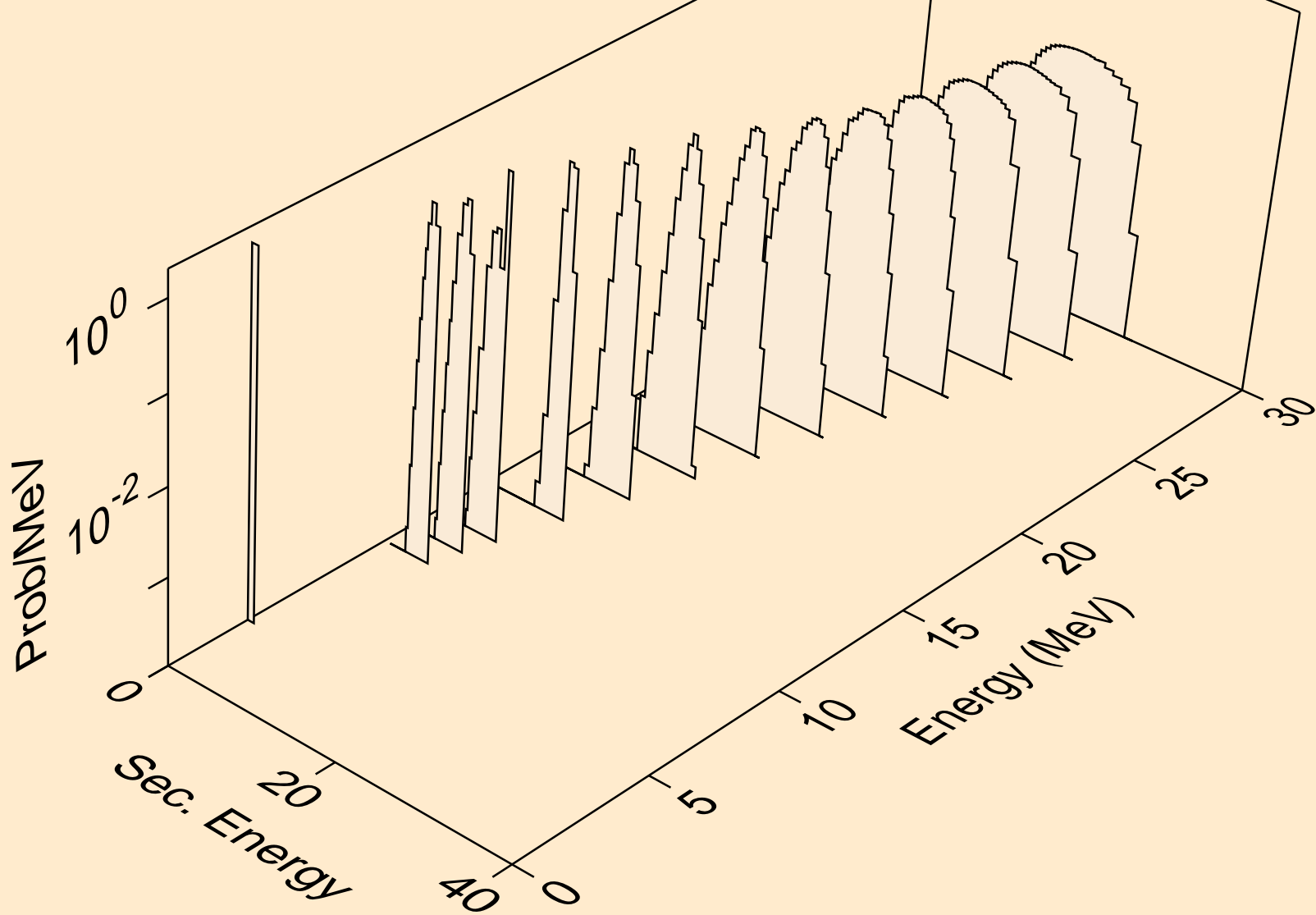



LR259 TRITON ACER TENDL-2021 LIBRARY; T=0.K  
protons from (t,2np)

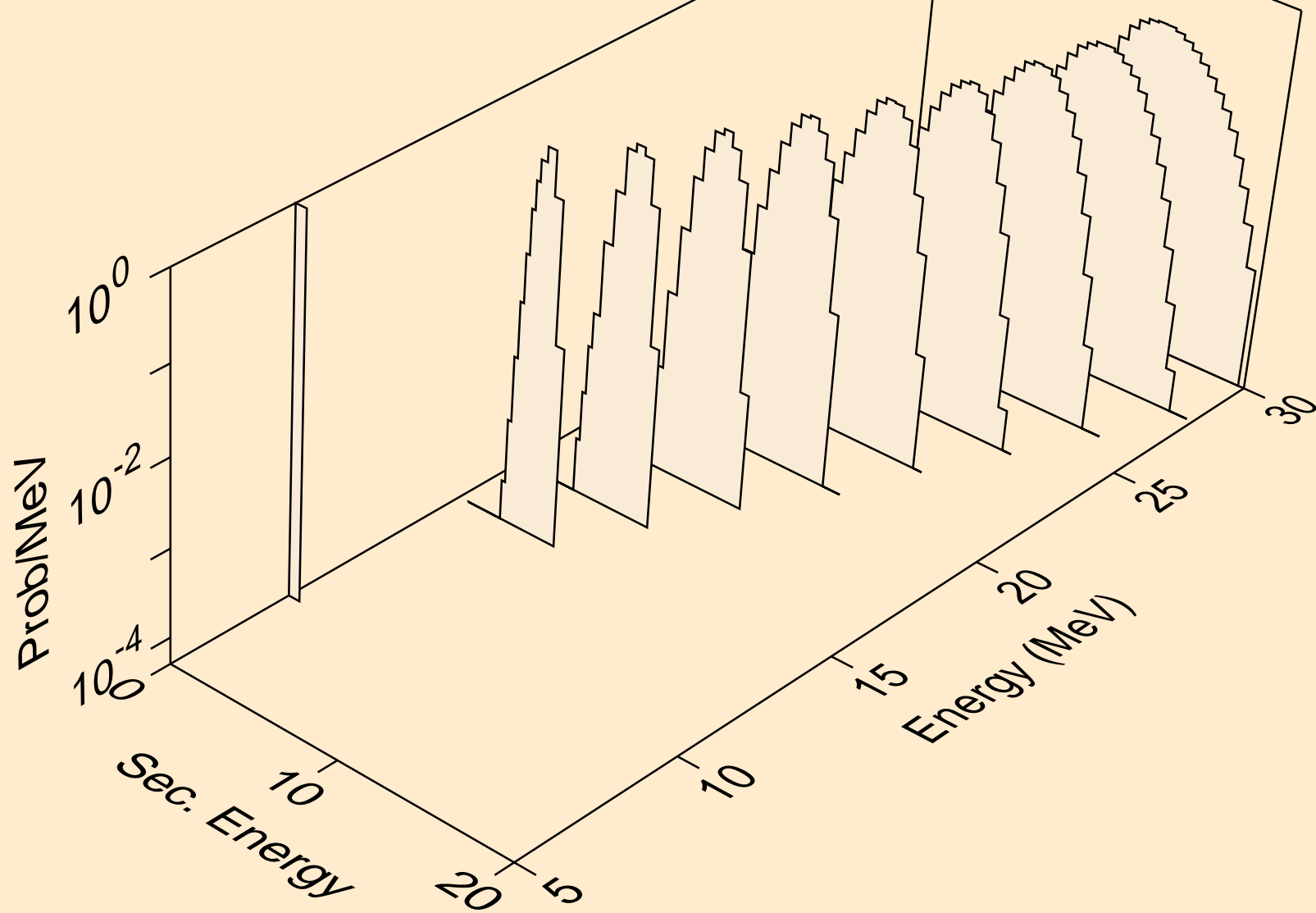

LR259 TRITON ACER TENDL-2021 LIBRARY; T=0.K  
protons from (t,3np)

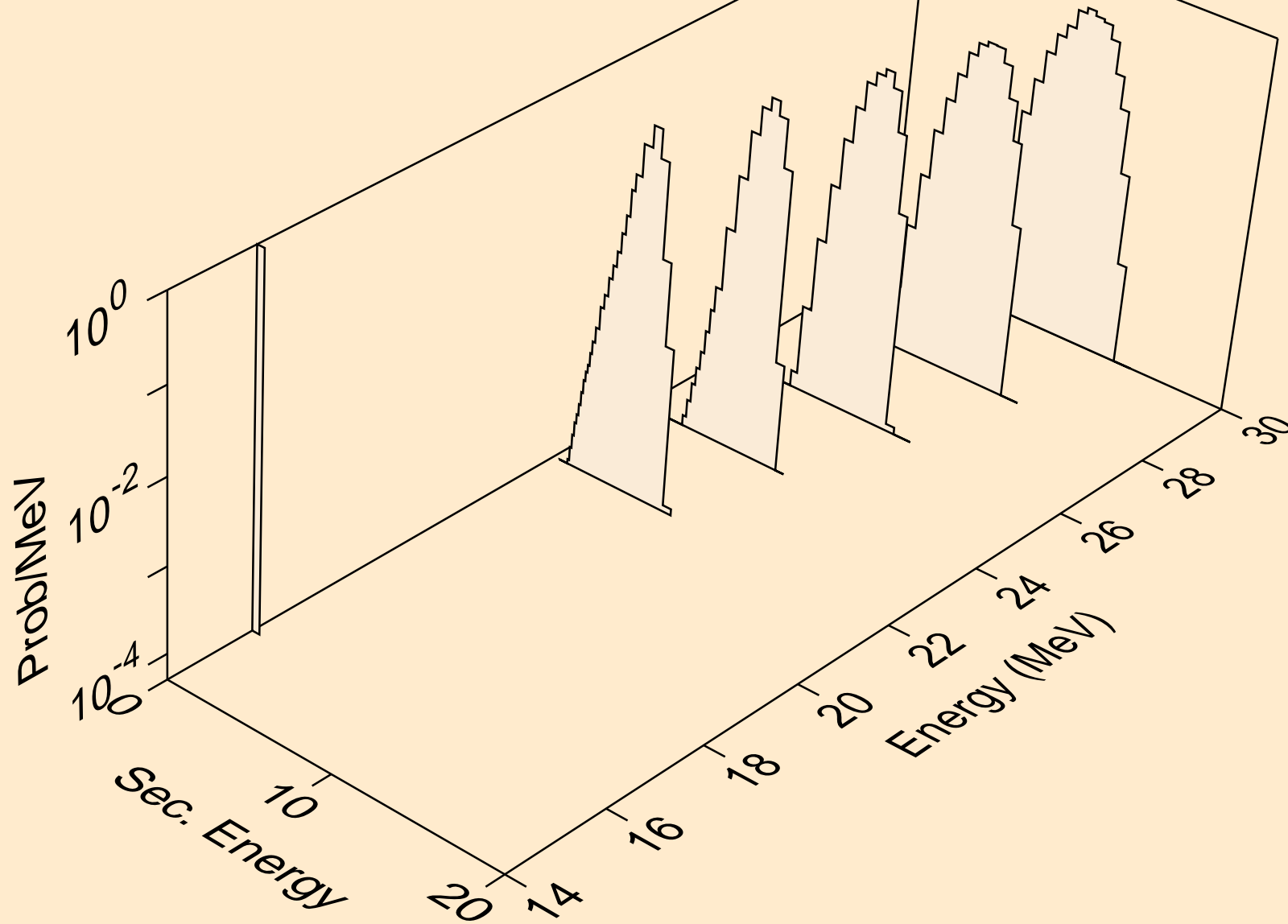

LR259 TRITON ACER TENDL-2021 LIBRARY; T=0.K  
protons from (t,npa)

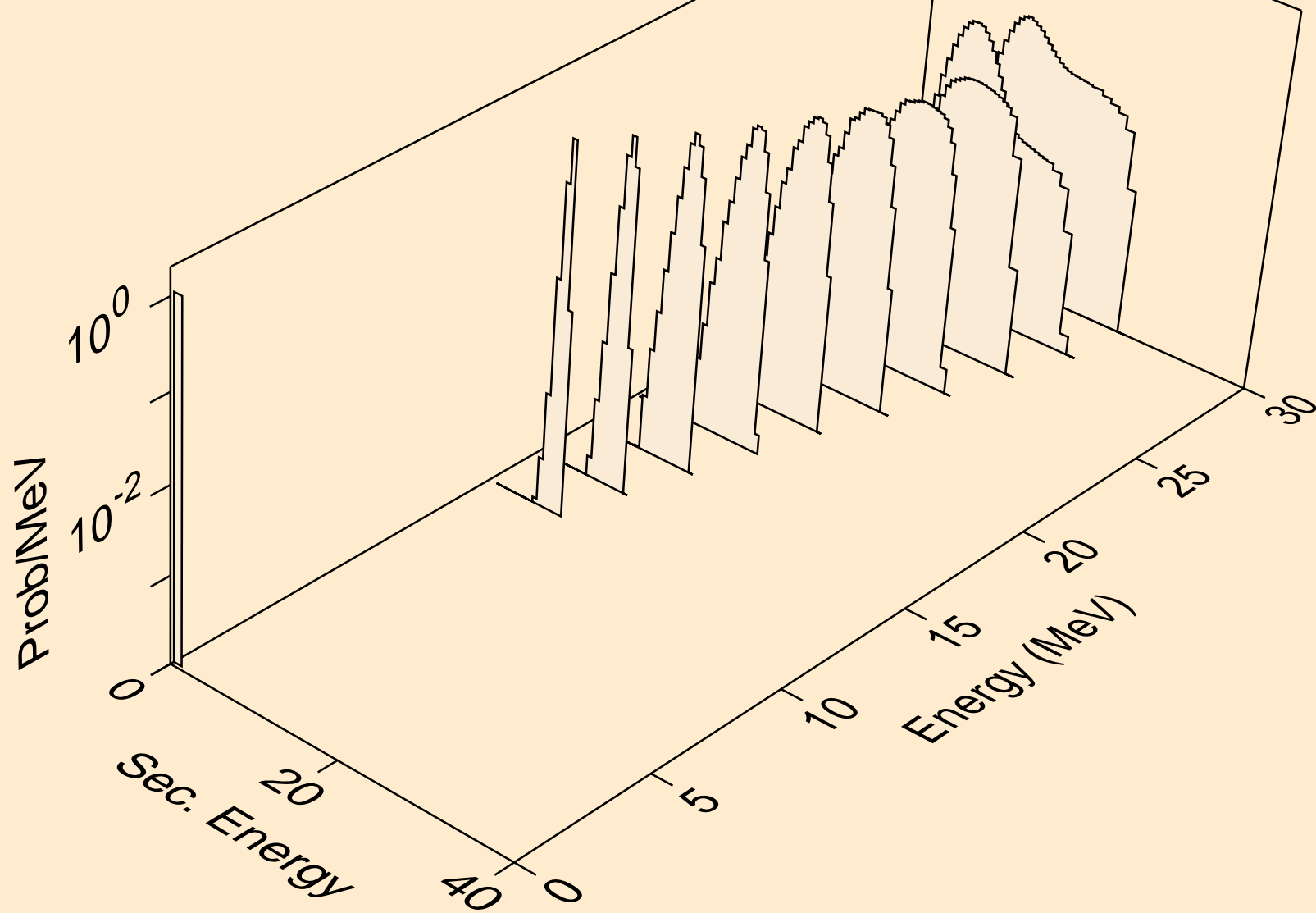

LR259 TRITON ACER TENDL-2021 LIBRARY; T=0.K  
protons from (t,p)

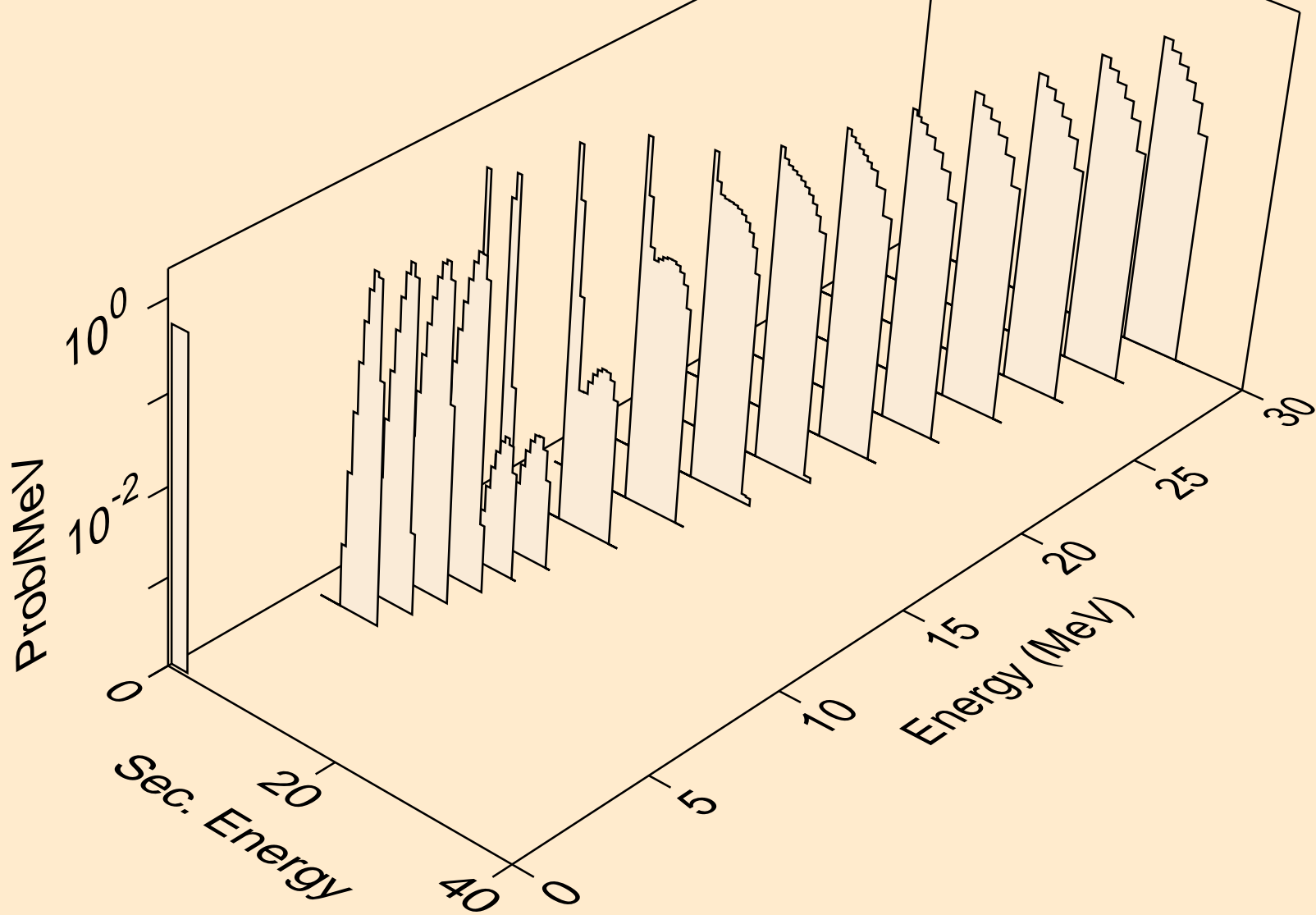

LR259 TRITON ACER TENDL-2021 LIBRARY; T=0.K  
protons from (t,2p)

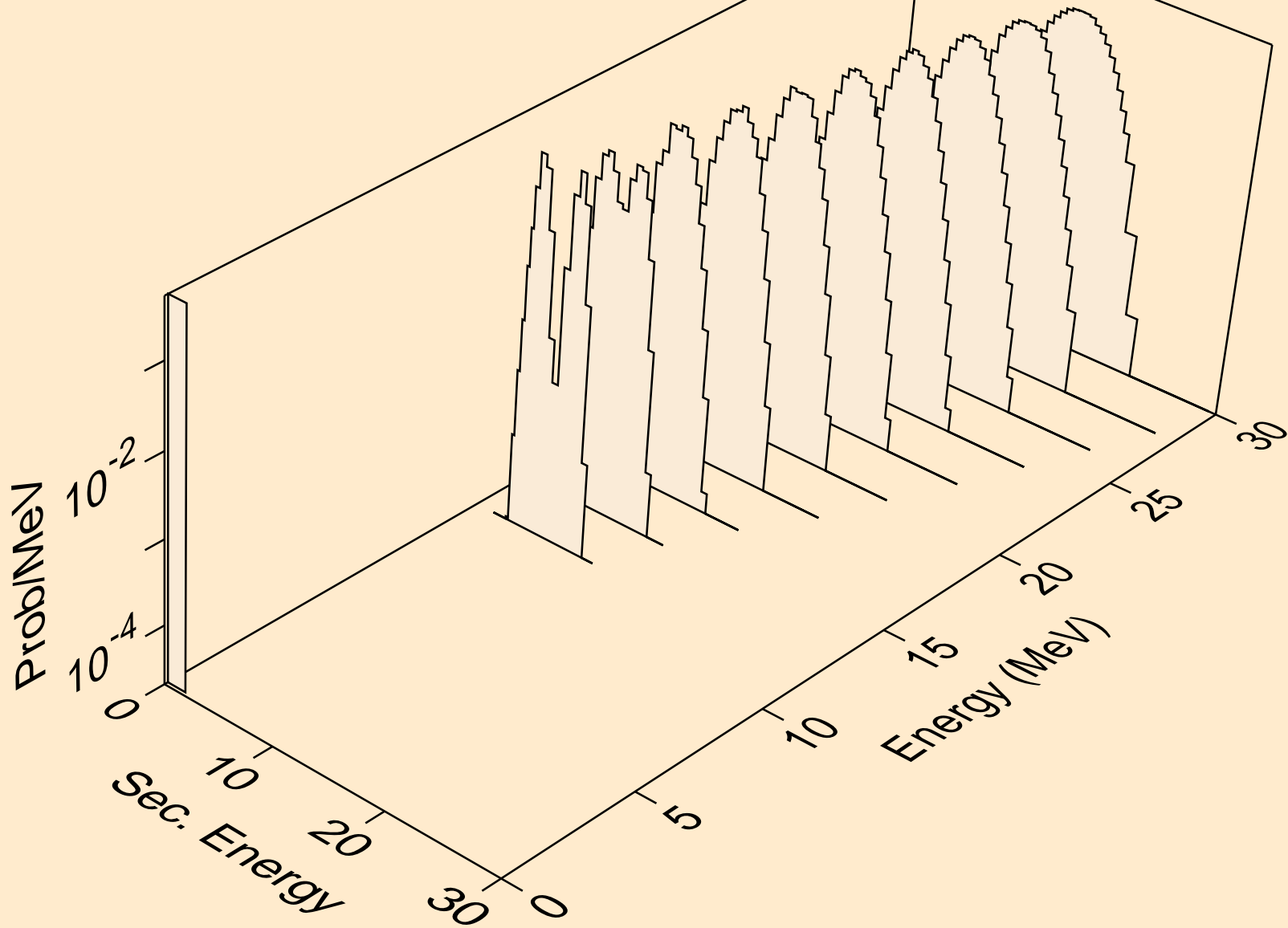

LR259 TRITON ACER TENDL-2021 LIBRARY; T=0.K  
deuterons from (t,x)

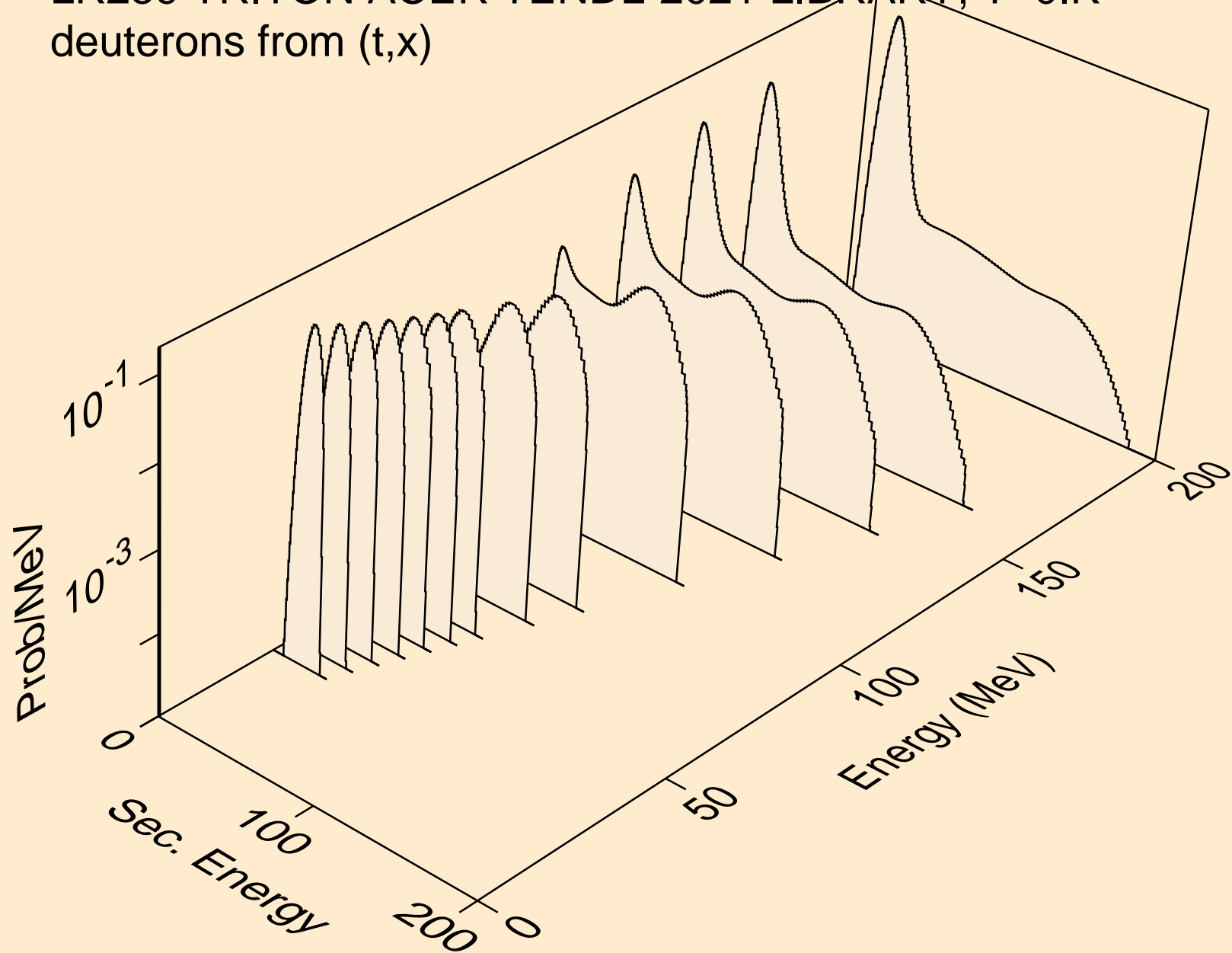

LR259 TRITON ACER TENDL-2021 LIBRARY; T=0.K  
deuterons from (t,n\*)d

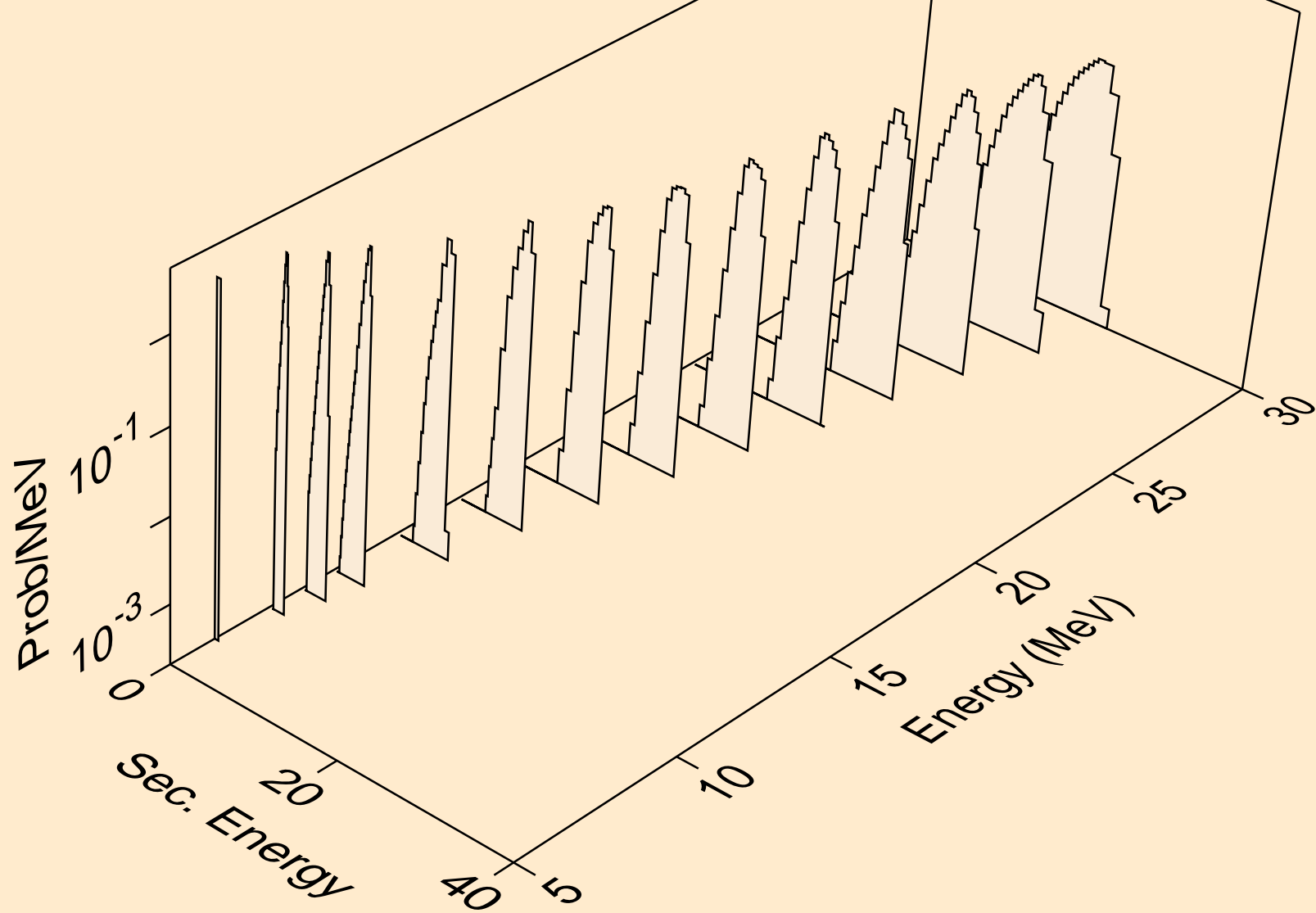

LR259 TRITON ACER TENDL-2021 LIBRARY; T=0.K  
deuterons from (t,d)

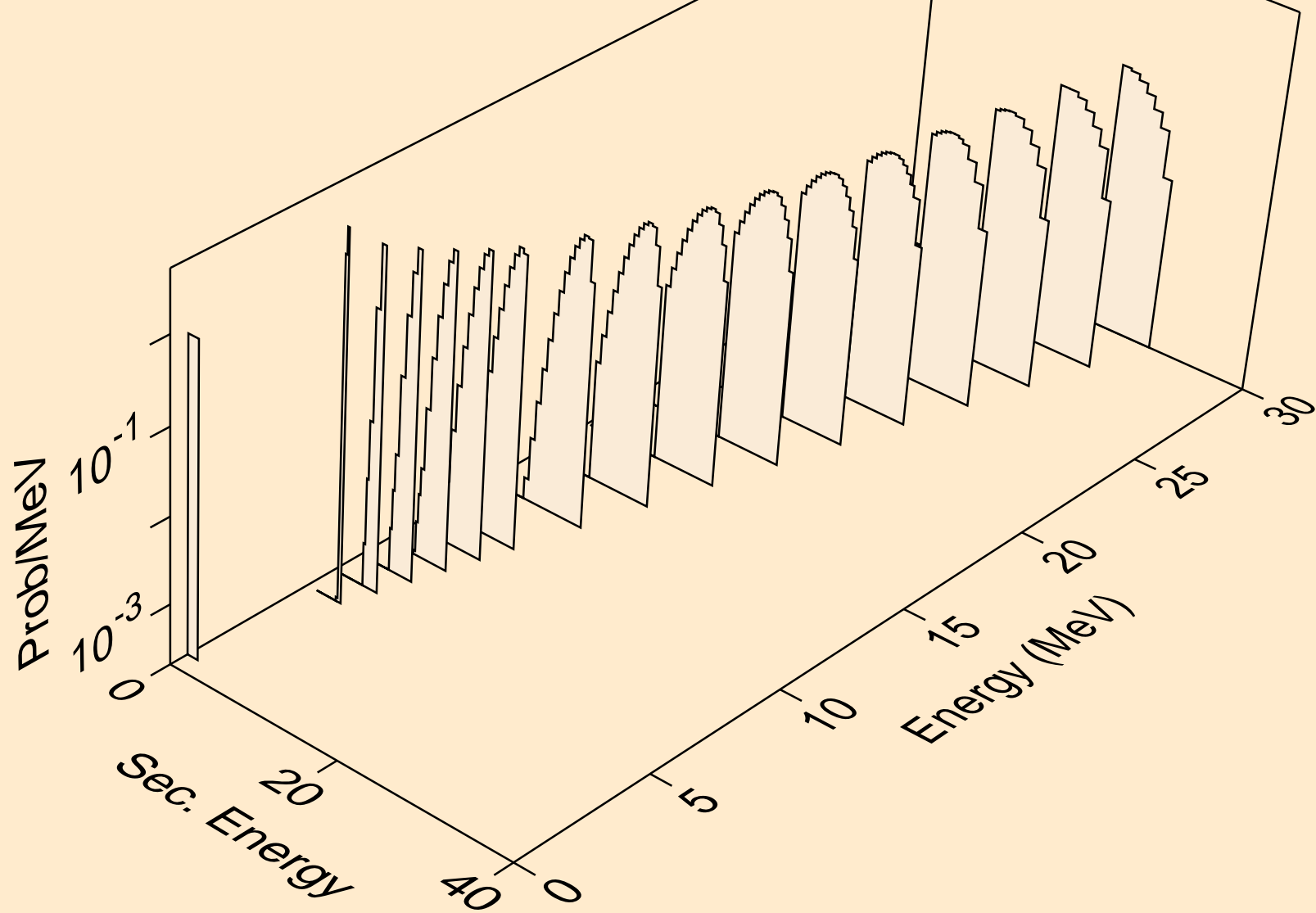



LR259 TRITON ACER TENDL-2021 LIBRARY; T=0.K  
deuterons from (t,da)

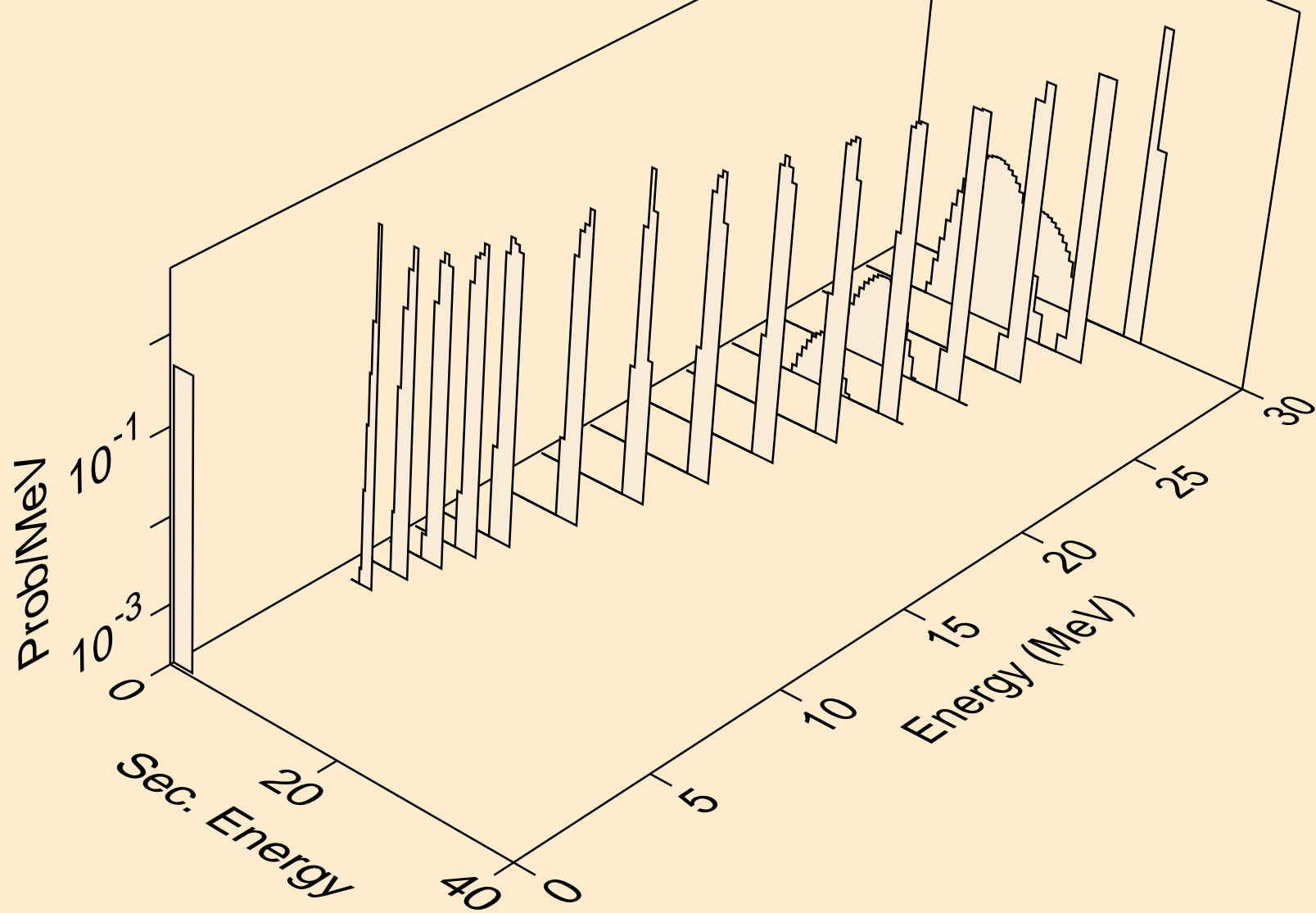

LR259 TRITON ACER TENDL-2021 LIBRARY; T=0.K  
he3s from (t,x)

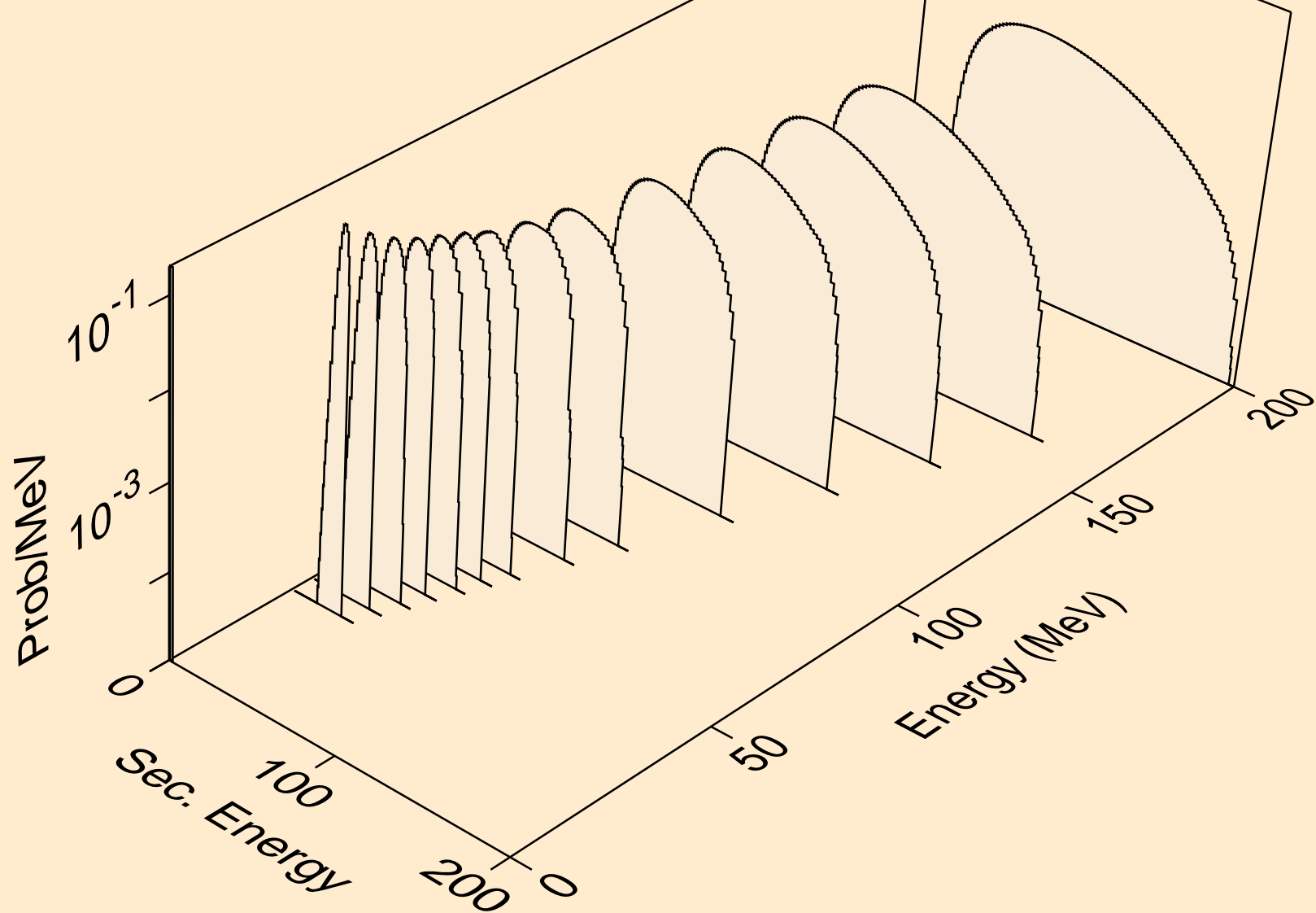

LR259 TRITON ACER TENDL-2021 LIBRARY; T=0.K  
he3s from (t,n\*)he3

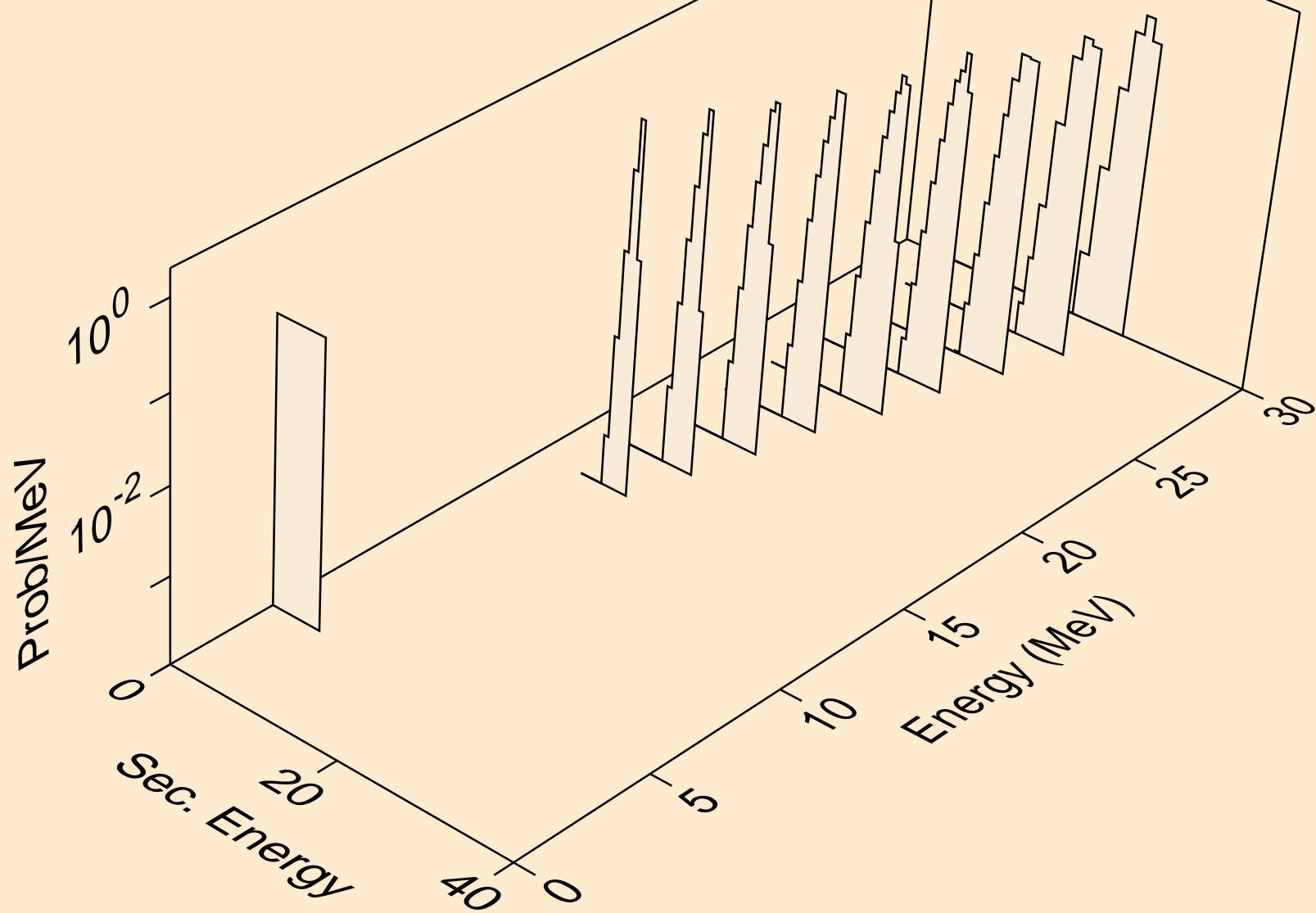

LR259 TRITON ACER TENDL-2021 LIBRARY; T=0.K  
he3s from (t,he3)

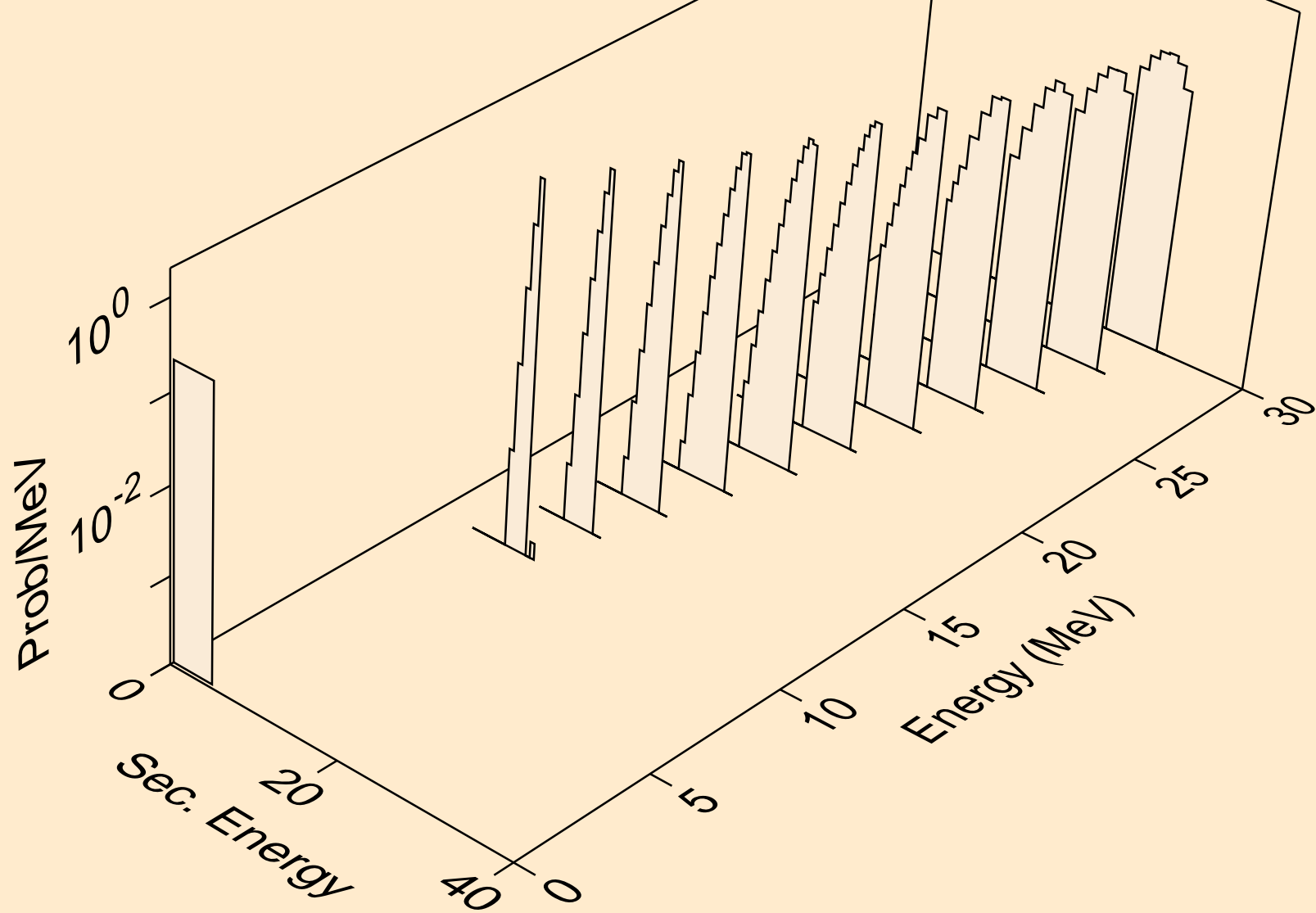

LR259 TRITON ACER TENDL-2021 LIBRARY; T=0.K  
alphas from (t,x)

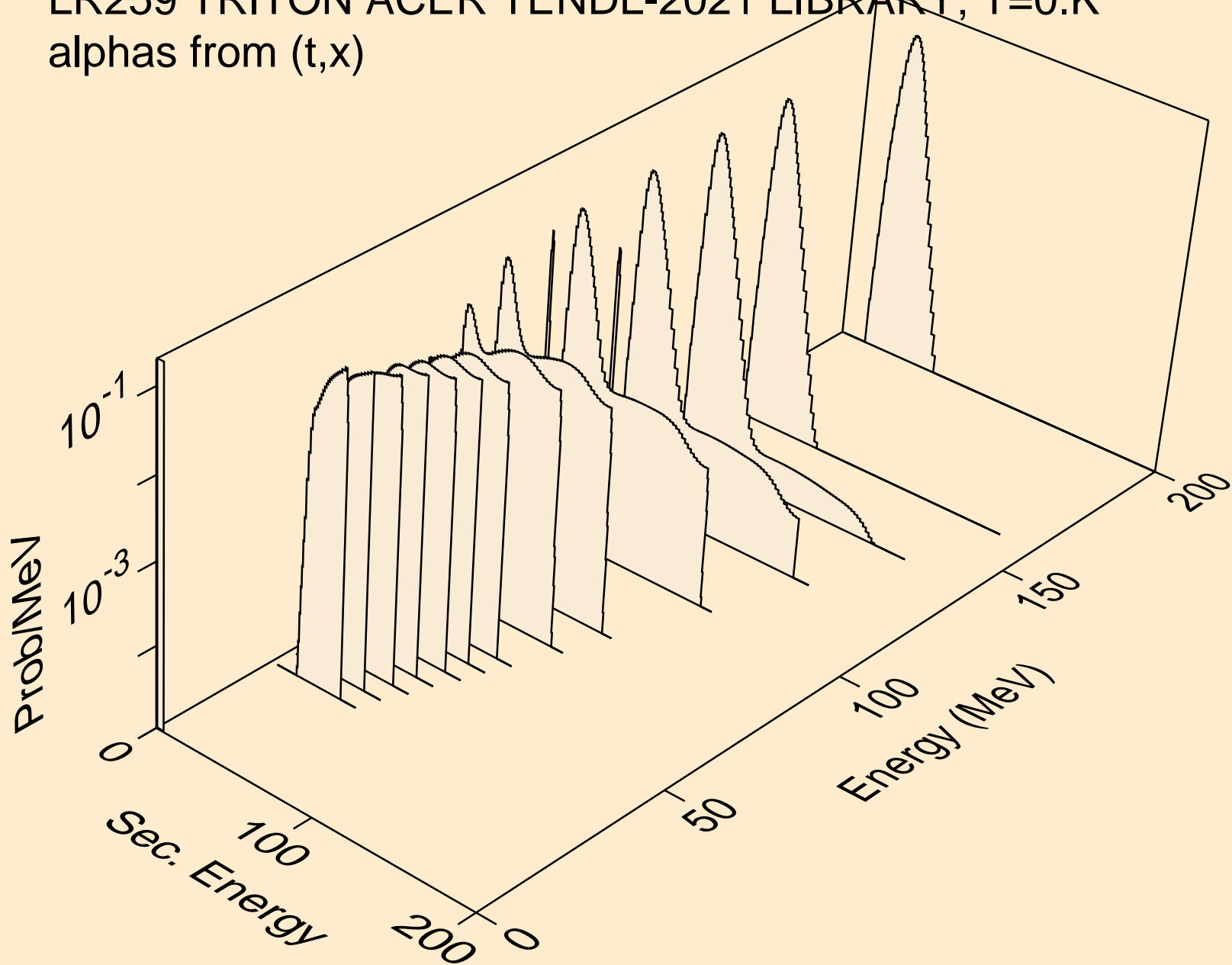

LR259 TRITON ACER TENDL-2021 LIBRARY; T=0.K  
alphas from (t,n\*)a

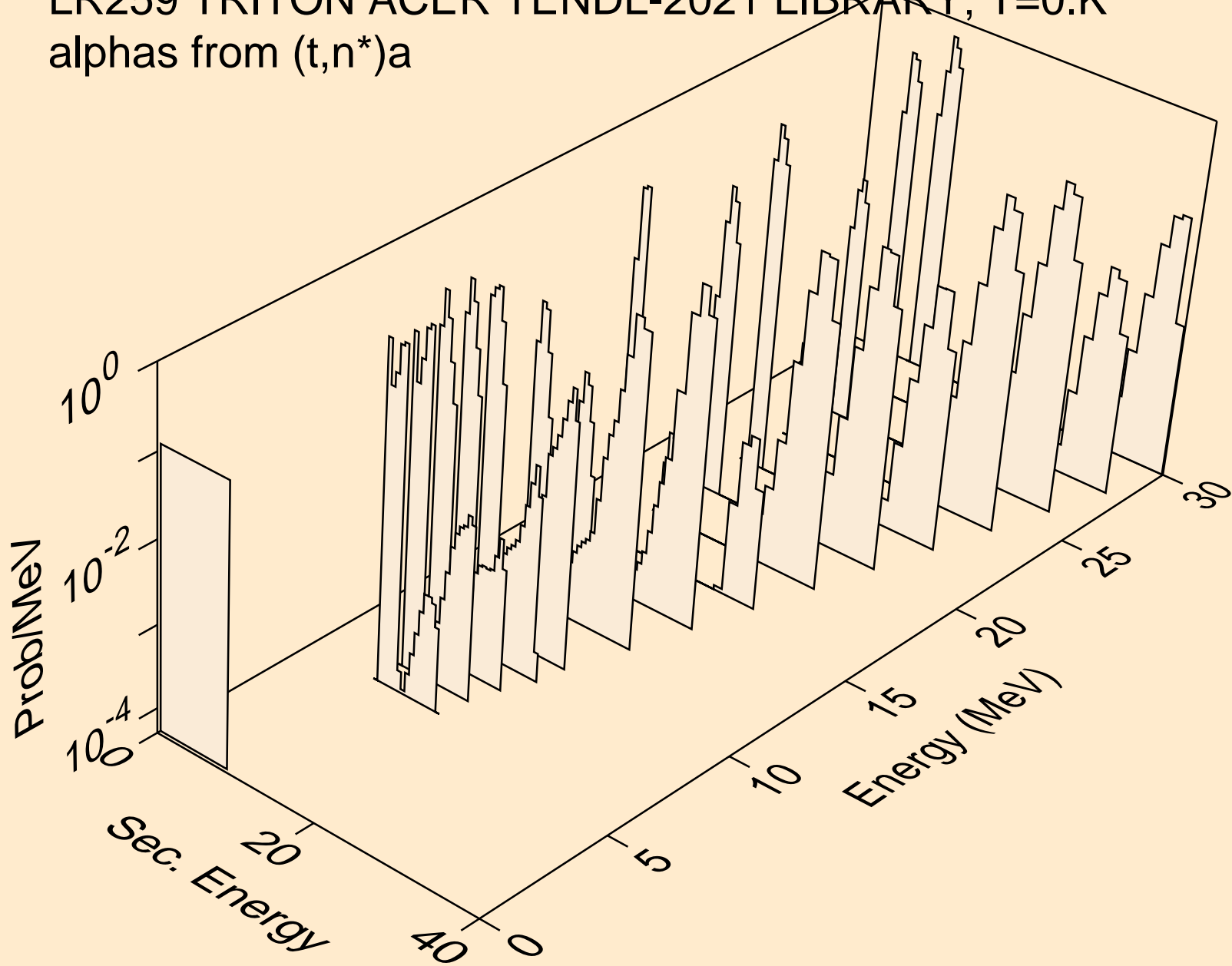

LR259 TRITON ACER TENDL-2021 LIBRARY; T=0.K  
alphas from (t,3n)a

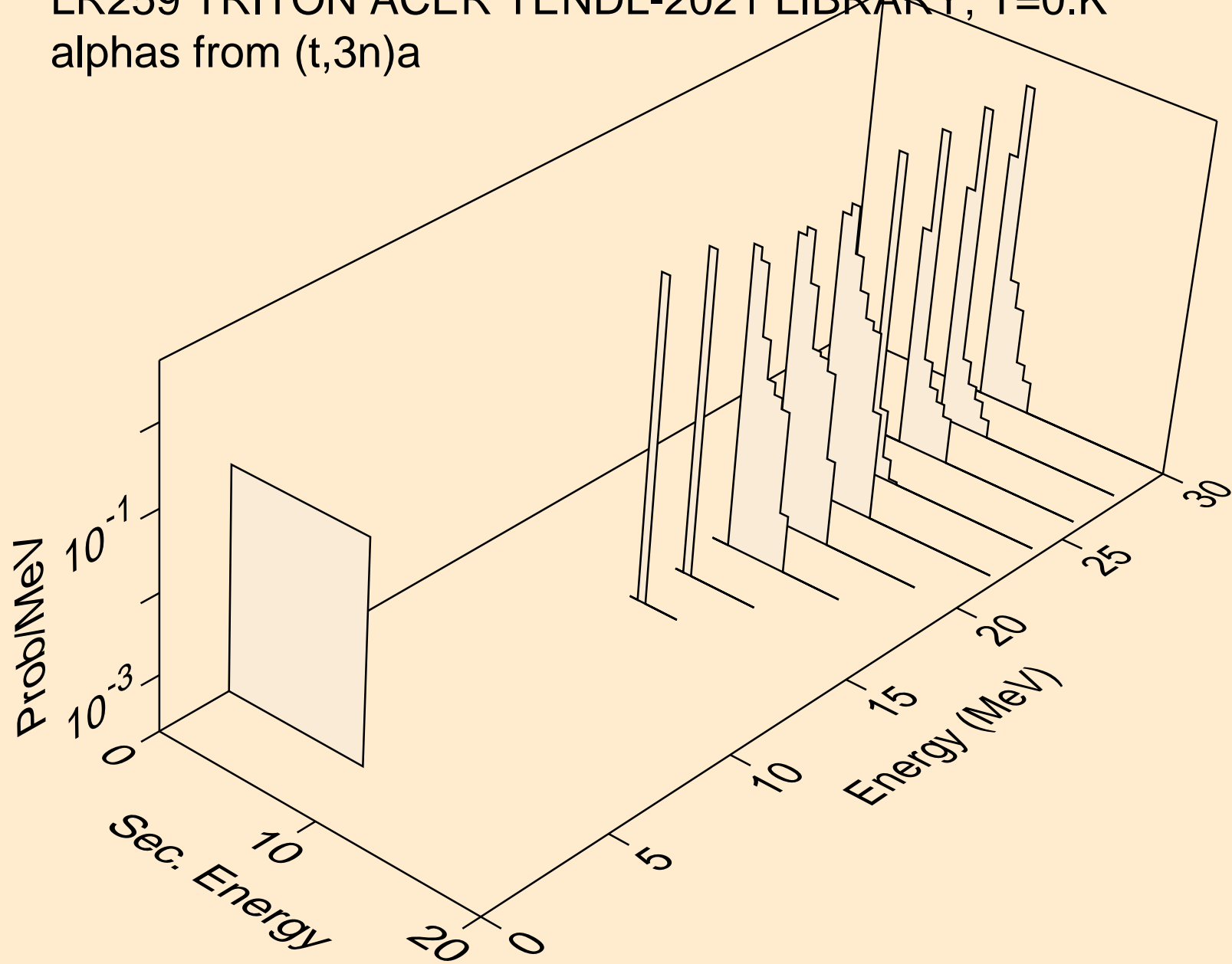

LR259 TRITON ACER TENDL-2021 LIBRARY; T=0.K  
alphas from (t,npa)

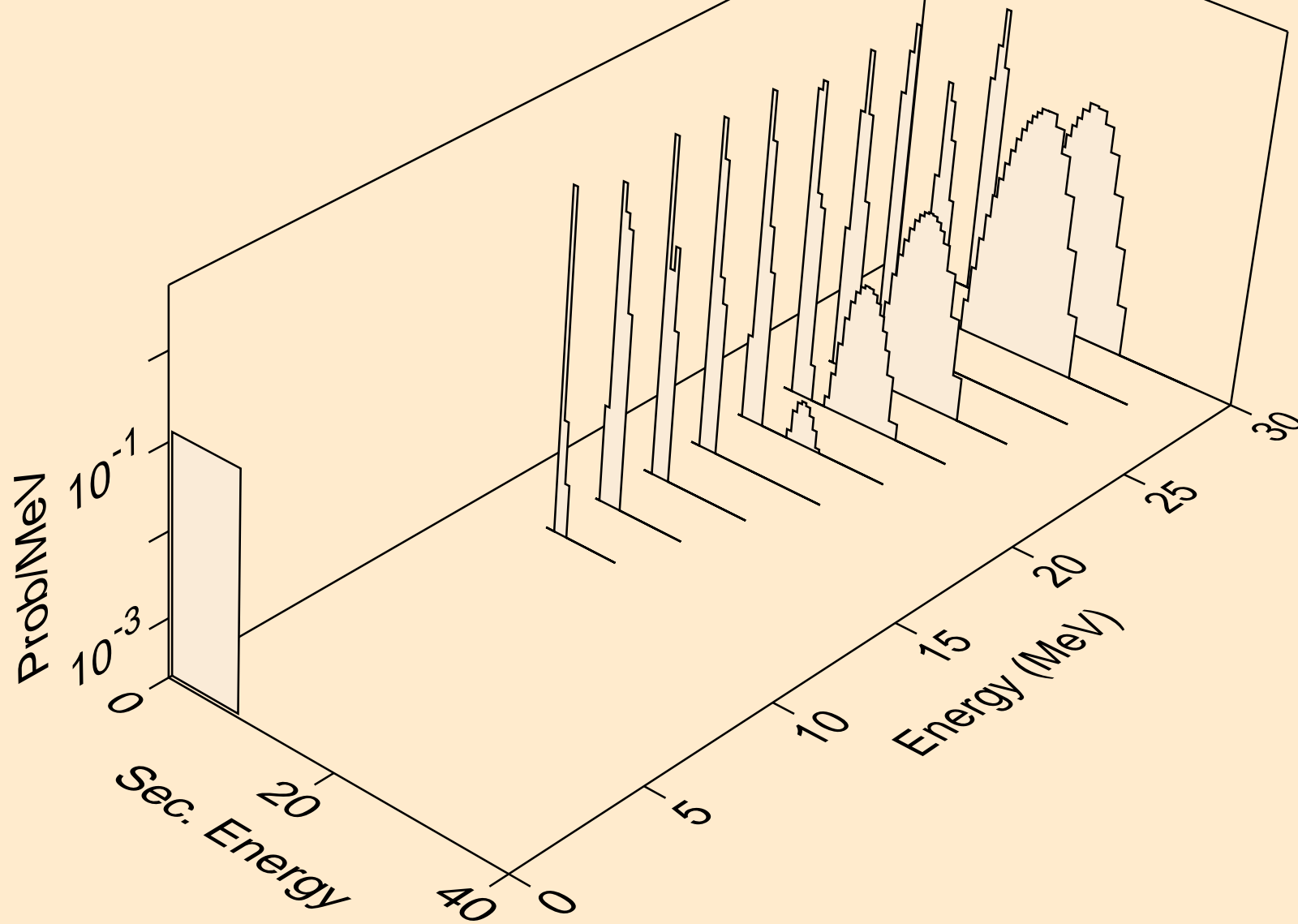



LR259 TRITON ACER TENDL-2021 LIBRARY; T=0.K  
alphas from (t,a)

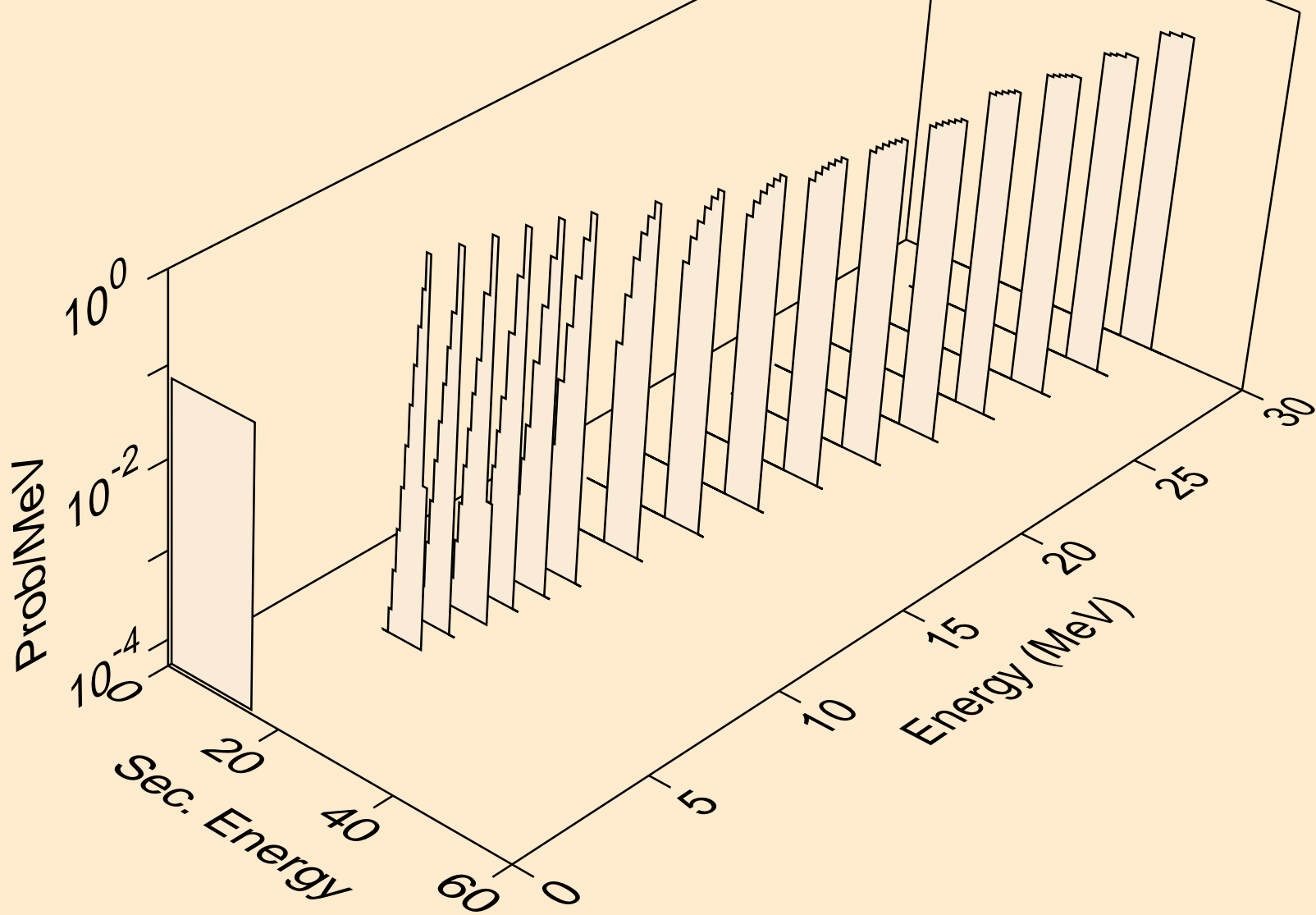

LR259 TRITON ACER TENDL-2021 LIBRARY; T=0.K  
alphas from (t,2a)

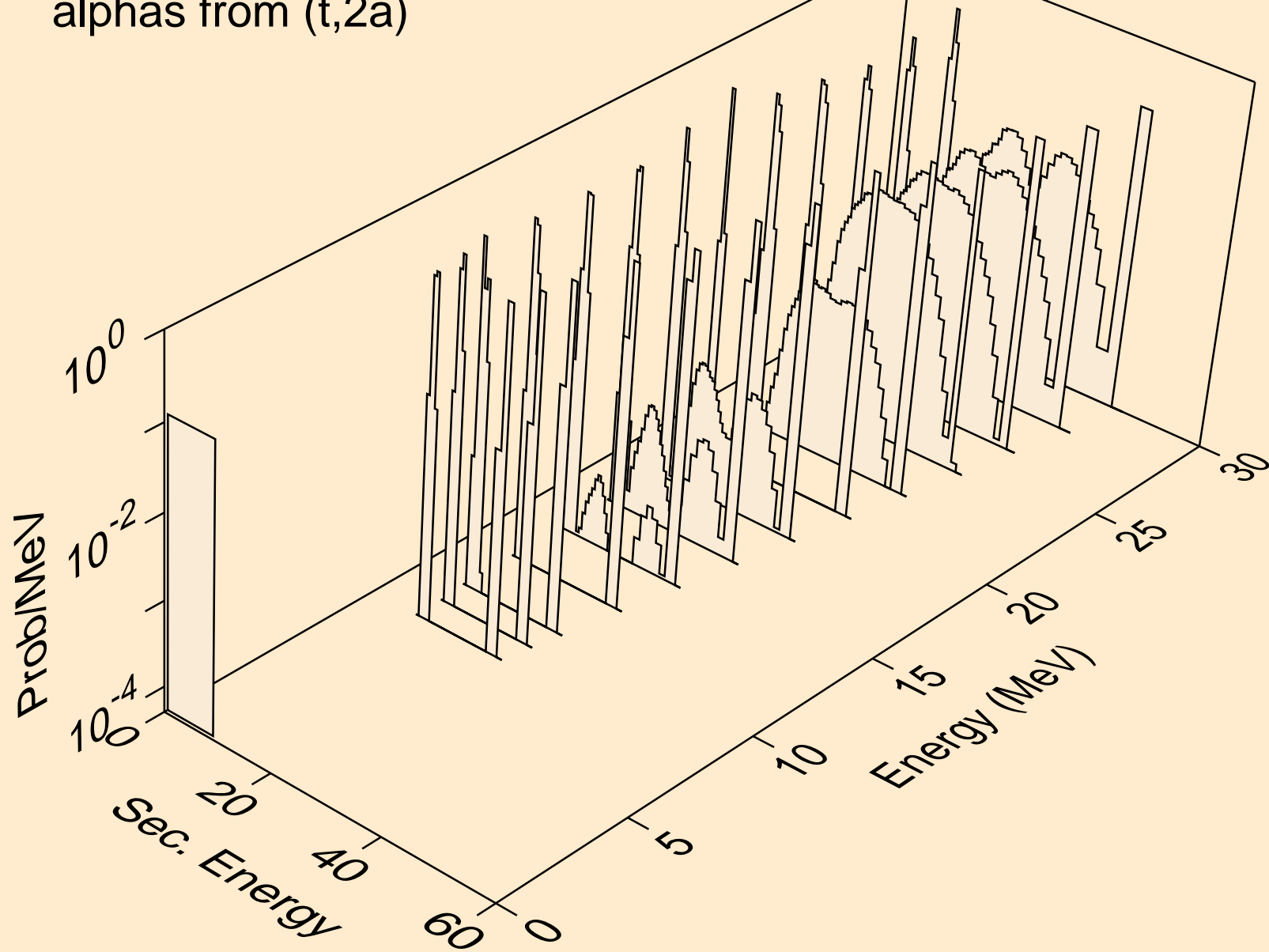

LR259 TRITON ACER TENDL-2021 LIBRARY; T=0.K  
alphas from (t,da)

