

MD246M TRITON ACER TENDL-2021 LIBRARY; T=0.K  
Principal cross sections

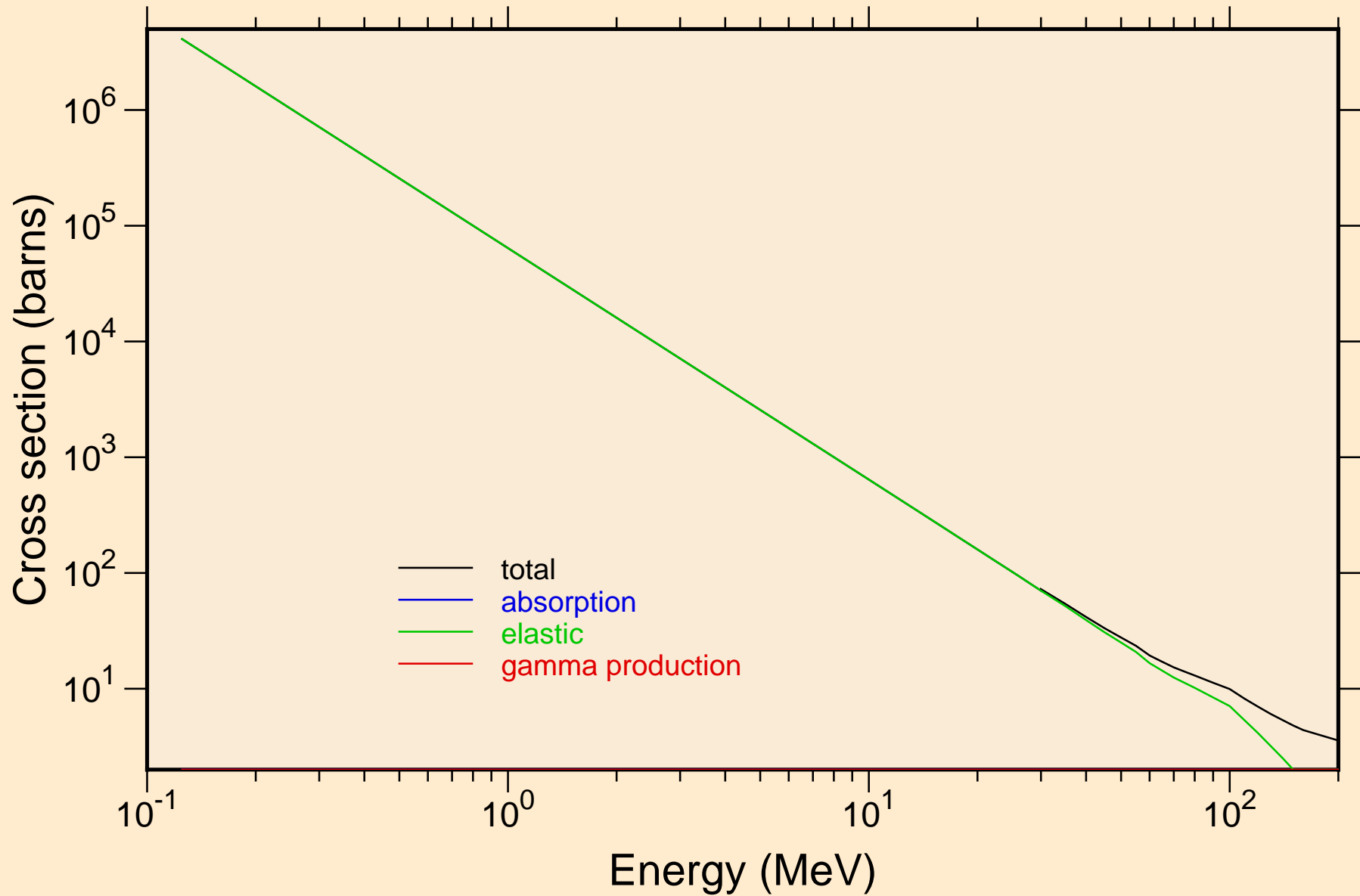

MD246M TRITON ACER TENDL-2021 LIBRARY; T=0.K

Heating

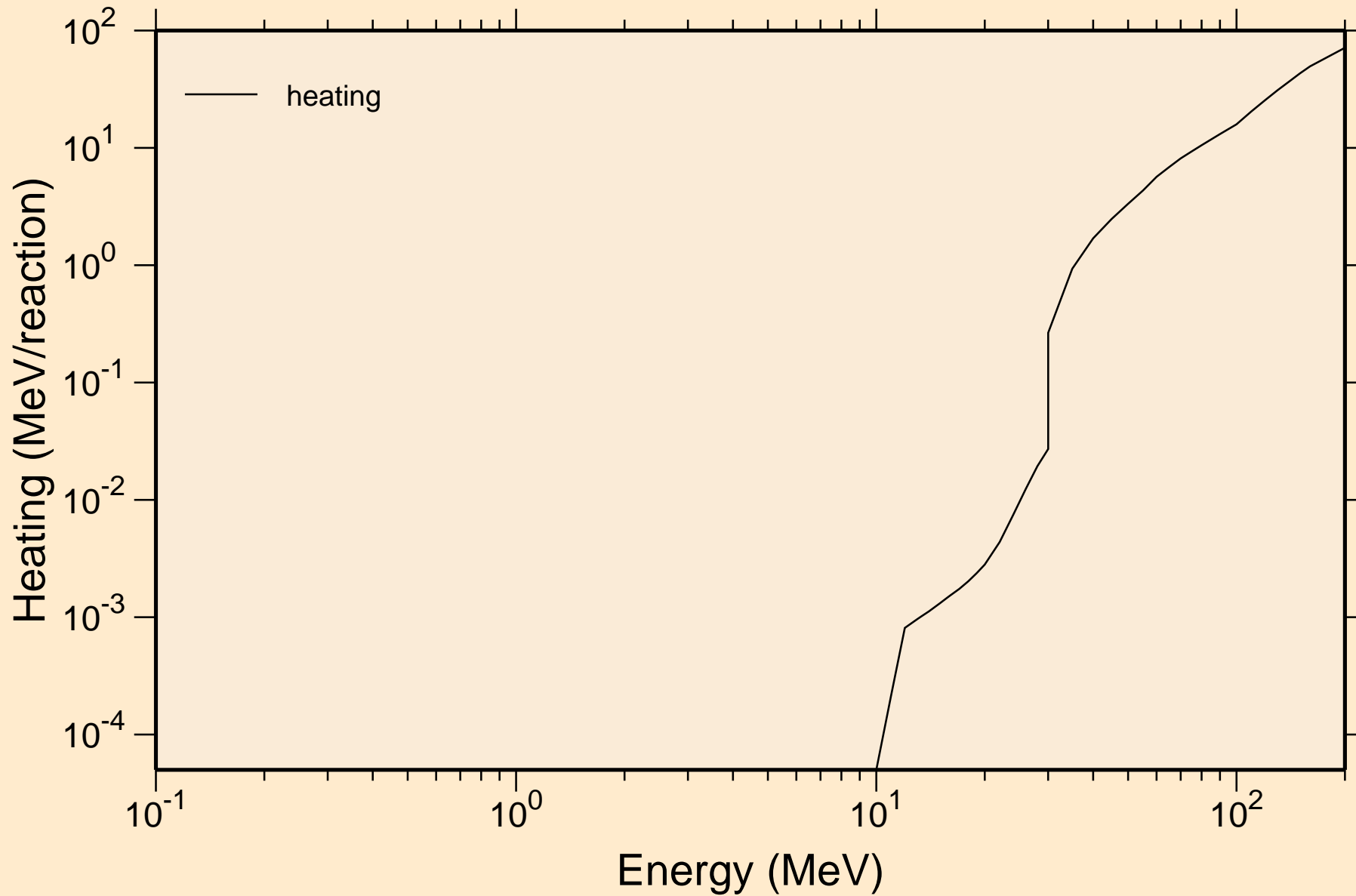

# MD246M TRITON ACER TENDL-2021 LIBRARY; T=0.K

## Principal cross sections

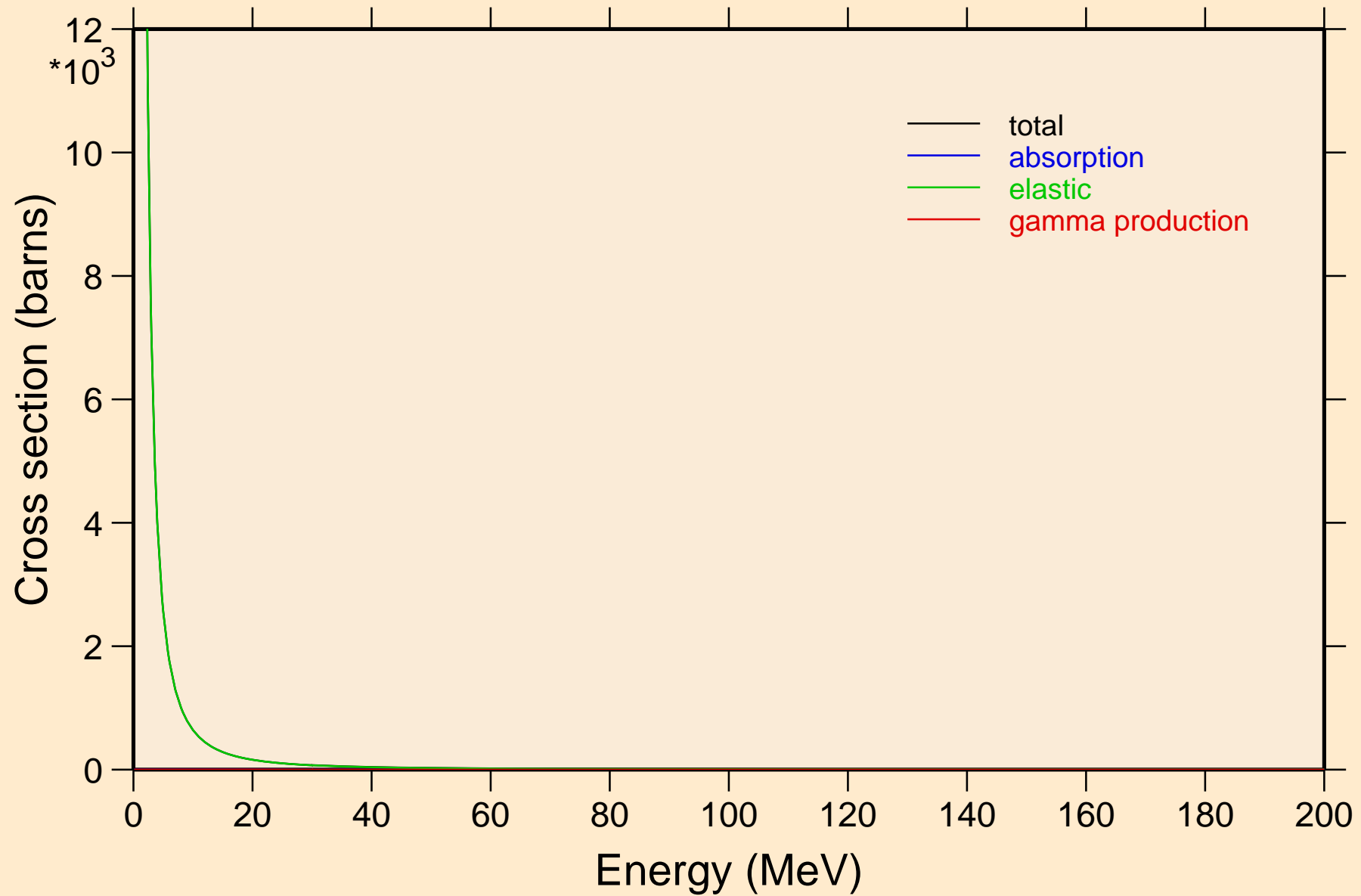

MD246M TRITON ACER TENDL-2021 LIBRARY; T=0.K

Heating

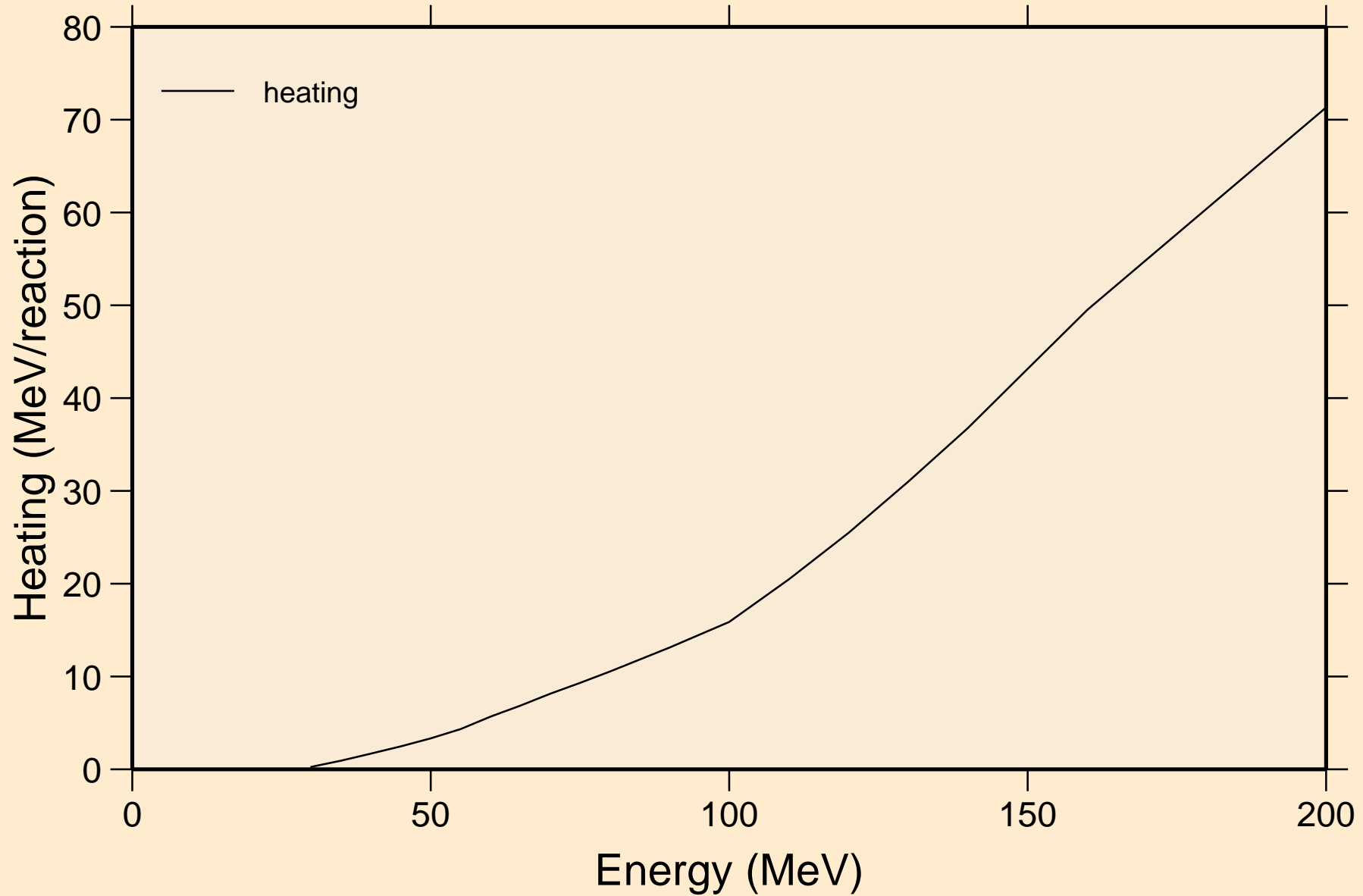

MD246M TRITON ACER TENDL-2021 LIBRARY; T=0.K  
Threshold reactions

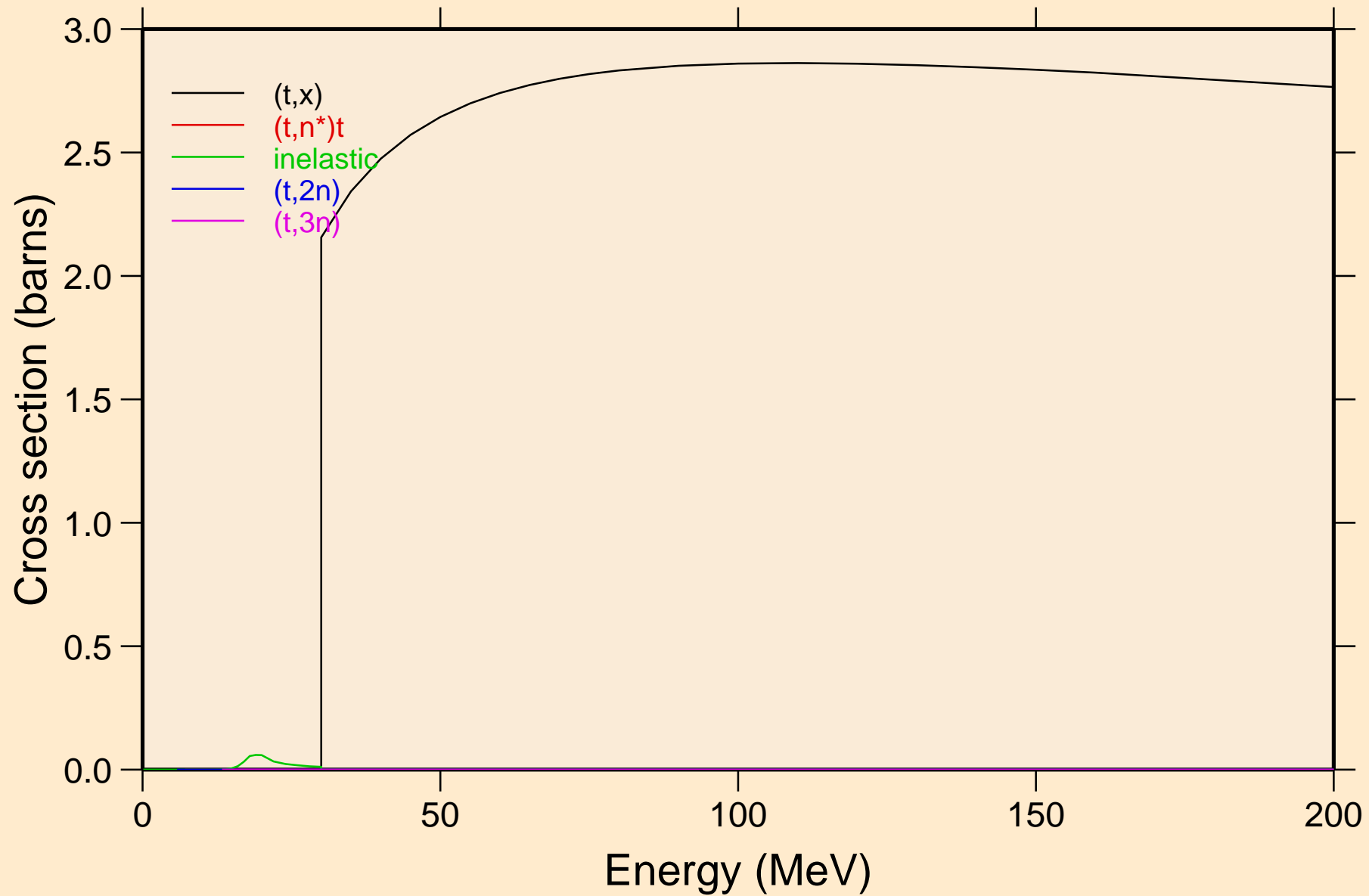

MD246M TRITON ACER TENDL-2021 LIBRARY; T=0.K  
Threshold reactions

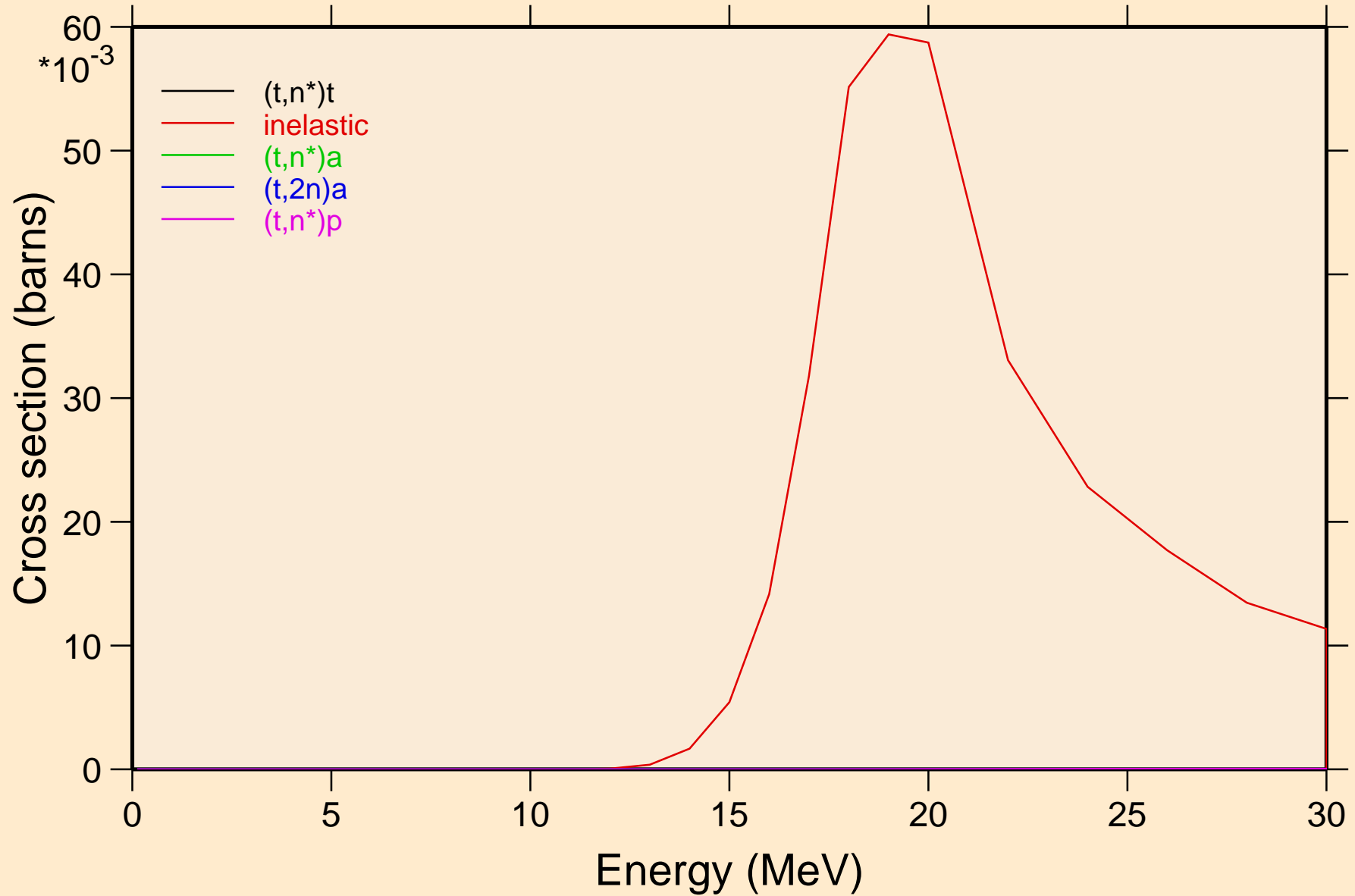

MD246M TRITON ACER TENDL-2021 LIBRARY; T=0.K  
Threshold reactions

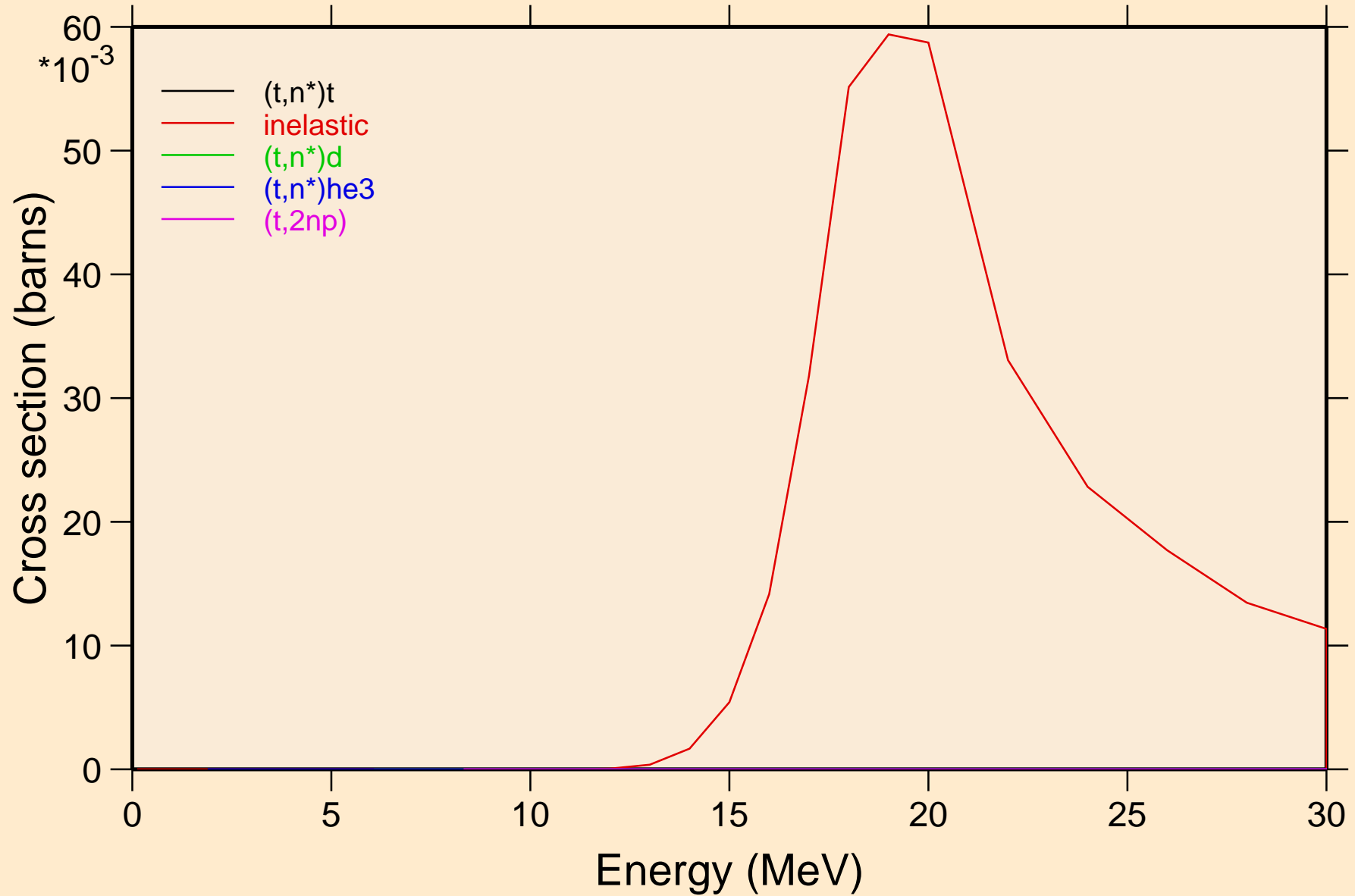

MD246M TRITON ACER TENDL-2021 LIBRARY; T=0.K  
Threshold reactions

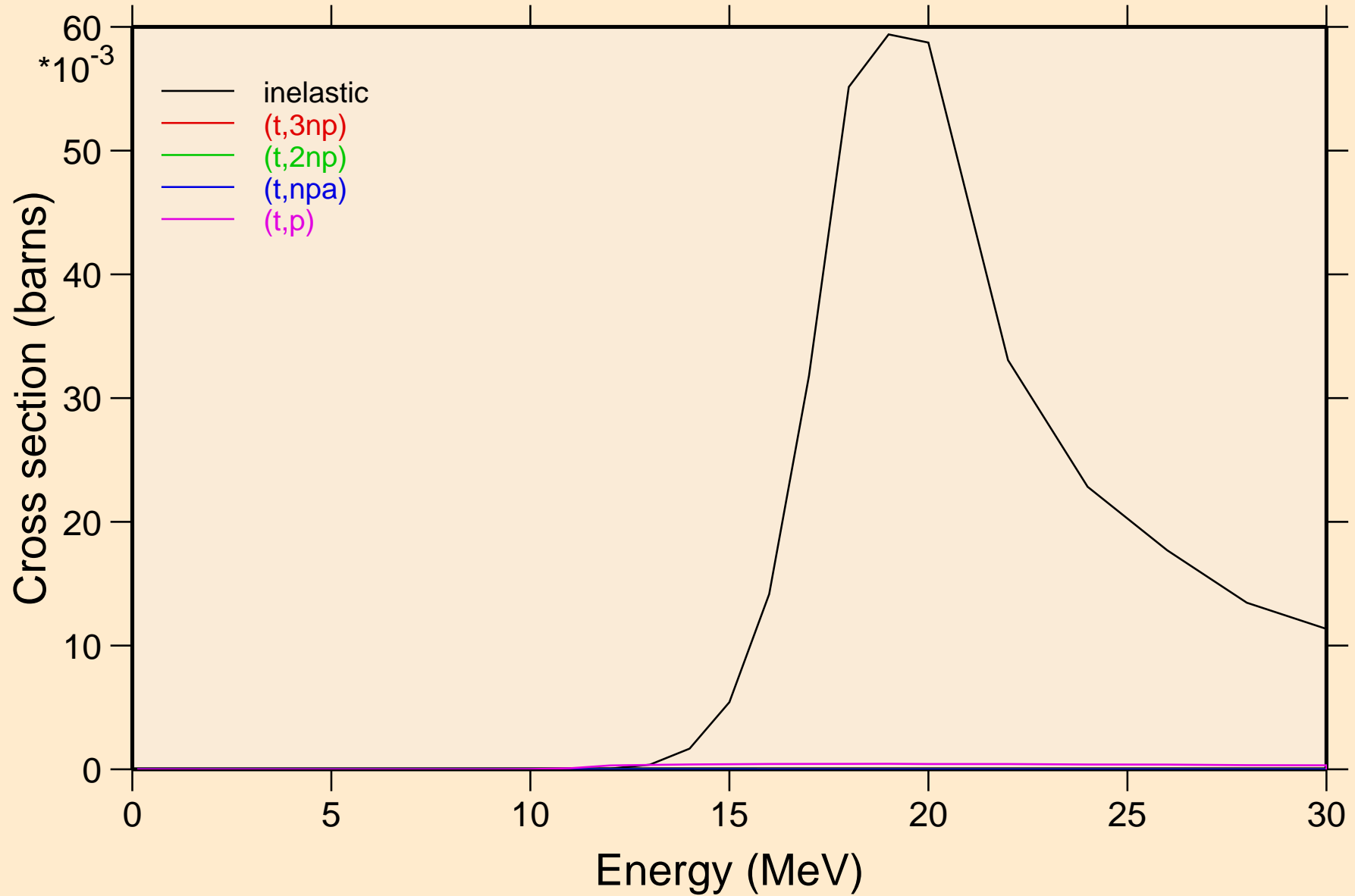



MD246M TRITON ACER TENDL-2021 LIBRARY; T=0.K  
Threshold reactions

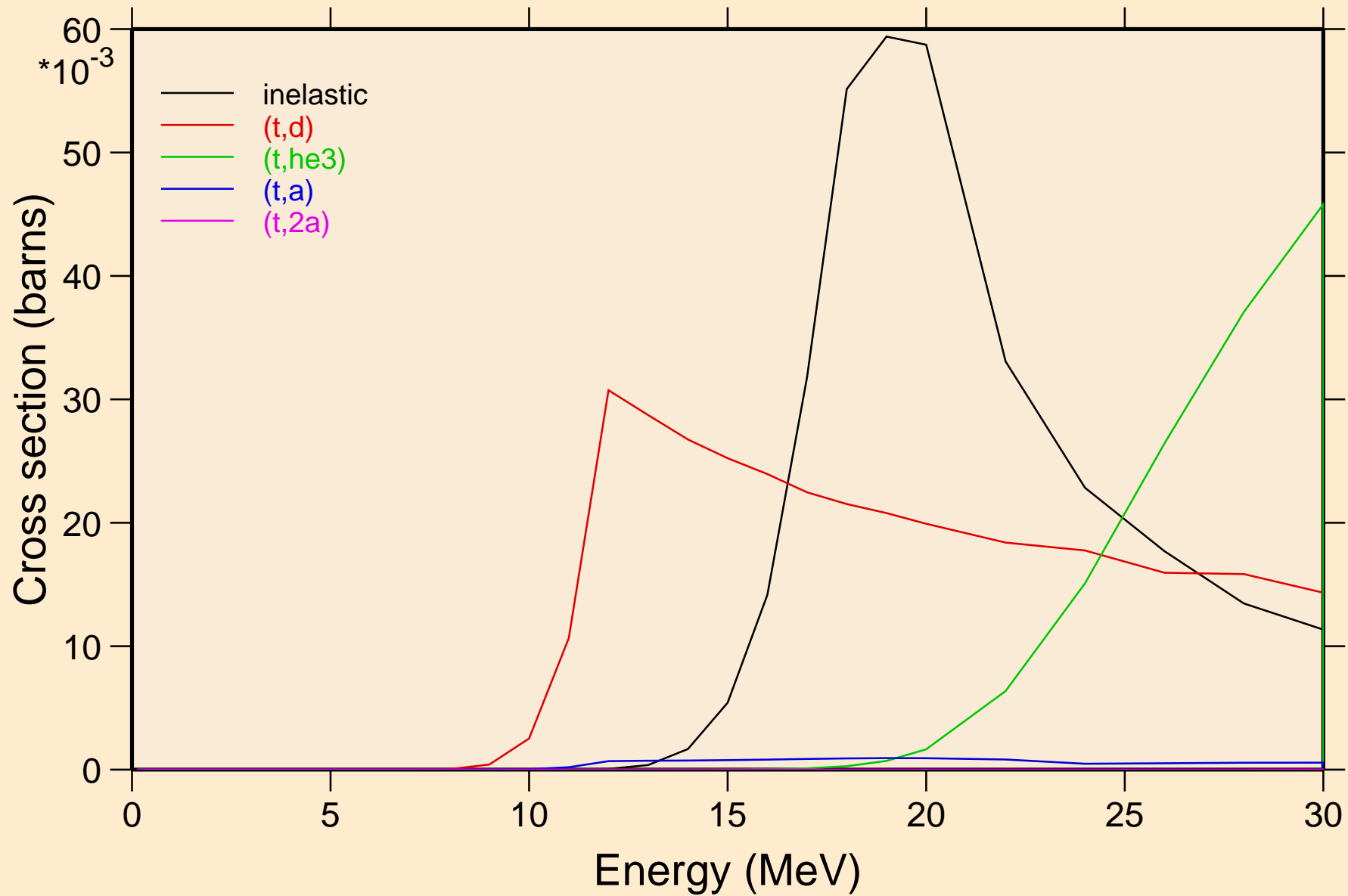

MD246M TRITON ACER TENDL-2021 LIBRARY; T=0.K  
Threshold reactions

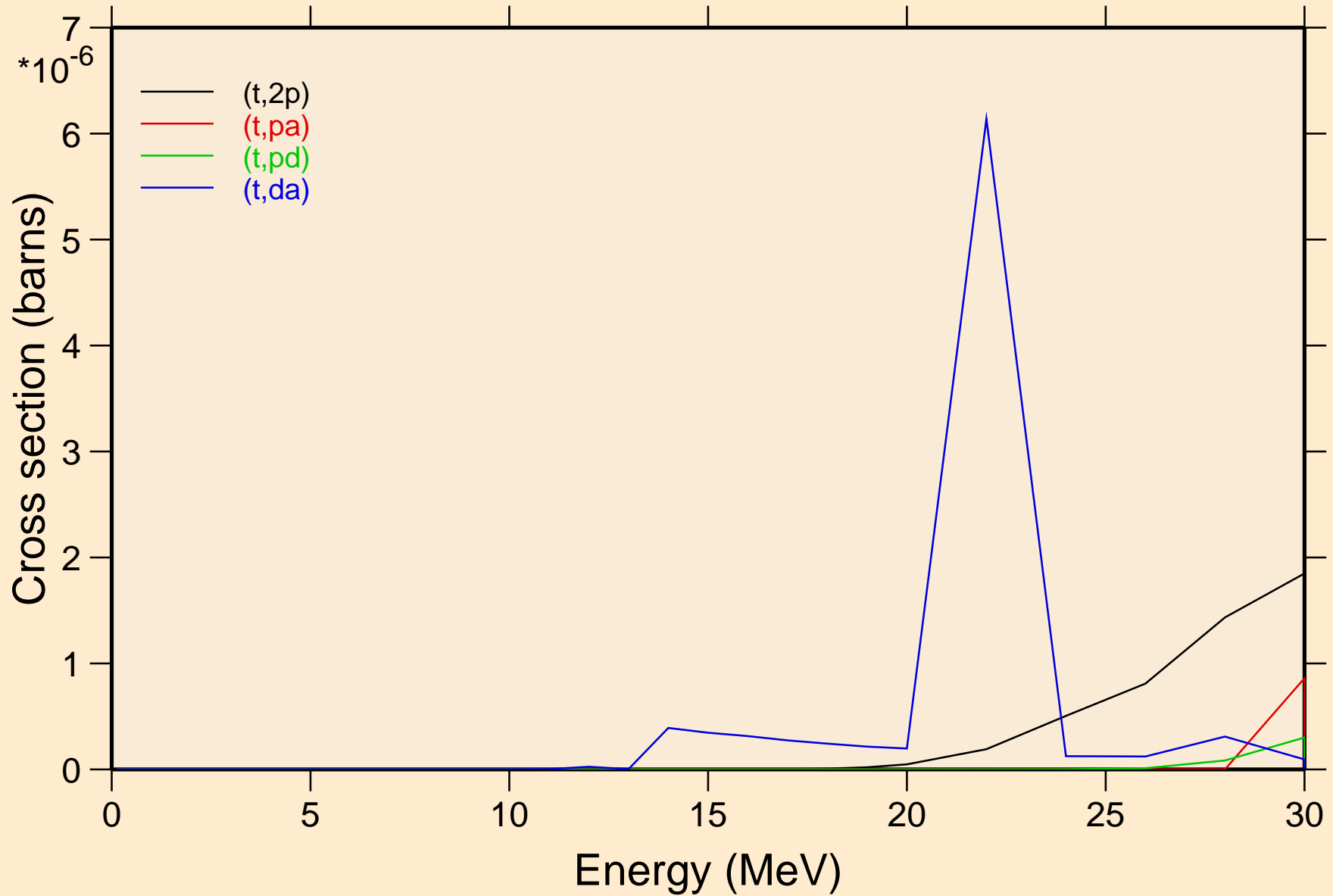

MD246M TRITON ACER TENDL-2021 LIBRARY; T=0.K  
angular distribution for elastic

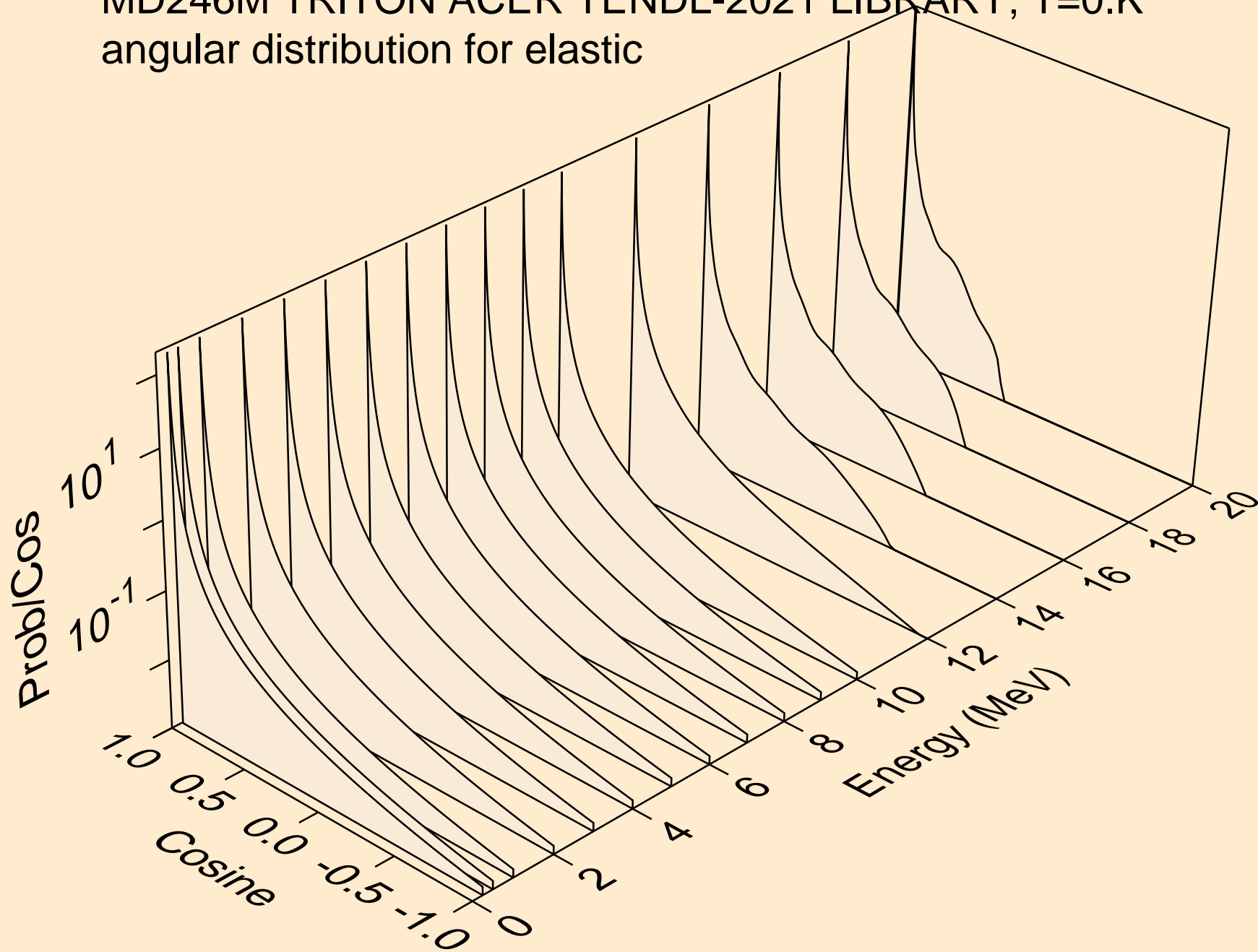

MD246M TRITON ACER TENDL-2021 LIBRARY; T=0.K  
angular distribution for elastic

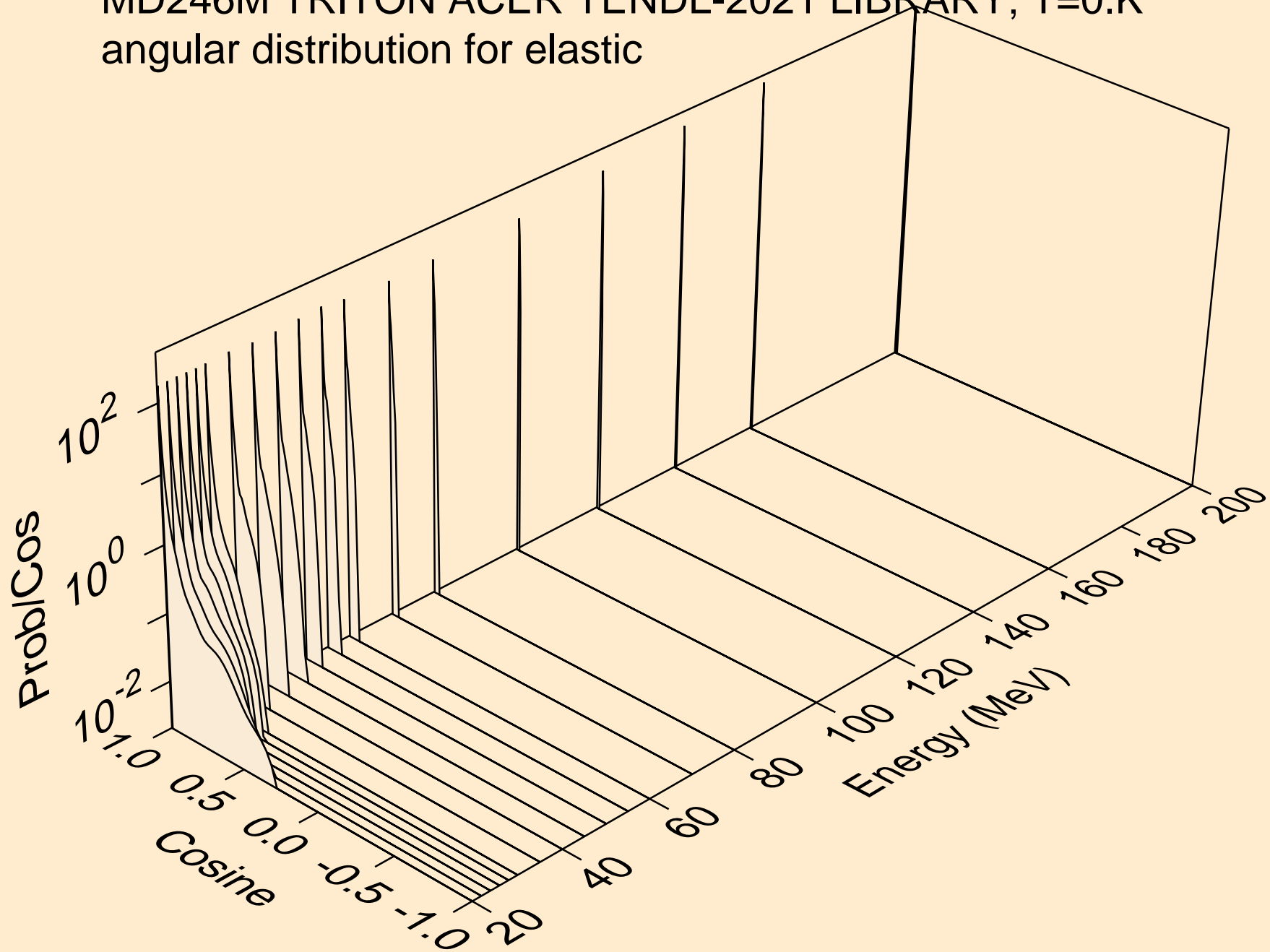

MD246M TRITON ACER TENDL-2021 LIBRARY; T=0.K  
Triton emission for (t,x)

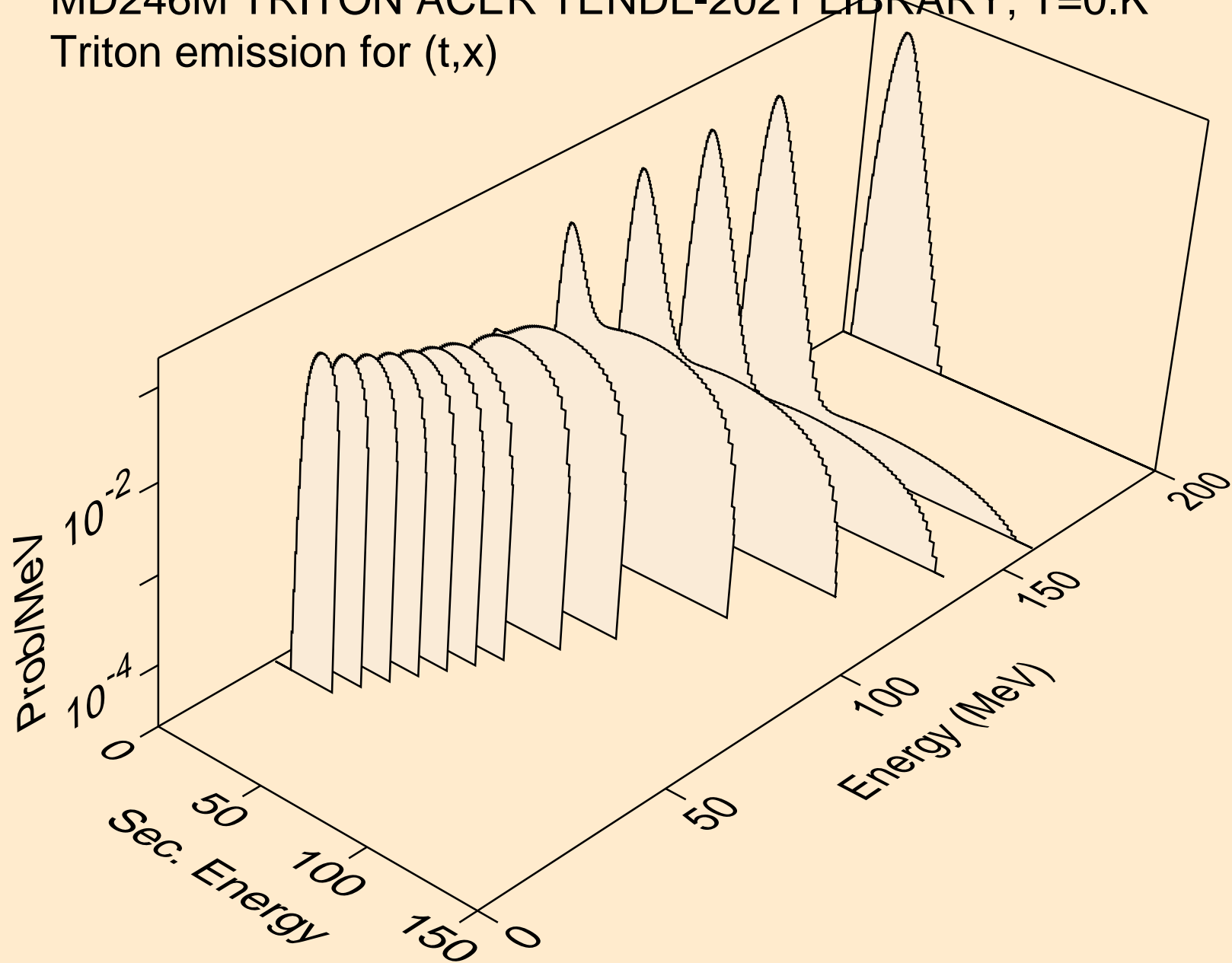

MD246M TRITON ACER TENDL-2021 LIBRARY; T=0.K  
Triton emission for (t,n\*)t

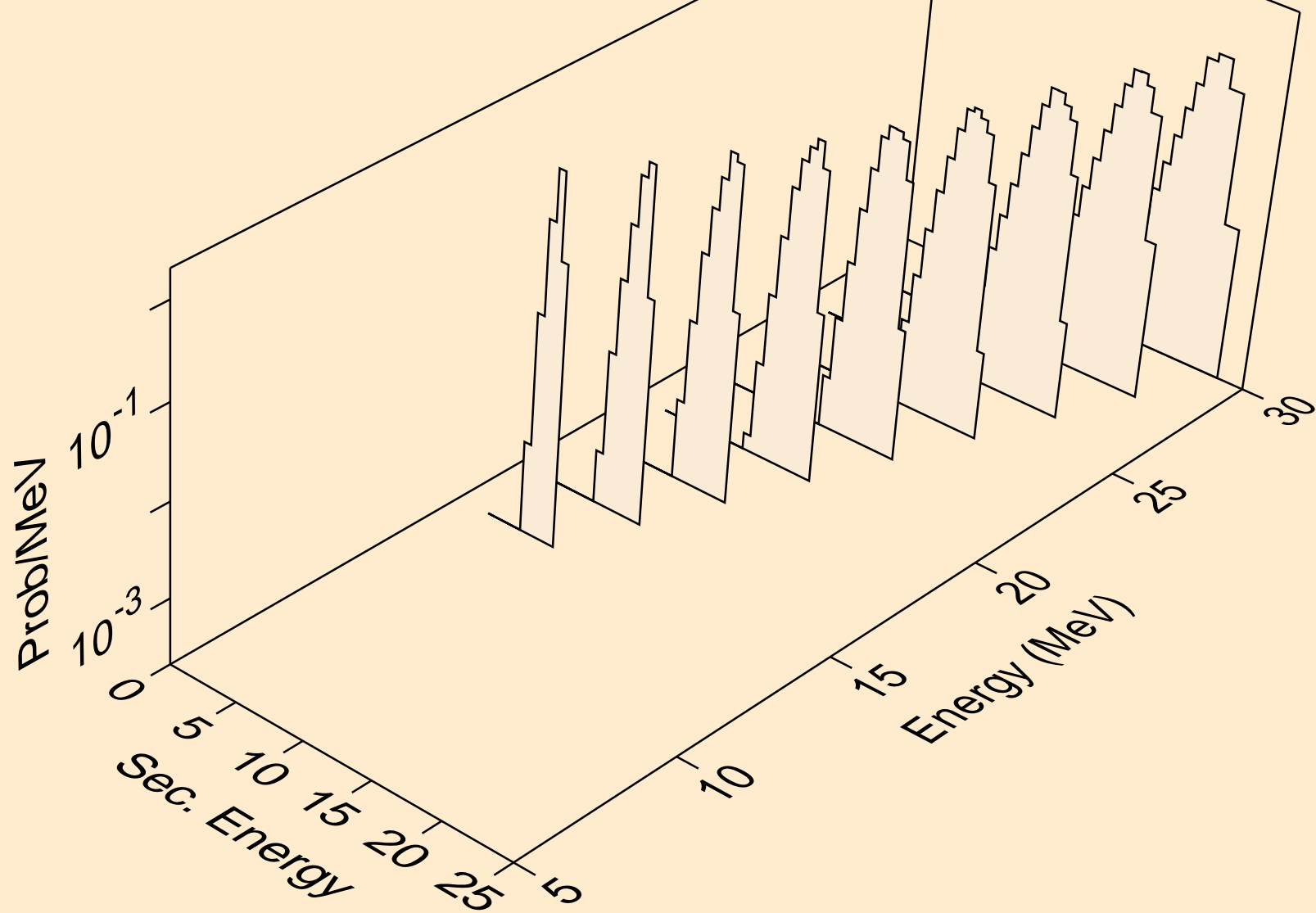

MD246M TRITON ACER TENDL-2021 LIBRARY; T=0.K  
Triton emission for inelastic

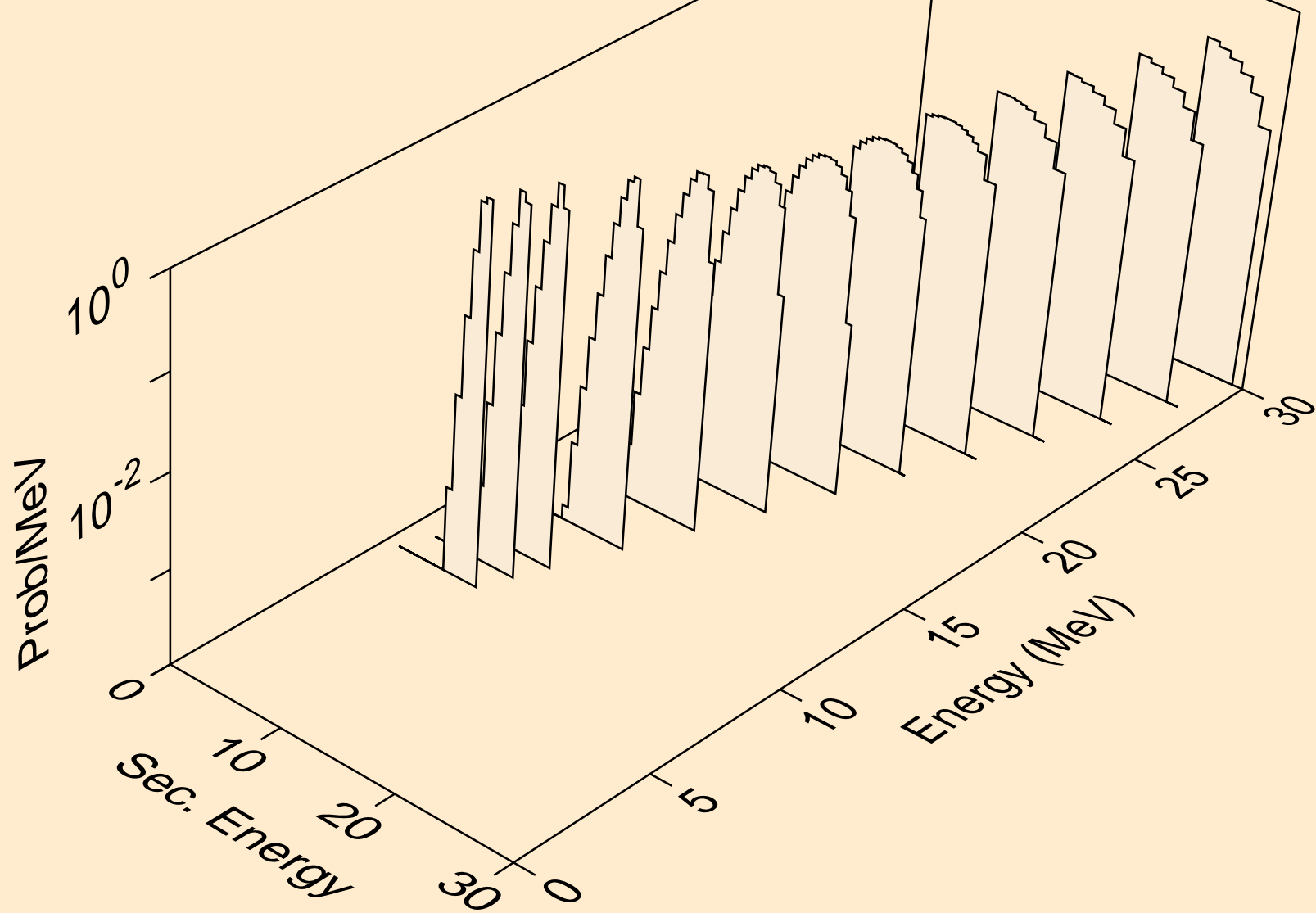

MD246M TRITON ACER TENDL-2021 LIBRARY; T=0.K  
Photon emission for (z,n)

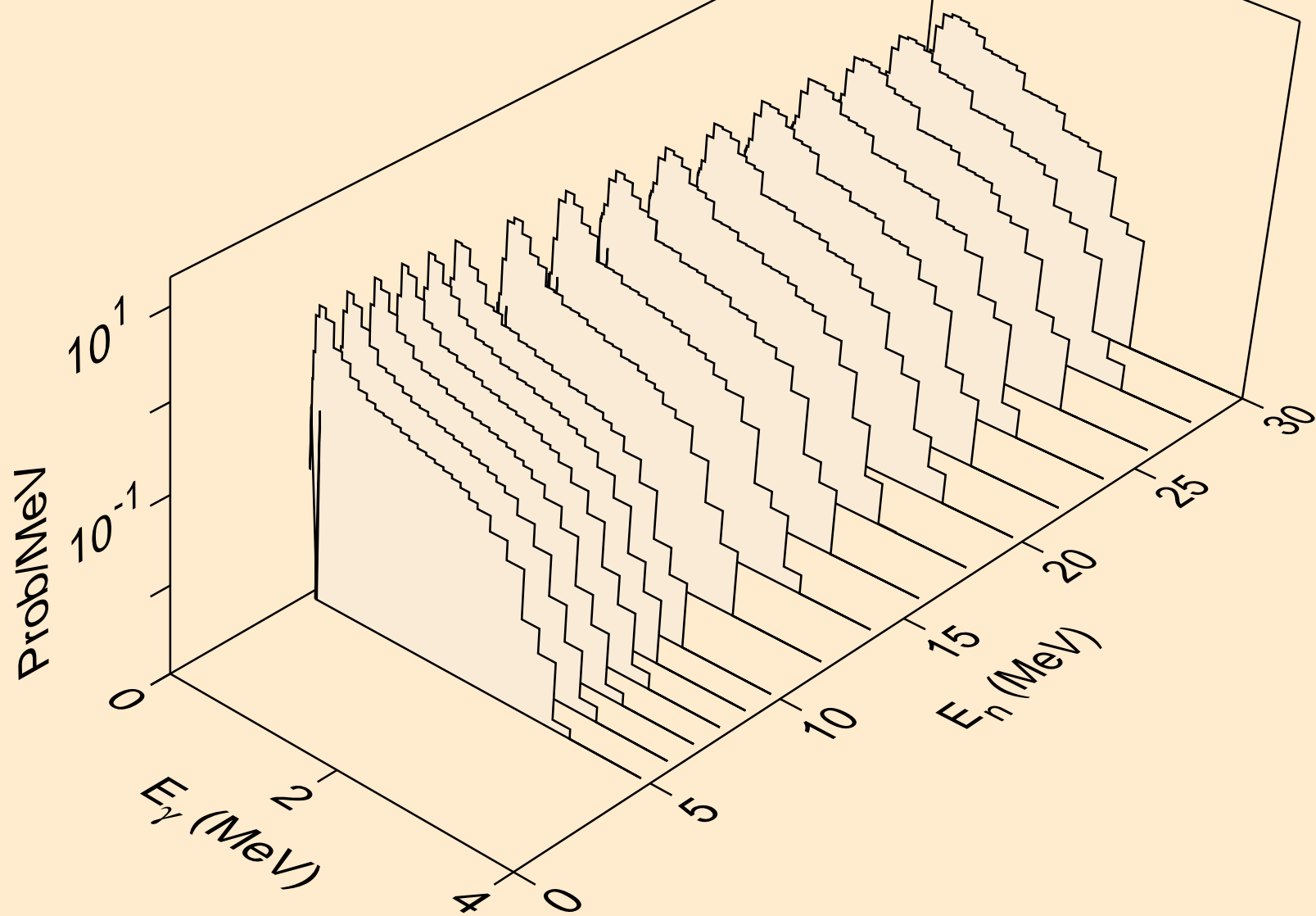



MD246M TRITON ACER TENDL-2021 LIBRARY; T=0.K  
Photon emission for (n,x)

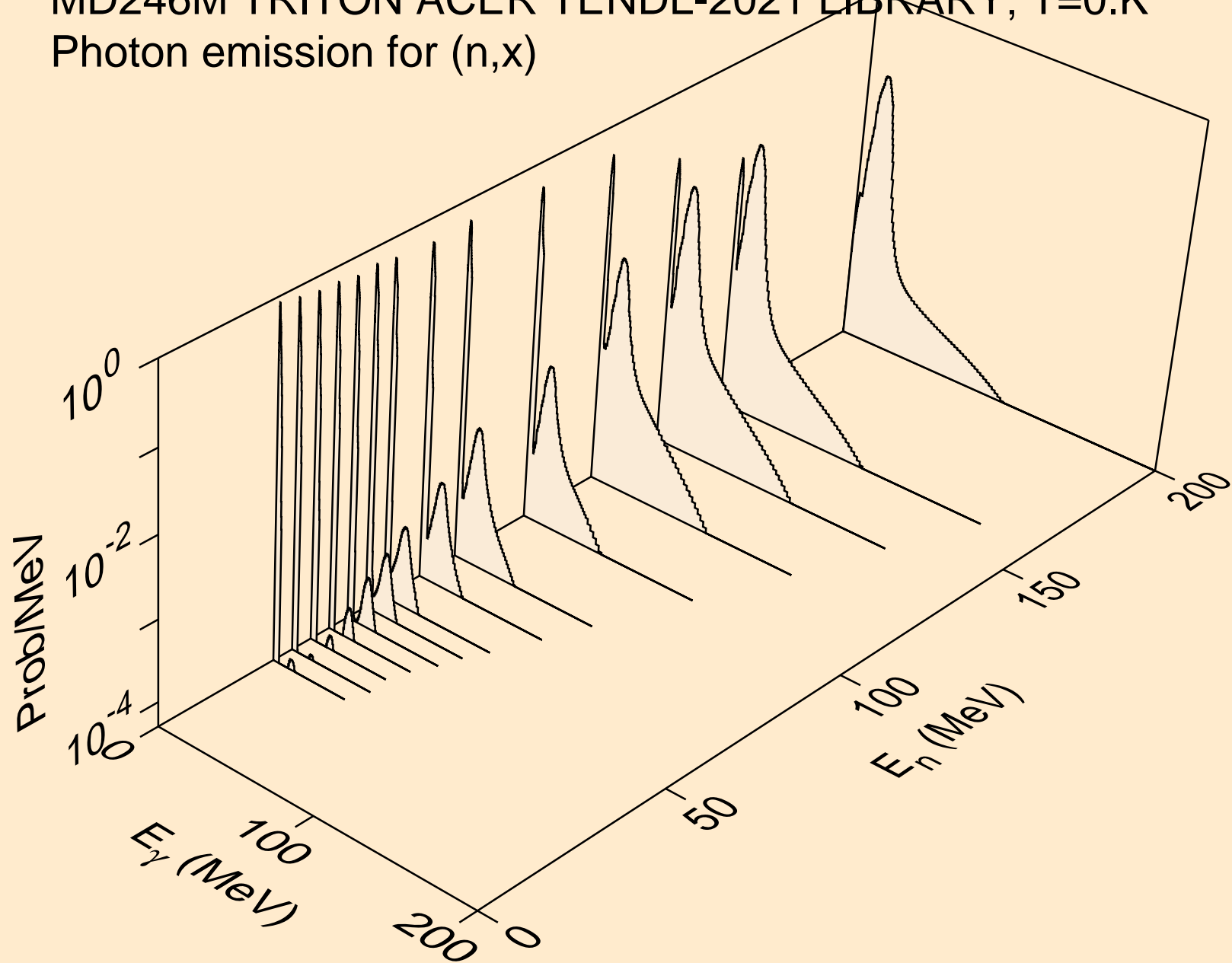

MD246M TRITON ACER TENDL-2021 LIBRARY; T=0.K  
Photon emission for (n,2n)

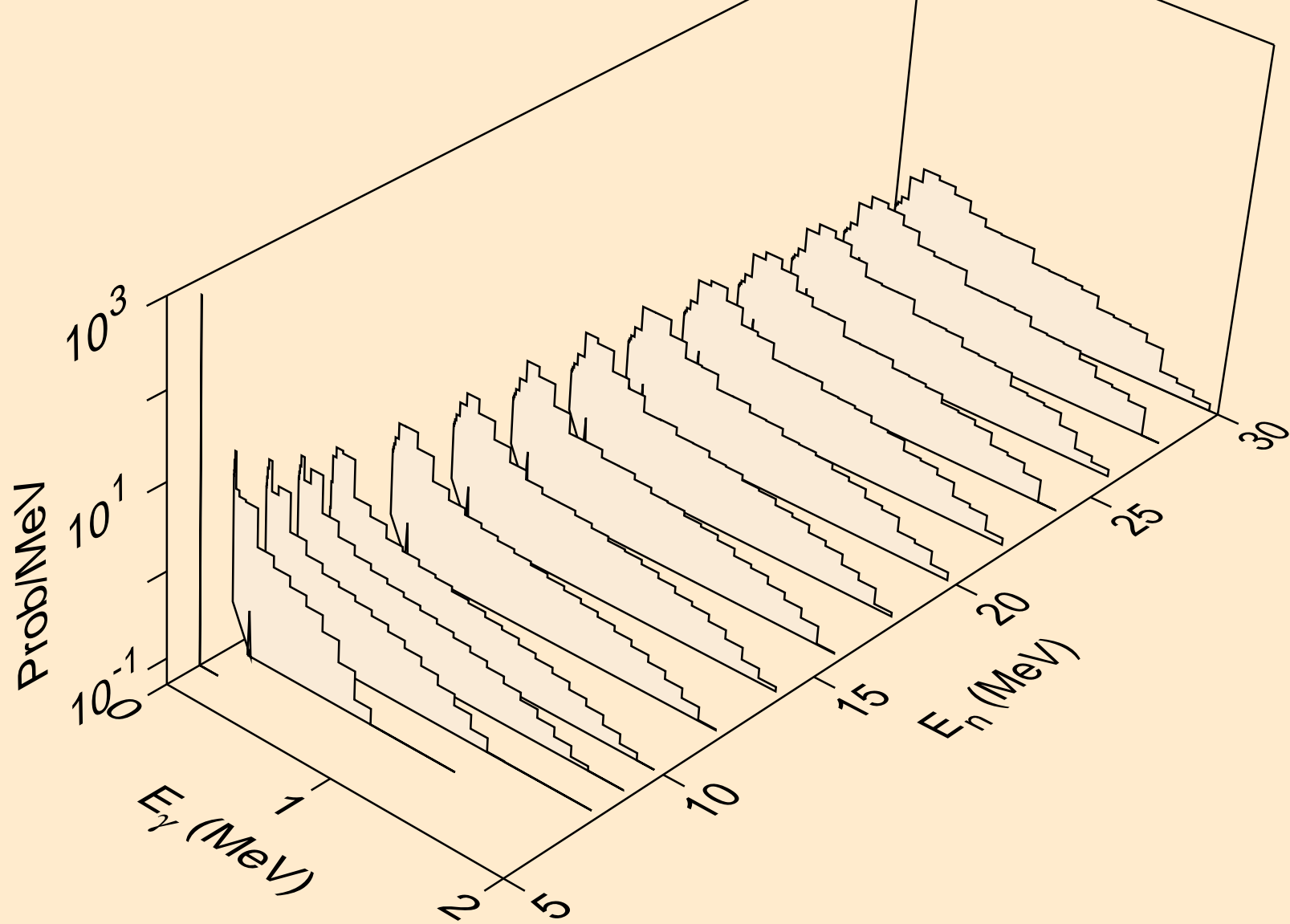

MD246M TRITON ACER TENDL-2021 LIBRARY; T=0.K  
Photon emission for (n,3n)

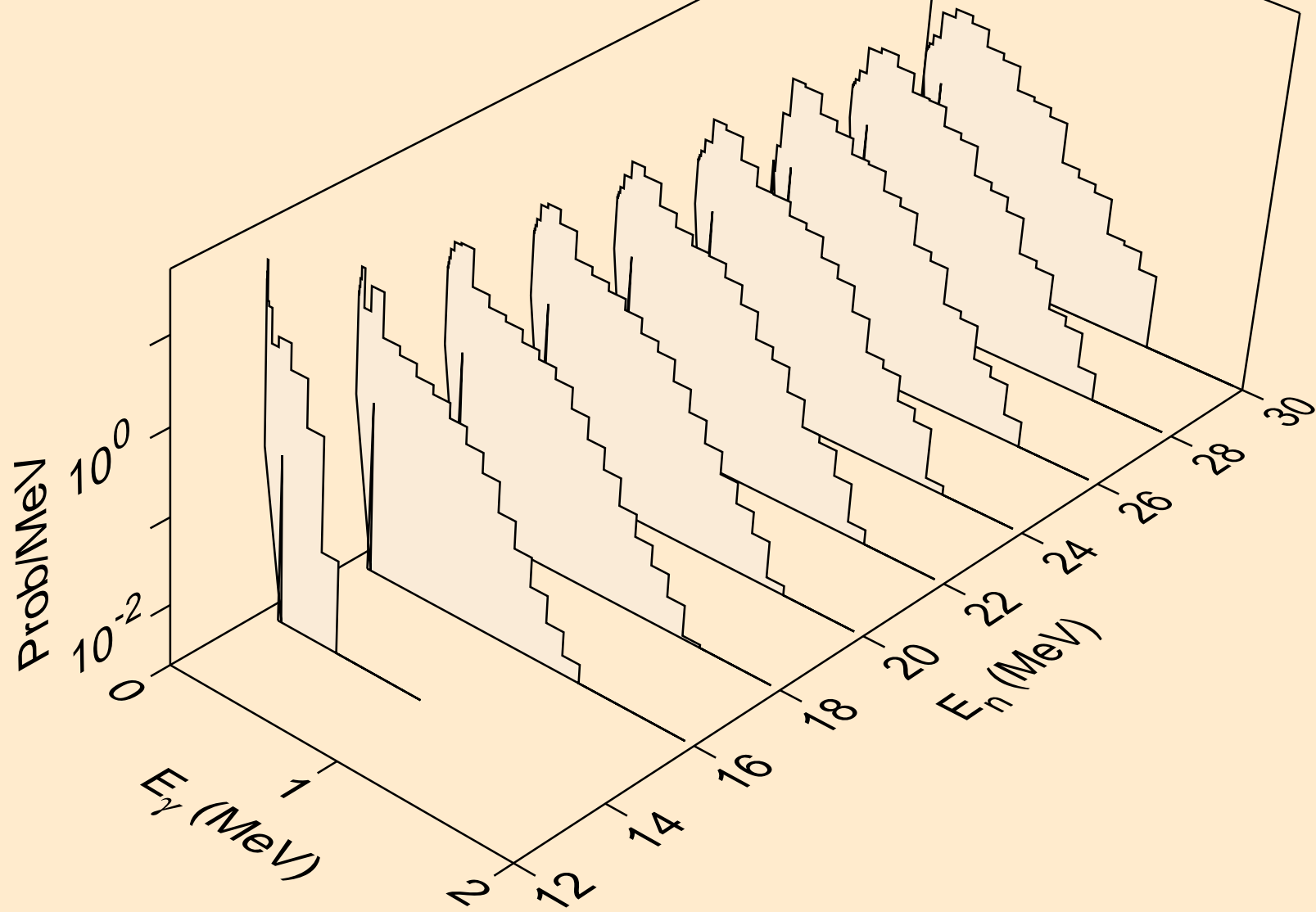

MD246M TRITON ACER TENDL-2021 LIBRARY; T=0.K  
Photon emission for (n,n\*)a

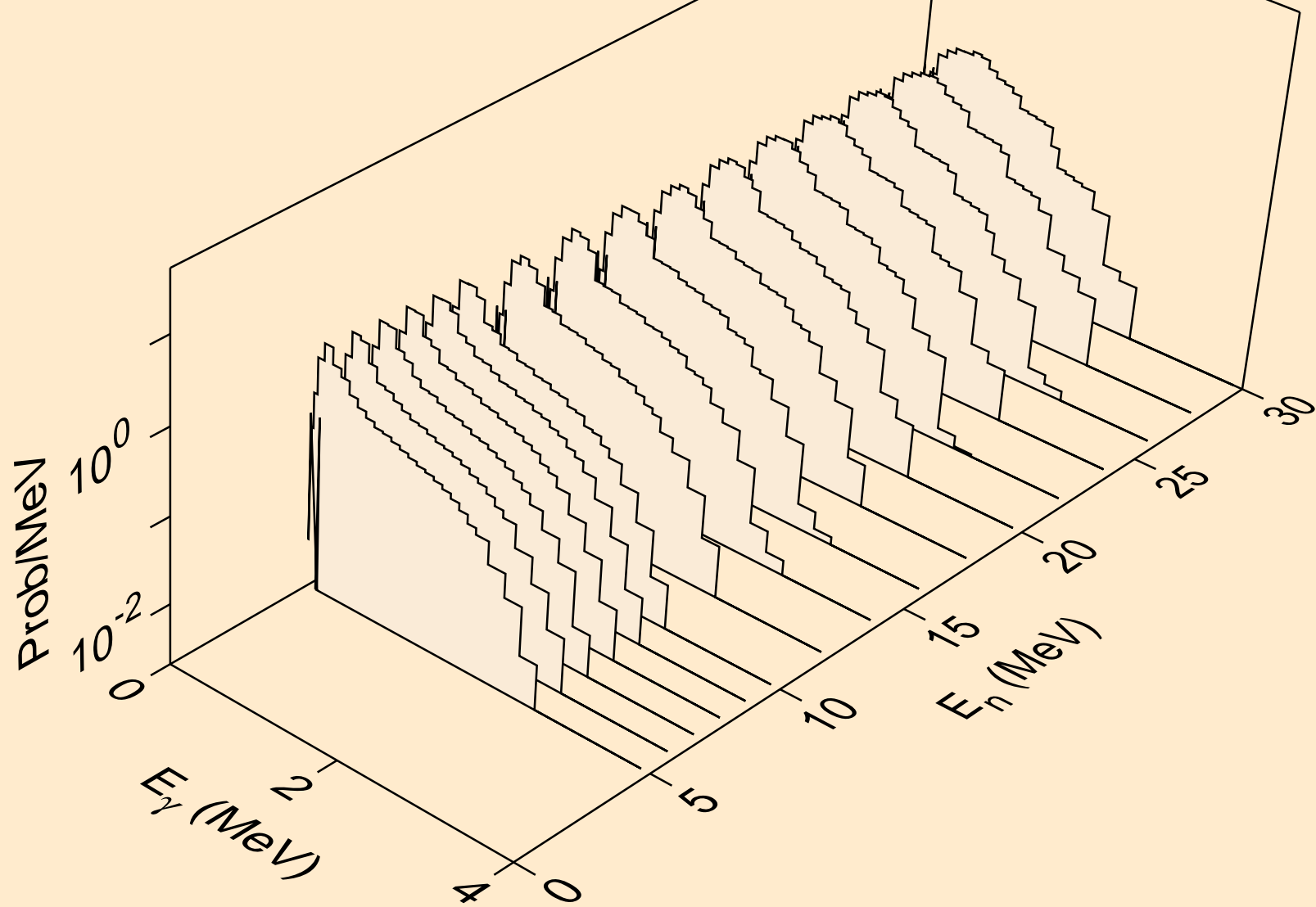

MD246M TRITON ACER TENDL-2021 LIBRARY; T=0.K  
Photon emission for (n,2n)a

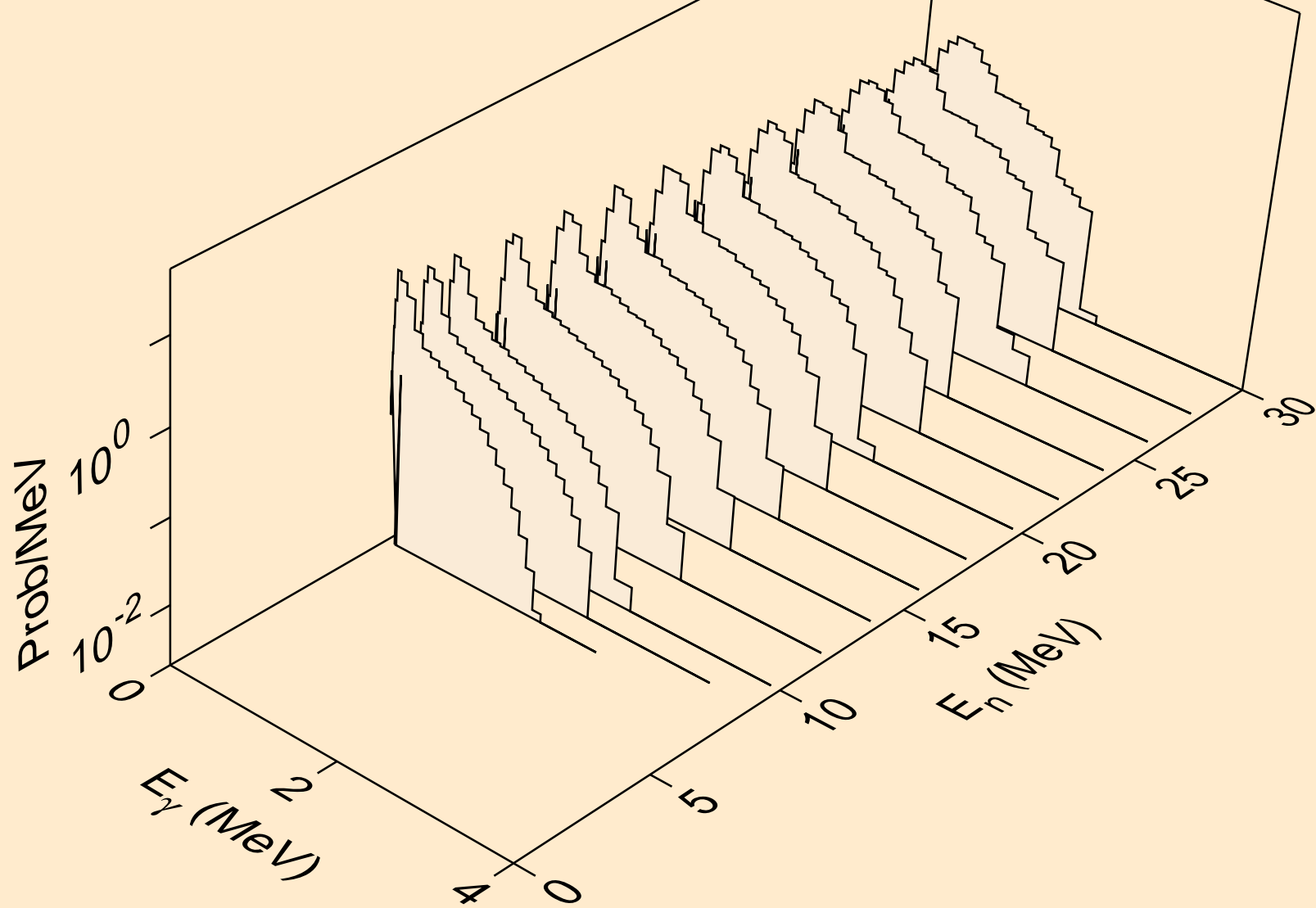

MD246M TRITON ACER TENDL-2021 LIBRARY; T=0.K  
Photon emission for (n,n\*)p

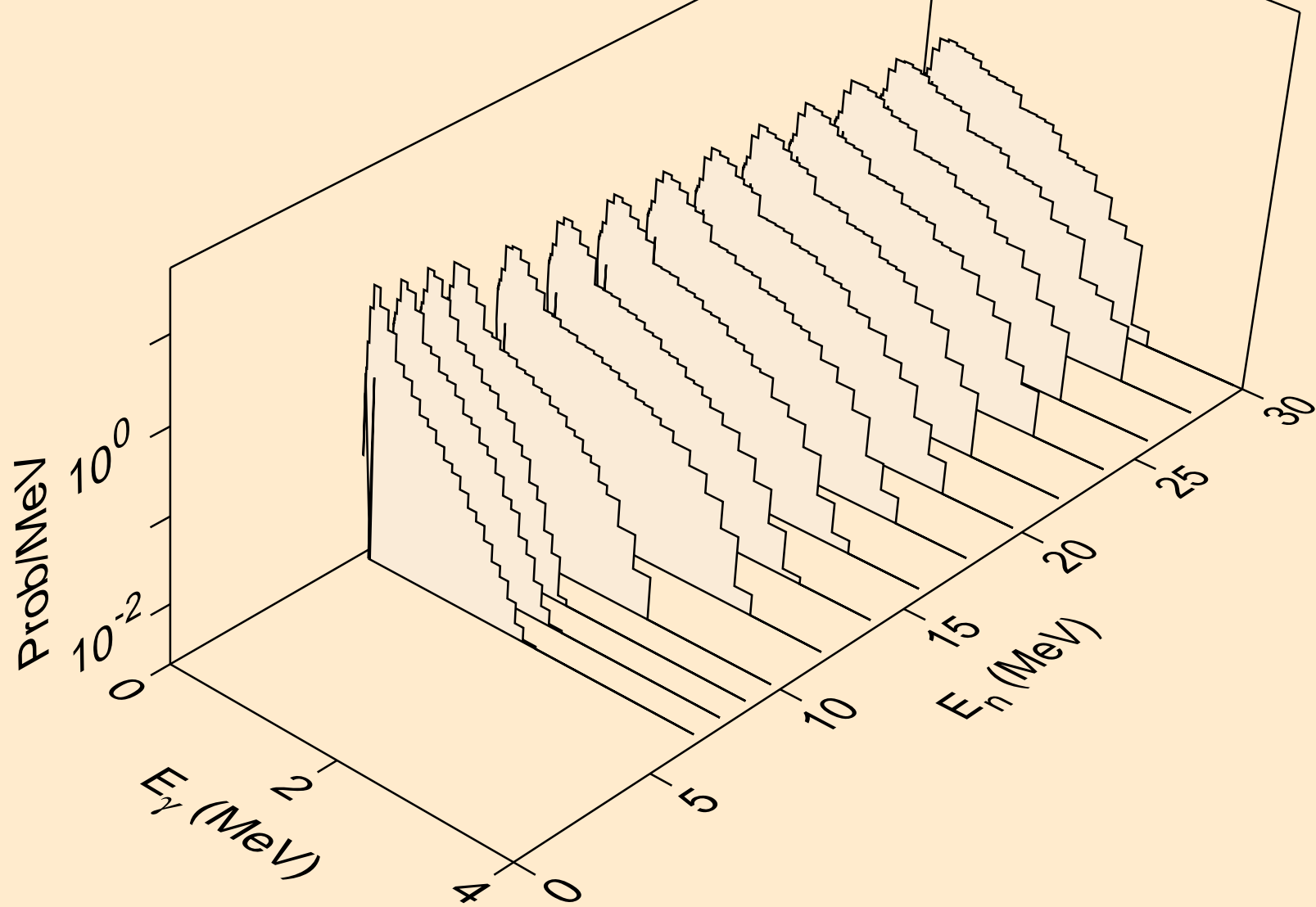

MD246M TRITON ACER TENDL-2021 LIBRARY; T=0.K  
Photon emission for (n,n\*)d

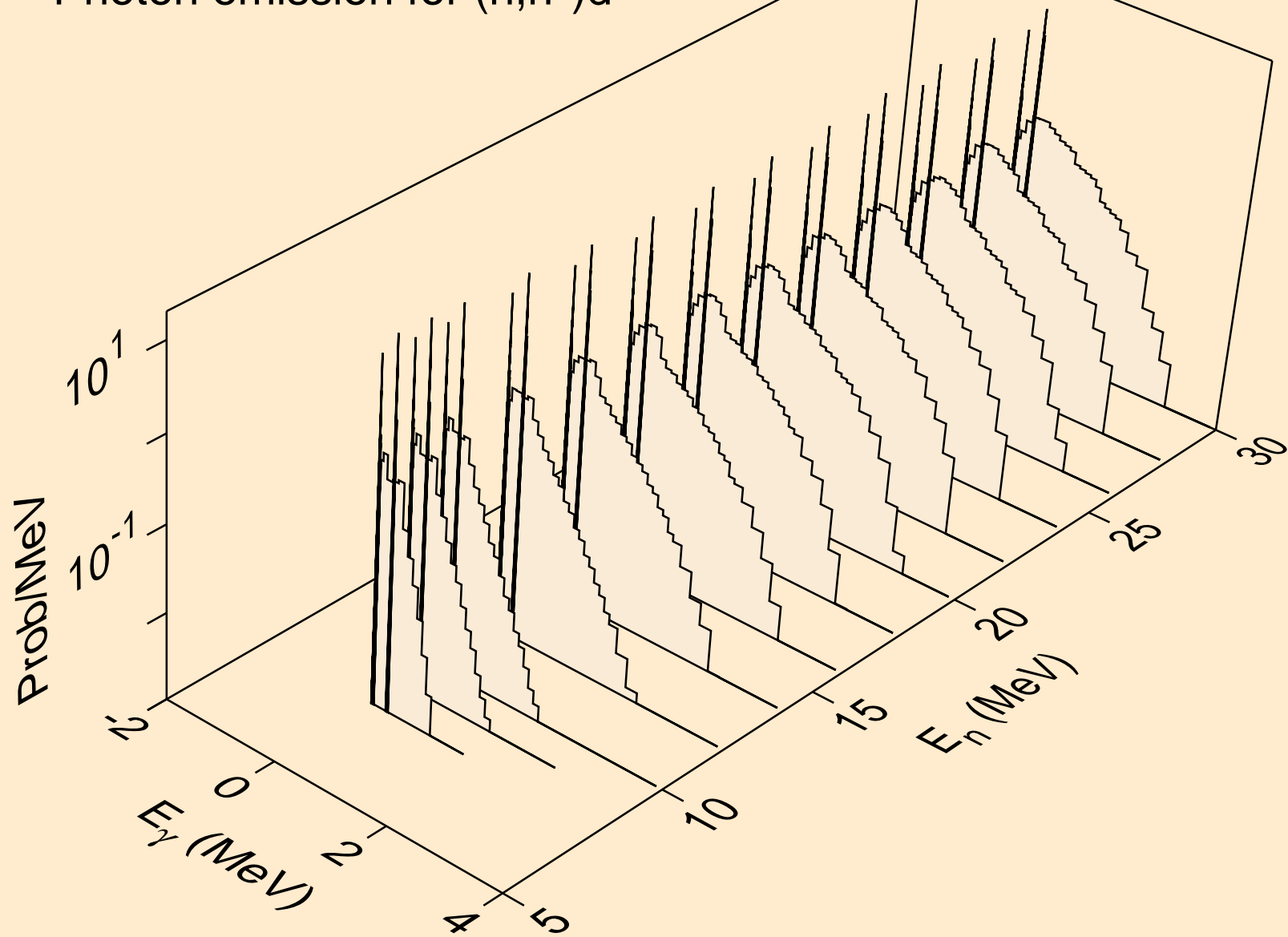

MD246M TRITON ACER TENDL-2021 LIBRARY; T=0.K  
Photon emission for (n,n\*)t

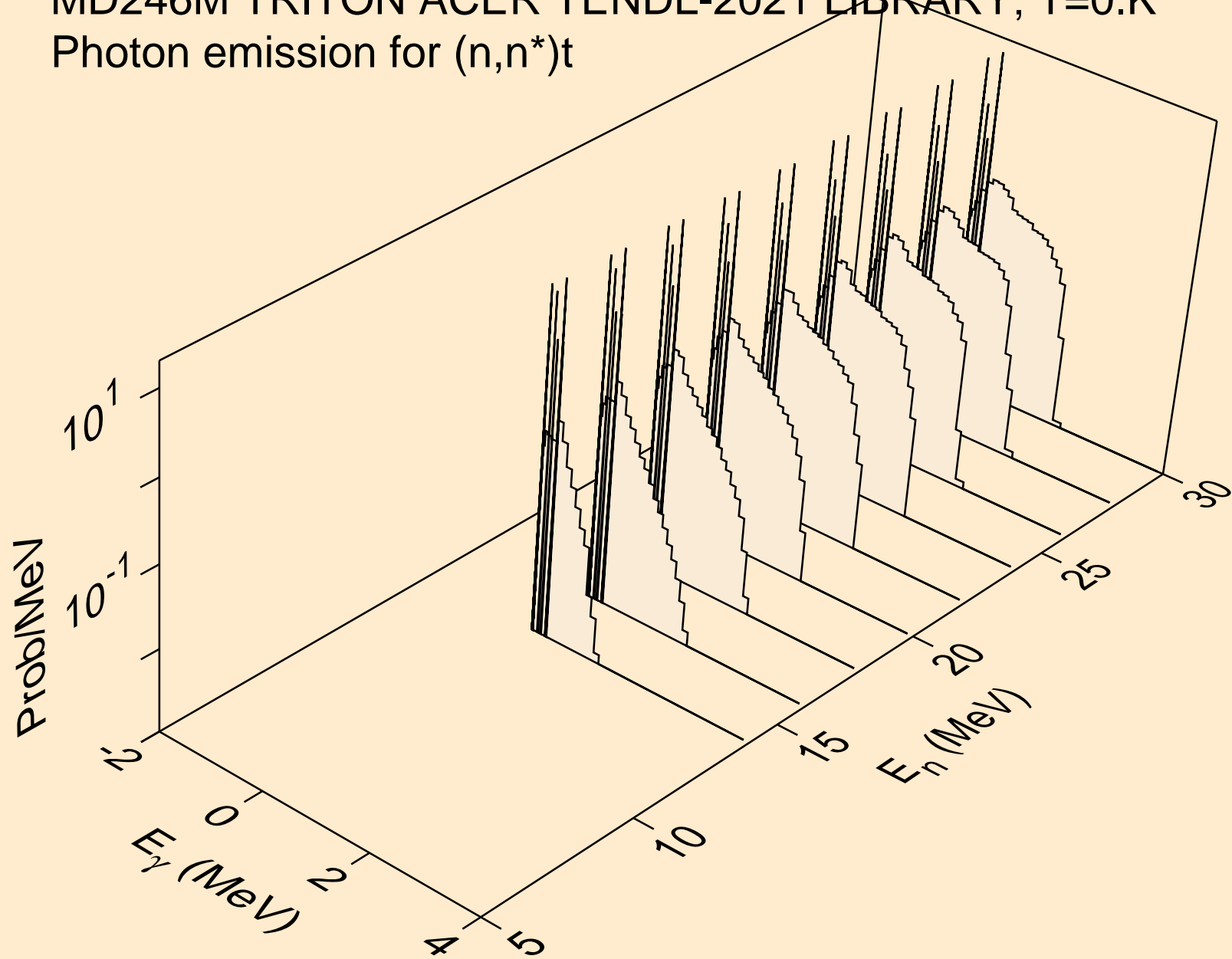



MD246M TRITON ACER TENDL-2021 LIBRARY; T=0.K  
Photon emission for (n,n\*)he3

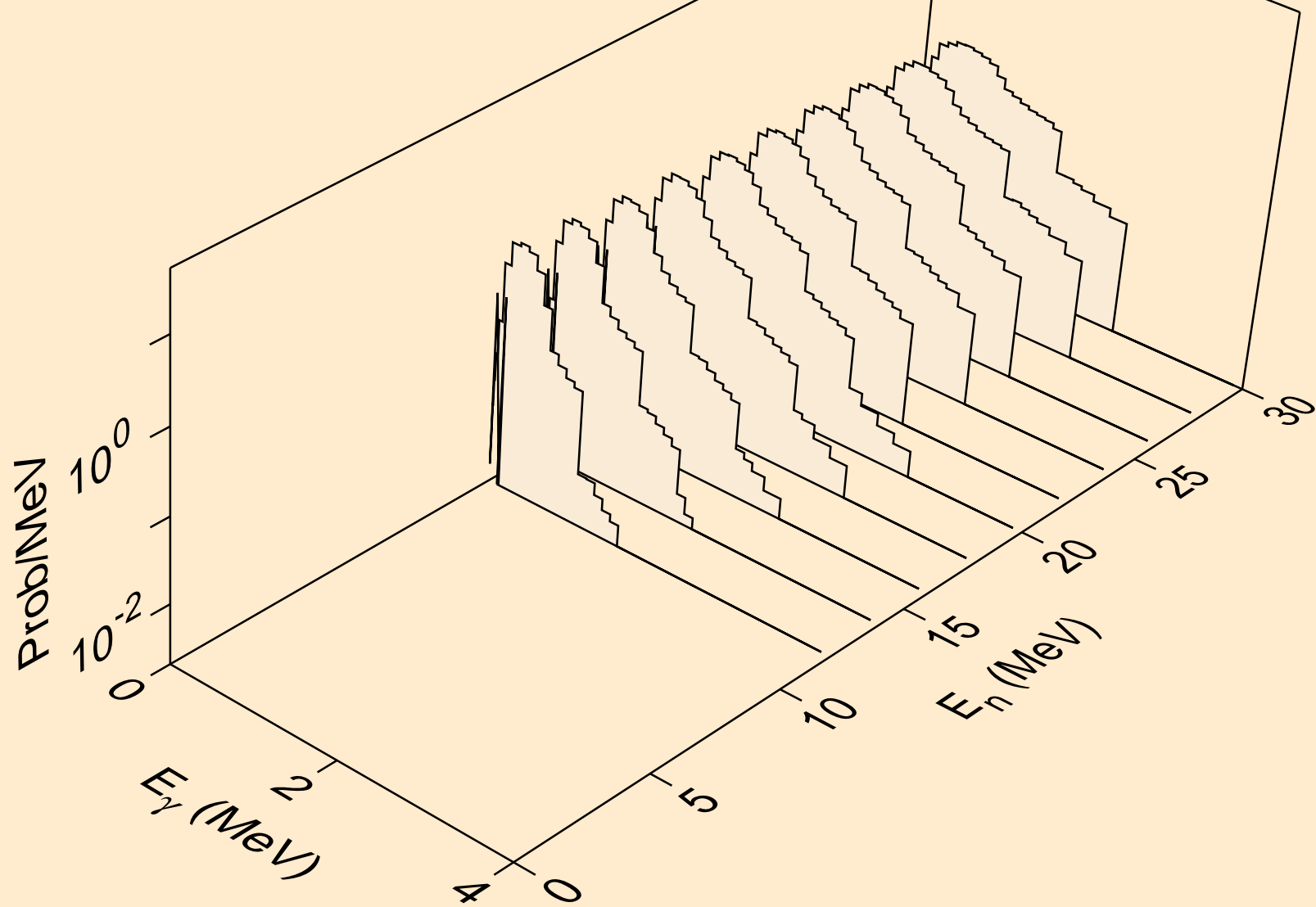

MD246M TRITON ACER TENDL-2021 LIBRARY; T=0.K  
Photon emission for (n,2np)

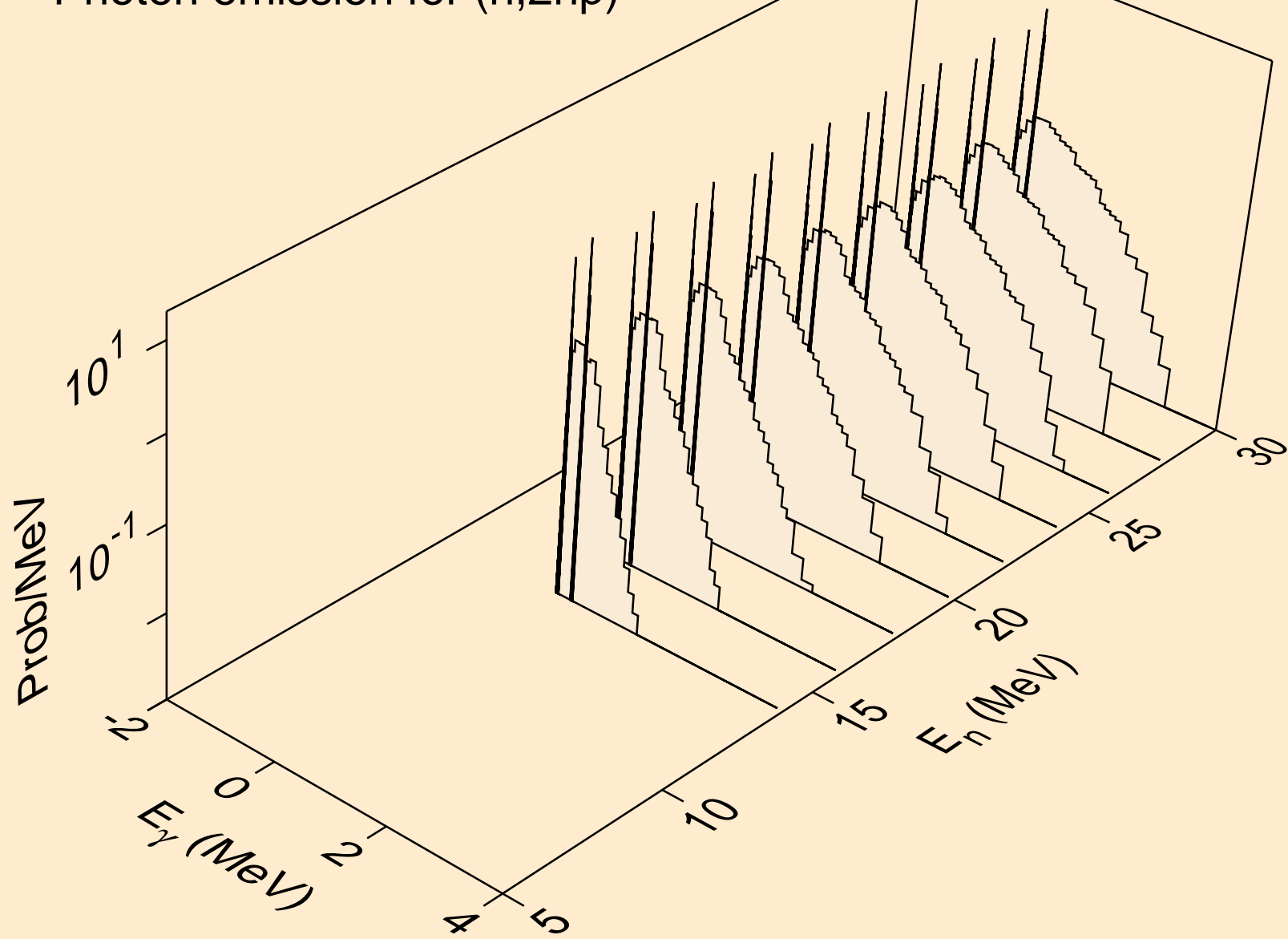

MD246M TRITON ACER TENDL-2021 LIBRARY; T=0.K  
Photon emission for (n,3np)

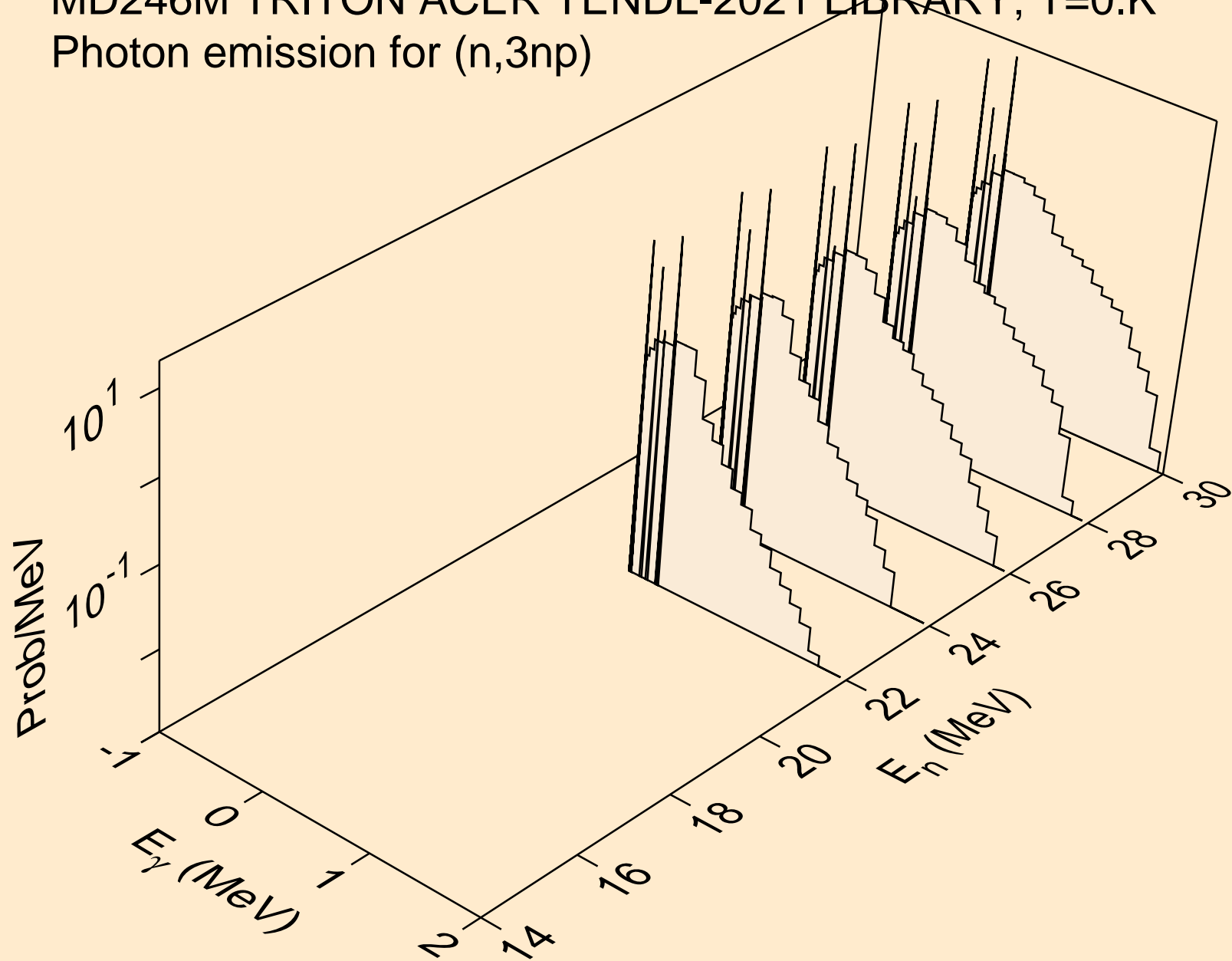

MD246M TRITON ACER TENDL-2021 LIBRARY; T=0.K  
Photon emission for (n,2np)

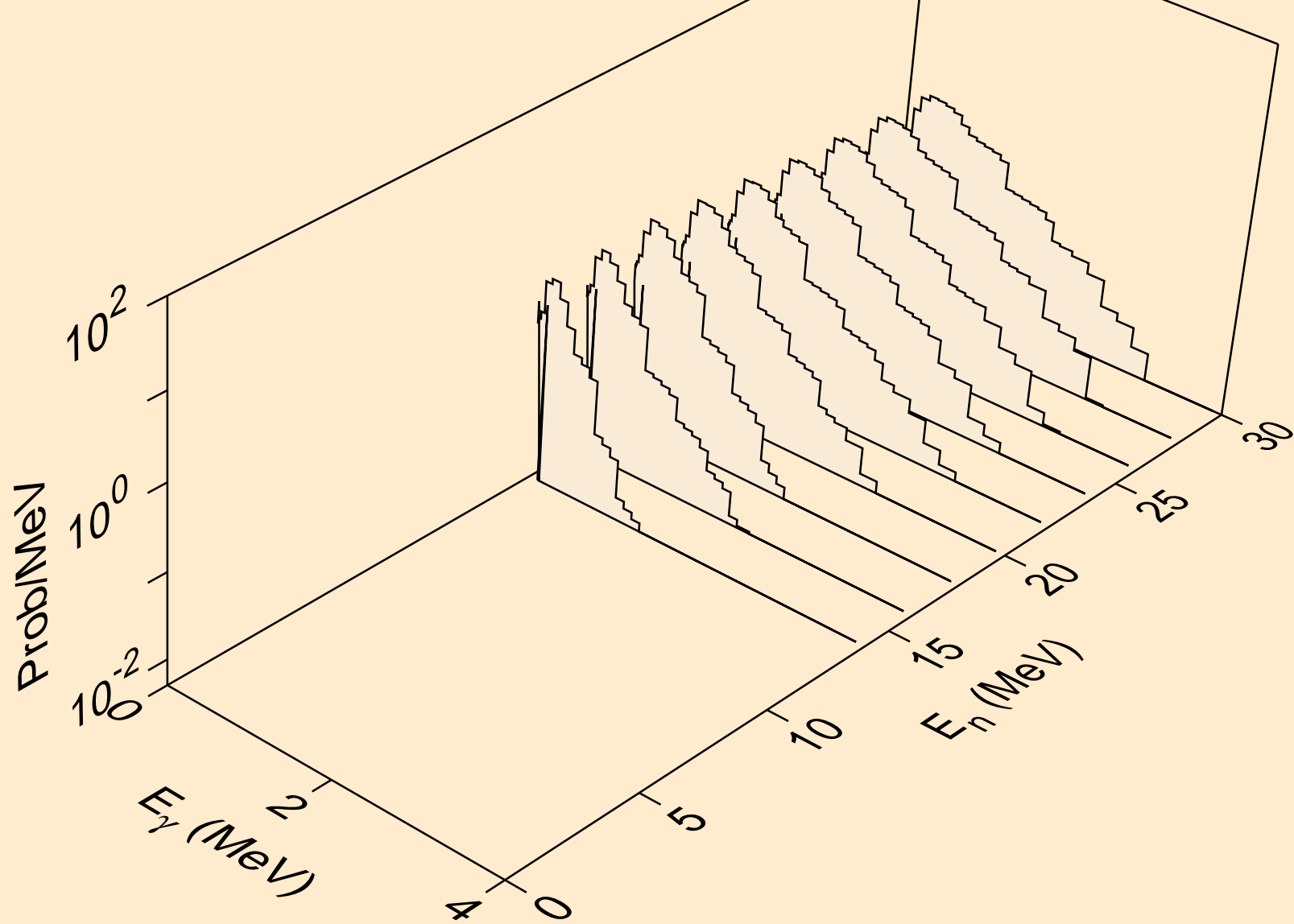

MD246M TRITON ACER TENDL-2021 LIBRARY; T=0.K  
Photon emission for (n,npa)

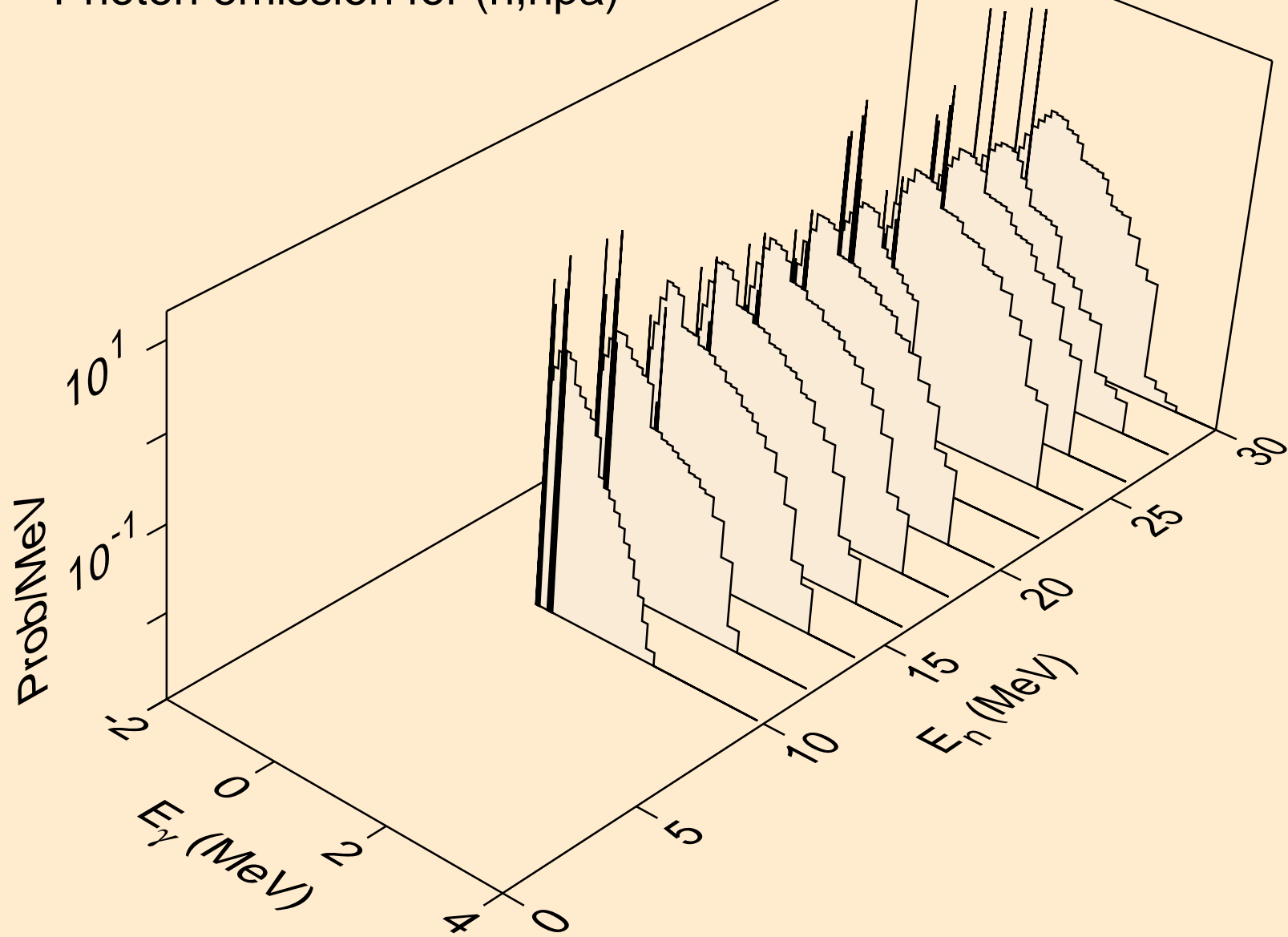

MD246M TRITON ACER TENDL-2021 LIBRARY; T=0.K  
Photon emission for (n,p)

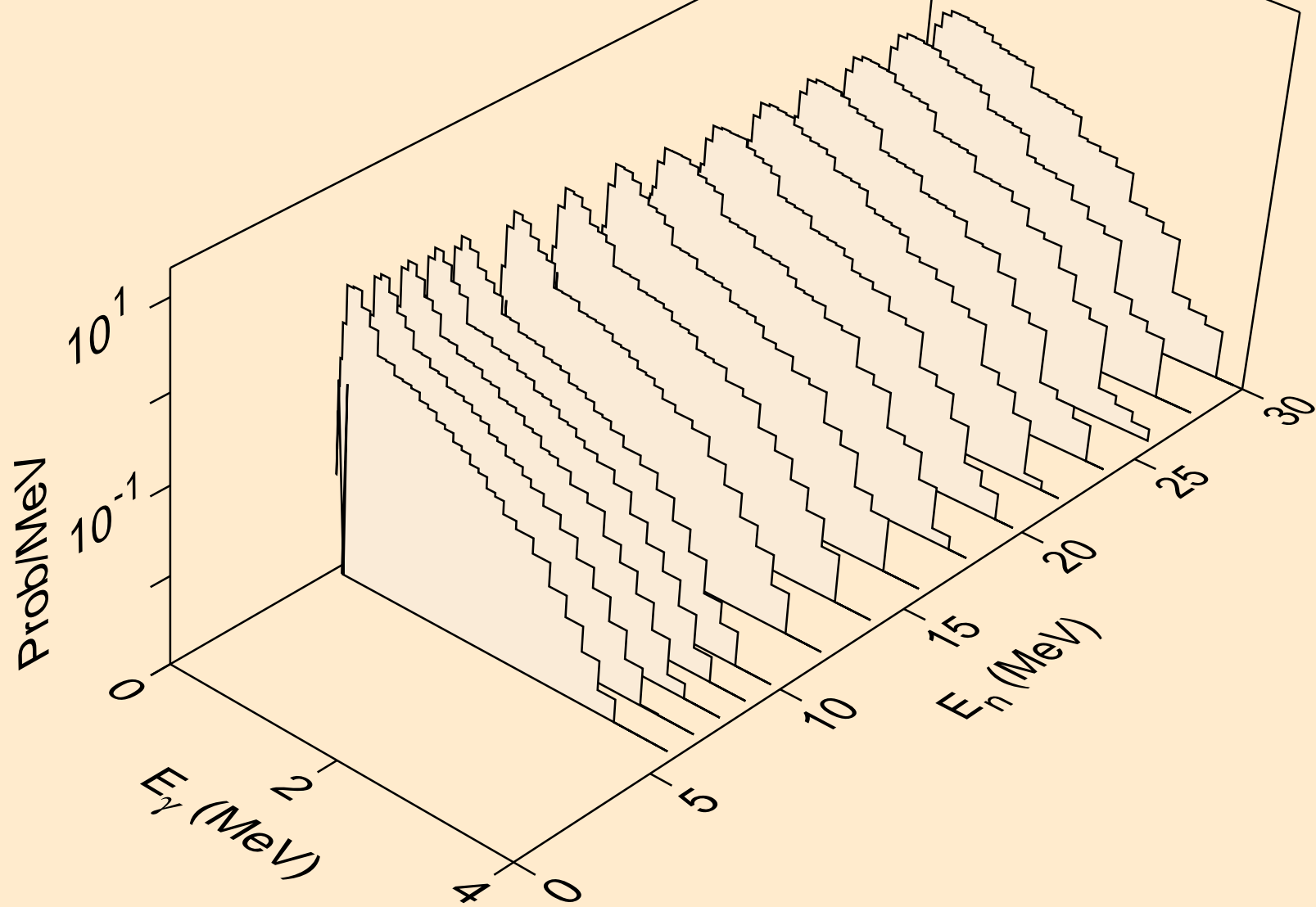

MD246M TRITON ACER TENDL-2021 LIBRARY; T=0.K  
Photon emission for (n,d)

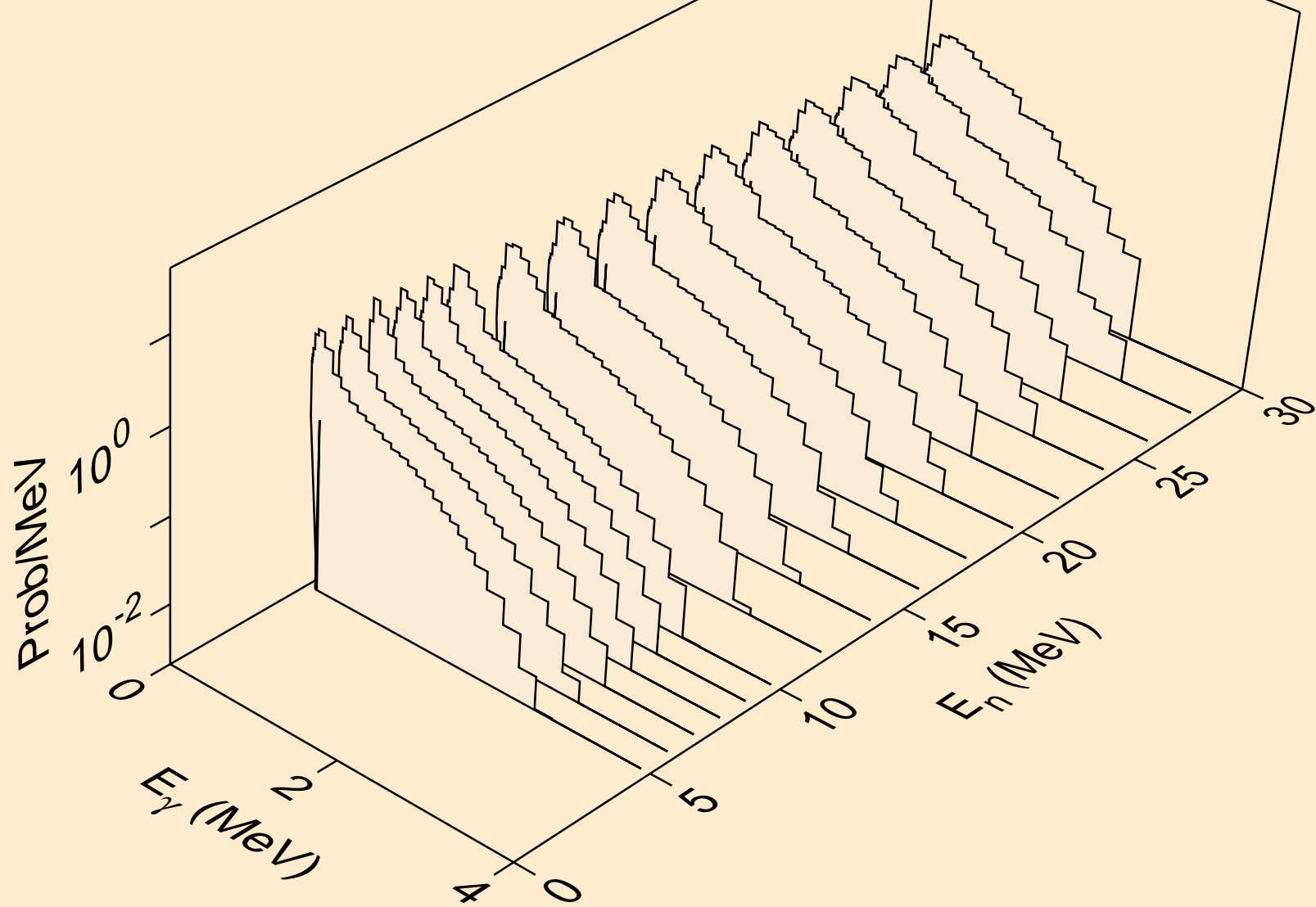

MD246M TRITON ACER TENDL-2021 LIBRARY; T=0.K  
Photon emission for inelastic

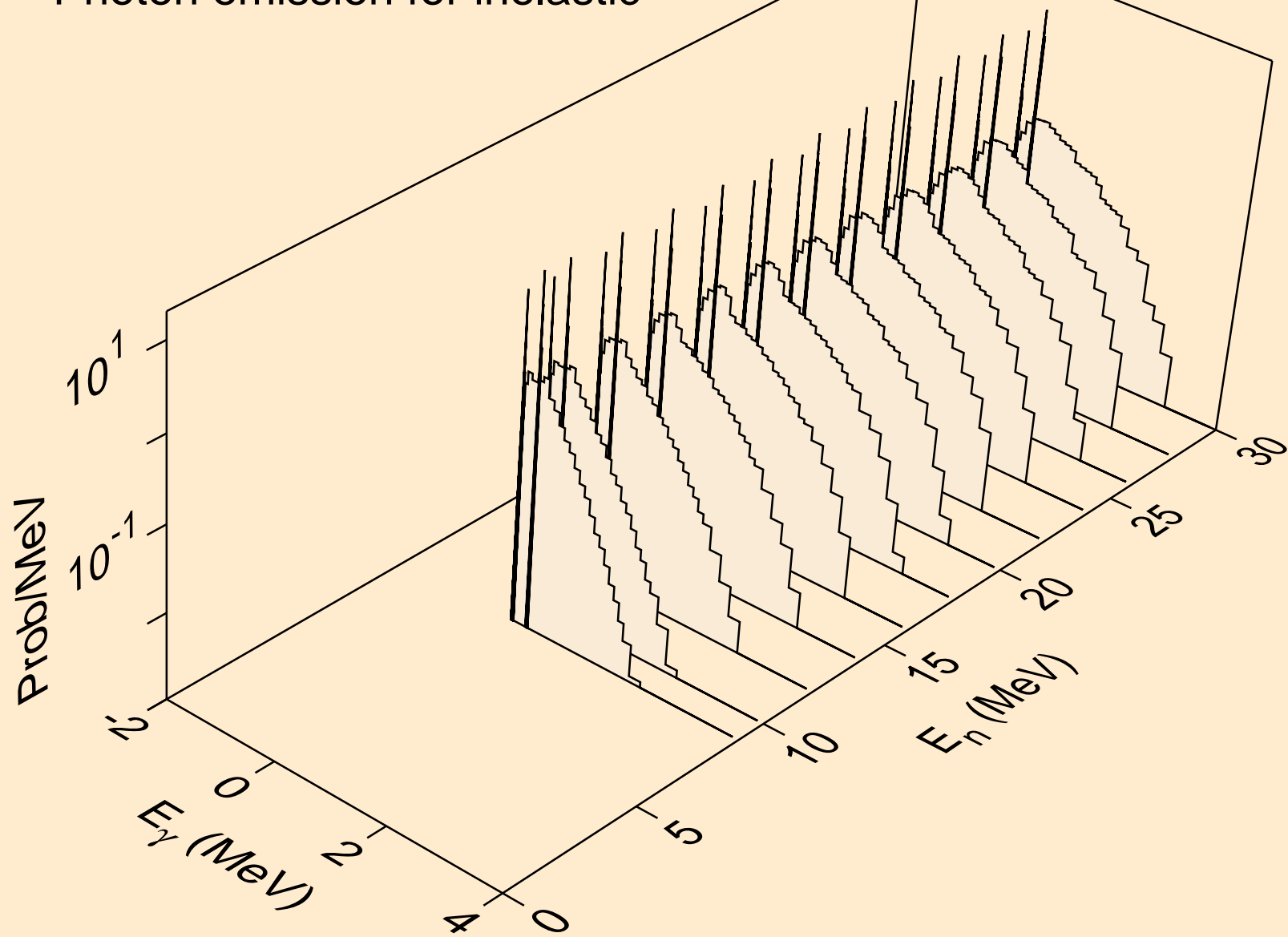



MD246M TRITON ACER TENDL-2021 LIBRARY; T=0.K  
Photon emission for (n,he3)

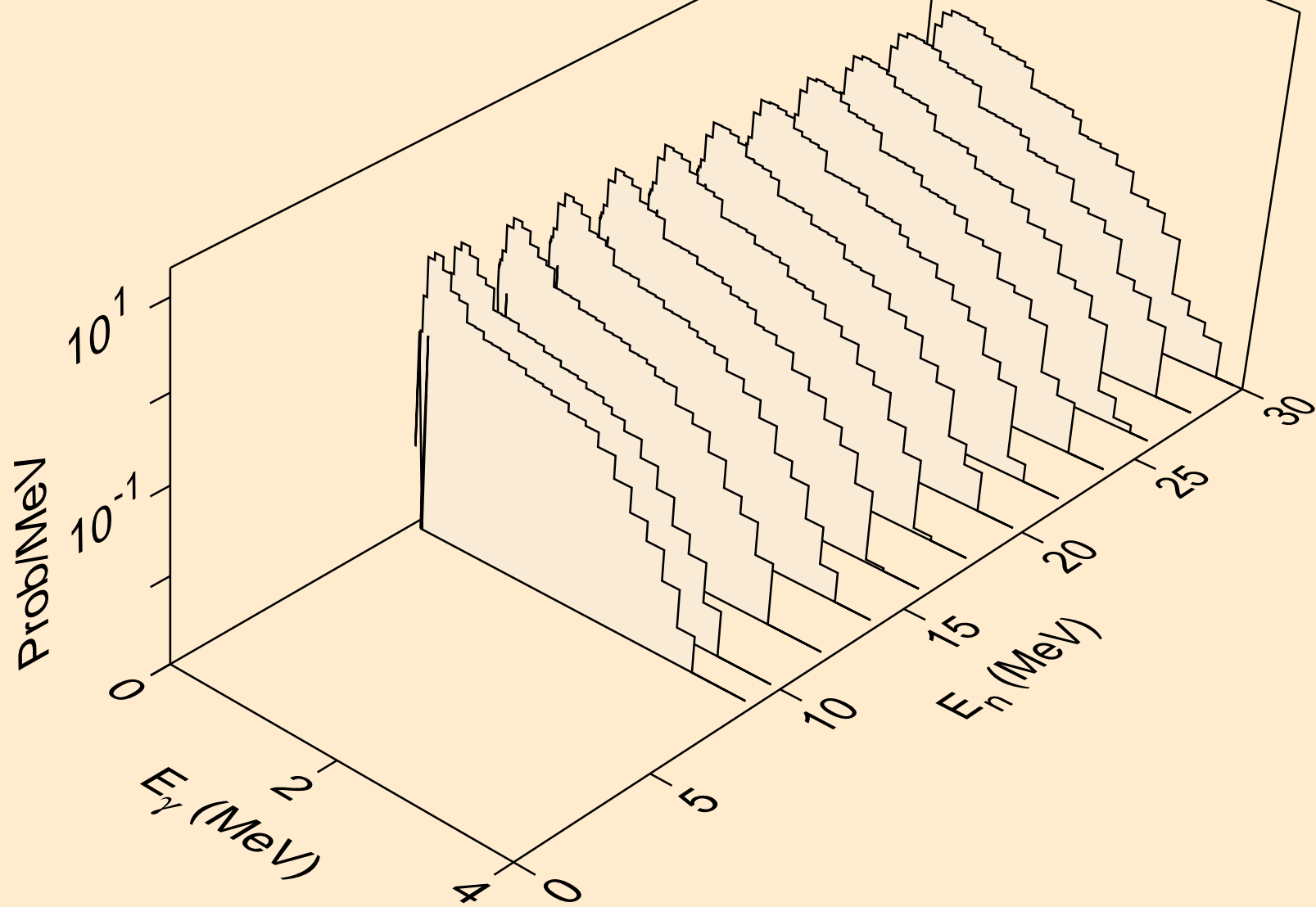

MD246M TRITON ACER TENDL-2021 LIBRARY; T=0.K  
Photon emission for (n,a)

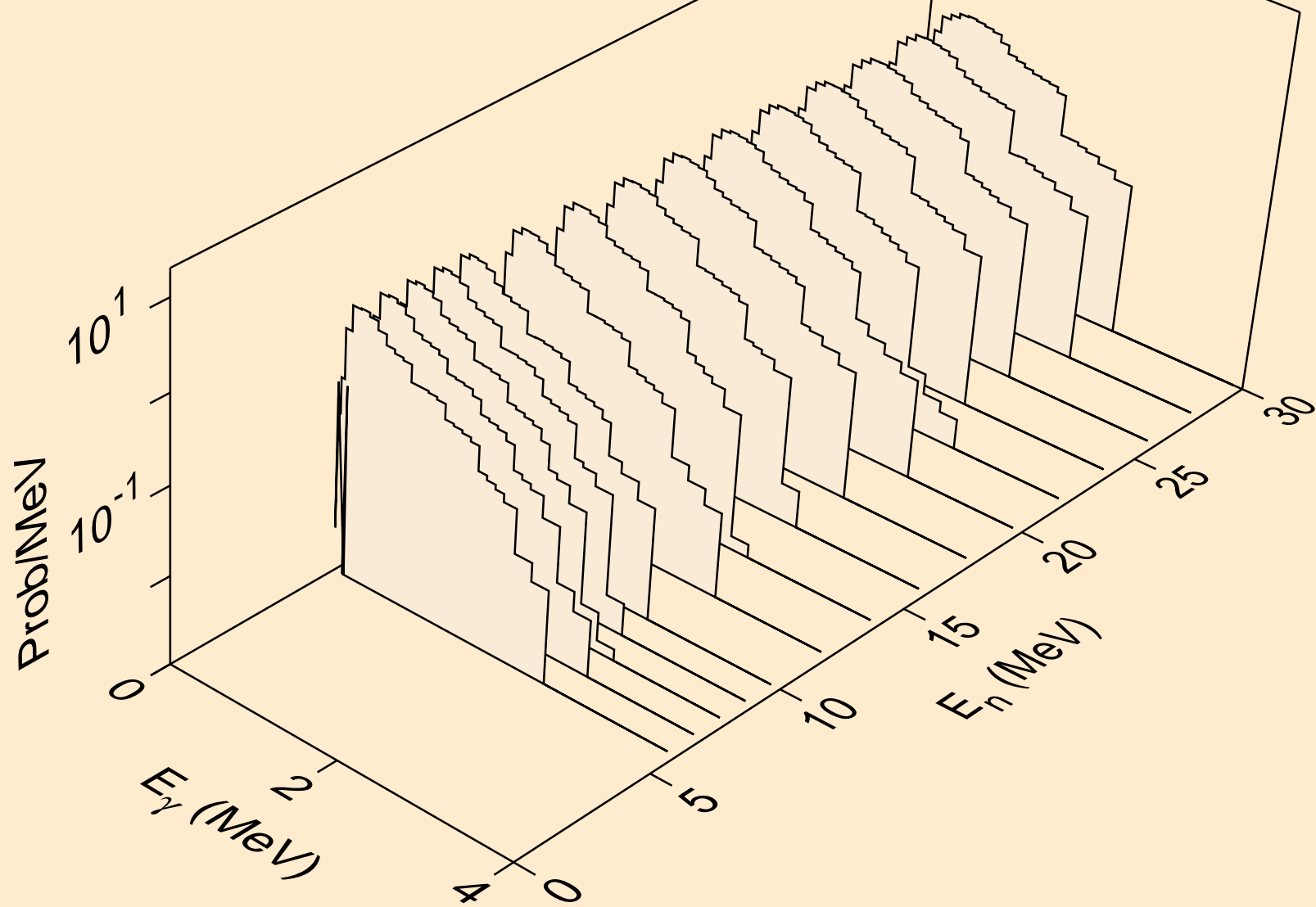

MD246M TRITON ACER TENDL-2021 LIBRARY; T=0.K  
Photon emission for (n,2a)

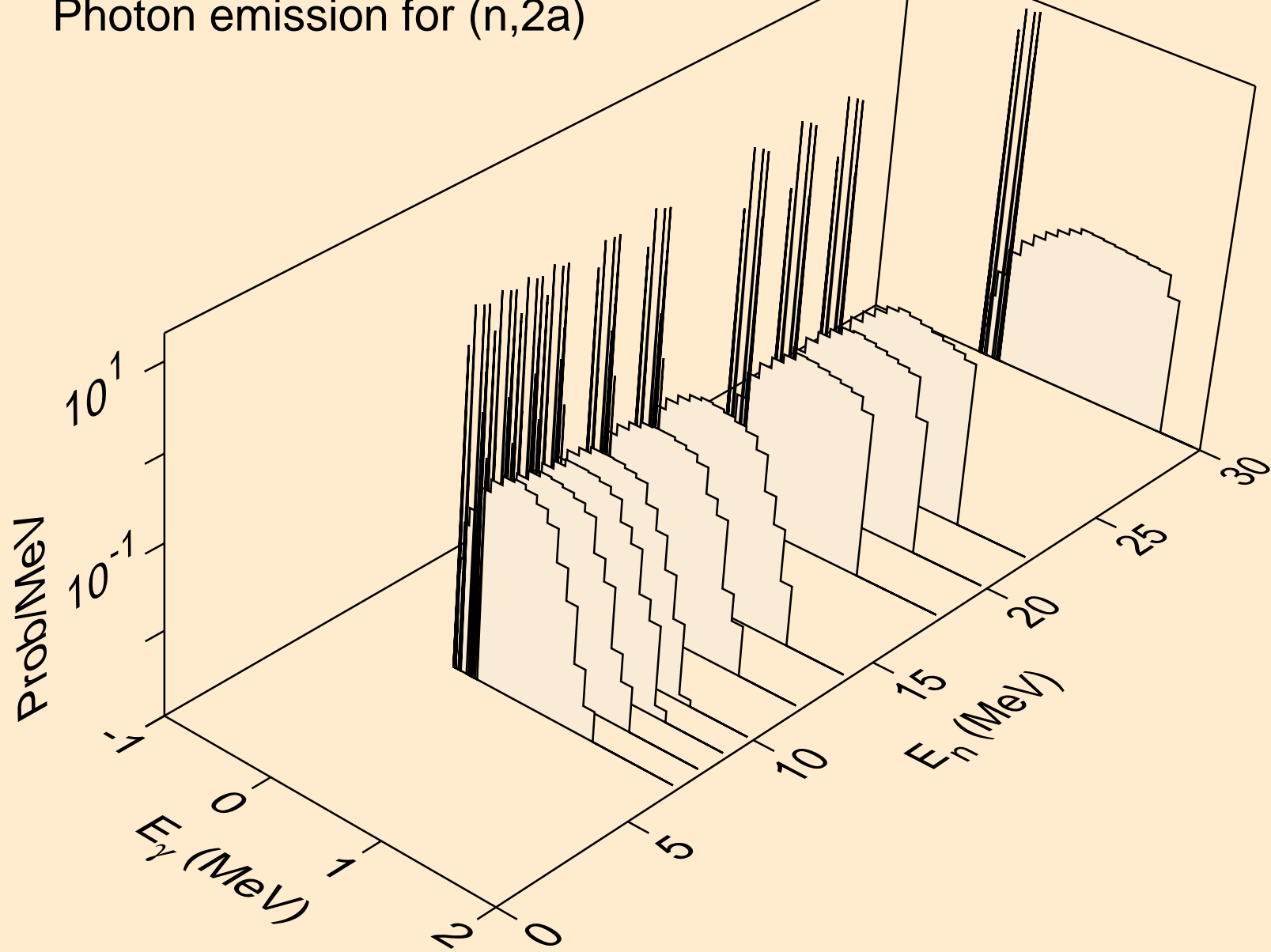

MD246M TRITON ACER TENDL-2021 LIBRARY; T=0.K  
Photon emission for (n,2p)

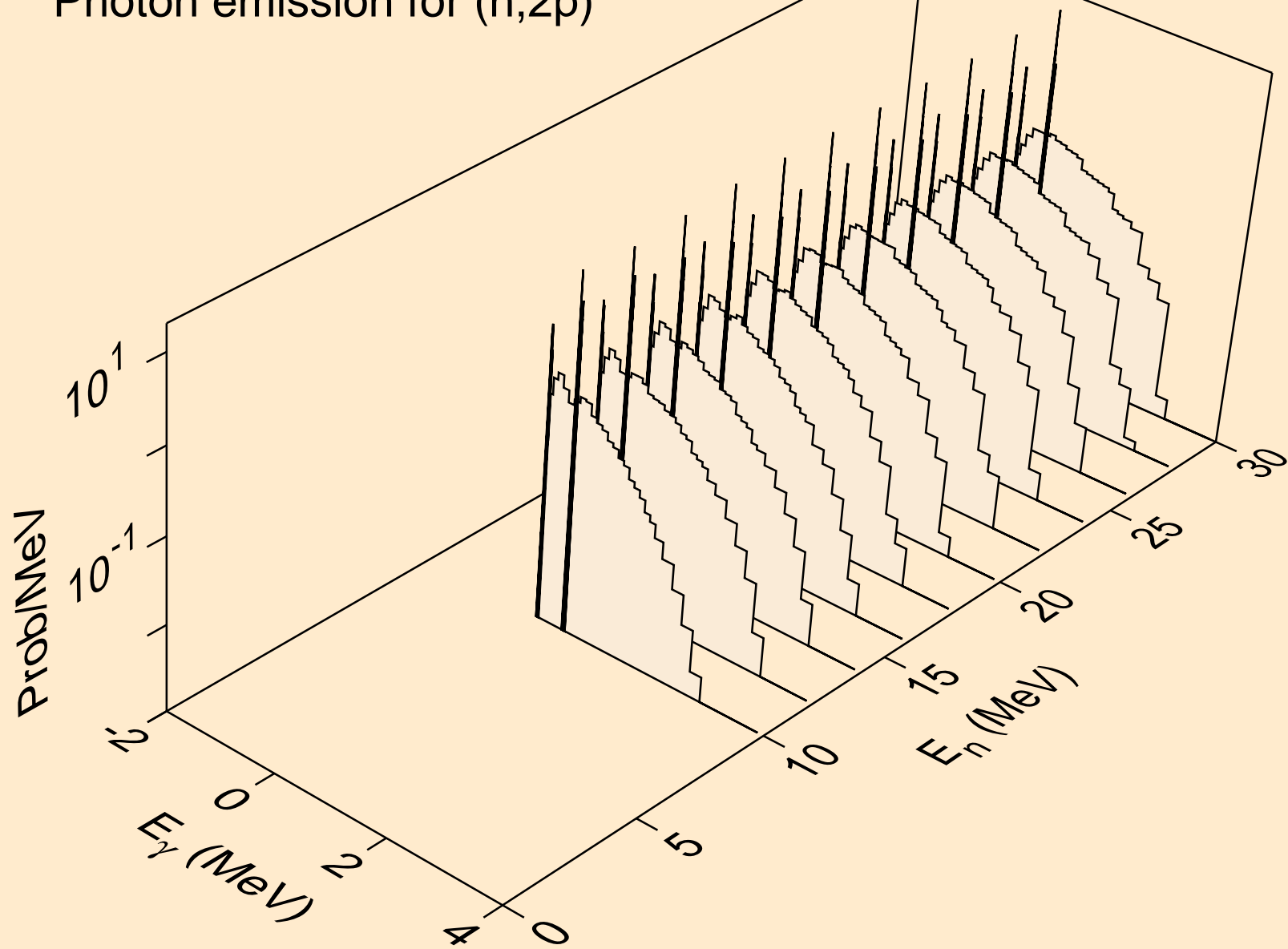

MD246M TRITON ACER TENDL-2021 LIBRARY; T=0.K  
Photon emission for (n,pa)

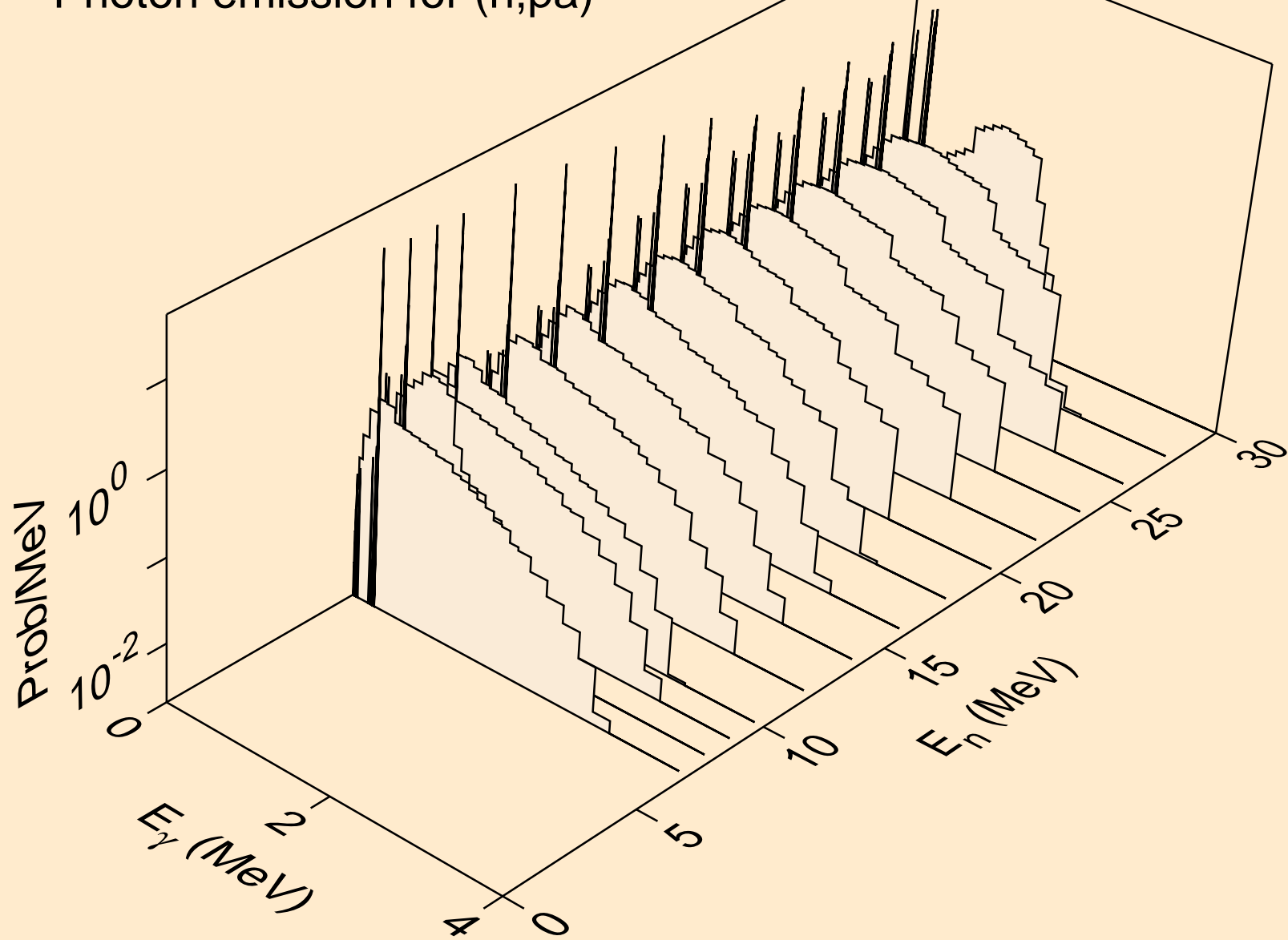

MD246M TRITON ACER TENDL-2021 LIBRARY; T=0.K  
Photon emission for (n,pd)

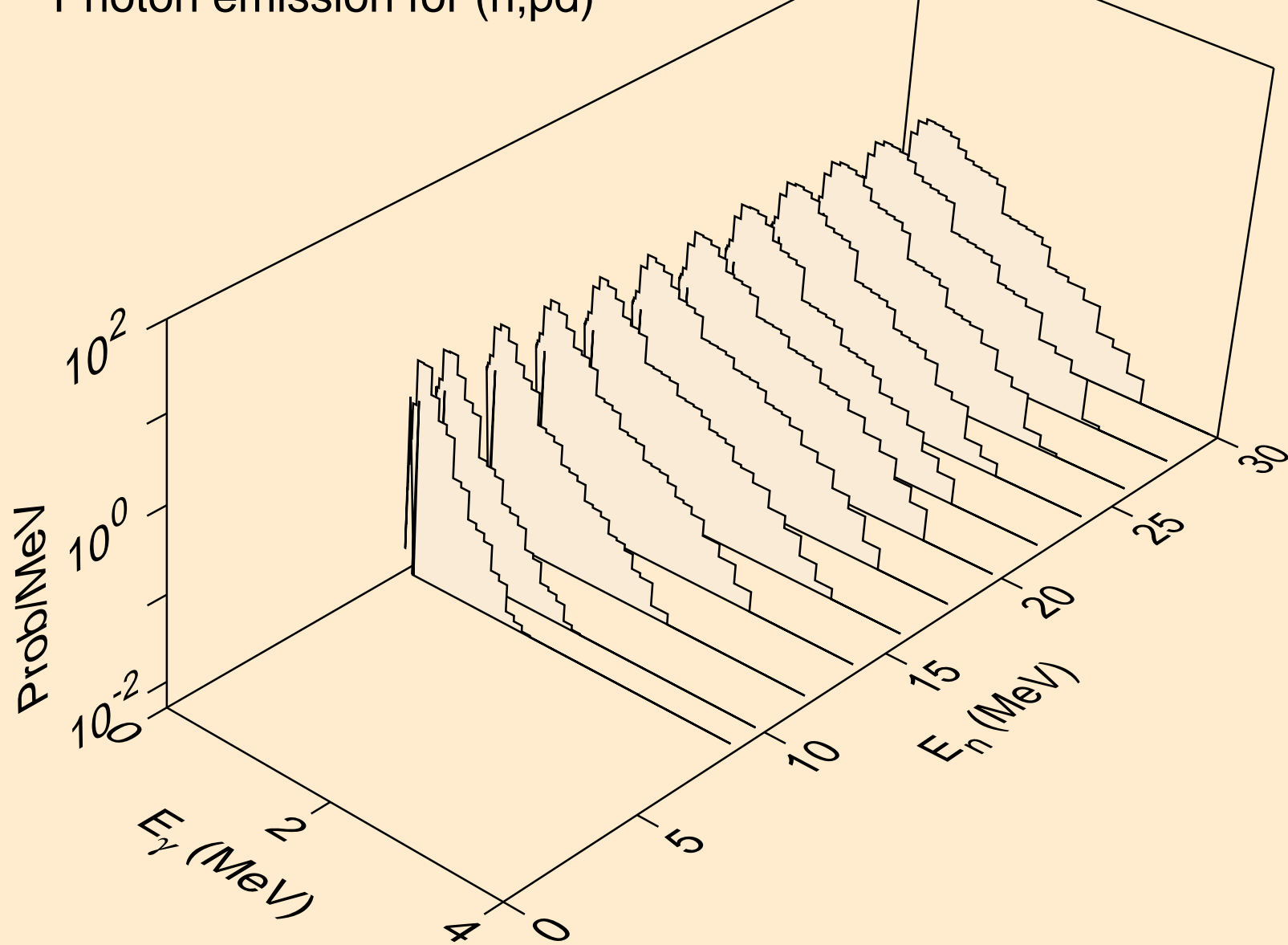

MD246M TRITON ACER TENDL-2021 LIBRARY; T=0.K  
Photon emission for (n,da)

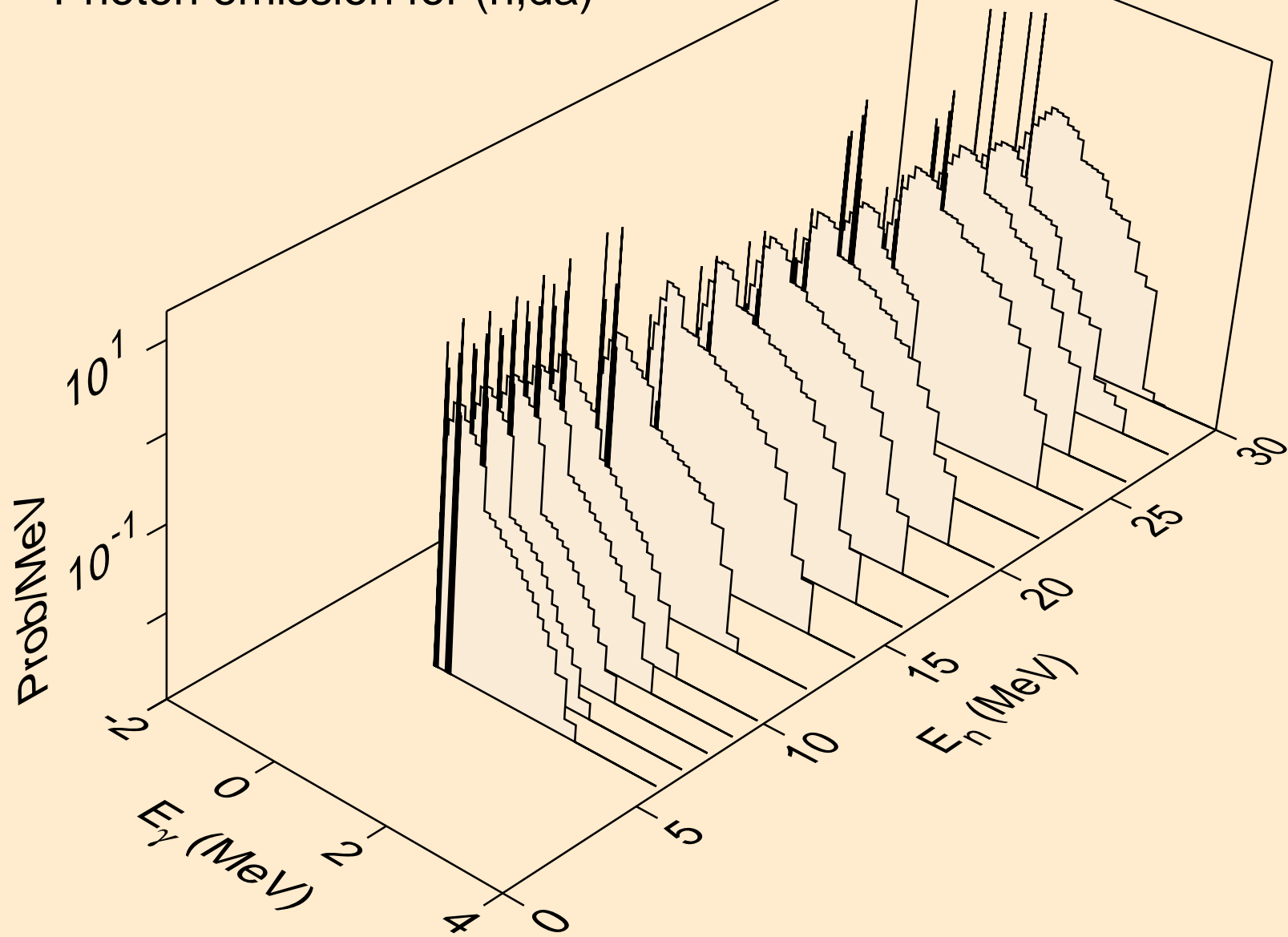

MD246M TRITON ACER TENDL-2021 LIBRARY; T=0.K  
Particle heating contributions

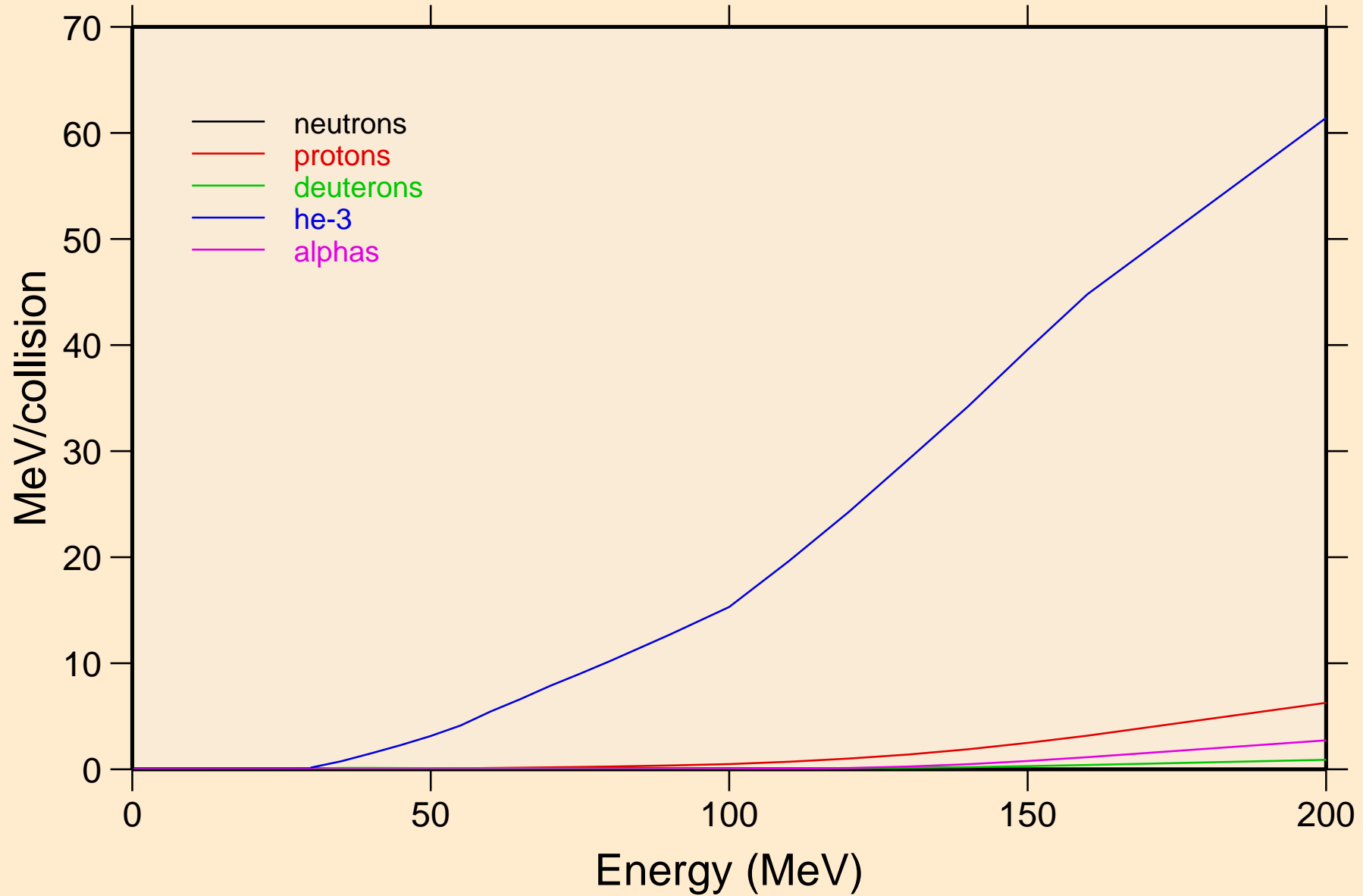



MD246M TRITON ACER TENDL-2021 LIBRARY; T=0.K  
Recoil Heating

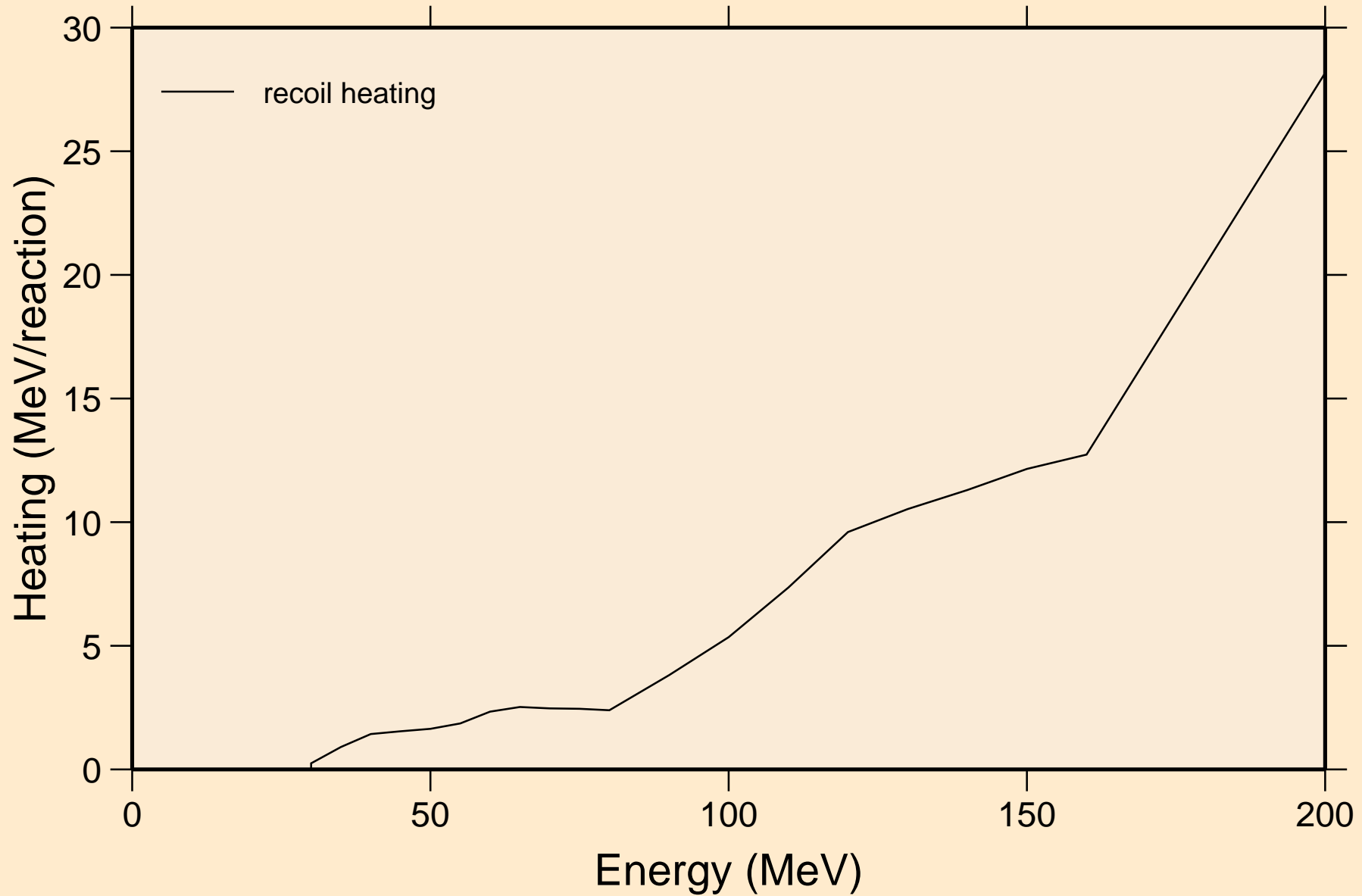

MD246M TRITON ACER TENDL-2021 LIBRARY; T=0.K  
Particle production cross sections

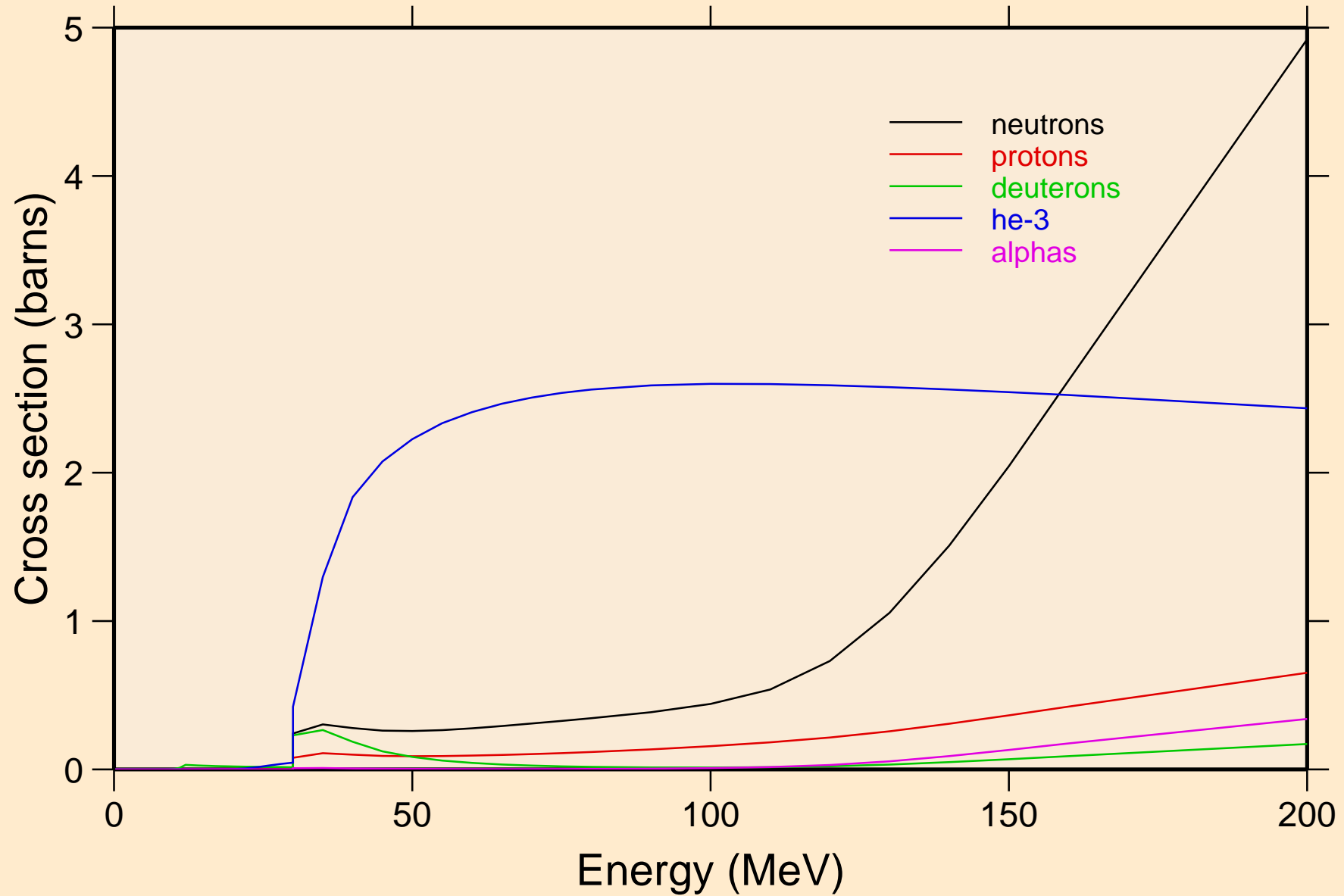

MD246M TRITON ACER TENDL-2021 LIBRARY; T=0.K  
neutrons from (t,n)

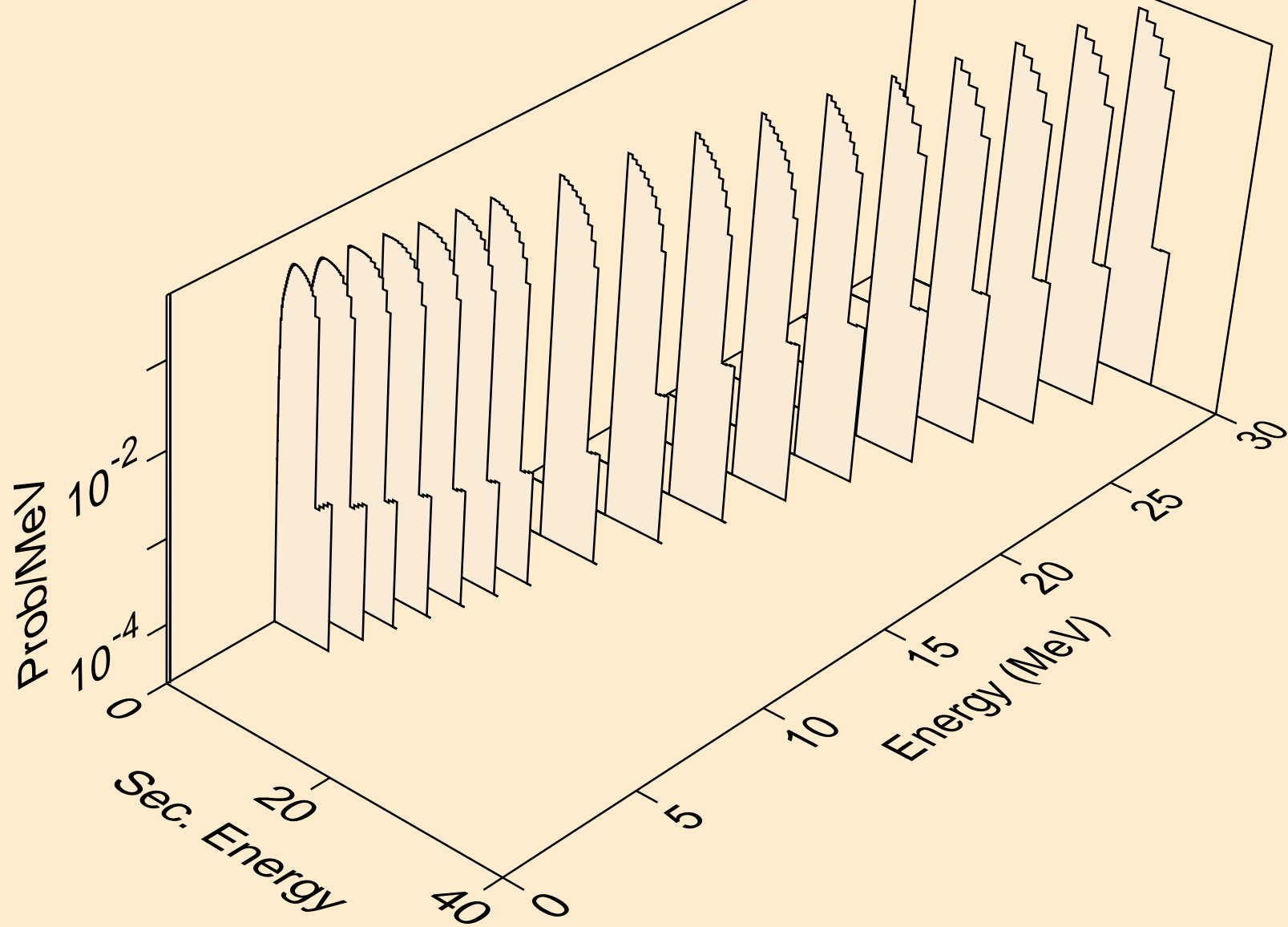

MD246M TRITON ACER TENDL-2021 LIBRARY; T=0.K  
neutrons from (t,x)

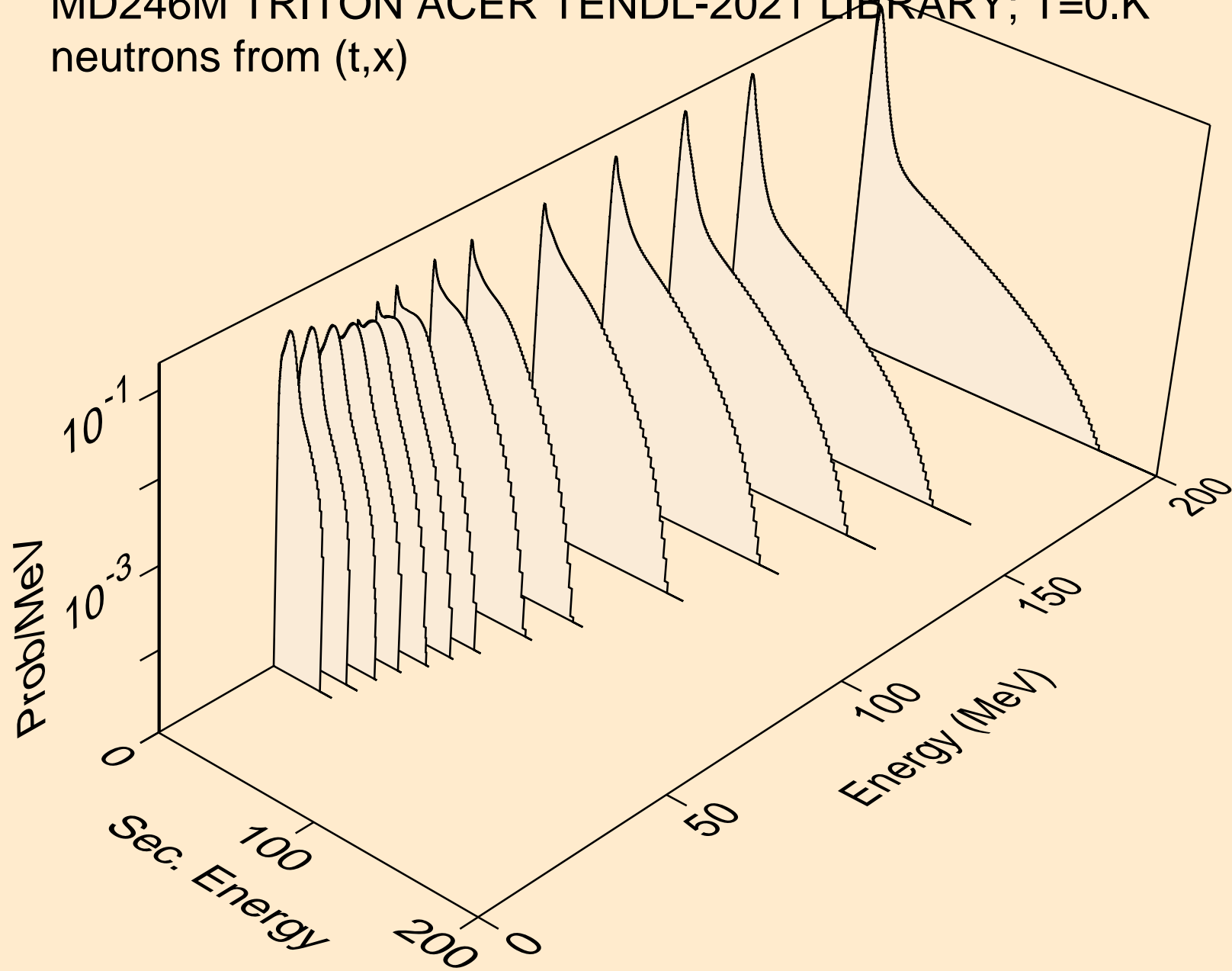

MD246M TRITON ACER TENDL-2021 LIBRARY; T=0.K  
neutrons from (t,2n)

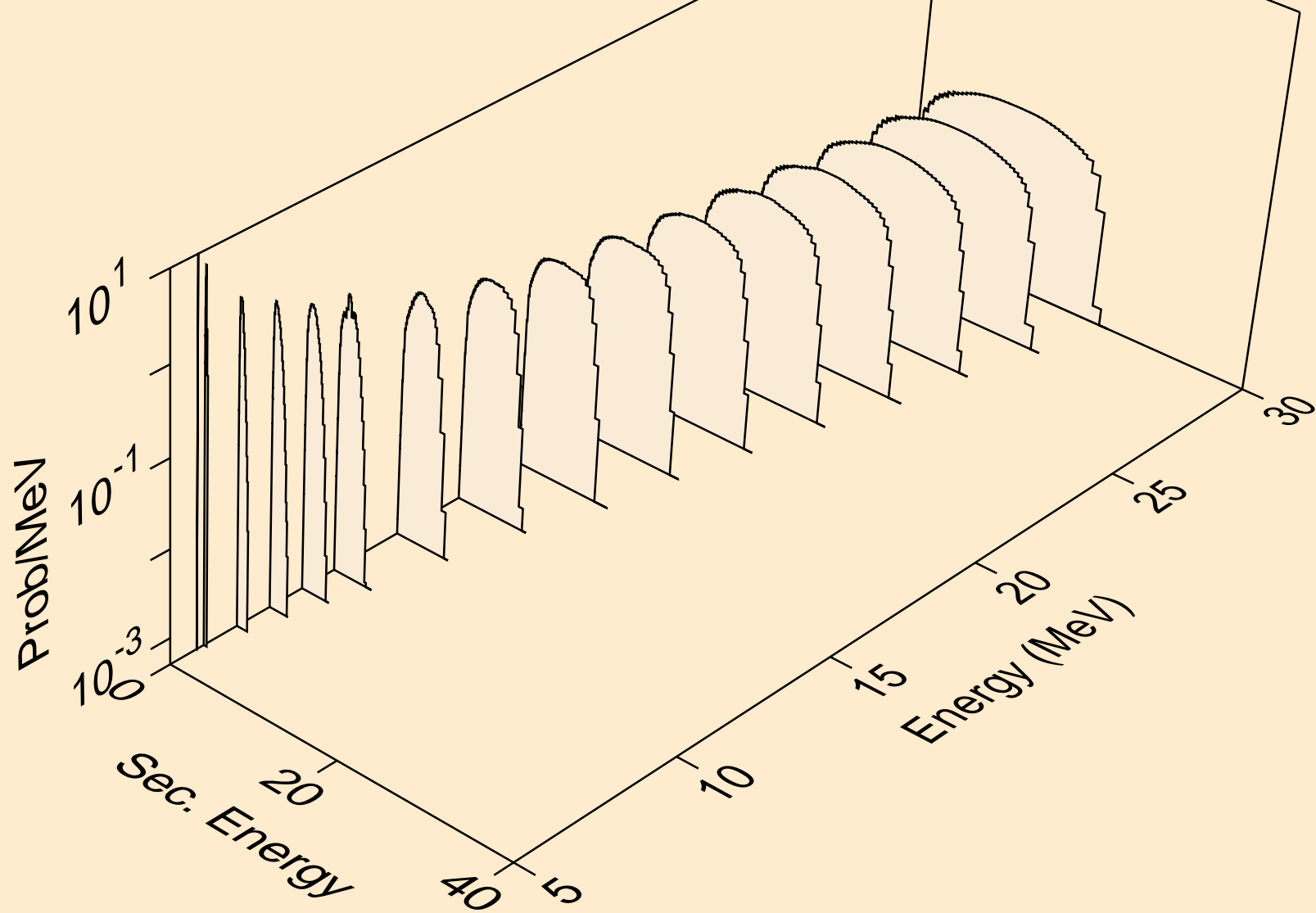

MD246M TRITON ACER TENDL-2021 LIBRARY; T=0.K  
neutrons from (t,3n)

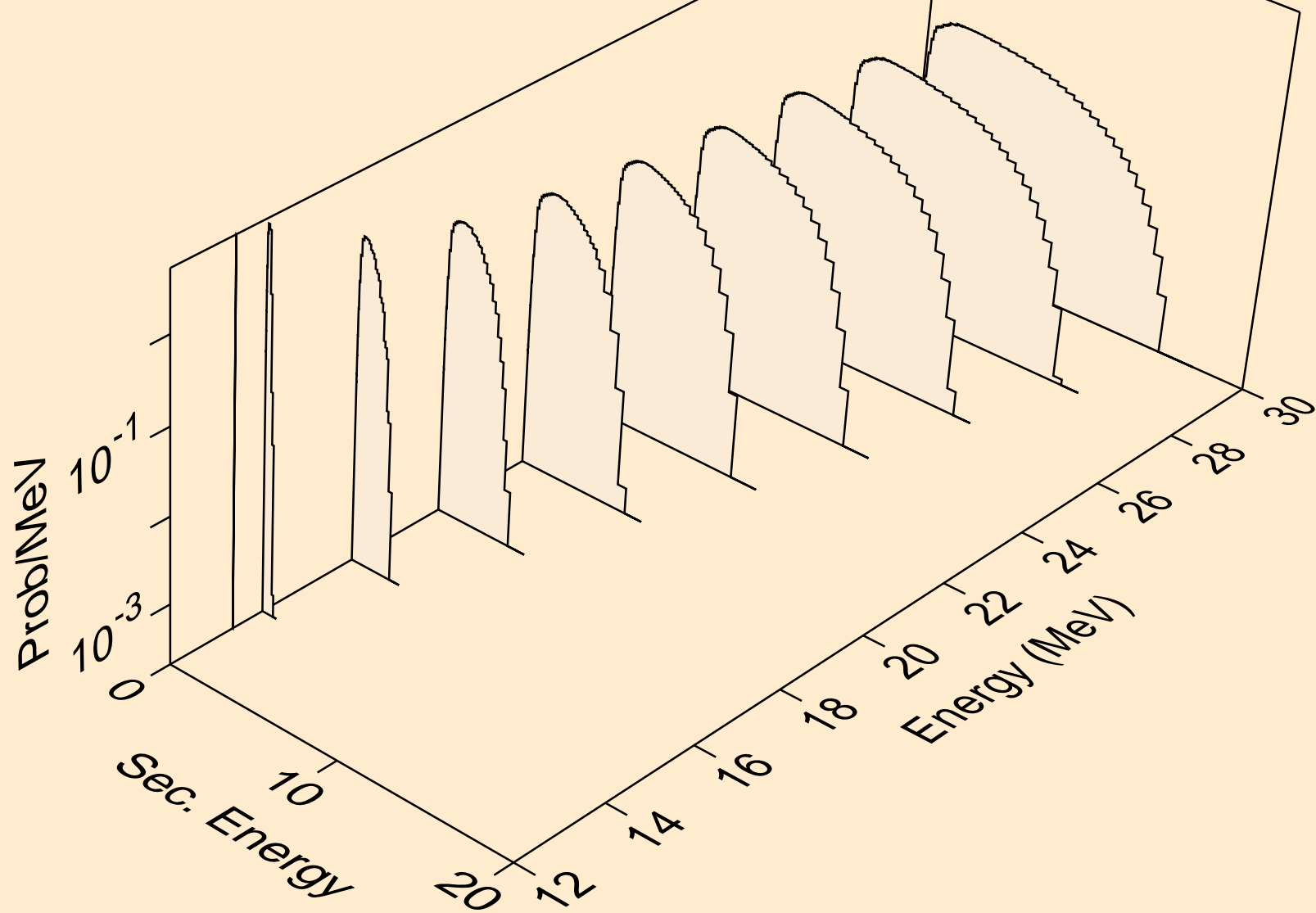

MD246M TRITON ACER TENDL-2021 LIBRARY; T=0.K  
neutrons from (t,n\*)a

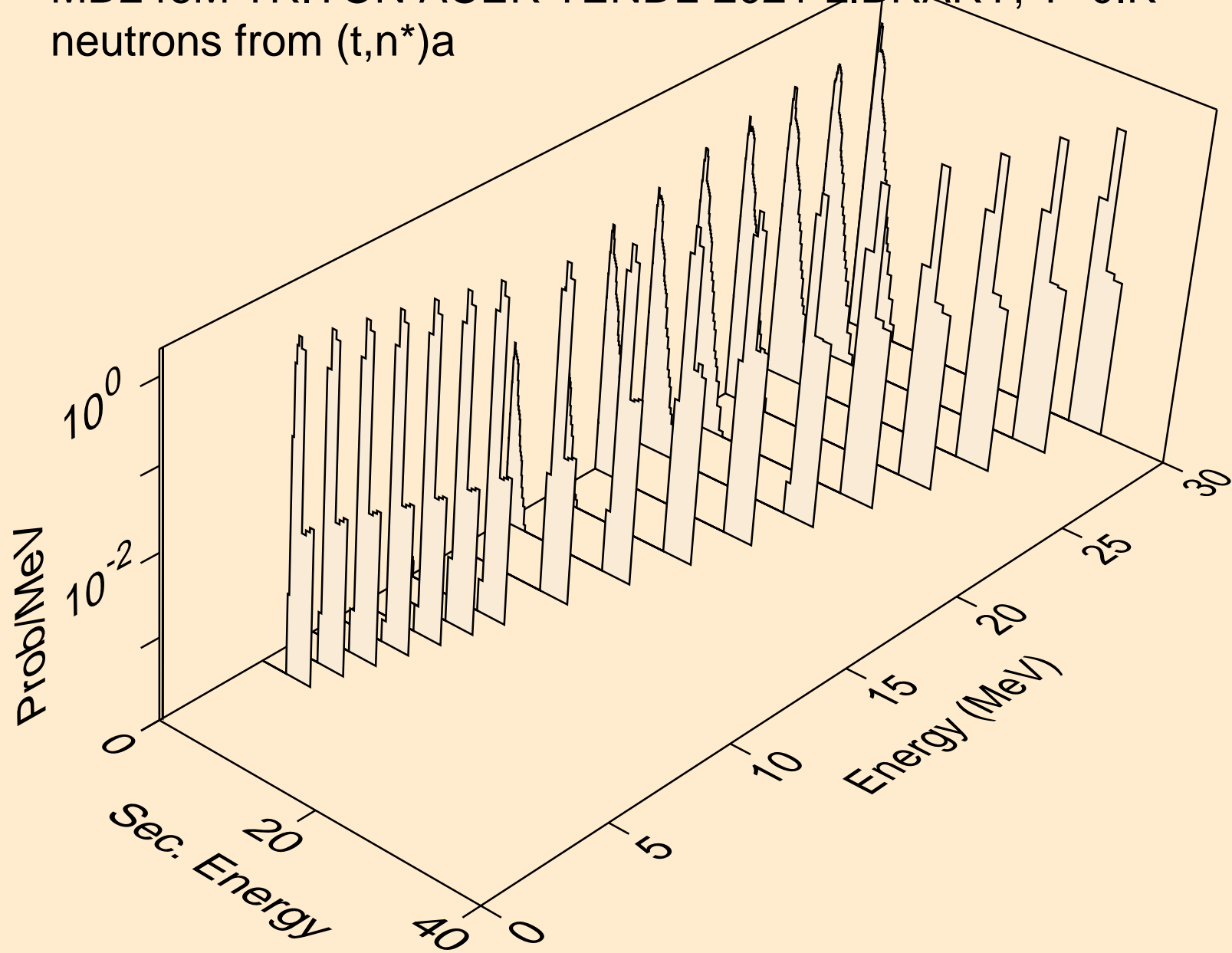

MD246M TRITON ACER TENDL-2021 LIBRARY; T=0.K  
neutrons from (t,2n)a

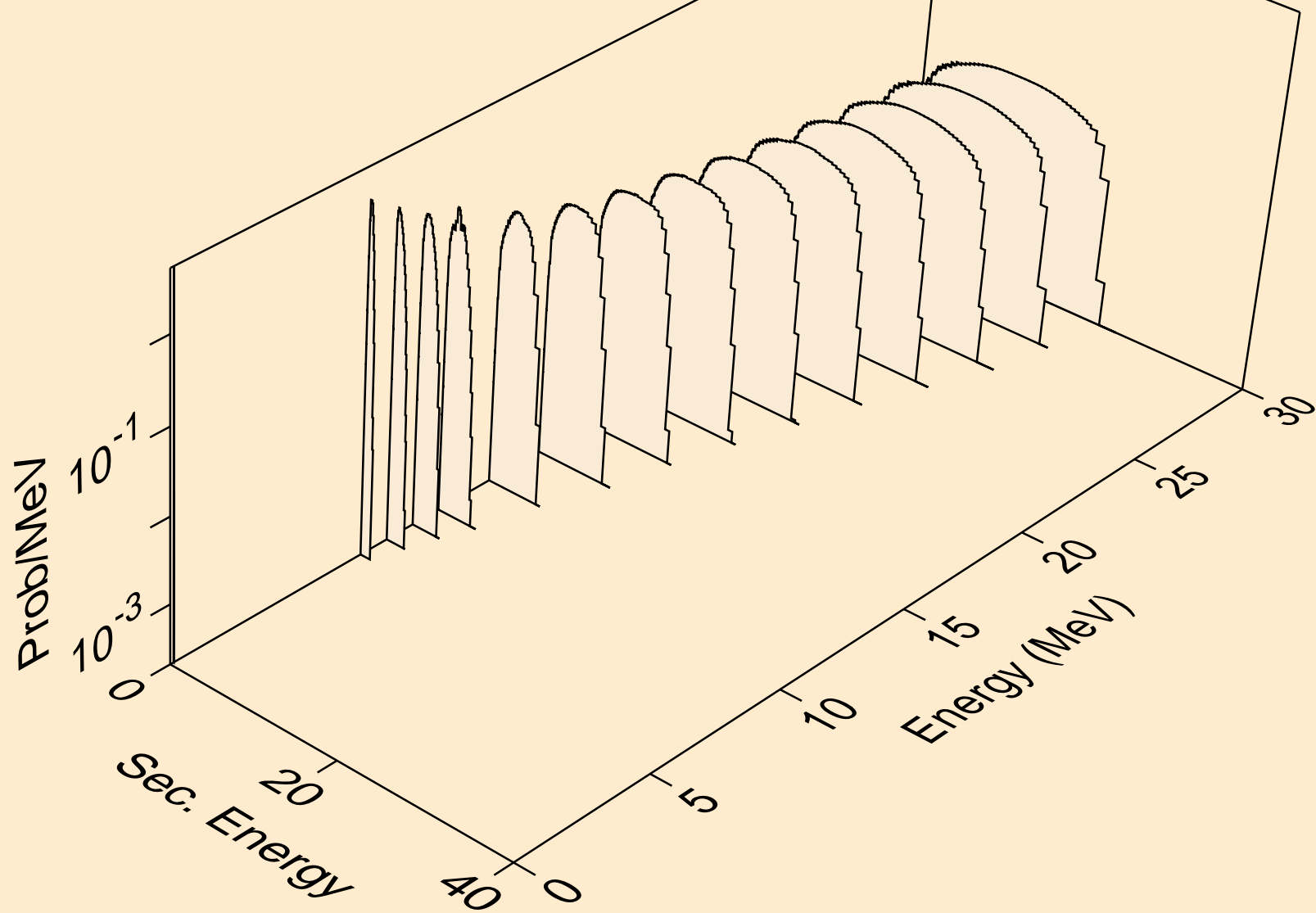



MD246M TRITON ACER TENDL-2021 LIBRARY; T=0.K  
neutrons from (t,n\*)p

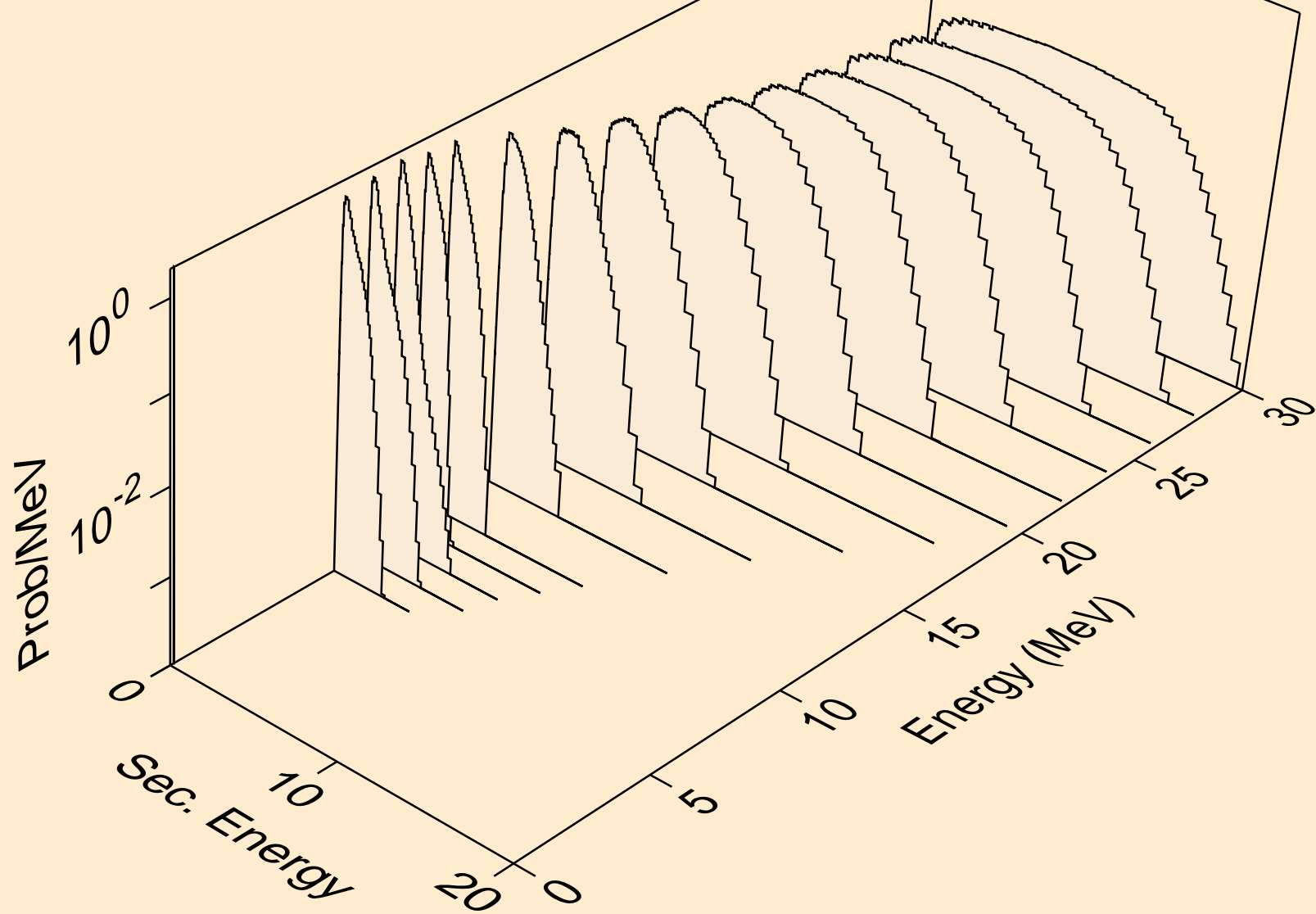

MD246M TRITON ACER TENDL-2021 LIBRARY; T=0.K  
neutrons from (t,n\*)d

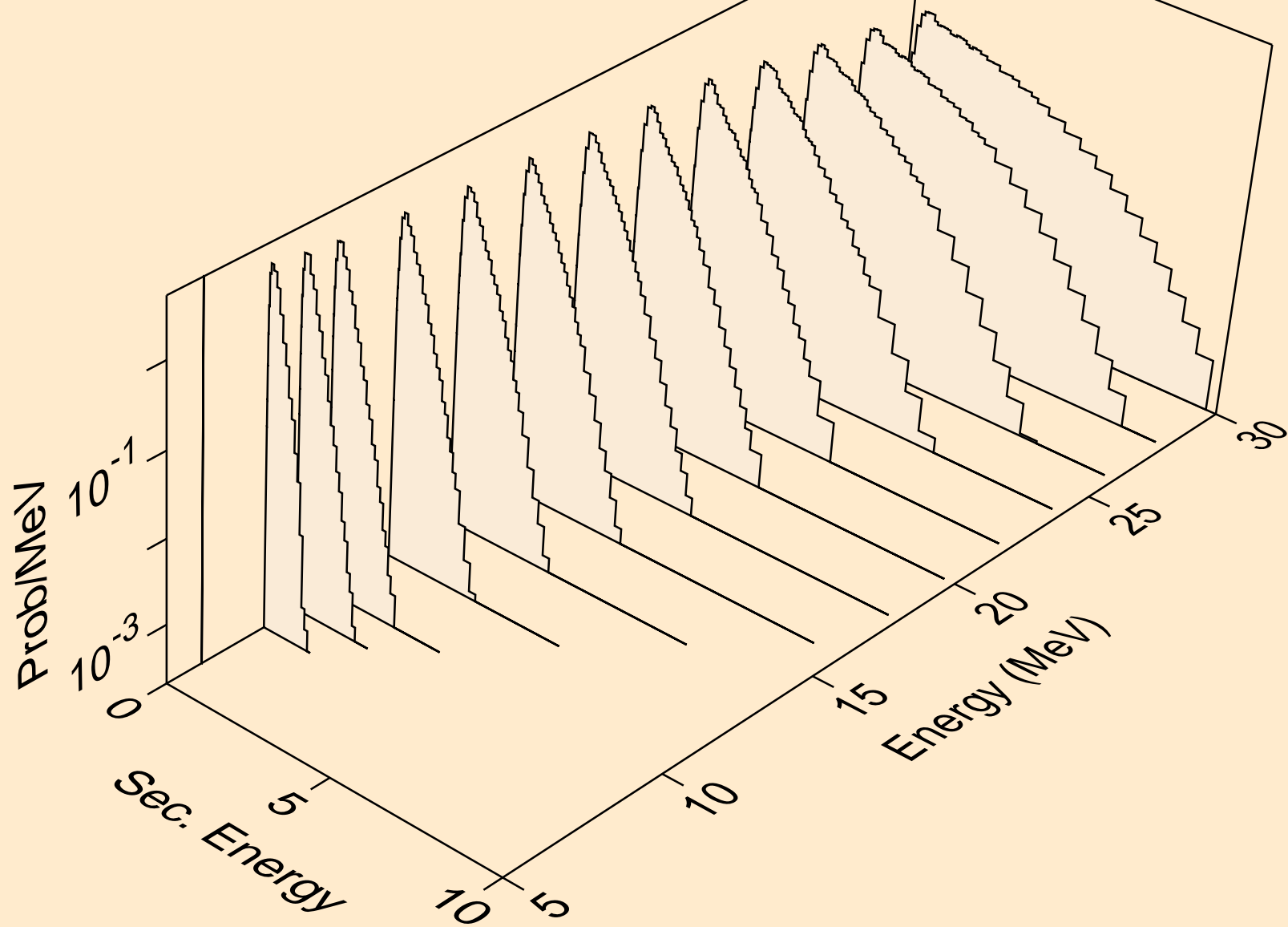

MD246M TRITON ACER TENDL-2021 LIBRARY; T=0.K  
neutrons from (t,n\*)t

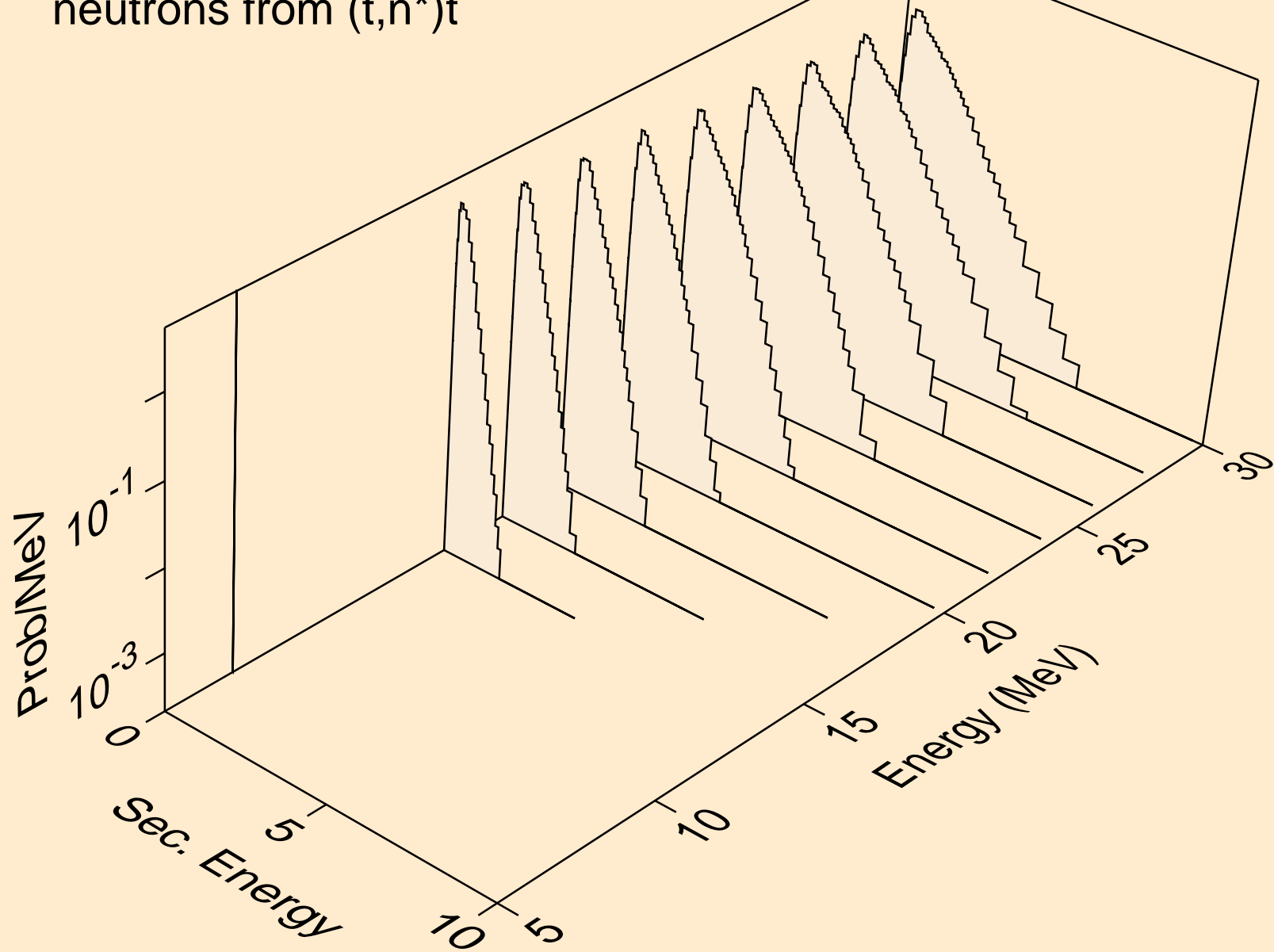

MD246M TRITON ACER TENDL-2021 LIBRARY; T=0.K  
neutrons from (t,n\*)he3

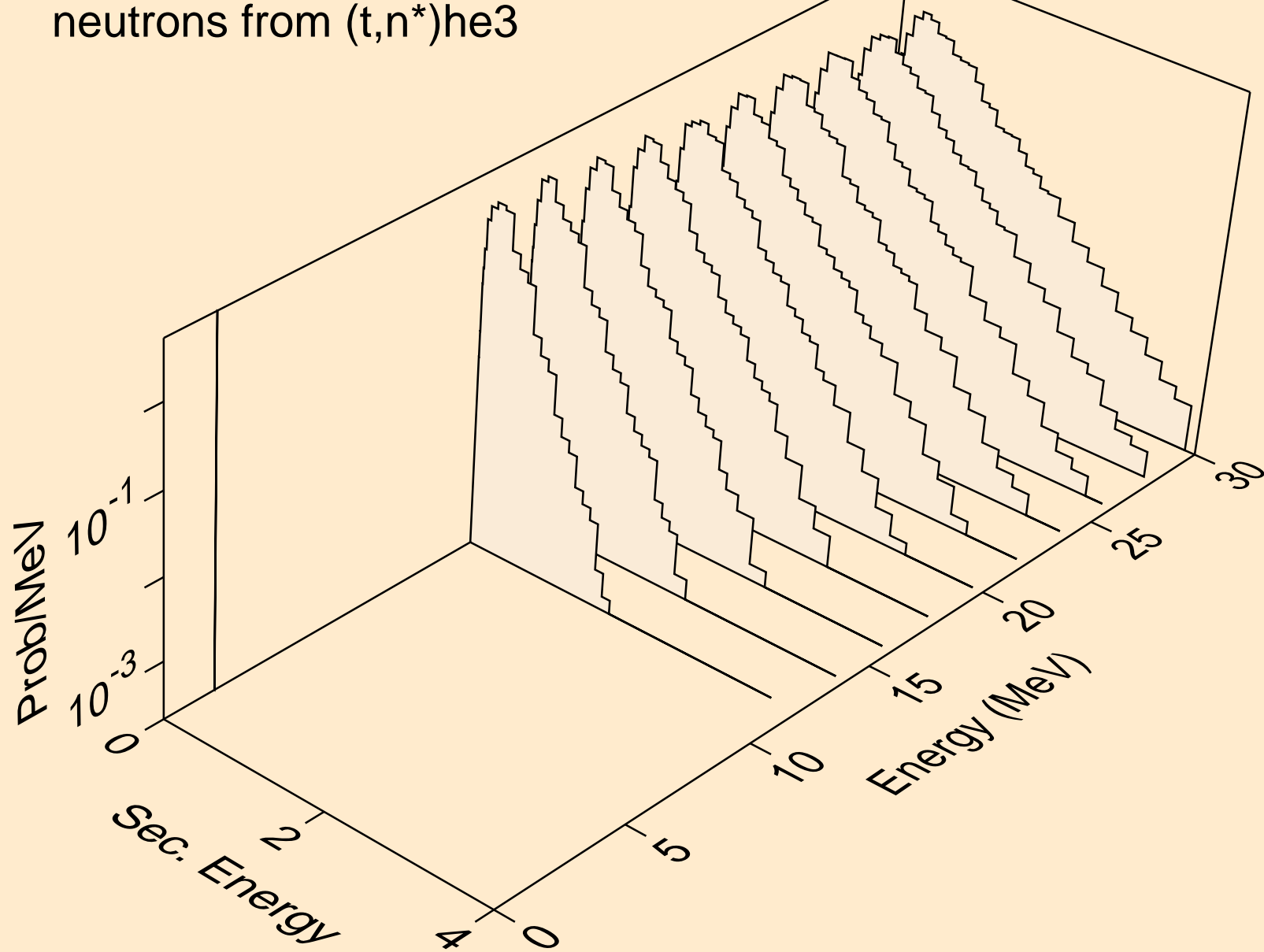

MD246M TRITON ACER TENDL-2021 LIBRARY; T=0.K  
neutrons from (t,2np)

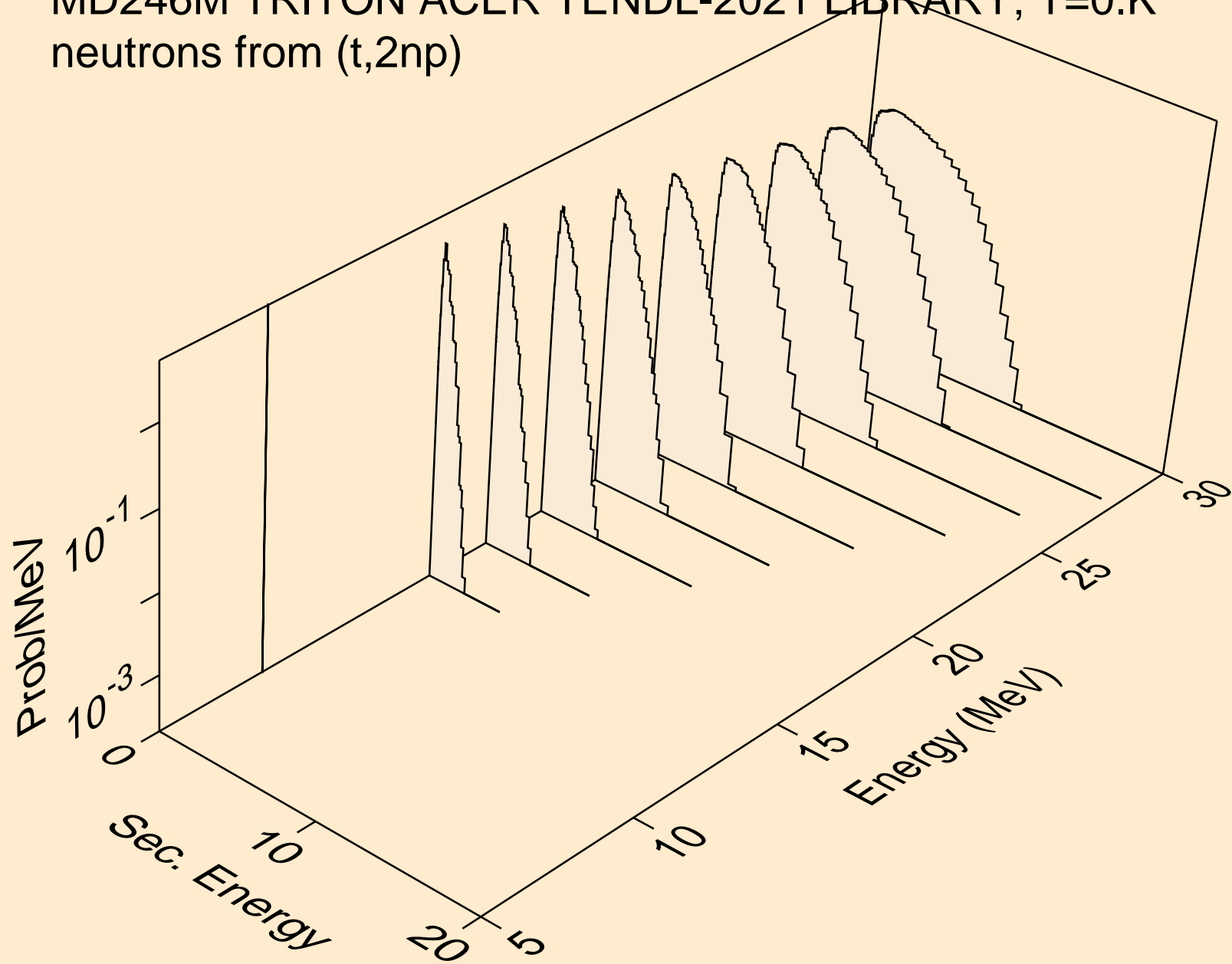

MD246M TRITON ACER TENDL-2021 LIBRARY; T=0.K  
neutrons from (t,3np)

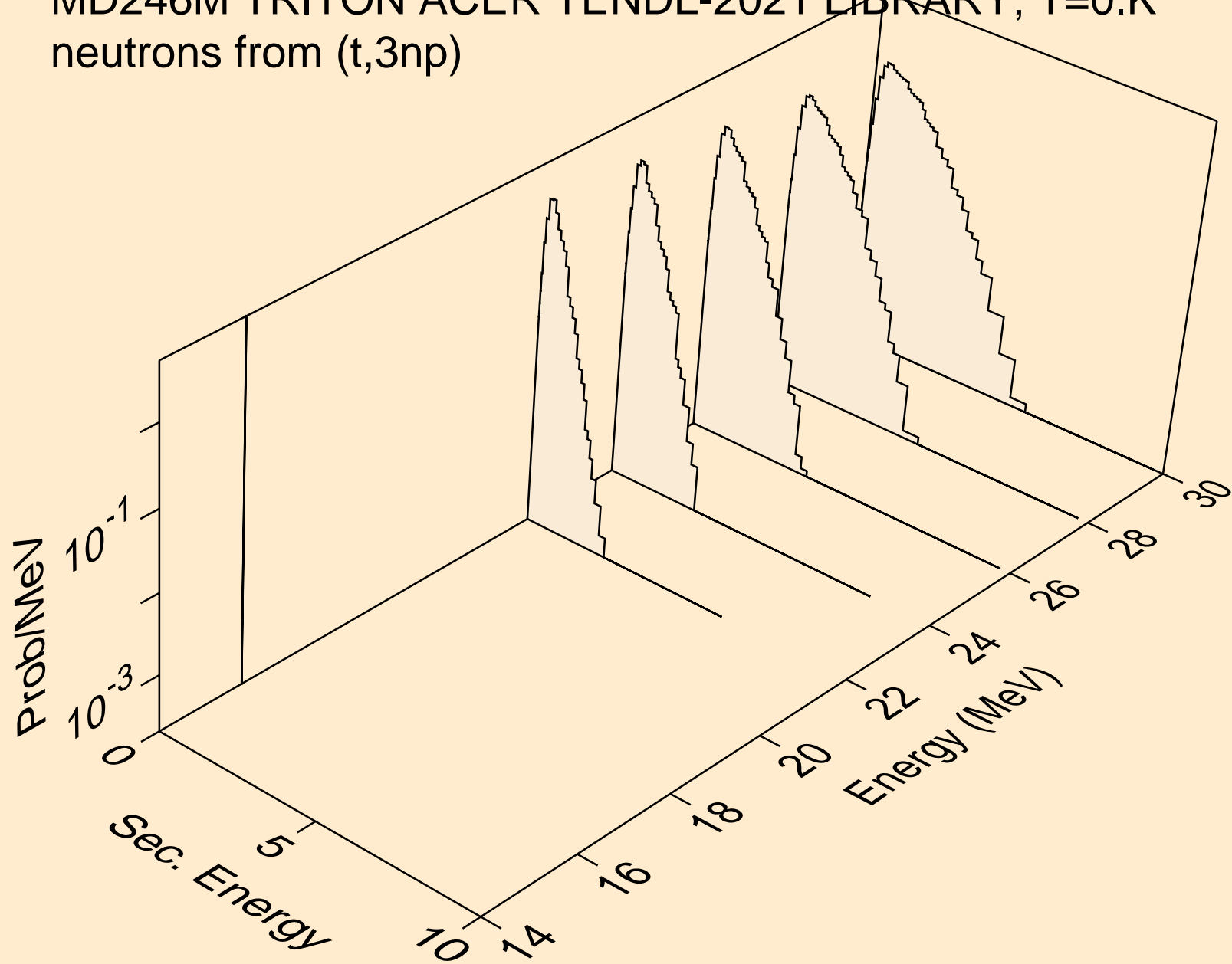

MD246M TRITON ACER TENDL-2021 LIBRARY; T=0.K  
neutrons from (t,2np)

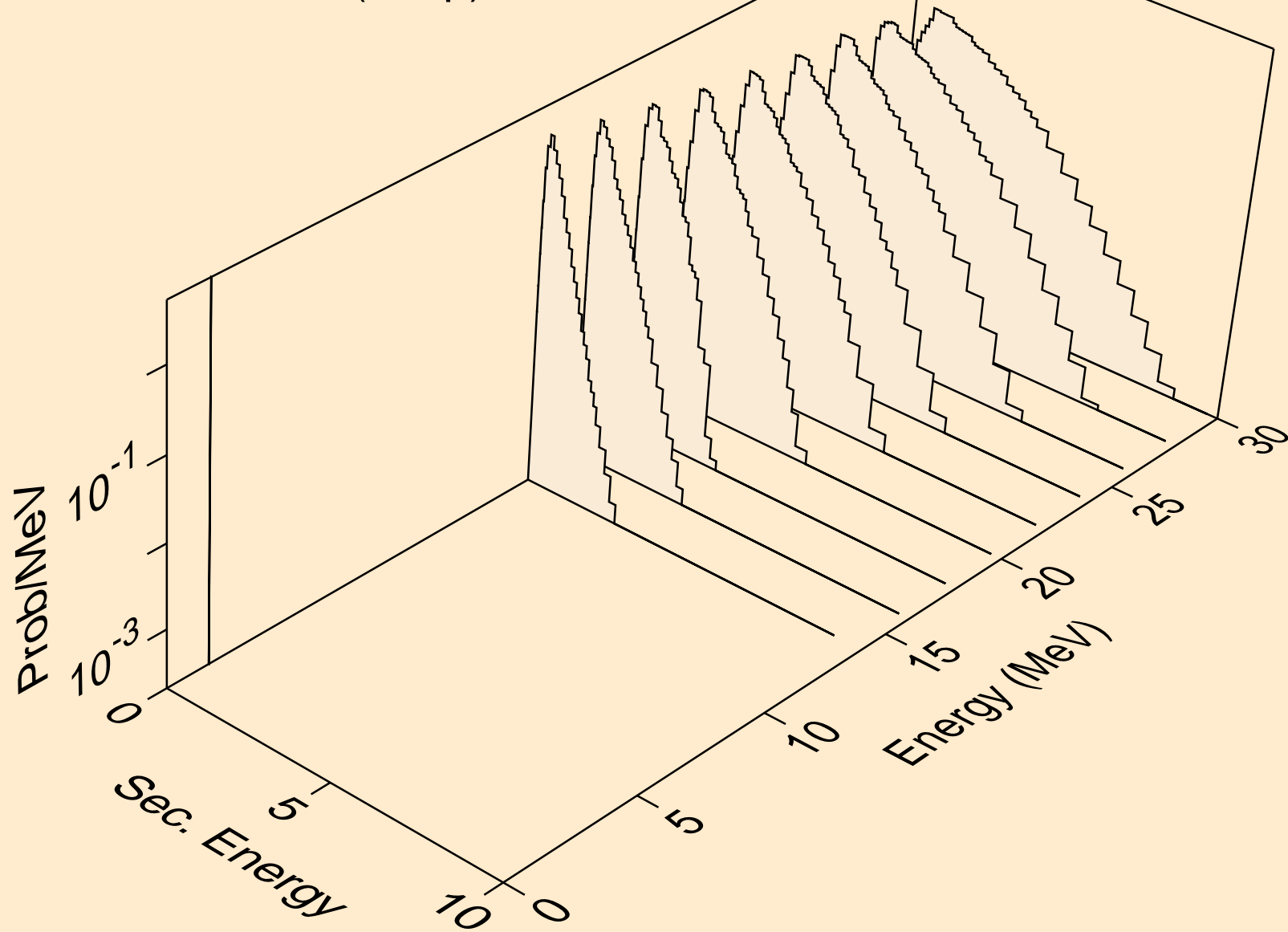

MD246M TRITON ACER TENDL-2021 LIBRARY; T=0.K  
neutrons from (t,npa)

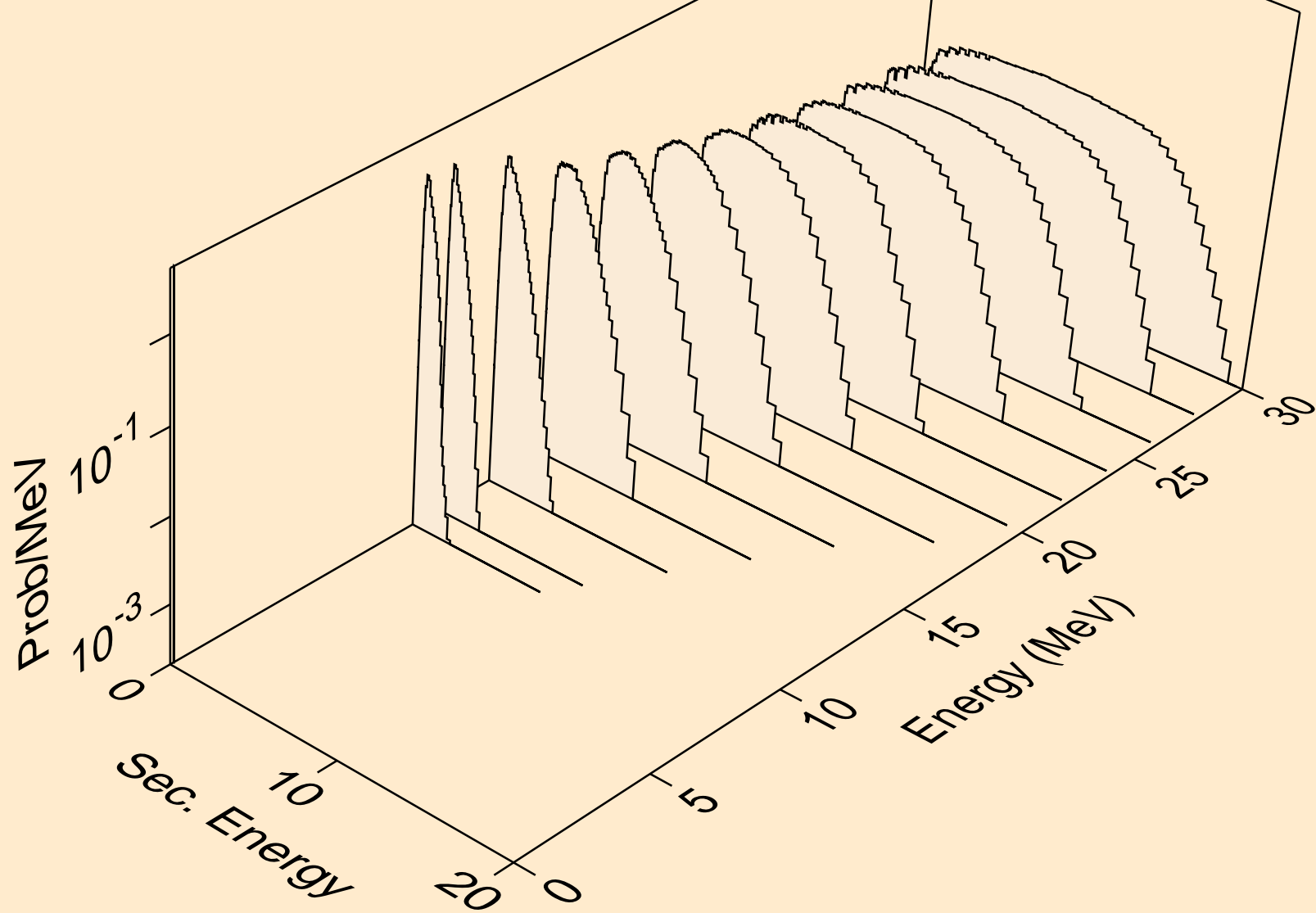



MD246M TRITON ACER TENDL-2021 LIBRARY; T=0.K  
protons from (t,x)

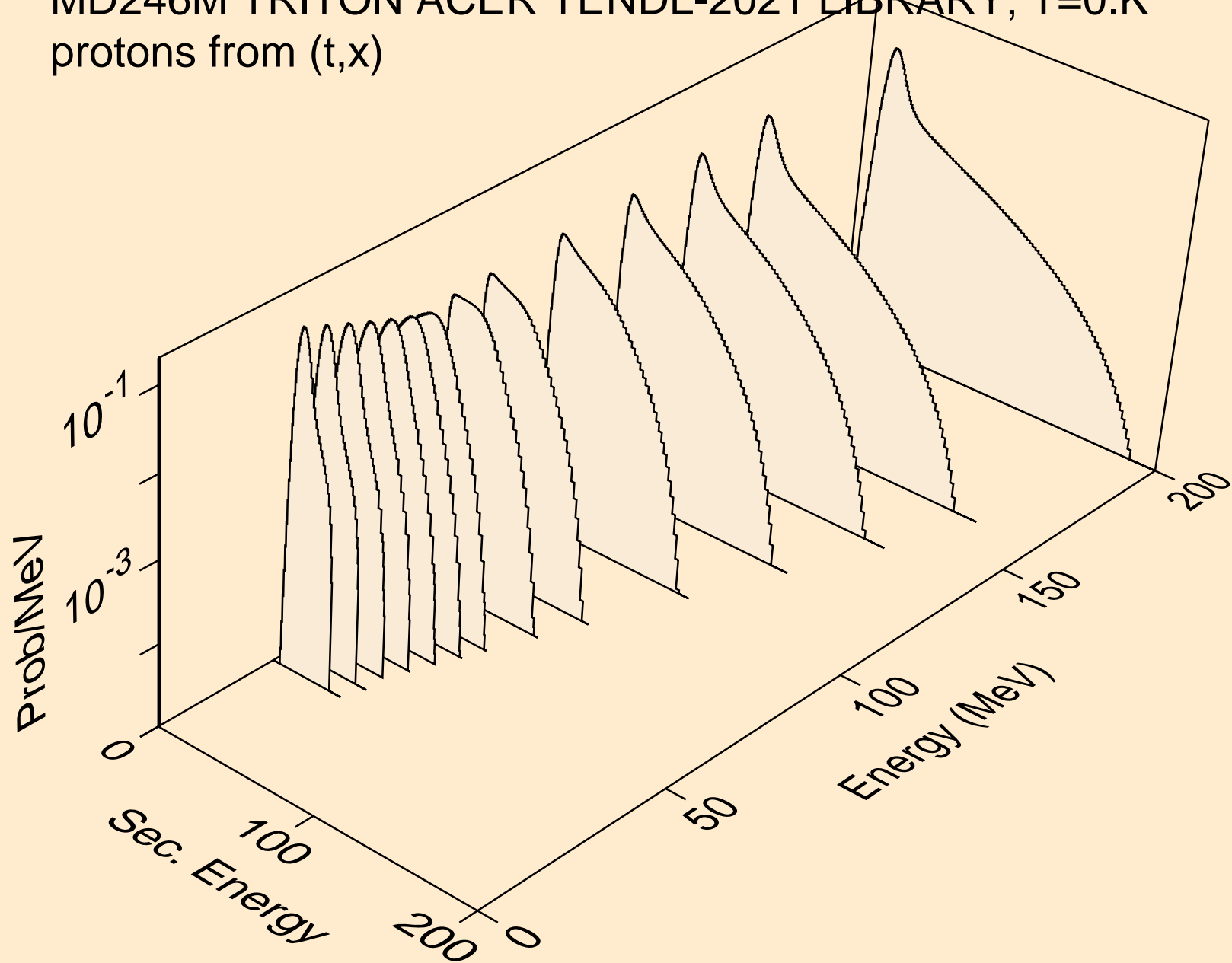

MD246M TRITON ACER TENDL-2021 LIBRARY; T=0.K  
protons from (t,n\*)p

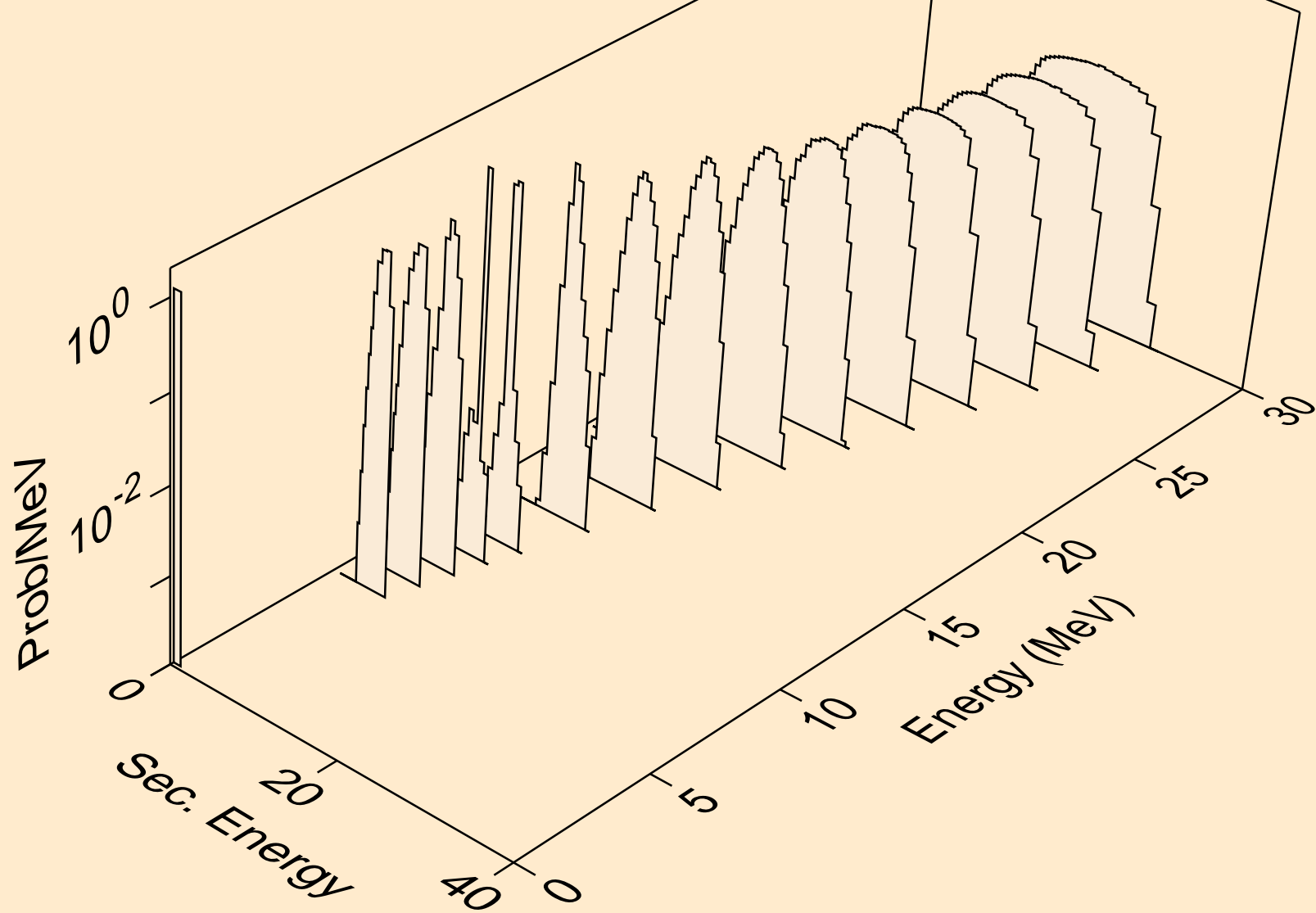

MD246M TRITON ACER TENDL-2021 LIBRARY; T=0.K  
protons from (t,2np)

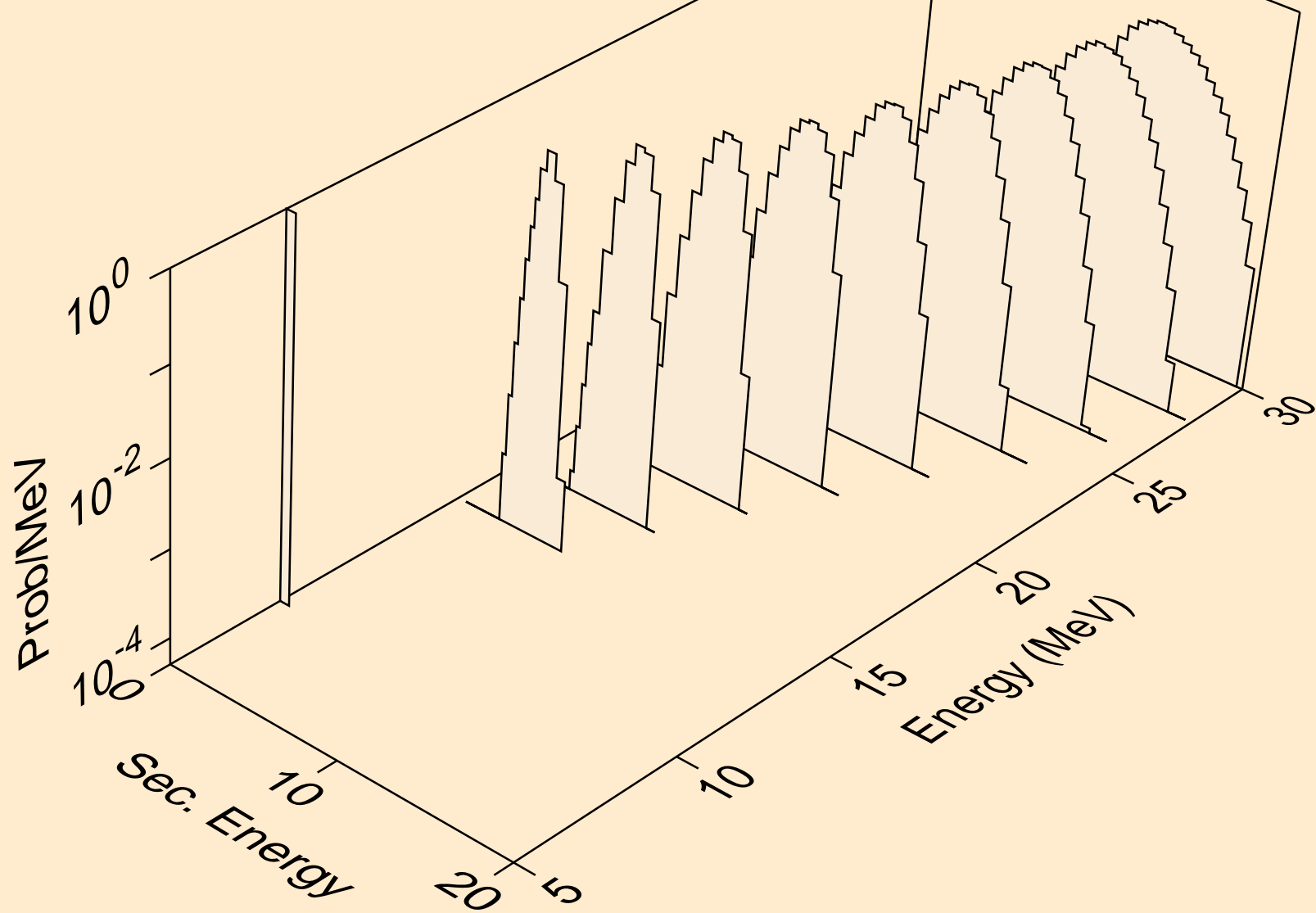

MD246M TRITON ACER TENDL-2021 LIBRARY; T=0.K  
protons from (t,3np)

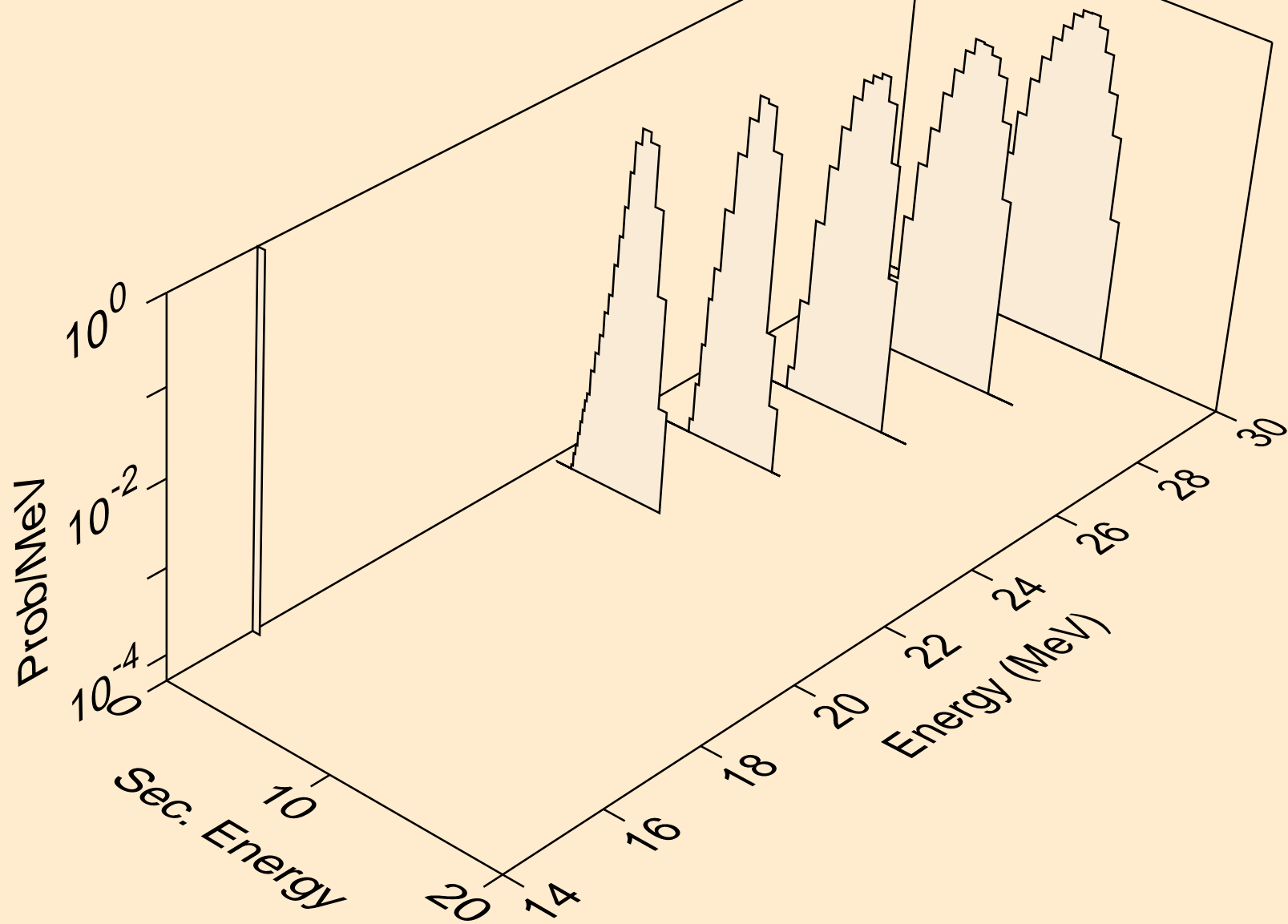

MD246M TRITON ACER TENDL-2021 LIBRARY; T=0.K  
protons from (t,2np)

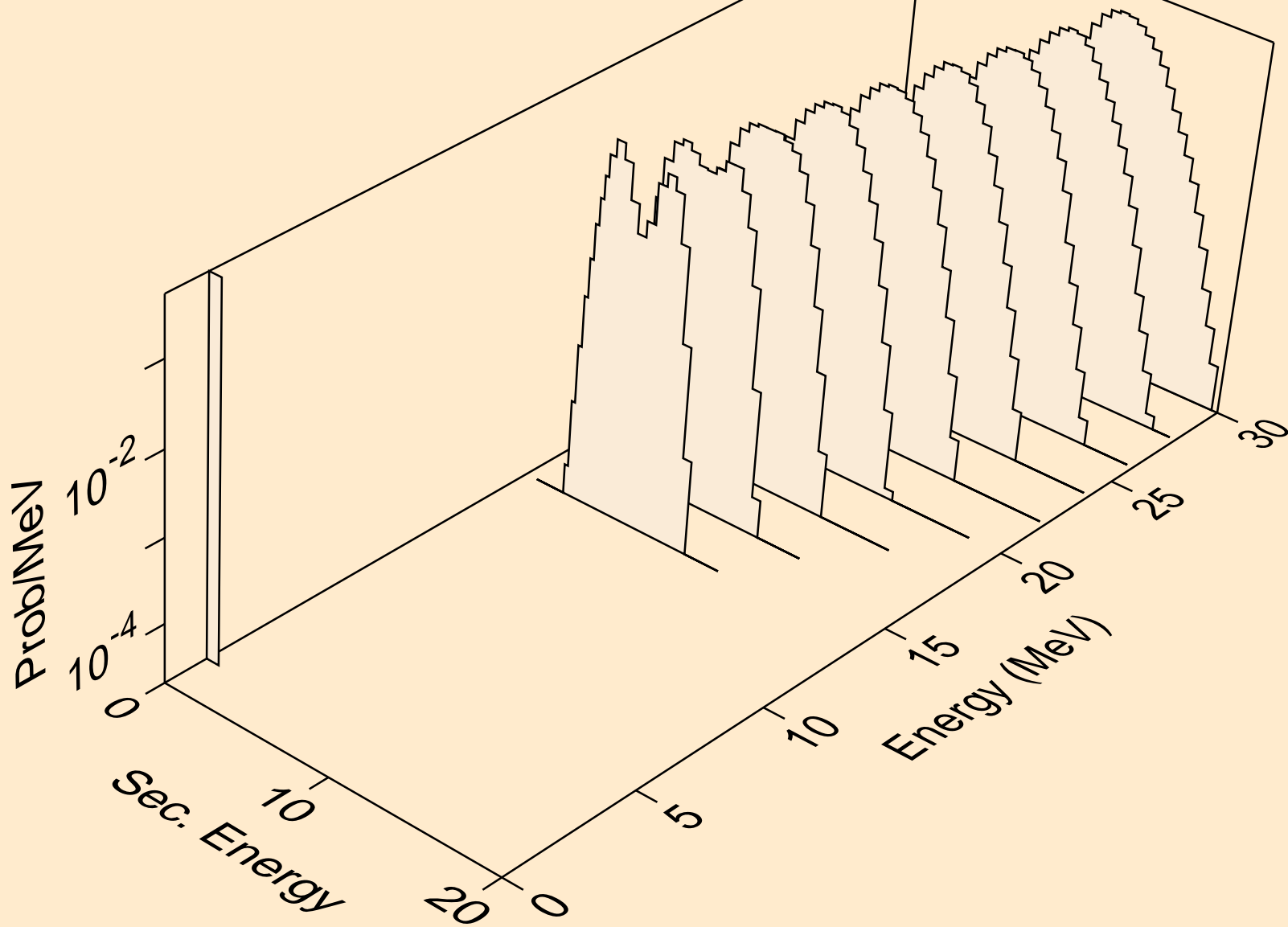

MD246M TRITON ACER TENDL-2021 LIBRARY; T=0.K  
protons from (t,npa)

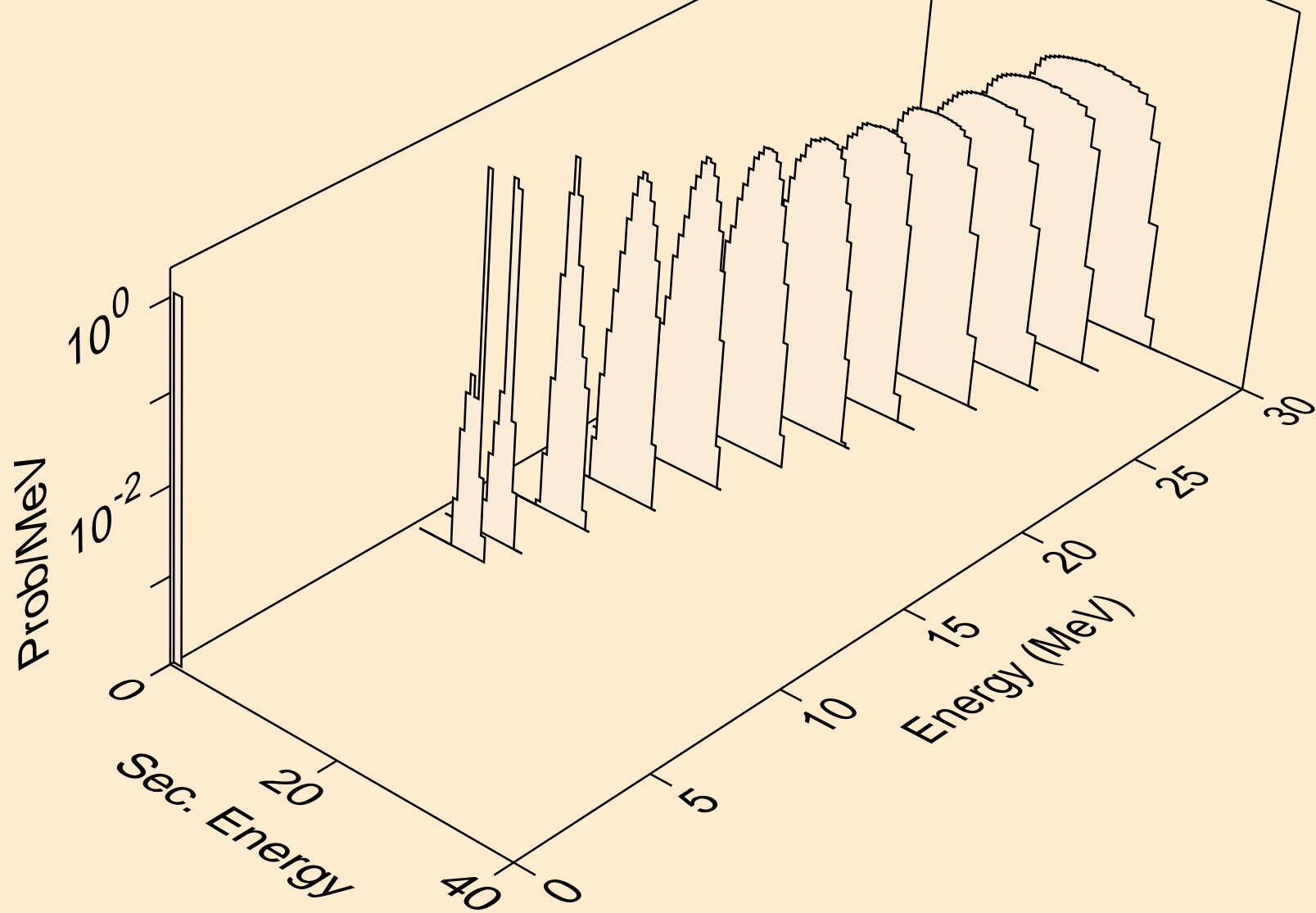

MD246M TRITON ACER TENDL-2021 LIBRARY; T=0.K  
protons from (t,p)

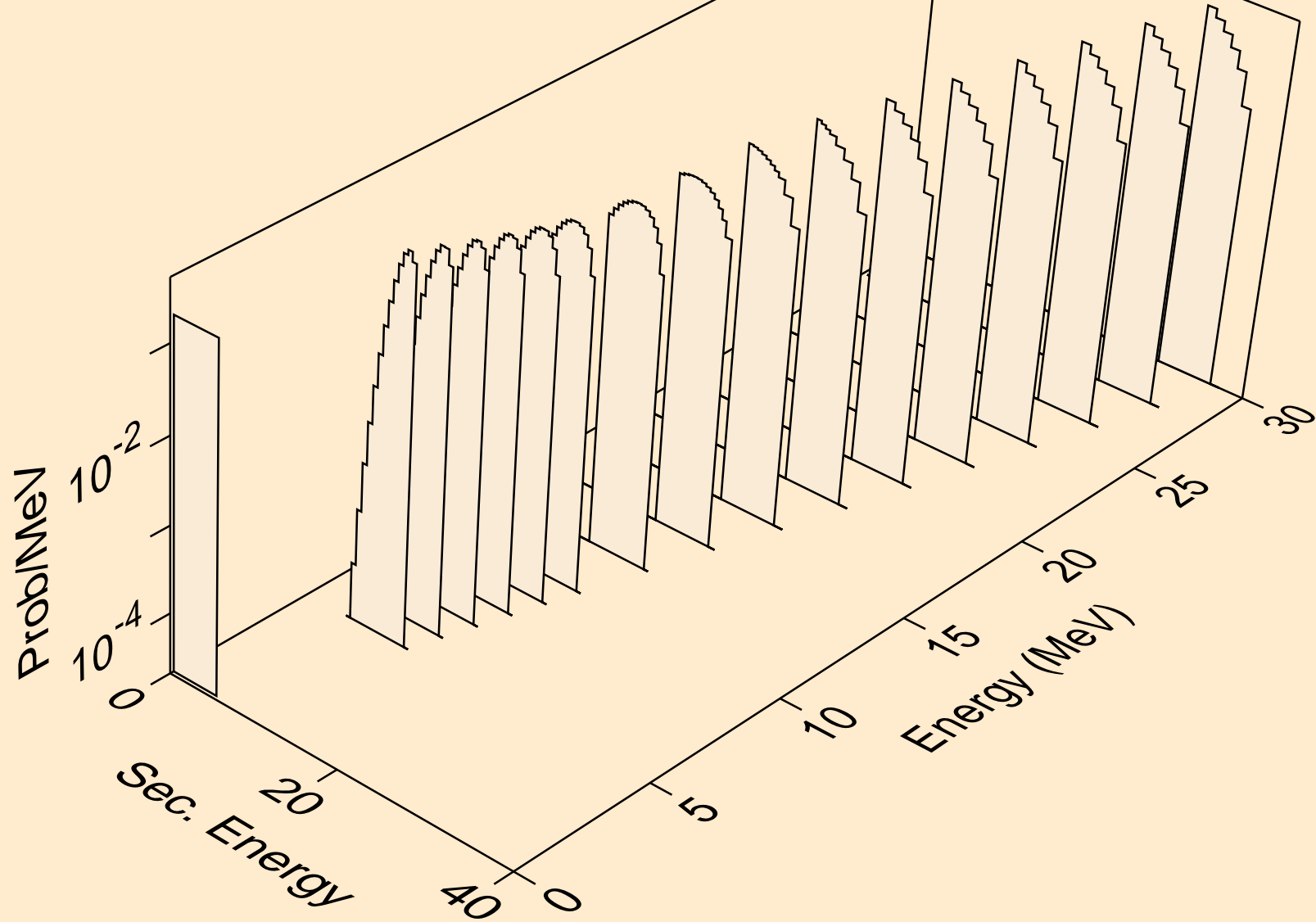

MD246M TRITON ACER TENDL-2021 LIBRARY; T=0.K  
protons from (t,2p)

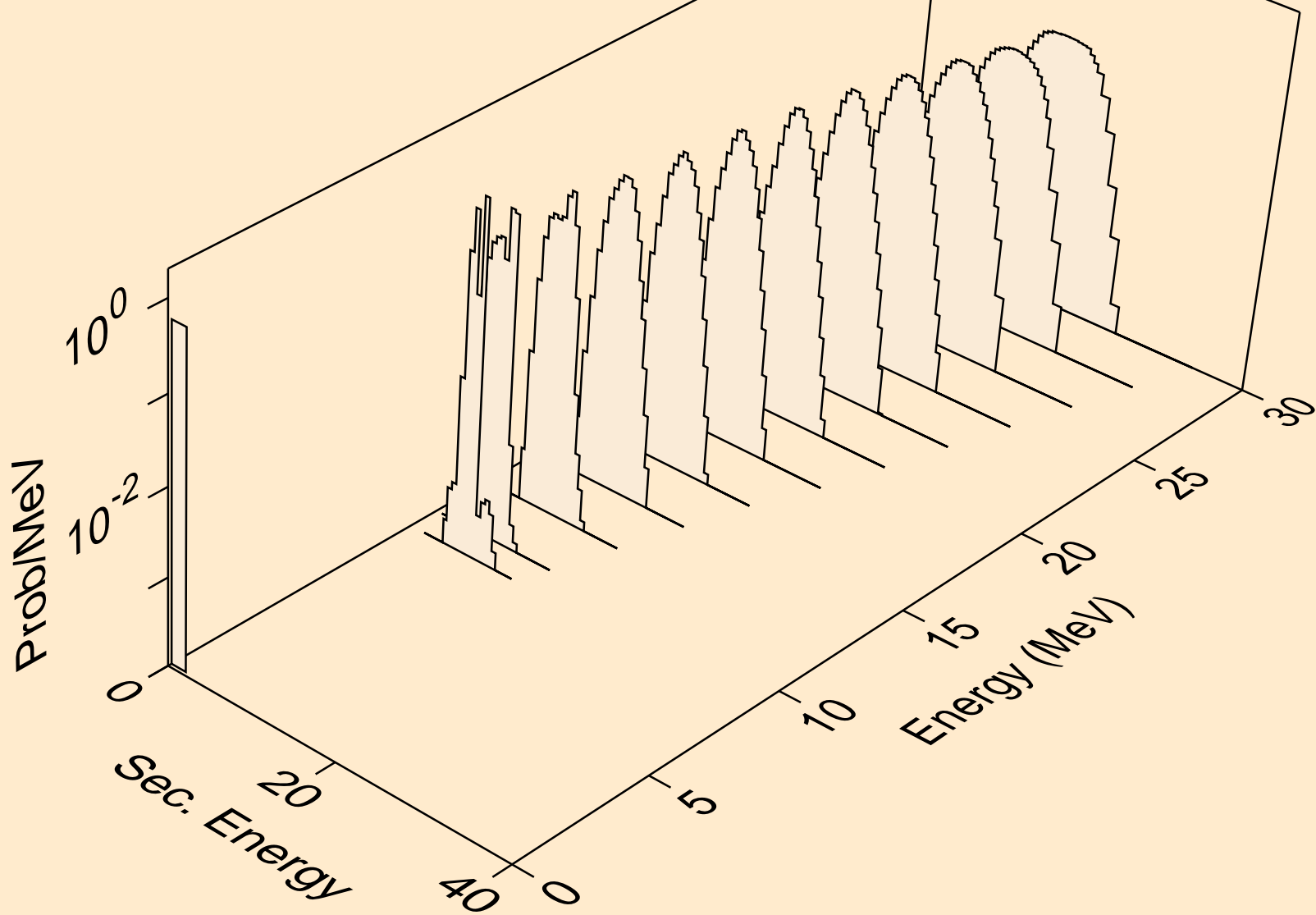



MD246M TRITON ACER TENDL-2021 LIBRARY; T=0.K  
protons from (t,pa)

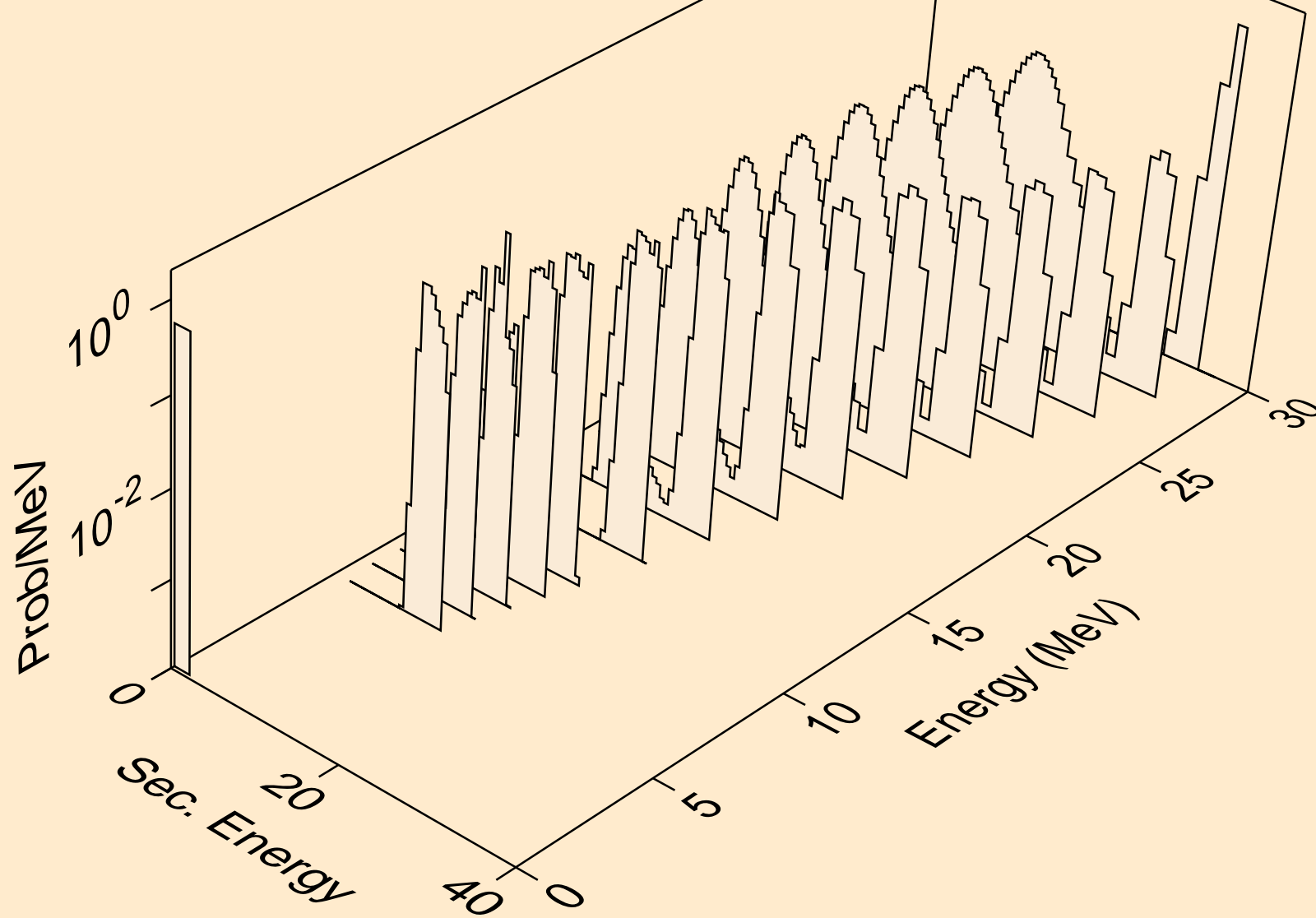

MD246M TRITON ACER TENDL-2021 LIBRARY; T=0.K  
protons from (t,pd)

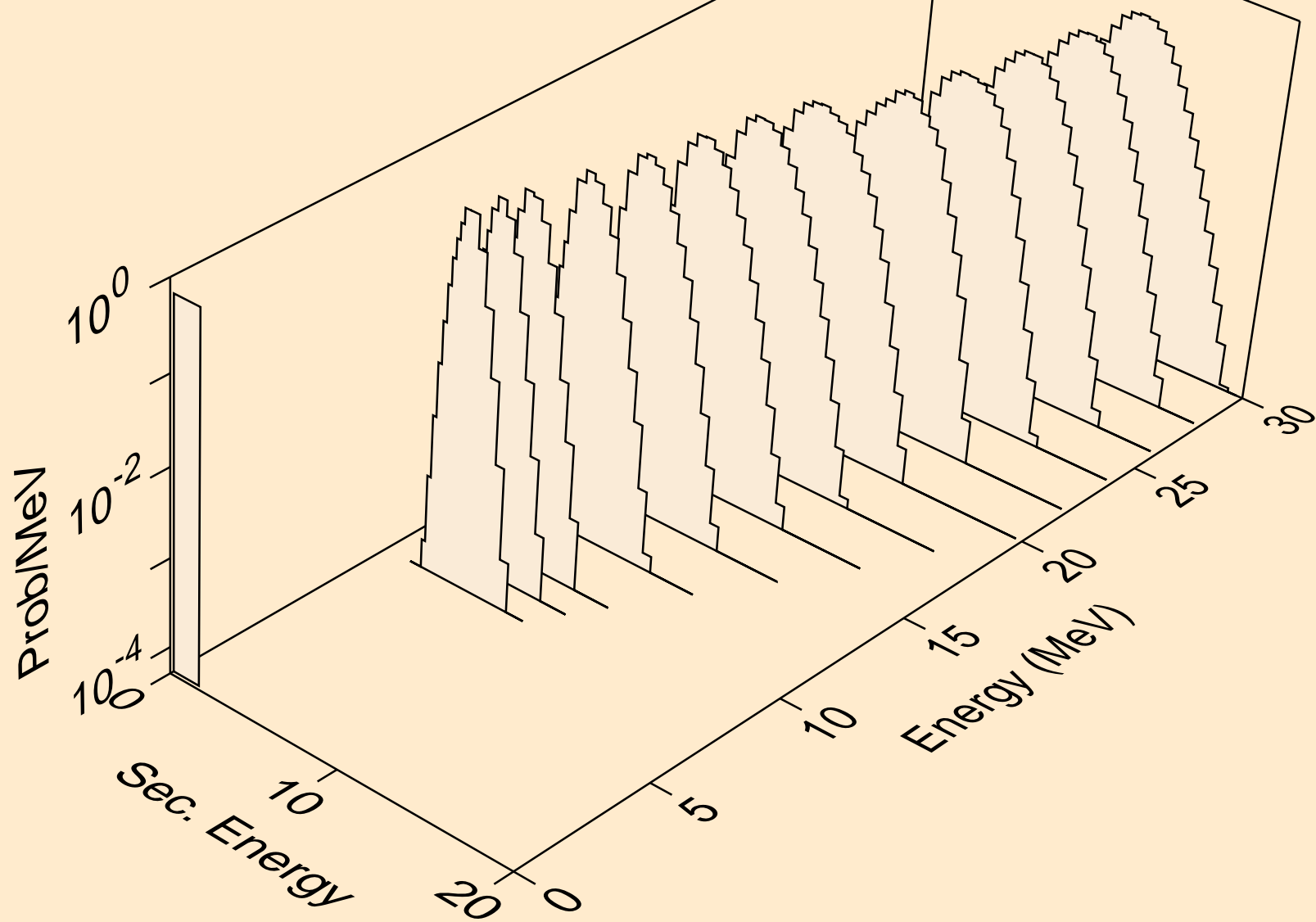

MD246M TRITON ACER TENDL-2021 LIBRARY; T=0.K  
deuterons from (t,x)

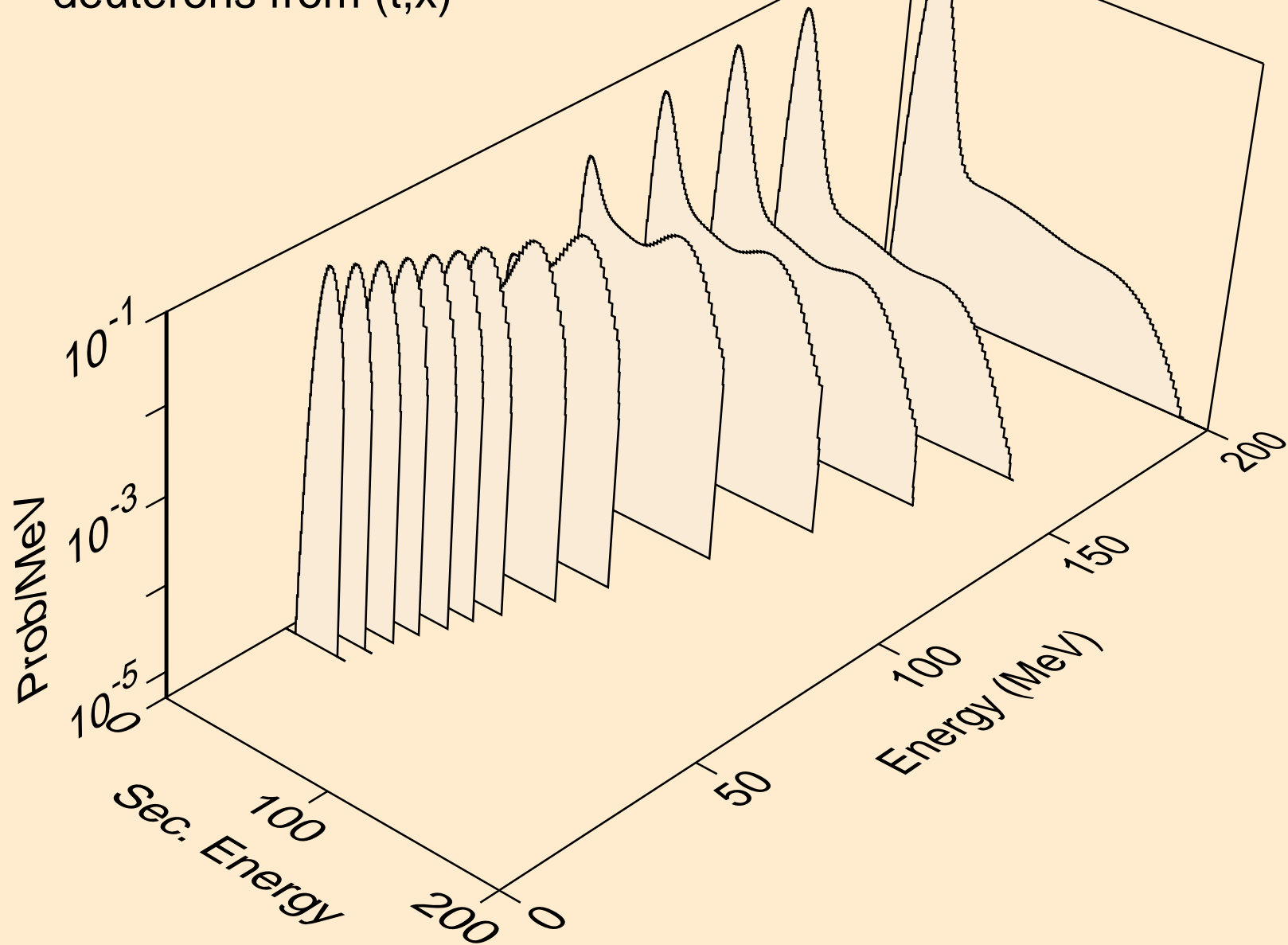

MD246M TRITON ACER TENDL-2021 LIBRARY; T=0.K  
deuterons from (t,n\*)d

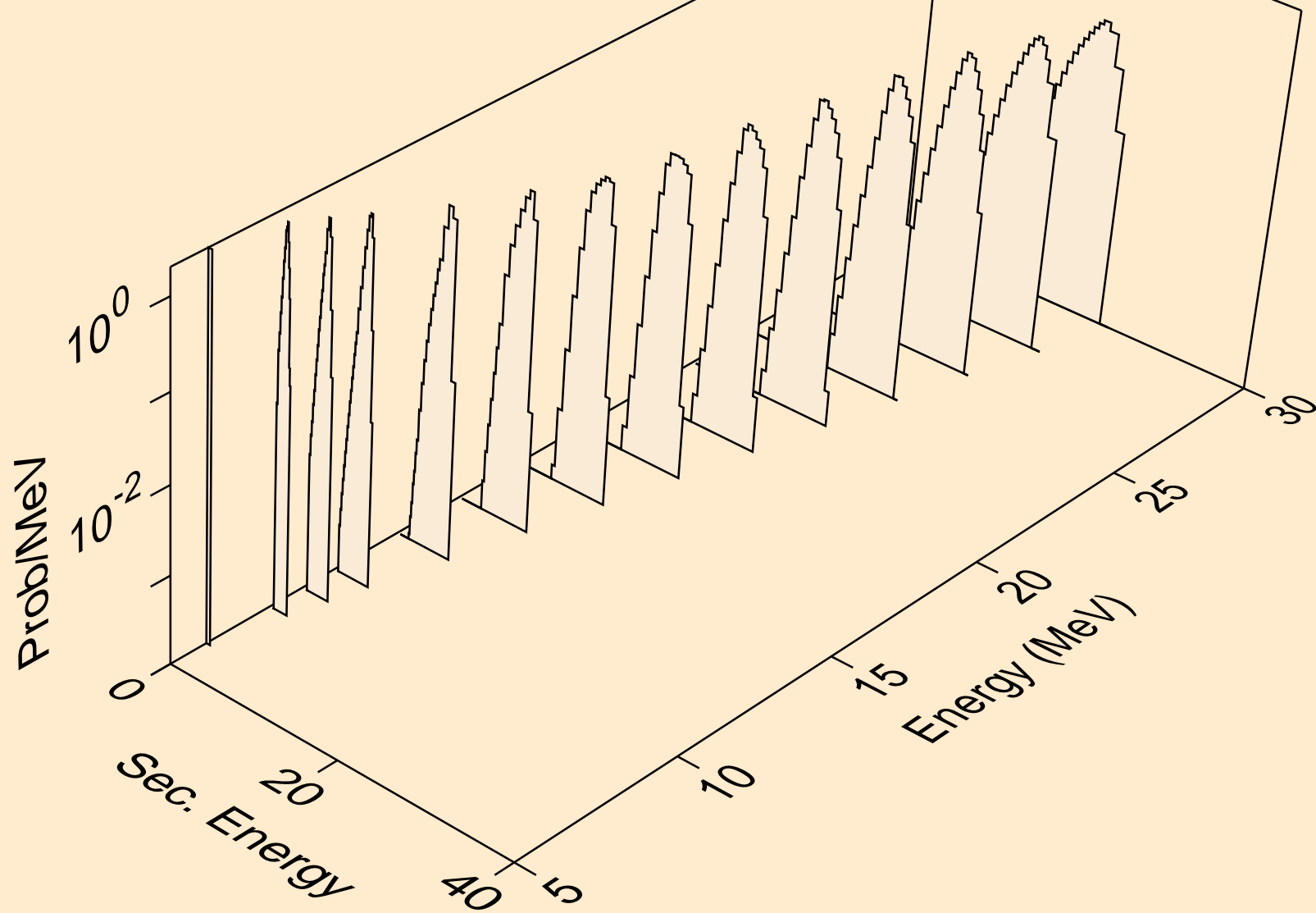

MD246M TRITON ACER TENDL-2021 LIBRARY; T=0.K  
deuterons from (t,d)

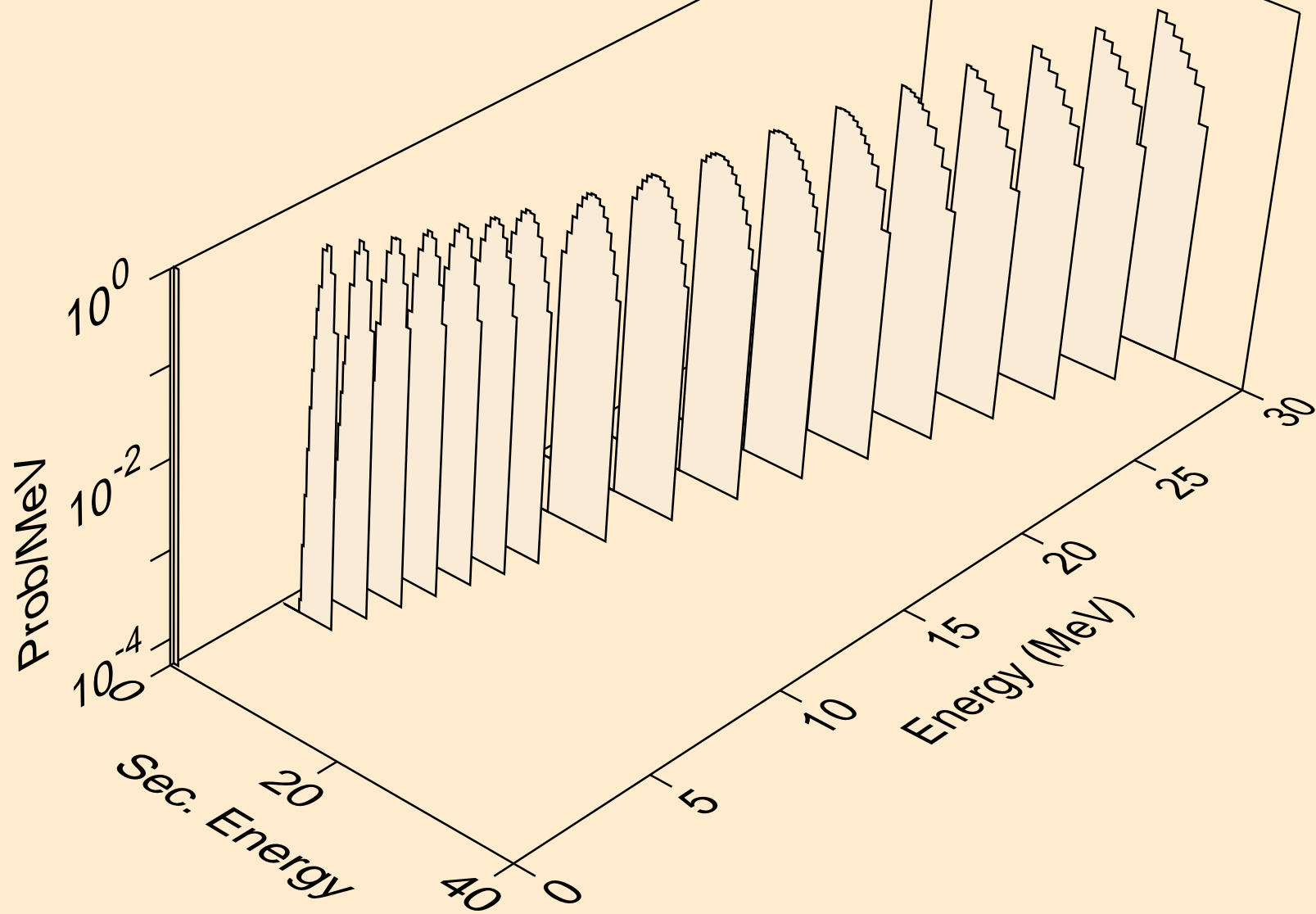

MD246M TRITON ACER TENDL-2021 LIBRARY; T=0.K  
deuterons from (t,pd)

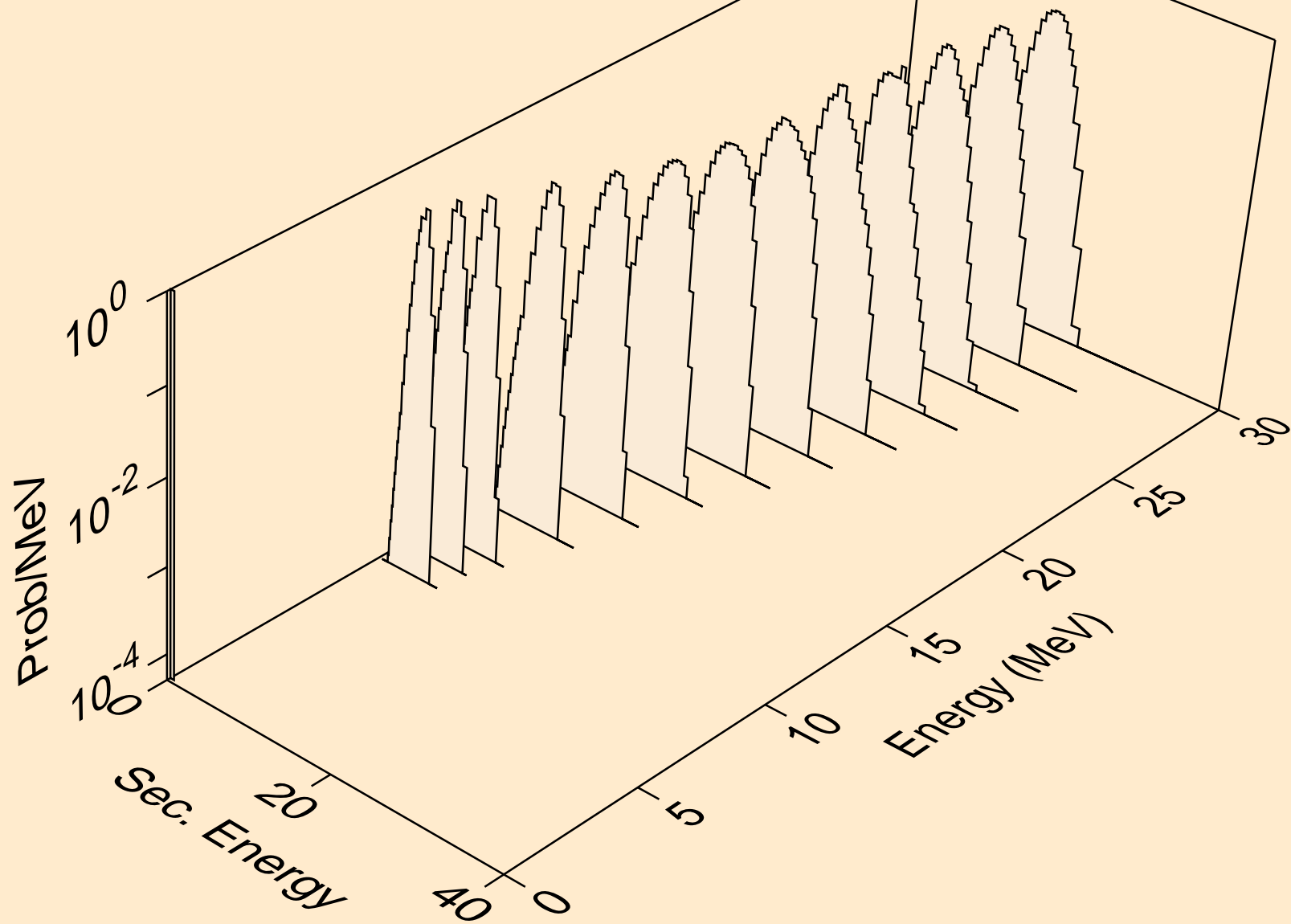

MD246M TRITON ACER TENDL-2021 LIBRARY; T=0.K  
deuterons from (t,da)

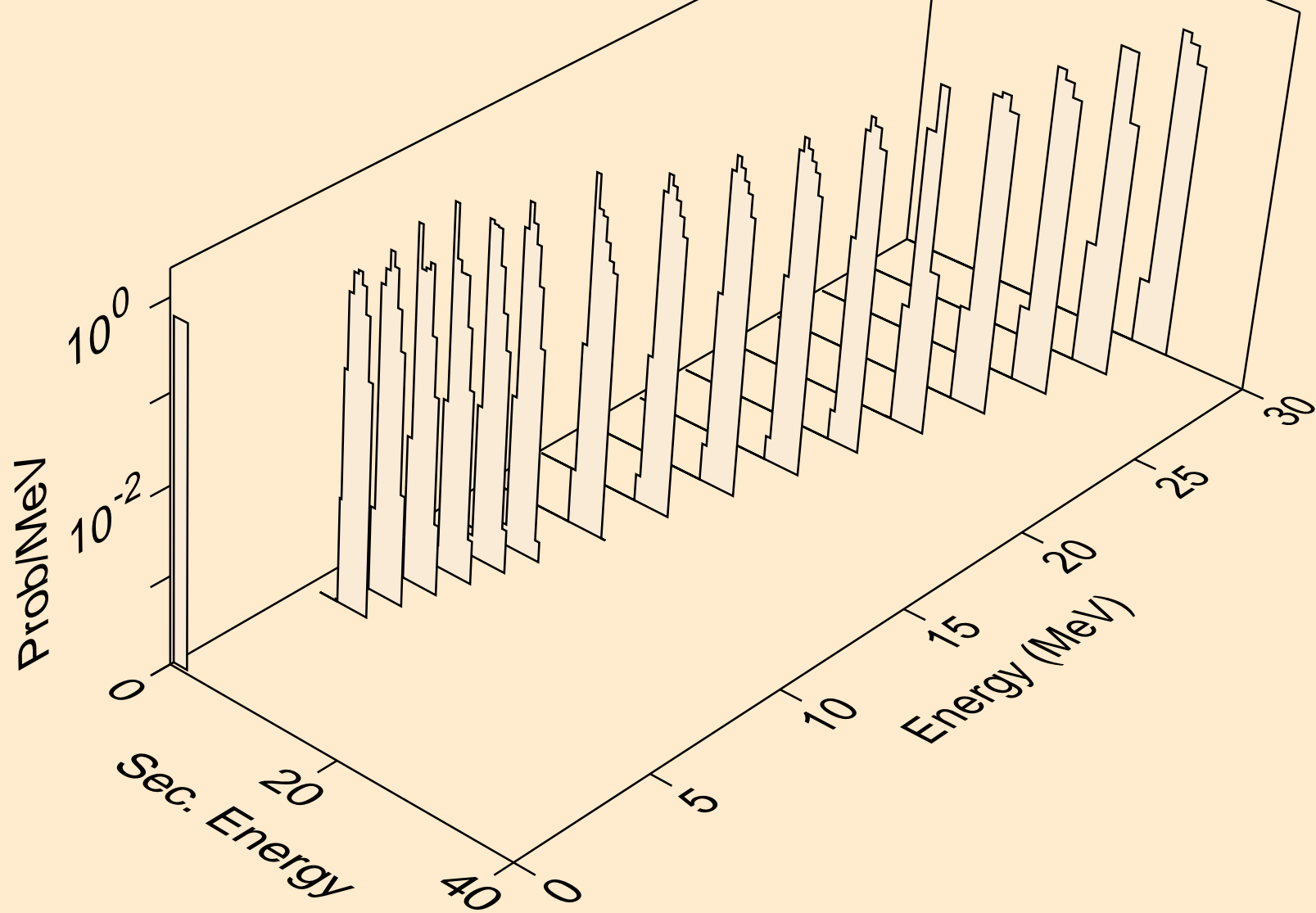

MD246M TRITON ACER TENDL-2021 LIBRARY; T=0.K  
he3s from (t,x)

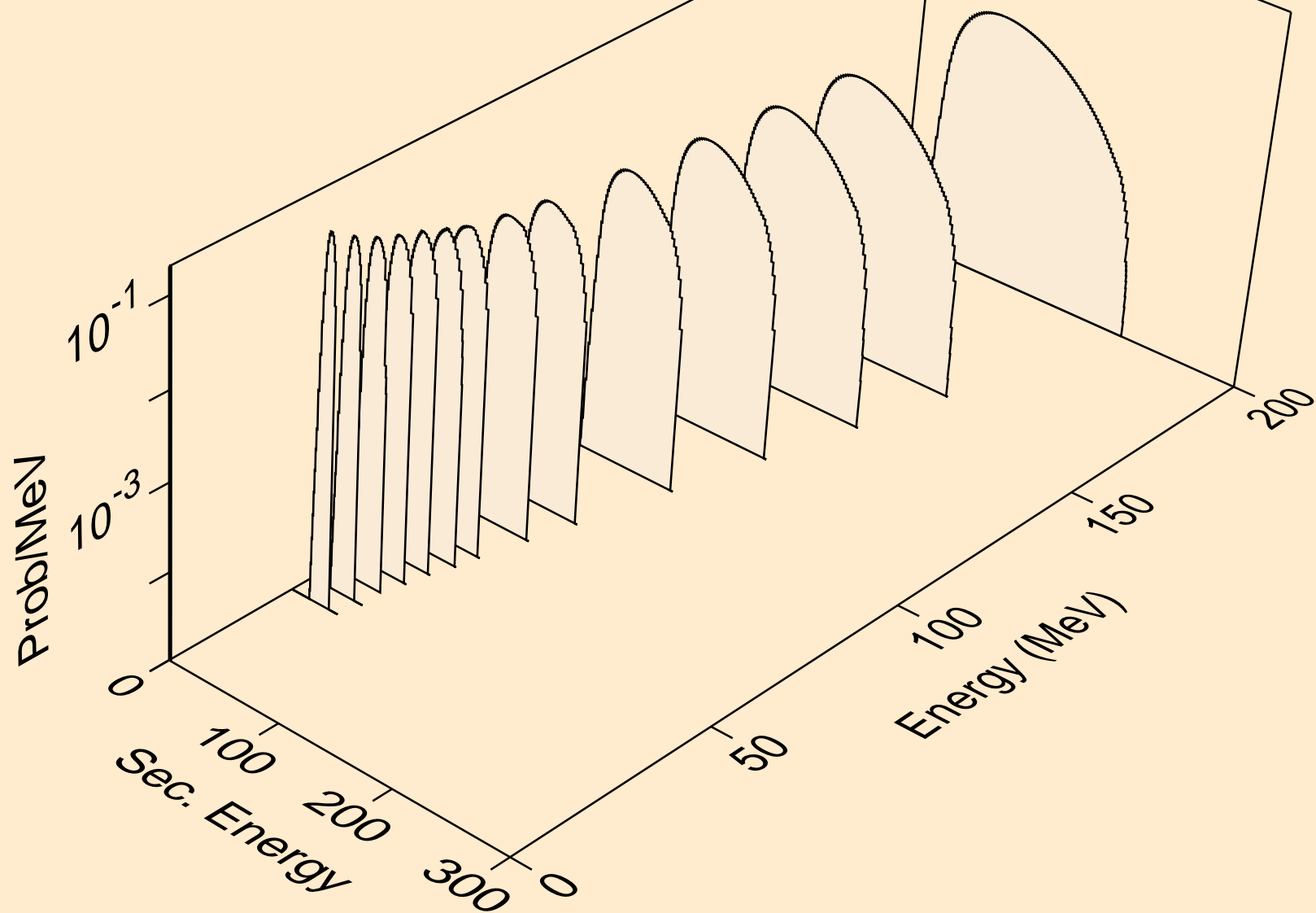



MD246M TRITON ACER TENDL-2021 LIBRARY; T=0.K  
he3s from (t,n\*)he3

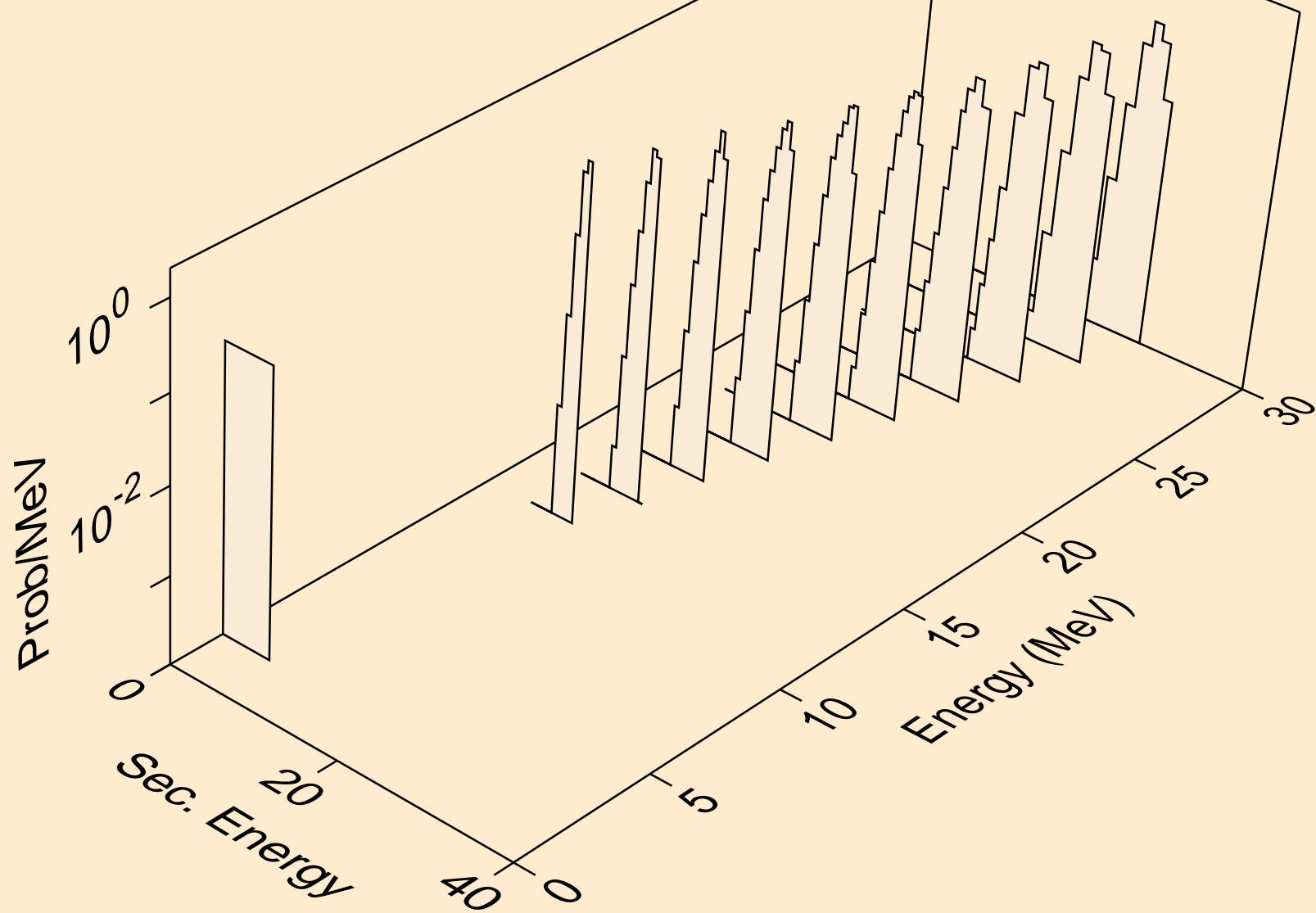

MD246M TRITON ACER TENDL-2021 LIBRARY; T=0.K  
he3s from (t,he3)

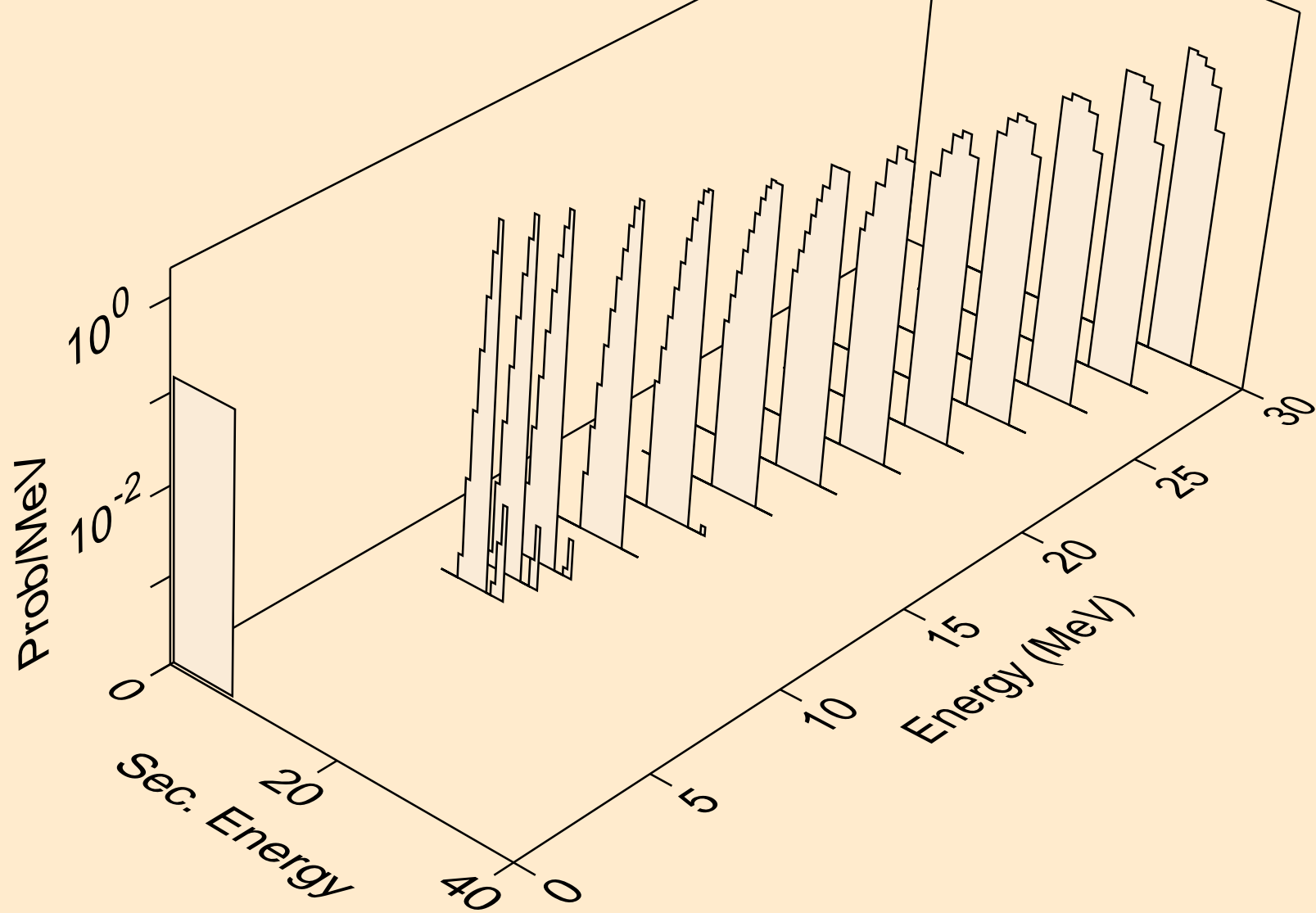

MD246M TRITON ACER TENDL-2021 LIBRARY; T=0.K  
alphas from (t,x)

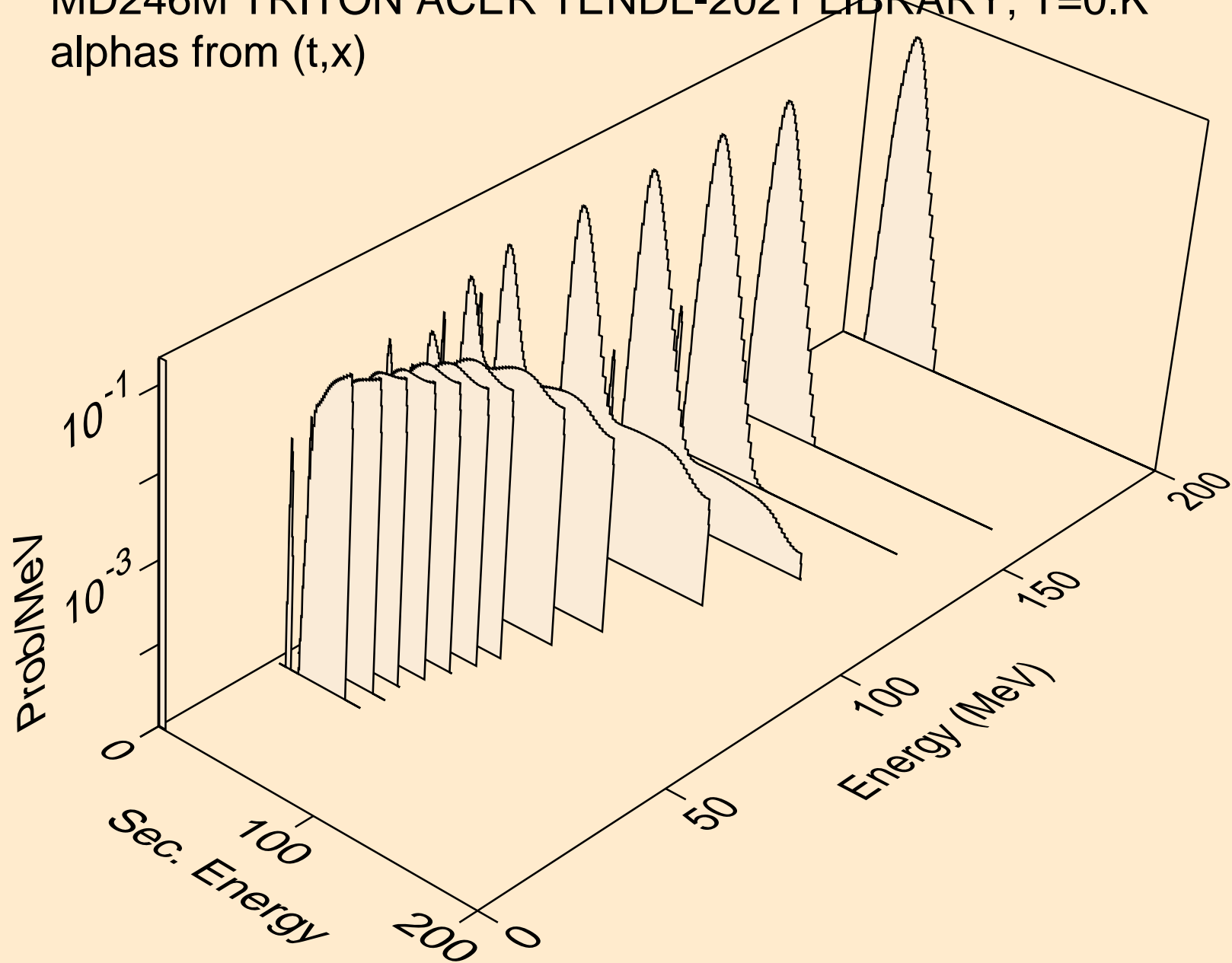

MD246M TRITON ACER TENDL-2021 LIBRARY; T=0.K  
alphas from (t,n\*)a

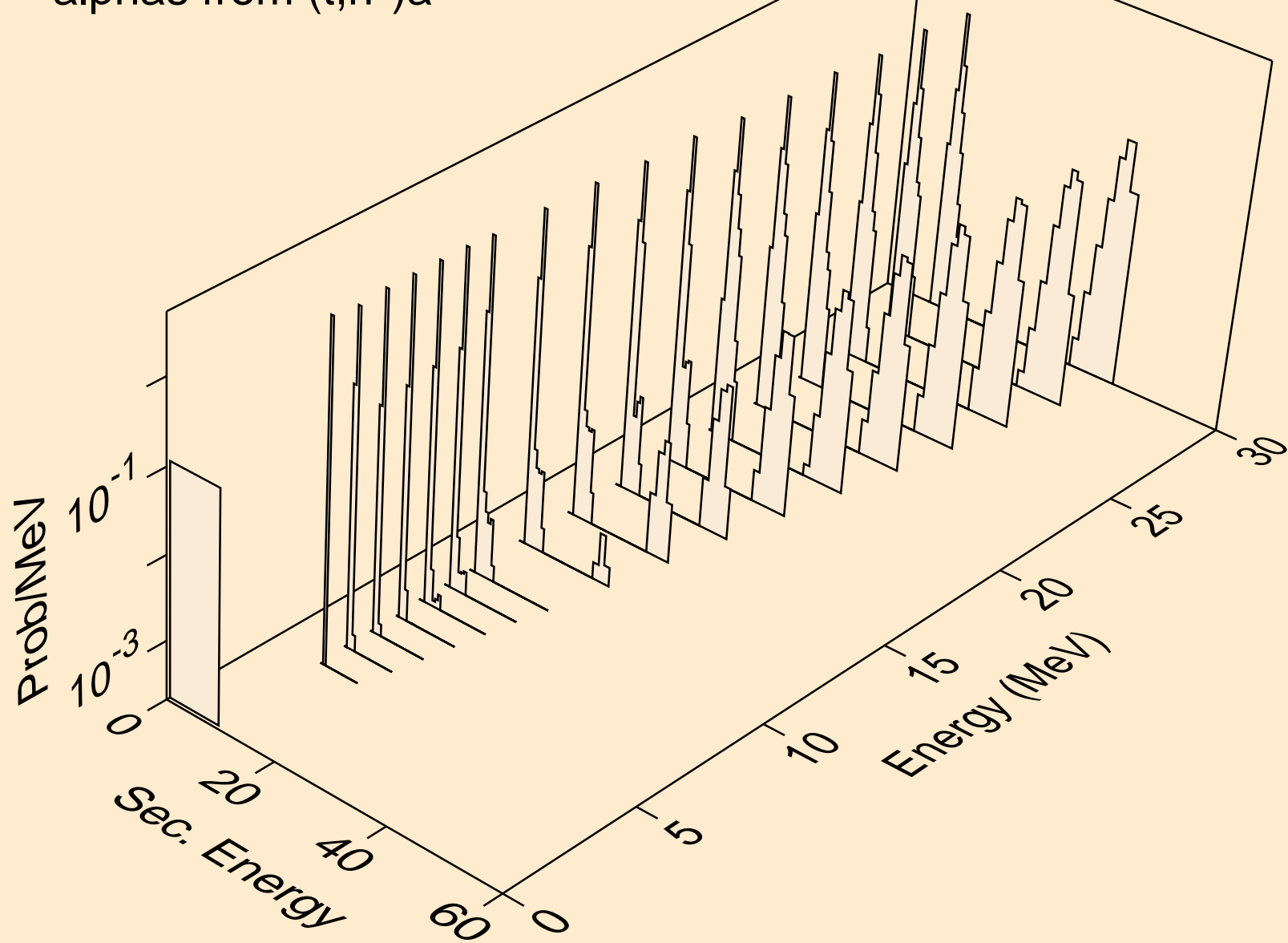

MD246M TRITON ACER TENDL-2021 LIBRARY; T=0.K  
alphas from (t,2n)a

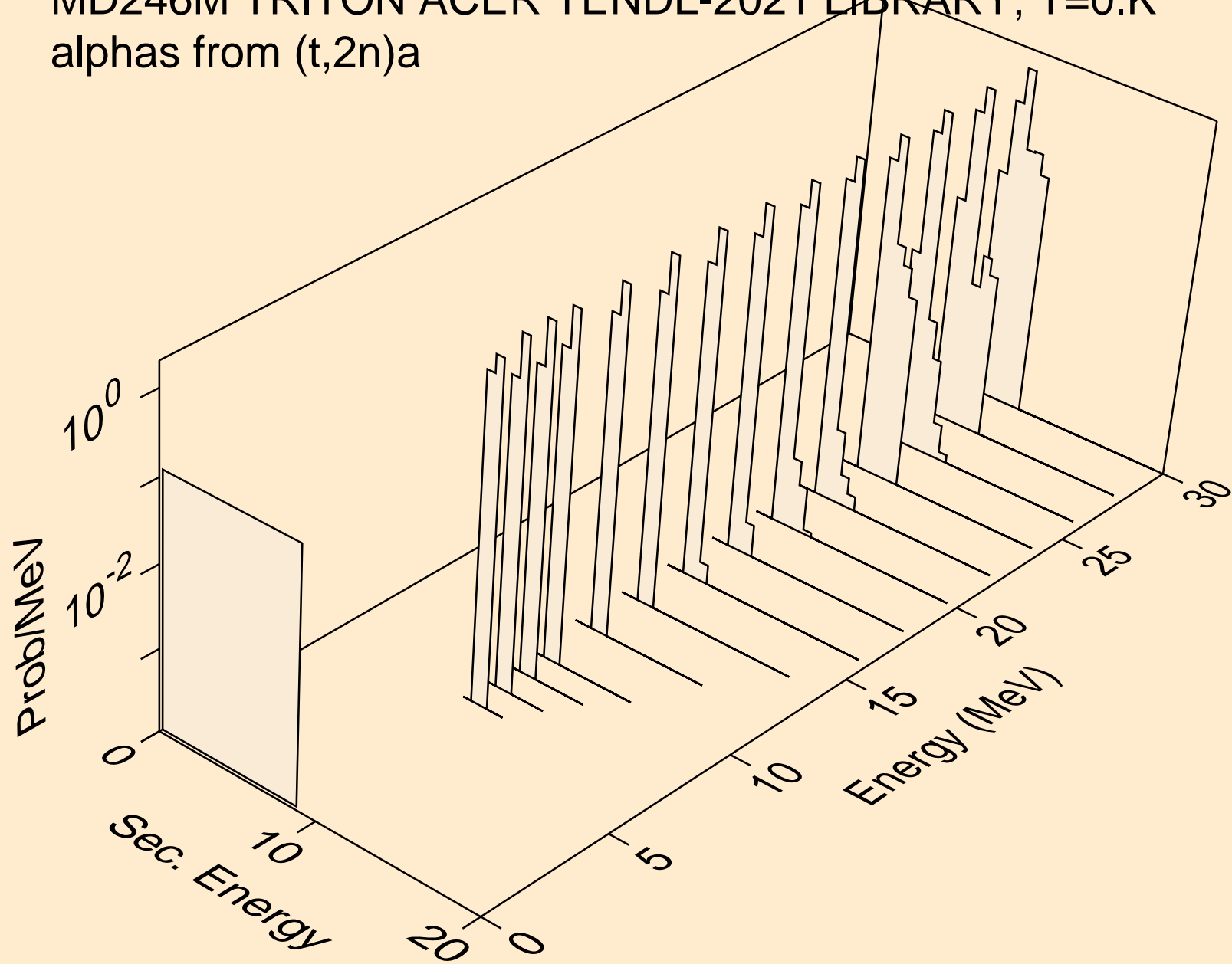

MD246M TRITON ACER TENDL-2021 LIBRARY; T=0.K  
alphas from (t,npa)

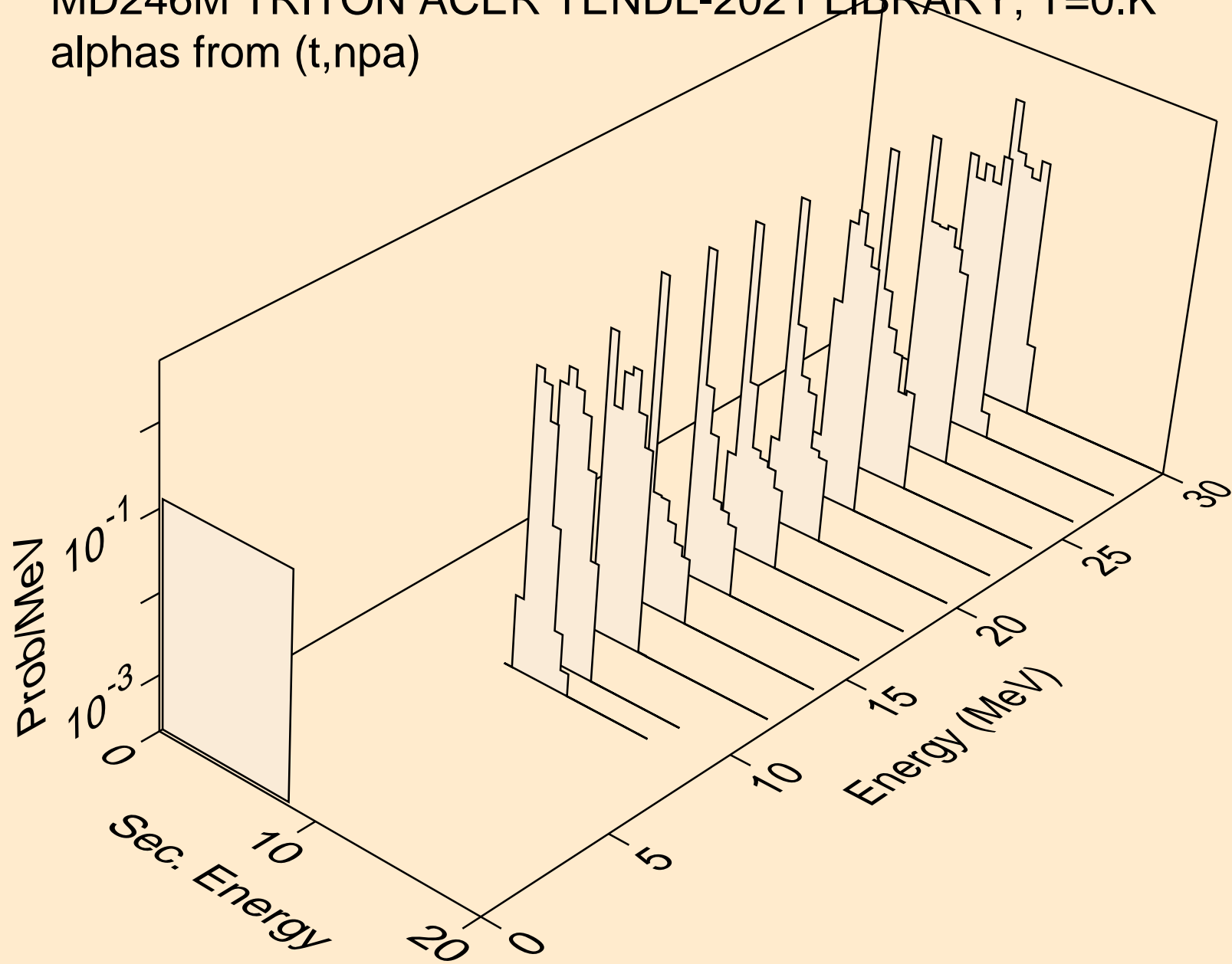

MD246M TRITON ACER TENDL-2021 LIBRARY; T=0.K  
alphas from (t,a)

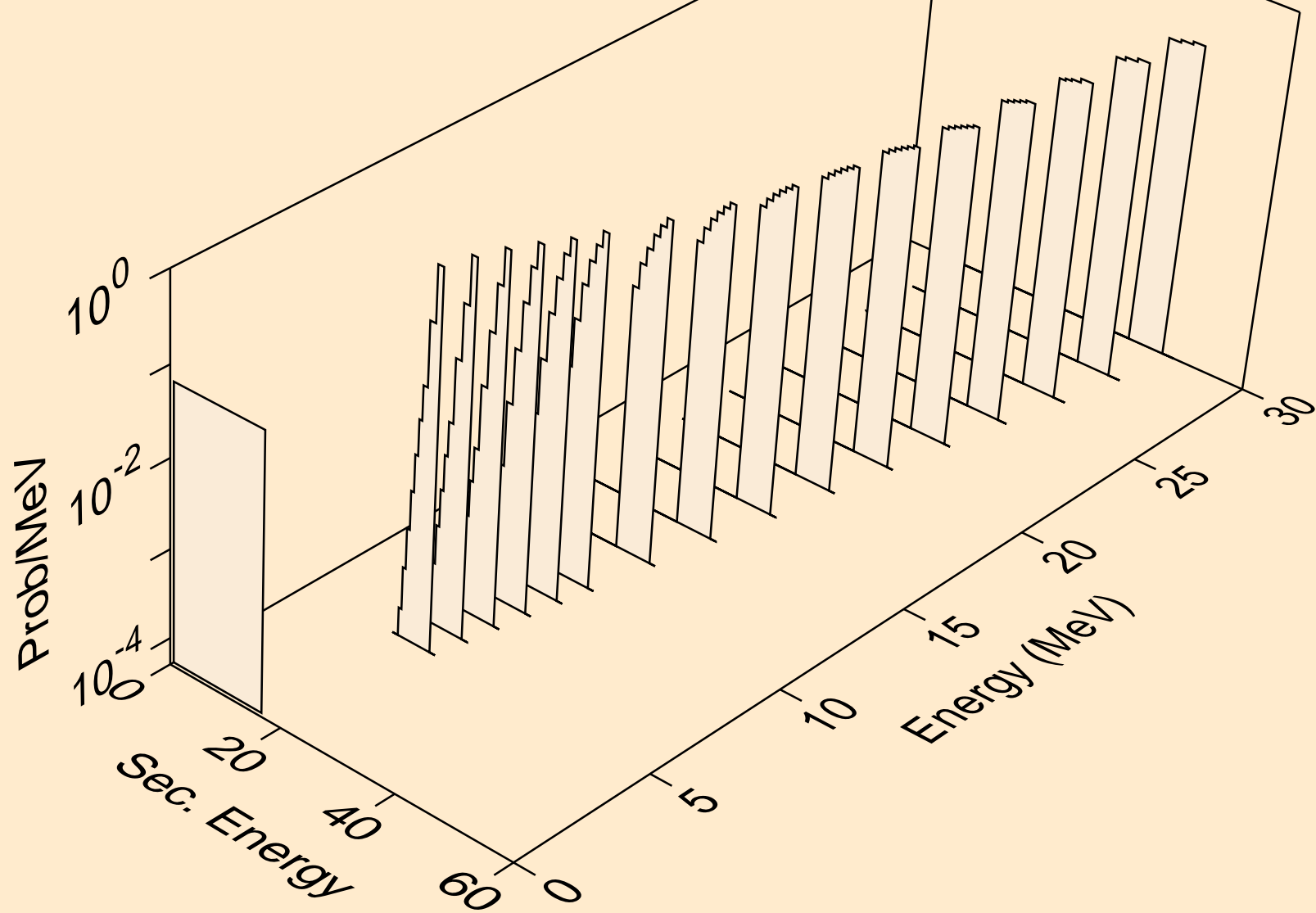

MD246M TRITON ACER TENDL-2021 LIBRARY; T=0.K  
alphas from (t,2a)

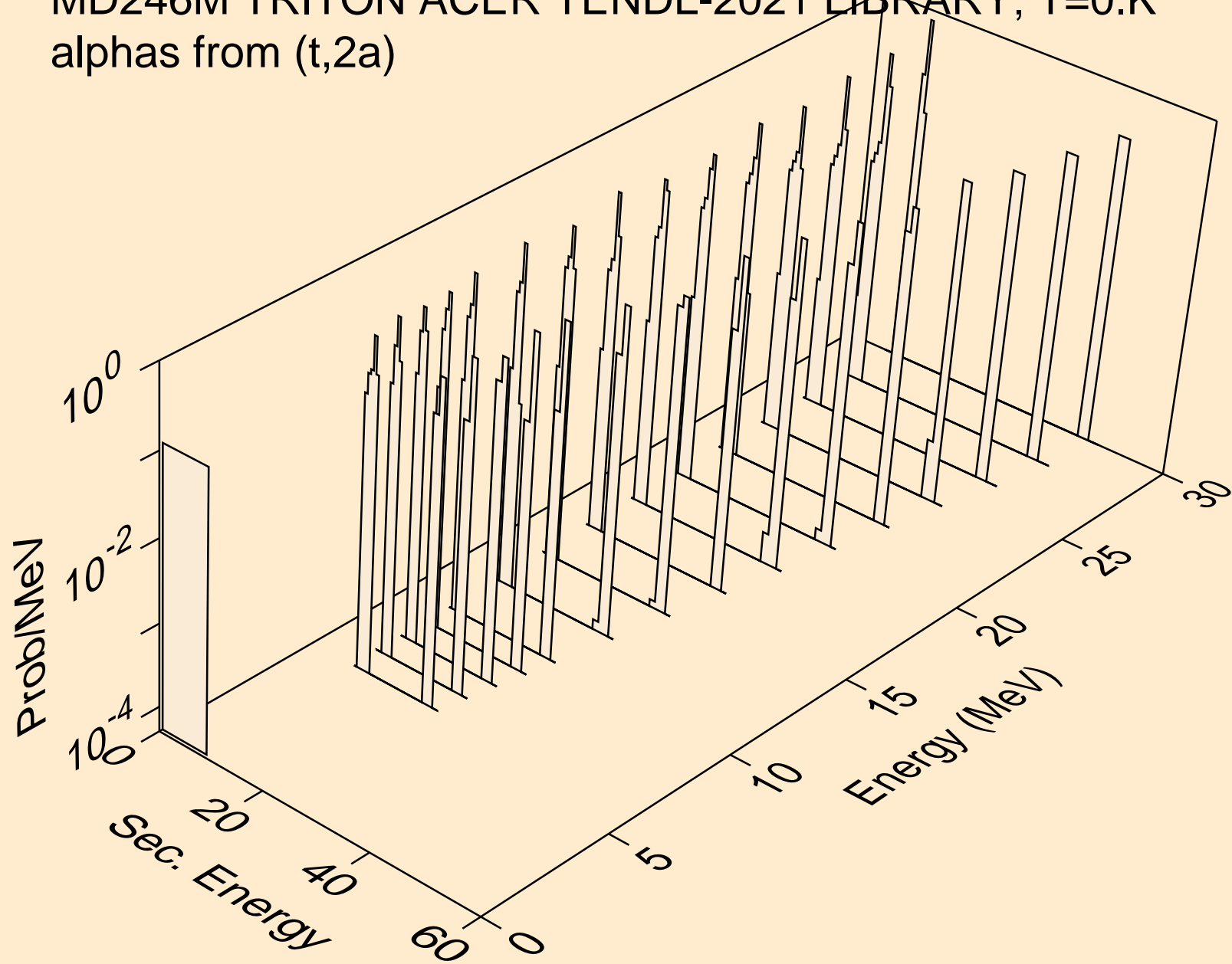



MD246M TRITON ACER TENDL-2021 LIBRARY; T=0.K  
alphas from (t,pa)

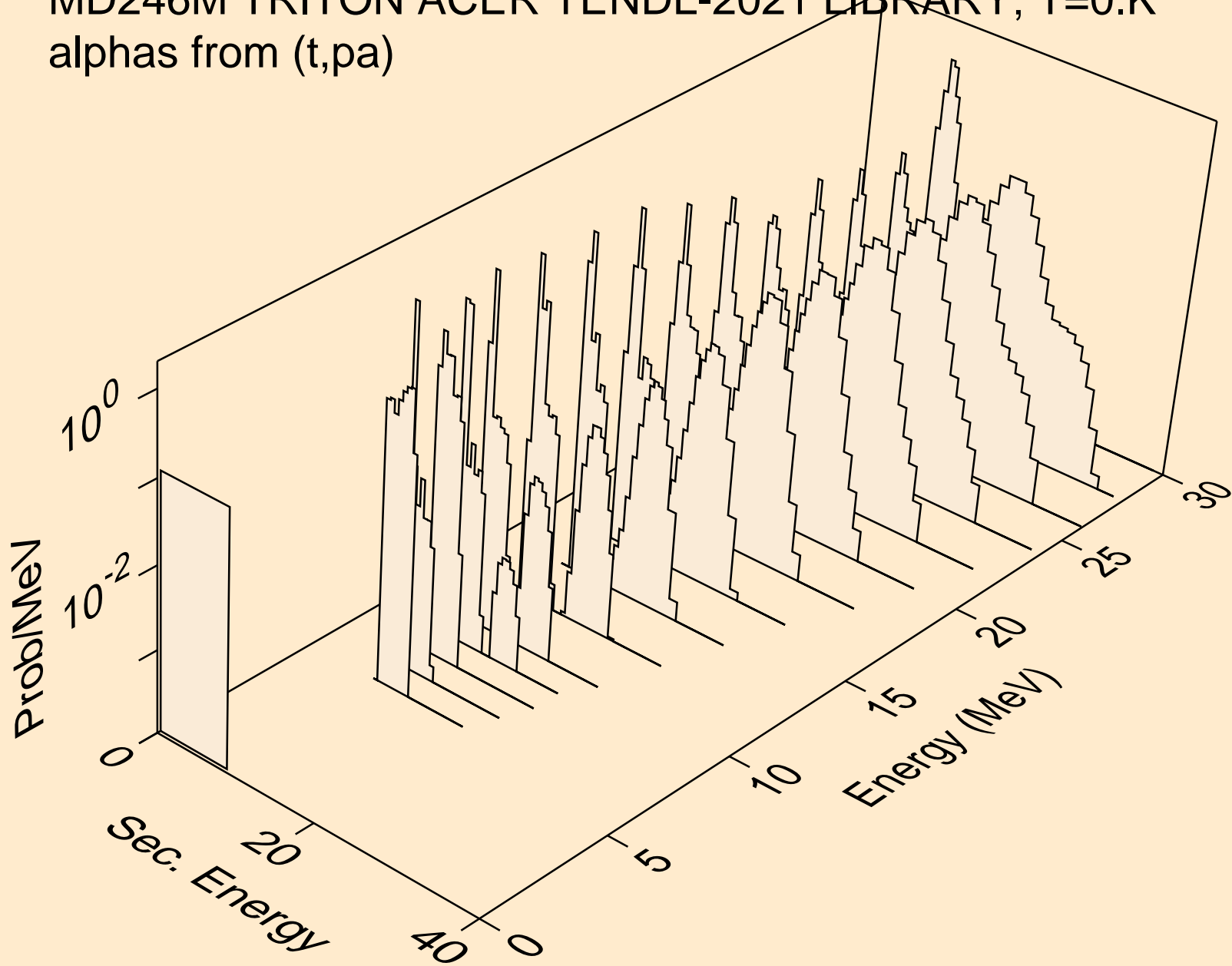

MD246M TRITON ACER TENDL-2021 LIBRARY; T=0.K  
alphas from (t,da)

