

NO254 TRITON ACER TENDL-2021 LIBRARY; T=0.K  
Principal cross sections

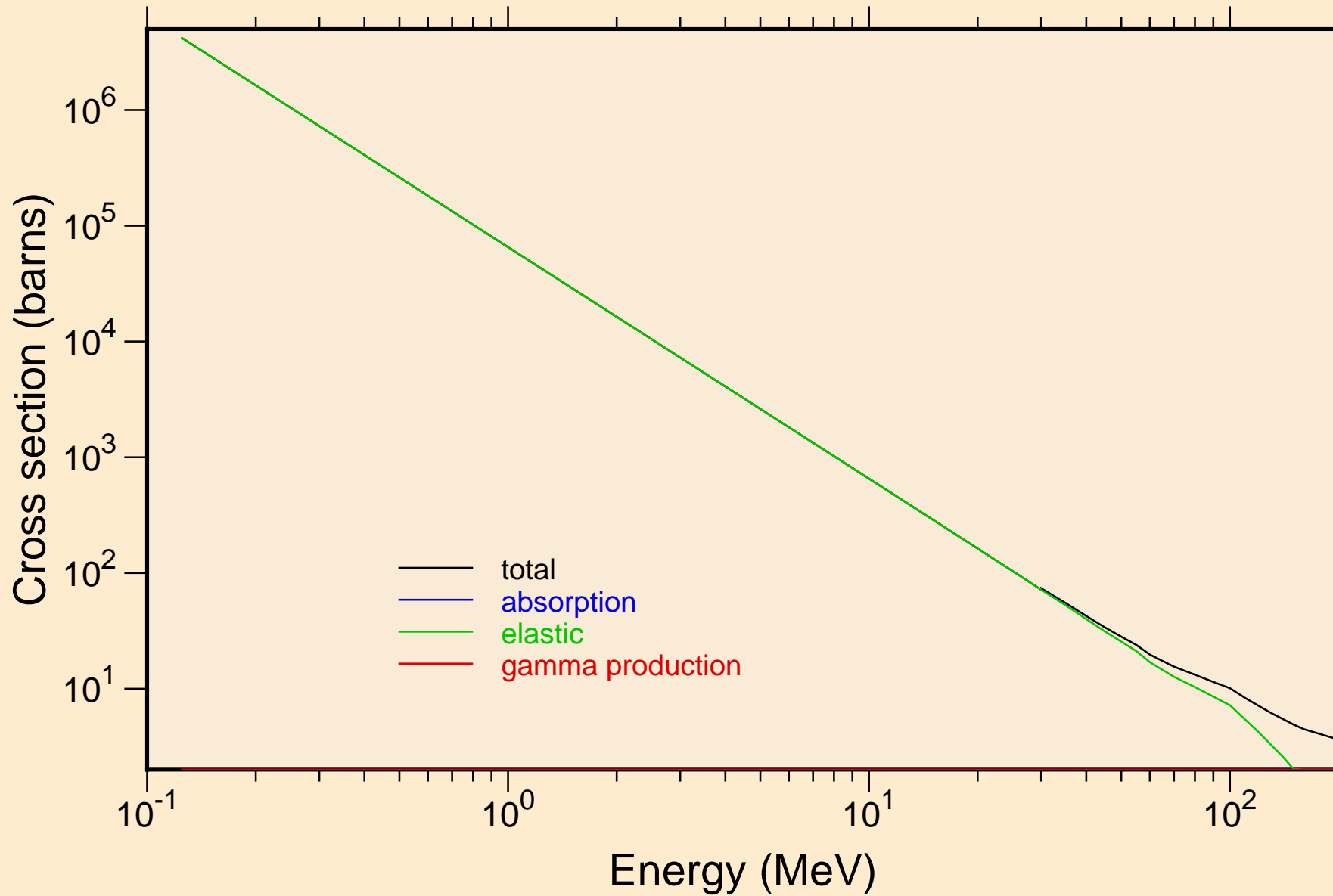

# NO254 TRITON ACER TENDL-2021 LIBRARY; T=0.K

## Heating

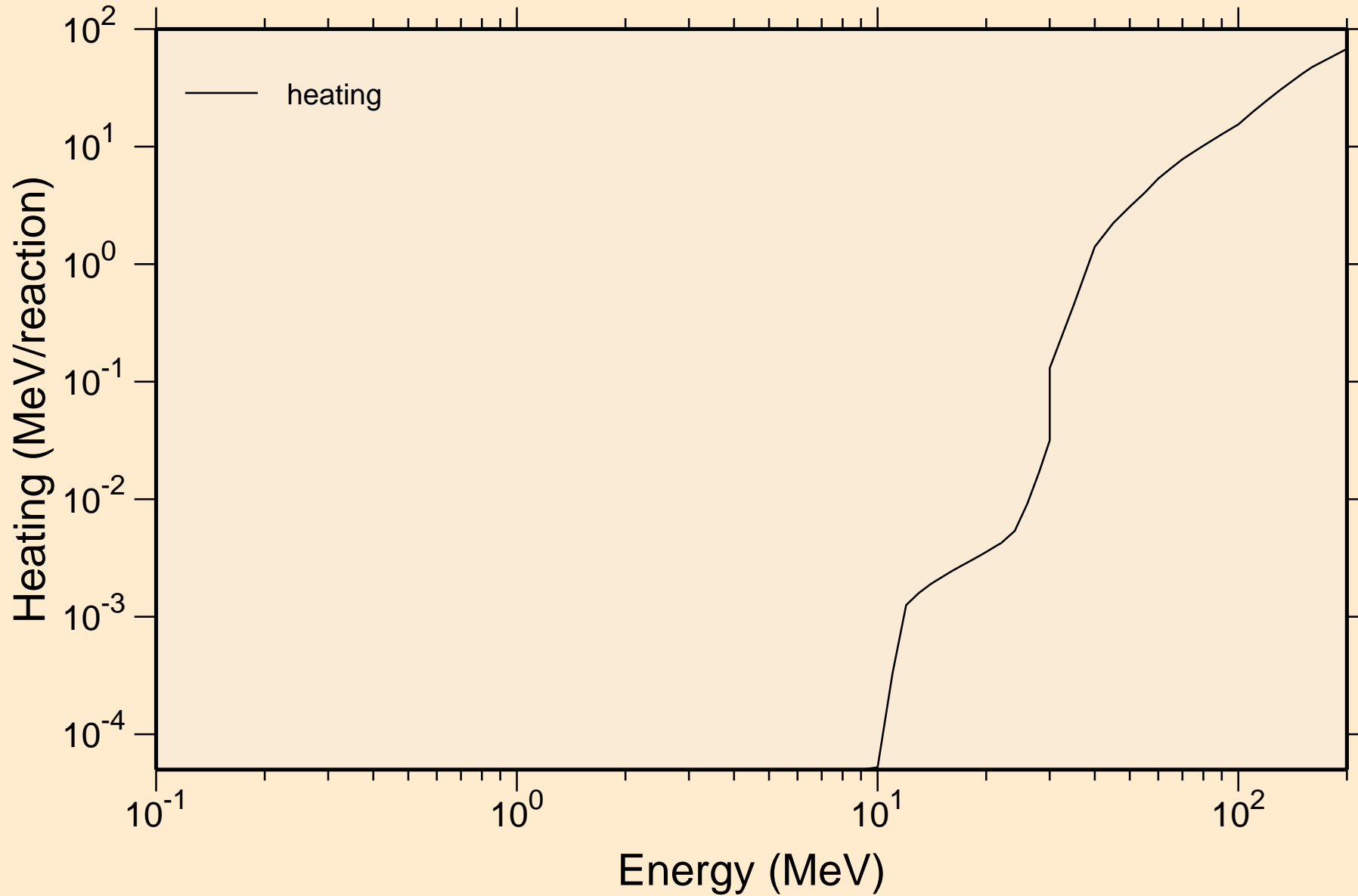

NO254 TRITON ACER TENDL-2021 LIBRARY; T=0.K  
Principal cross sections

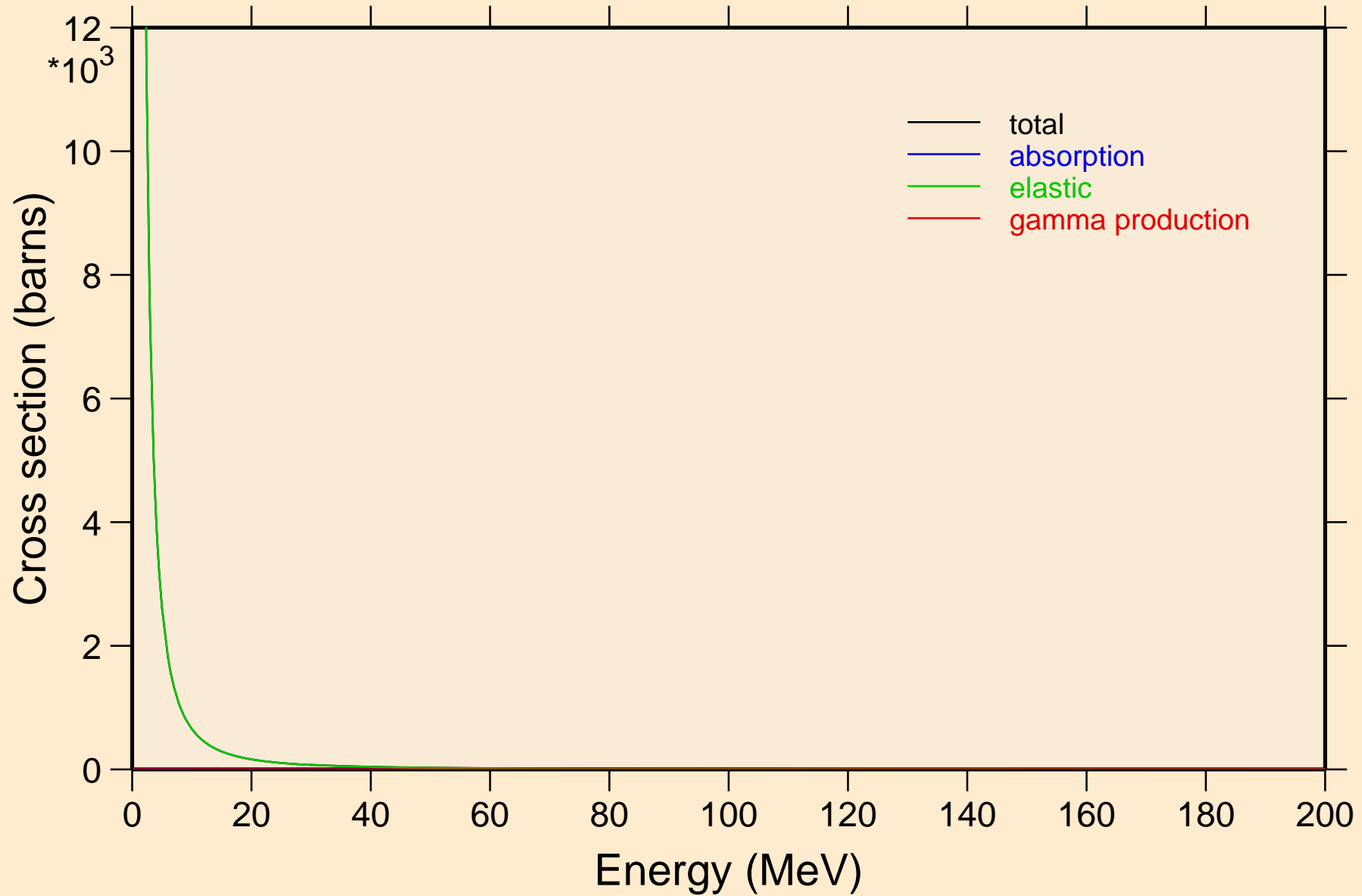

NO254 TRITON ACER TENDL-2021 LIBRARY; T=0.K

Heating

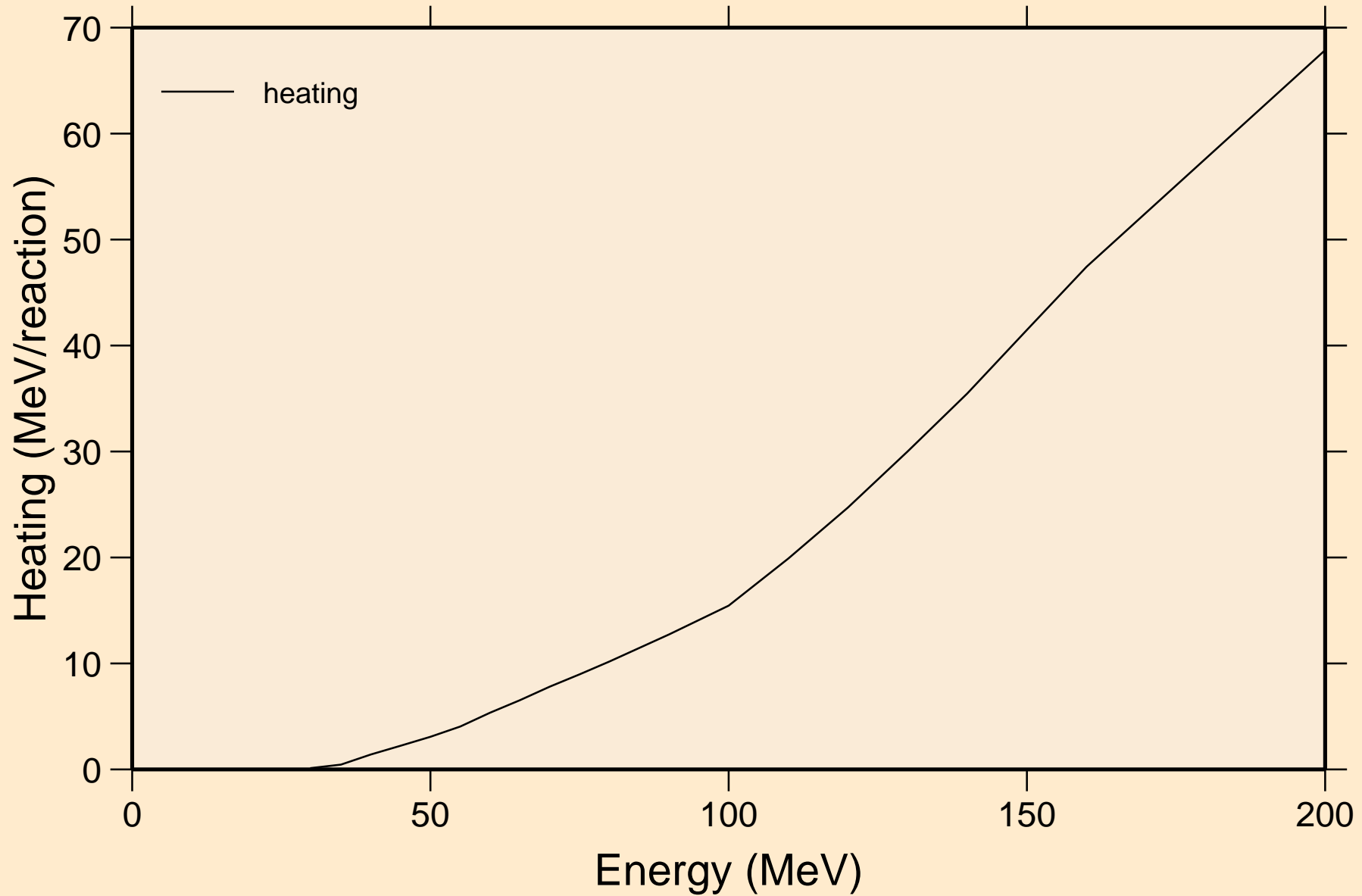

NO254 TRITON ACER TENDL-2021 LIBRARY; T=0.K  
Threshold reactions

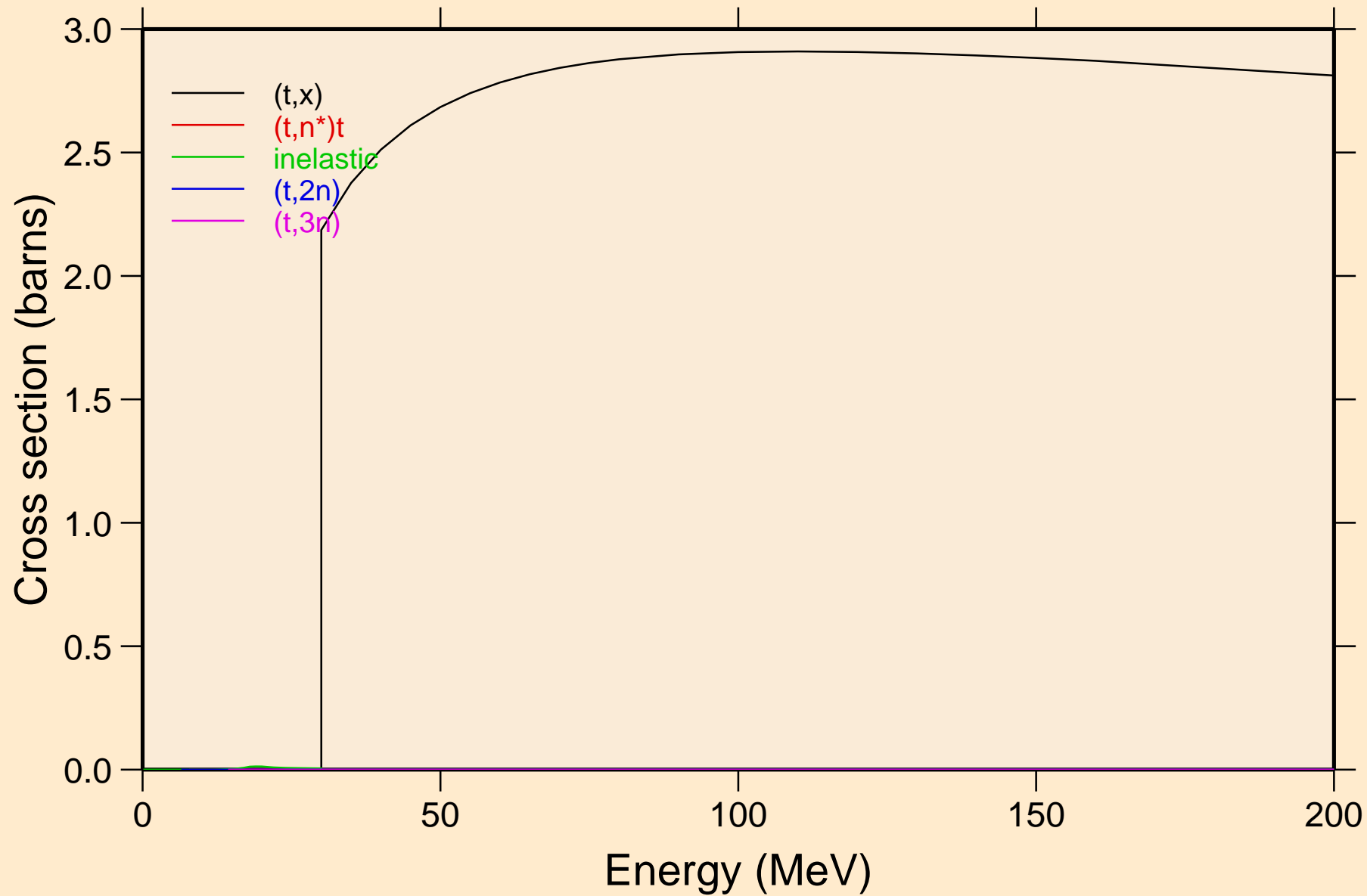

NO254 TRITON ACER TENDL-2021 LIBRARY; T=0.K  
Threshold reactions

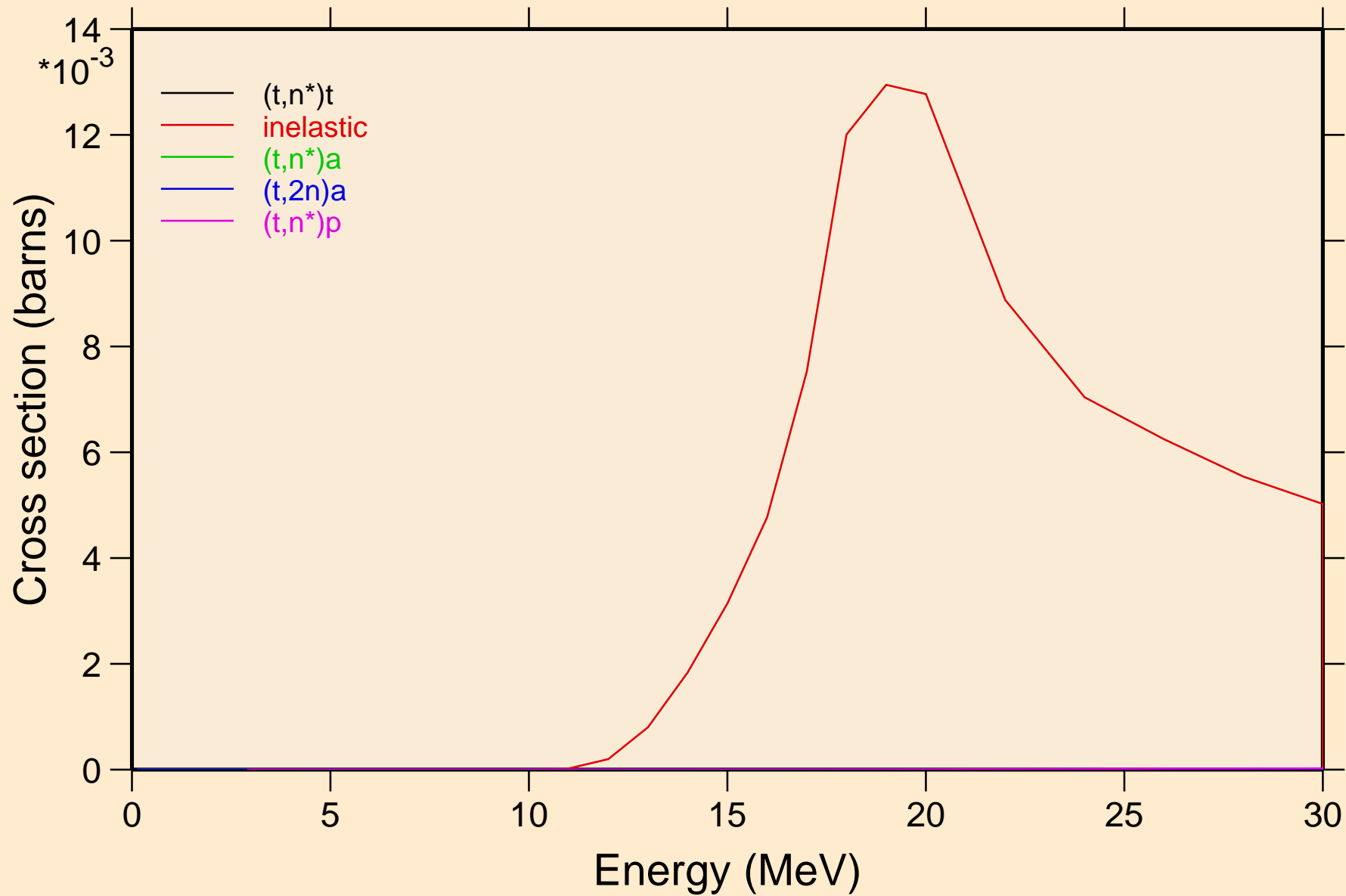

NO254 TRITON ACER TENDL-2021 LIBRARY; T=0.K  
Threshold reactions

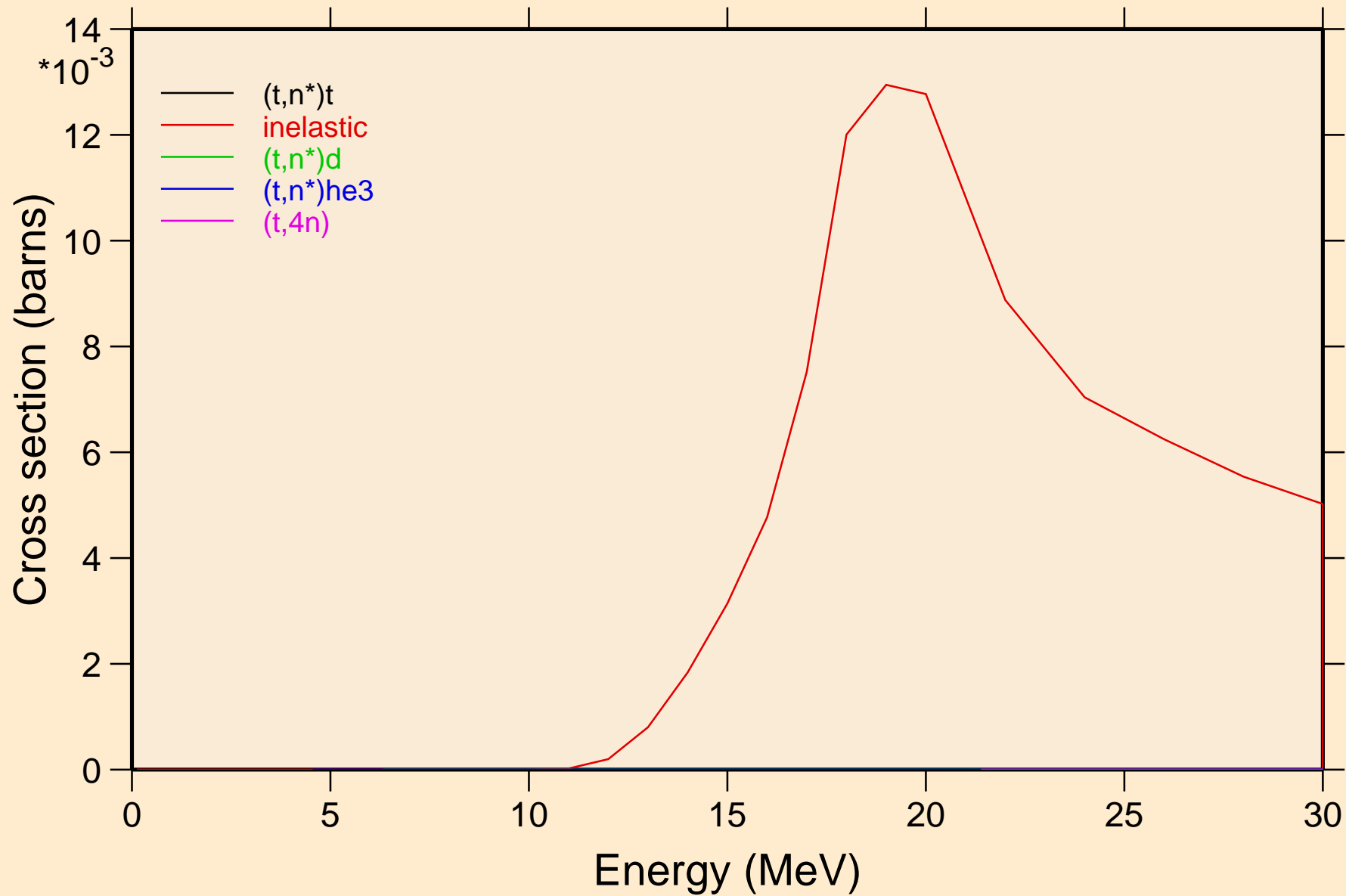

NO254 TRITON ACER TENDL-2021 LIBRARY; T=0.K  
Threshold reactions

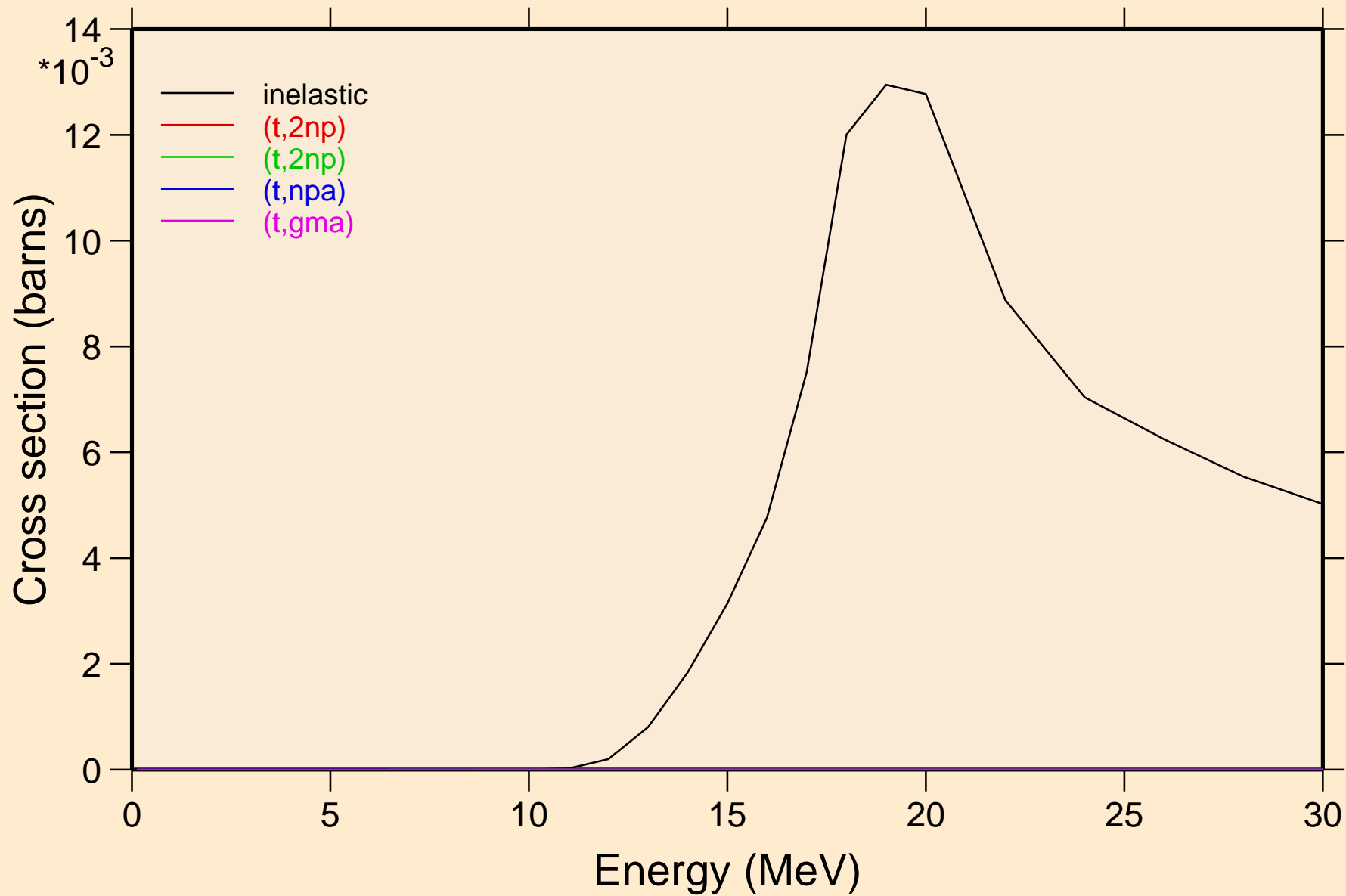



NO254 TRITON ACER TENDL-2021 LIBRARY; T=0.K  
Threshold reactions

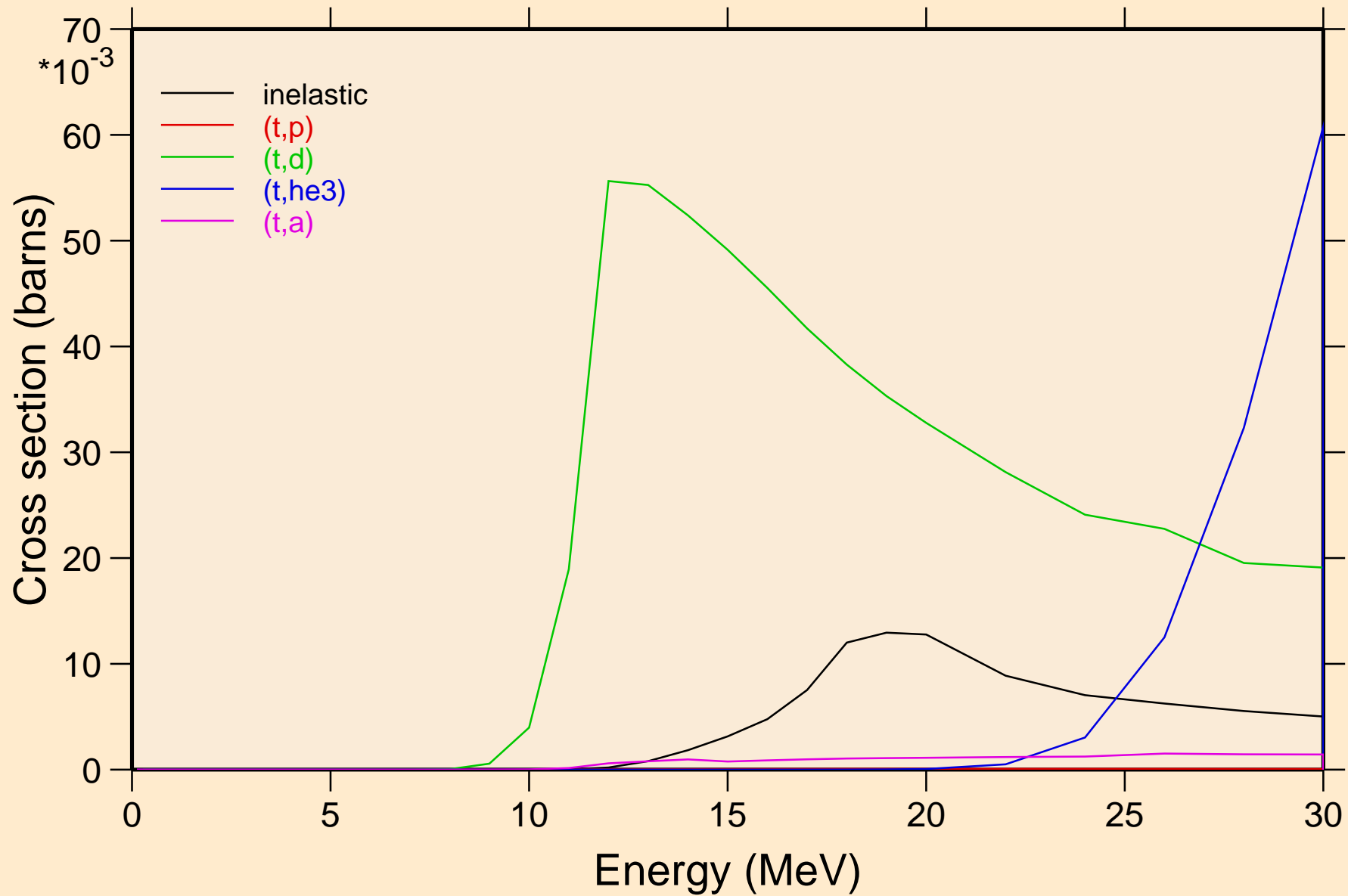

NO254 TRITON ACER TENDL-2021 LIBRARY; T=0.K  
Threshold reactions

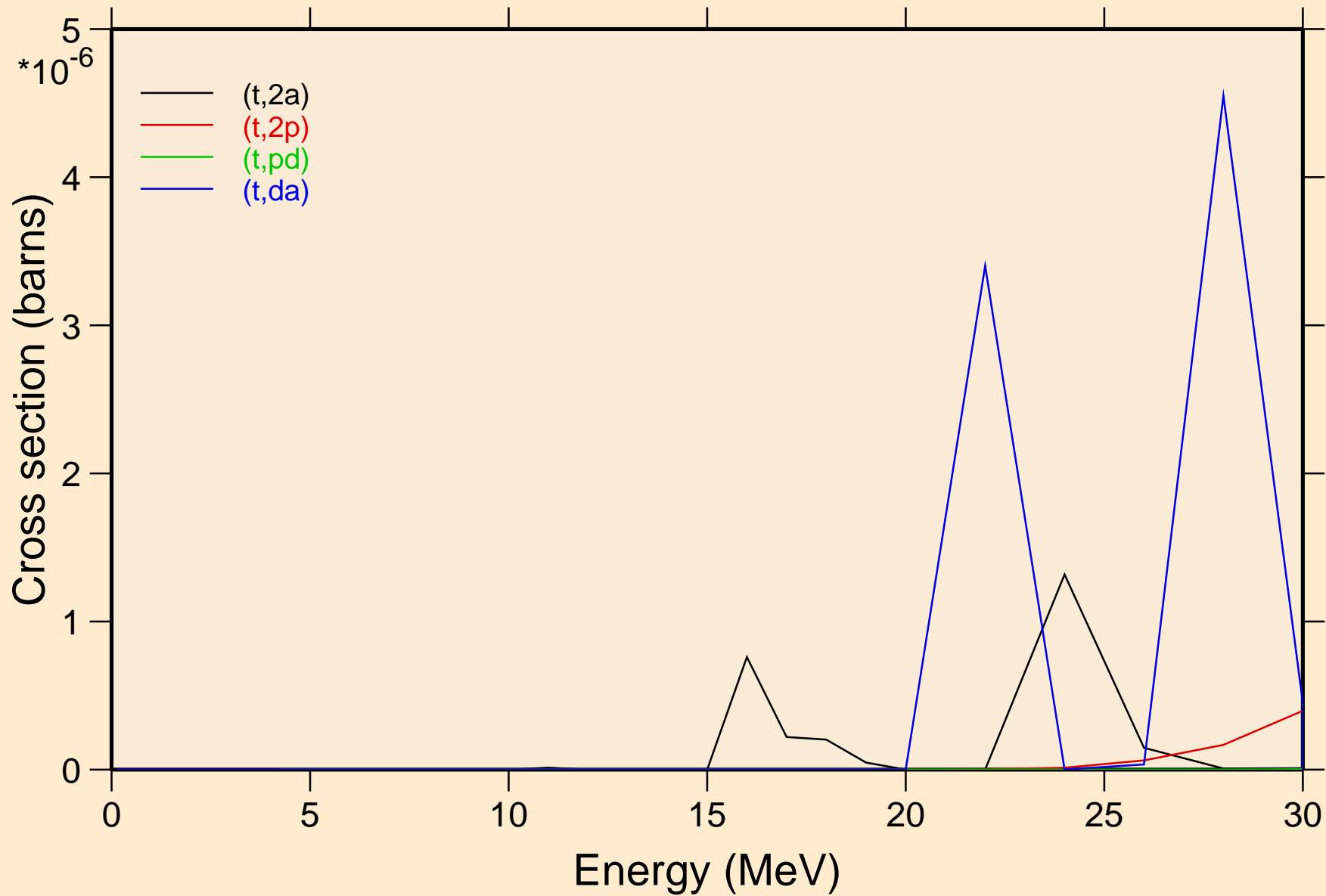

NO254 TRITON ACER TENDL-2021 LIBRARY; T=0.K  
angular distribution for elastic

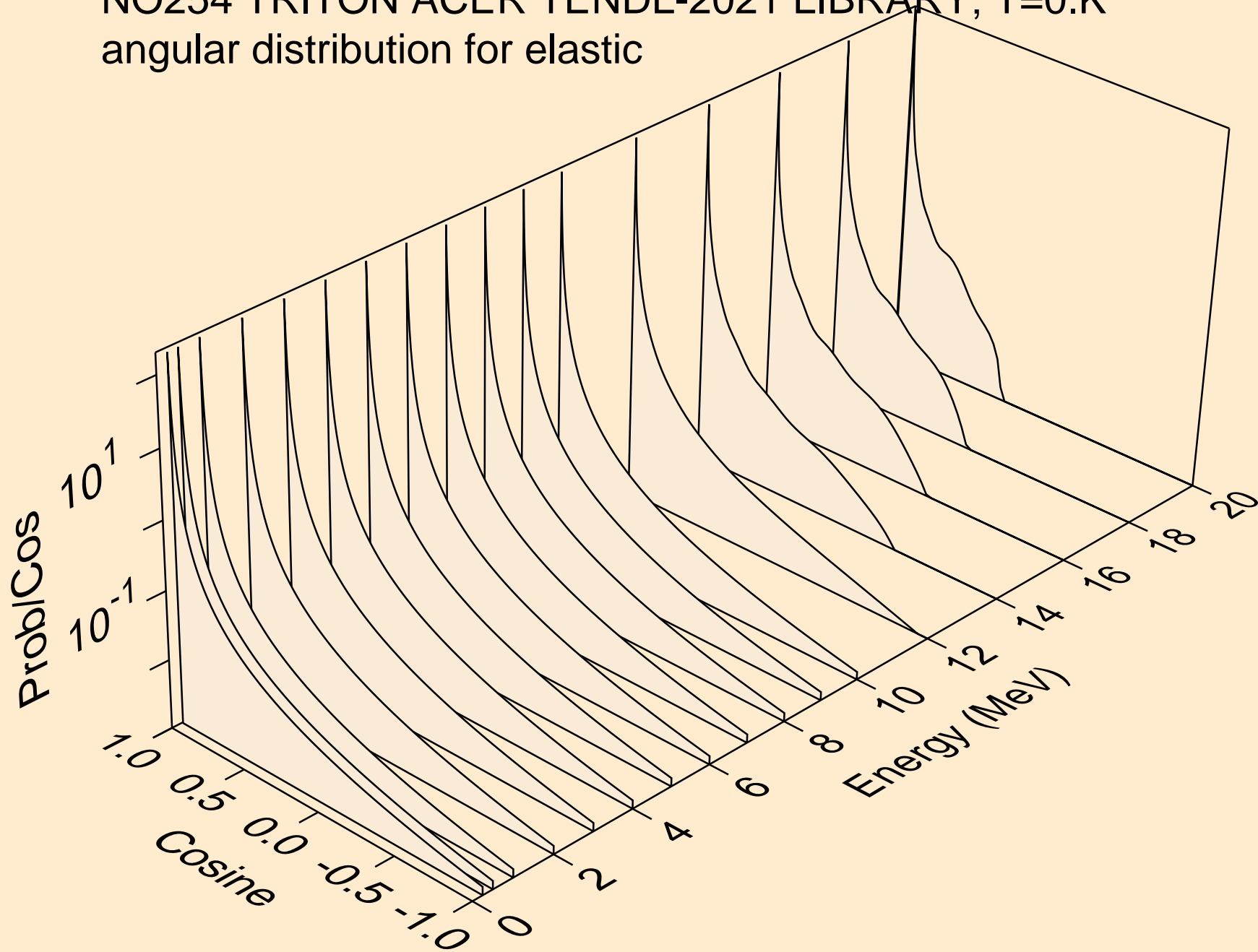

NO254 TRITON ACER TENDL-2021 LIBRARY; T=0.K  
angular distribution for elastic

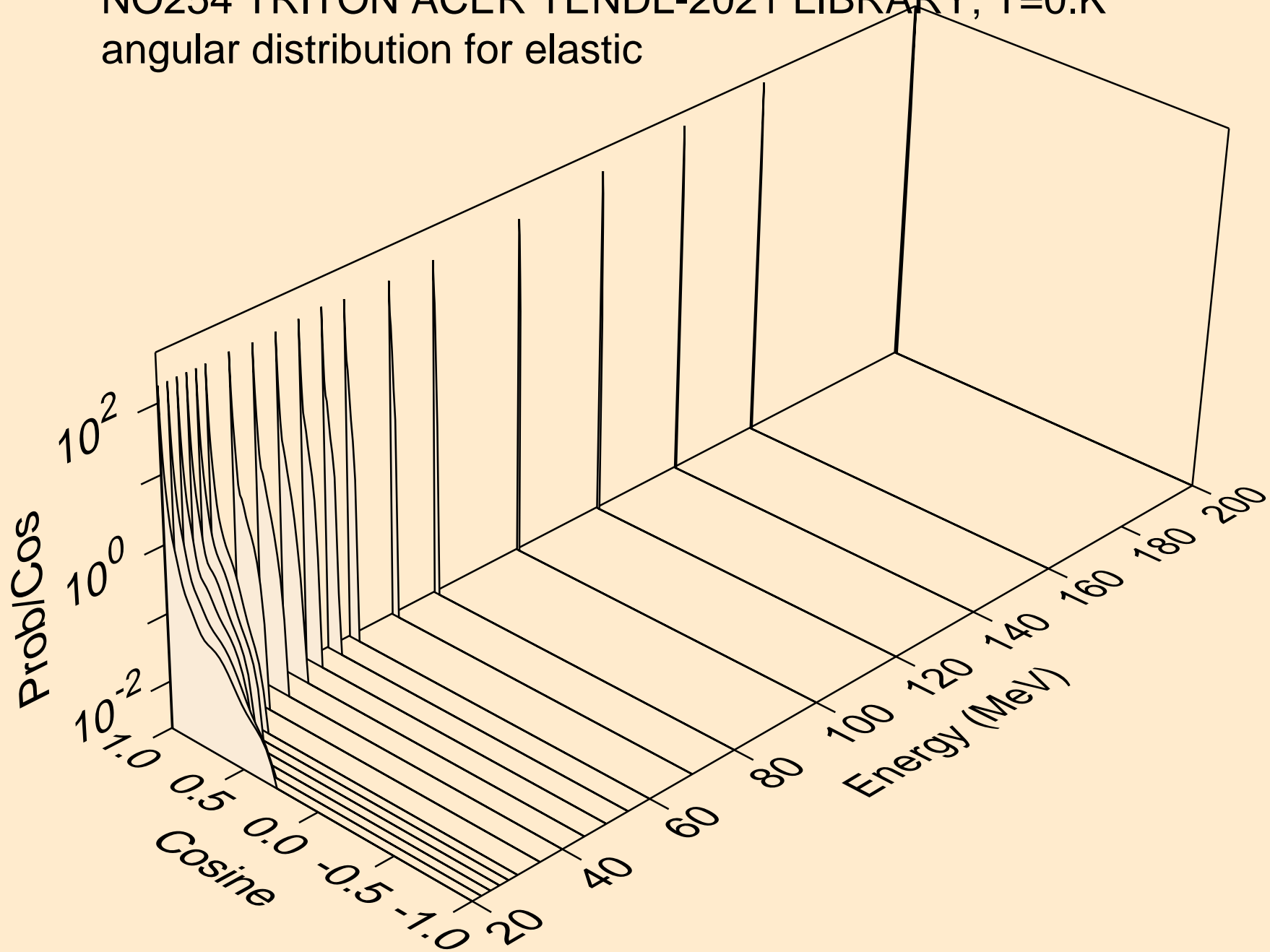

NO254 TRITON ACER TENDL-2021 LIBRARY; T=0.K  
Triton emission for (t,x)

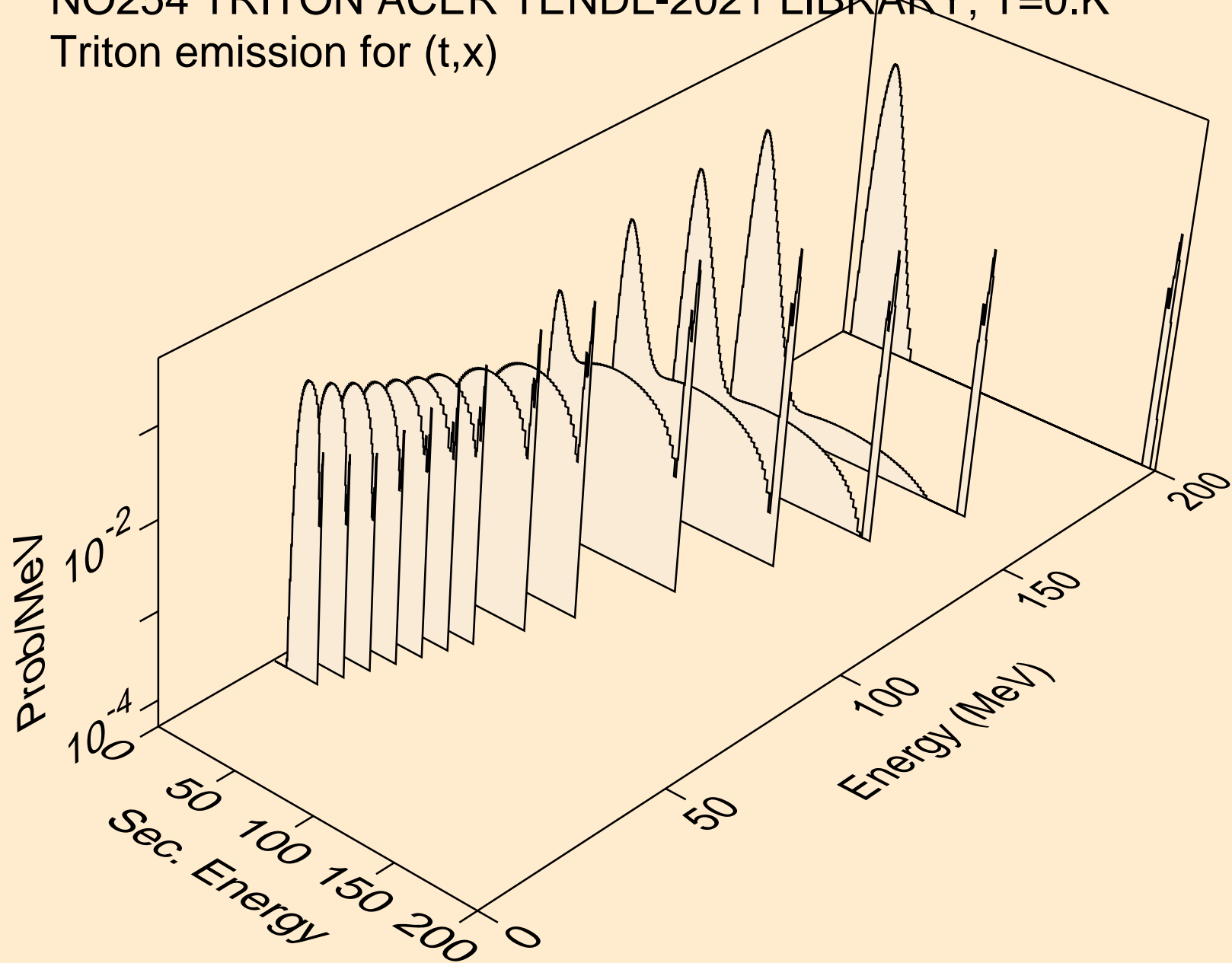

NO254 TRITON ACER TENDL-2021 LIBRARY; T=0.K  
Triton emission for (t,n\*)t

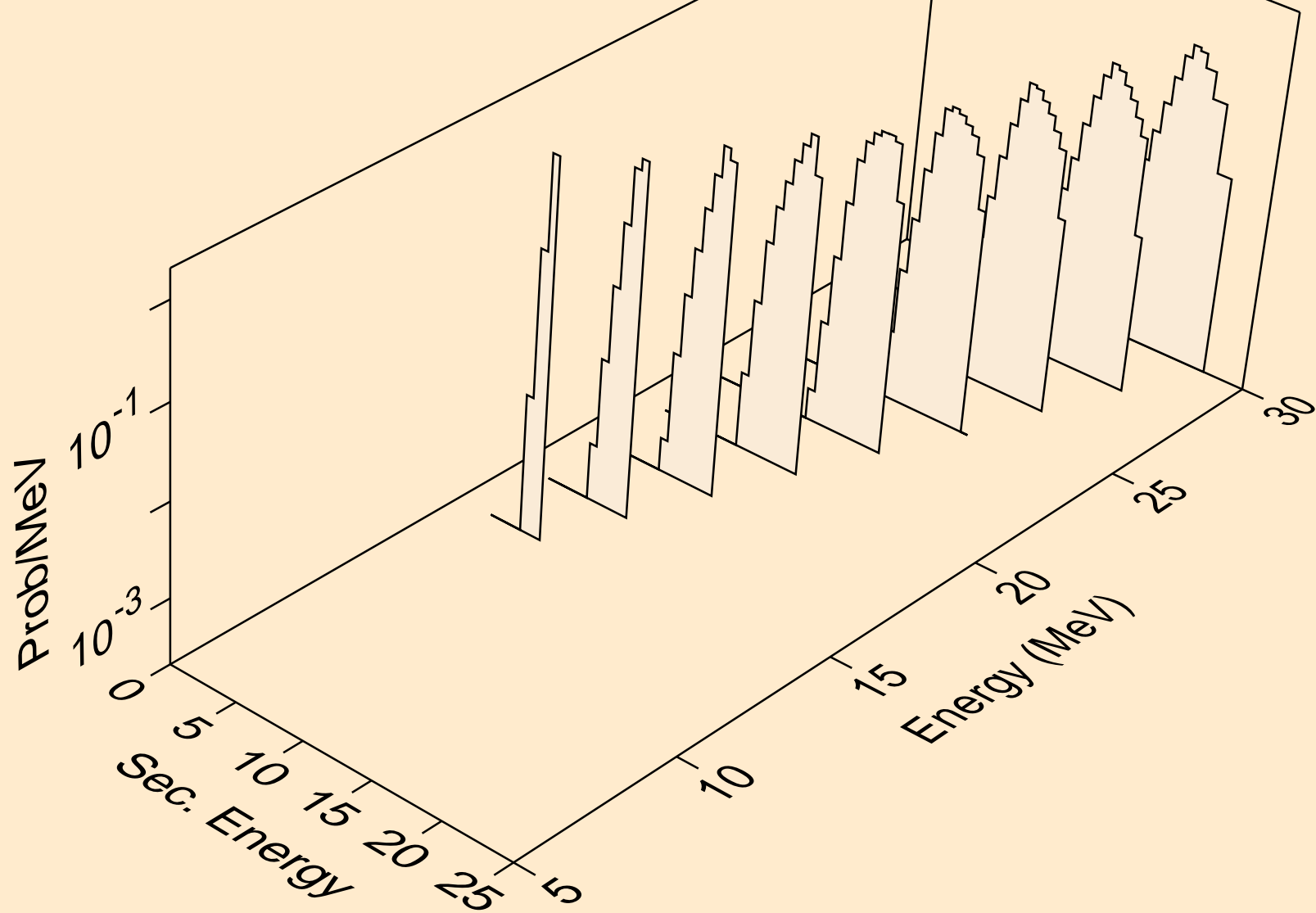

NO254 TRITON ACER TENDL-2021 LIBRARY; T=0.K  
Triton emission for inelastic

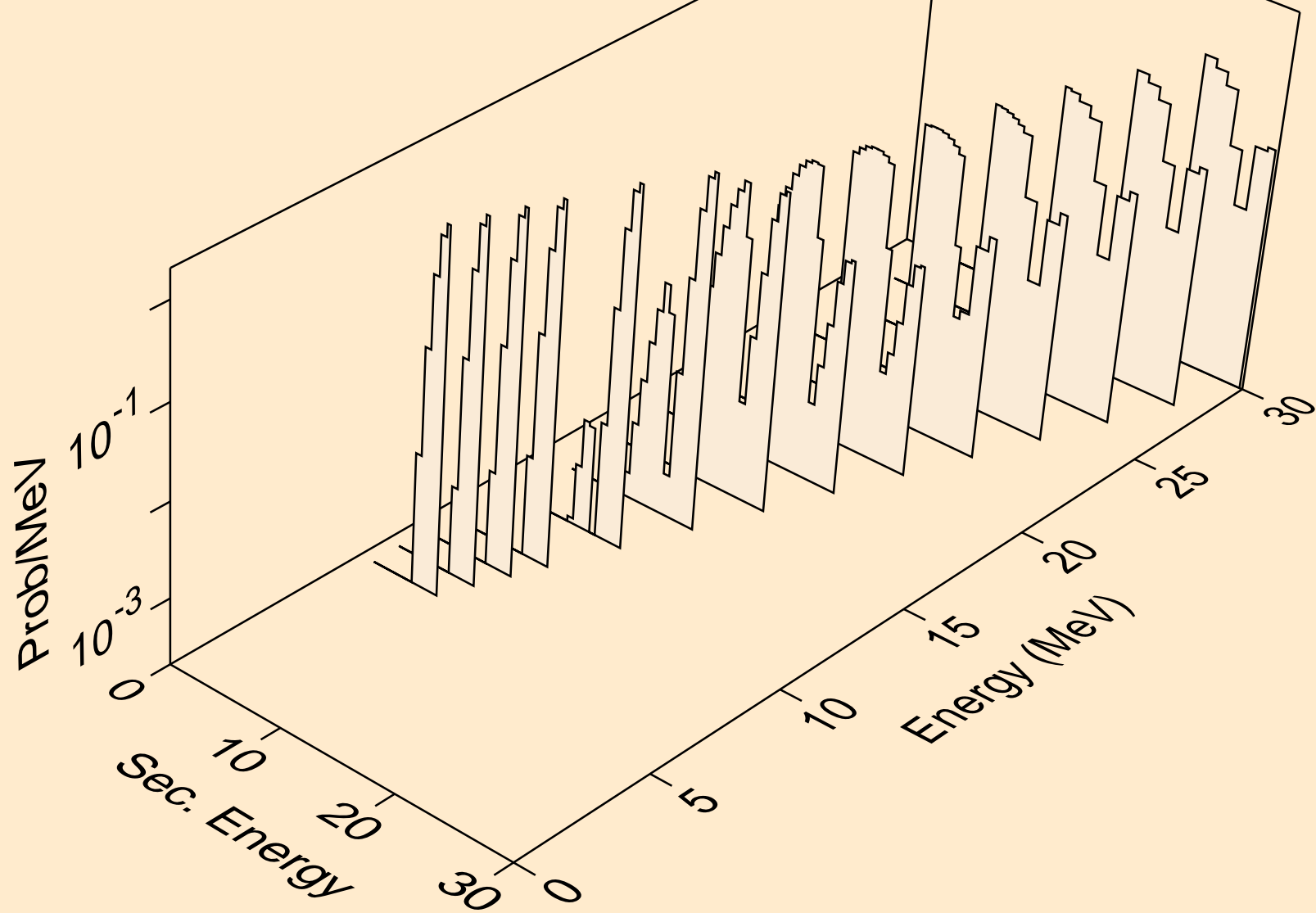

NO254 TRITON ACER TENDL-2021 LIBRARY; T=0.K  
Photon emission for (z,n)

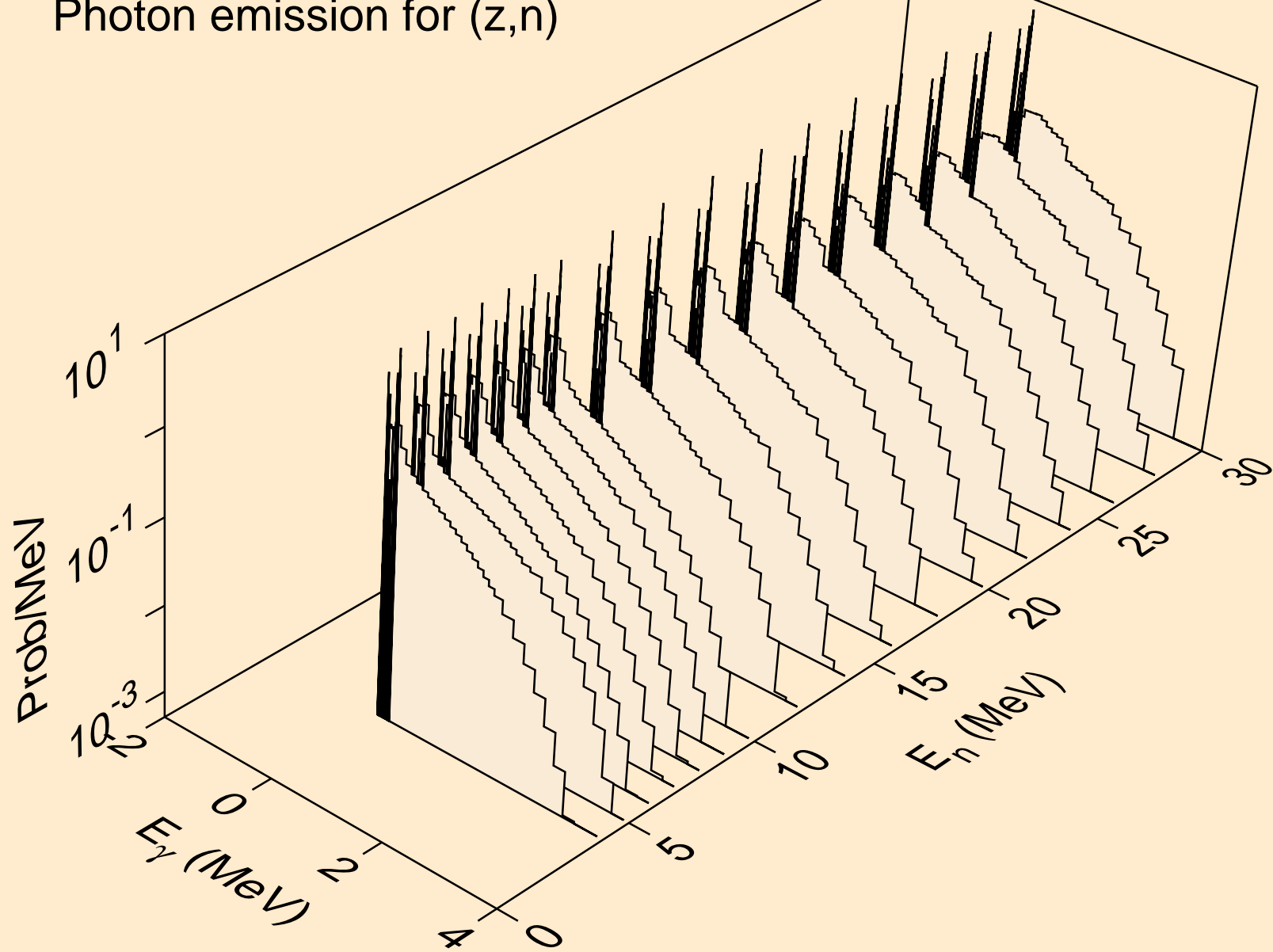



NO254 TRITON ACER TENDL-2021 LIBRARY; T=0.K  
Photon emission for (n,x)

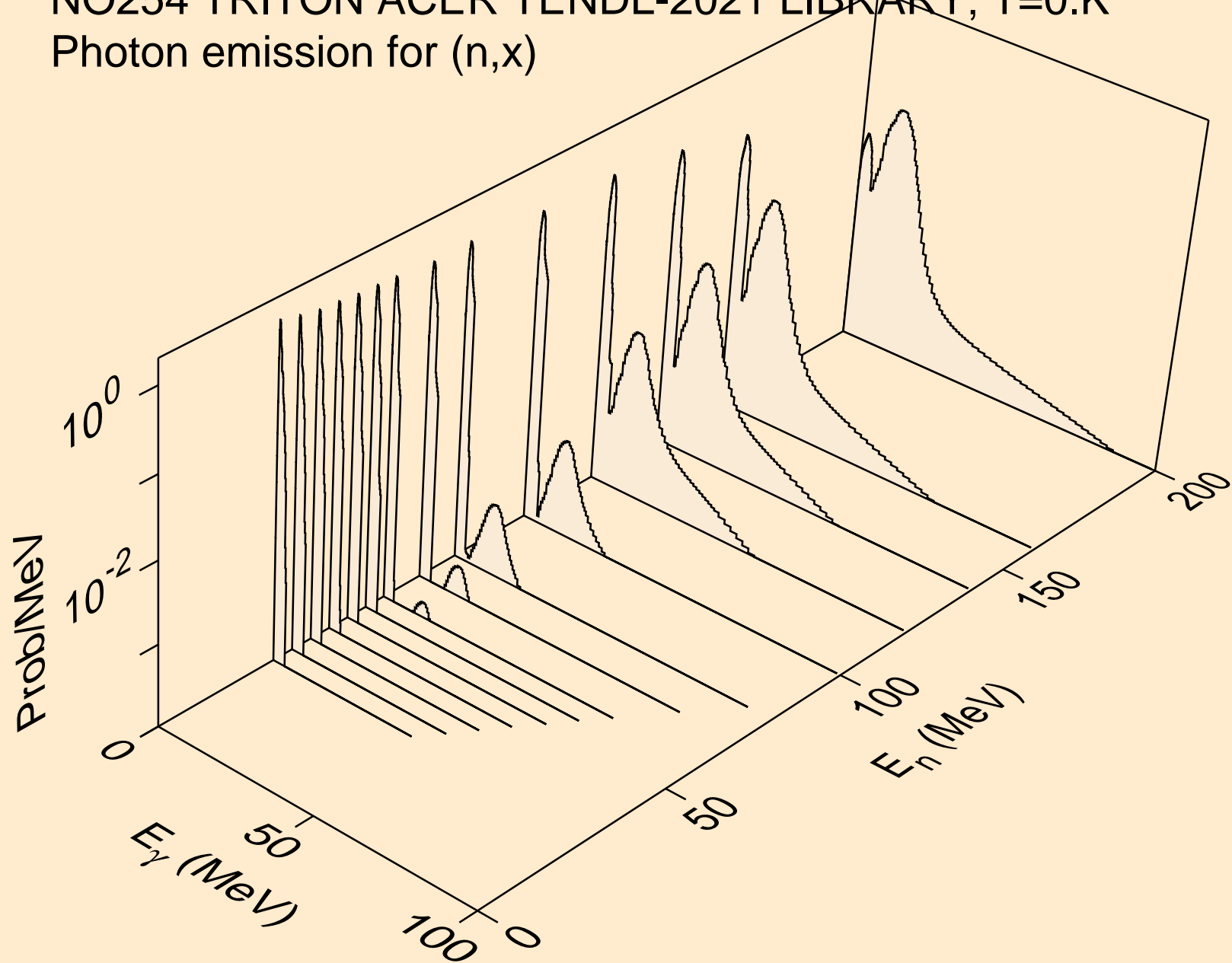

NO254 TRITON ACER TENDL-2021 LIBRARY; T=0.K  
Photon emission for (n,2n)

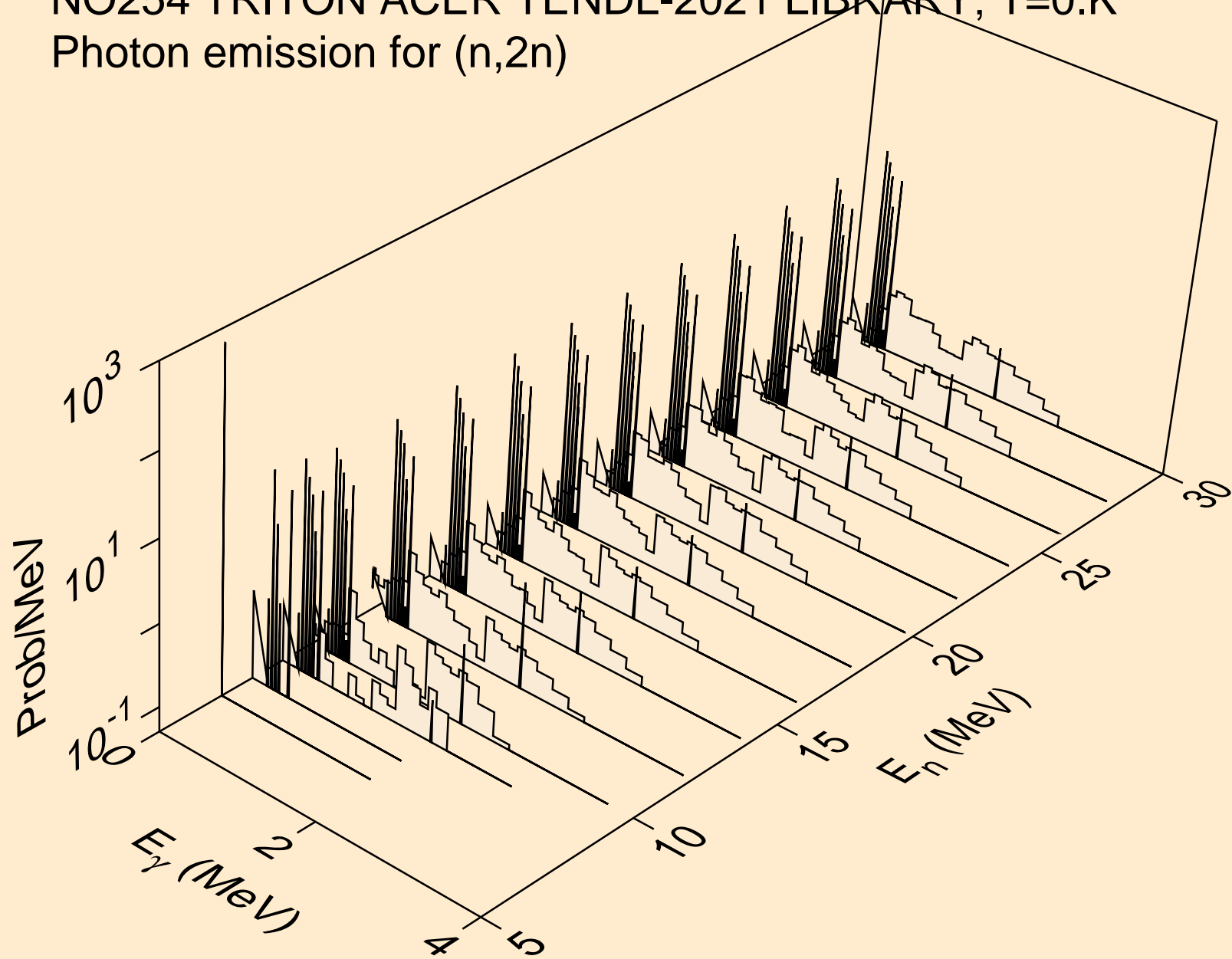

NO254 TRITON ACER TENDL-2021 LIBRARY; T=0.K  
Photon emission for (n,3n)

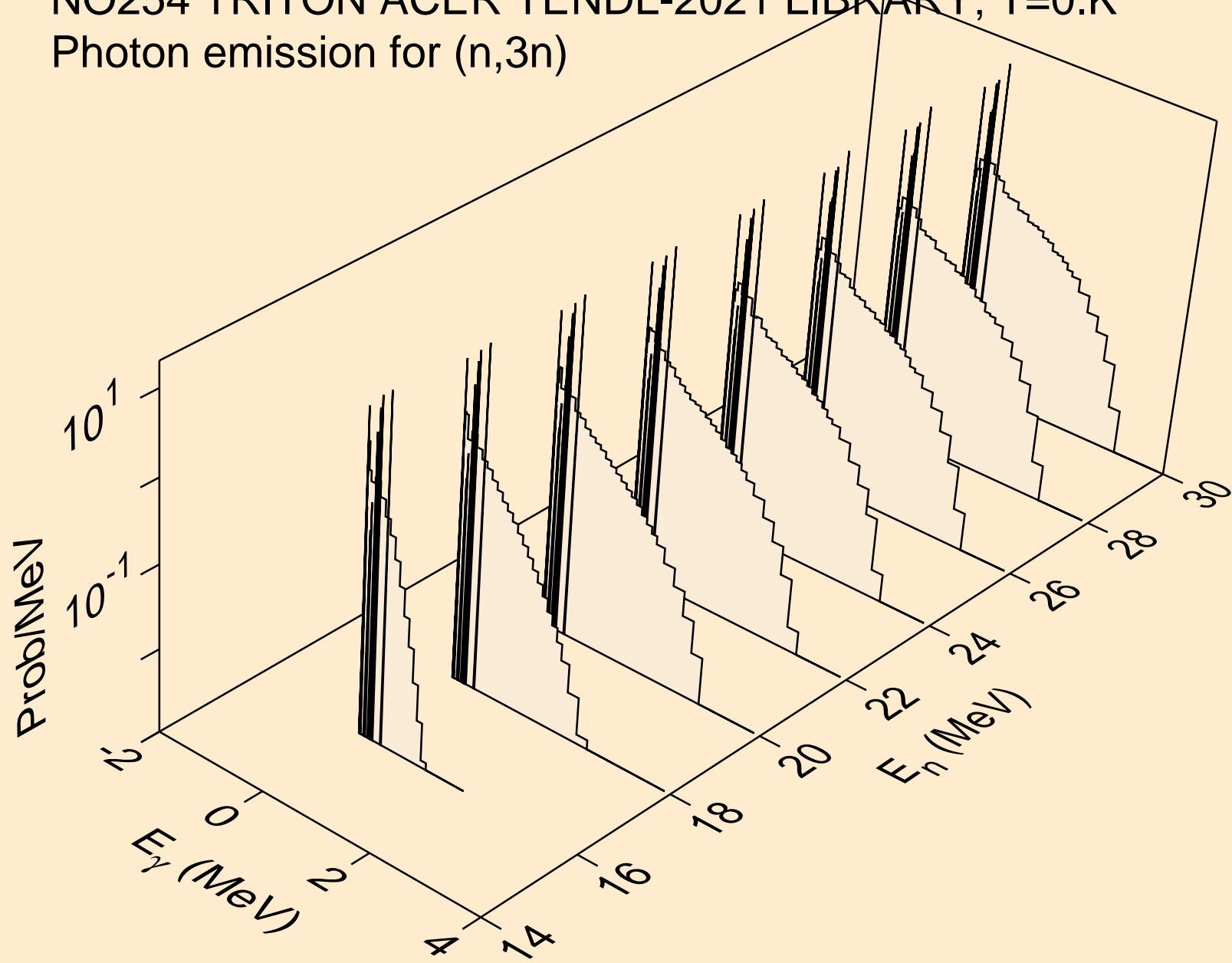

NO254 TRITON ACER TENDL-2021 LIBRARY; T=0.K  
Photon emission for (n,n\*)a

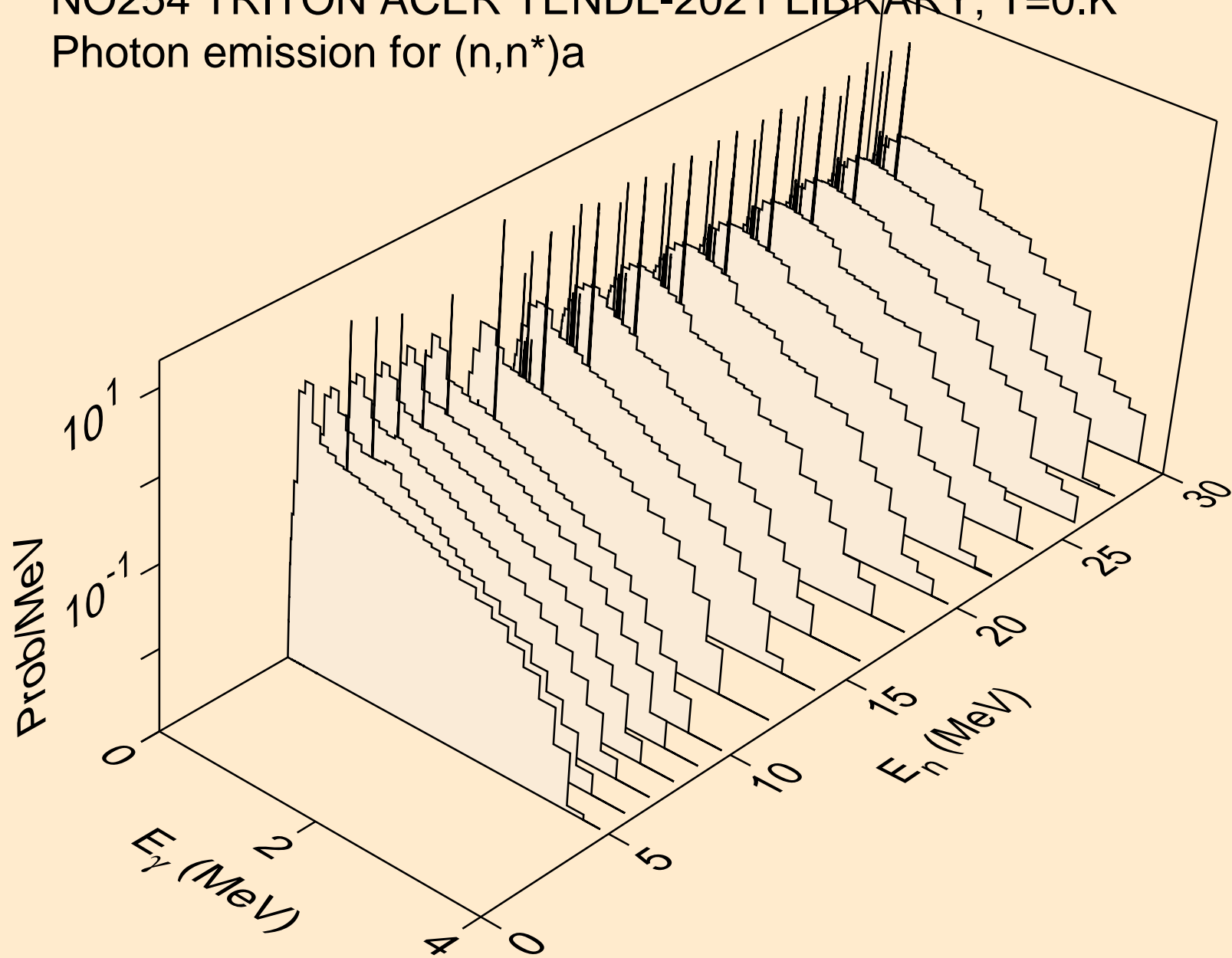

NO254 TRITON ACER TENDL-2021 LIBRARY; T=0.K  
Photon emission for (n,2n)a

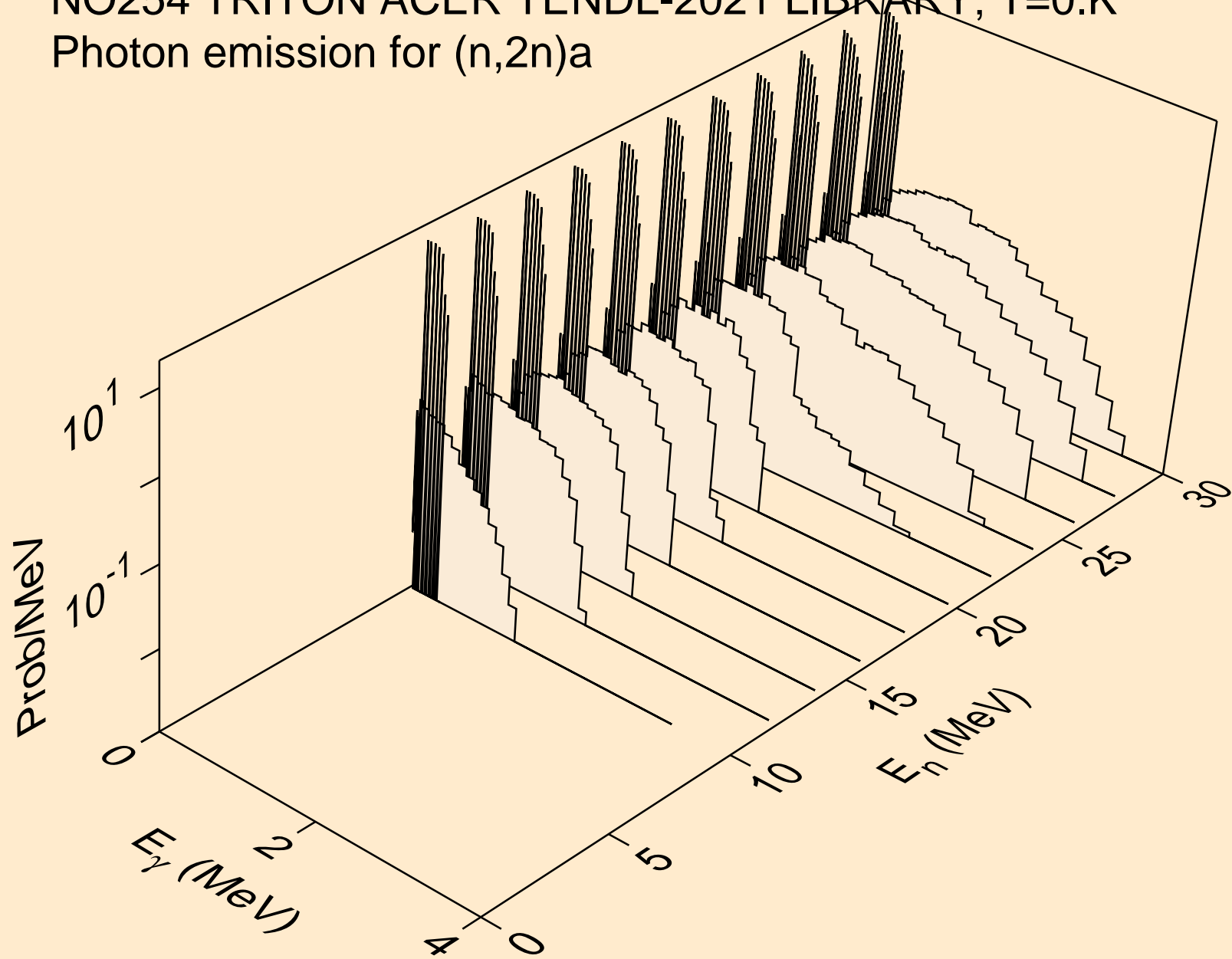

NO254 TRITON ACER TENDL-2021 LIBRARY; T=0.K  
Photon emission for (n,n\*)p

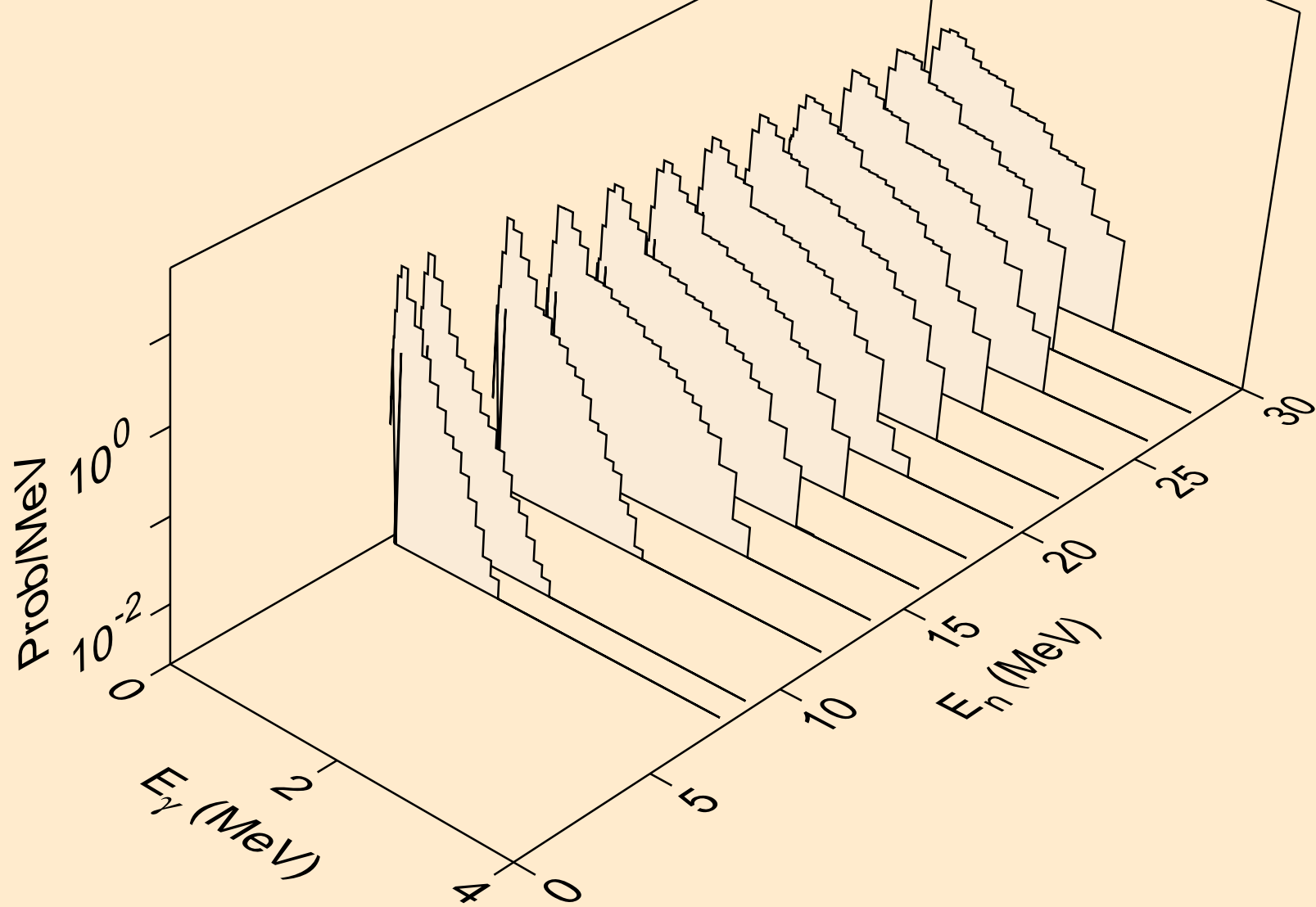

NO254 TRITON ACER TENDL-2021 LIBRARY; T=0.K  
Photon emission for (n,n\*)d

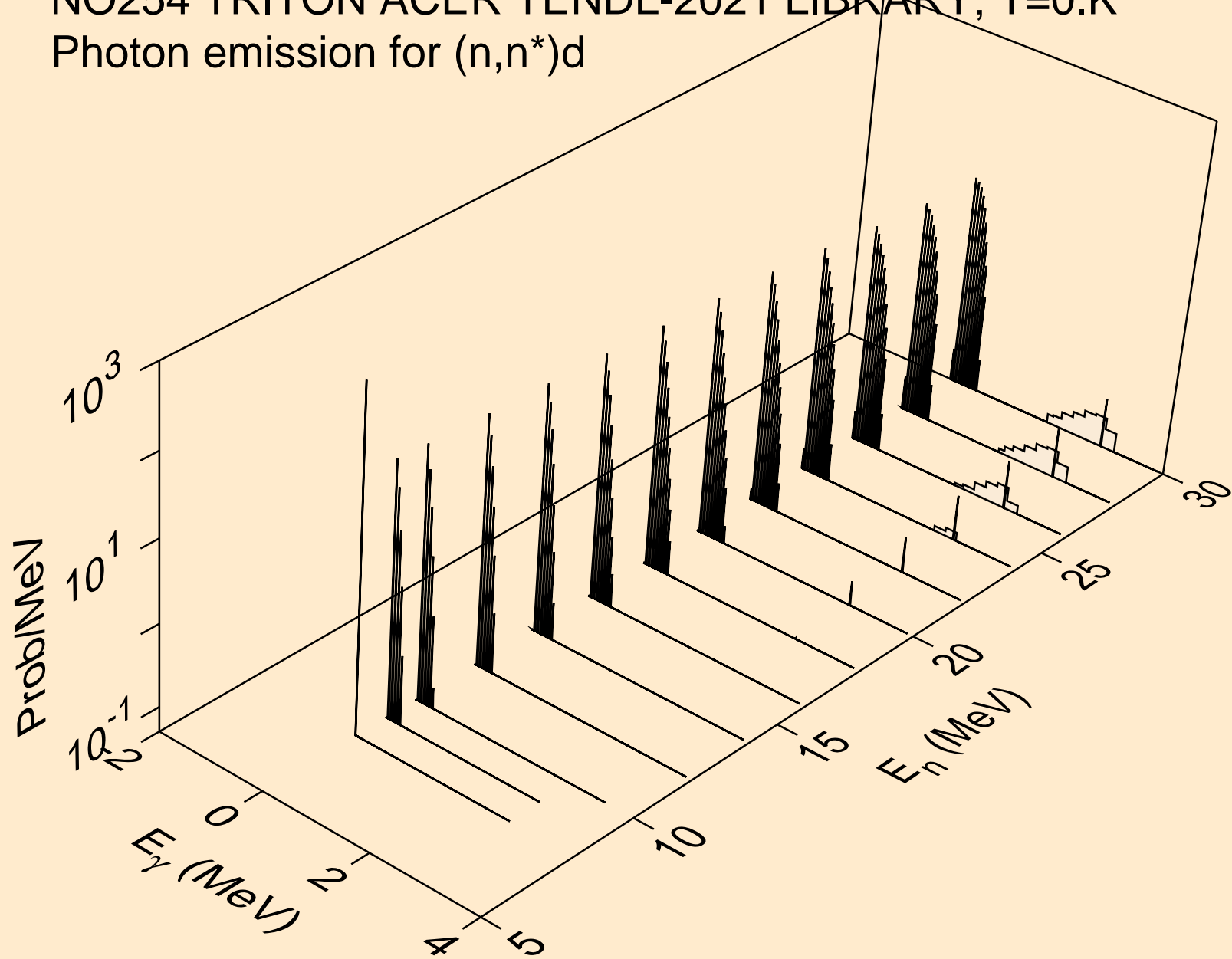

NO254 TRITON ACER TENDL-2021 LIBRARY; T=0.K  
Photon emission for (n,n\*)t

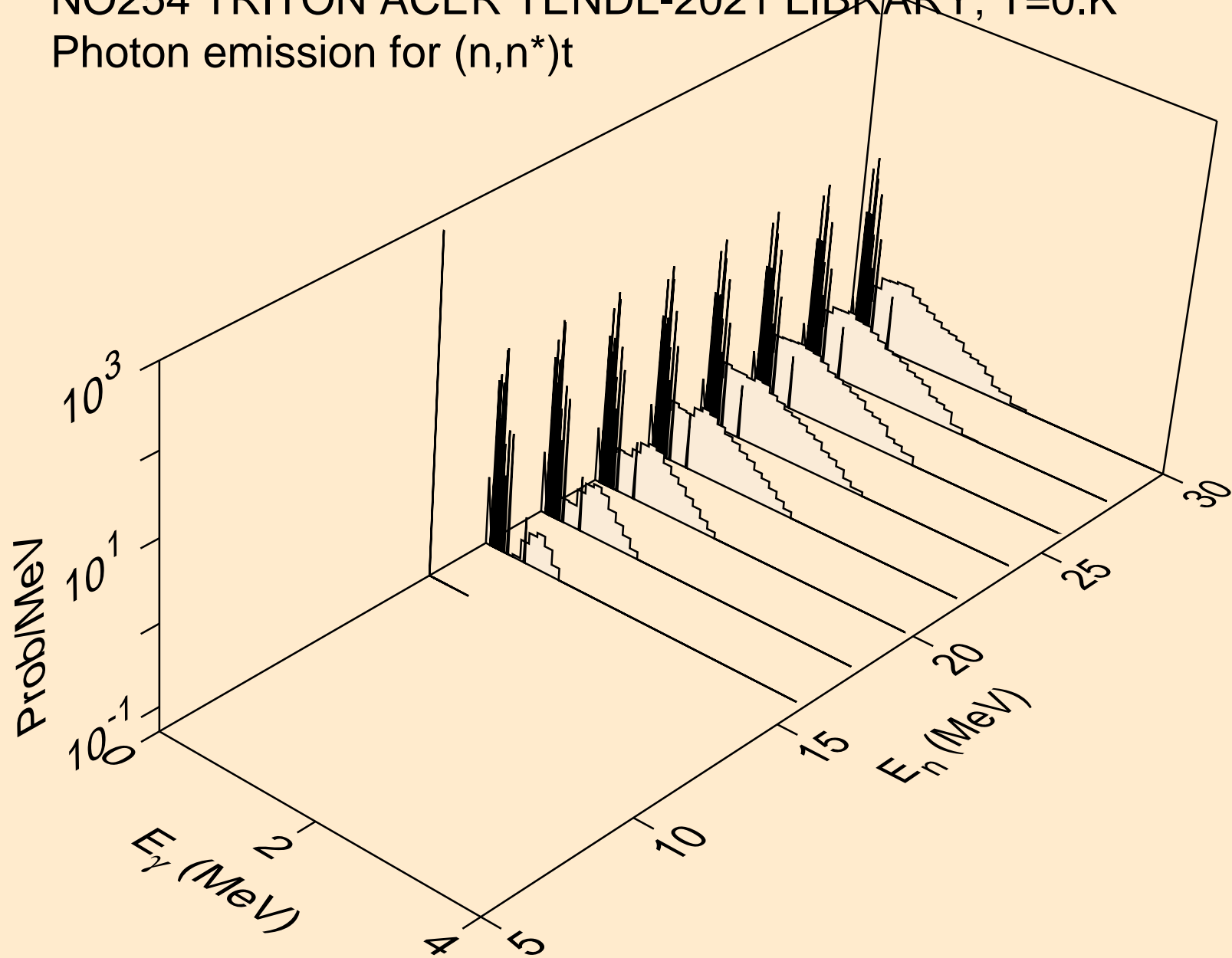



NO254 TRITON ACER TENDL-2021 LIBRARY; T=0.K  
Photon emission for (n,n\*)he3

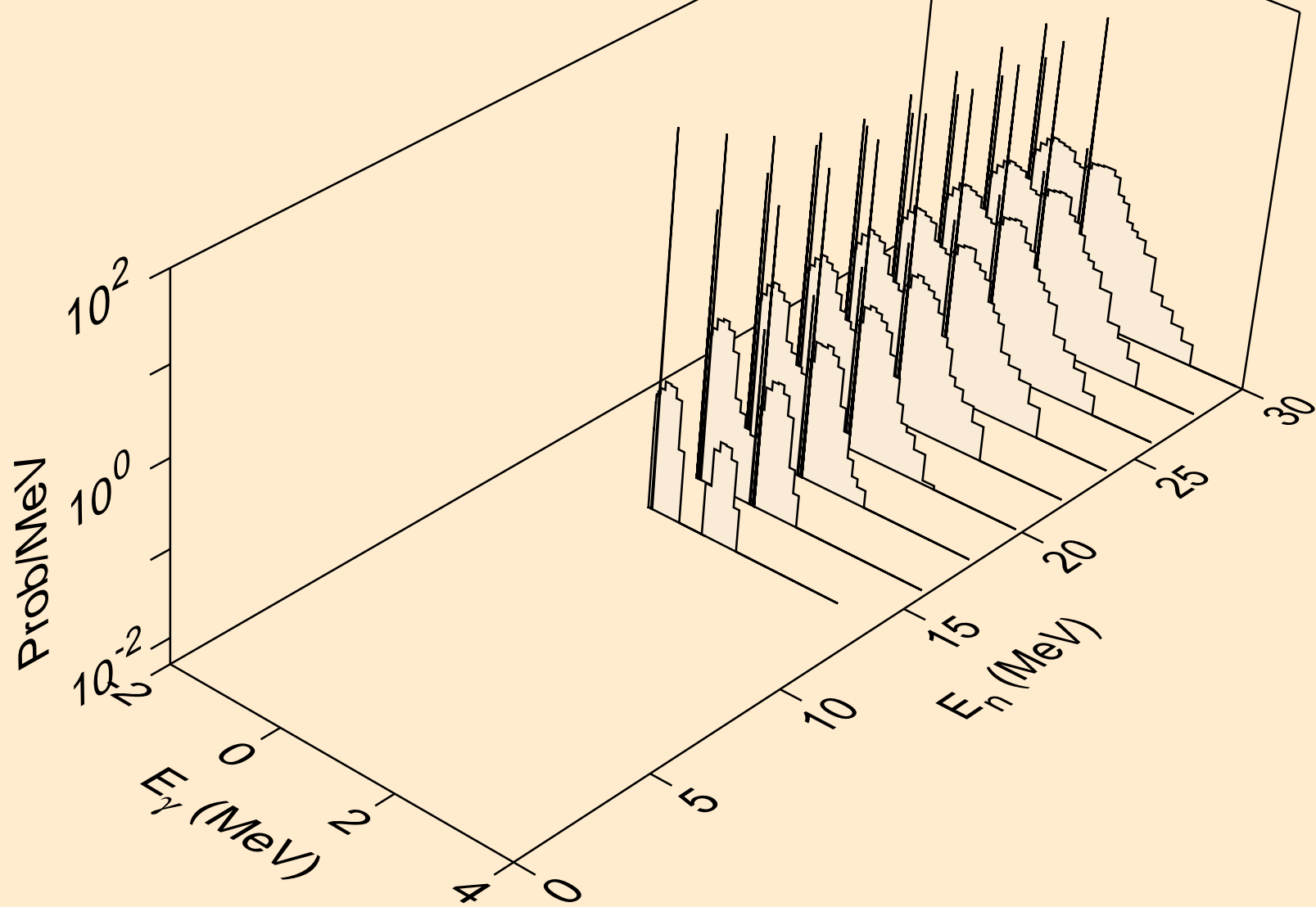

NO254 TRITON ACER TENDL-2021 LIBRARY; T=0.K  
Photon emission for (n,4n)

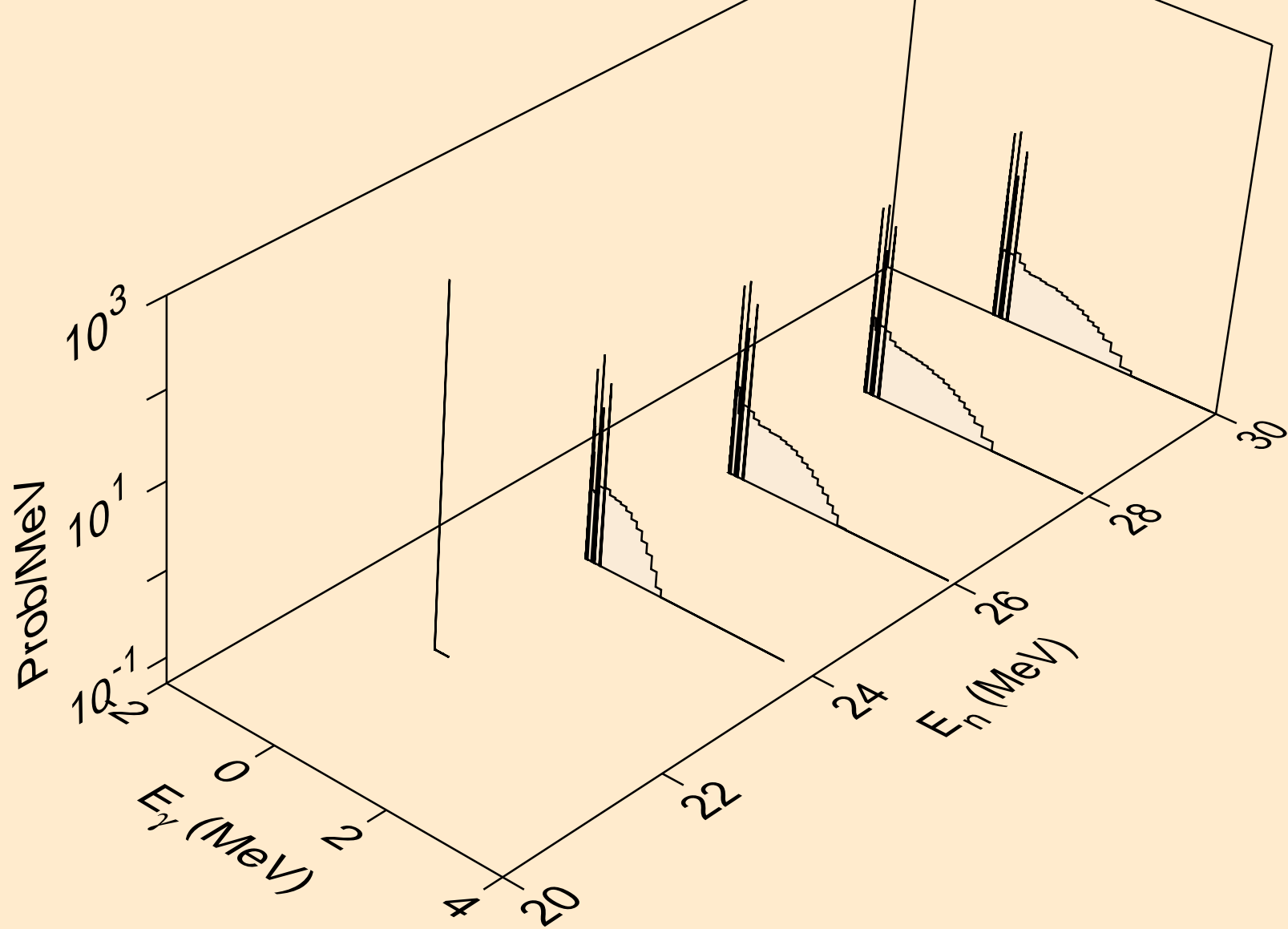

NO254 TRITON ACER TENDL-2021 LIBRARY; T=0.K  
Photon emission for (n,2np)

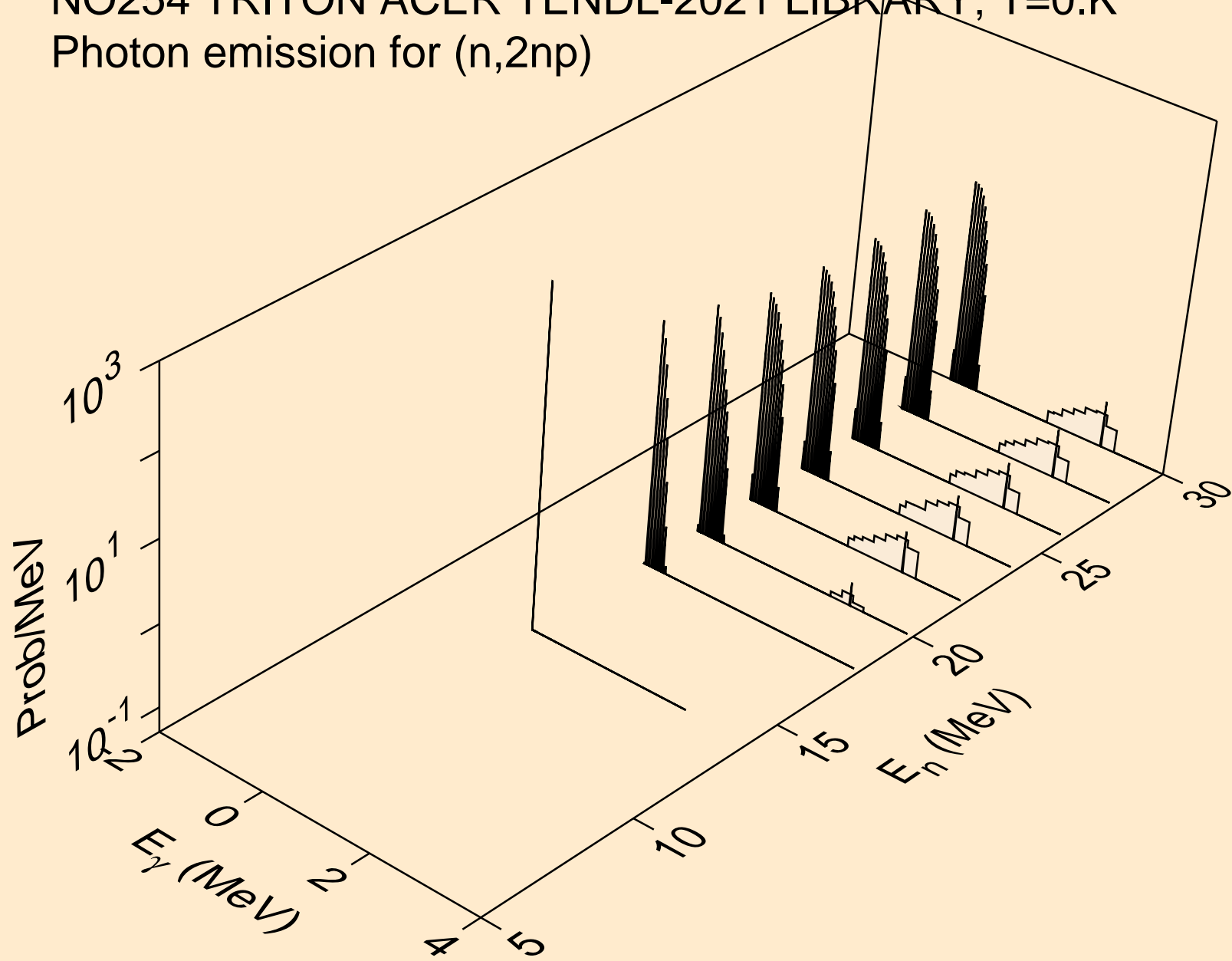

NO254 TRITON ACER TENDL-2021 LIBRARY; T=0.K  
Photon emission for (n,2np)

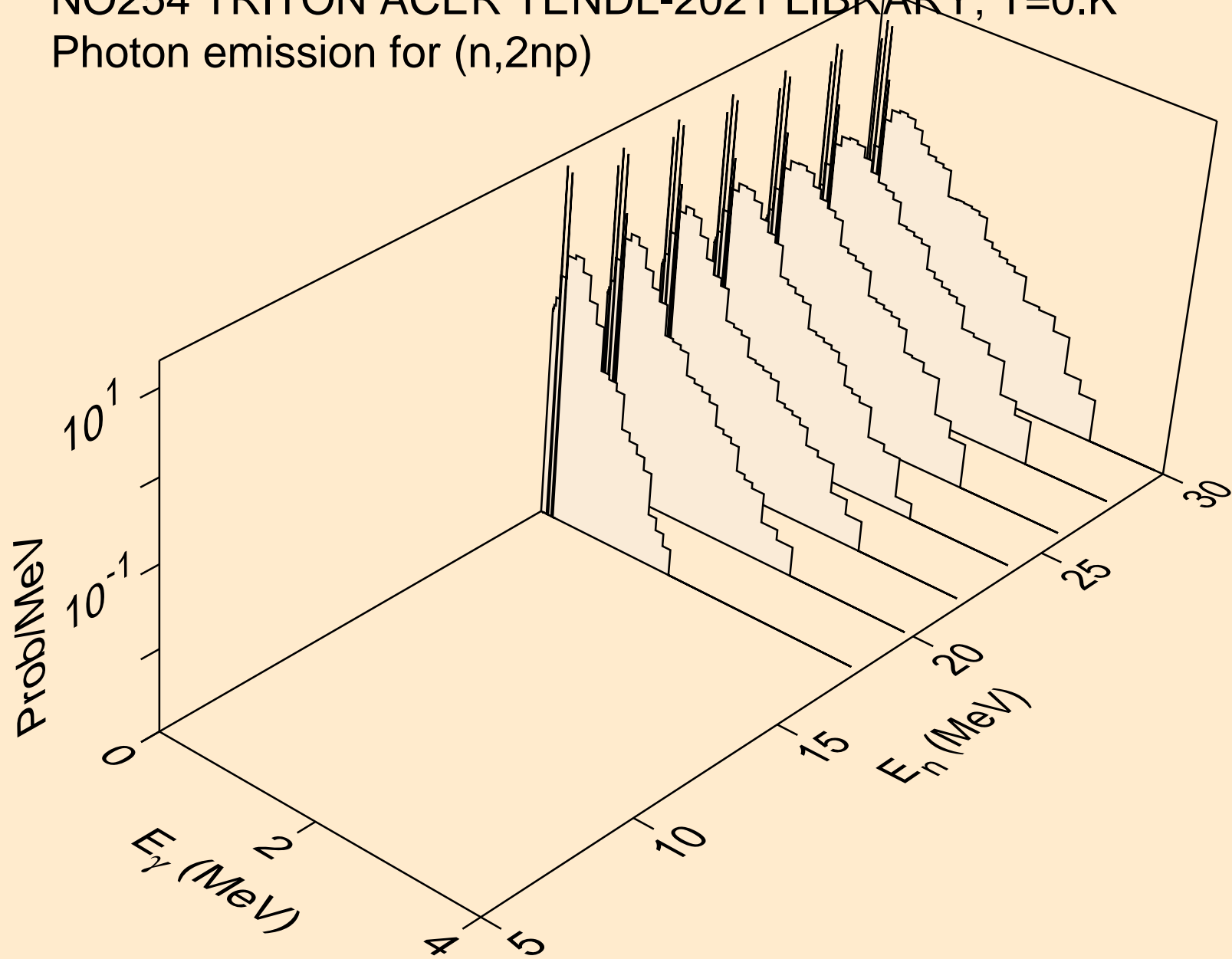

NO254 TRITON ACER TENDL-2021 LIBRARY; T=0.K  
Photon emission for (n,npa)

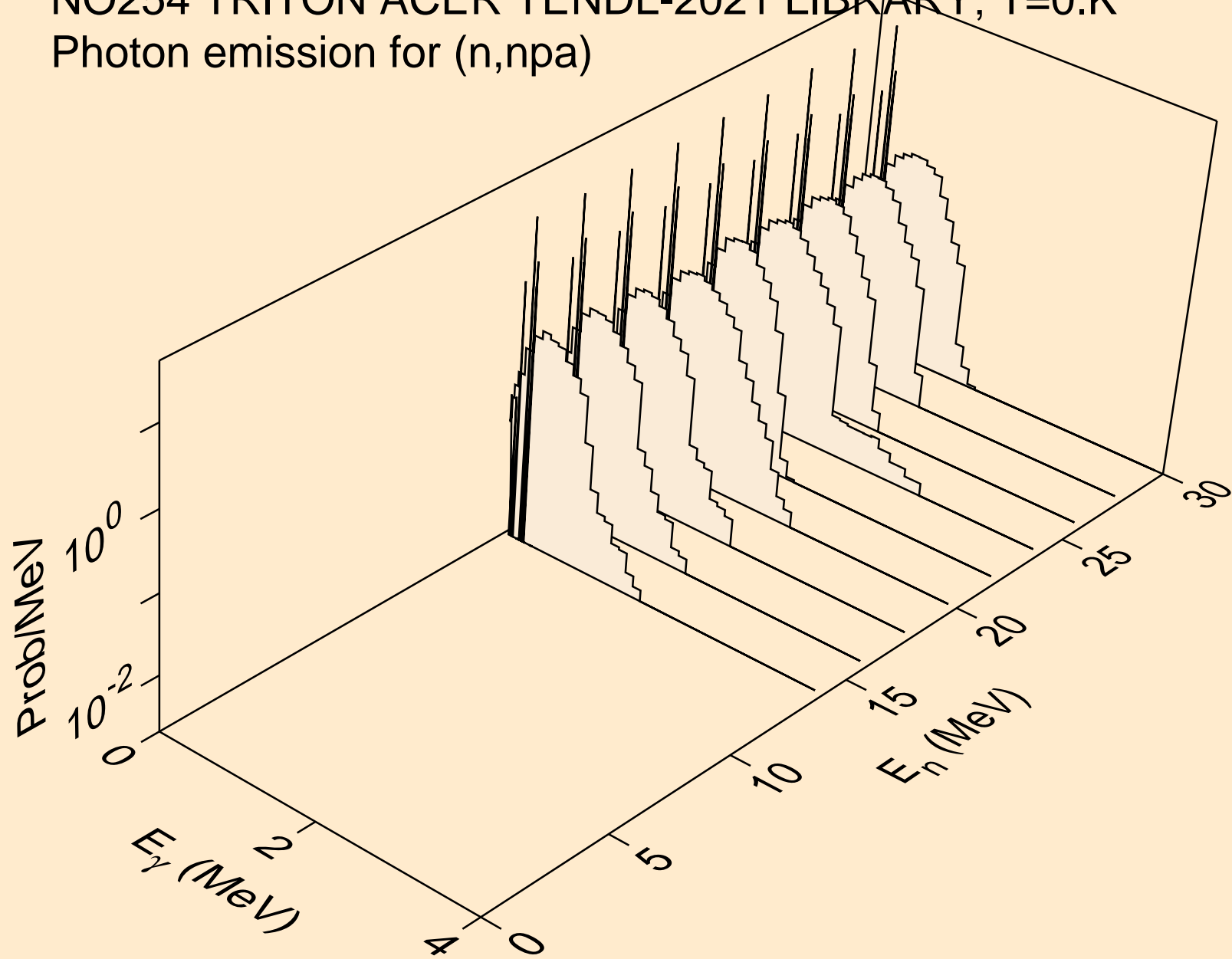

NO254 TRITON ACER TENDL-2021 LIBRARY; T=0.K  
Photon emission for (n,gma)

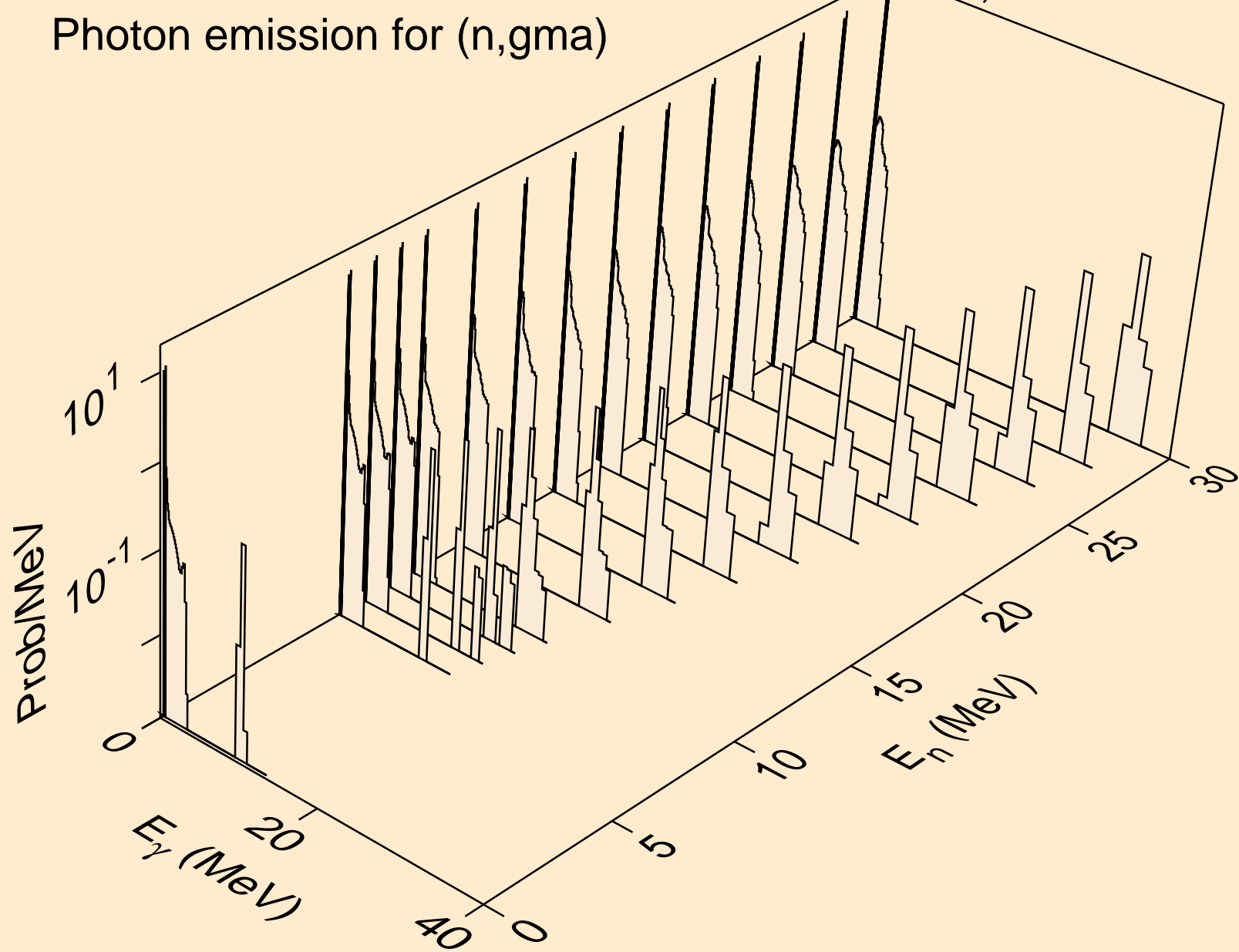

NO254 TRITON ACER TENDL-2021 LIBRARY; T=0.K  
Photon emission for (n,p)

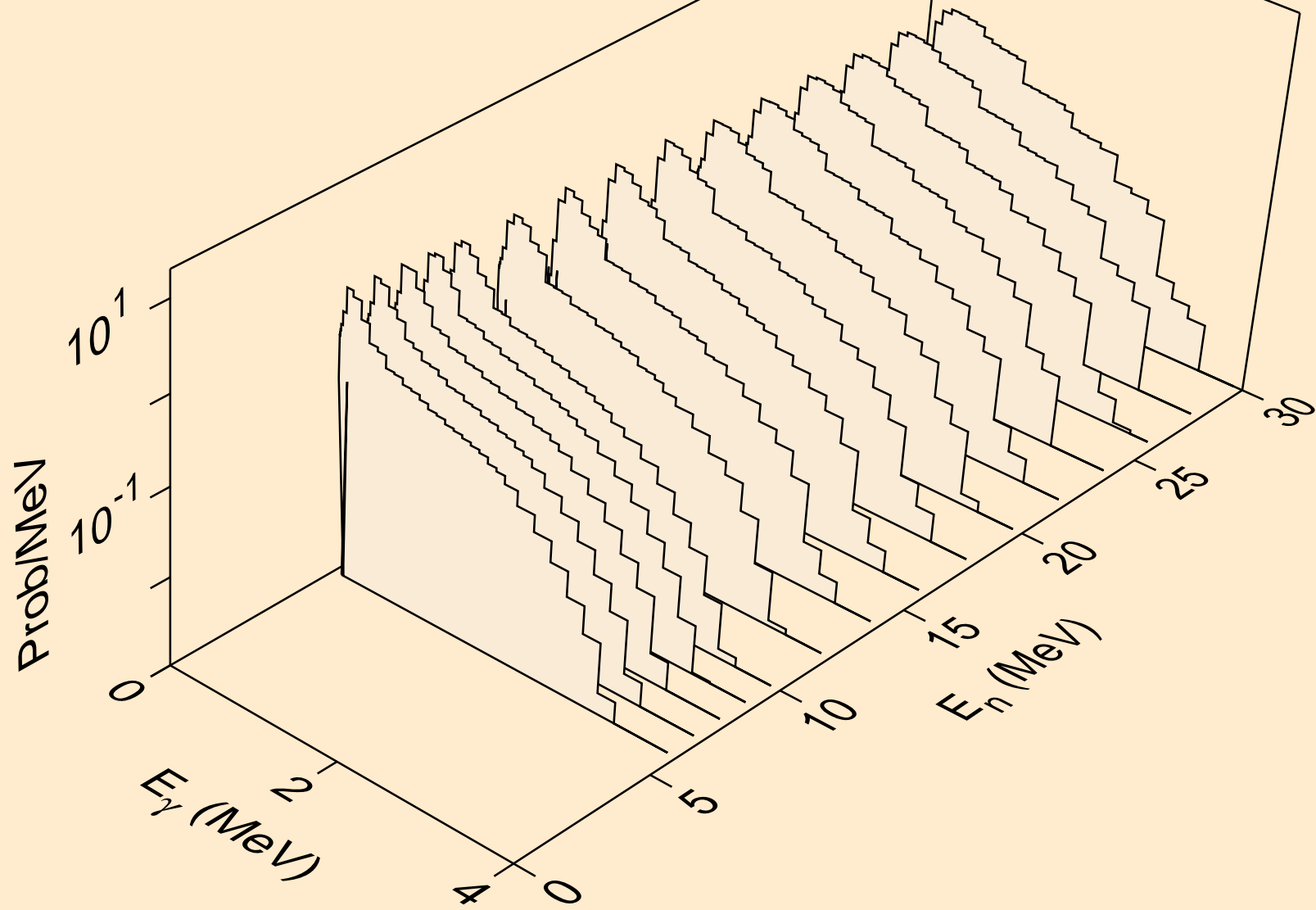

NO254 TRITON ACER TENDL-2021 LIBRARY; T=0.K  
Photon emission for (n,d)

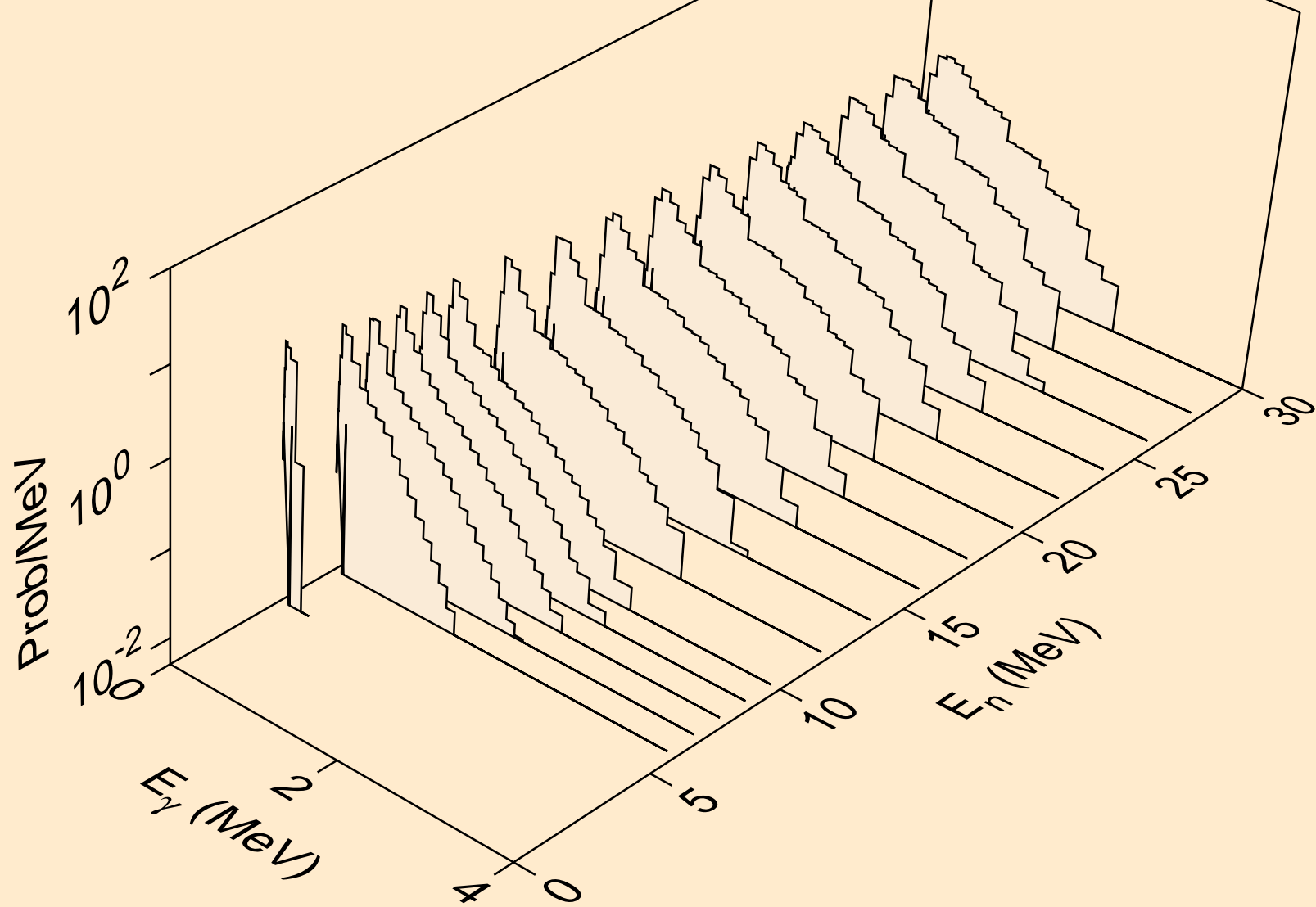



NO254 TRITON ACER TENDL-2021 LIBRARY; T=0.K  
Photon emission for inelastic

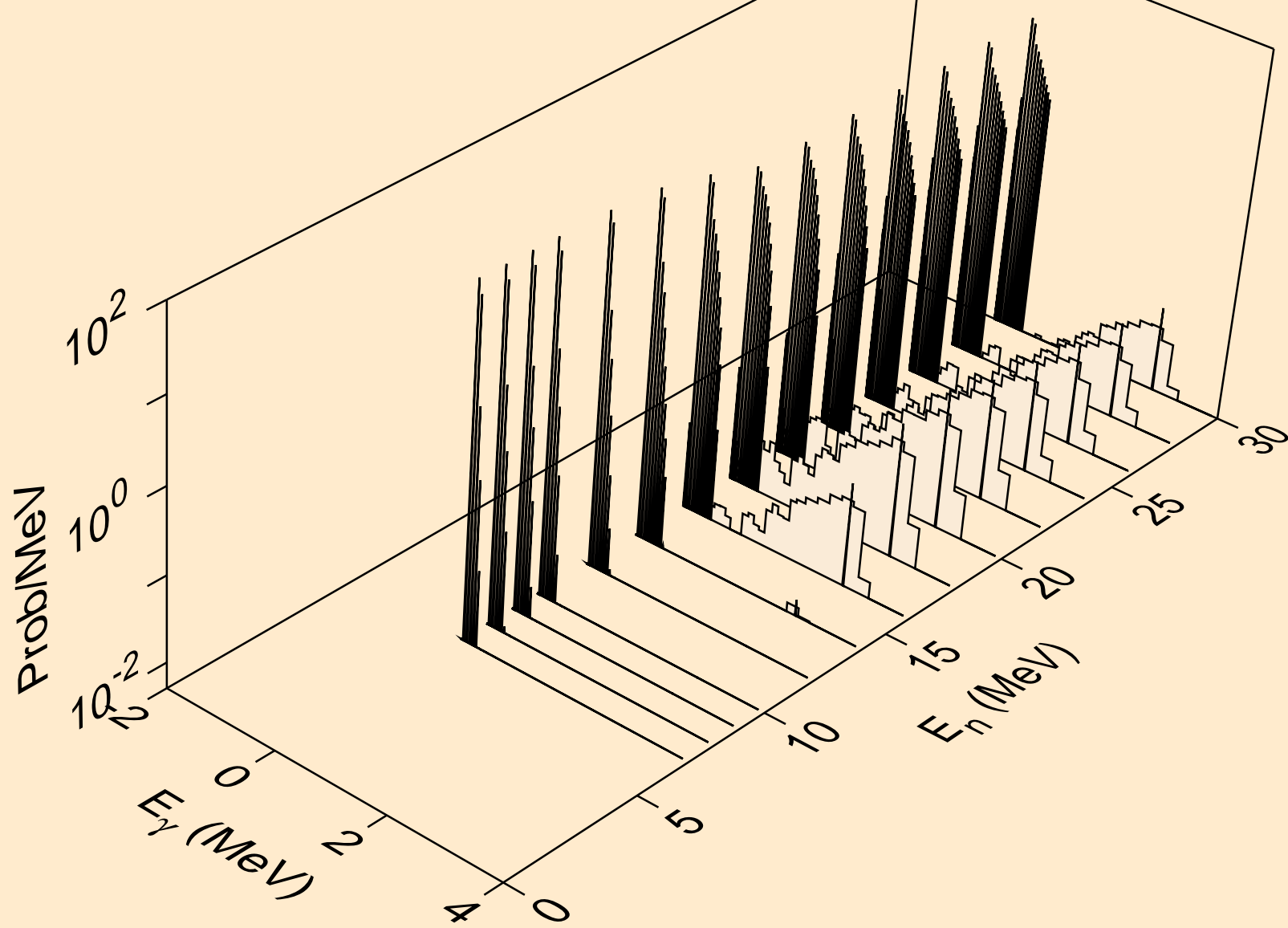

NO254 TRITON ACER TENDL-2021 LIBRARY; T=0.K  
Photon emission for (n,he3)

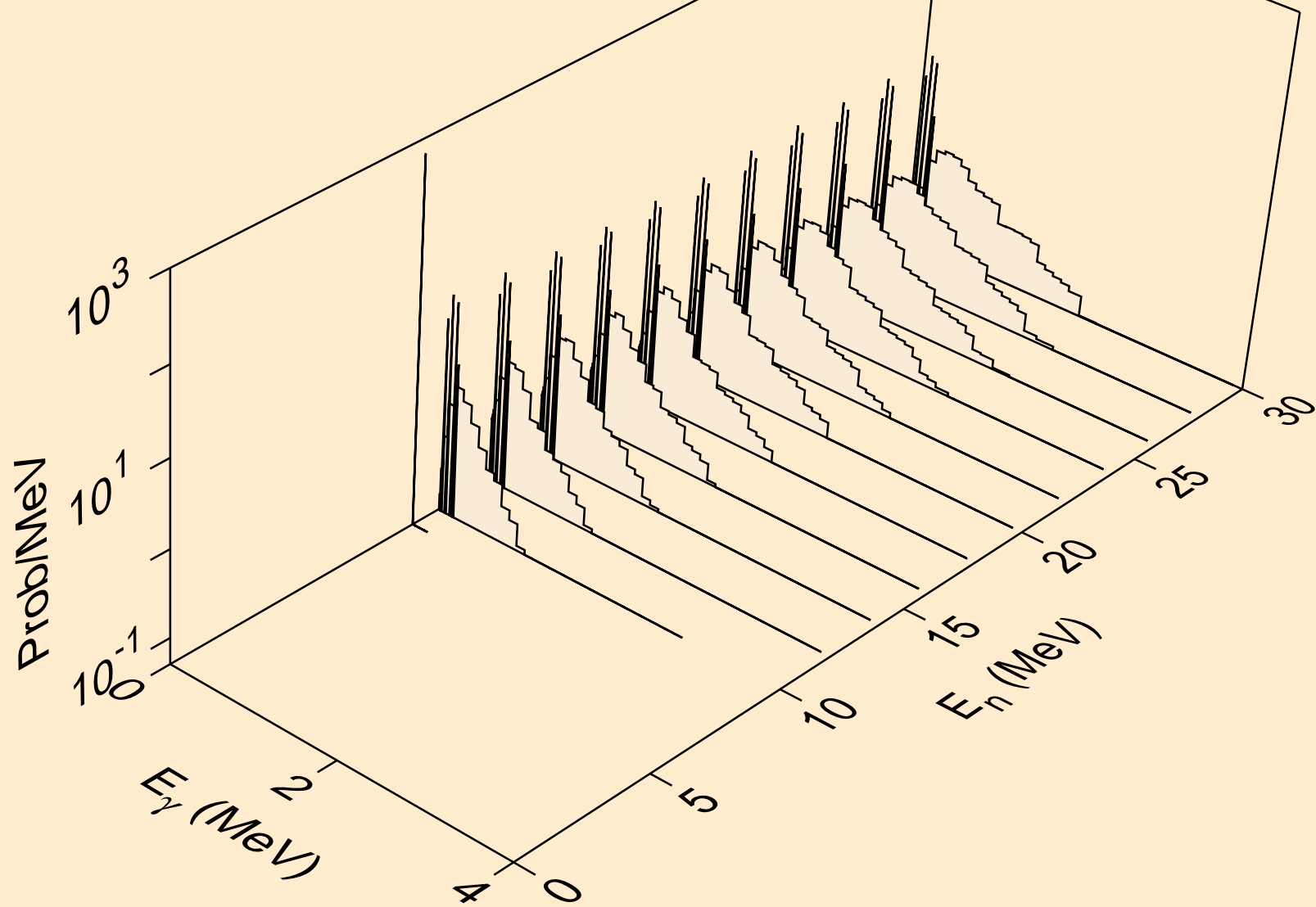

NO254 TRITON ACER TENDL-2021 LIBRARY; T=0.K  
Photon emission for (n,a)

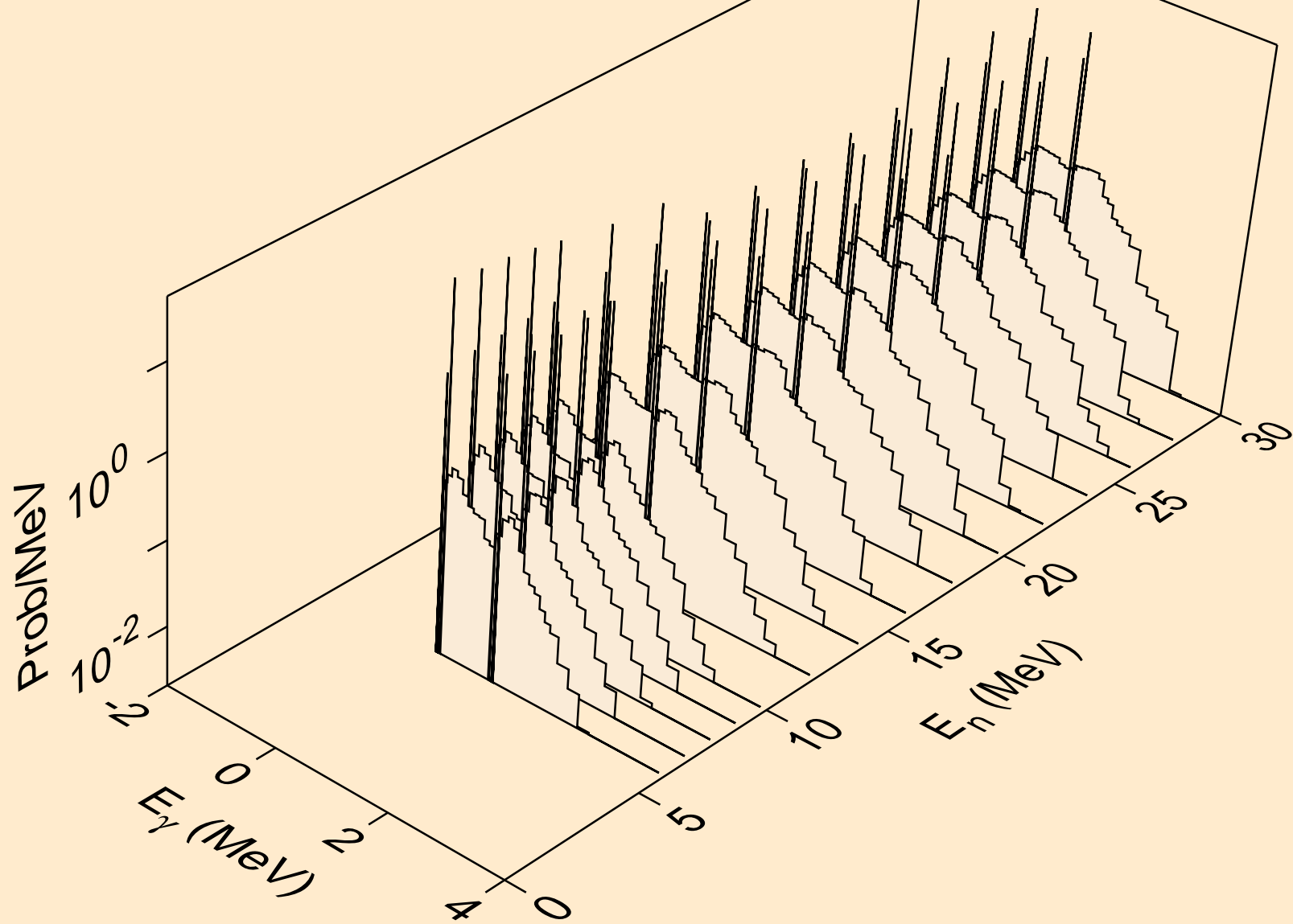

NO254 TRITON ACER TENDL-2021 LIBRARY; T=0.K  
Photon emission for (n,2a)

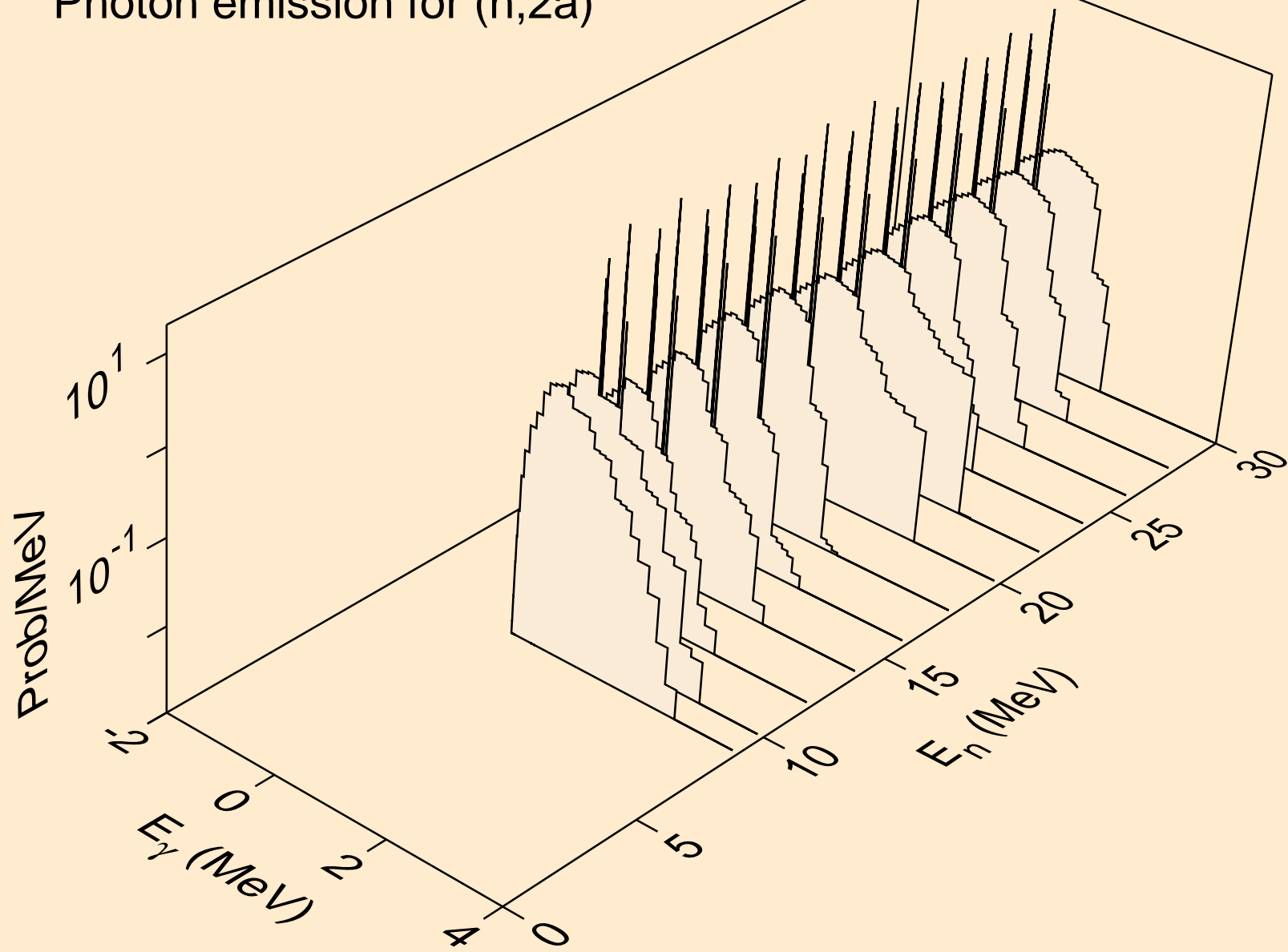

NO254 TRITON ACER TENDL-2021 LIBRARY; T=0.K  
Photon emission for (n,2p)

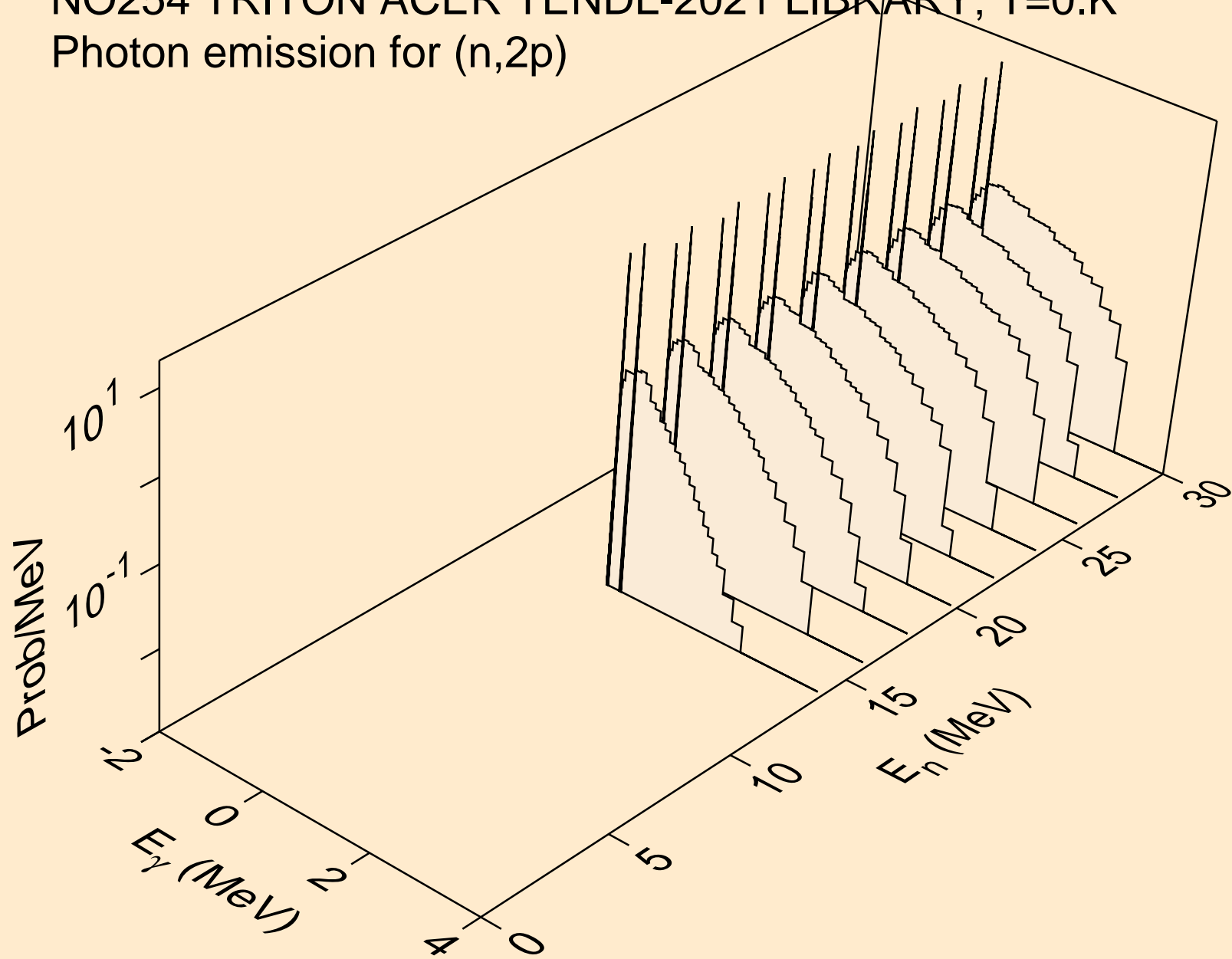

NO254 TRITON ACER TENDL-2021 LIBRARY; T=0.K  
Photon emission for (n,pd)

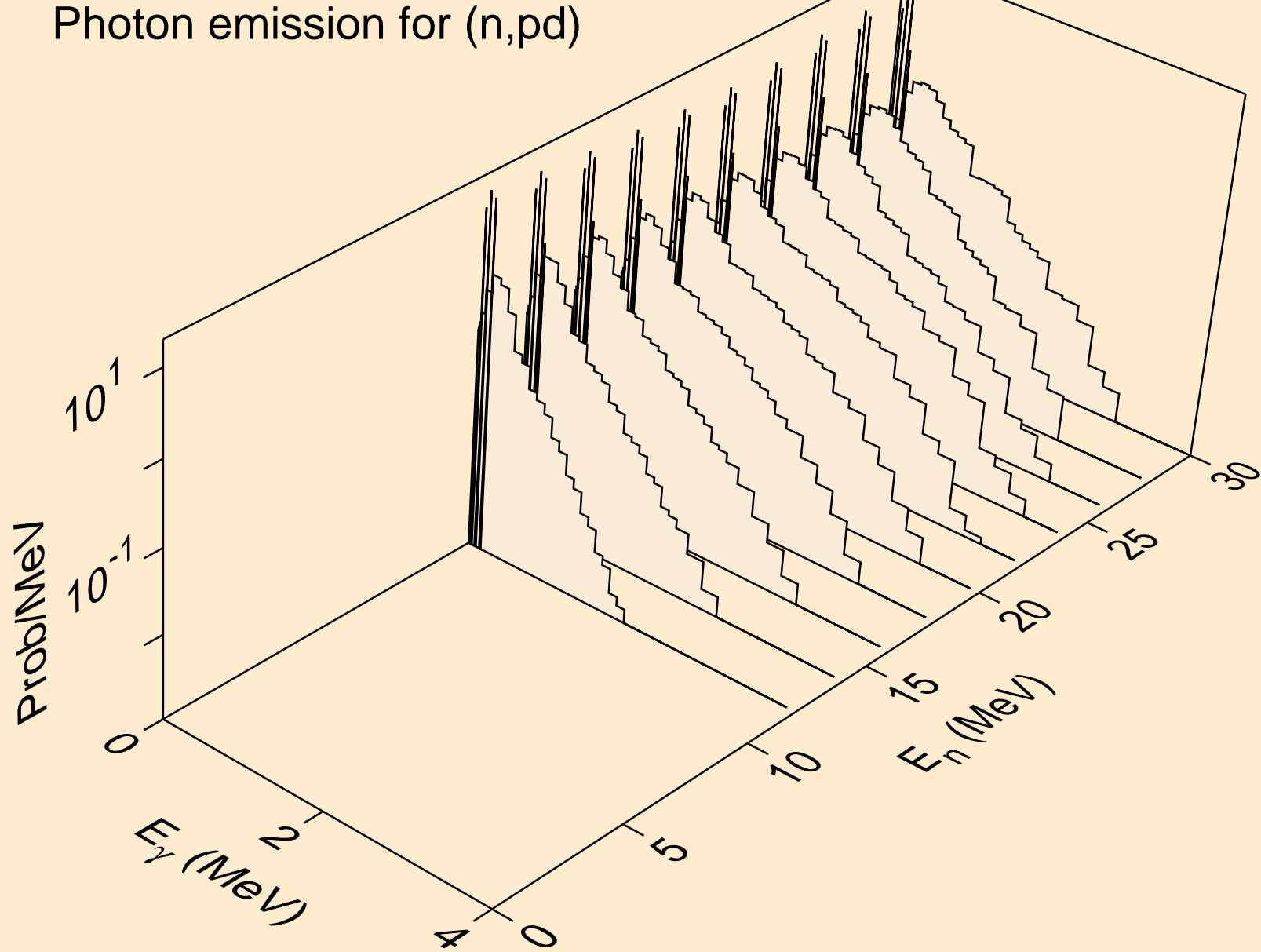

NO254 TRITON ACER TENDL-2021 LIBRARY; T=0.K  
Photon emission for (n,da)

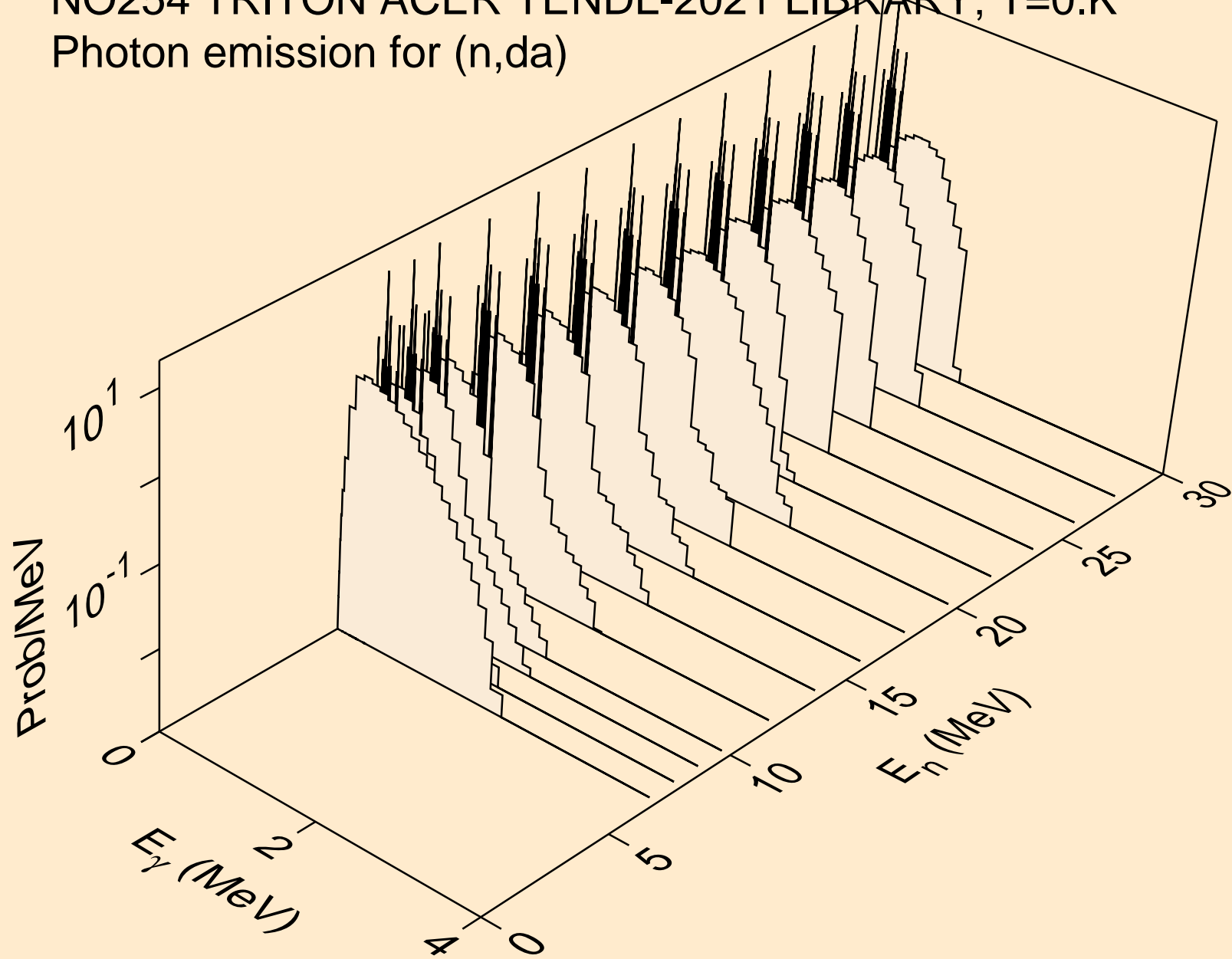

NO254 TRITON ACER TENDL-2021 LIBRARY; T=0.K  
Particle heating contributions

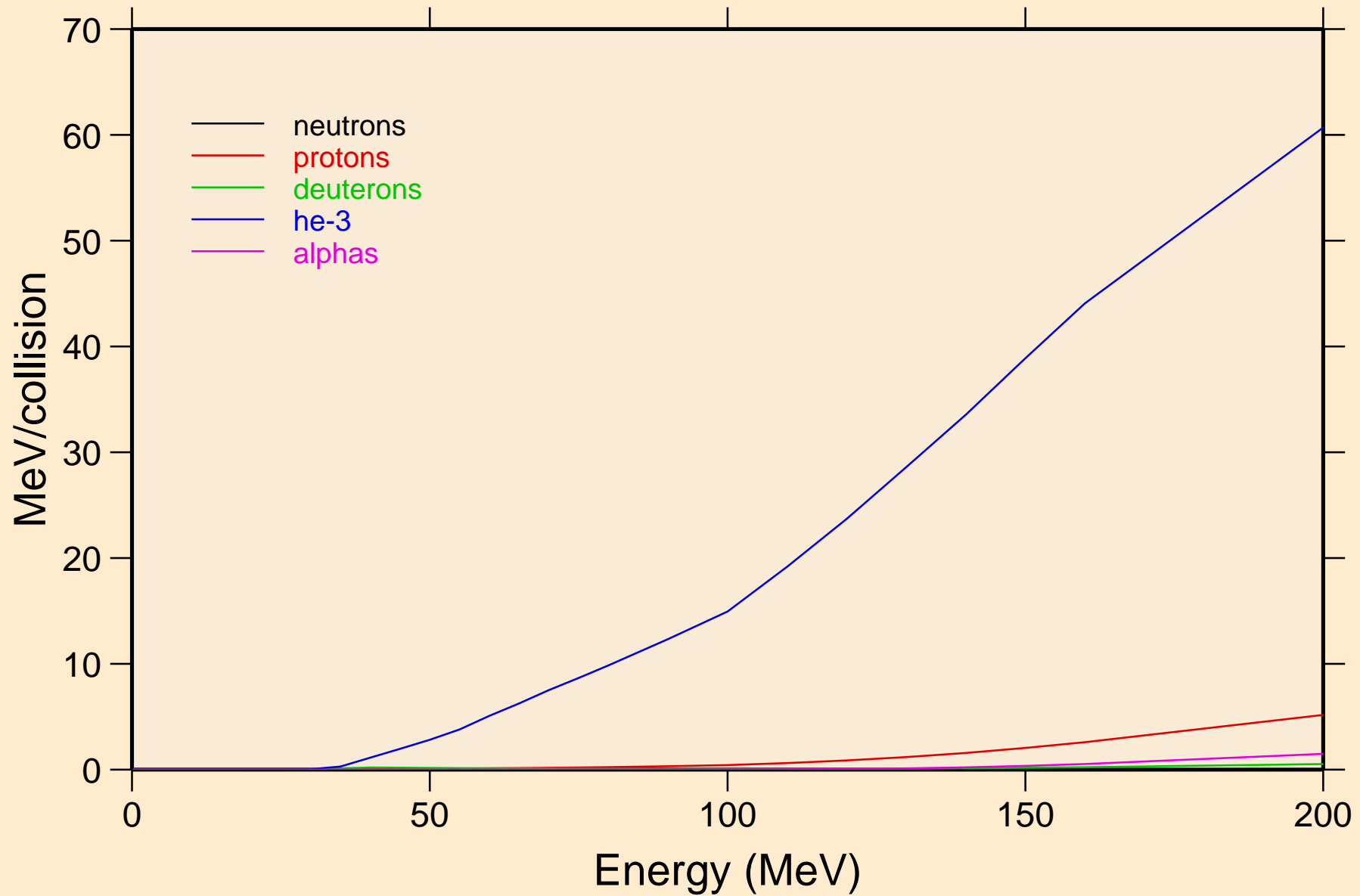



NO254 TRITON ACER TENDL-2021 LIBRARY; T=0.K  
Recoil Heating

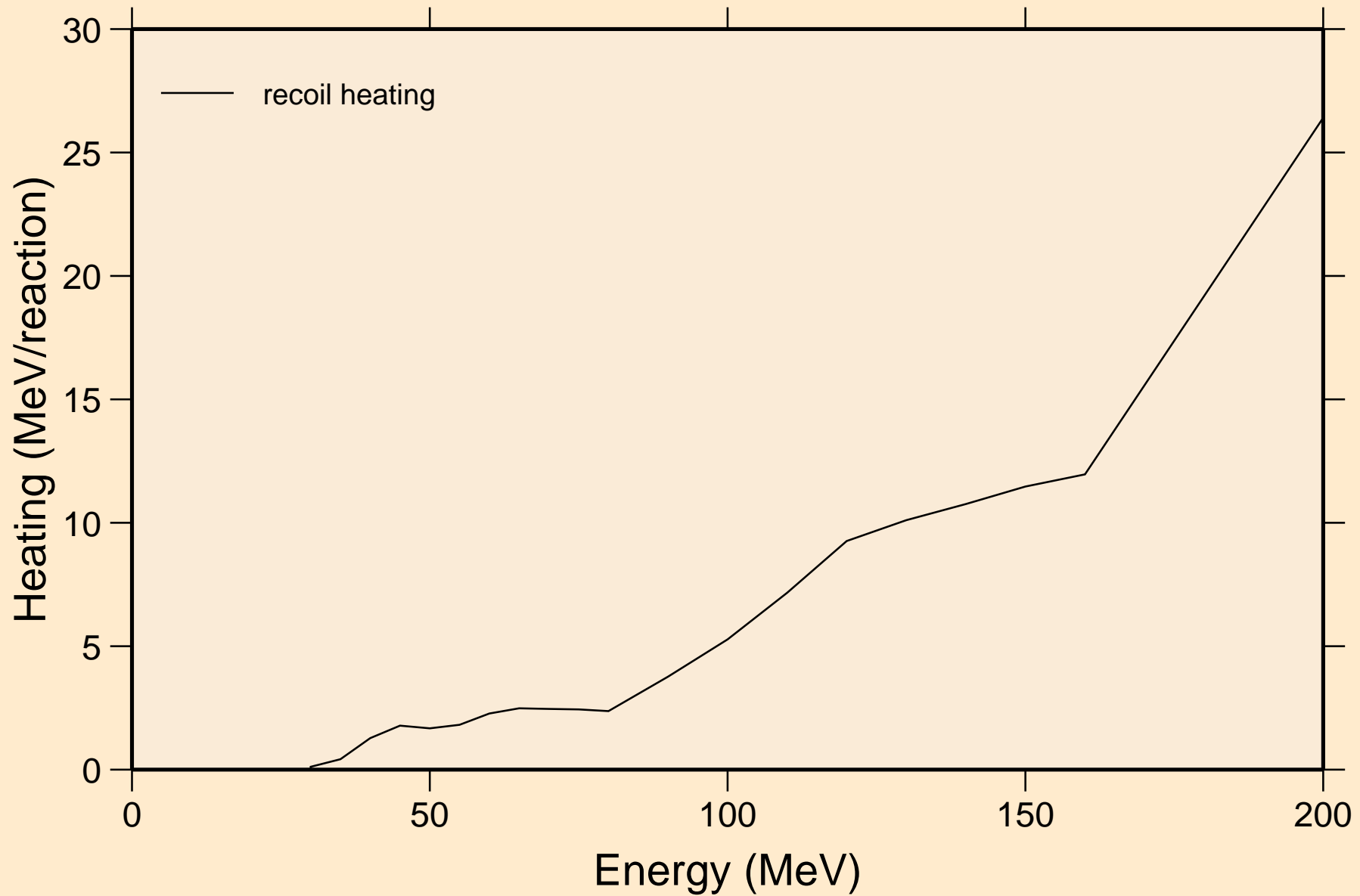

NO254 TRITON ACER TENDL-2021 LIBRARY; T=0.K  
Particle production cross sections

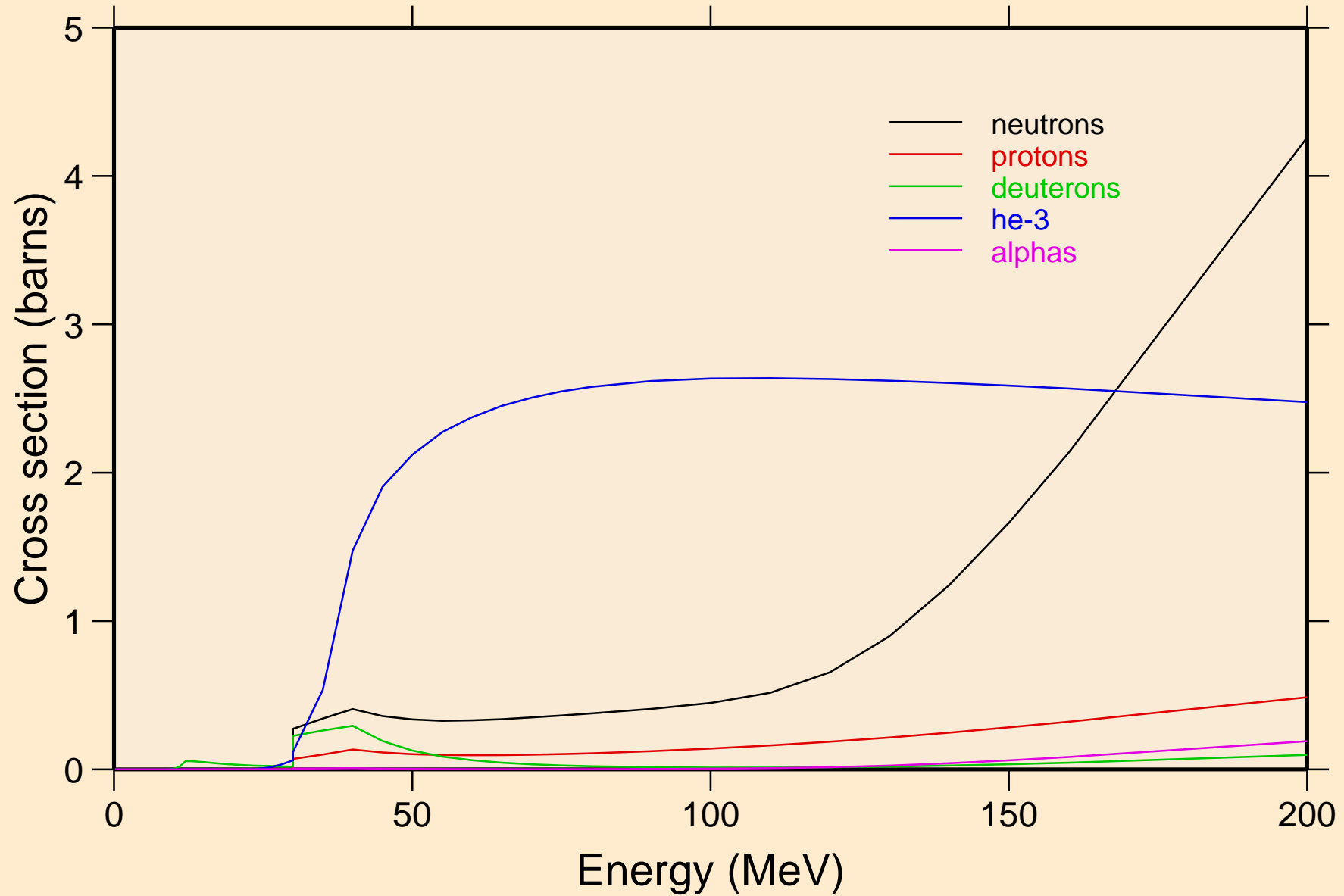

NO254 TRITON ACER TENDL-2021 LIBRARY; T=0.K  
neutrons from (t,n)

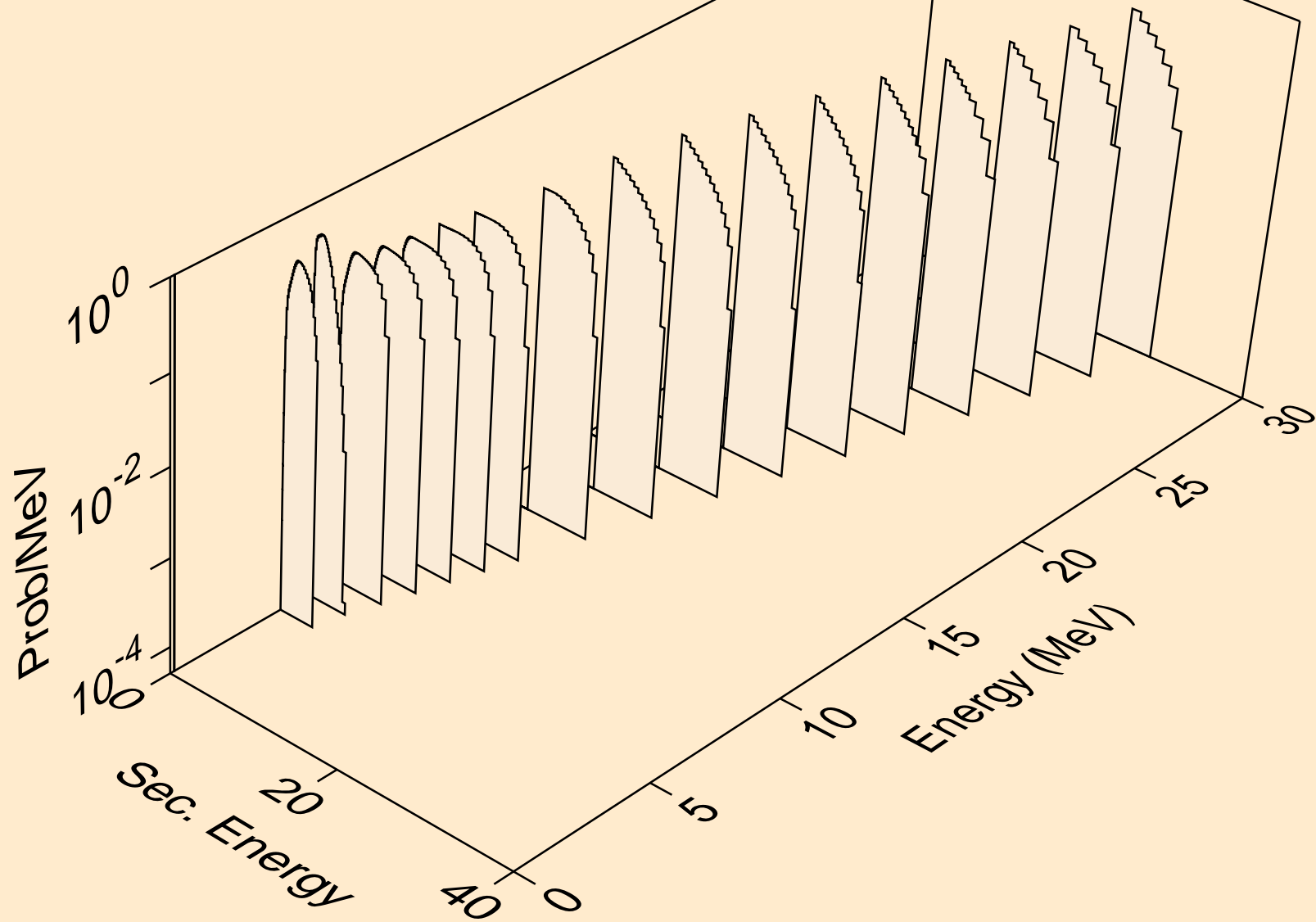

NO254 TRITON ACER TENDL-2021 LIBRARY; T=0.K  
neutrons from (t,x)

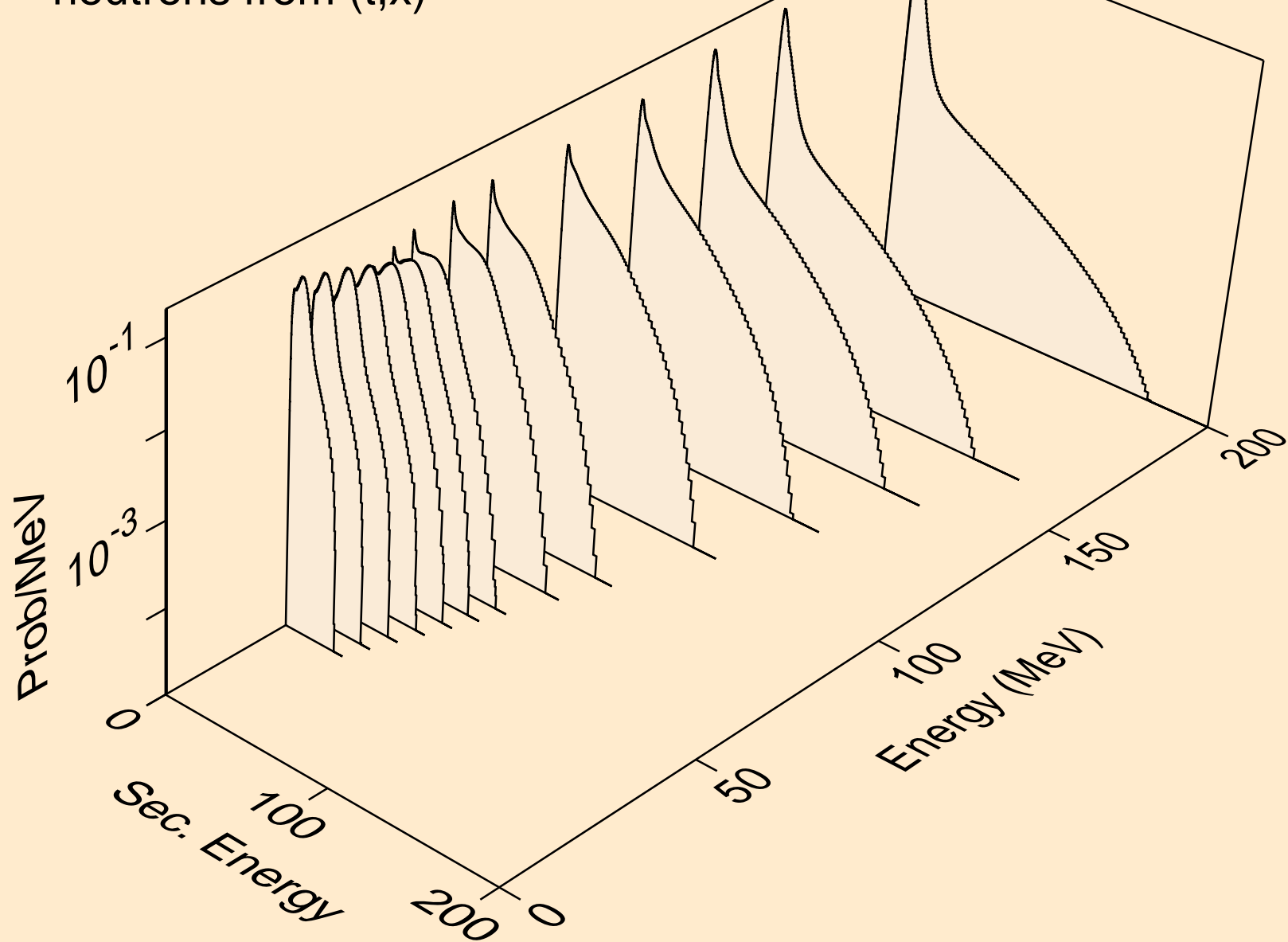

NO254 TRITON ACER TENDL-2021 LIBRARY; T=0.K  
neutrons from (t,2n)

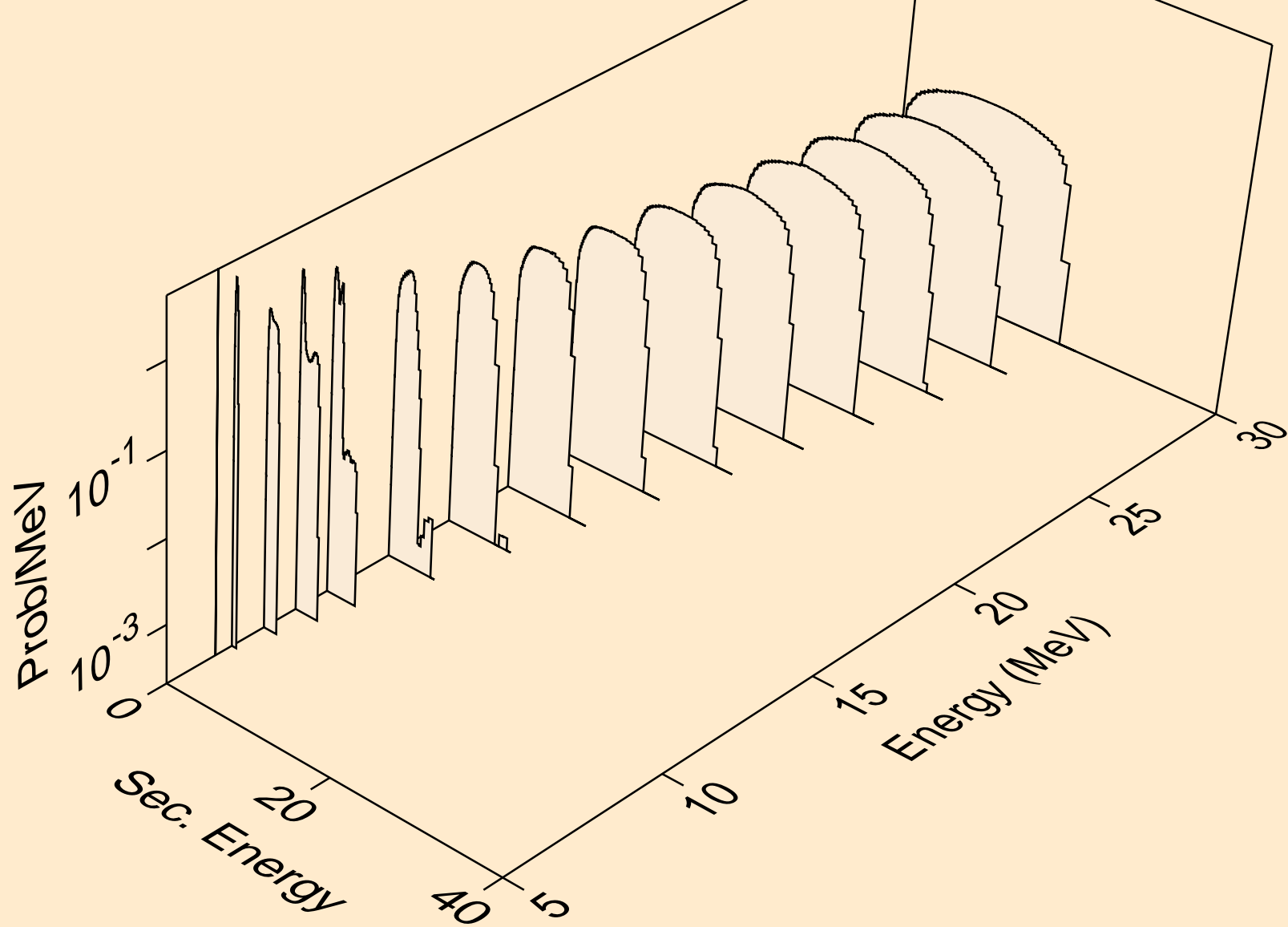

NO254 TRITON ACER TENDL-2021 LIBRARY; T=0.K  
neutrons from (t,3n)

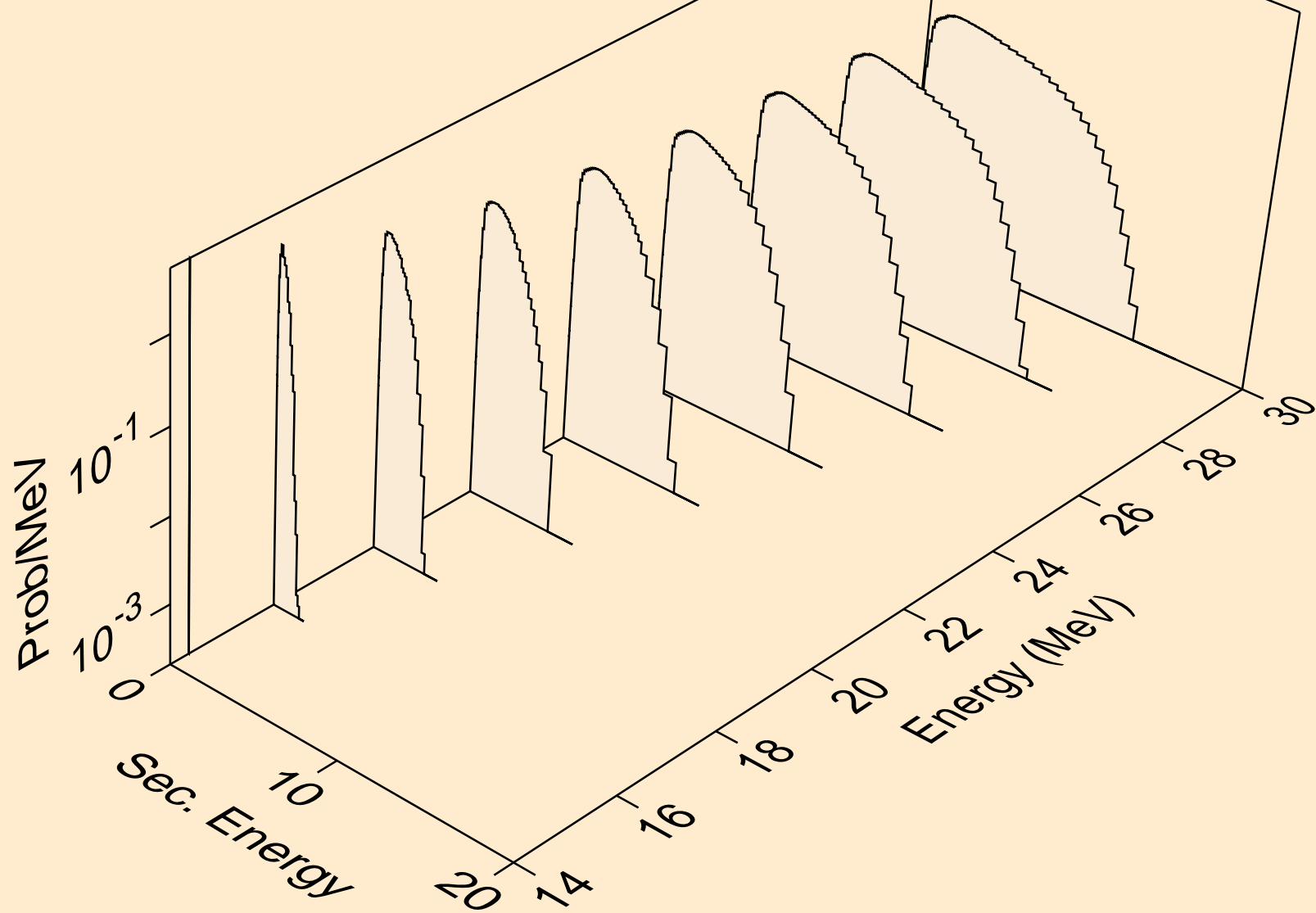

NO254 TRITON ACER TENDL-2021 LIBRARY; T=0.K  
neutrons from (t,n\*)a

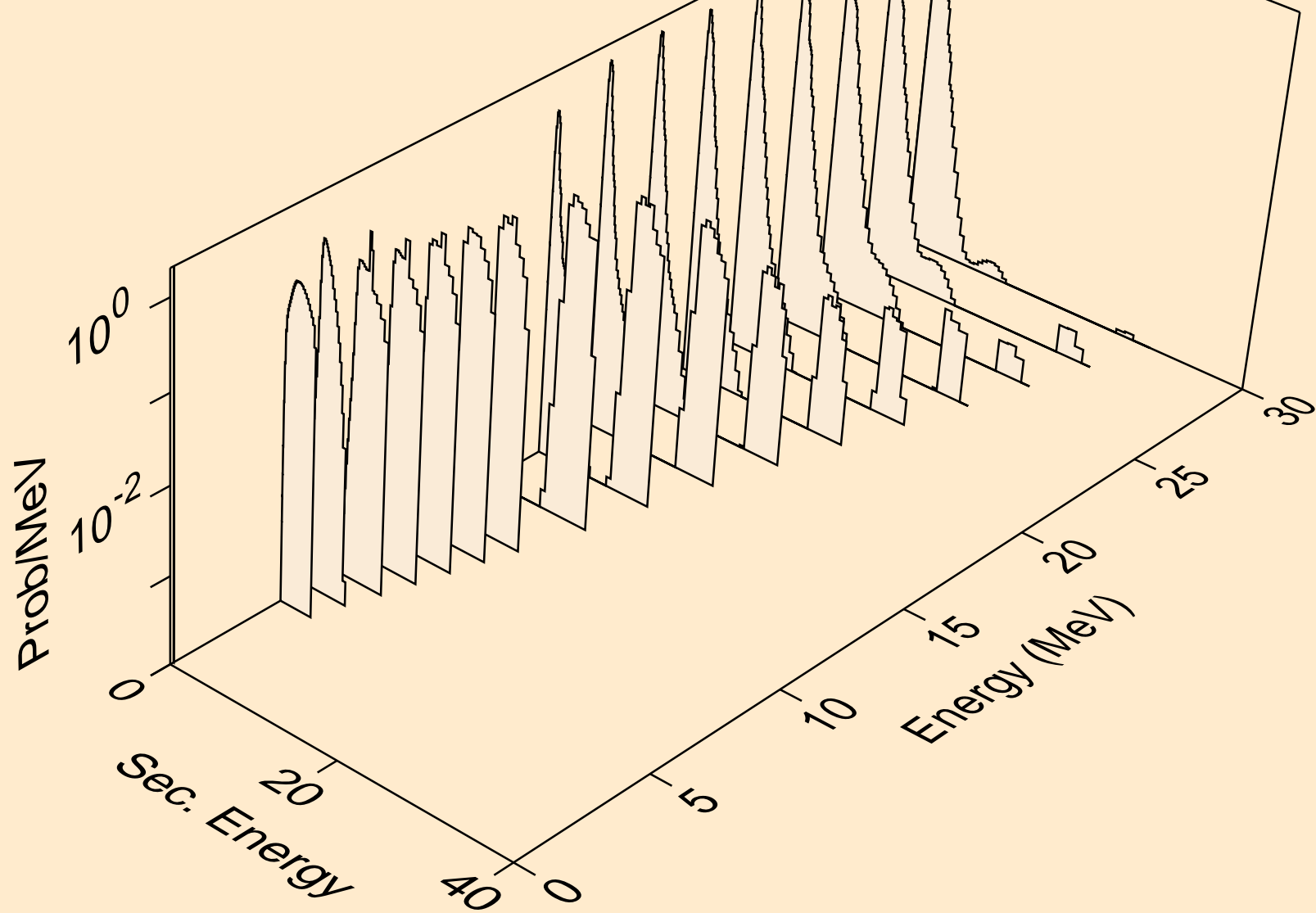

NO254 TRITON ACER TENDL-2021 LIBRARY; T=0.K  
neutrons from (t,2n)a

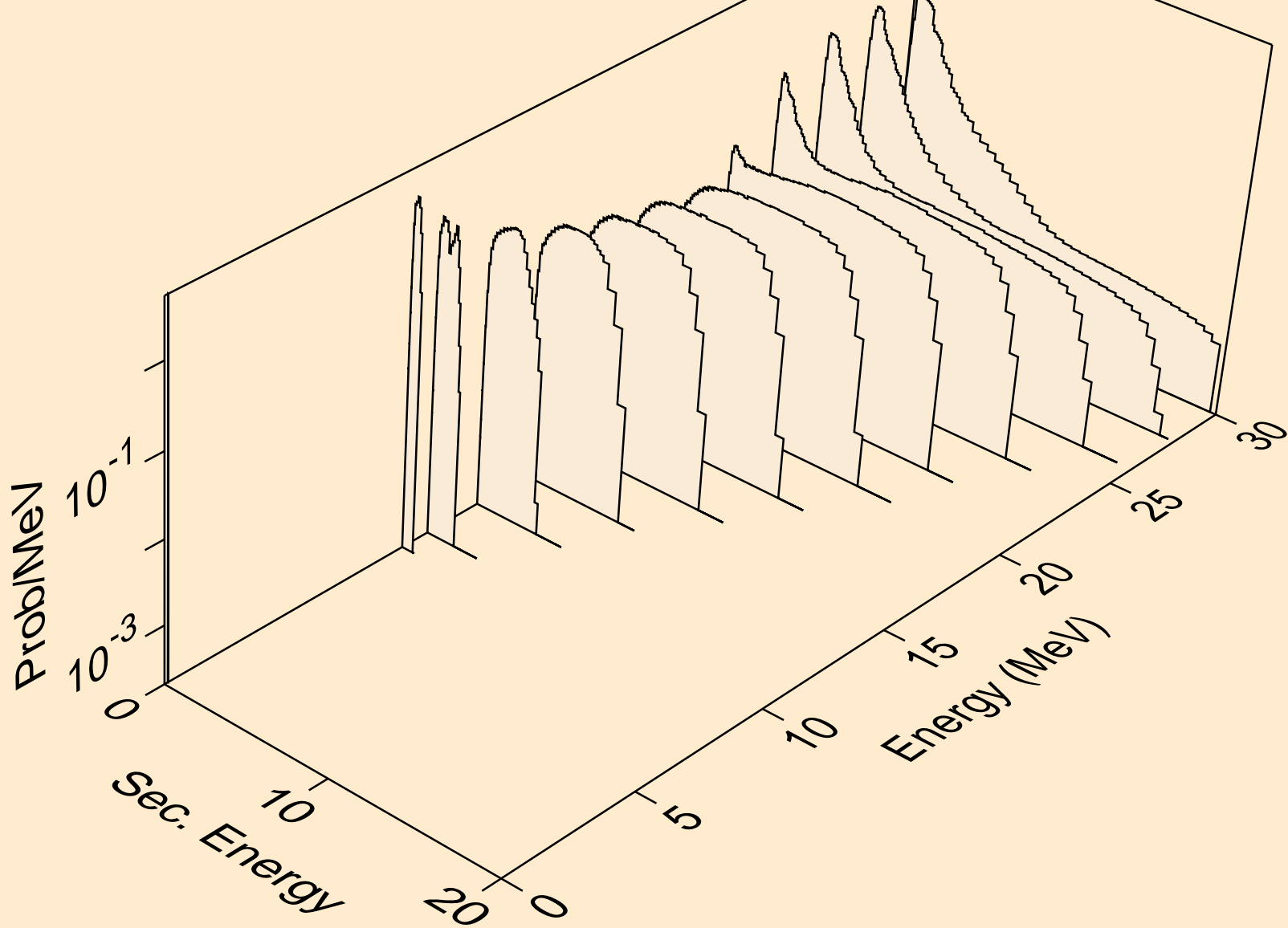



NO254 TRITON ACER TENDL-2021 LIBRARY; T=0.K  
neutrons from (t,n\*)p

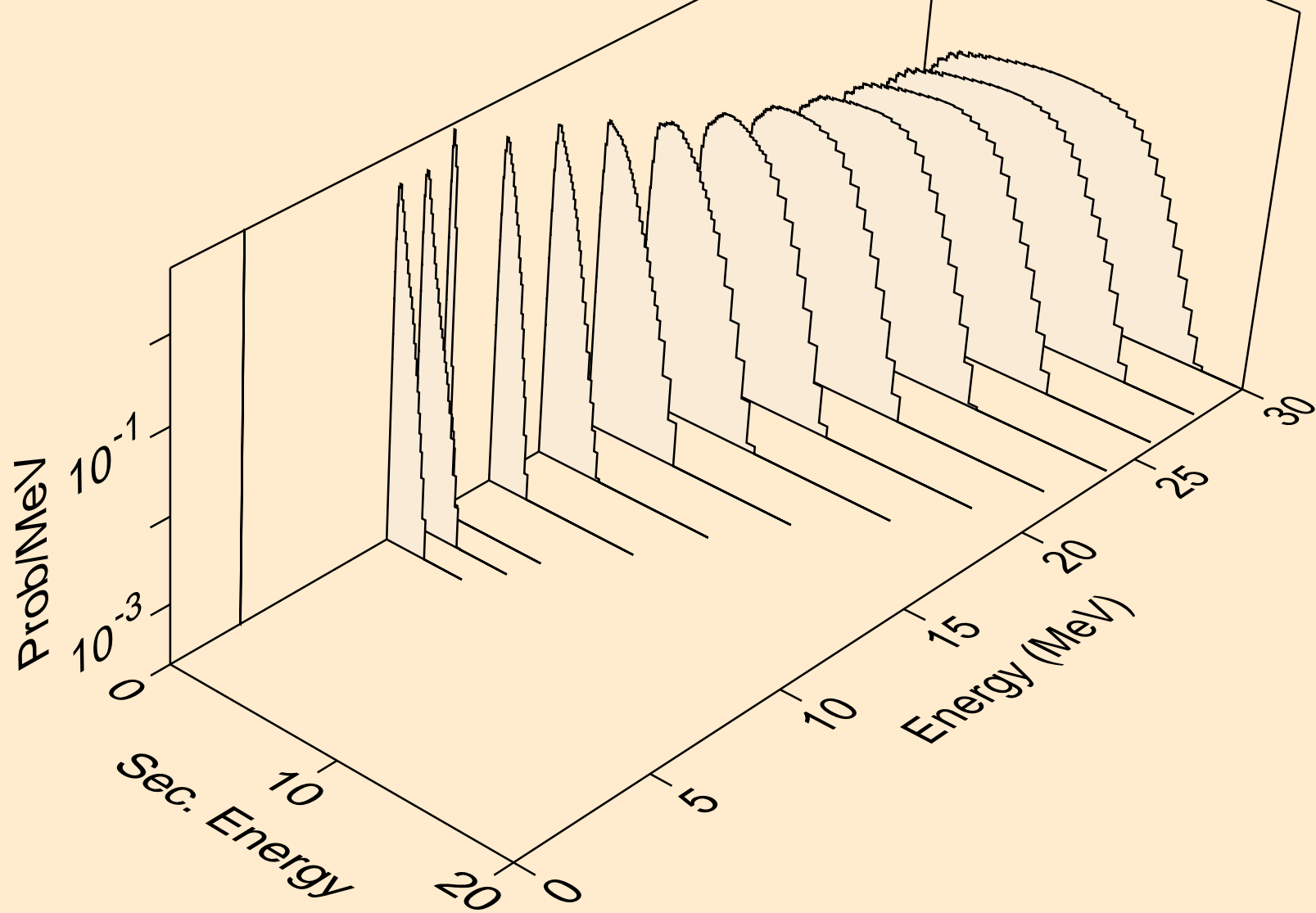

NO254 TRITON ACER TENDL-2021 LIBRARY; T=0.K  
neutrons from (t,n\*)d

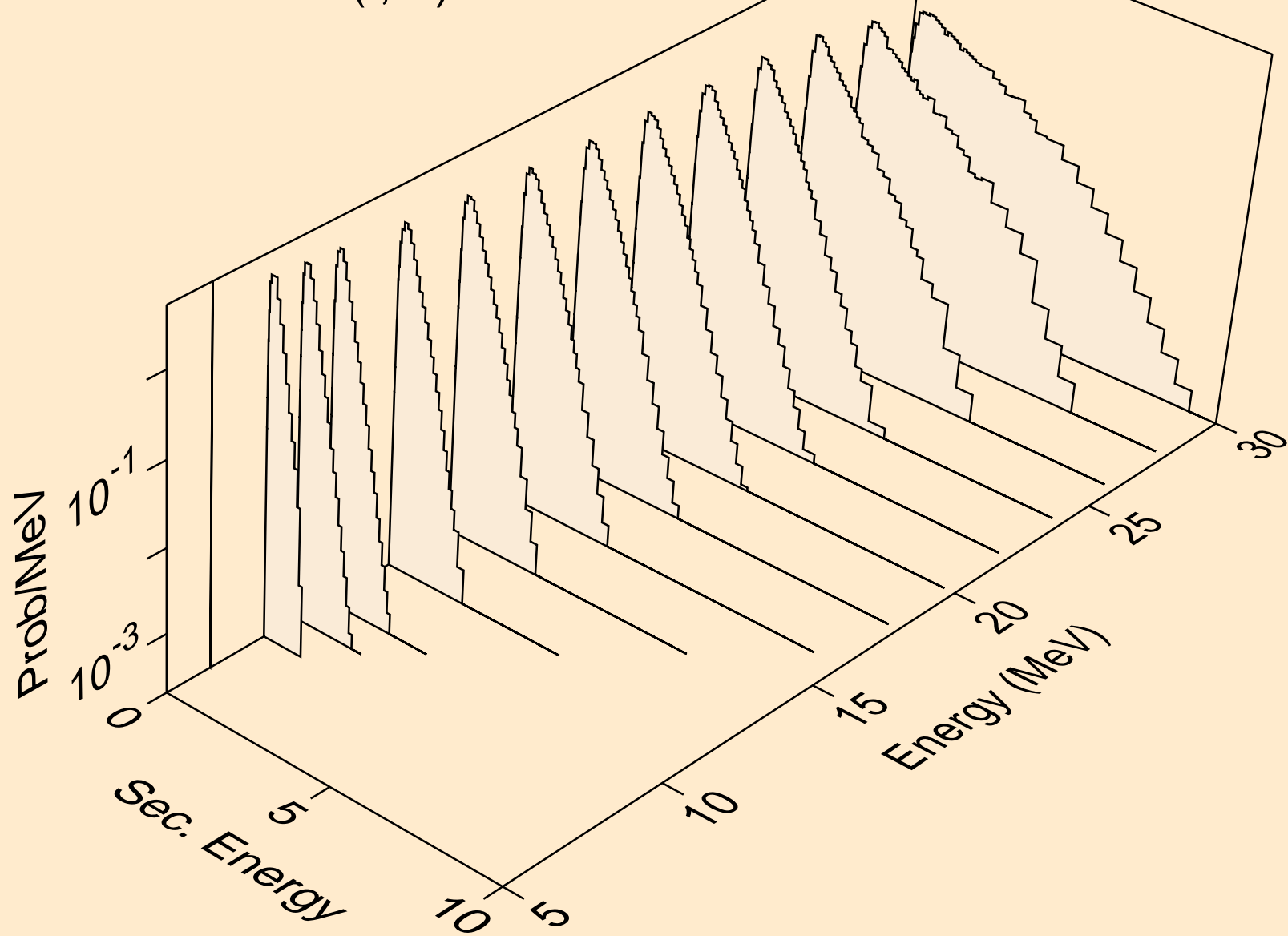

NO254 TRITON ACER TENDL-2021 LIBRARY; T=0.K  
neutrons from (t,n\*)t

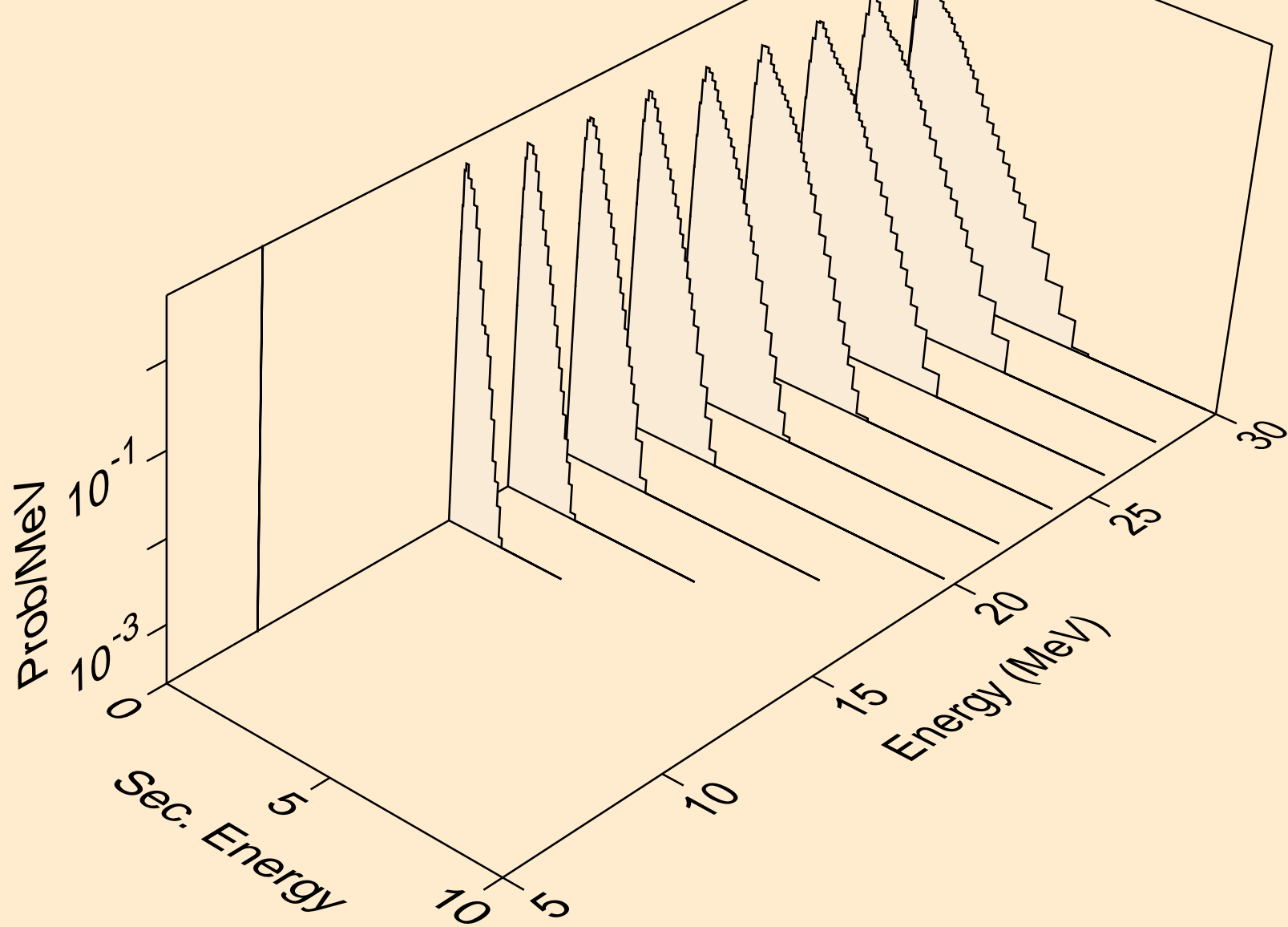

NO254 TRITON ACER TENDL-2021 LIBRARY; T=0.K  
neutrons from (t,n\*)he3

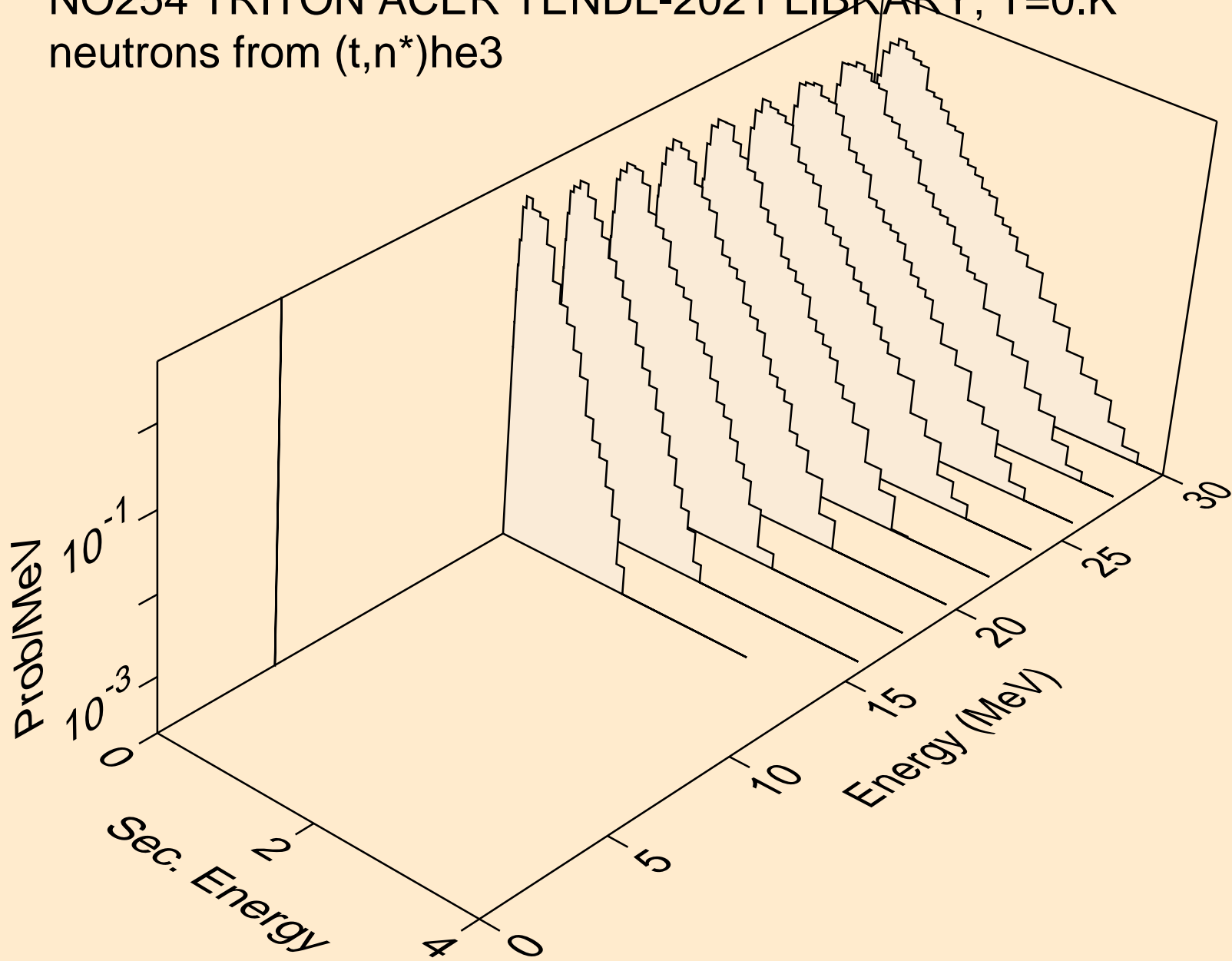

NO254 TRITON ACER TENDL-2021 LIBRARY; T=0.K  
neutrons from (t,4n)

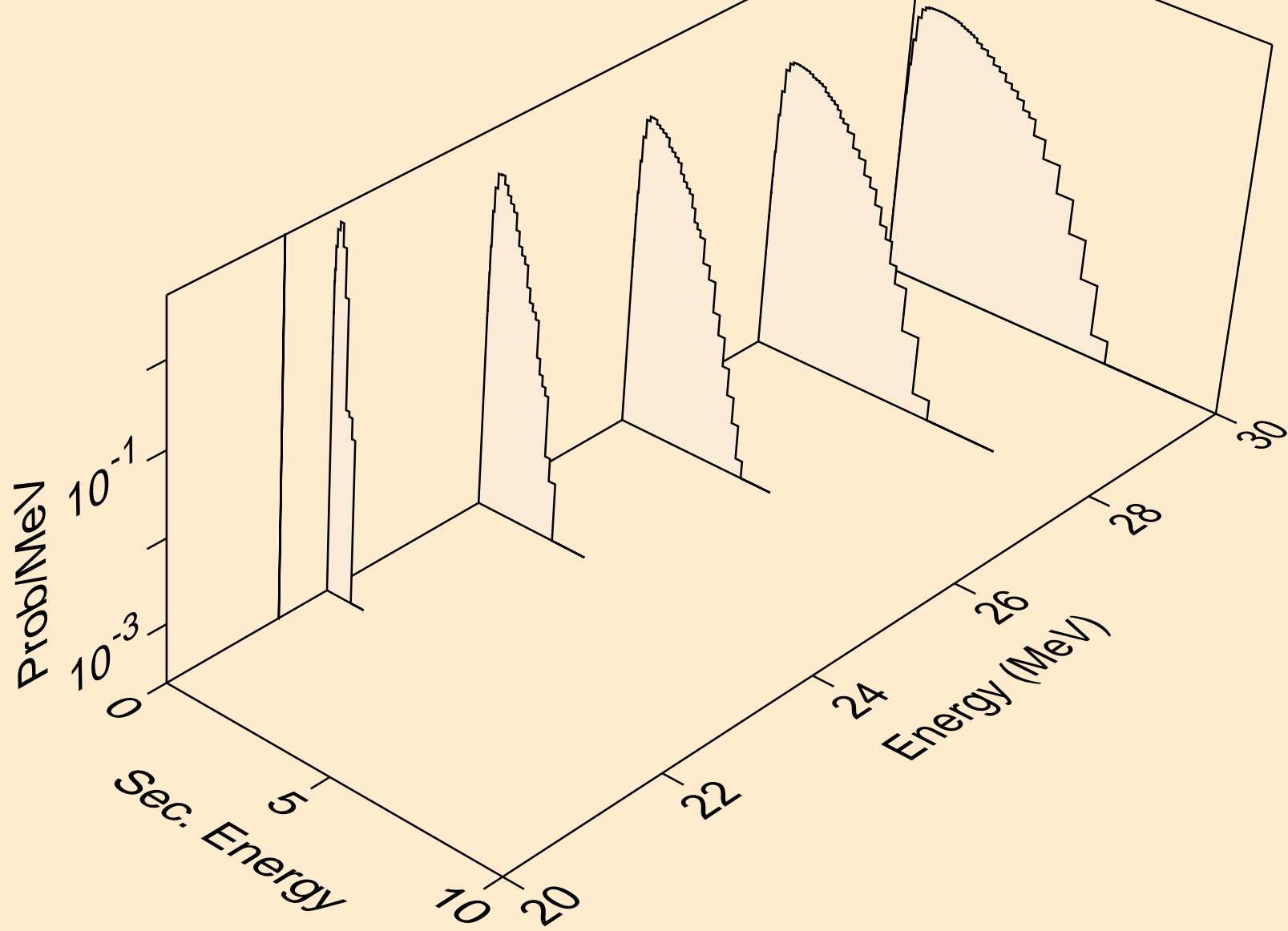

NO254 TRITON ACER TENDL-2021 LIBRARY; T=0.K  
neutrons from (t,2np)

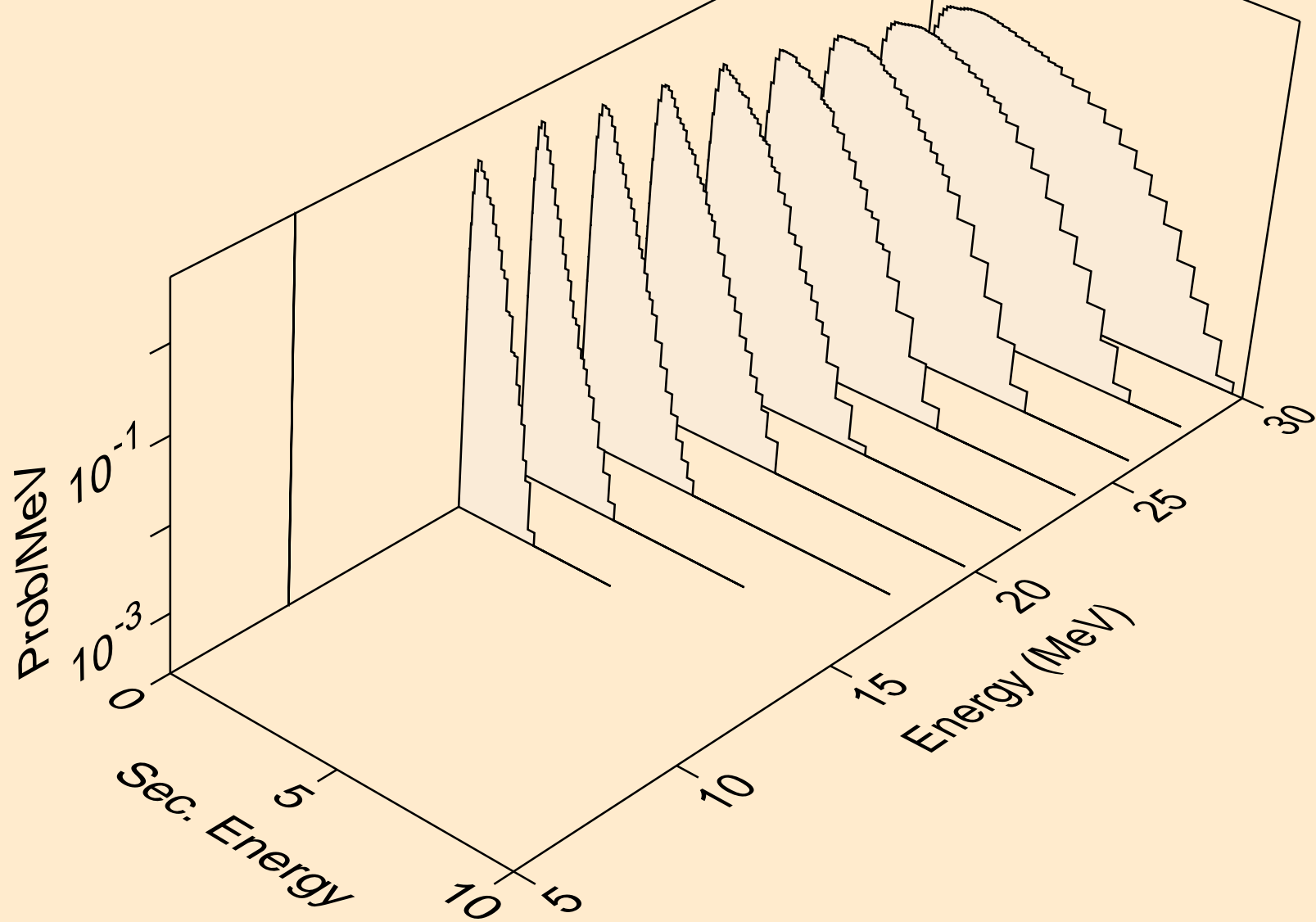

NO254 TRITON ACER TENDL-2021 LIBRARY; T=0.K  
neutrons from (t,2np)

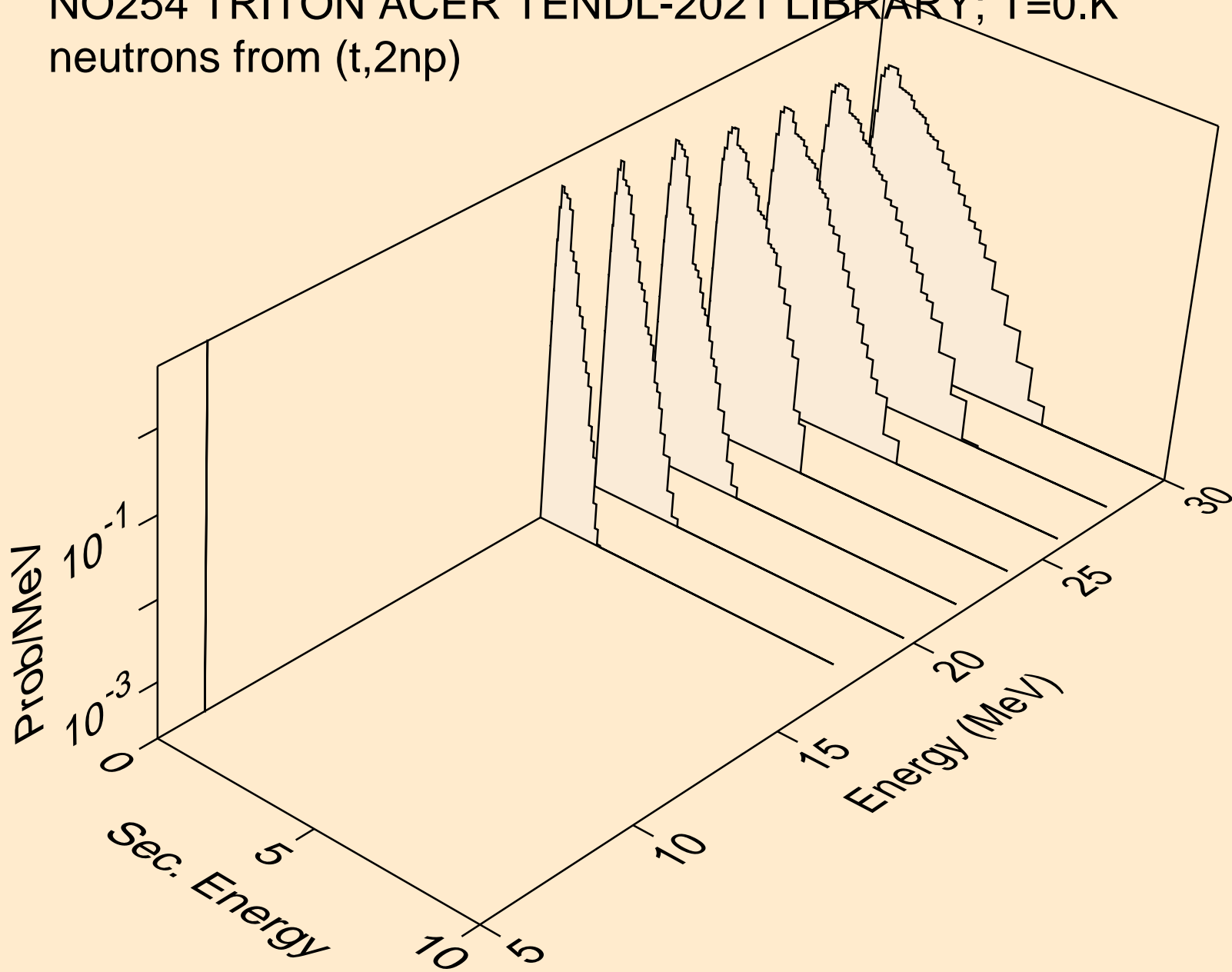

NO254 TRITON ACER TENDL-2021 LIBRARY; T=0.K  
neutrons from (t,npa)

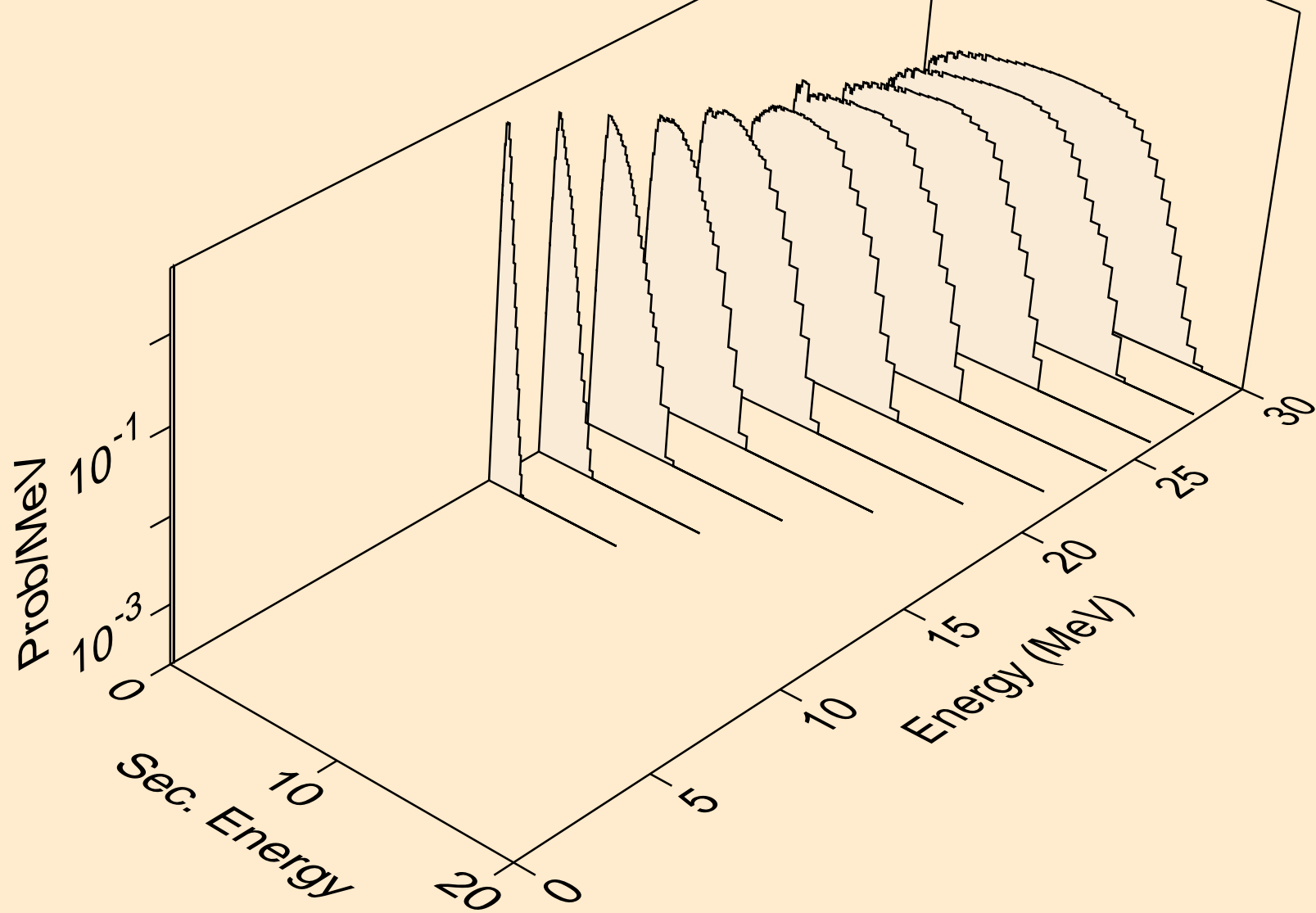



NO254 TRITON ACER TENDL-2021 LIBRARY; T=0.K  
protons from (t,x)

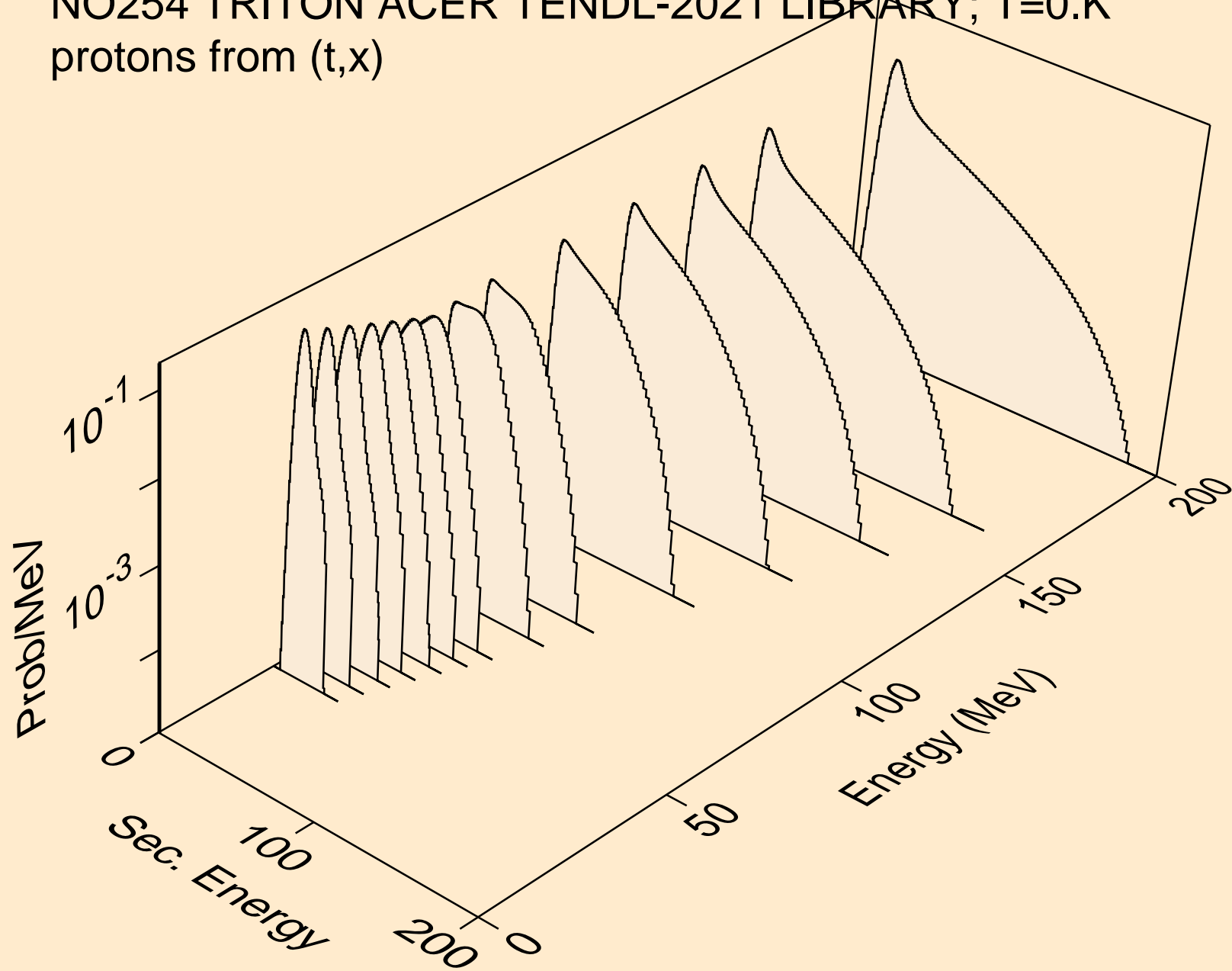

NO254 TRITON ACER TENDL-2021 LIBRARY; T=0.K  
protons from (t,n\*)p

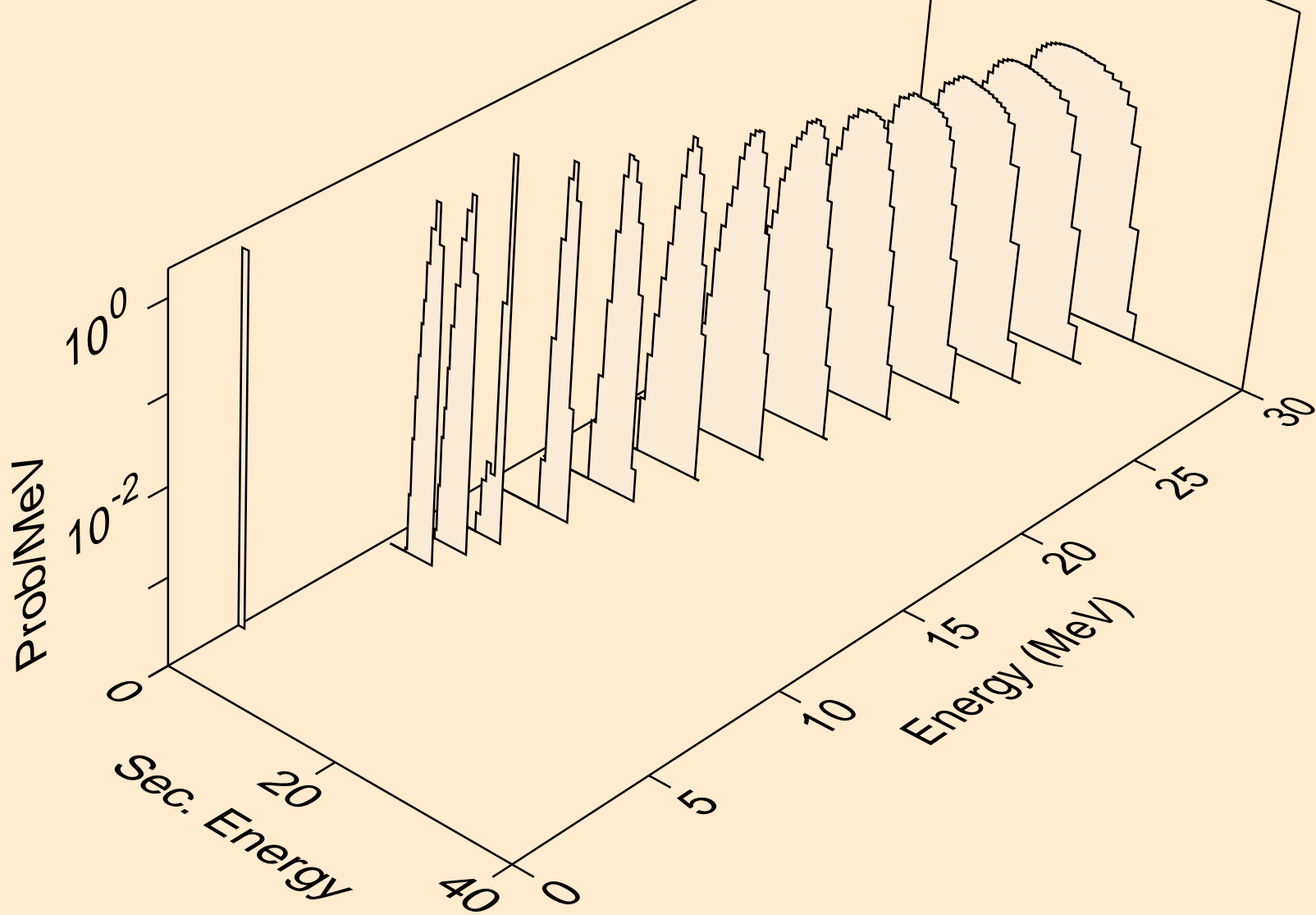

NO254 TRITON ACER TENDL-2021 LIBRARY; T=0.K  
protons from (t,2np)

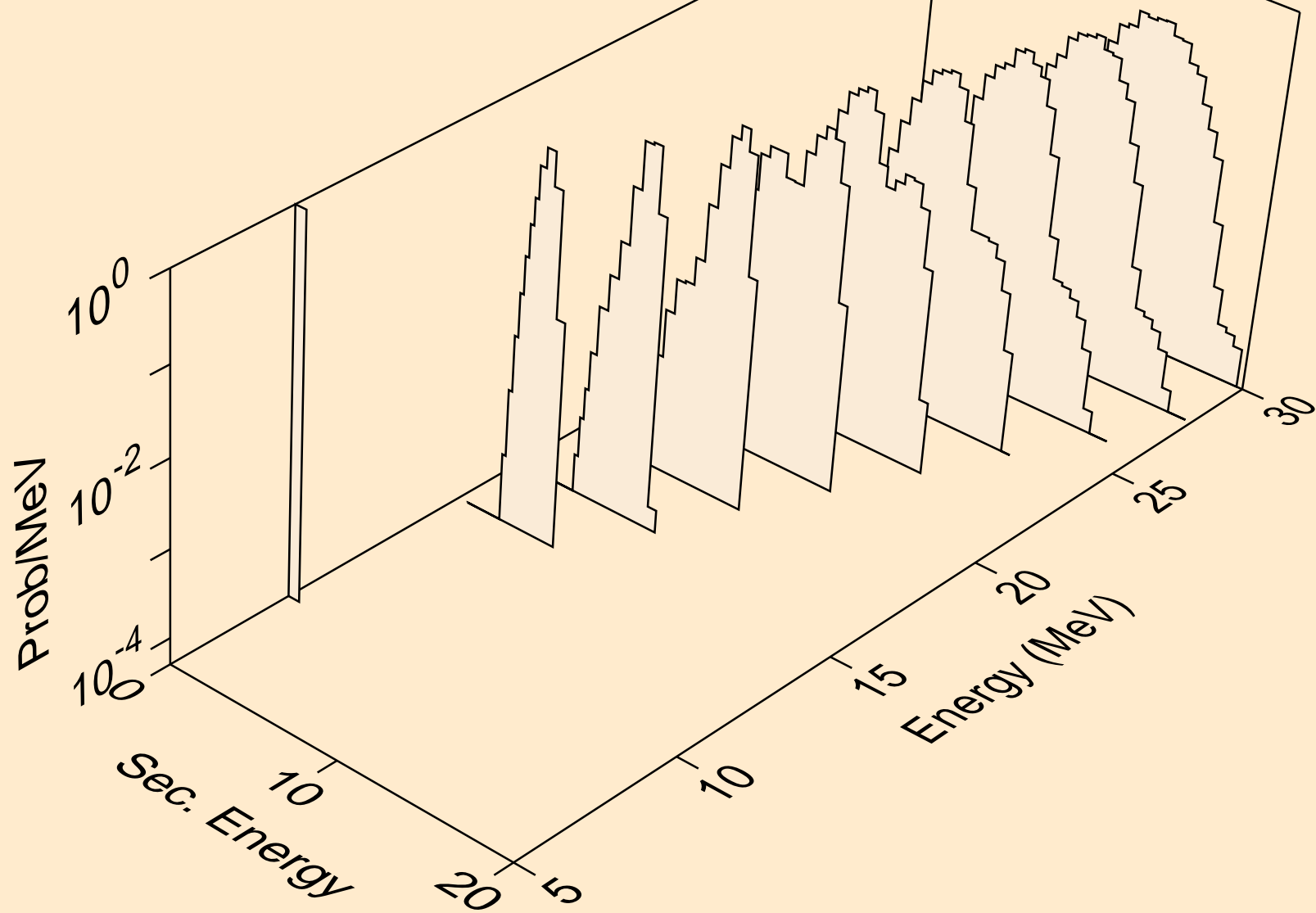

NO254 TRITON ACER TENDL-2021 LIBRARY; T=0.K  
protons from (t,2np)

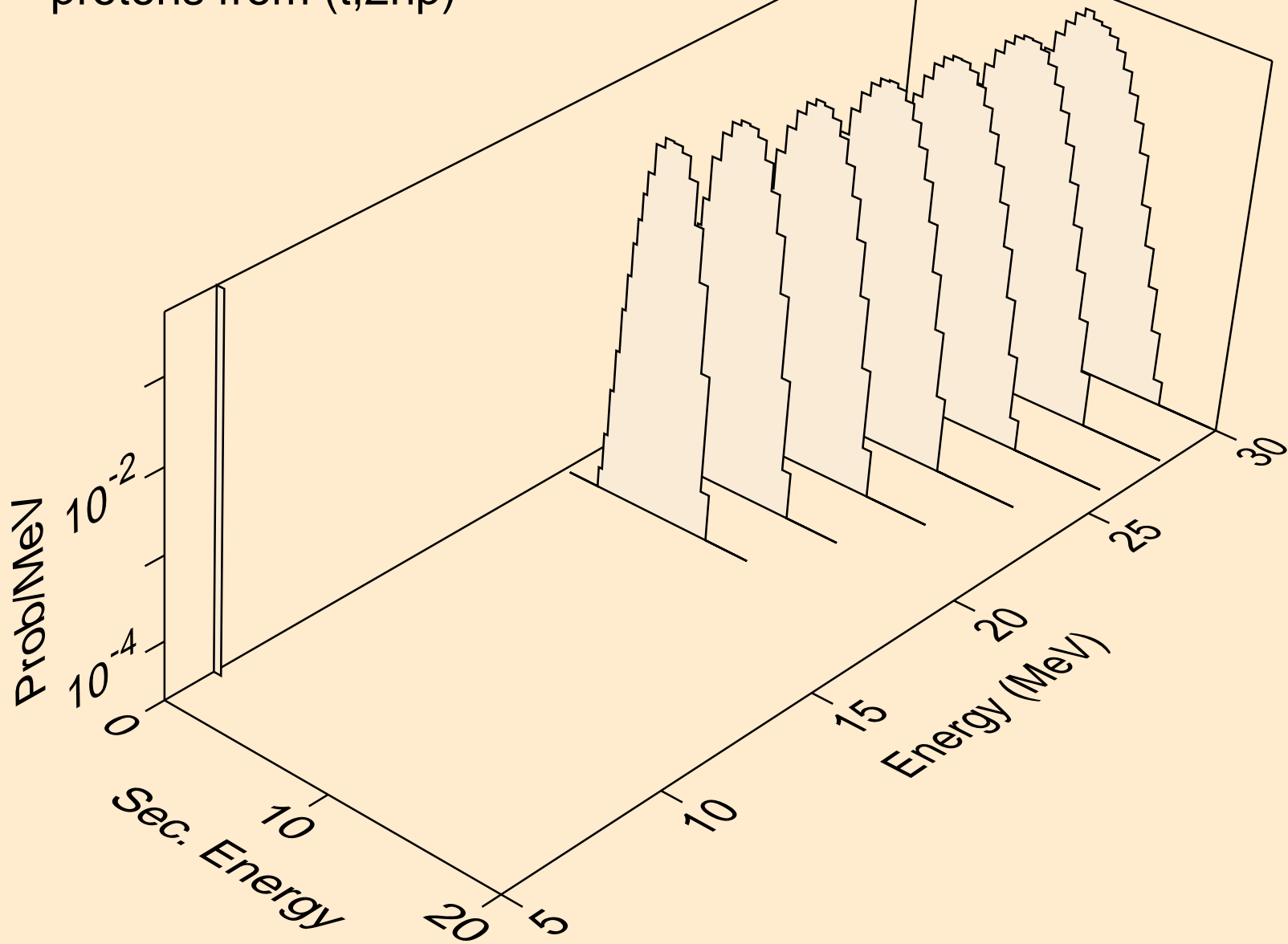

NO254 TRITON ACER TENDL-2021 LIBRARY; T=0.K  
protons from (t,npa)

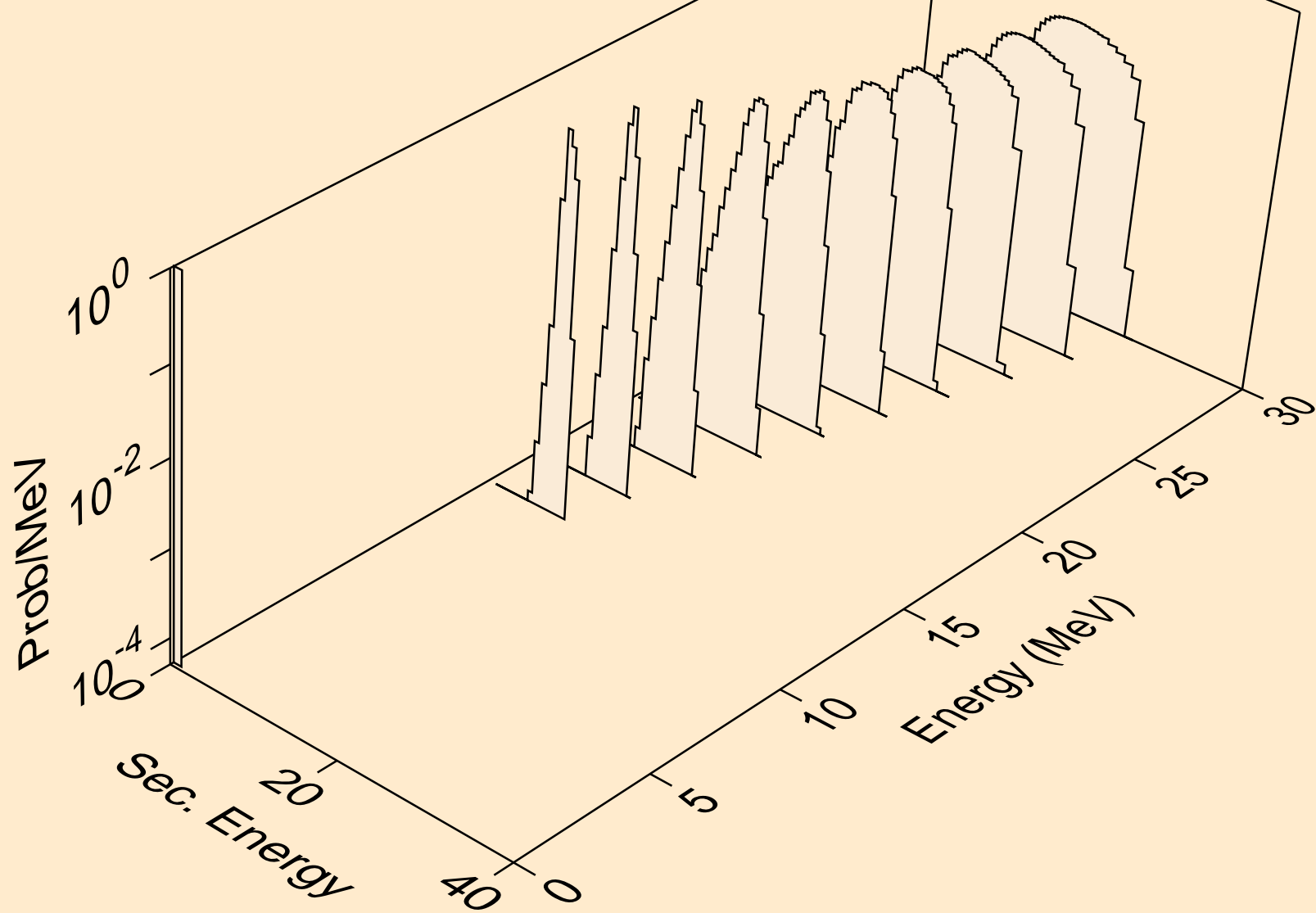

NO254 TRITON ACER TENDL-2021 LIBRARY; T=0.K  
protons from (t,p)

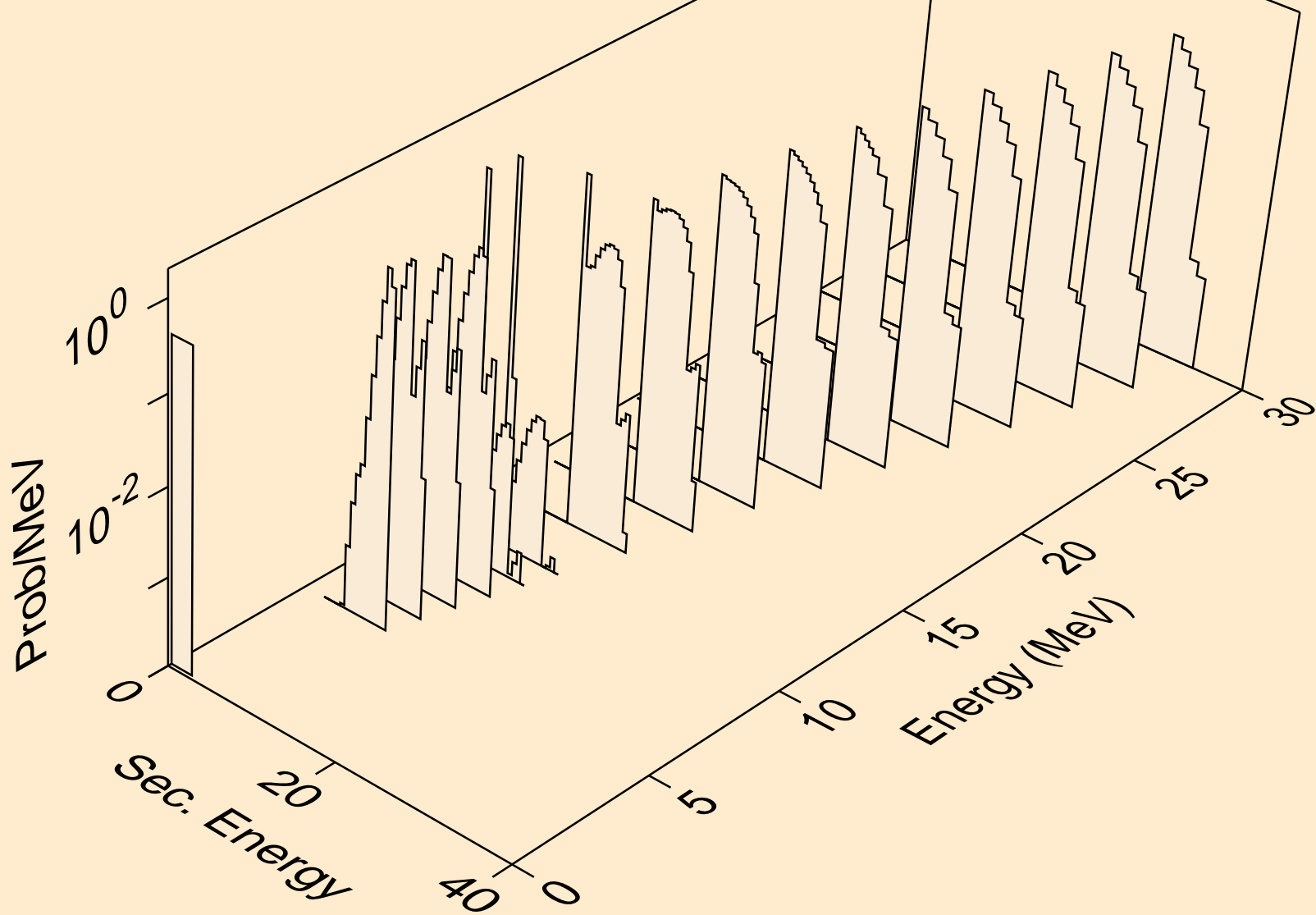

NO254 TRITON ACER TENDL-2021 LIBRARY; T=0.K  
protons from (t,2p)

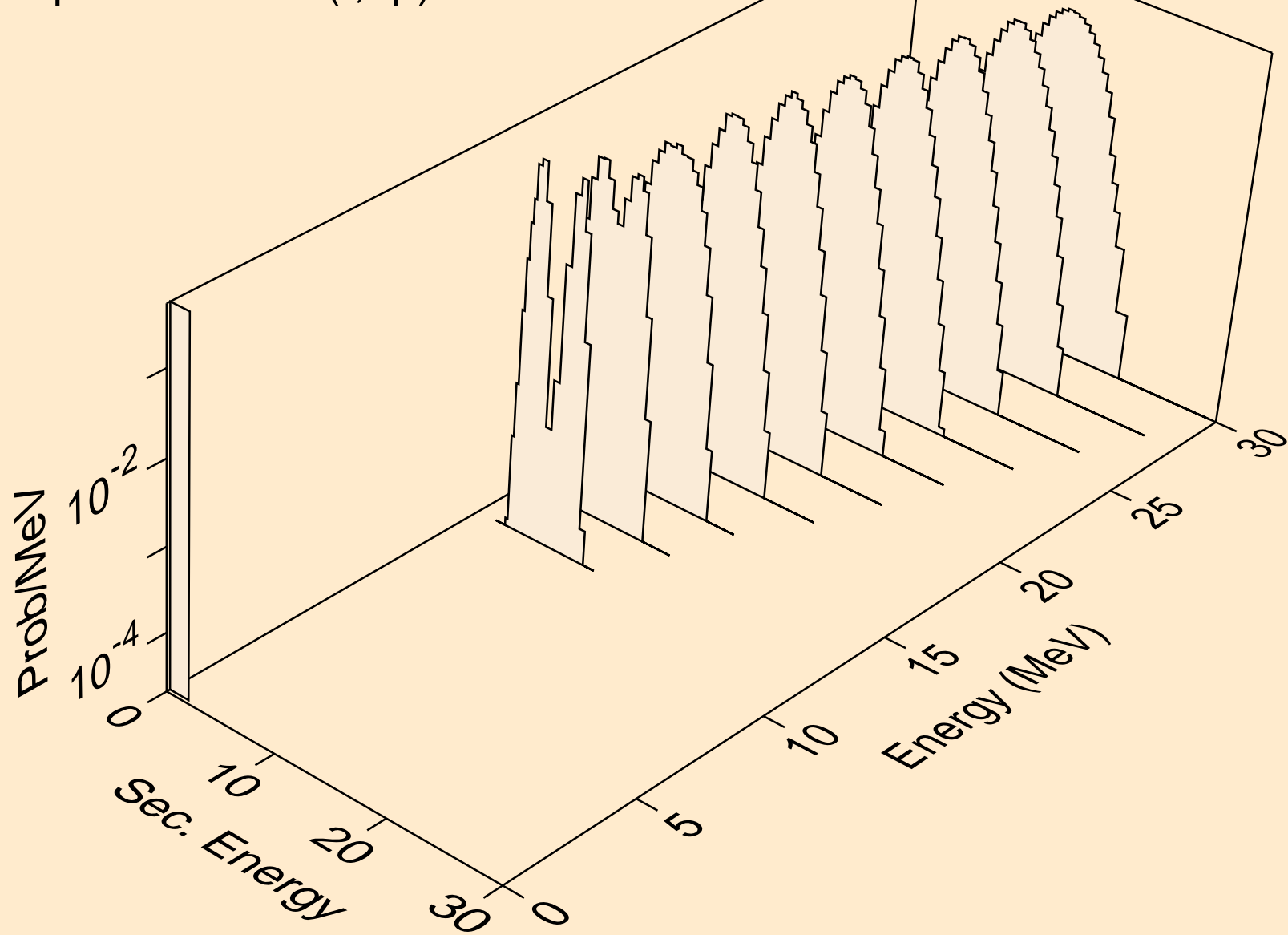

NO254 TRITON ACER TENDL-2021 LIBRARY; T=0.K  
protons from (t,pd)

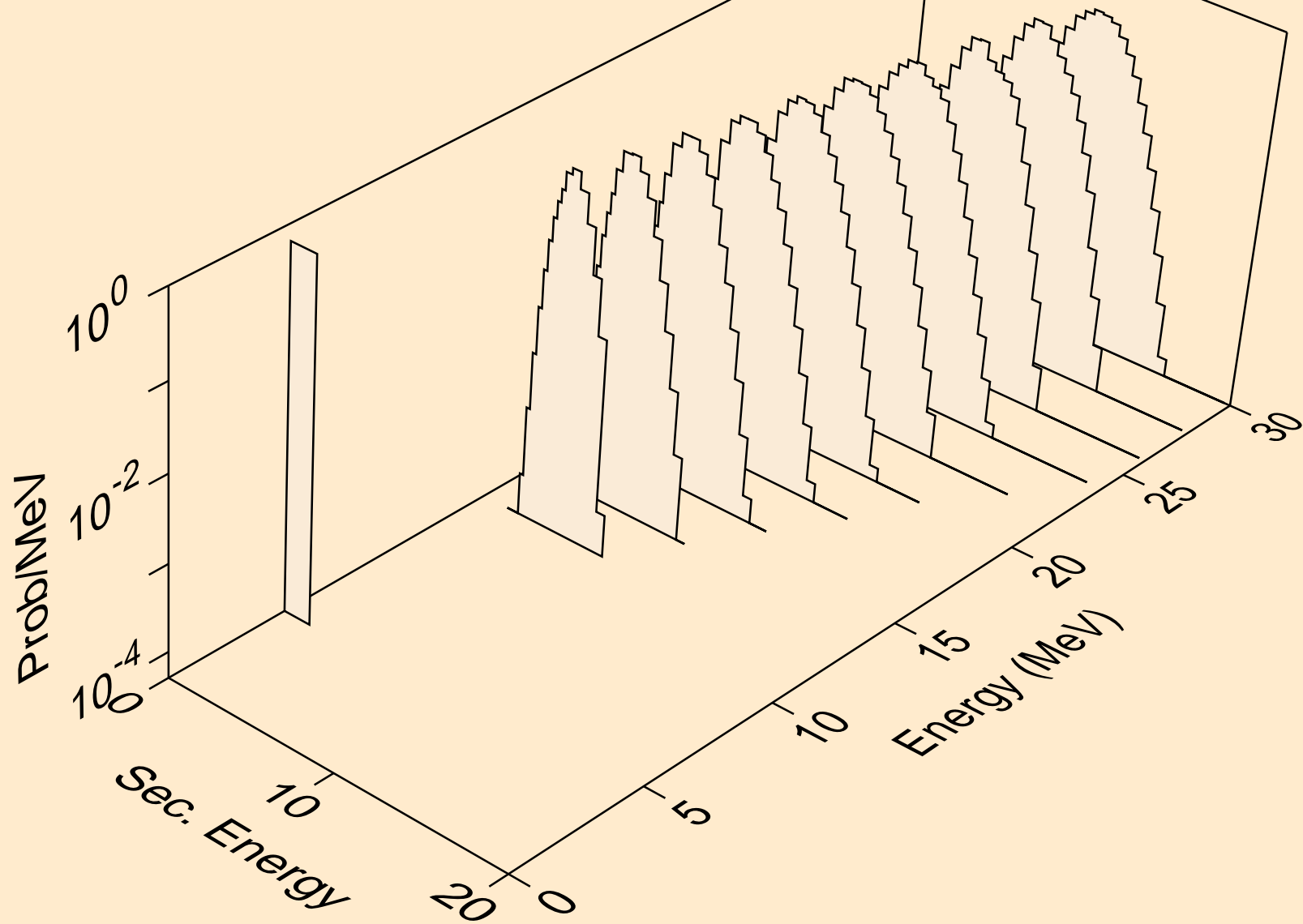



NO254 TRITON ACER TENDL-2021 LIBRARY; T=0.K  
deuterons from (t,x)

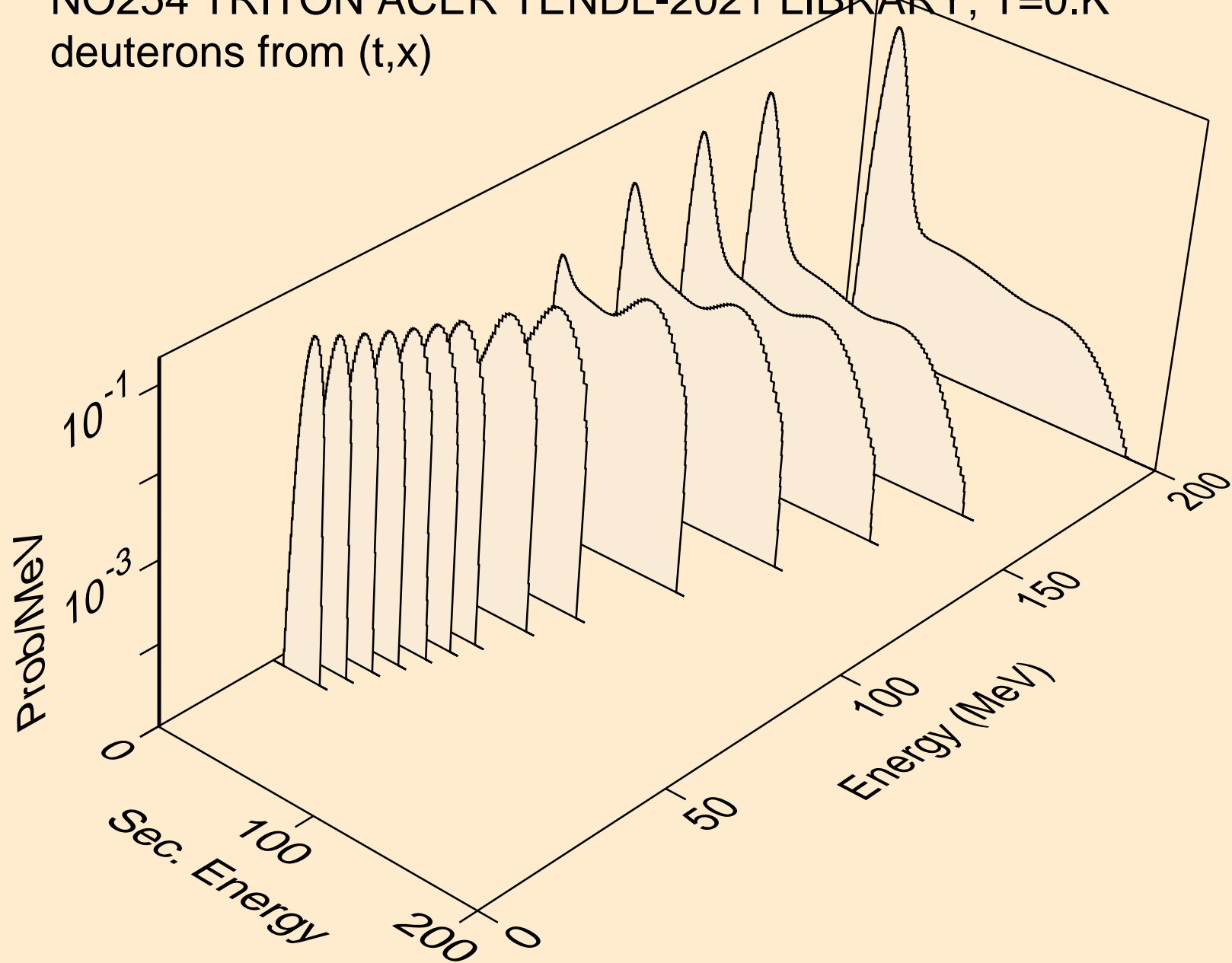

NO254 TRITON ACER TENDL-2021 LIBRARY; T=0.K  
deuterons from (t,n\*)d

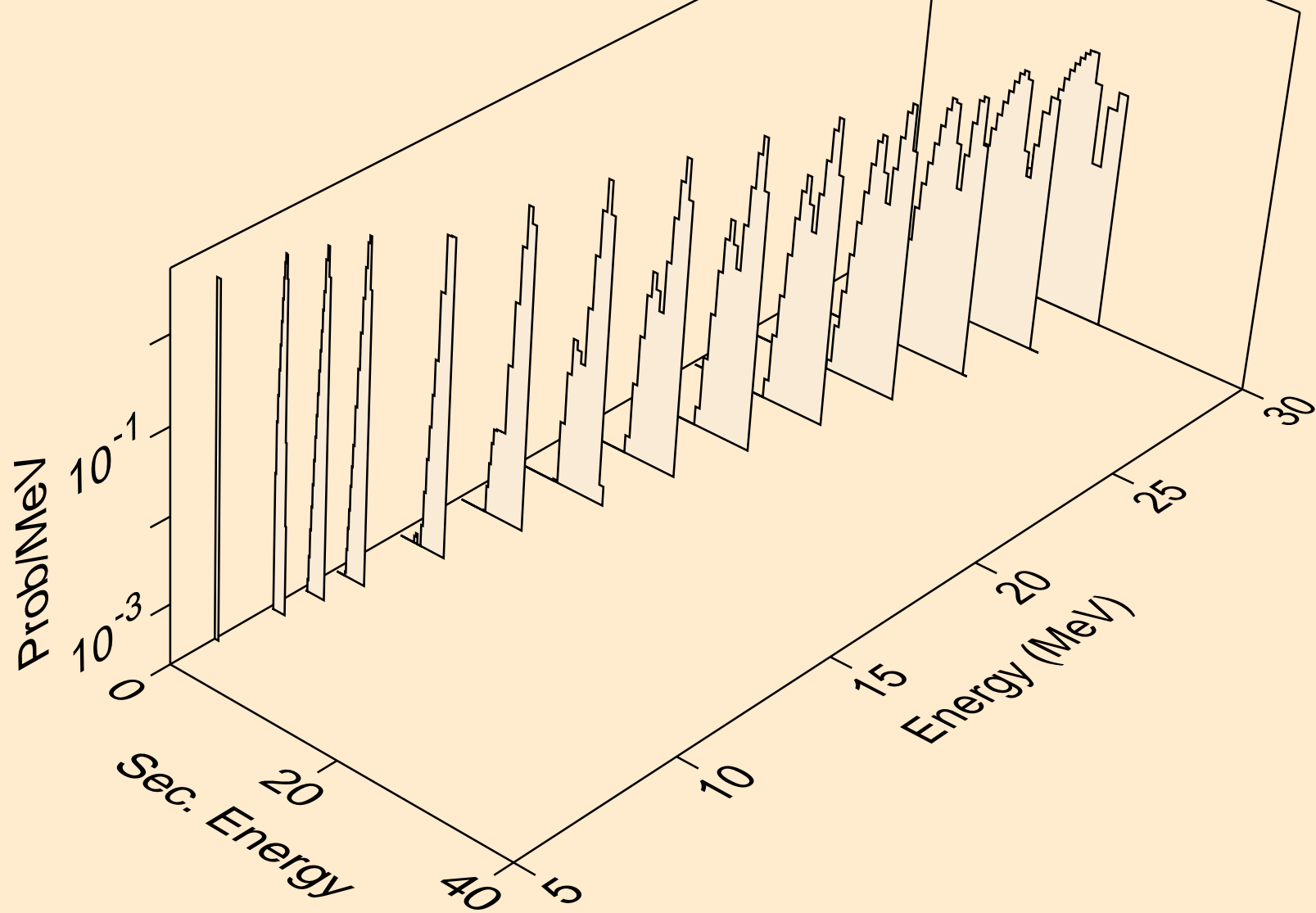

NO254 TRITON ACER TENDL-2021 LIBRARY; T=0.K  
deuterons from (t,d)

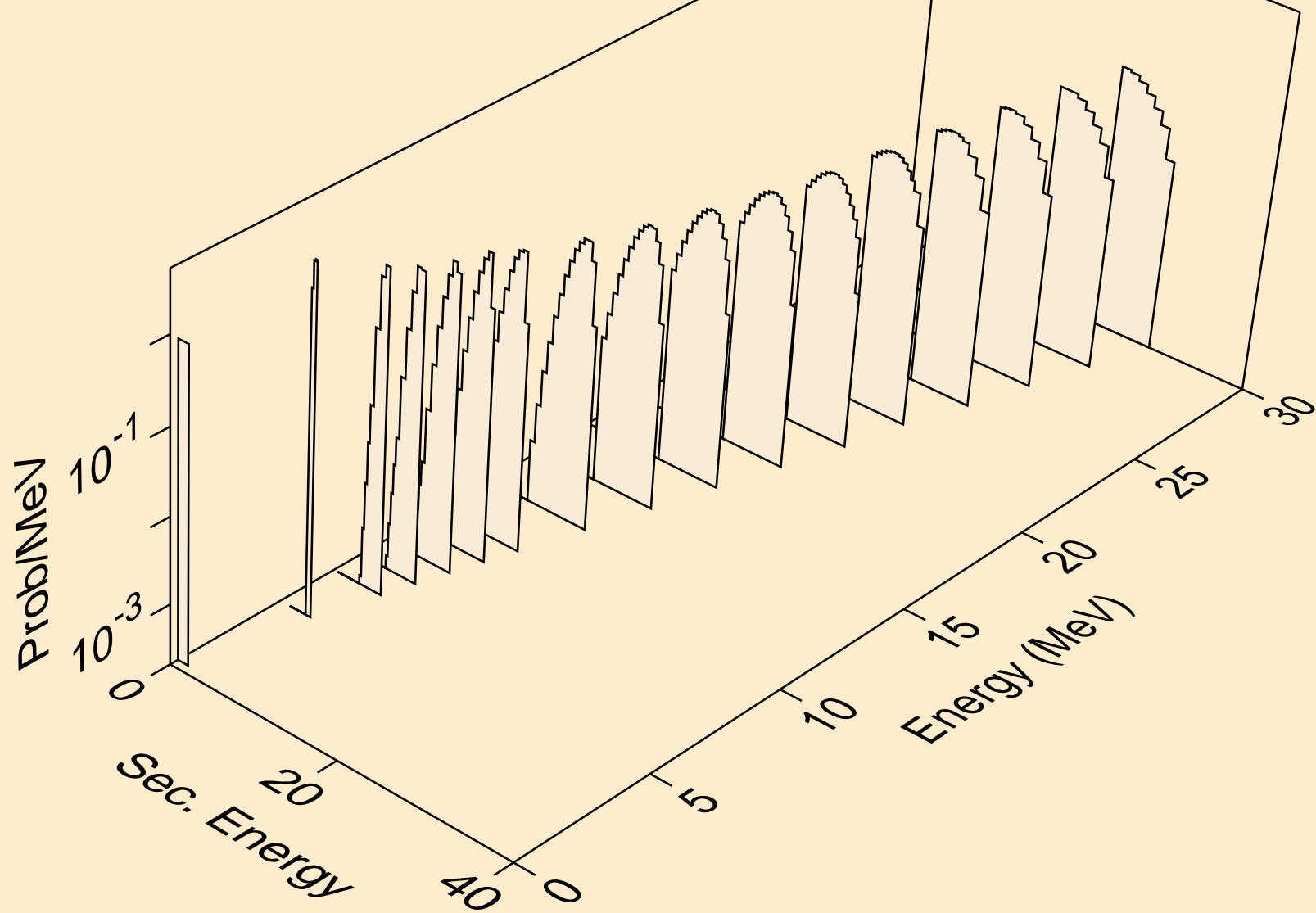

NO254 TRITON ACER TENDL-2021 LIBRARY; T=0.K  
deuterons from (t,pd)

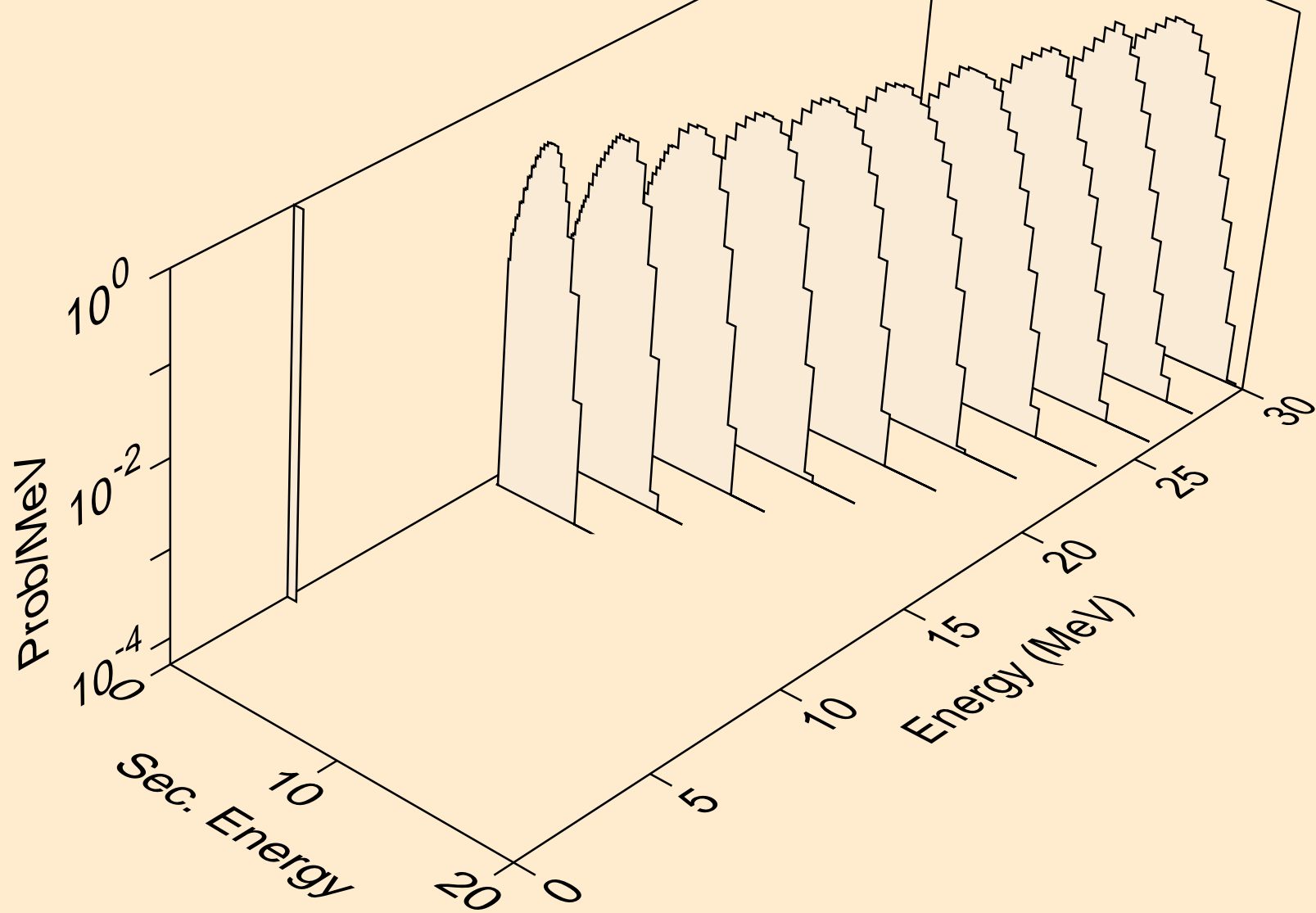

NO254 TRITON ACER TENDL-2021 LIBRARY; T=0.K  
deuterons from (t,da)

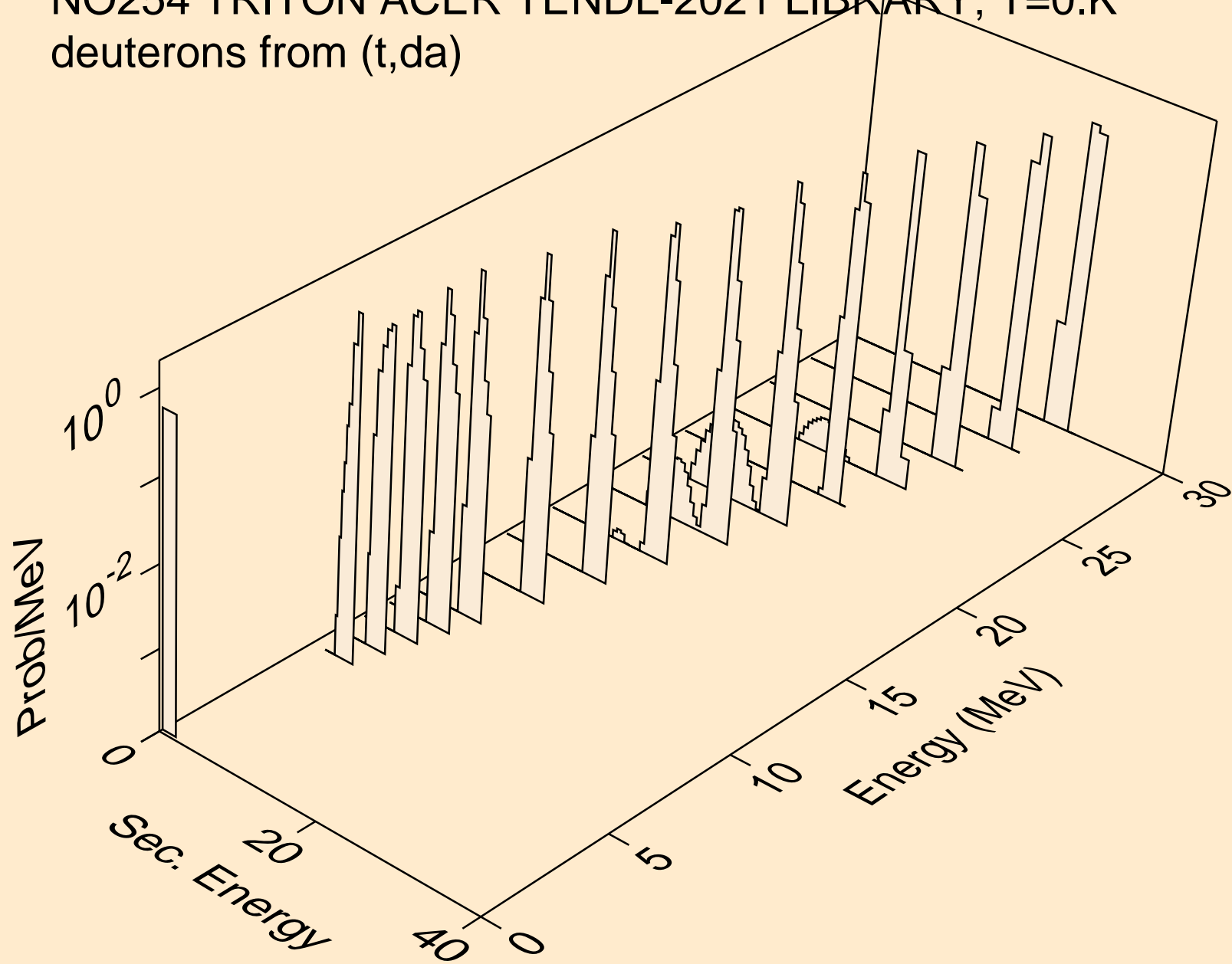

NO254 TRITON ACER TENDL-2021 LIBRARY; T=0.K  
he3s from (t,x)

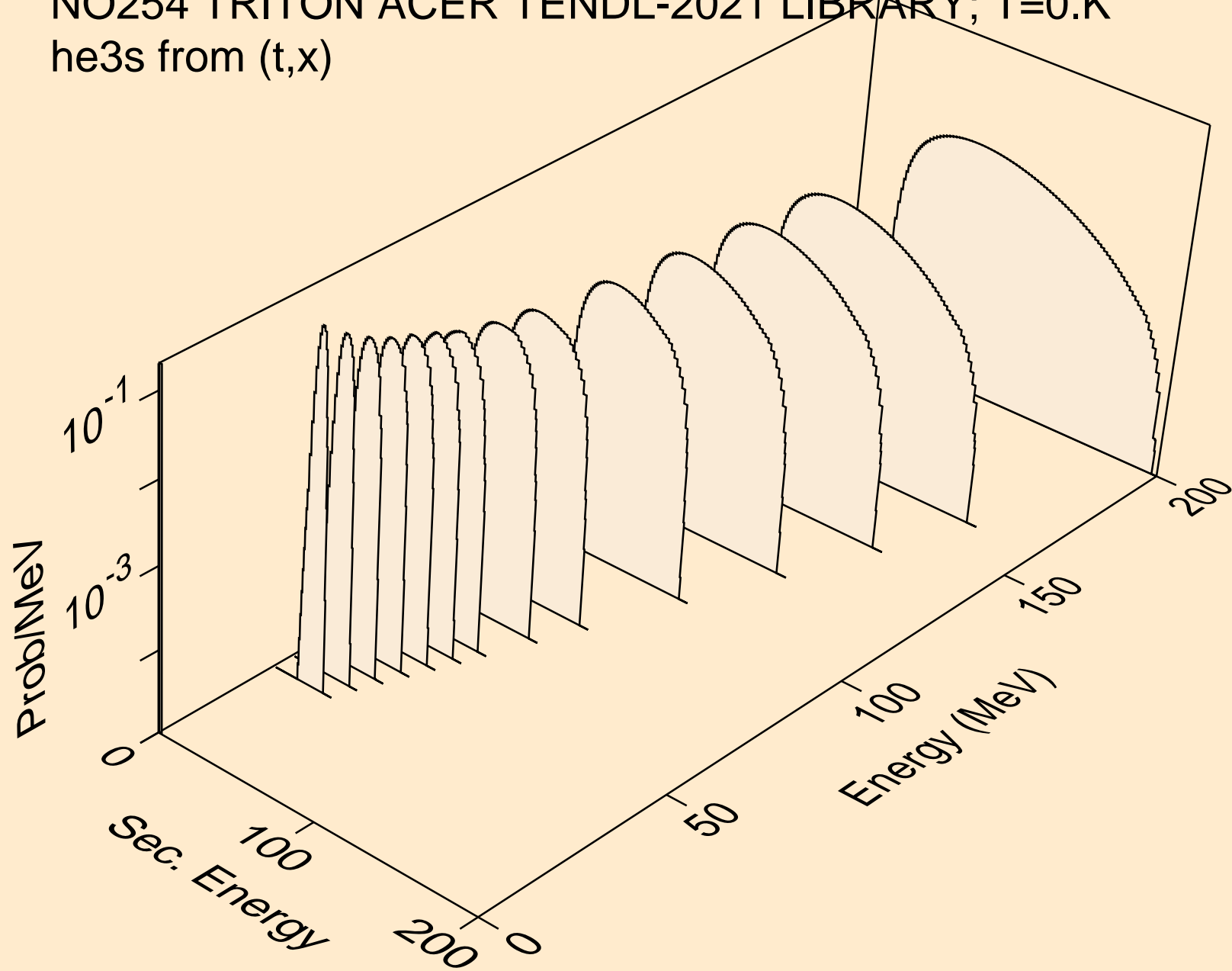

NO254 TRITON ACER TENDL-2021 LIBRARY; T=0.K  
he3s from (t,n\*)he3

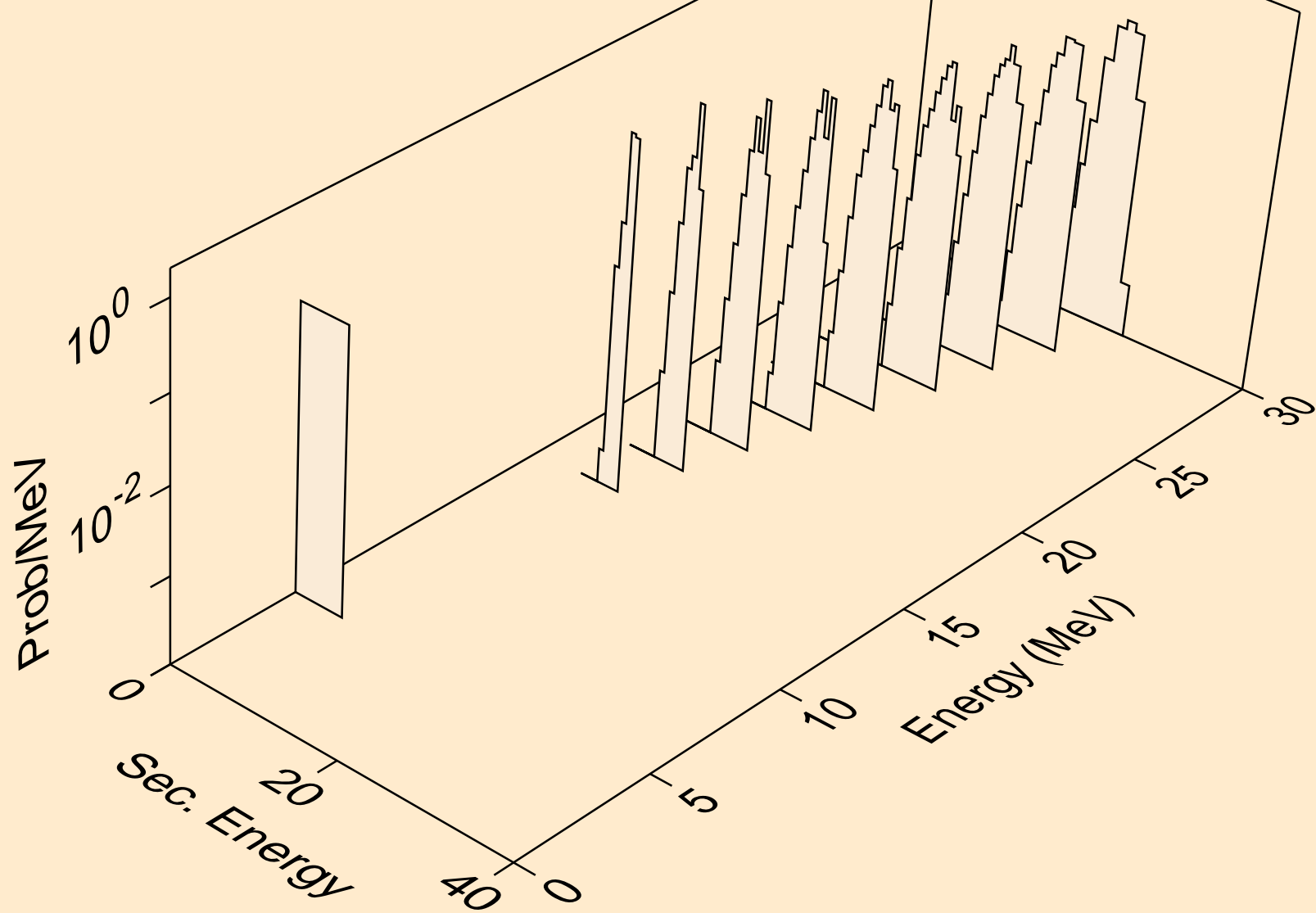

NO254 TRITON ACER TENDL-2021 LIBRARY; T=0.K  
he3s from (t,he3)

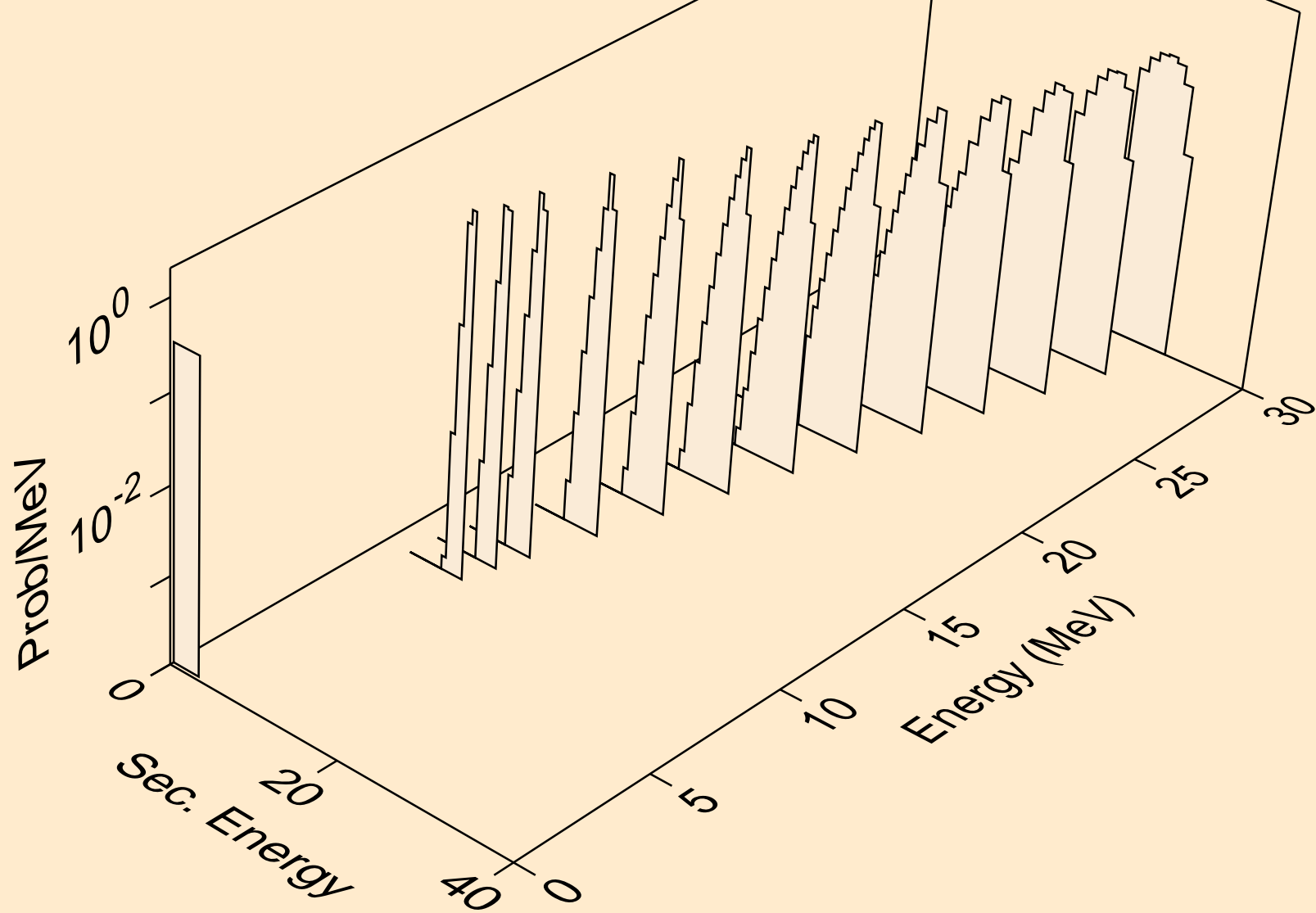



NO254 TRITON ACER TENDL-2021 LIBRARY; T=0.K  
alphas from (t,x)

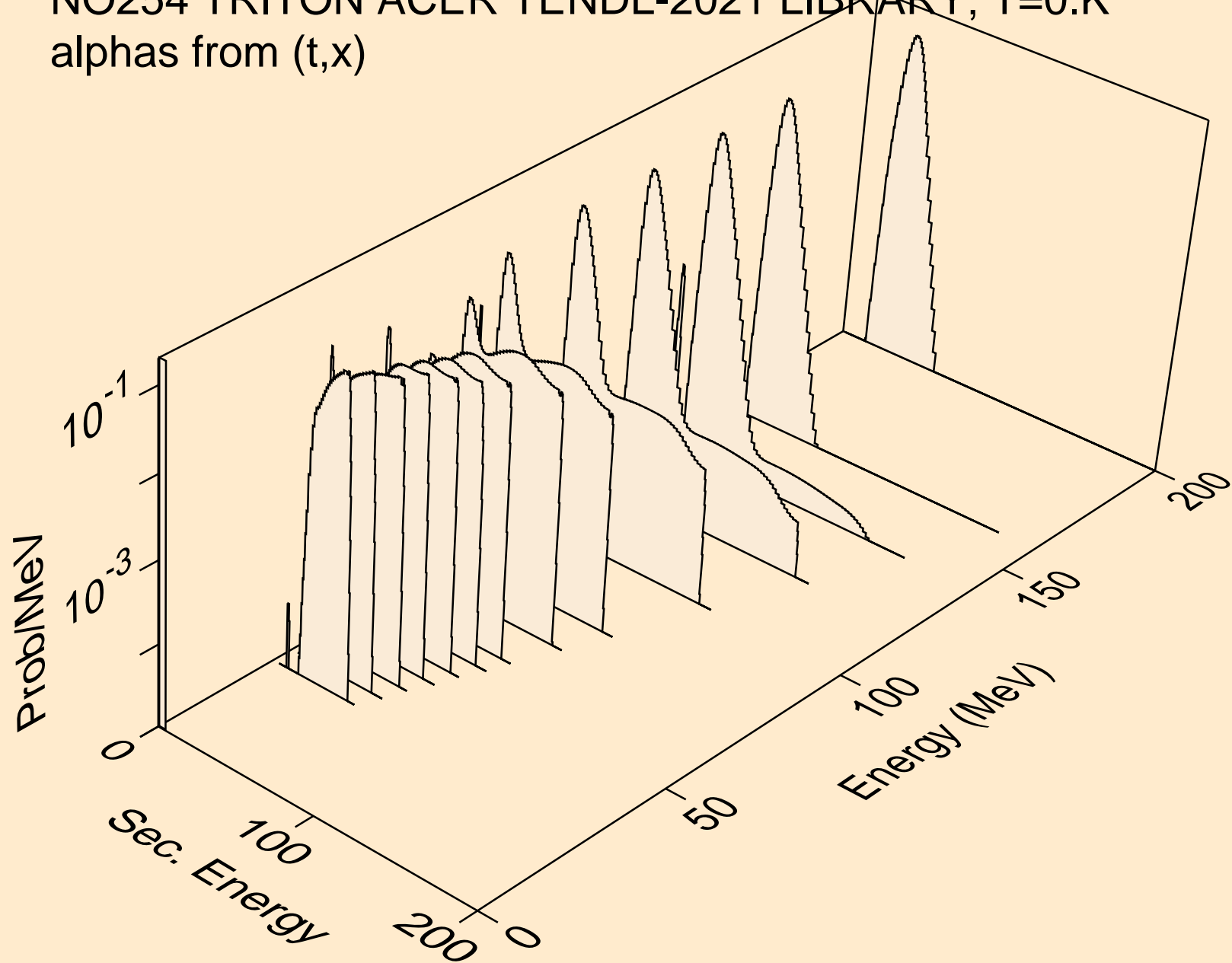

NO254 TRITON ACER TENDL-2021 LIBRARY; T=0.K  
alphas from (t,n\*)a

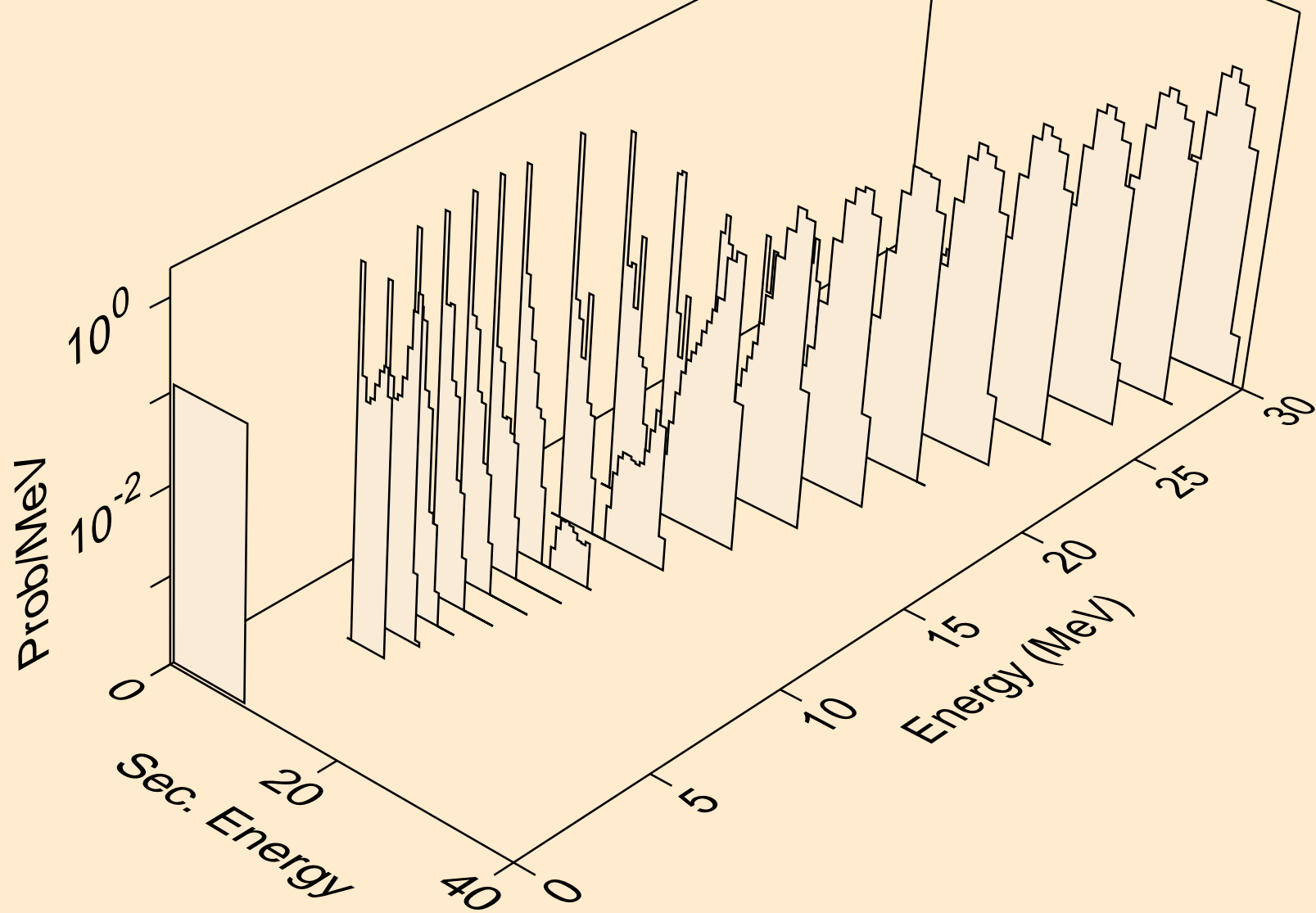

NO254 TRITON ACER TENDL-2021 LIBRARY; T=0.K  
alphas from (t,2n)a

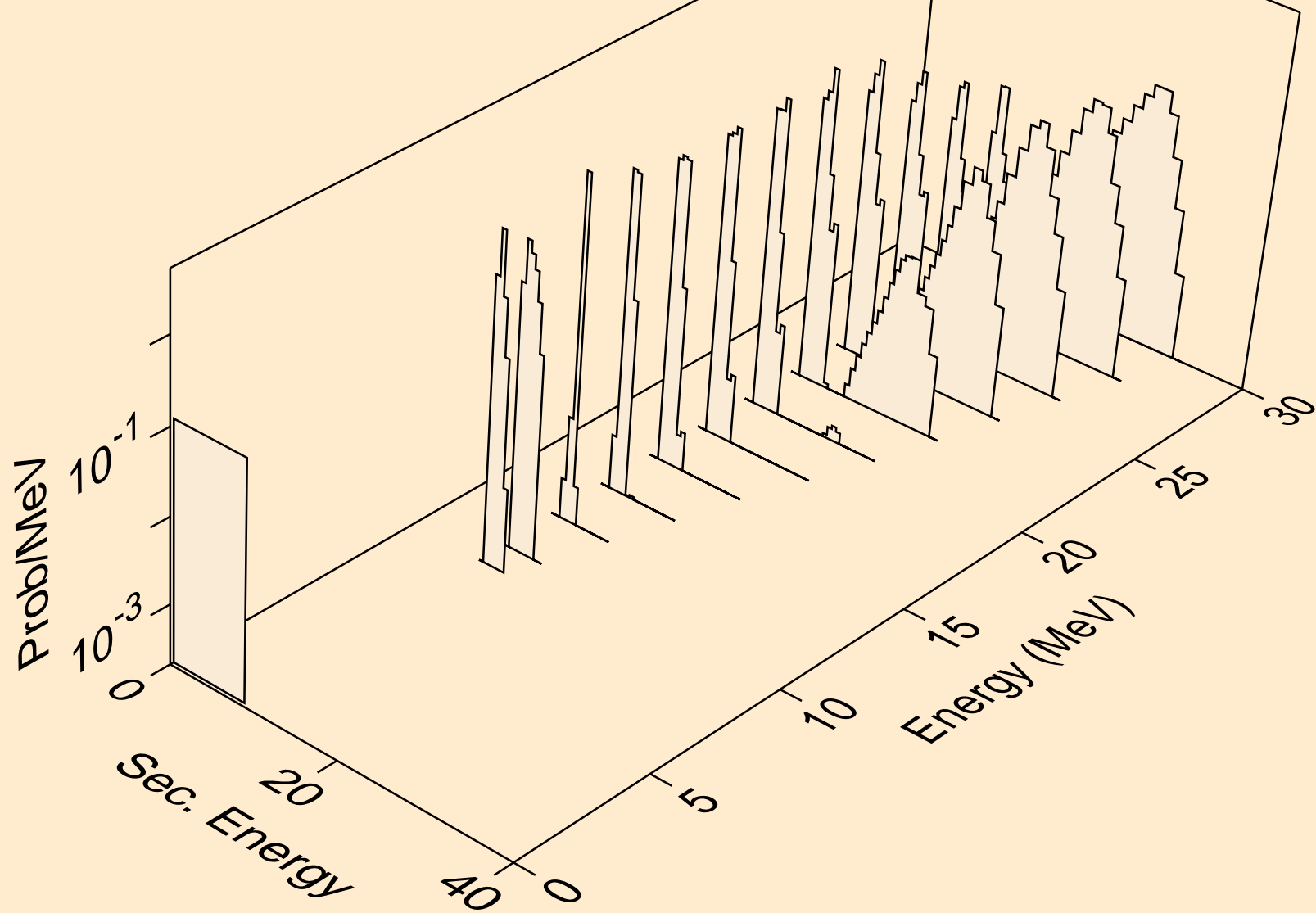

NO254 TRITON ACER TENDL-2021 LIBRARY; T=0.K  
alphas from (t,npa)

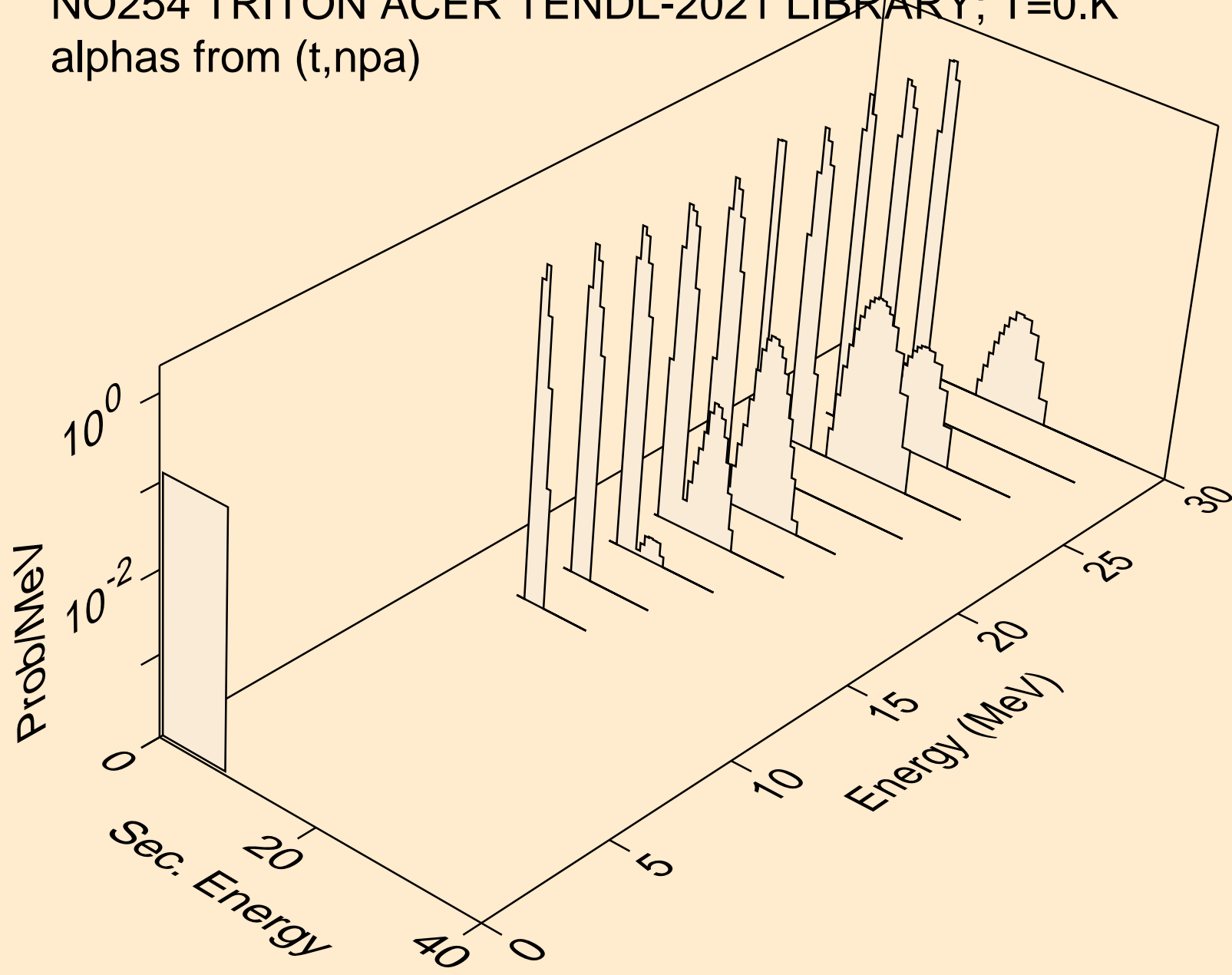

NO254 TRITON ACER TENDL-2021 LIBRARY; T=0.K  
alphas from (t,a)

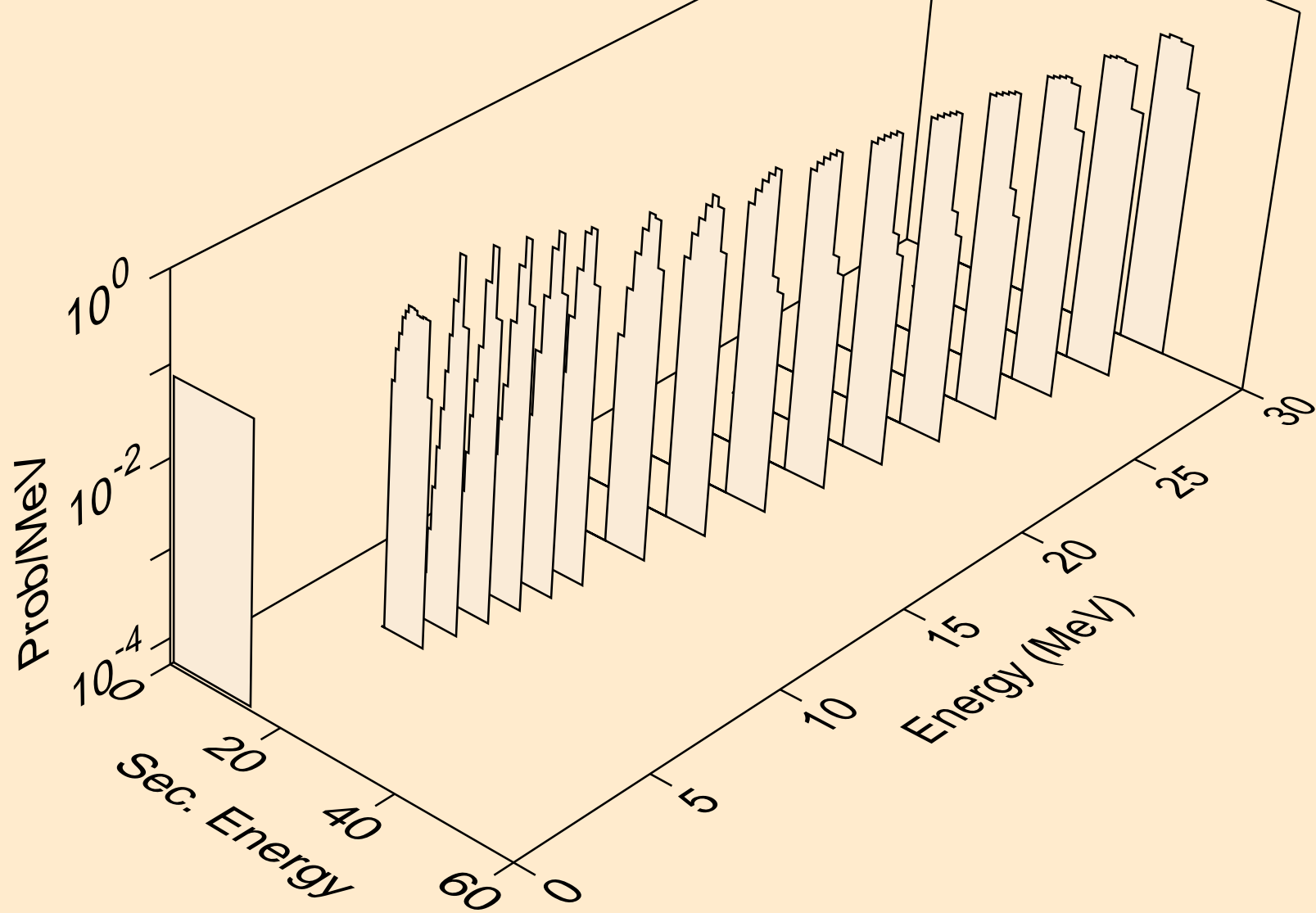

NO254 TRITON ACER TENDL-2021 LIBRARY; T=0.K  
alphas from (t,2a)

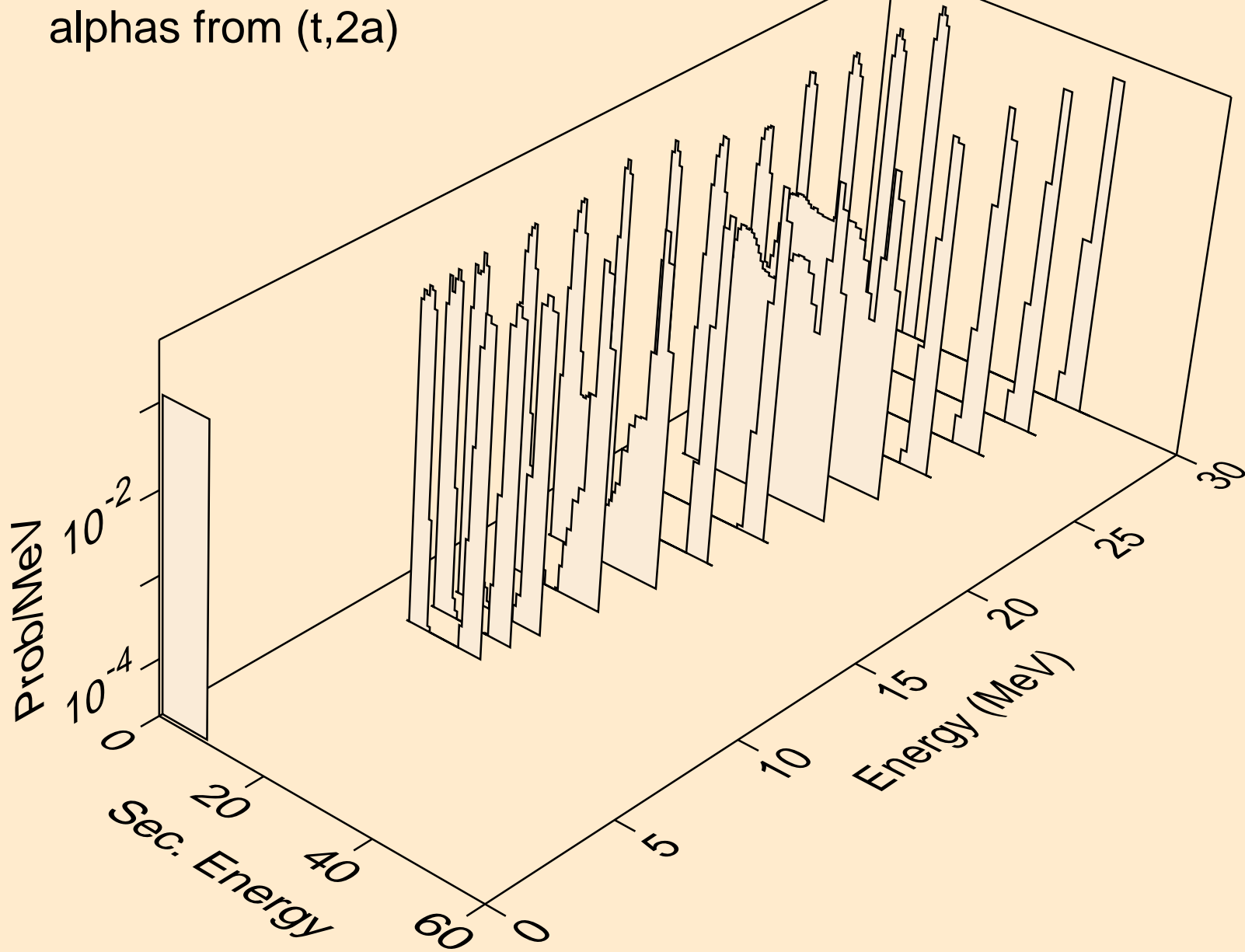

NO254 TRITON ACER TENDL-2021 LIBRARY; T=0.K  
alphas from (t,da)

