

PA232 TRITON ACER TENDL-2021 LIBRARY; T=0.K  
Principal cross sections

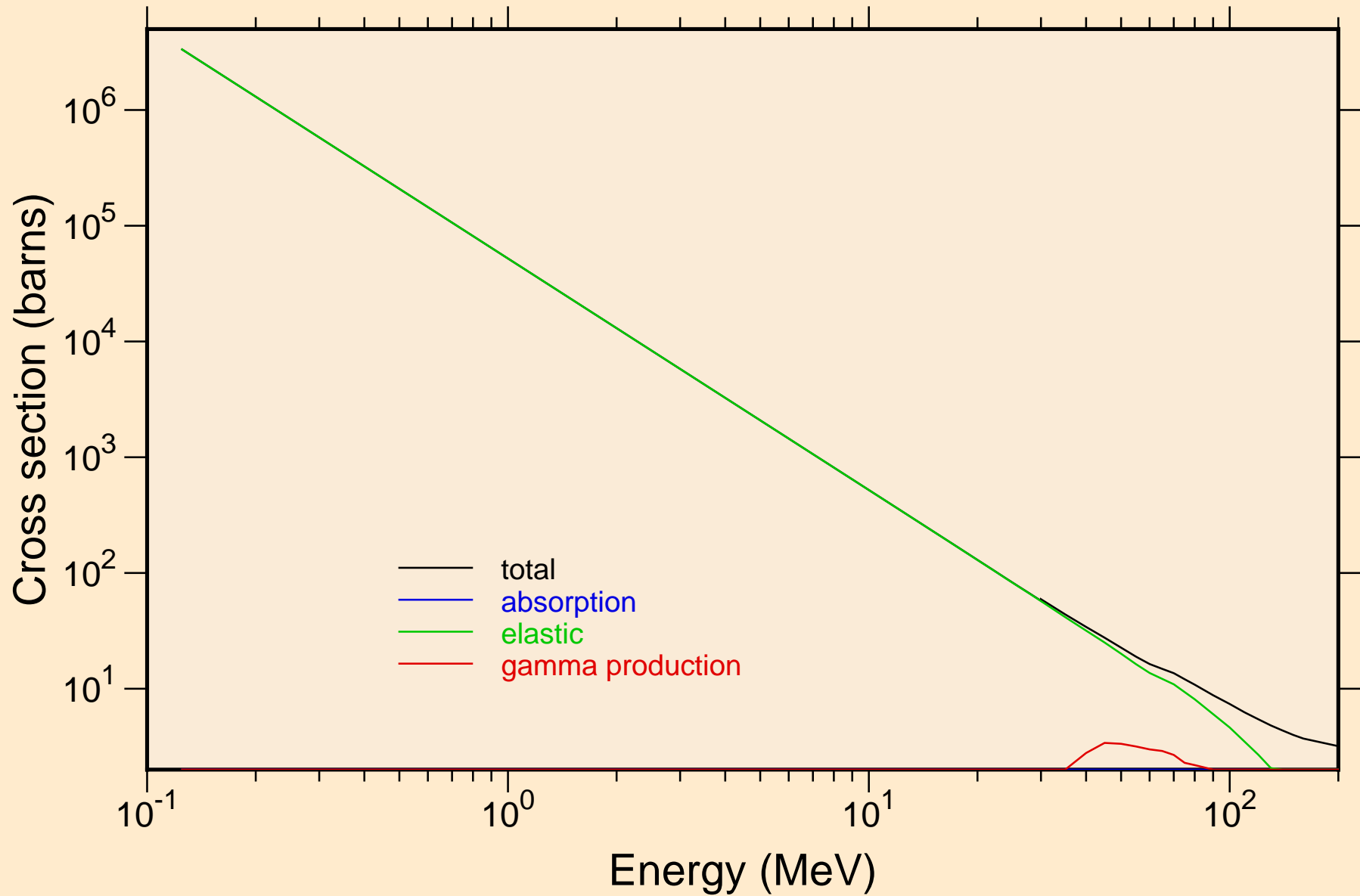

PA232 TRITON ACER TENDL-2021 LIBRARY; T=0.K

Heating

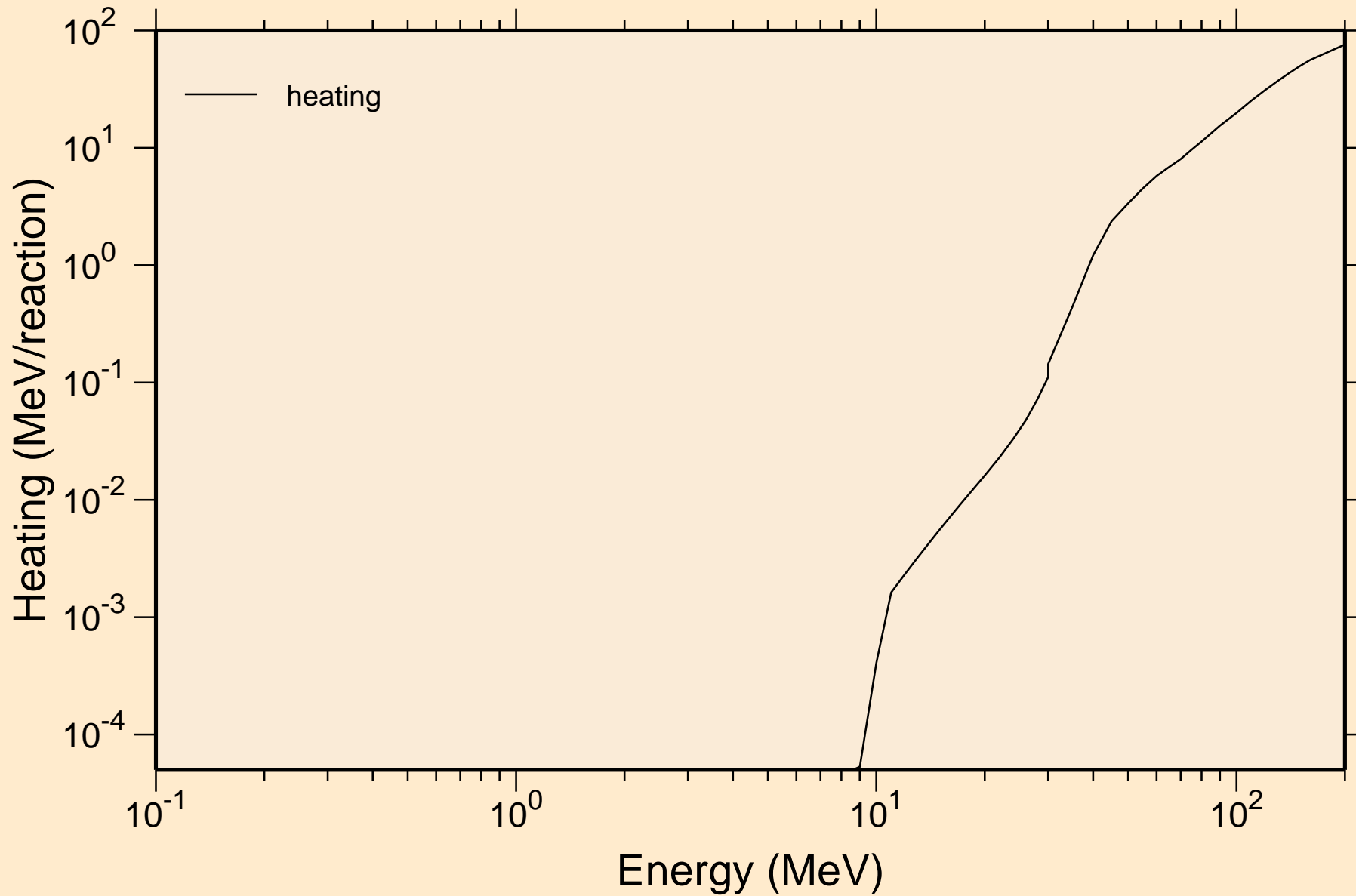

PA232 TRITON ACER TENDL-2021 LIBRARY; T=0.K

Principal cross sections

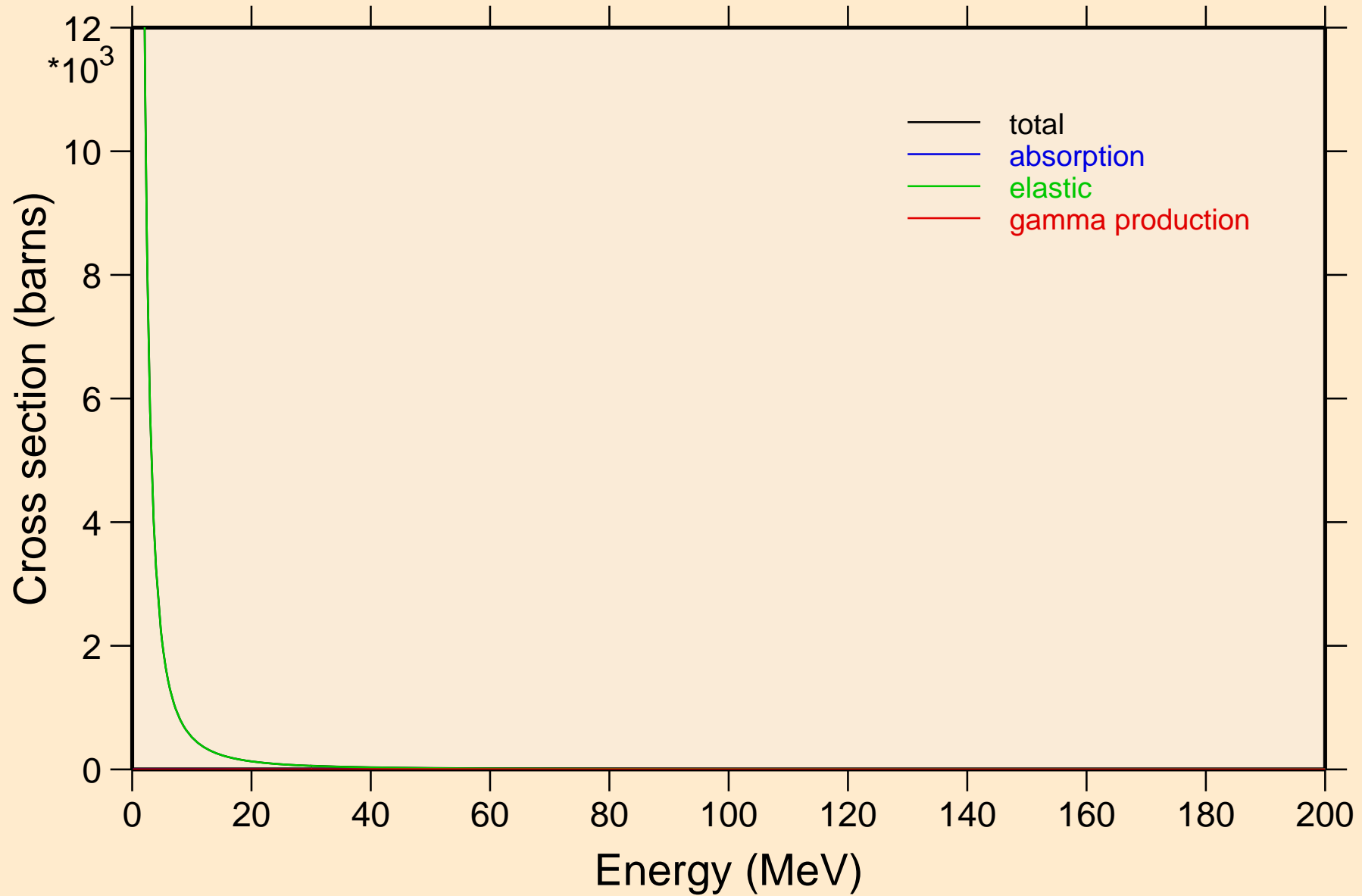

PA232 TRITON ACER TENDL-2021 LIBRARY; T=0.K

Heating

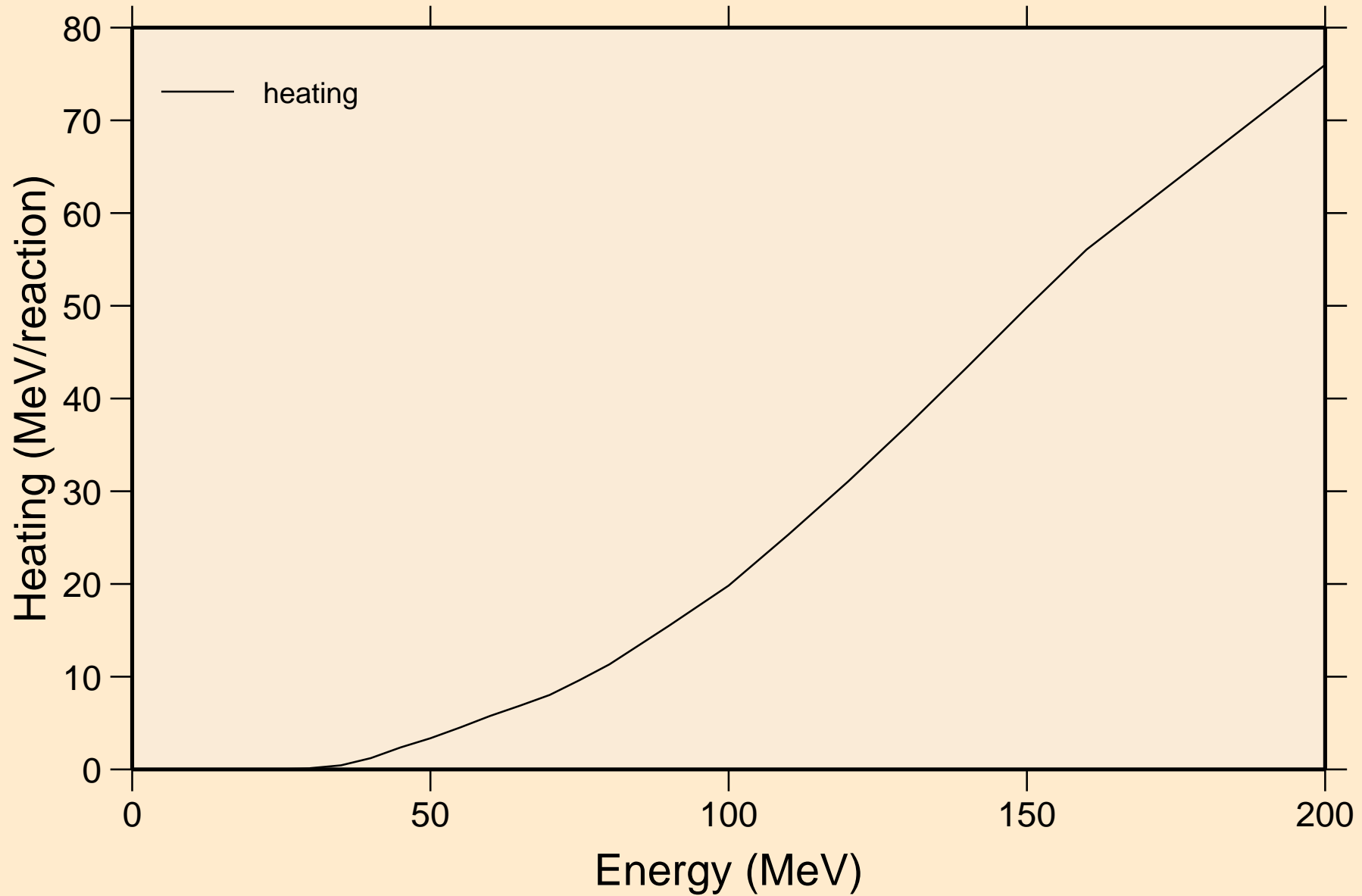

PA232 TRITON ACER TENDL-2021 LIBRARY; T=0.K  
Threshold reactions

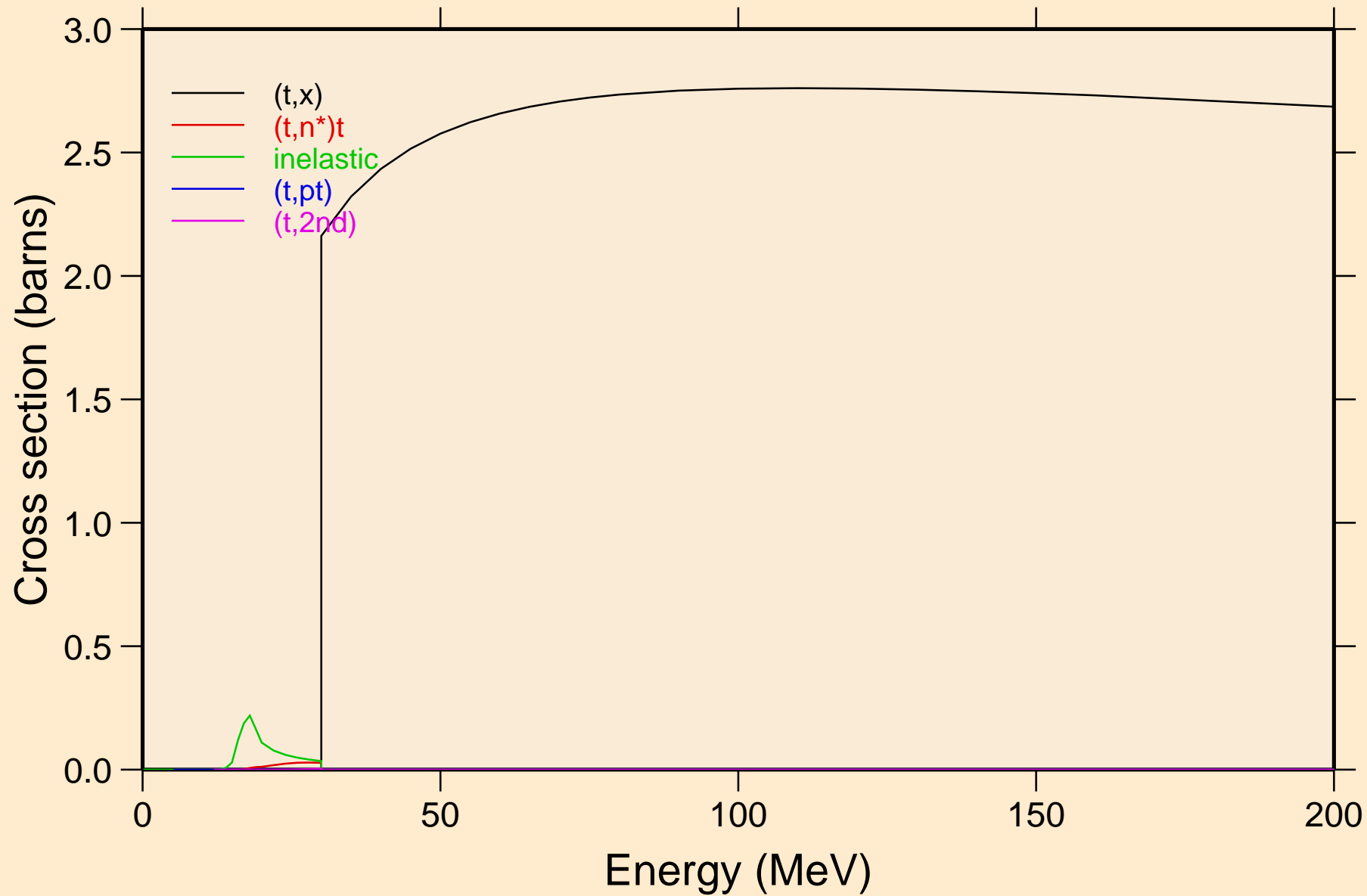

PA232 TRITON ACER TENDL-2021 LIBRARY; T=0.K  
Threshold reactions

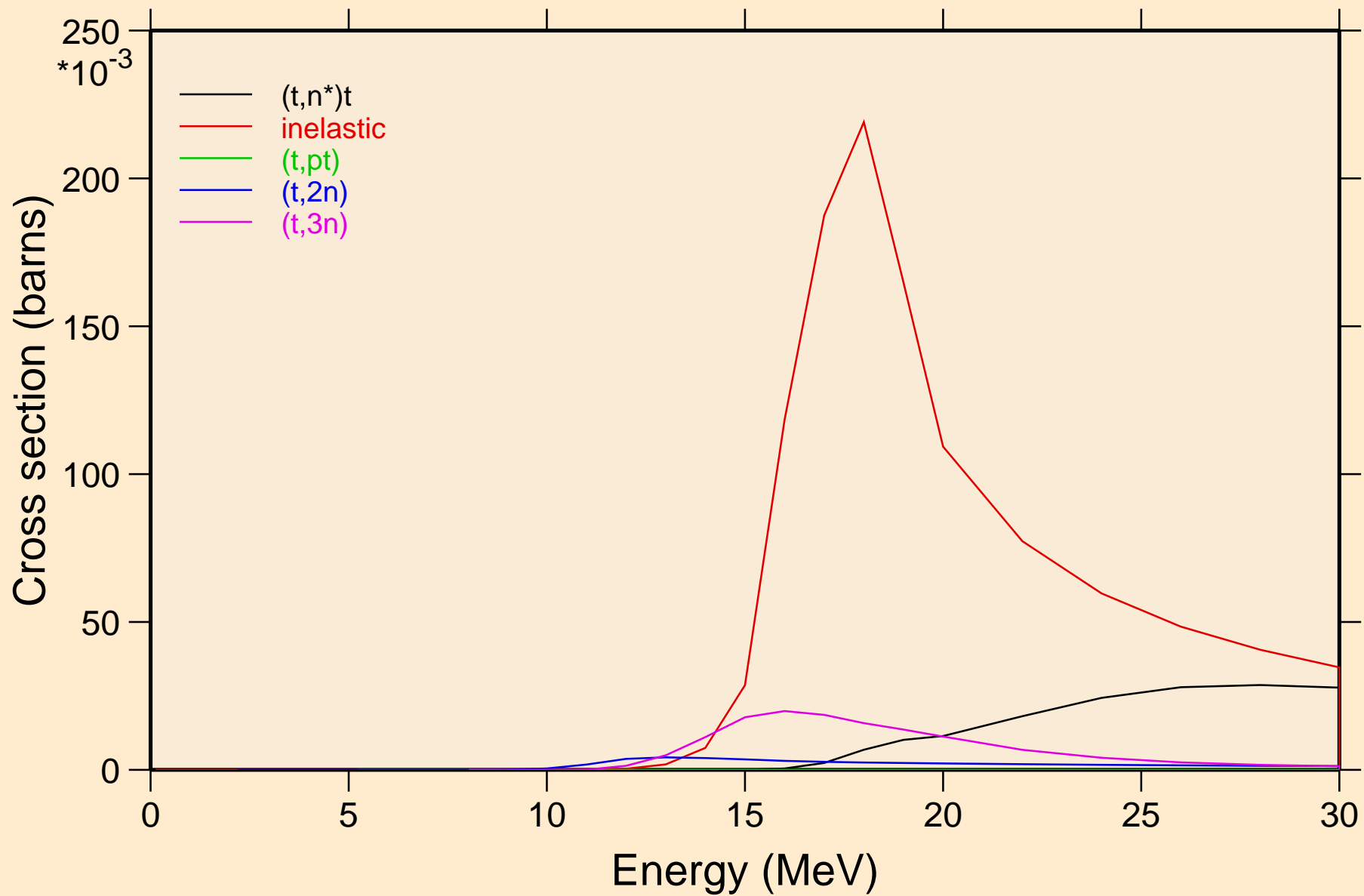

PA232 TRITON ACER TENDL-2021 LIBRARY; T=0.K  
Threshold reactions

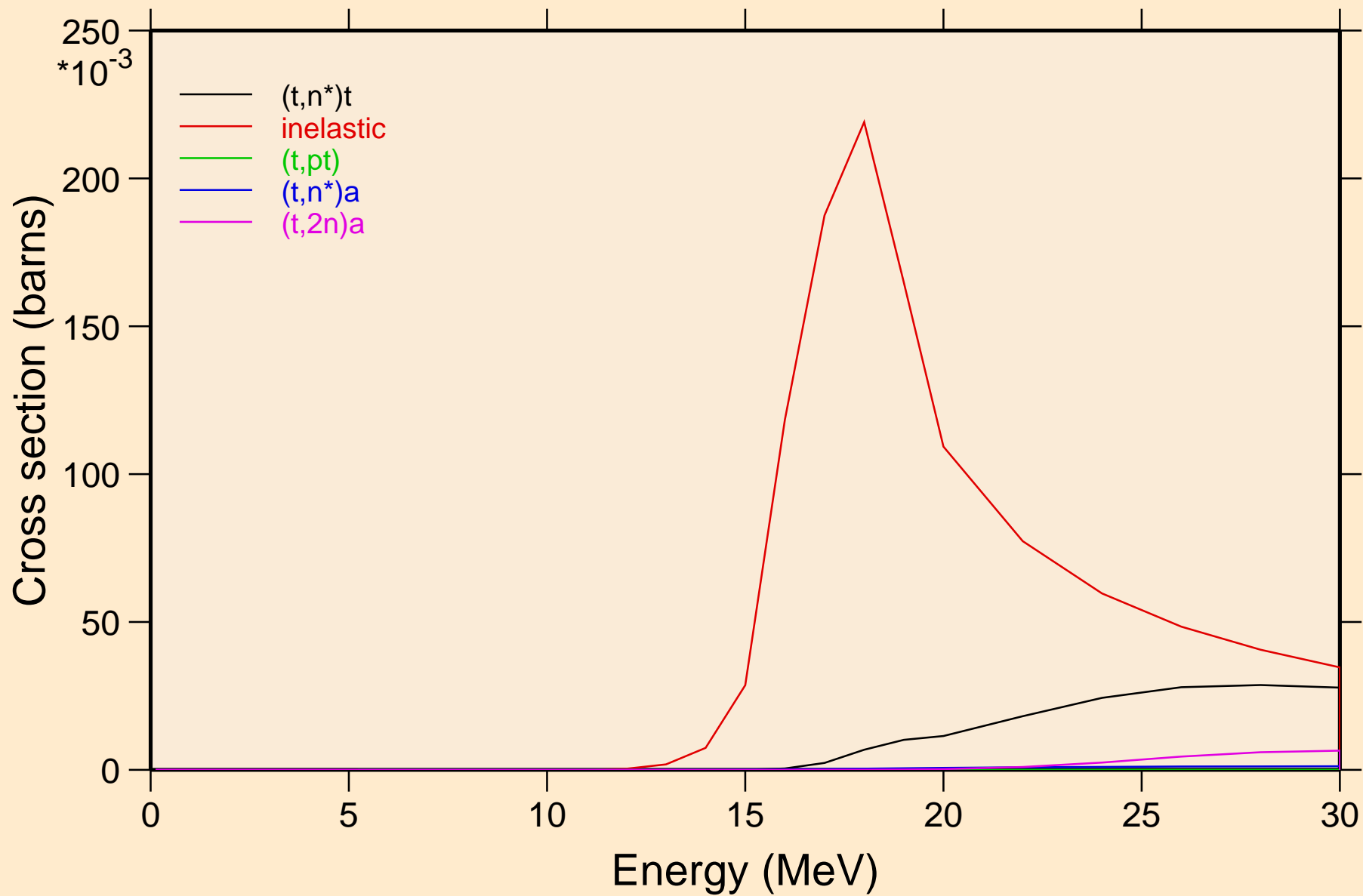

PA232 TRITON ACER TENDL-2021 LIBRARY; T=0.K  
Threshold reactions

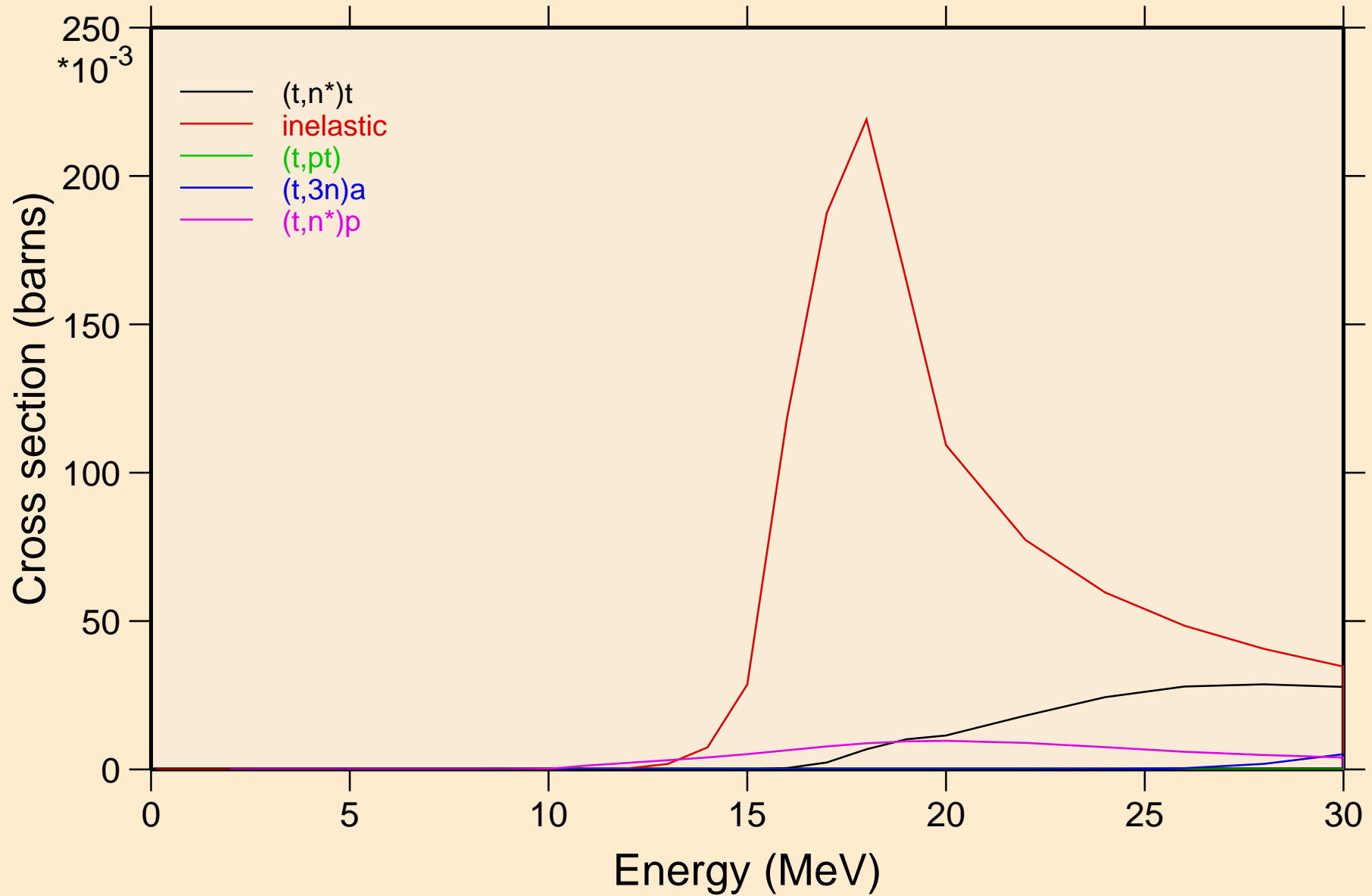



PA232 TRITON ACER TENDL-2021 LIBRARY; T=0.K  
Threshold reactions

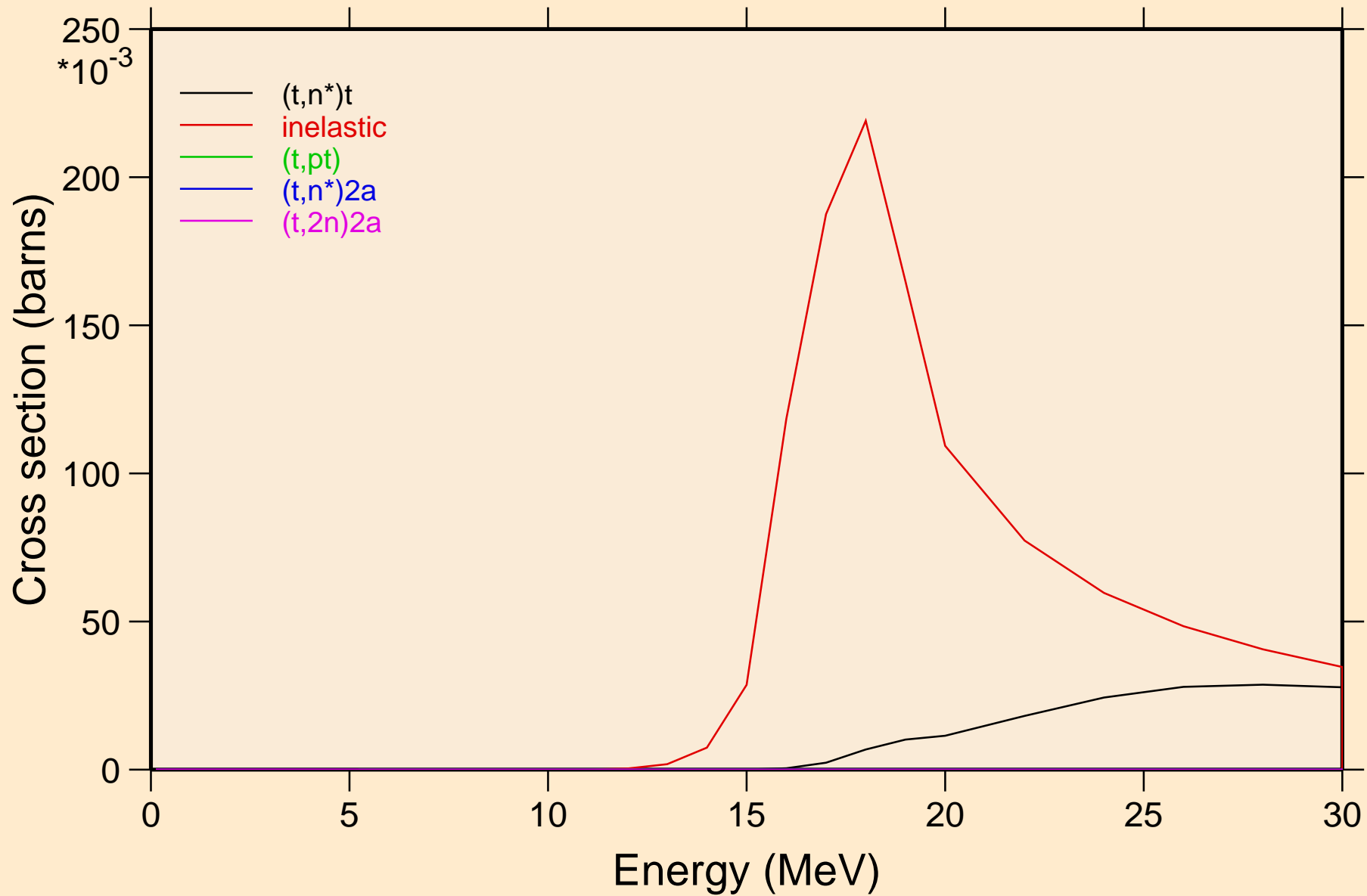

PA232 TRITON ACER TENDL-2021 LIBRARY; T=0.K  
Threshold reactions

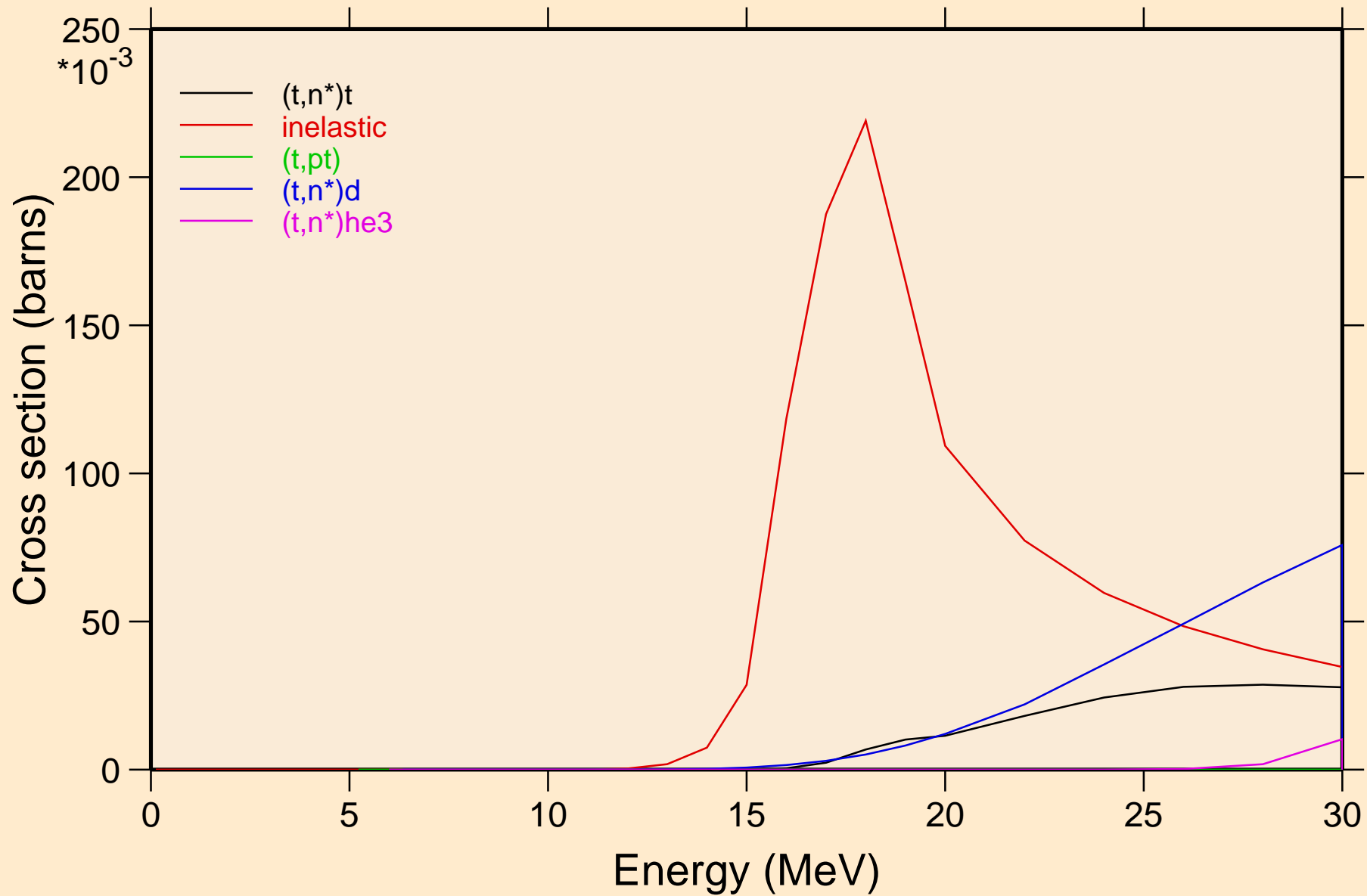

PA232 TRITON ACER TENDL-2021 LIBRARY; T=0.K  
Threshold reactions

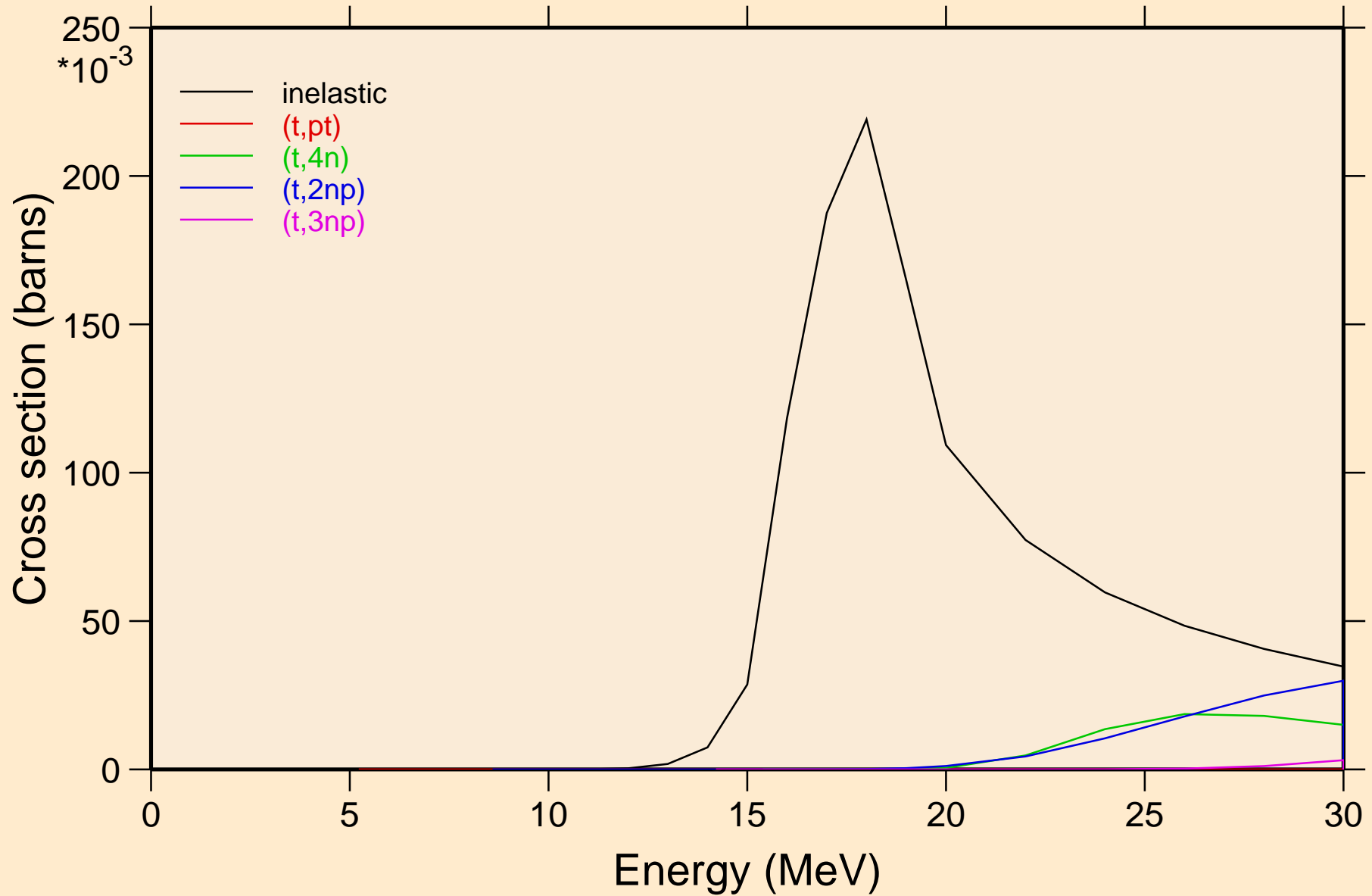

PA232 TRITON ACER TENDL-2021 LIBRARY; T=0.K  
Threshold reactions

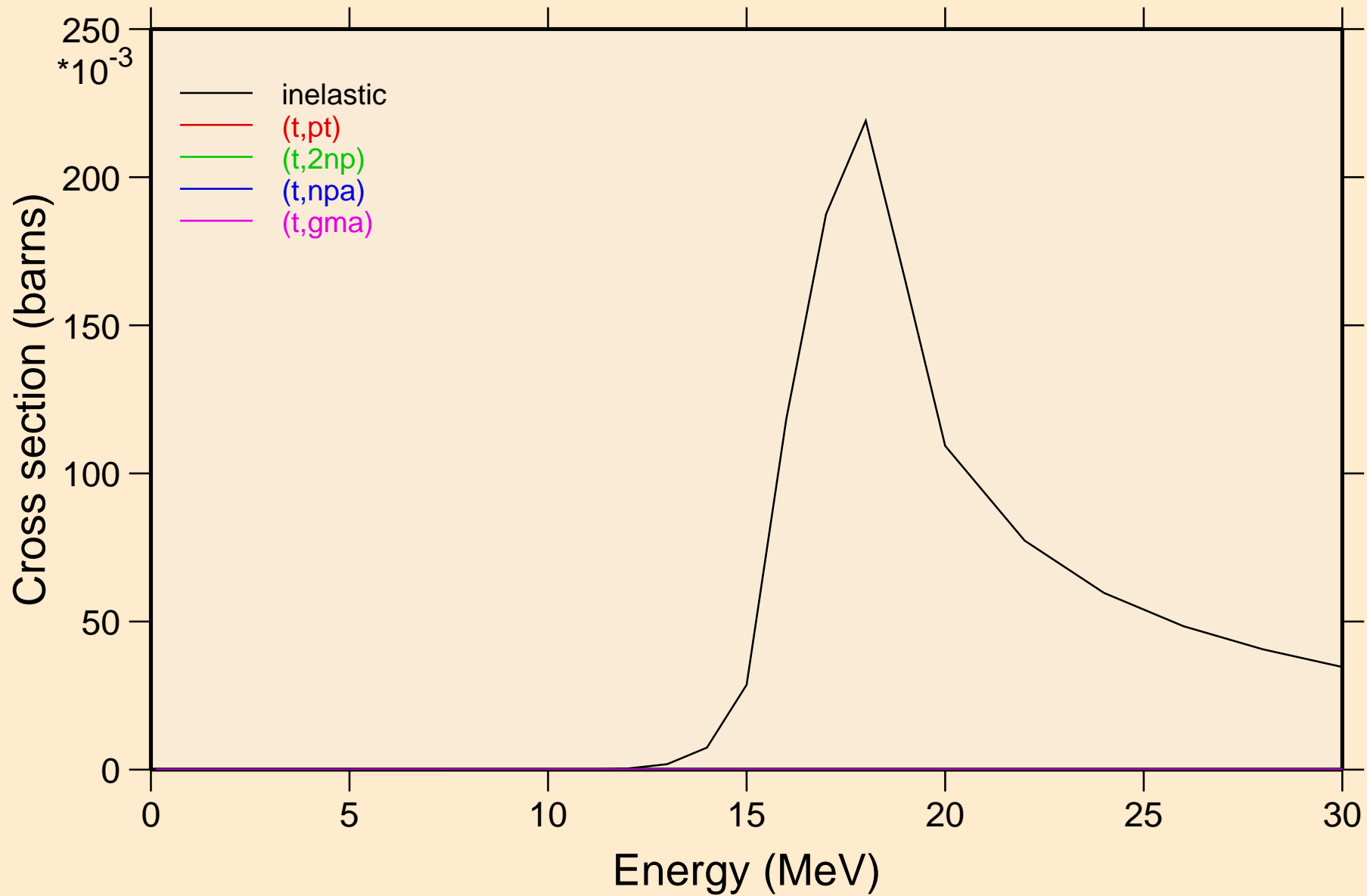

PA232 TRITON ACER TENDL-2021 LIBRARY; T=0.K  
Threshold reactions

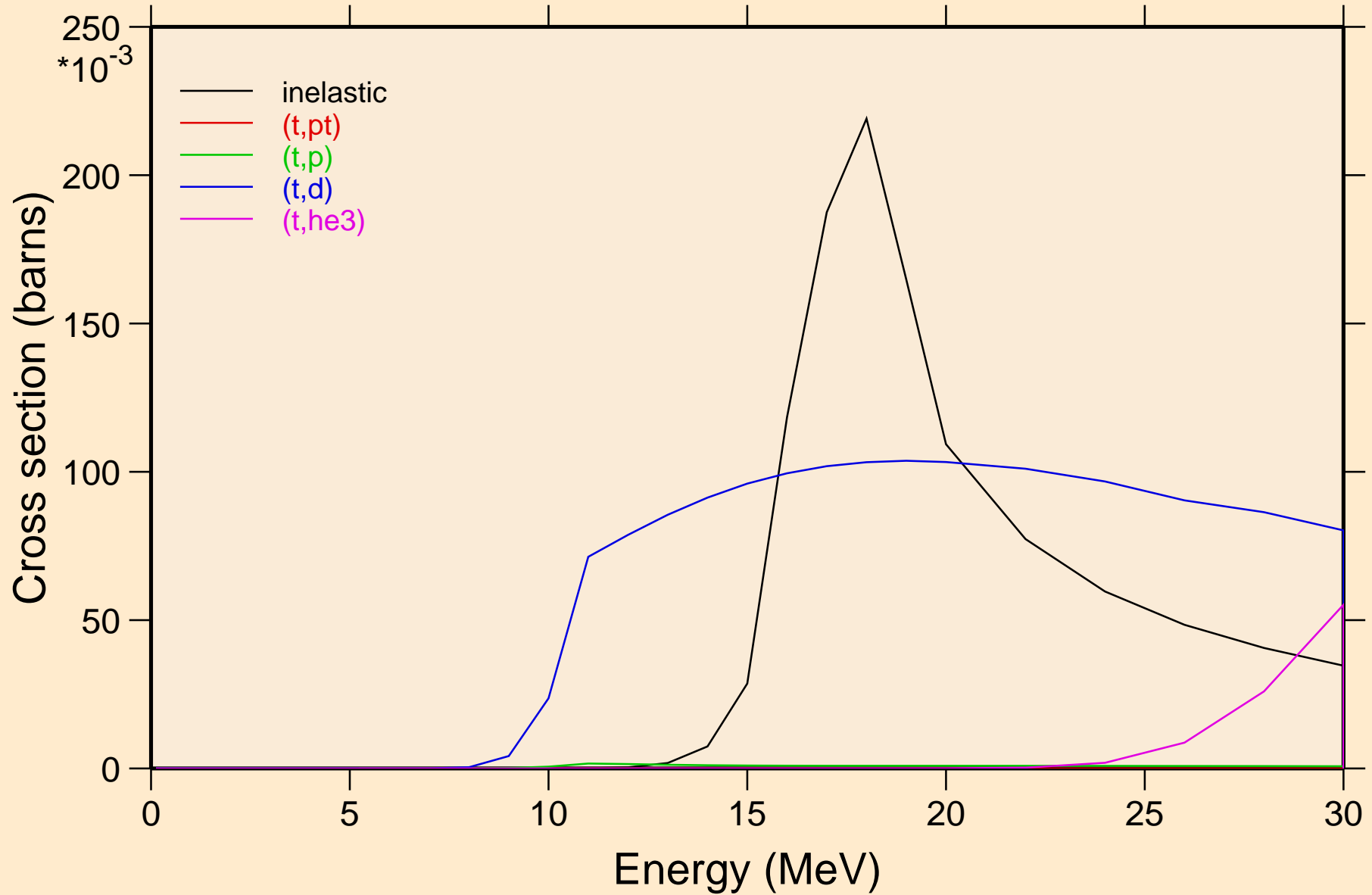

PA232 TRITON ACER TENDL-2021 LIBRARY; T=0.K  
Threshold reactions

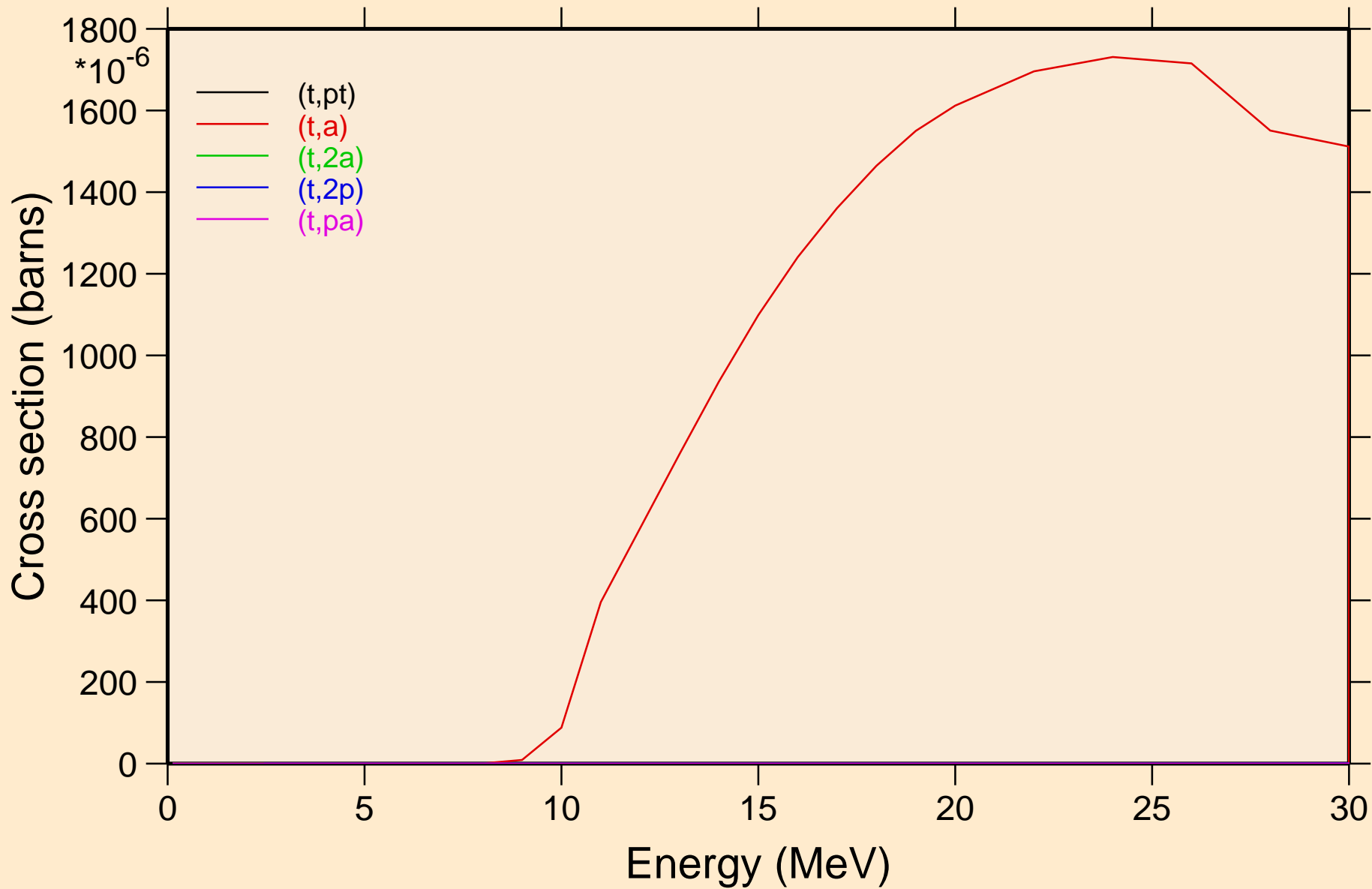

PA232 TRITON ACER TENDL-2021 LIBRARY; T=0.K  
Threshold reactions

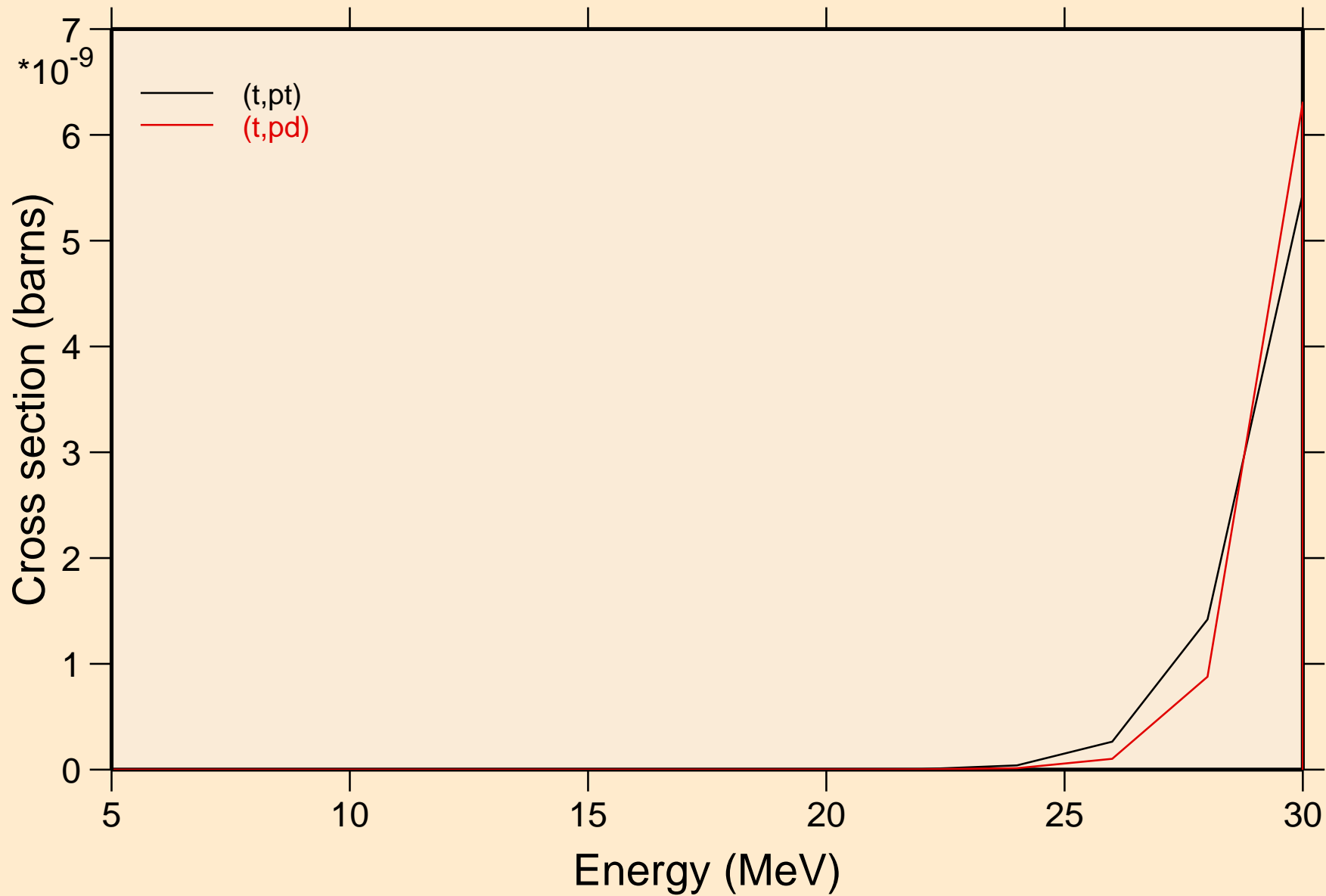

PA232 TRITON ACER TENDL-2021 LIBRARY; T=0.K  
Threshold reactions

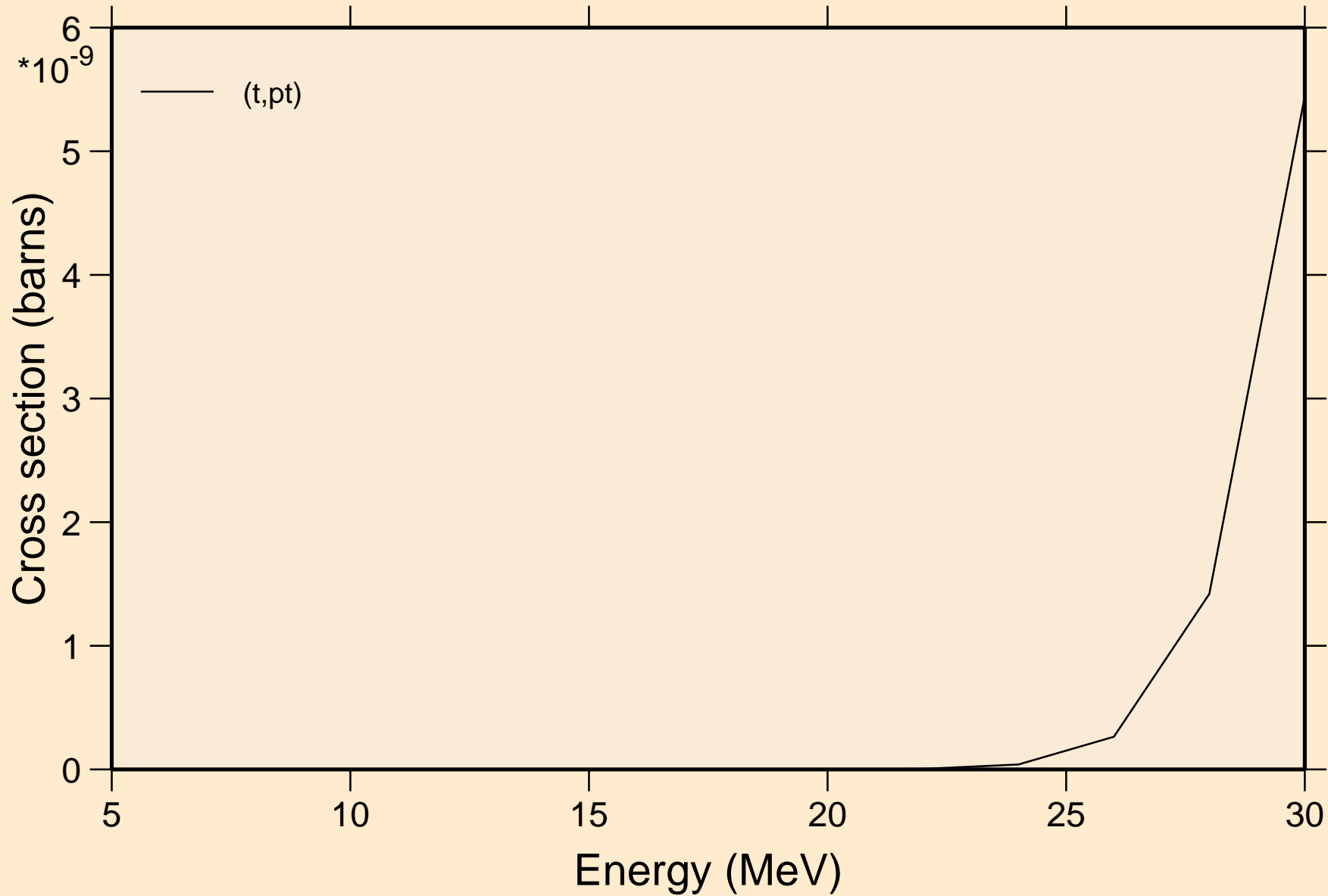



PA232 TRITON ACER TENDL-2021 LIBRARY; T=0.K  
angular distribution for elastic

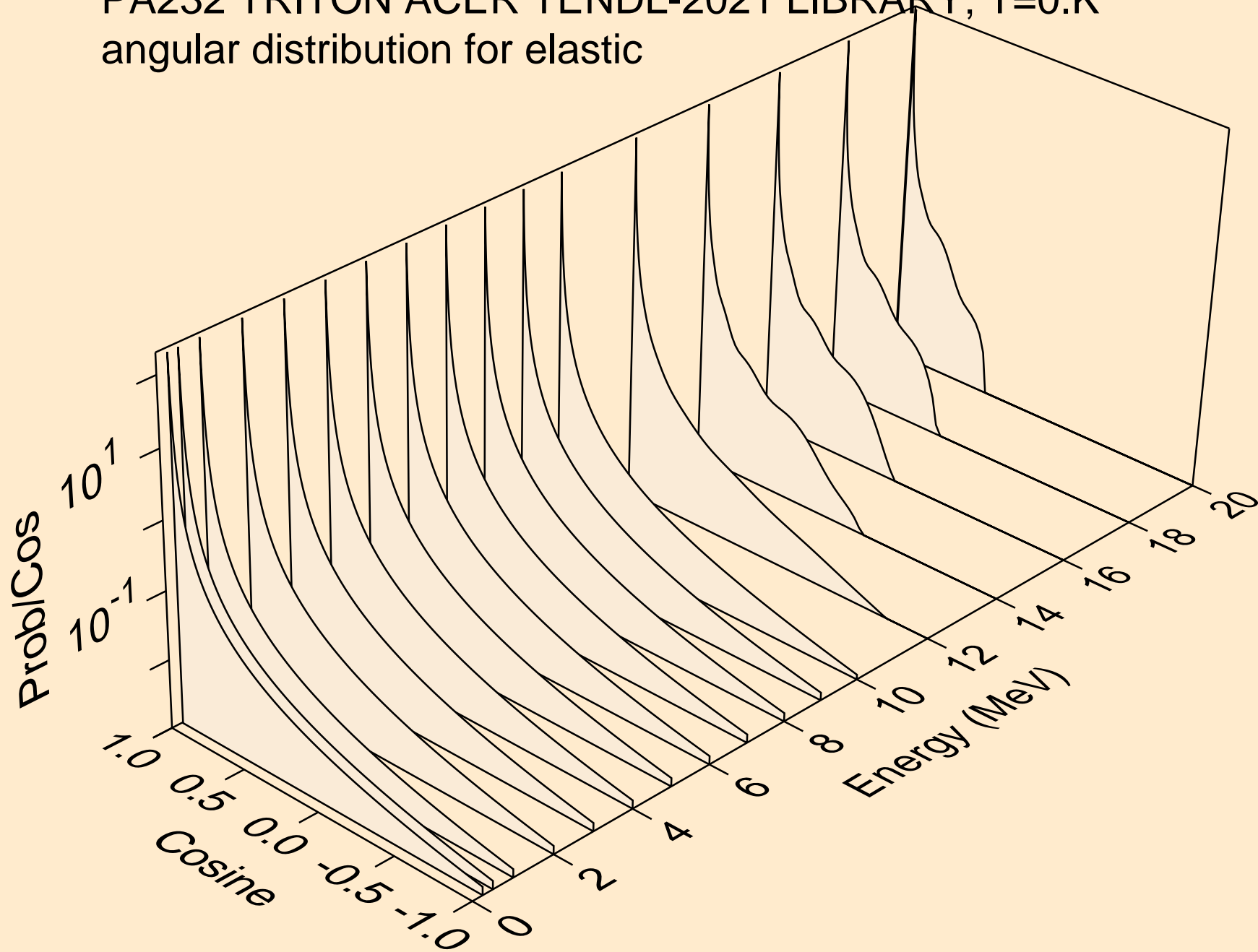

PA232 TRITON ACER TENDL-2021 LIBRARY; T=0.K  
angular distribution for elastic

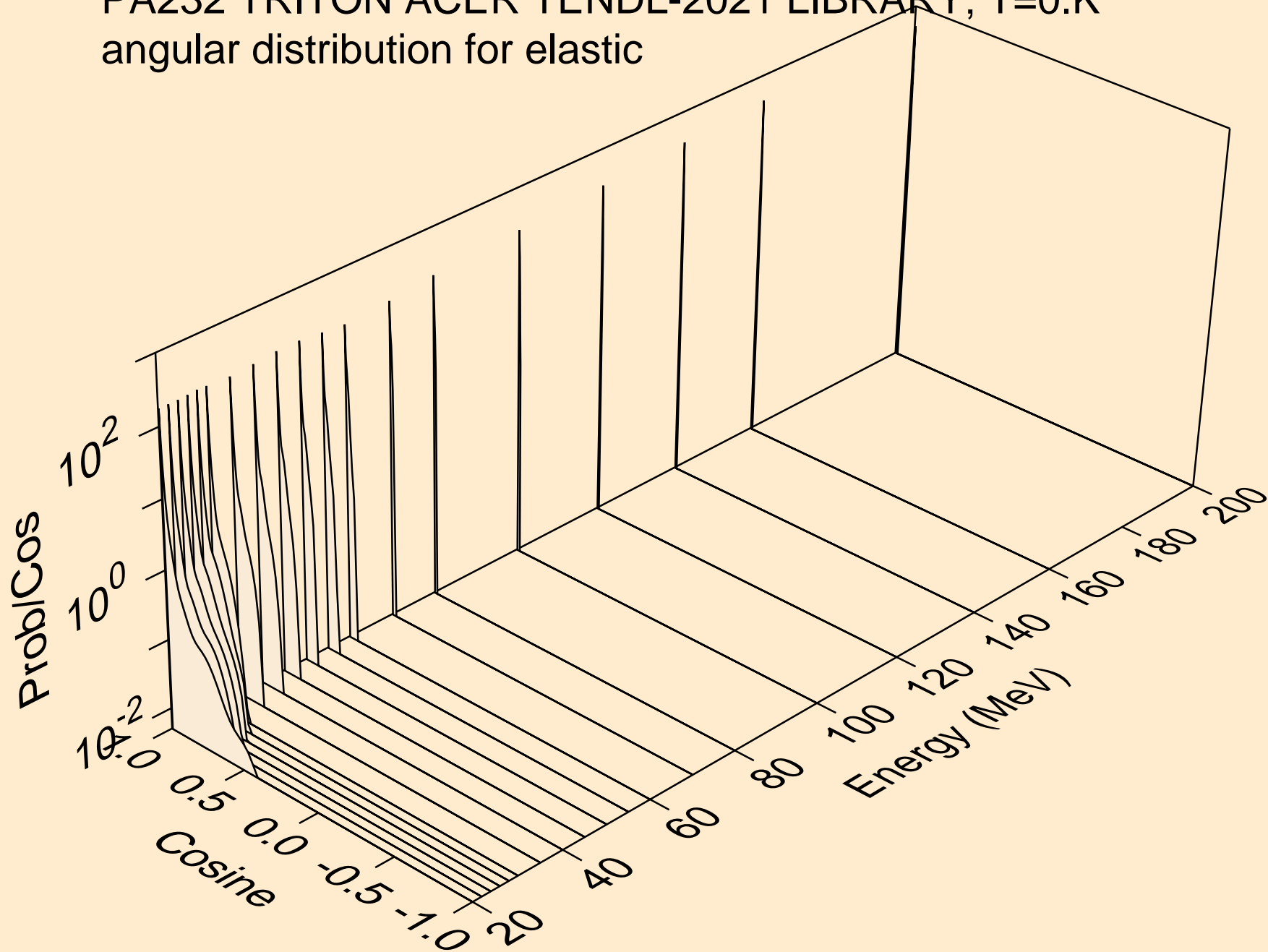

PA232 TRITON ACER TENDL-2021 LIBRARY; T=0.K  
Triton emission for (t,x)

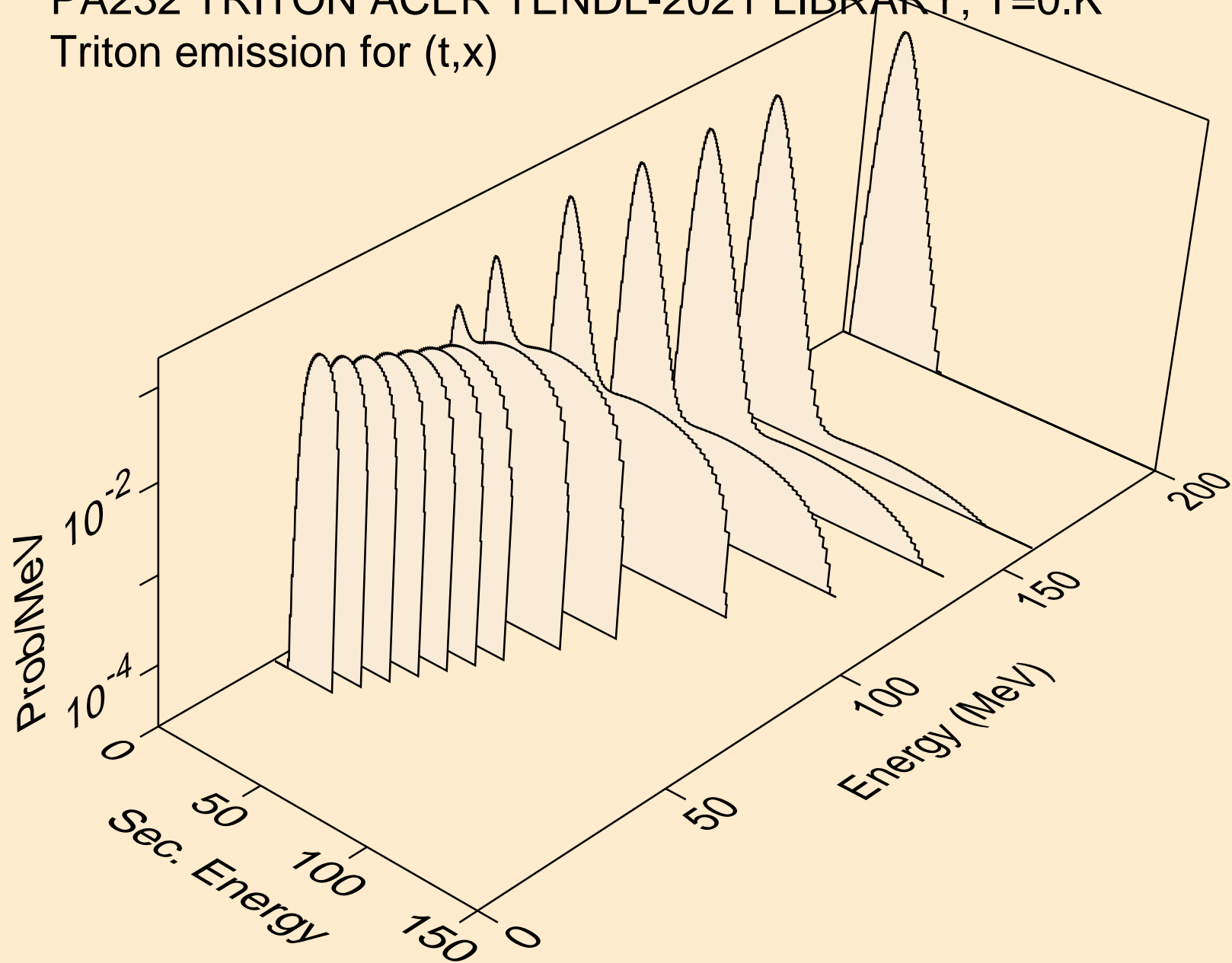

PA232 TRITON ACER TENDL-2021 LIBRARY; T=0.K  
Triton emission for (t,n\*)t

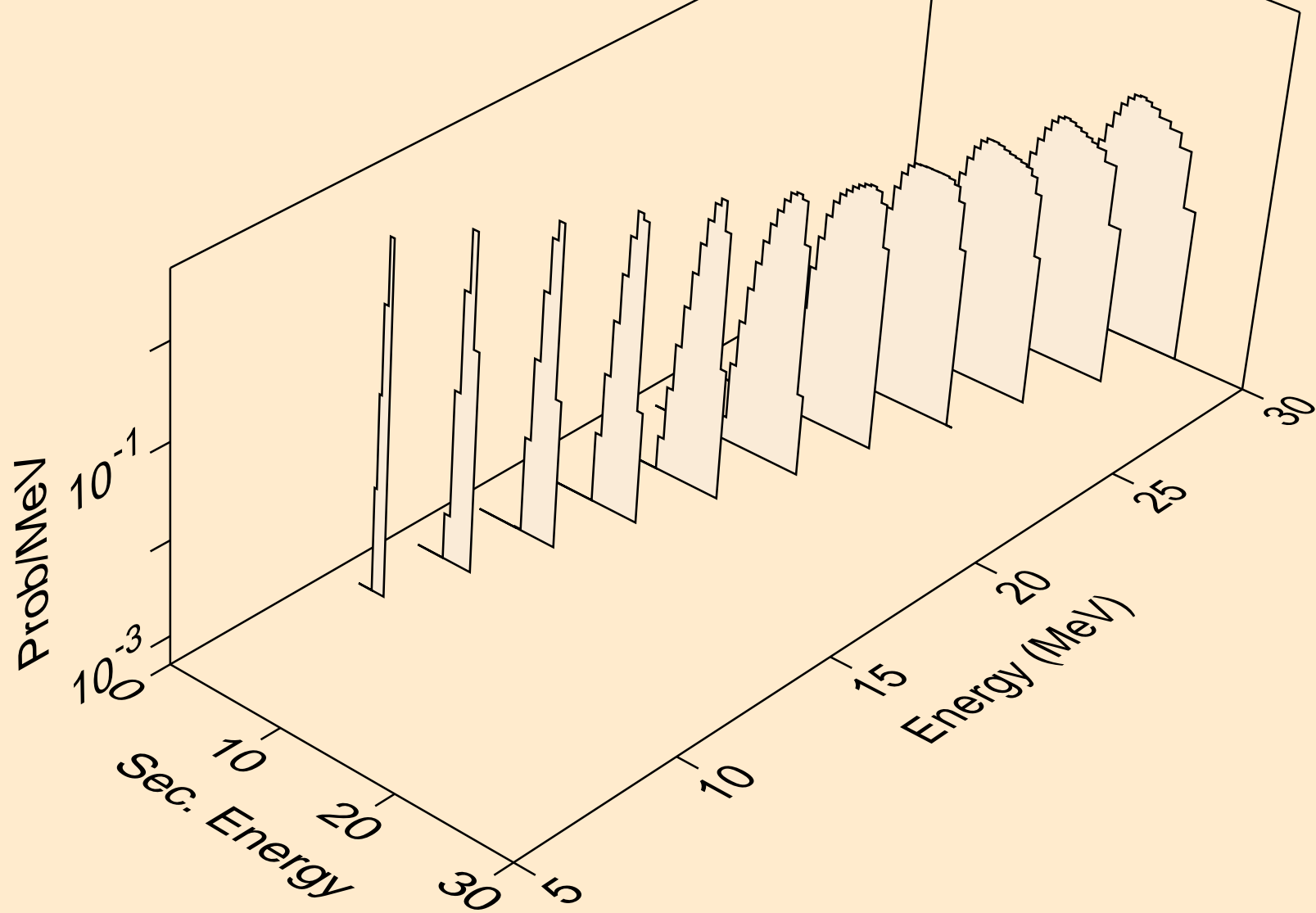

PA232 TRITON ACER TENDL-2021 LIBRARY; T=0.K  
Triton emission for inelastic

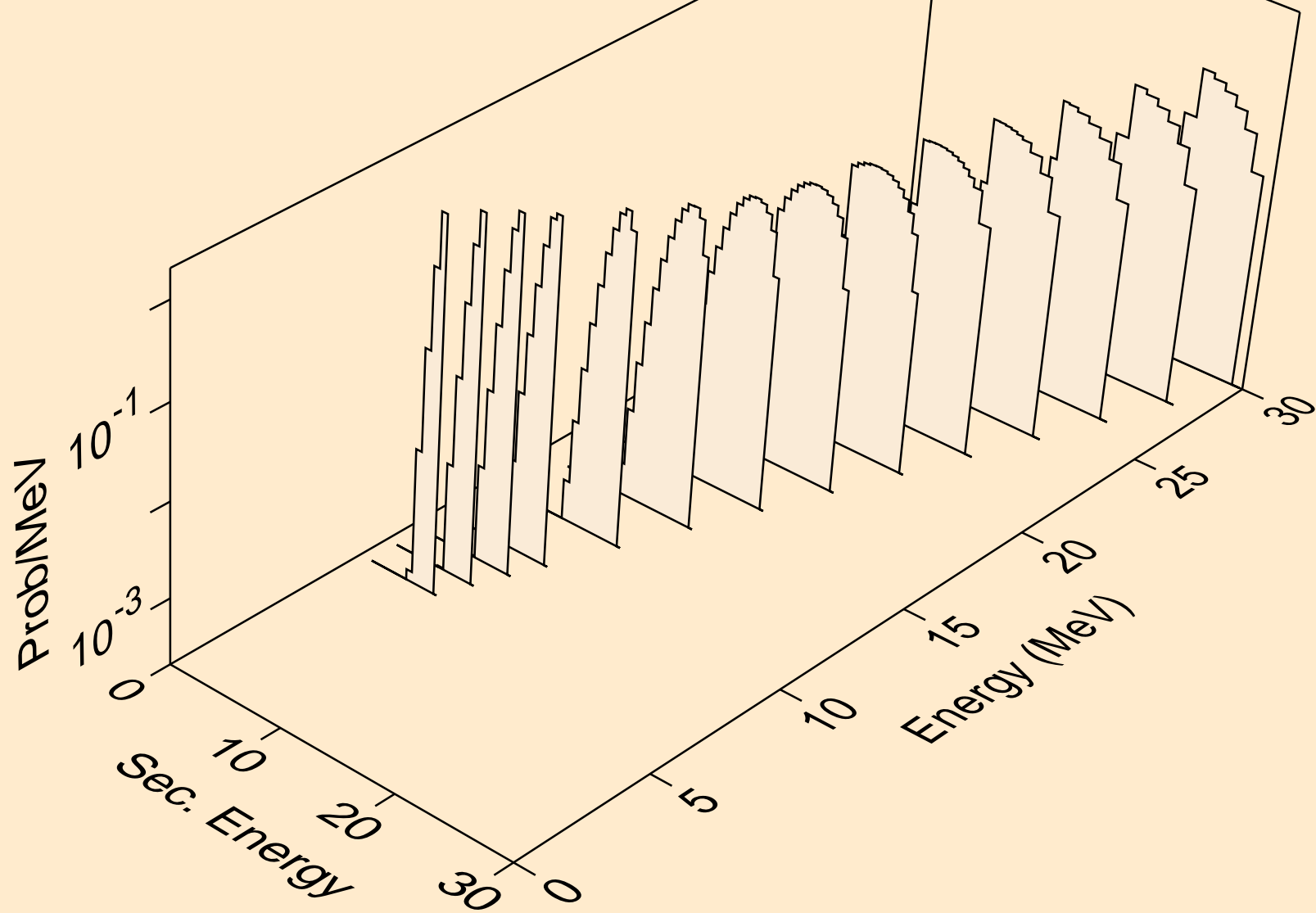

PA232 TRITON ACER TENDL-2021 LIBRARY; T=0.K  
Triton emission for (t,pt)

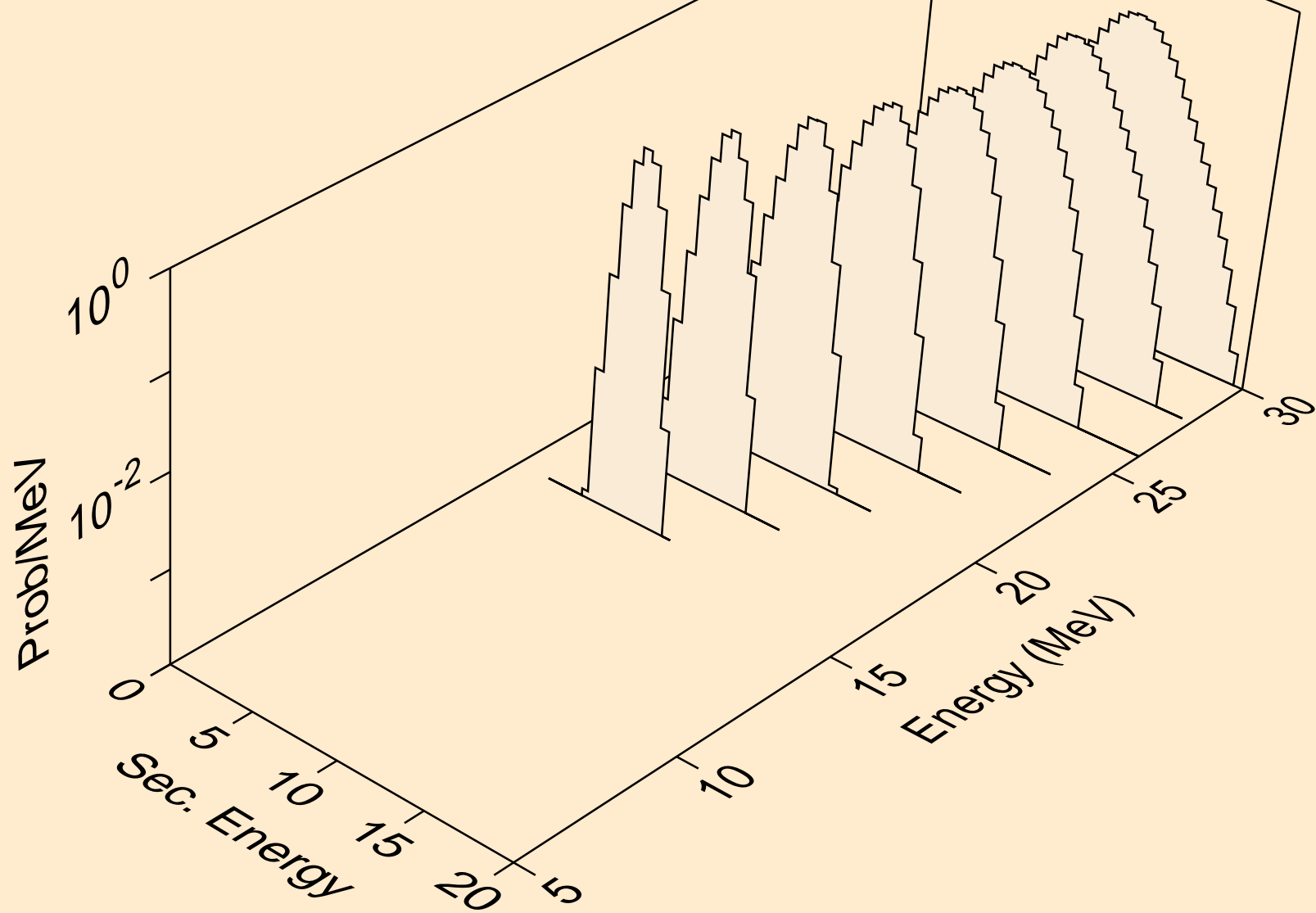

PA232 TRITON ACER TENDL-2021 LIBRARY; T=0.K  
Photon emission for (z,n)

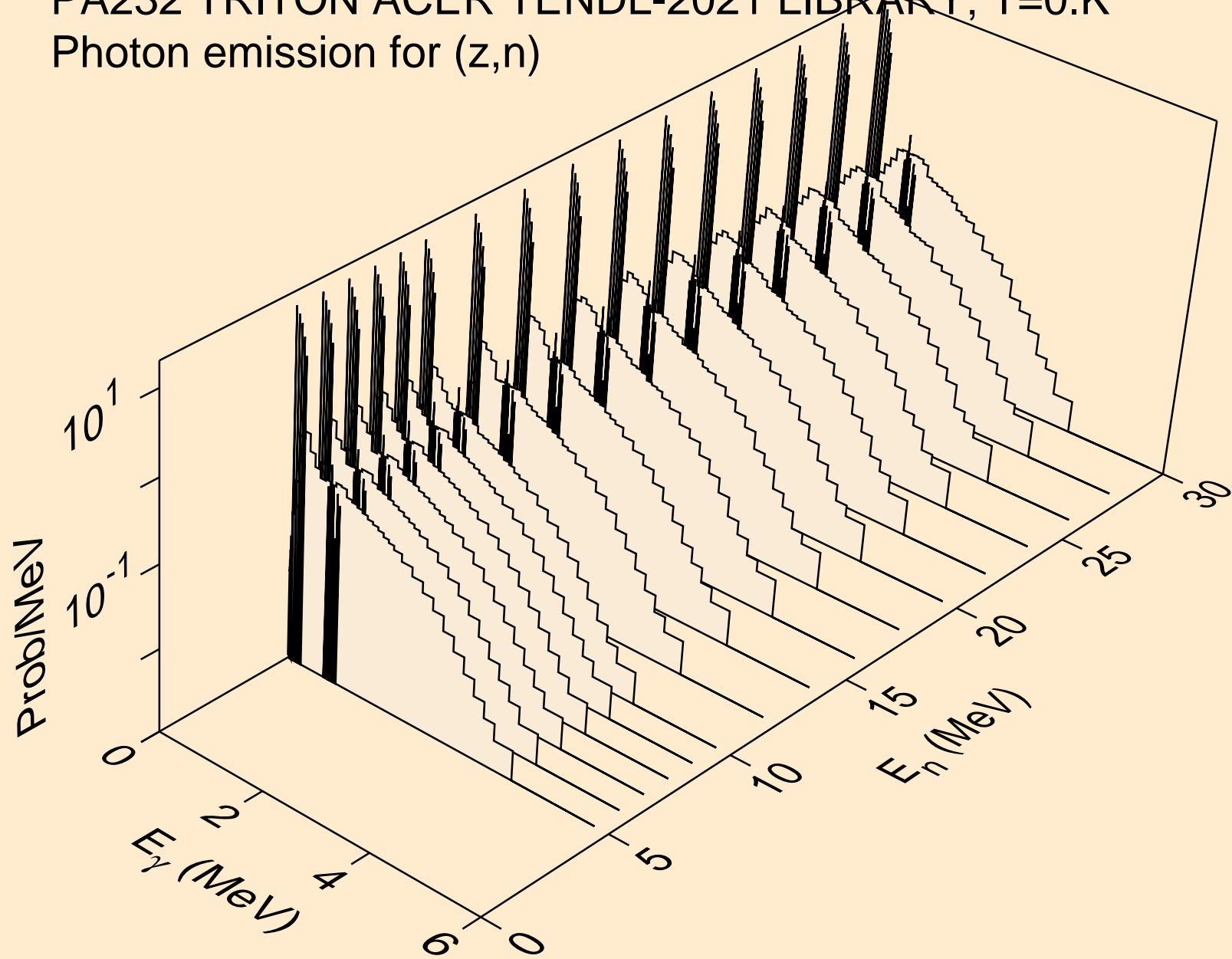

PA232 TRITON ACER TENDL-2021 LIBRARY; T=0.K  
Photon emission for (n,x)

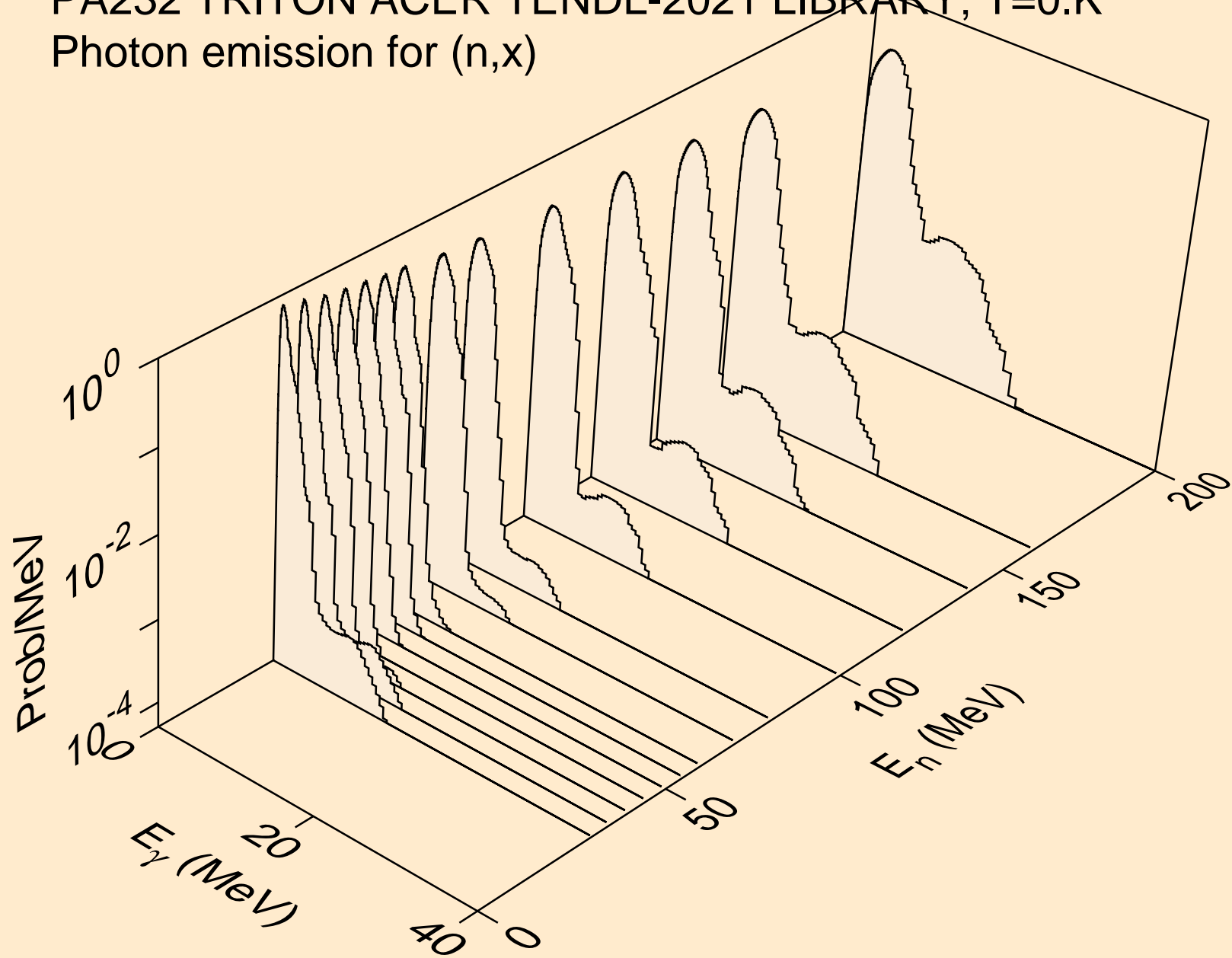



PA232 TRITON ACER TENDL-2021 LIBRARY; T=0.K  
Photon emission for (n,2nd)

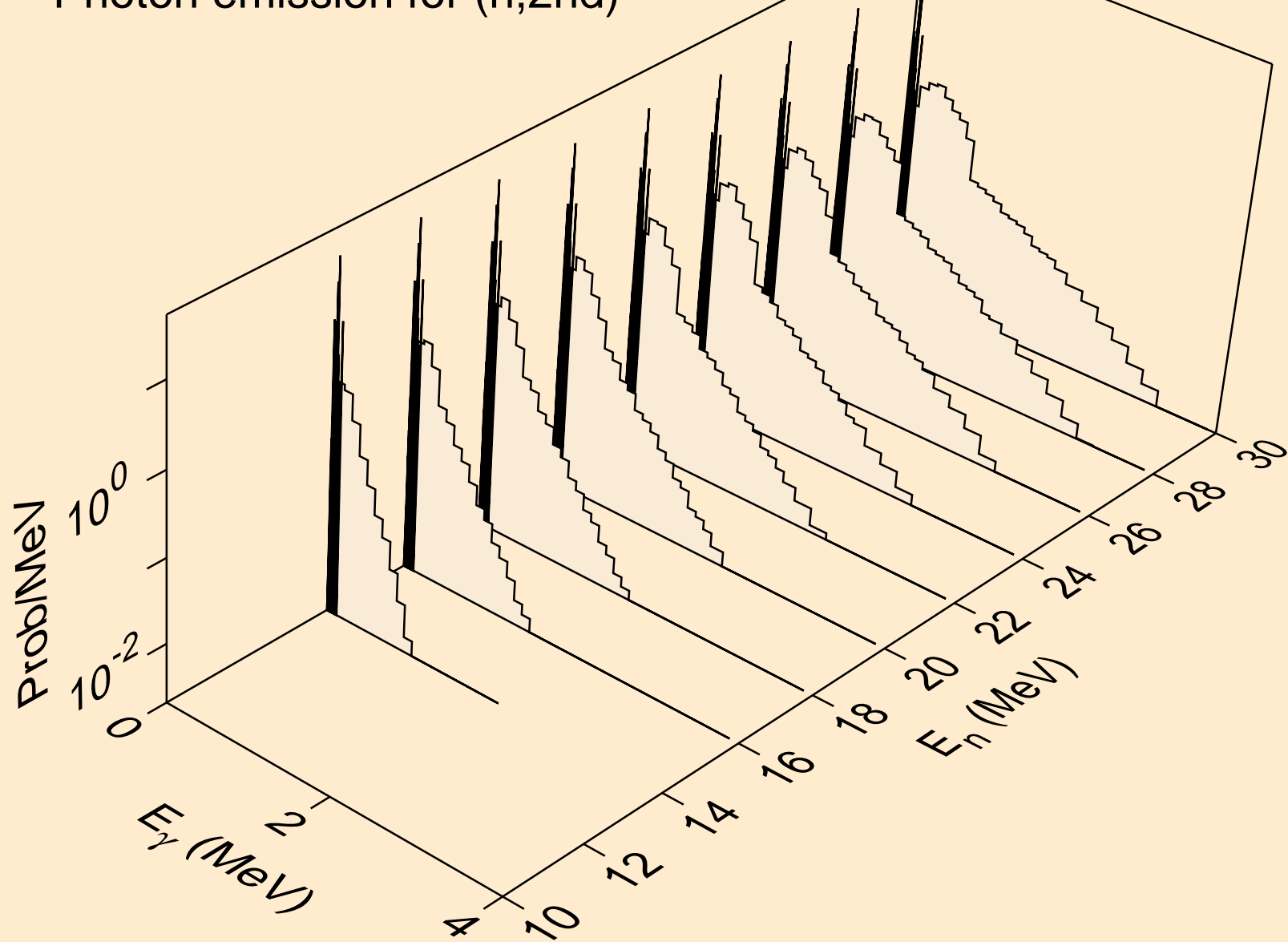

PA232 TRITON ACER TENDL-2021 LIBRARY; T=0.K  
Photon emission for (n,2n)

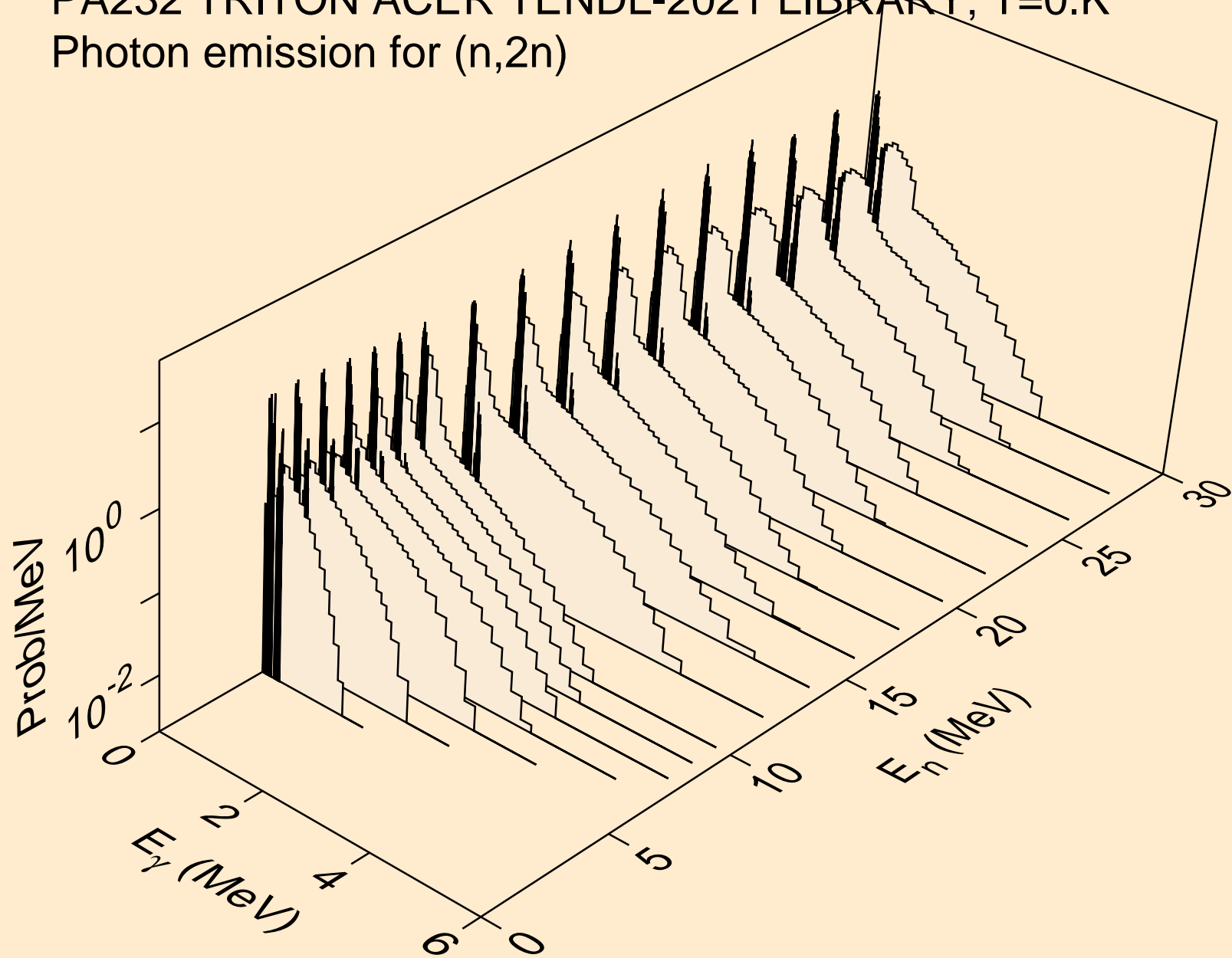

PA232 TRITON ACER TENDL-2021 LIBRARY; T=0.K  
Photon emission for (n,3n)

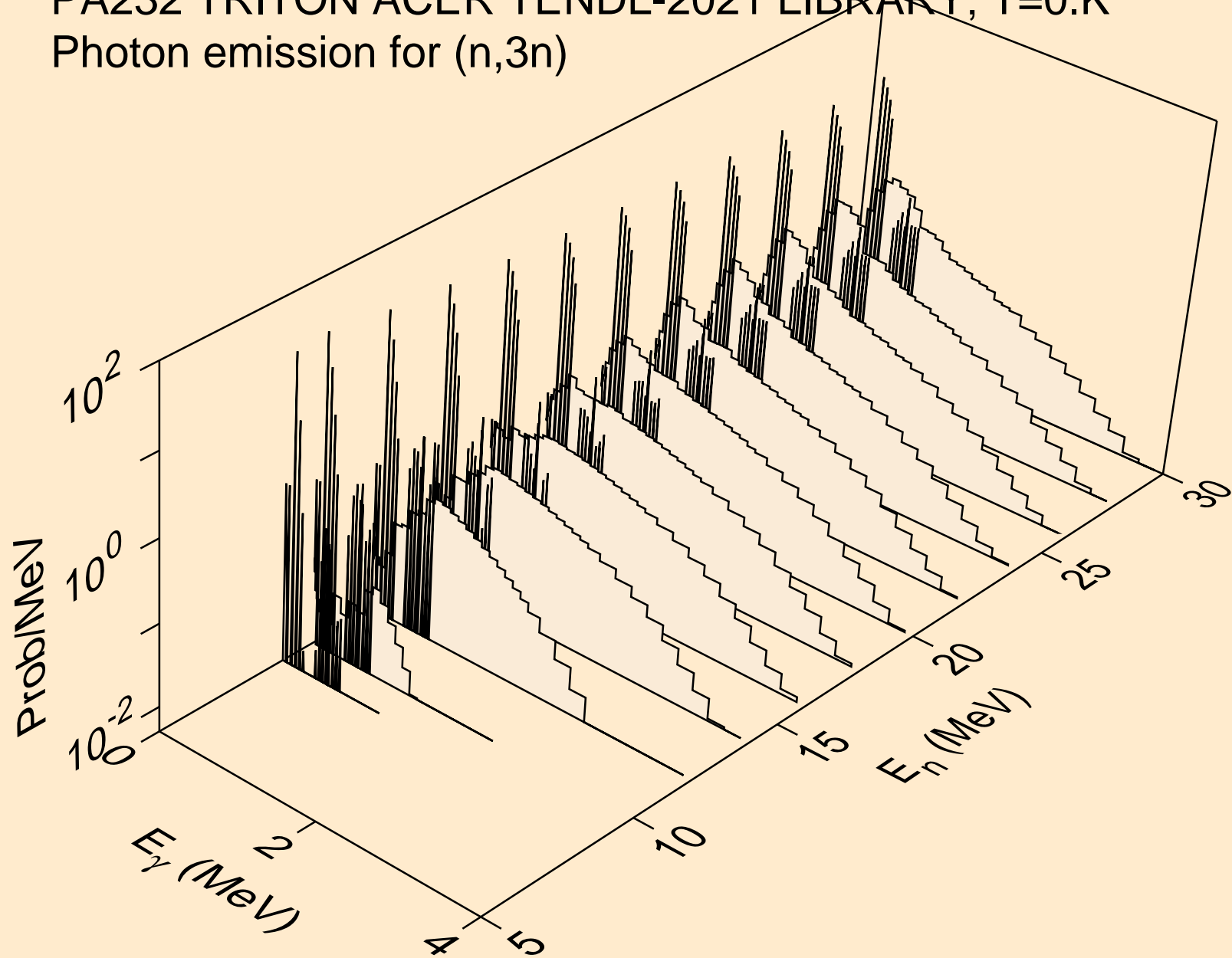

PA232 TRITON ACER TENDL-2021 LIBRARY; T=0.K  
Photon emission for (n,n\*)a

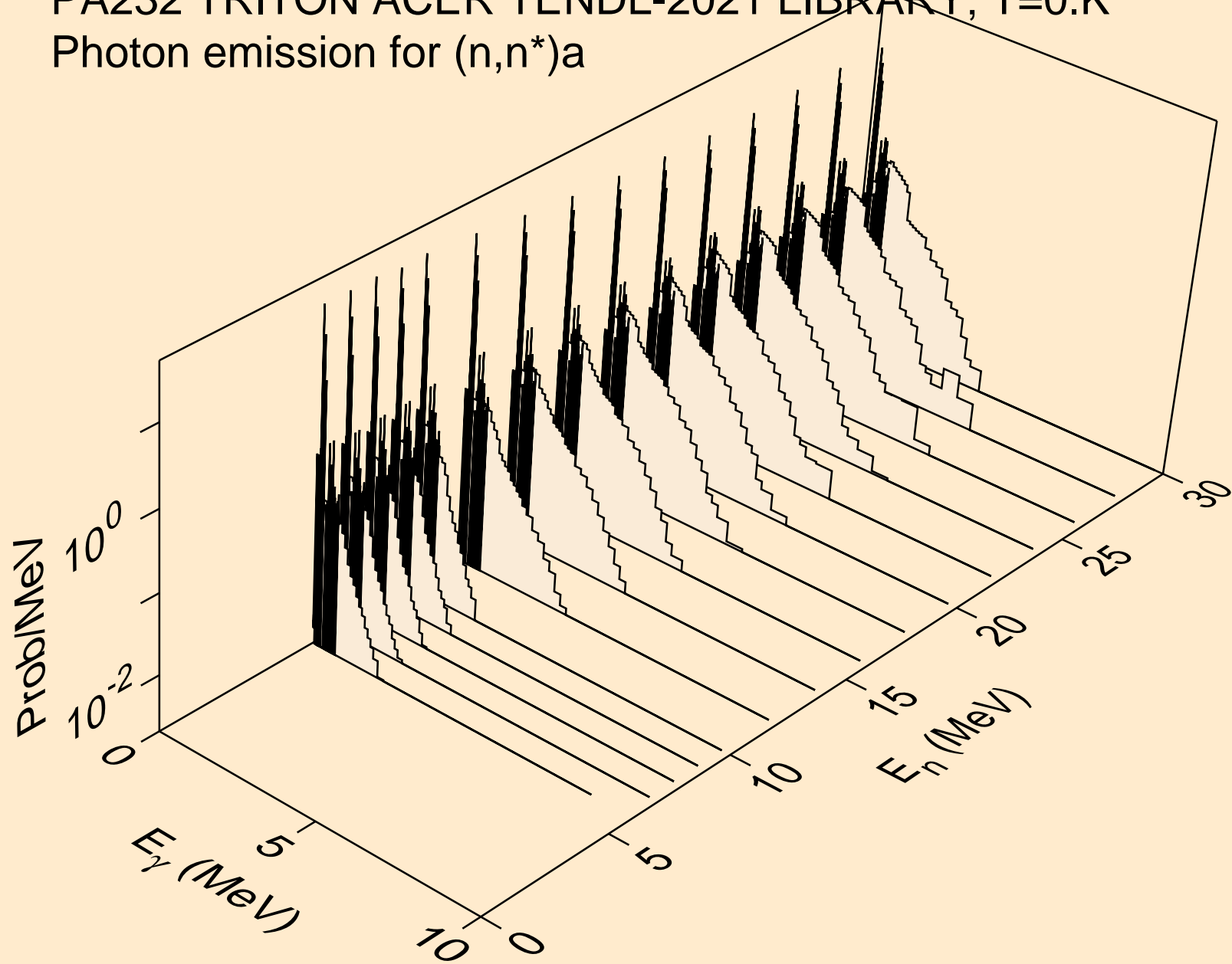

PA232 TRITON ACER TENDL-2021 LIBRARY; T=0.K  
Photon emission for (n,2n)a

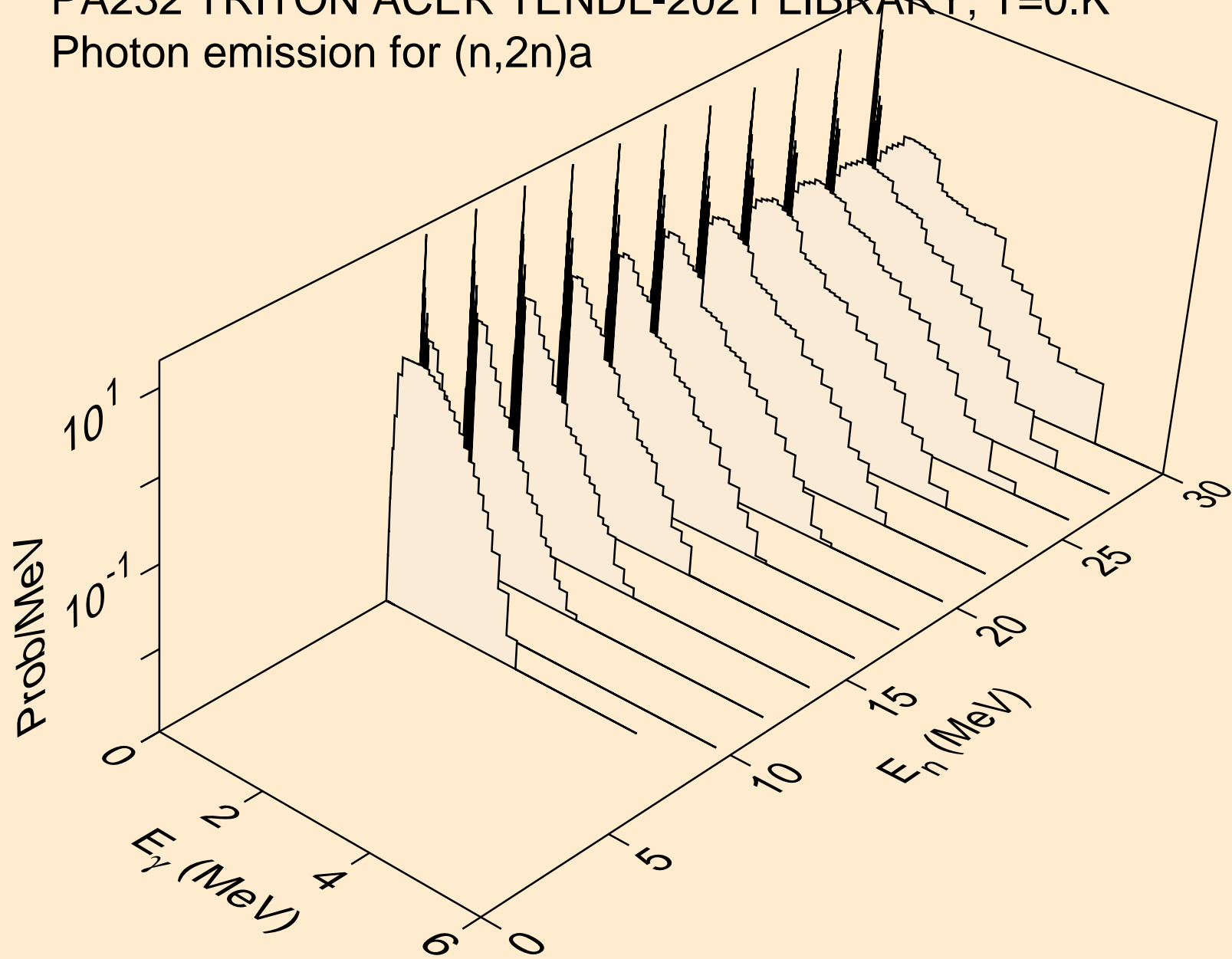

PA232 TRITON ACER TENDL-2021 LIBRARY; T=0.K  
Photon emission for (n,3n)a

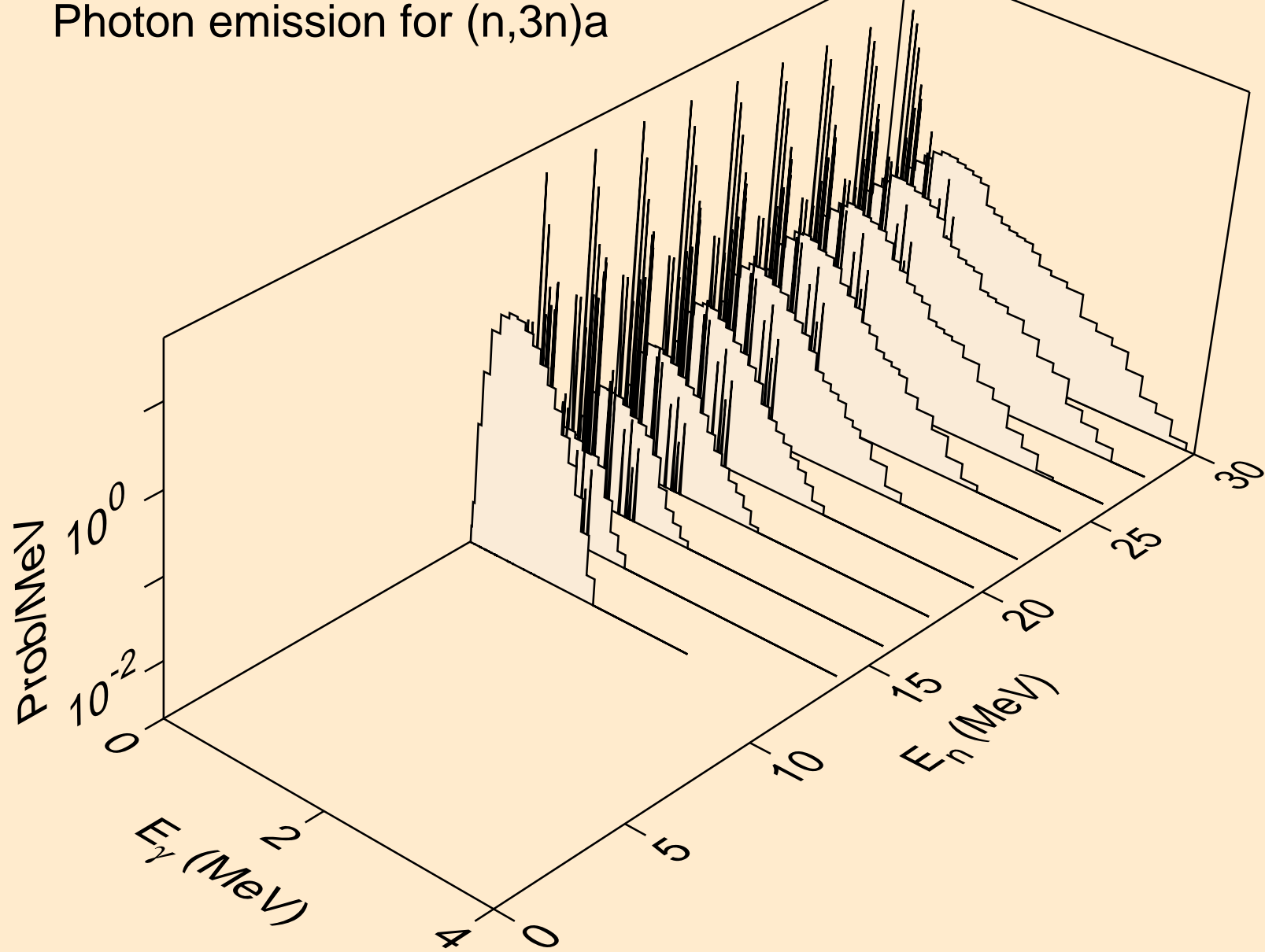

PA232 TRITON ACER TENDL-2021 LIBRARY; T=0.K  
Photon emission for (n,n\*)p

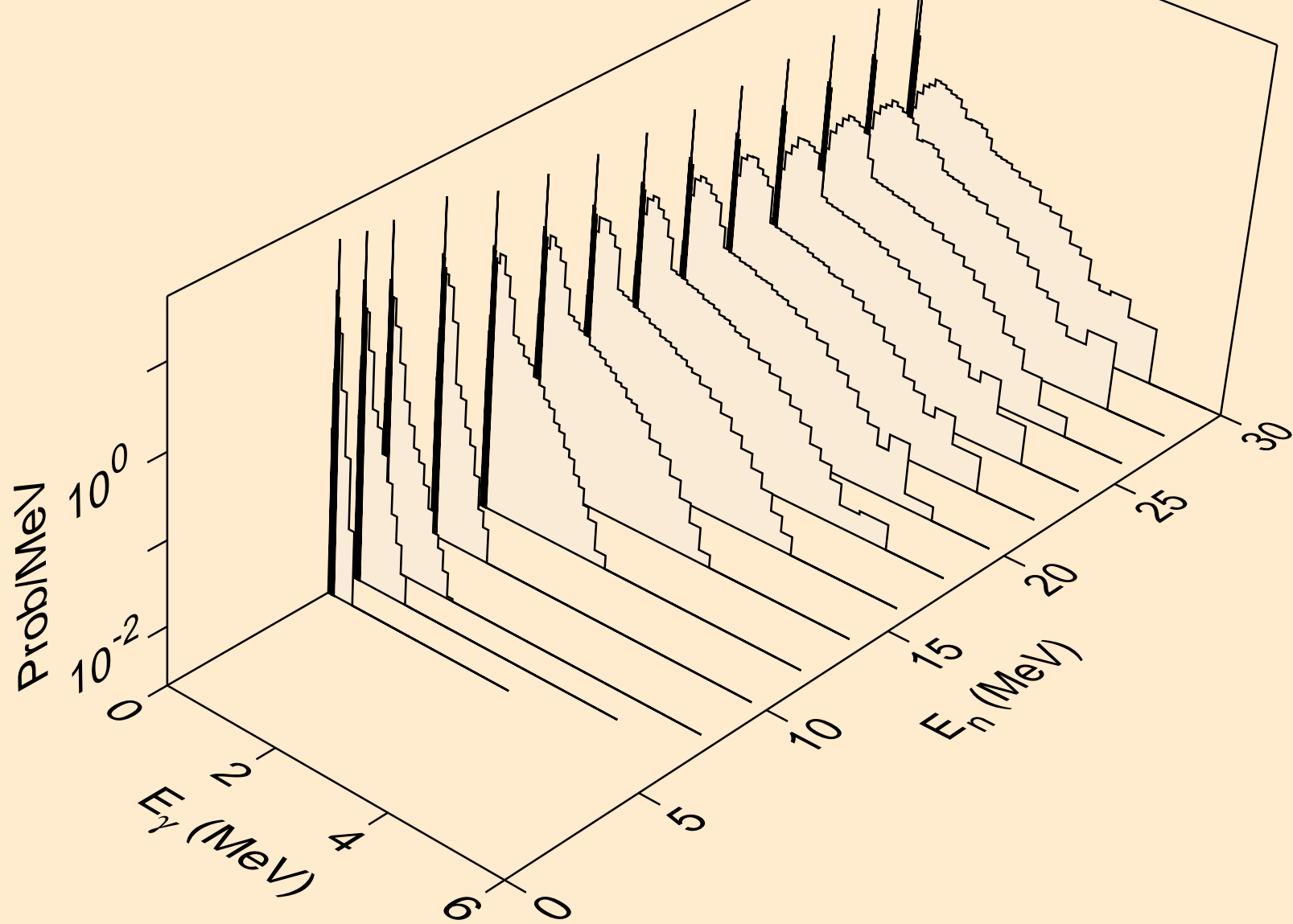

PA232 TRITON ACER TENDL-2021 LIBRARY; T=0.K  
Photon emission for (n,n\*)2a

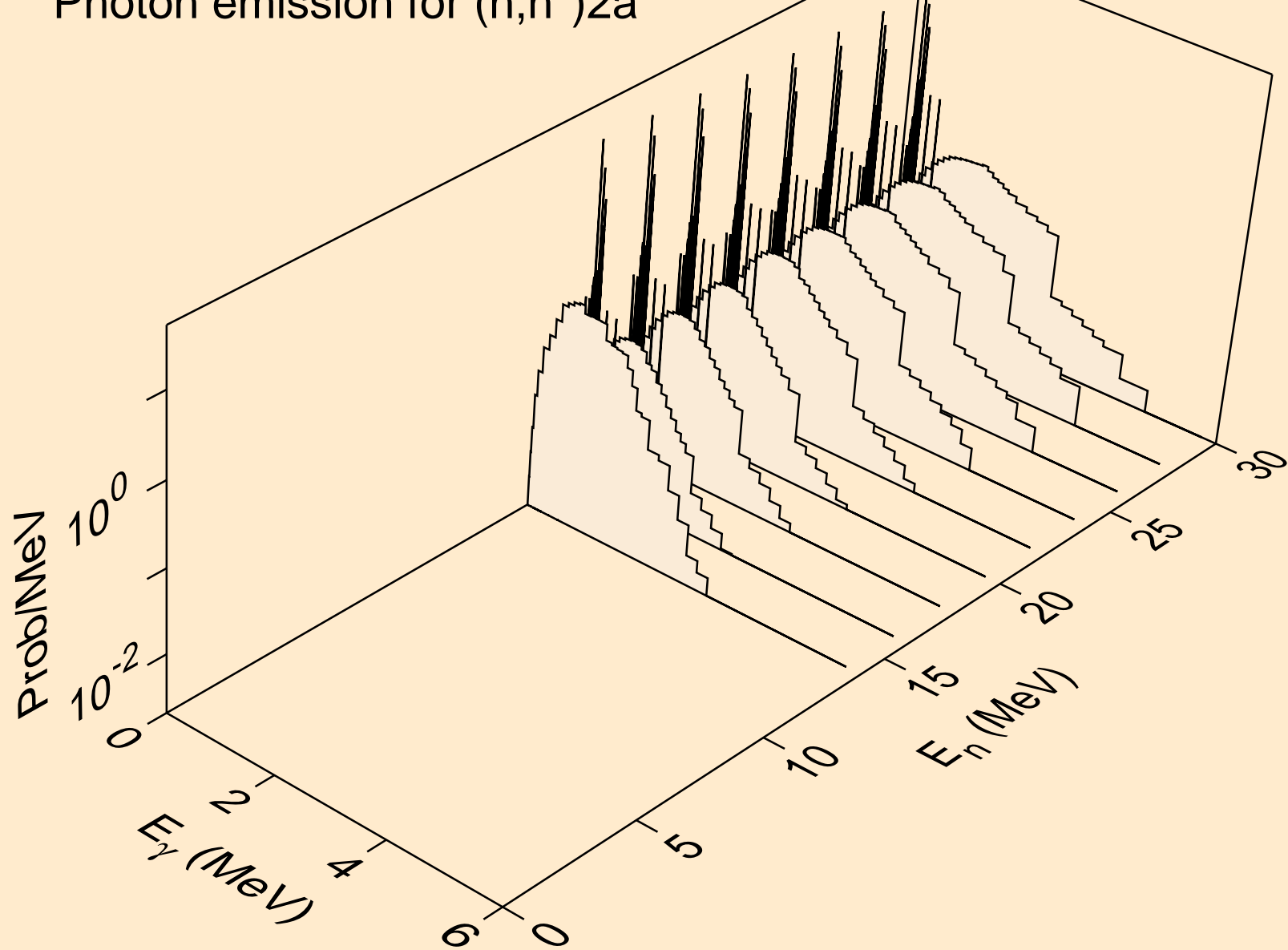



PA232 TRITON ACER TENDL-2021 LIBRARY; T=0.K  
Photon emission for (n,2n)2a

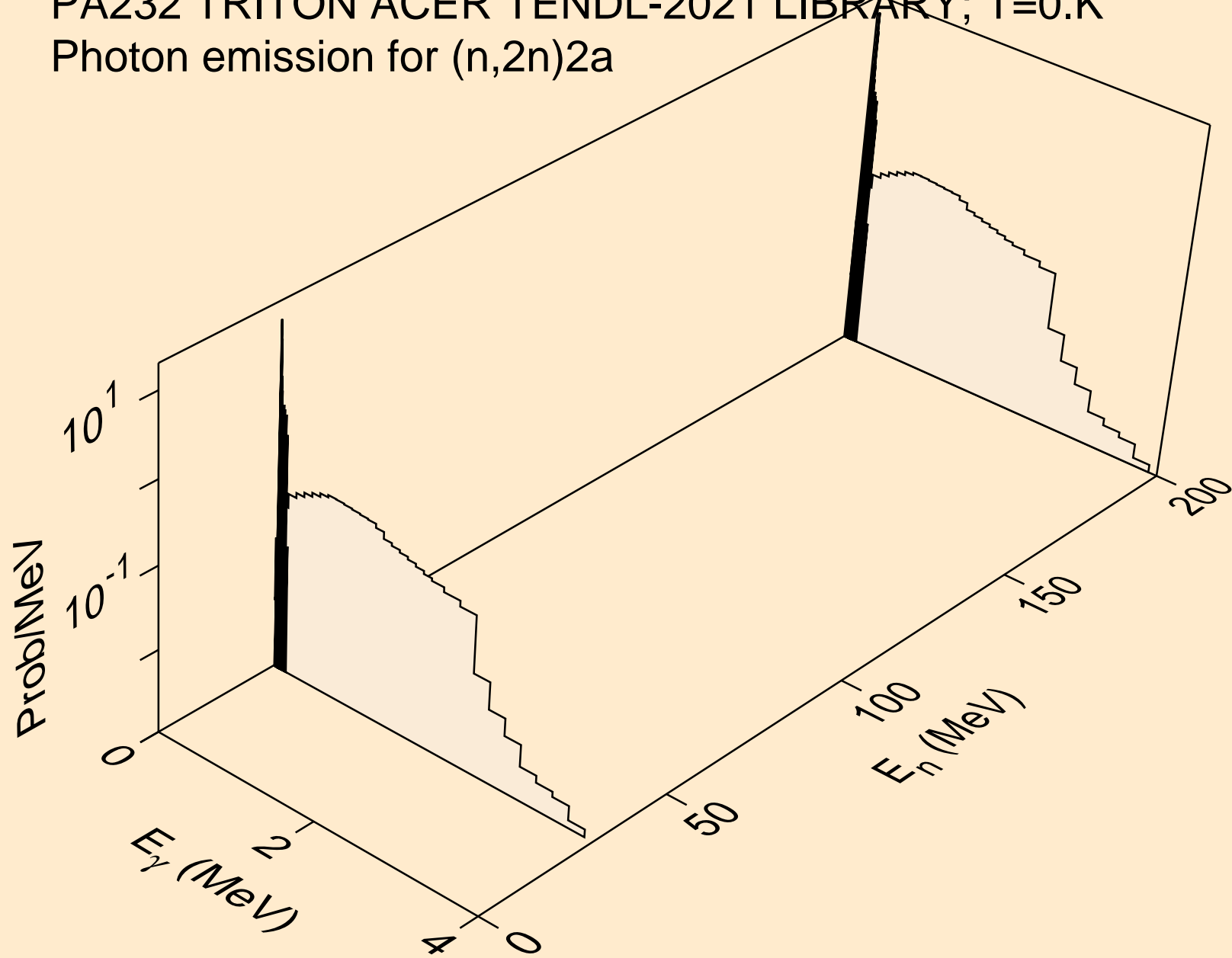

PA232 TRITON ACER TENDL-2021 LIBRARY; T=0.K  
Photon emission for (n,n\*)d

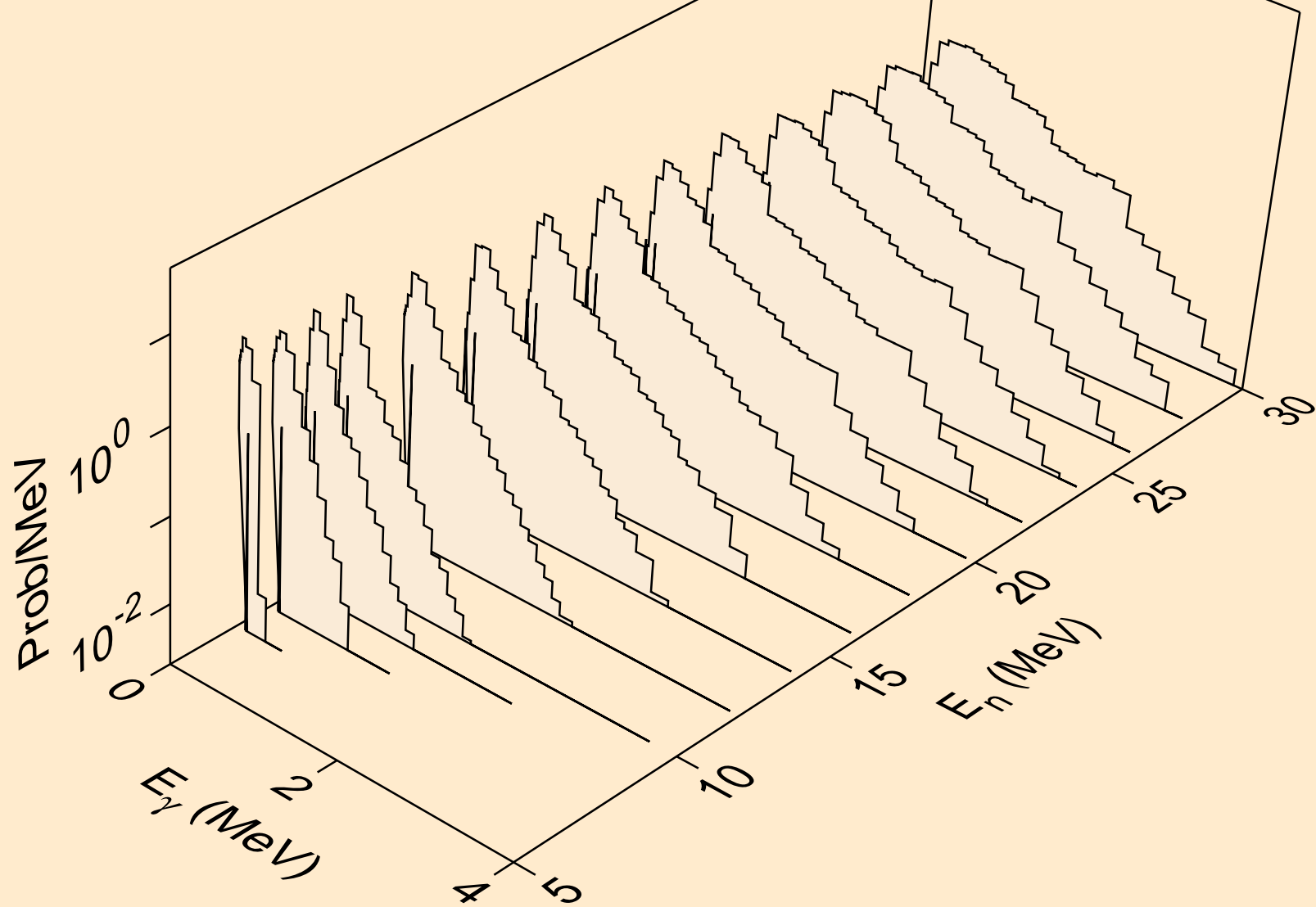

PA232 TRITON ACER TENDL-2021 LIBRARY; T=0.K  
Photon emission for (n,n\*)t

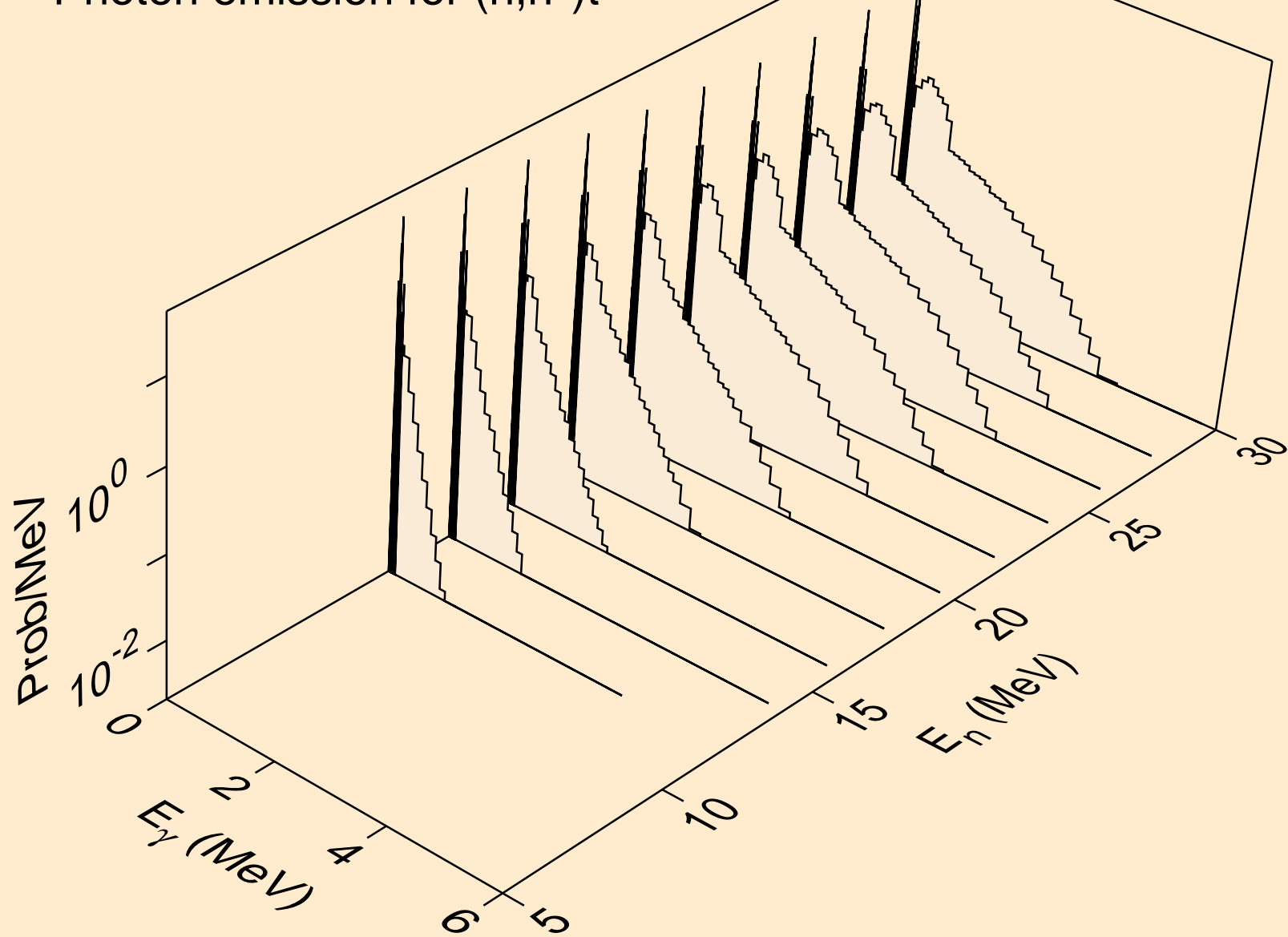

PA232 TRITON ACER TENDL-2021 LIBRARY; T=0.K  
Photon emission for (n,n\*)he3

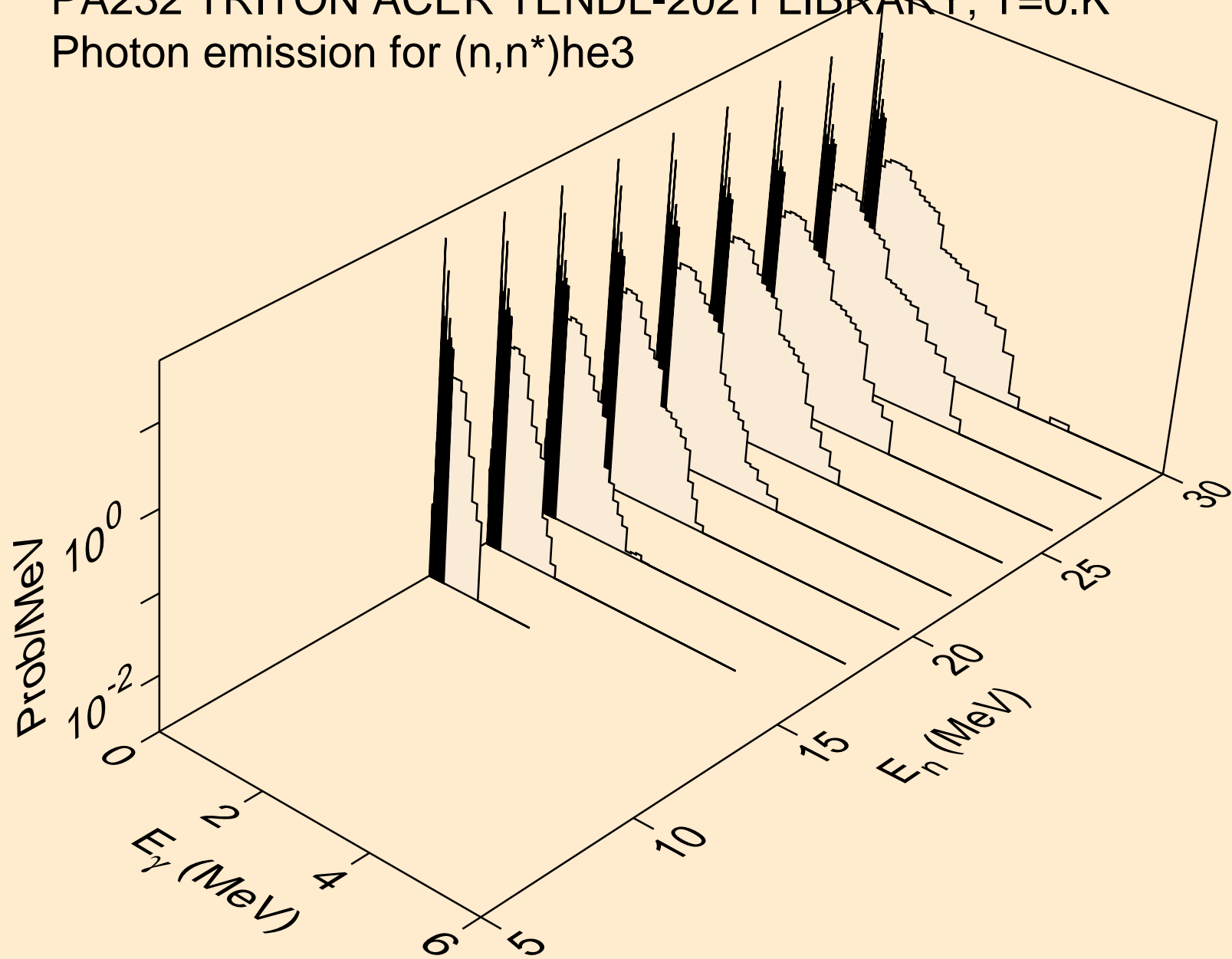

PA232 TRITON ACER TENDL-2021 LIBRARY; T=0.K  
Photon emission for (n,4n)

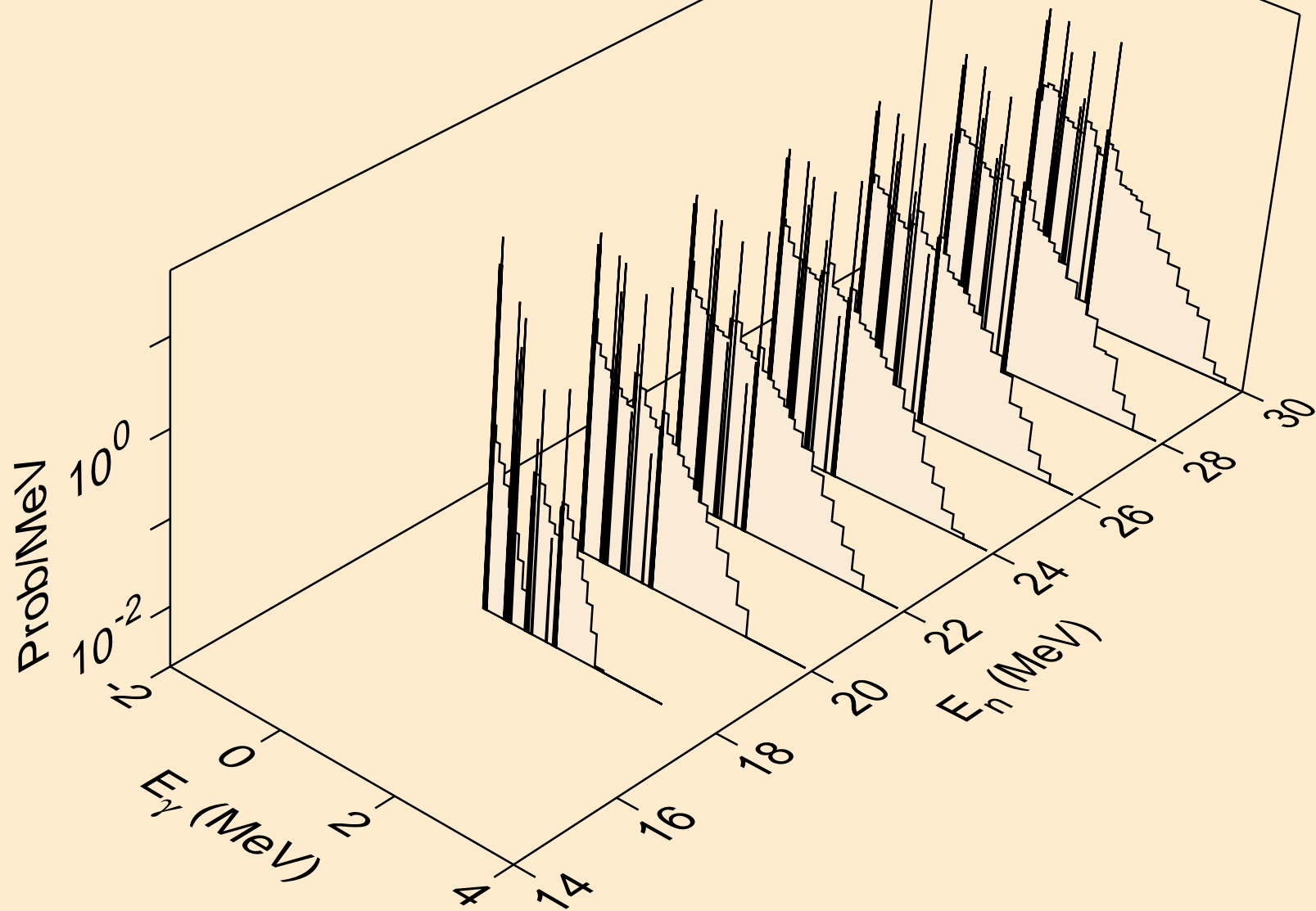

PA232 TRITON ACER TENDL-2021 LIBRARY; T=0.K  
Photon emission for (n,2np)

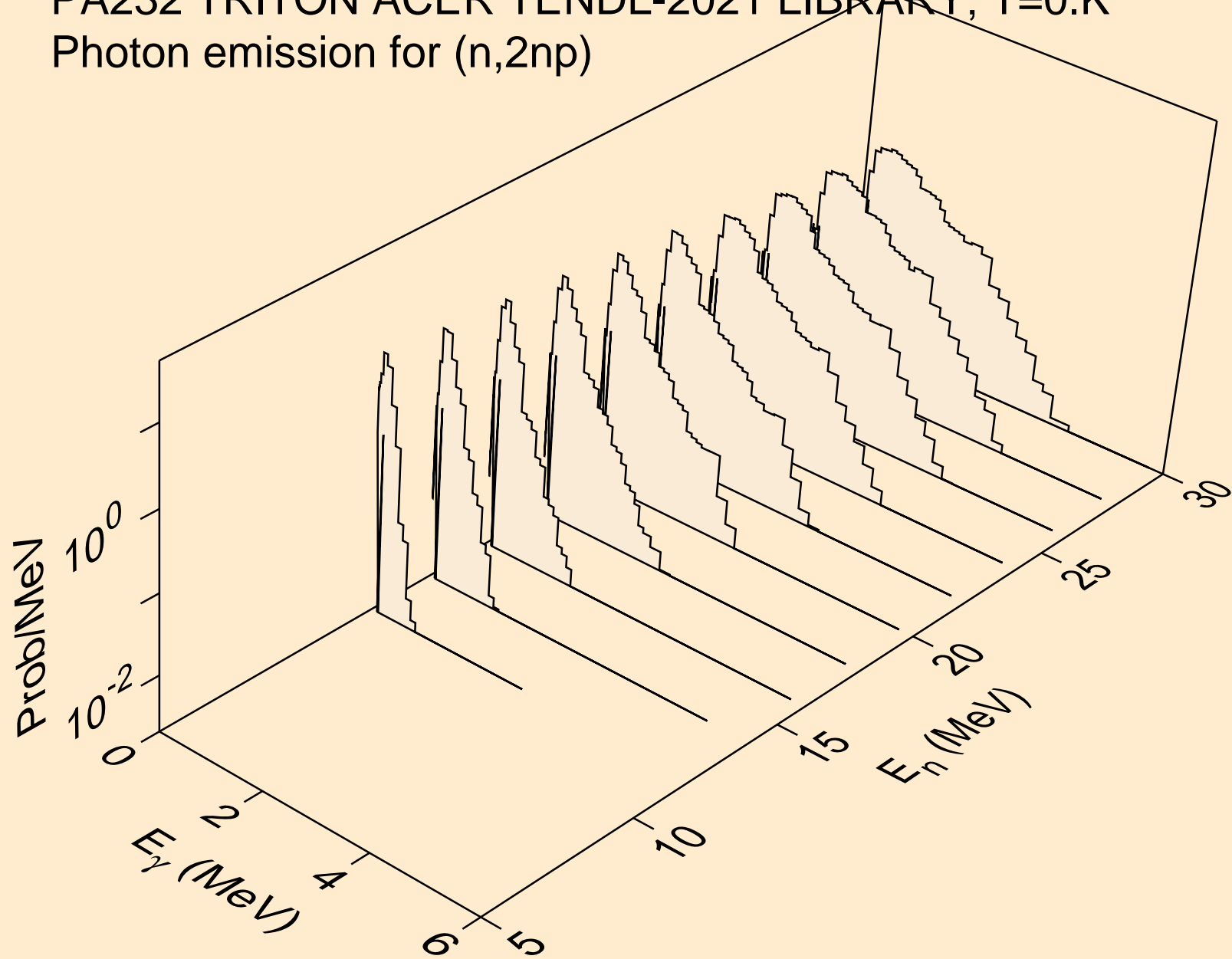

PA232 TRITON ACER TENDL-2021 LIBRARY; T=0.K  
Photon emission for (n,3np)

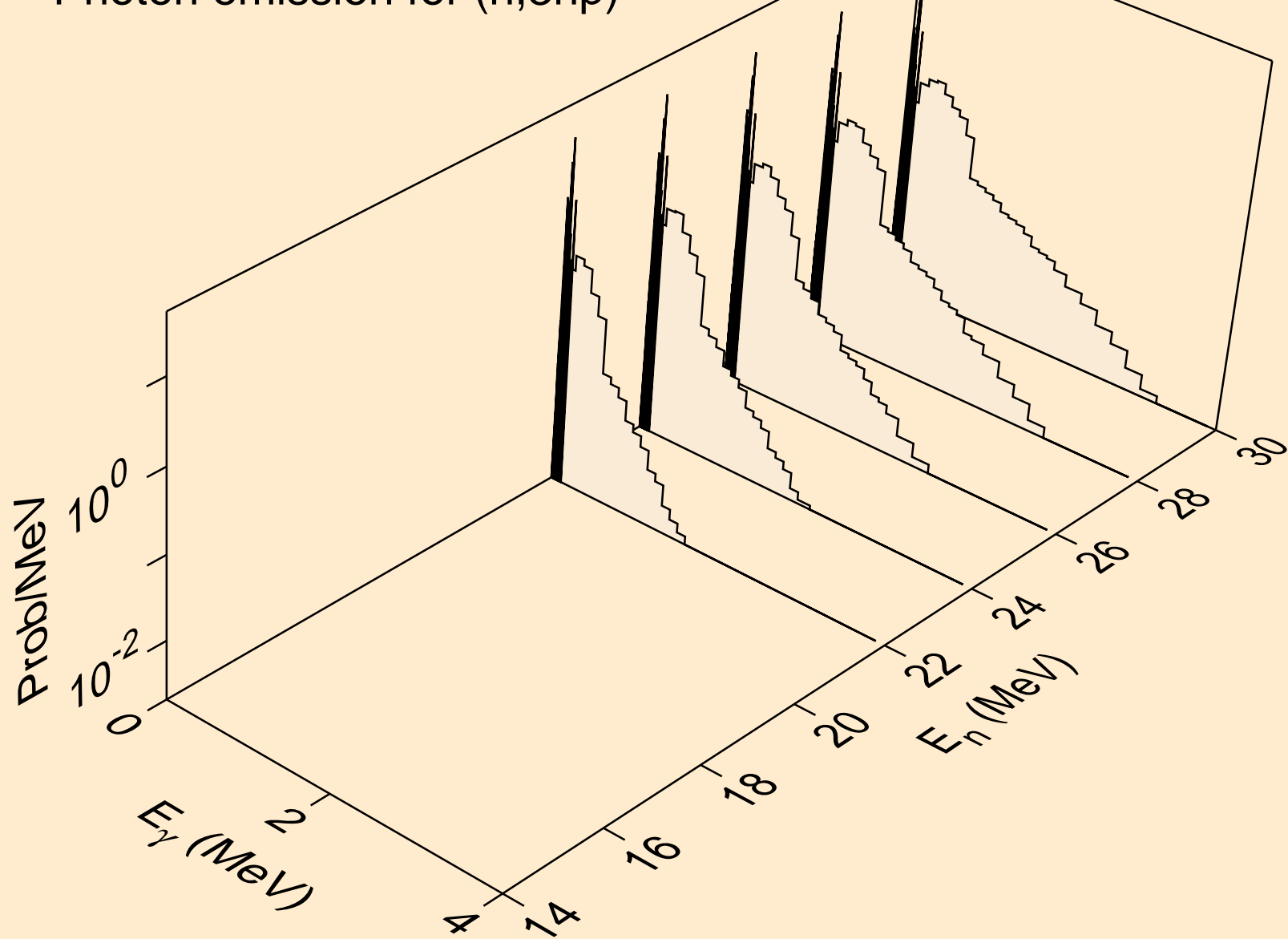

PA232 TRITON ACER TENDL-2021 LIBRARY; T=0.K  
Photon emission for (n,2np)

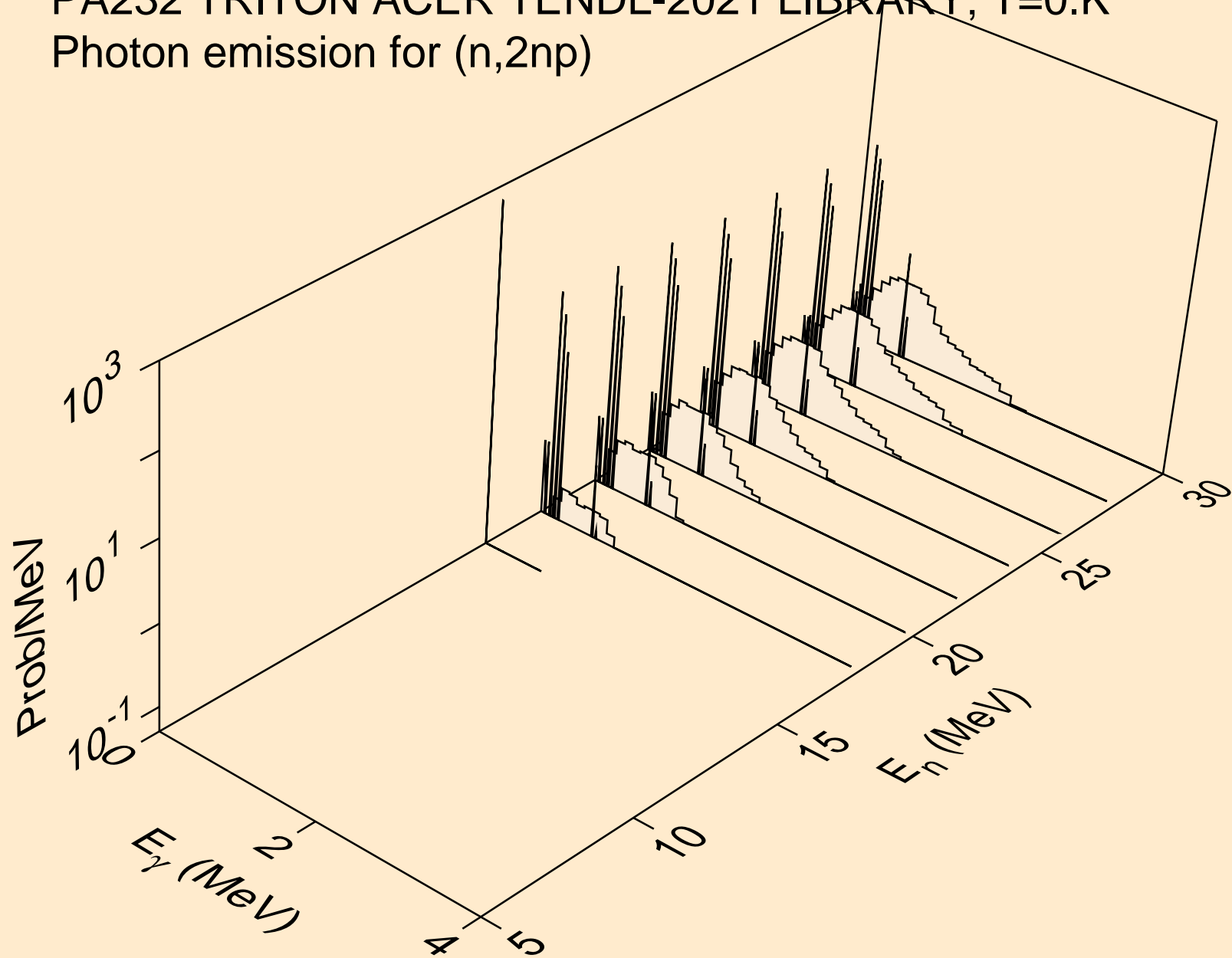



PA232 TRITON ACER TENDL-2021 LIBRARY; T=0.K  
Photon emission for (n,npa)

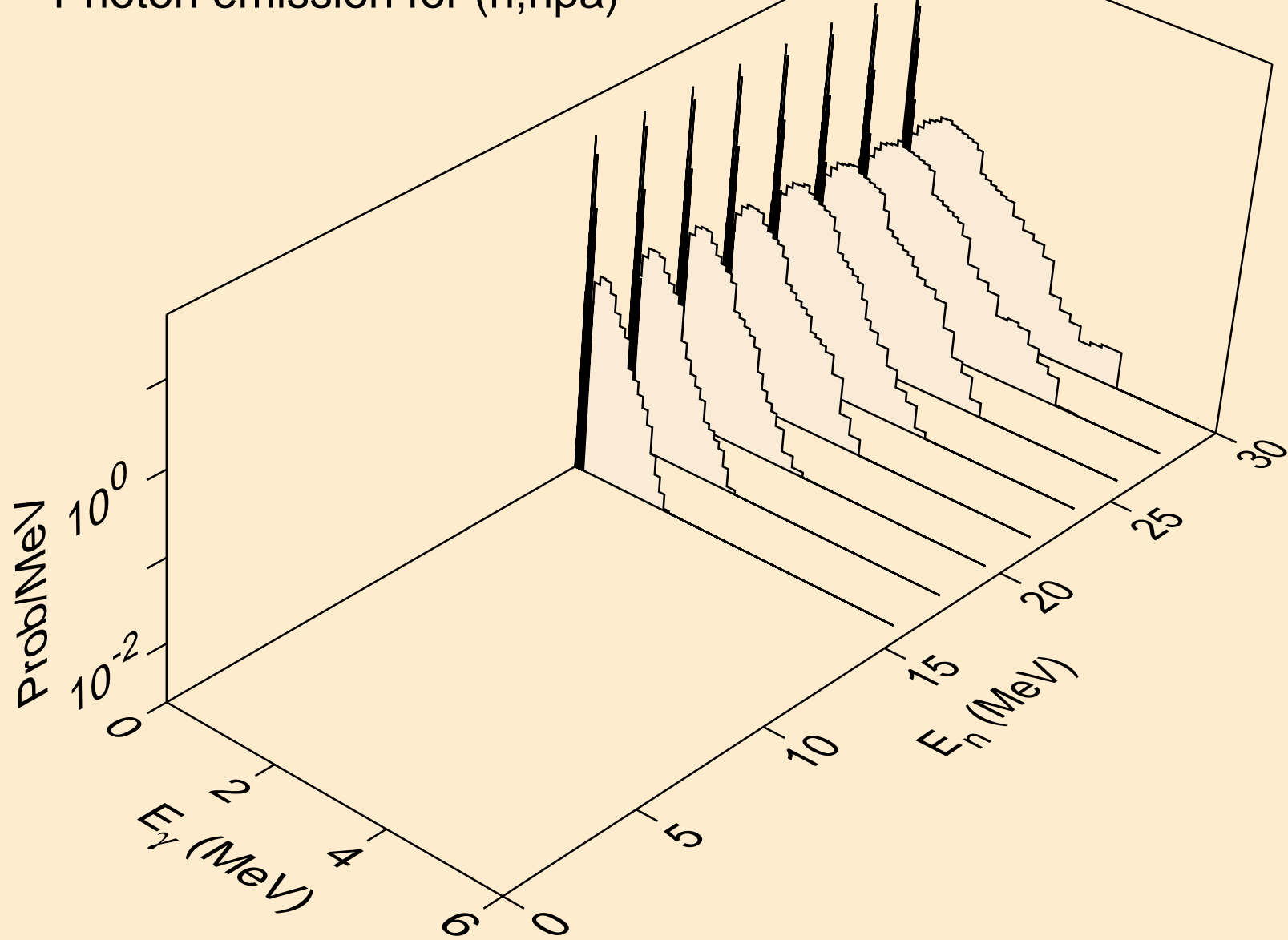

PA232 TRITON ACER TENDL-2021 LIBRARY; T=0.K  
Photon emission for (n,gma)

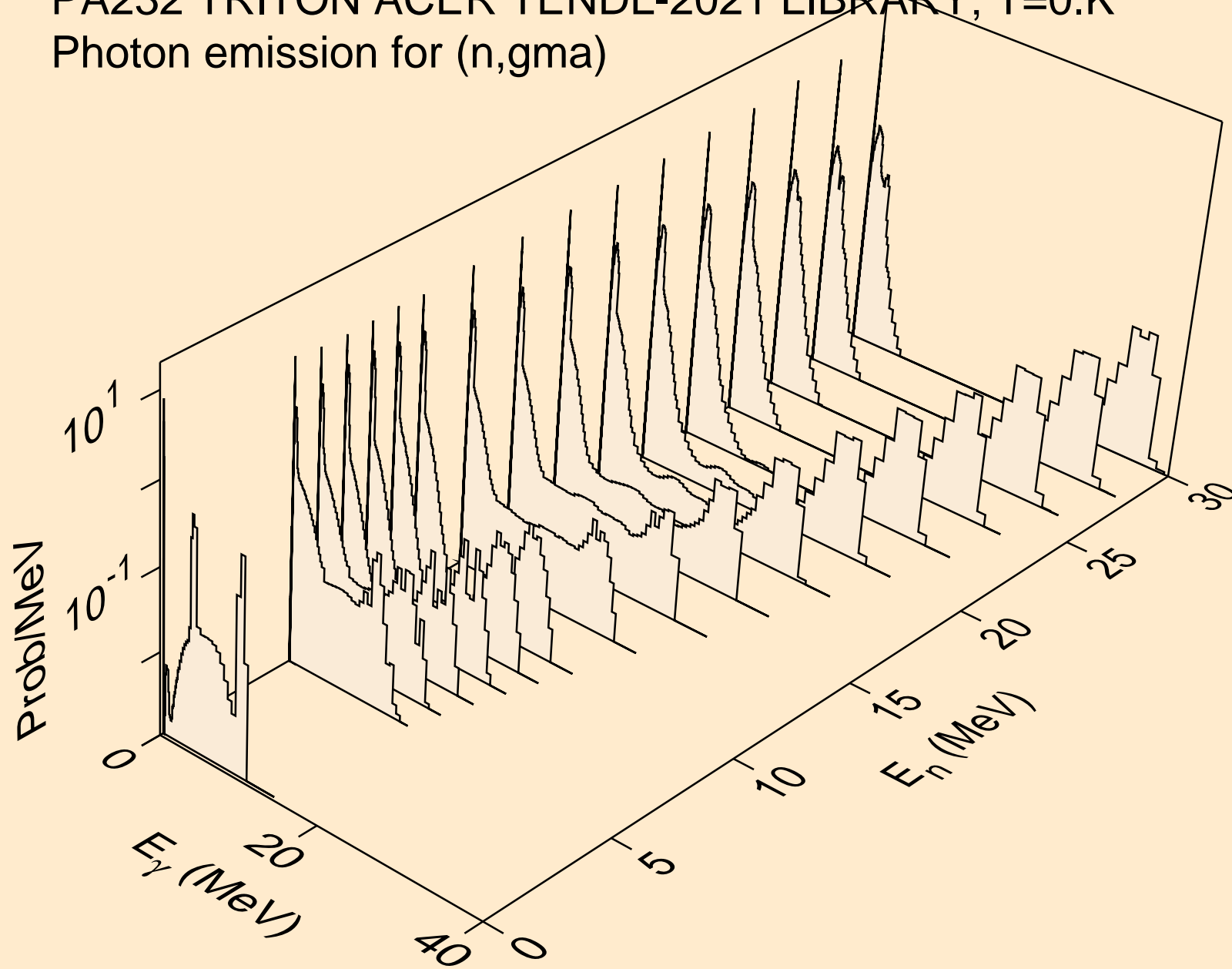

PA232 TRITON ACER TENDL-2021 LIBRARY; T=0.K  
Photon emission for (n,p)

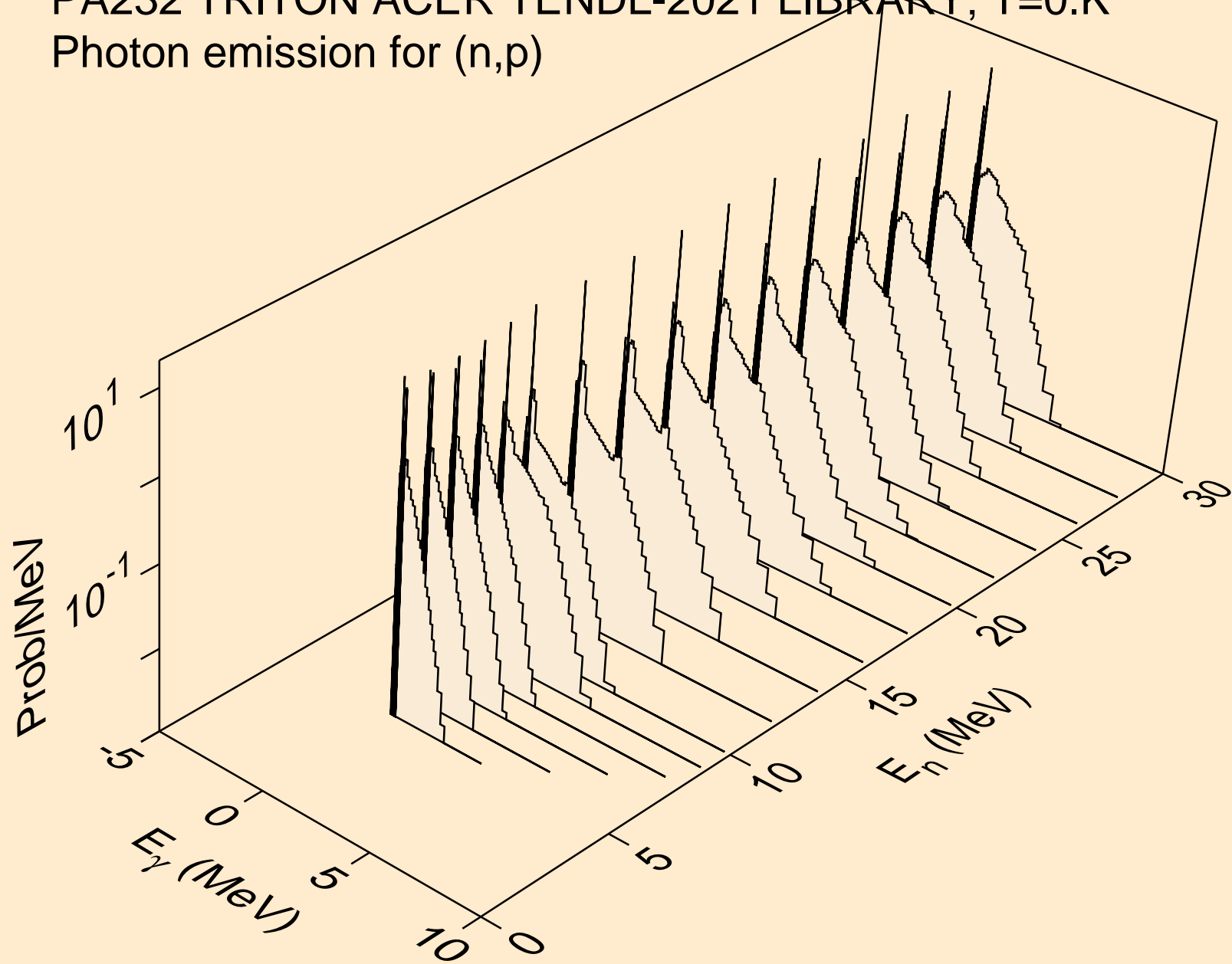

PA232 TRITON ACER TENDL-2021 LIBRARY; T=0.K  
Photon emission for (n,d)

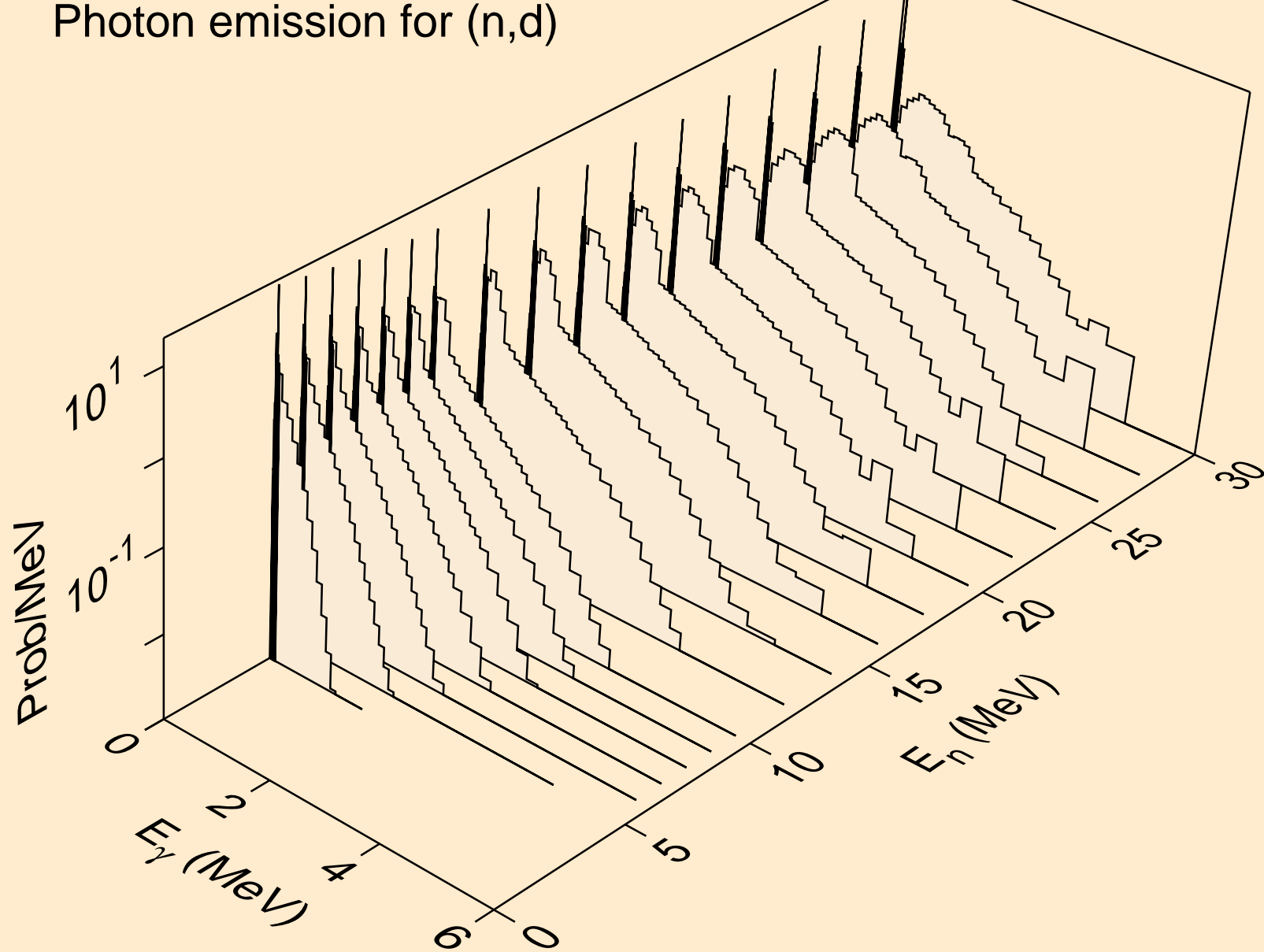

PA232 TRITON ACER TENDL-2021 LIBRARY; T=0.K  
Photon emission for inelastic

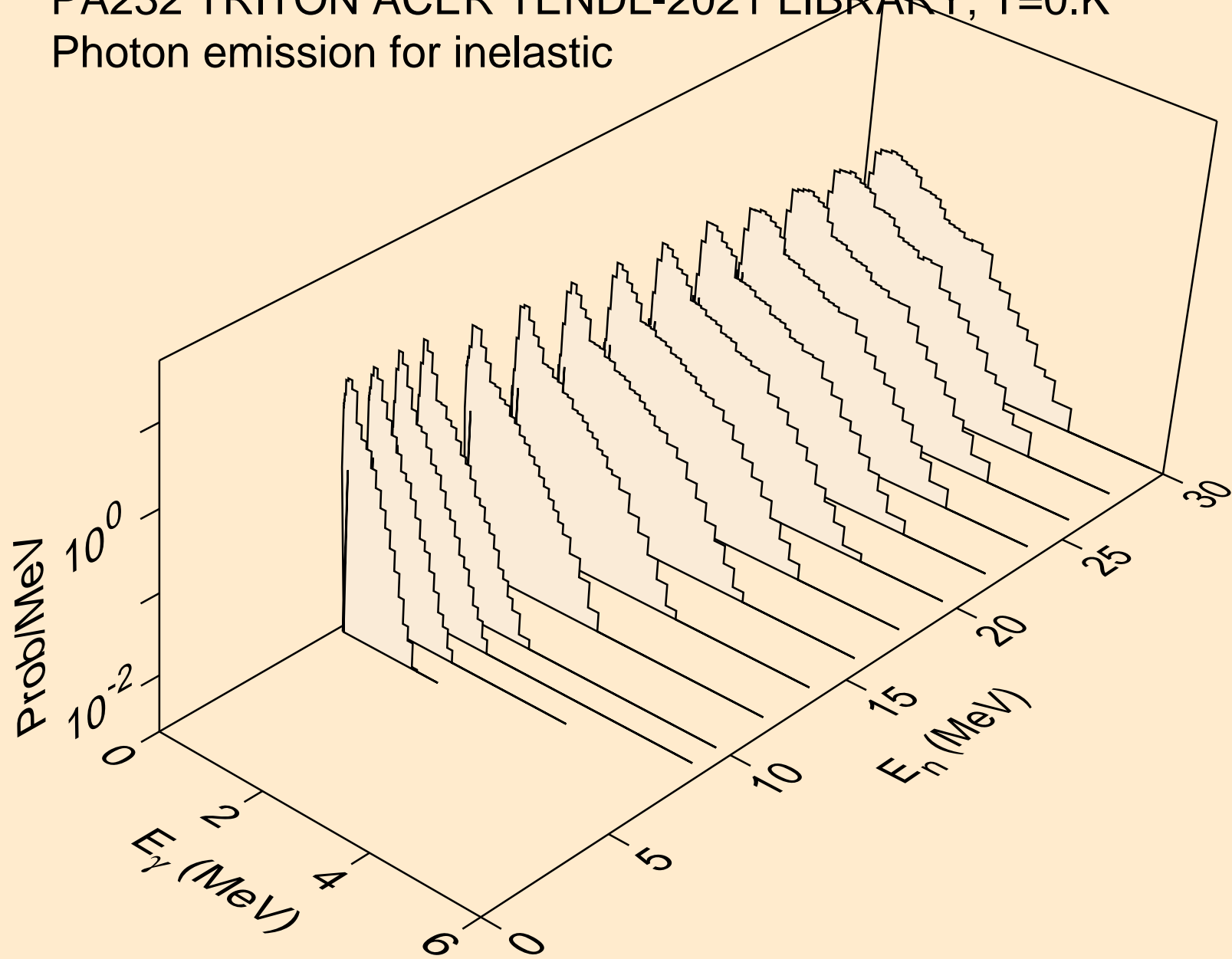

PA232 TRITON ACER TENDL-2021 LIBRARY; T=0.K  
Photon emission for (n,he3)

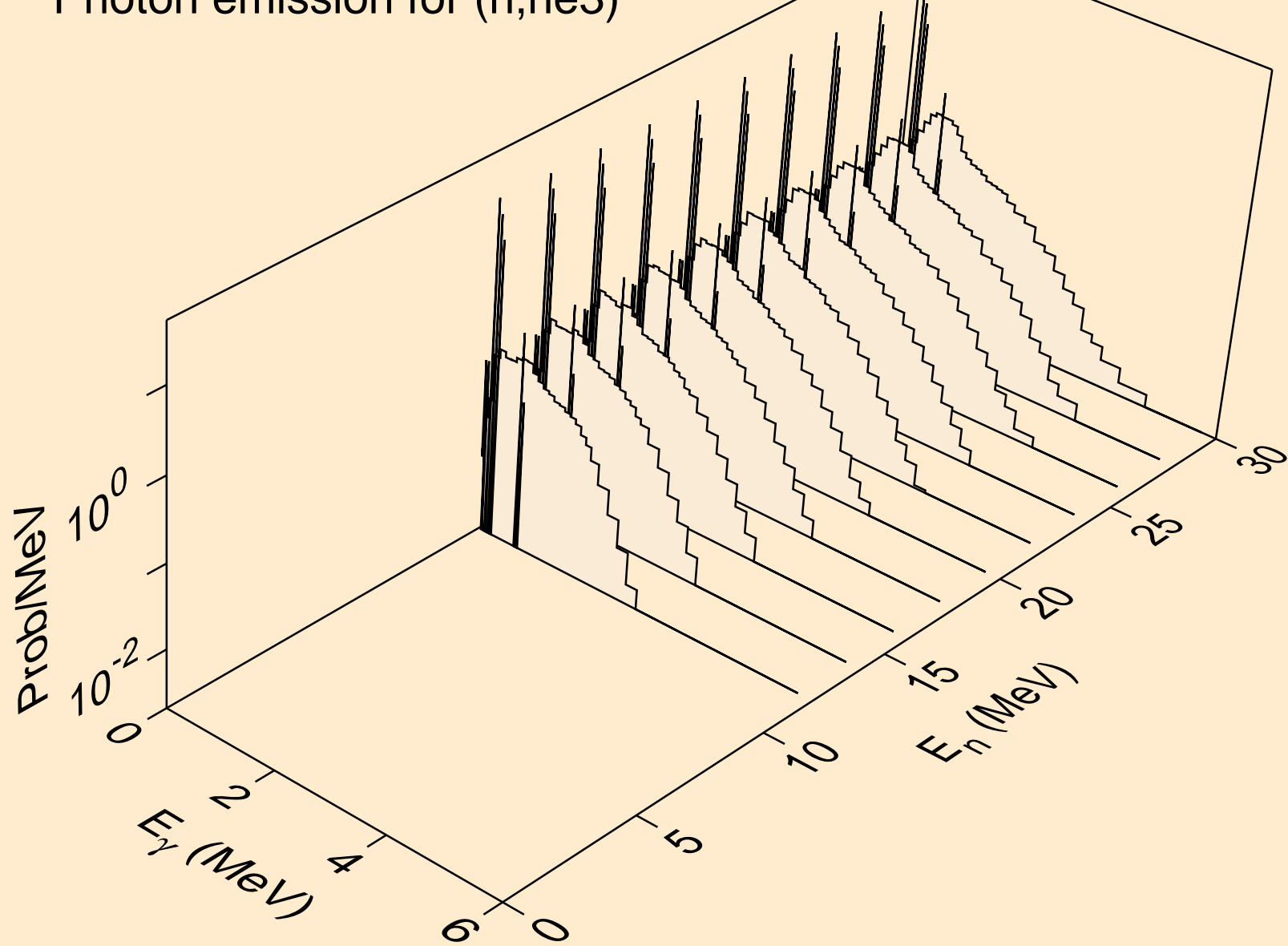

PA232 TRITON ACER TENDL-2021 LIBRARY; T=0.K  
Photon emission for (n,a)

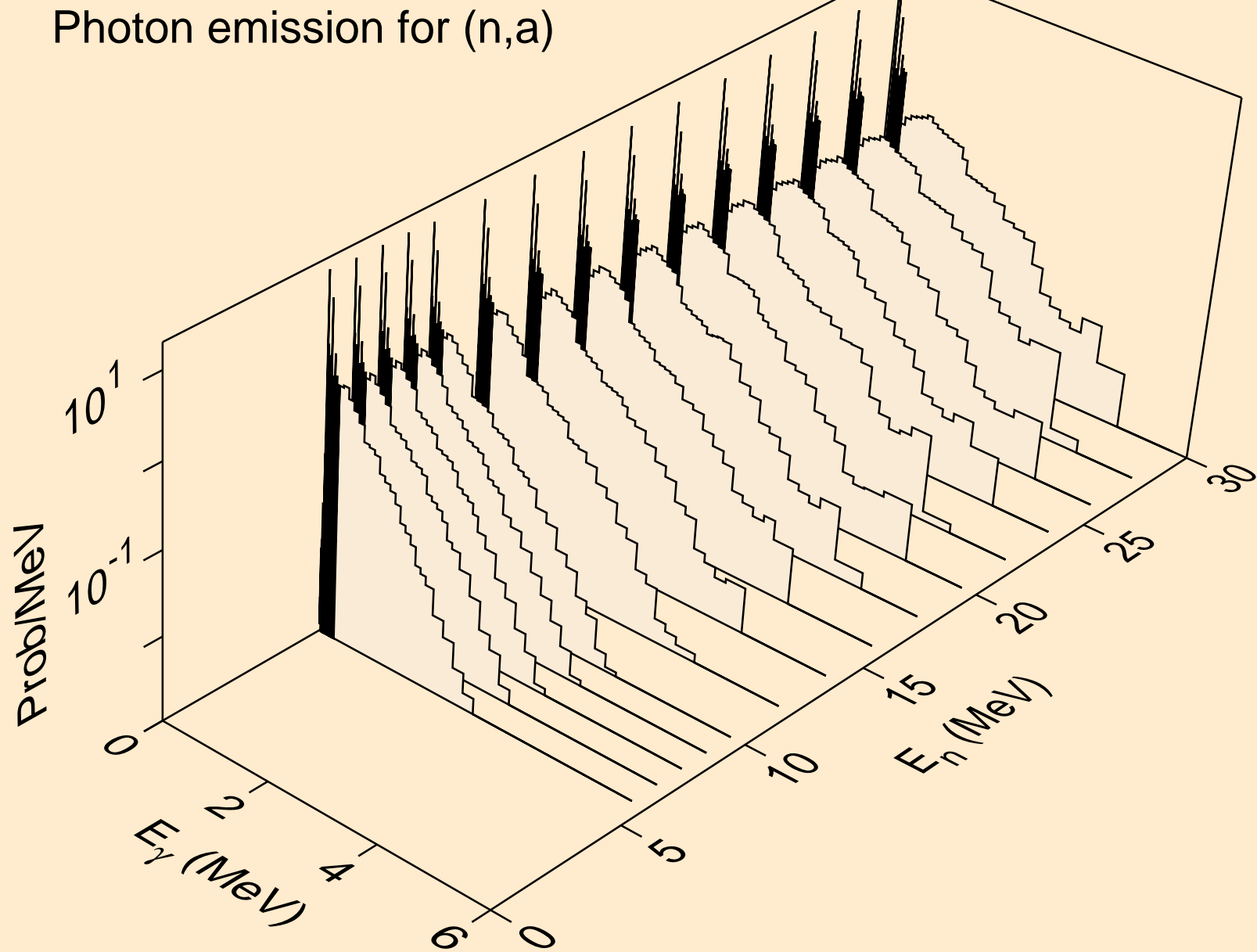

PA232 TRITON ACER TENDL-2021 LIBRARY; T=0.K  
Photon emission for (n,2a)

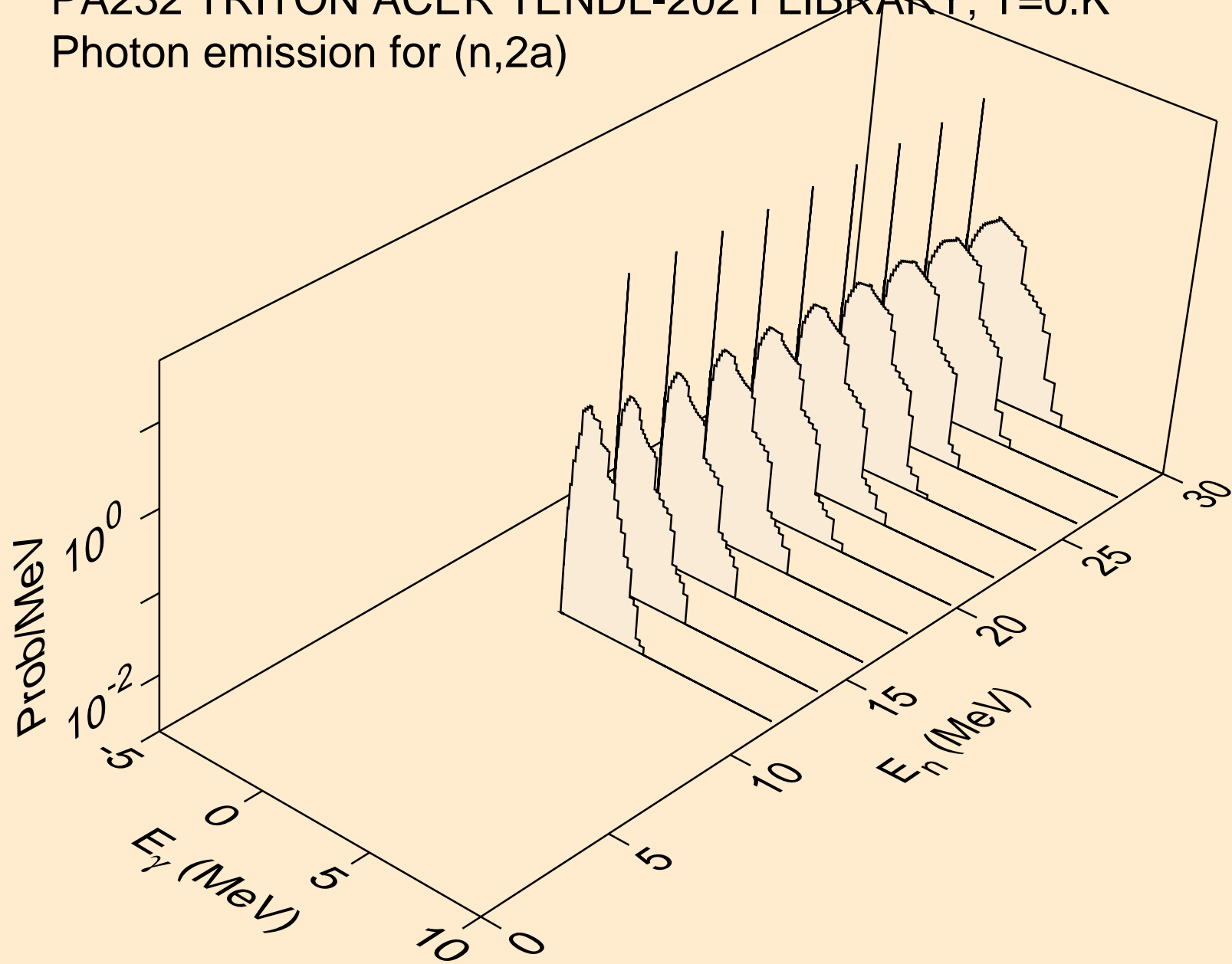



PA232 TRITON ACER TENDL-2021 LIBRARY; T=0.K  
Photon emission for (n,2p)

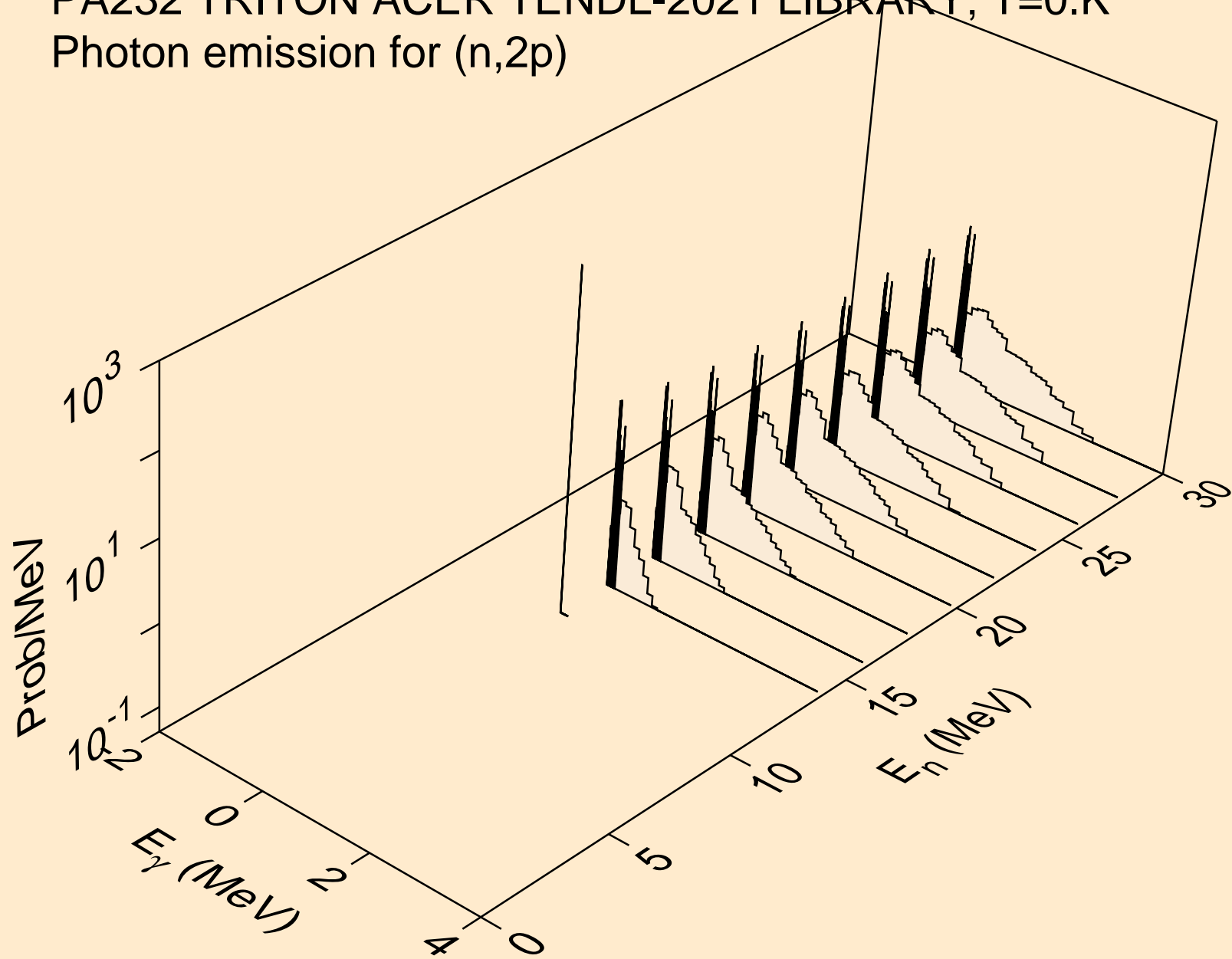

PA232 TRITON ACER TENDL-2021 LIBRARY; T=0.K  
Photon emission for (n,pa)

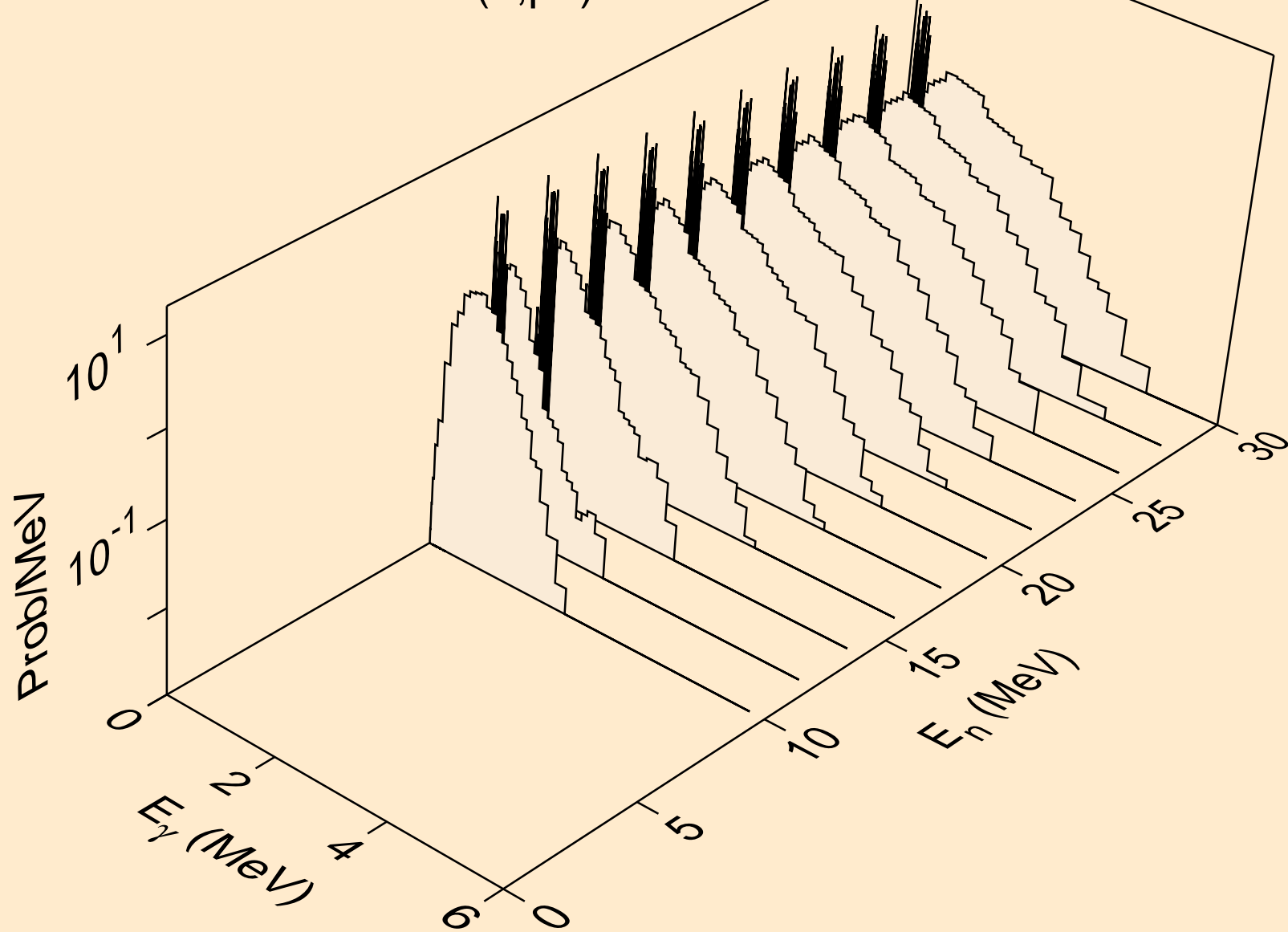

PA232 TRITON ACER TENDL-2021 LIBRARY; T=0.K  
Photon emission for (n,pd)

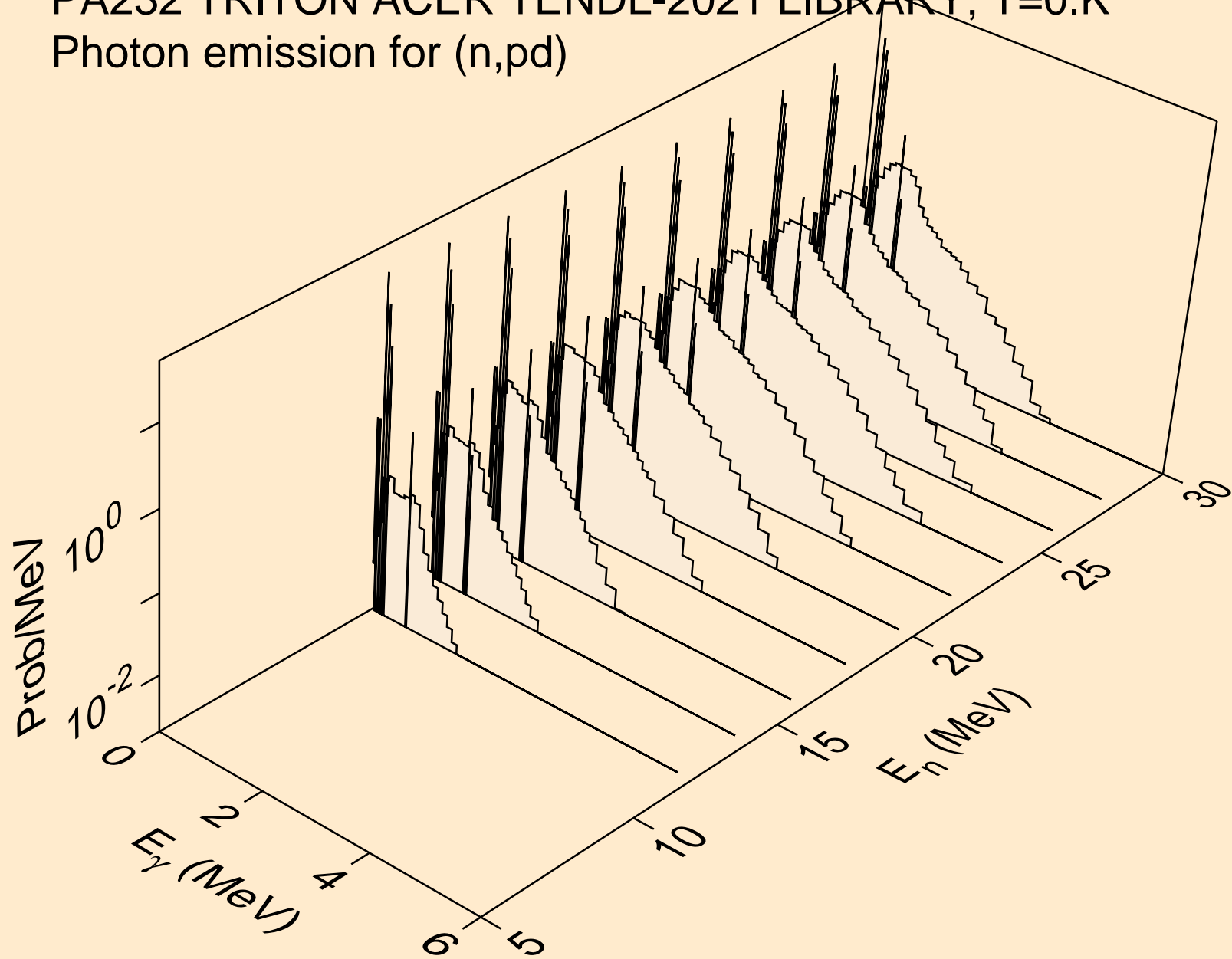

PA232 TRITON ACER TENDL-2021 LIBRARY; T=0.K  
Photon emission for (n,pt)

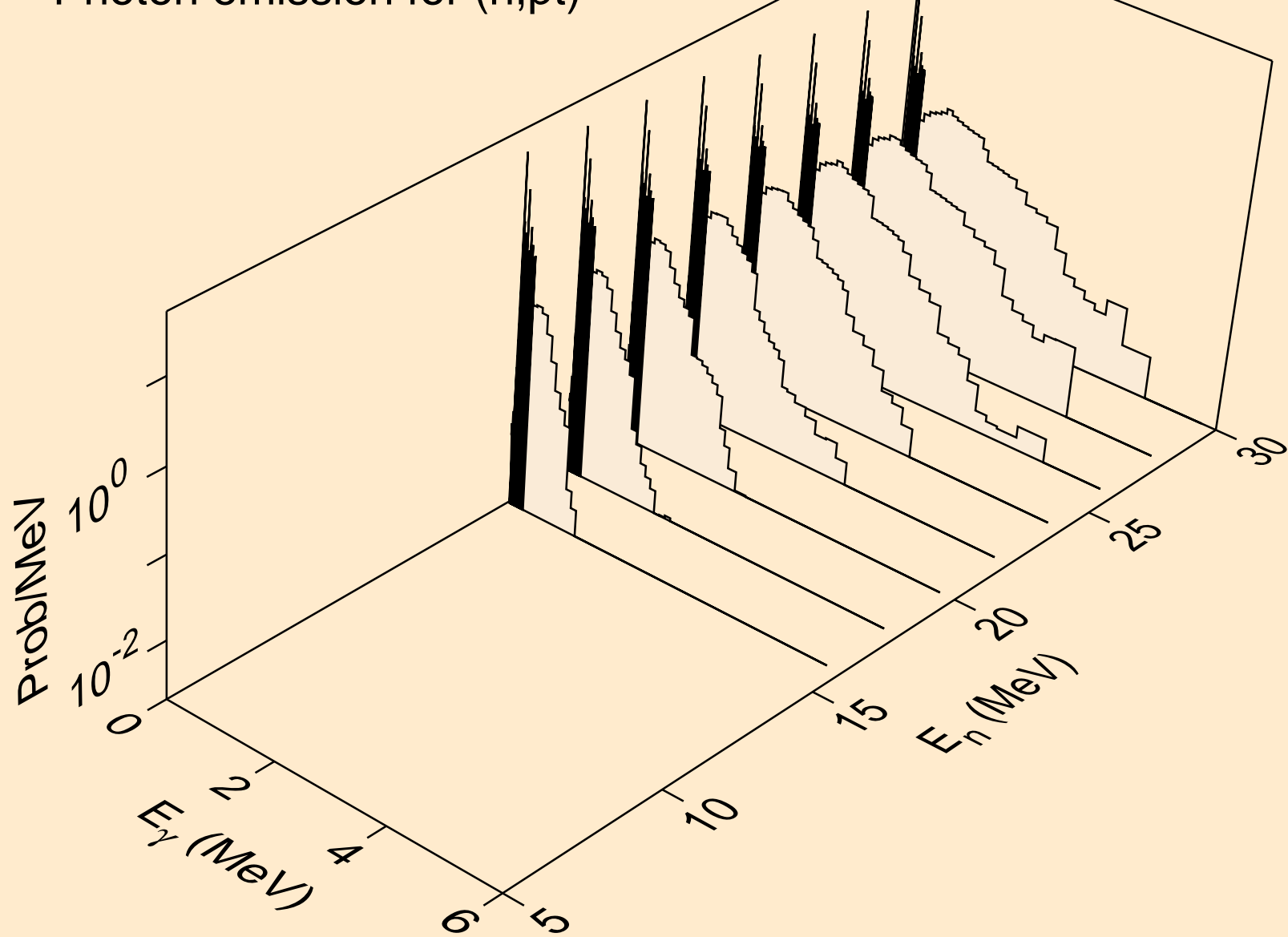

PA232 TRITON ACER TENDL-2021 LIBRARY; T=0.K  
Particle heating contributions

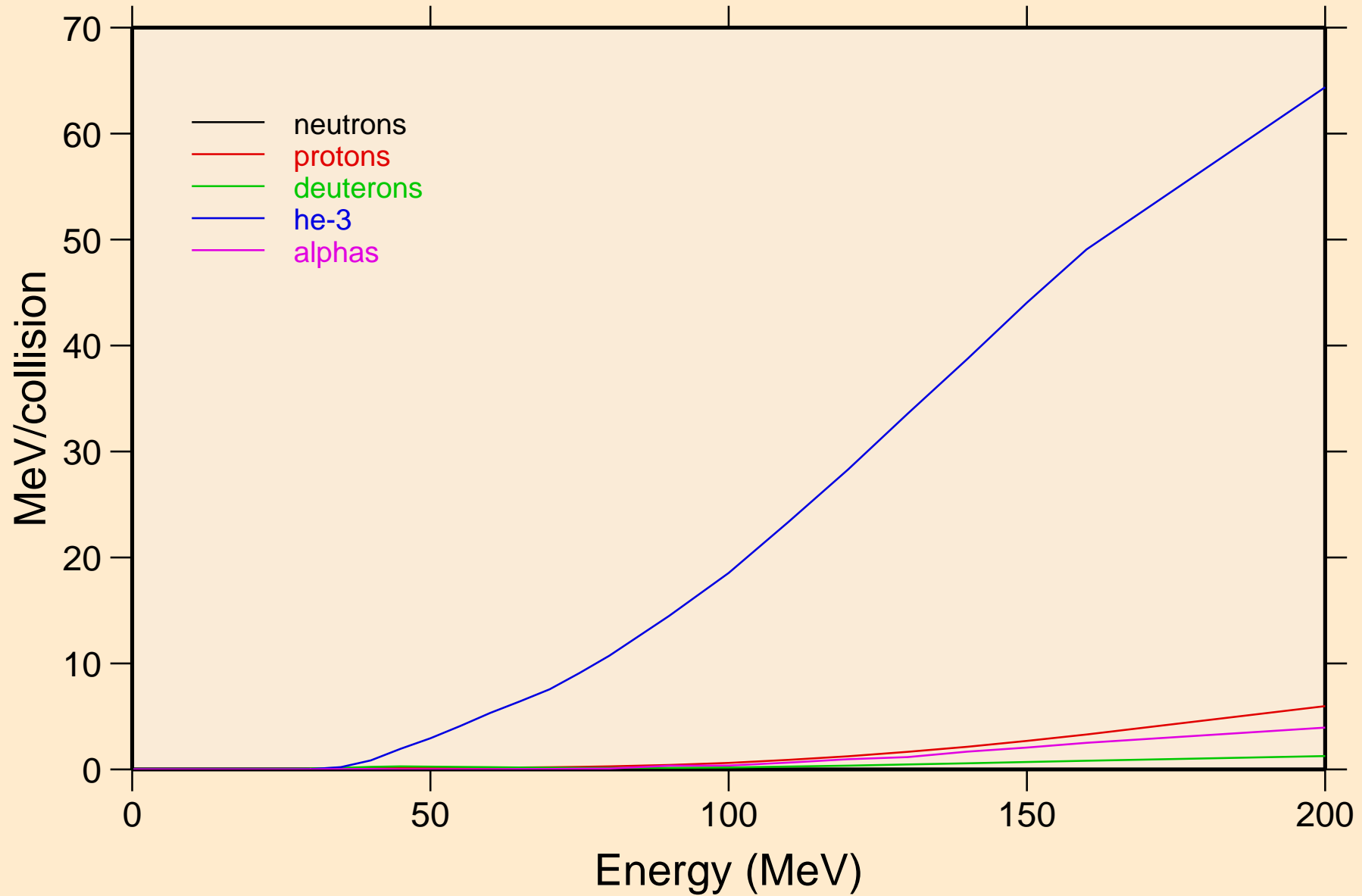

PA232 TRITON ACER TENDL-2021 LIBRARY; T=0.K  
Recoil Heating

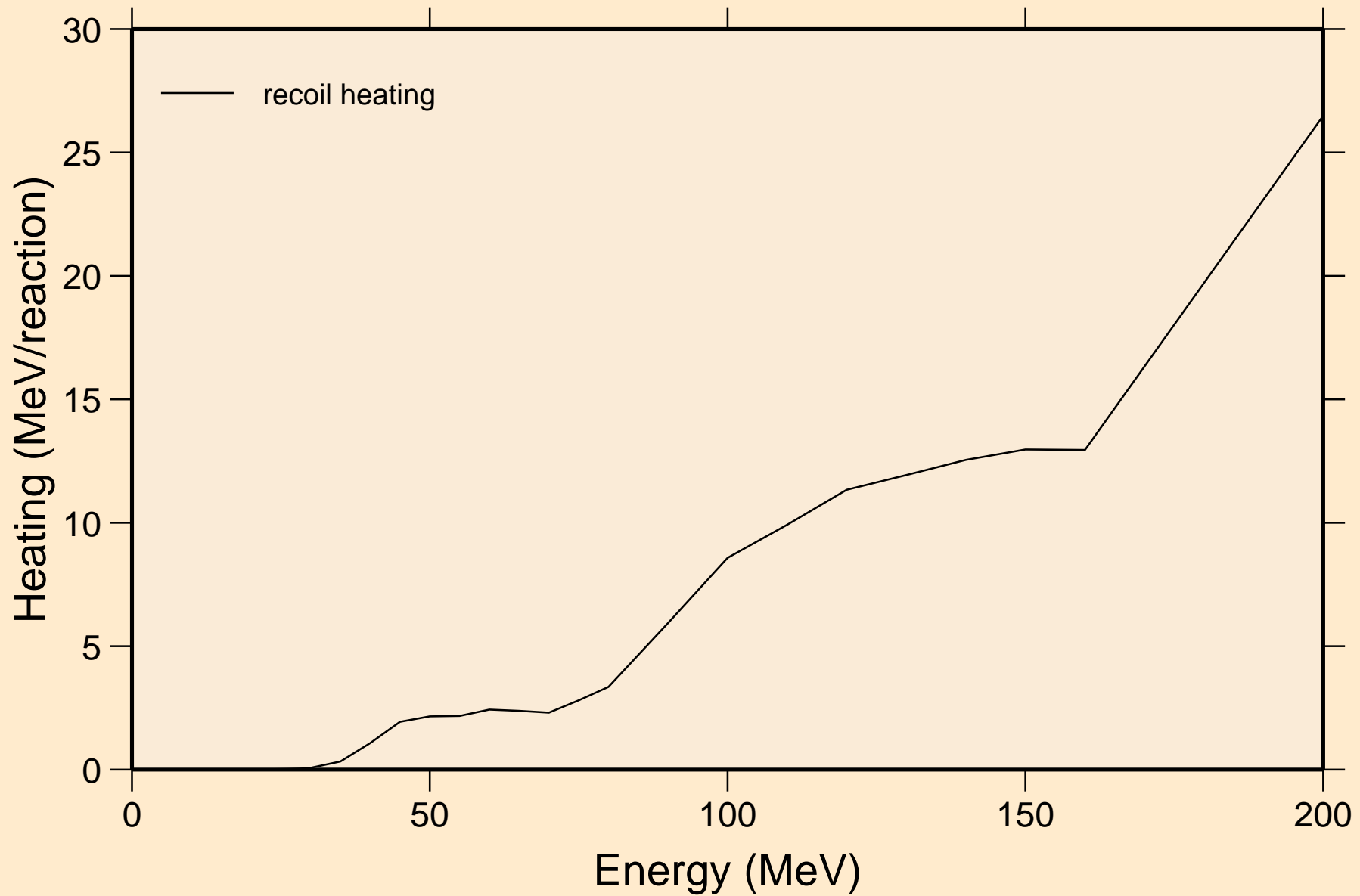

PA232 TRITON ACER TENDL-2021 LIBRARY; T=0.K  
Particle production cross sections

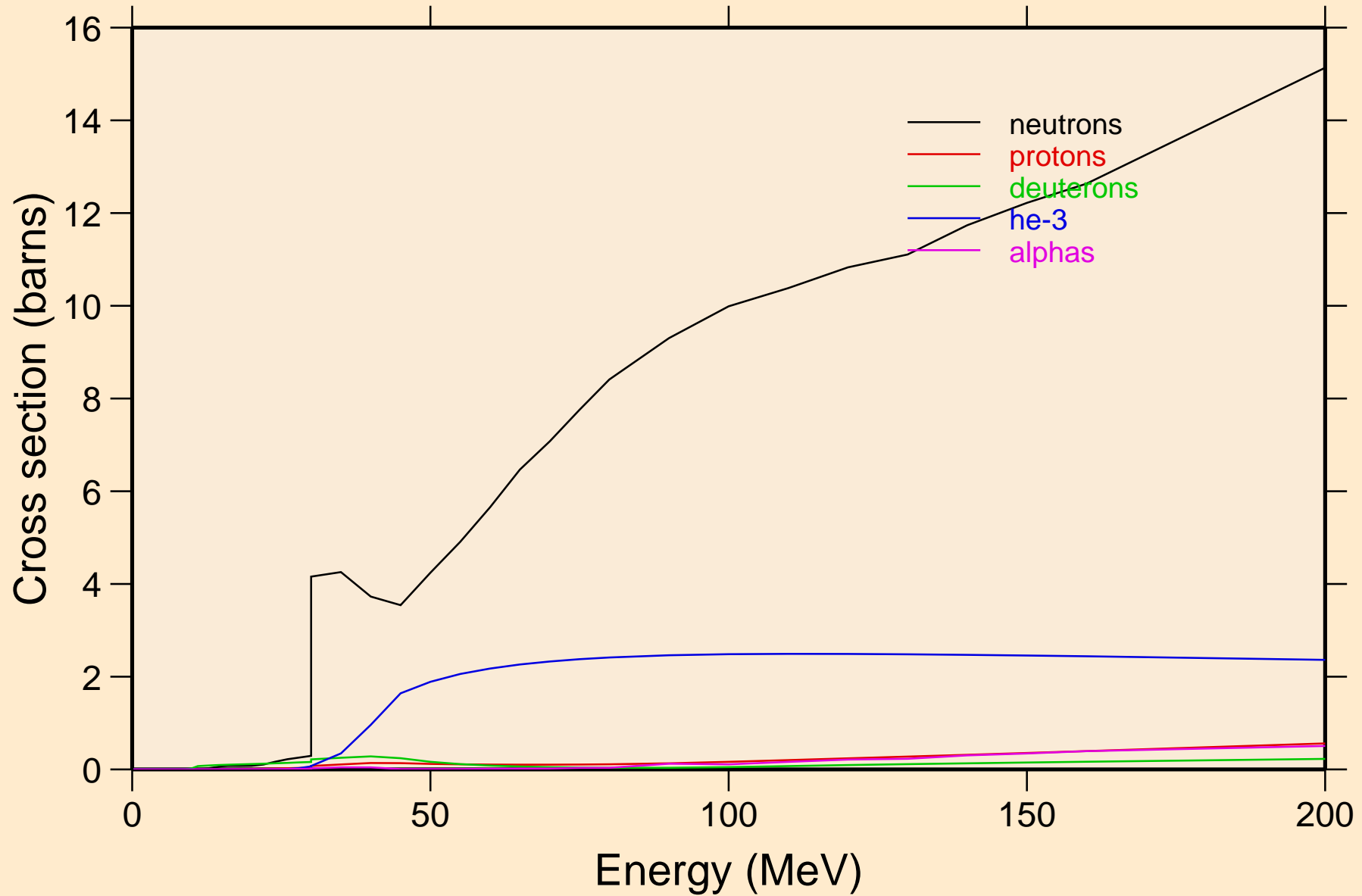

PA232 TRITON ACER TENDL-2021 LIBRARY; T=0.K  
neutrons from (t,n)

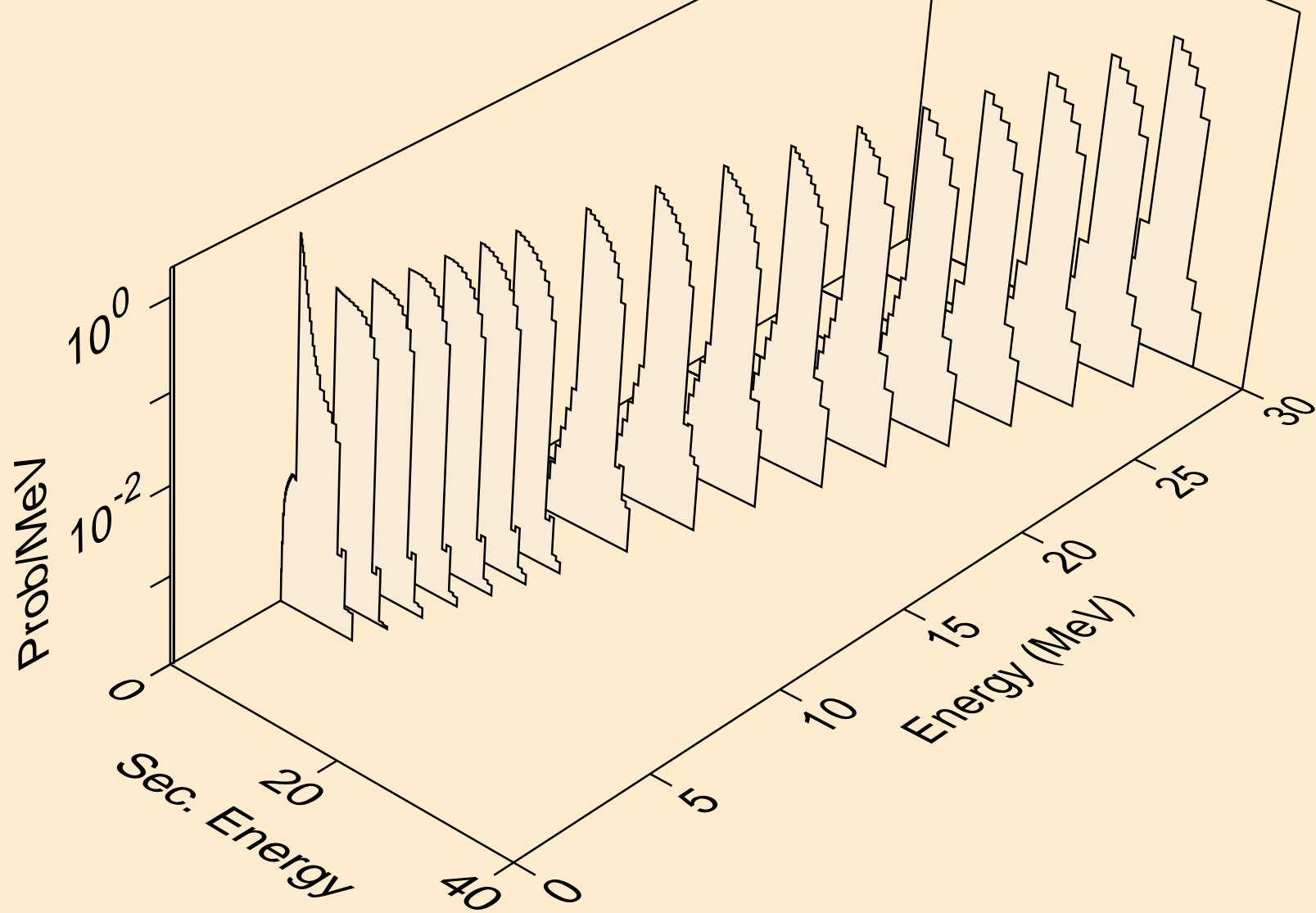



PA232 TRITON ACER TENDL-2021 LIBRARY; T=0.K  
neutrons from (t,x)

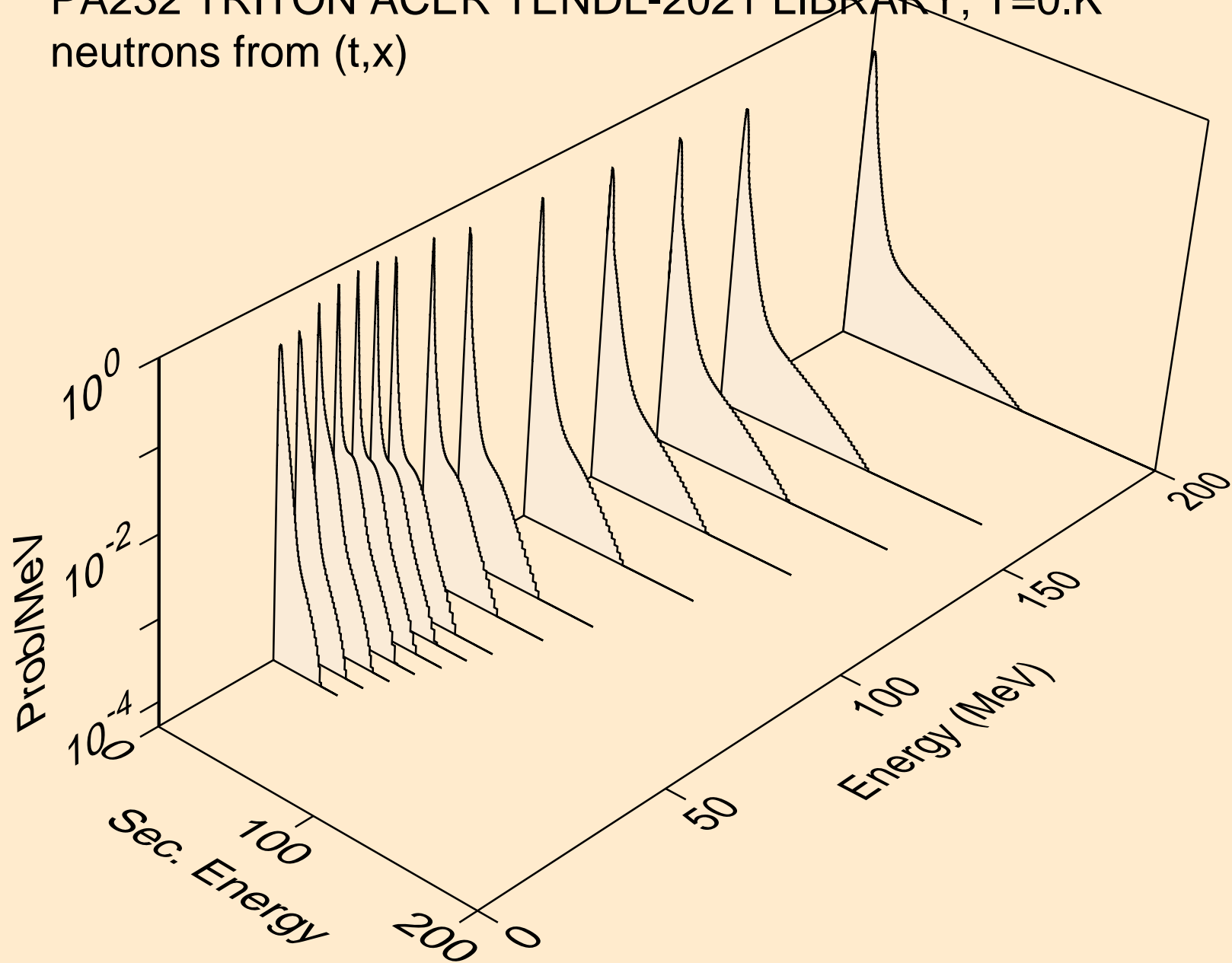

PA232 TRITON ACER TENDL-2021 LIBRARY; T=0.K  
neutrons from (t,2nd)

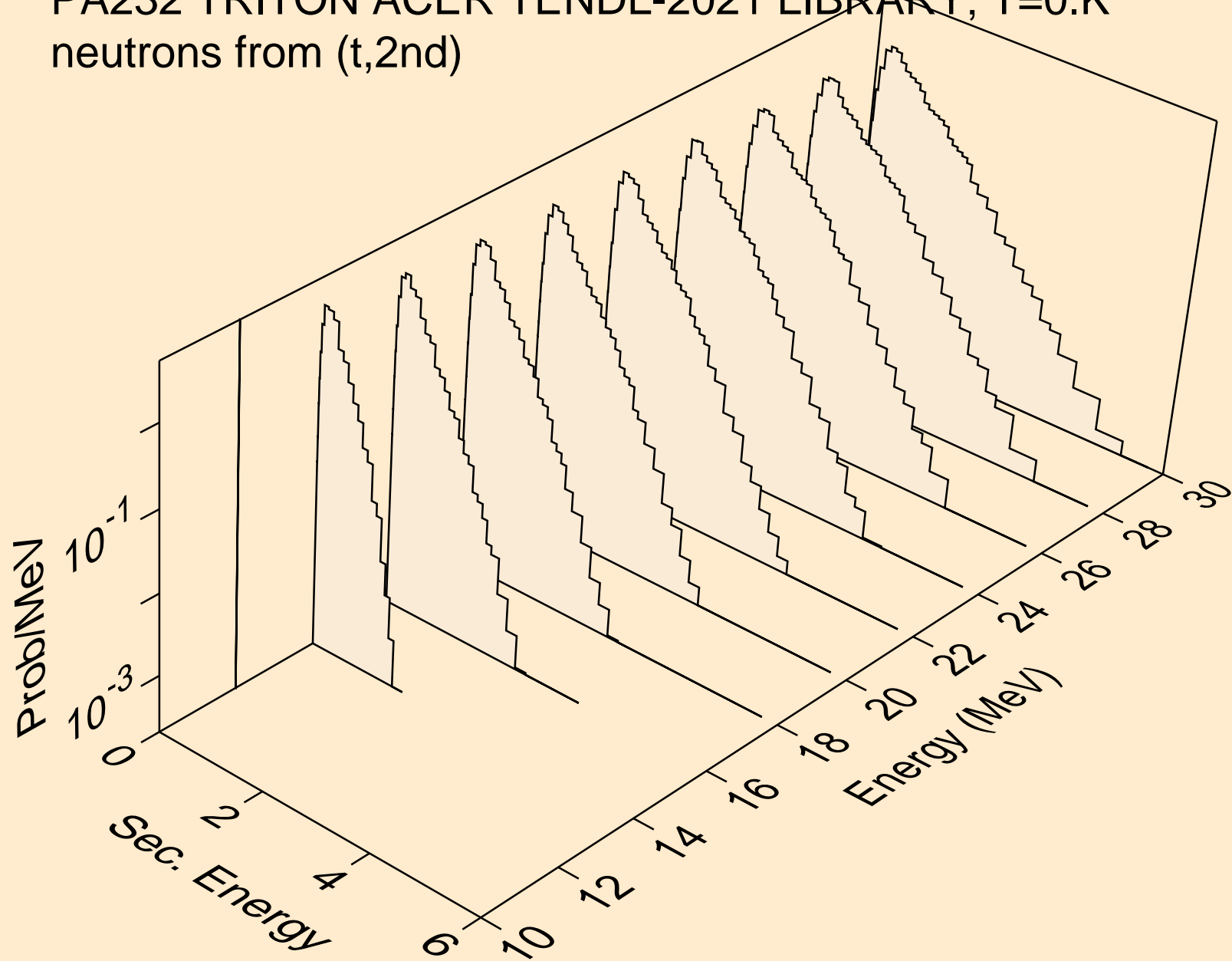

PA232 TRITON ACER TENDL-2021 LIBRARY; T=0.K  
neutrons from (t,2n)

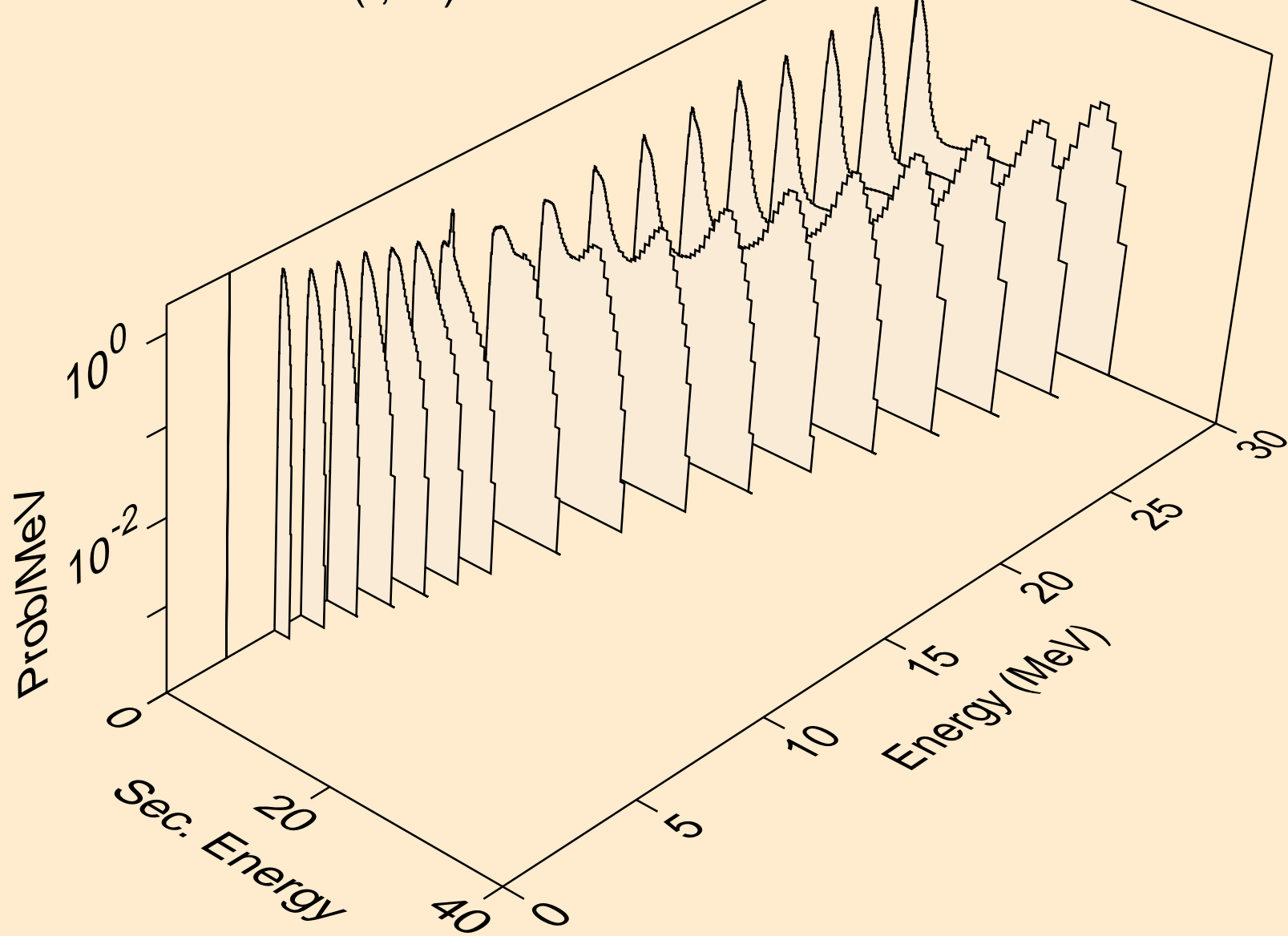

PA232 TRITON ACER TENDL-2021 LIBRARY; T=0.K  
neutrons from (t,3n)

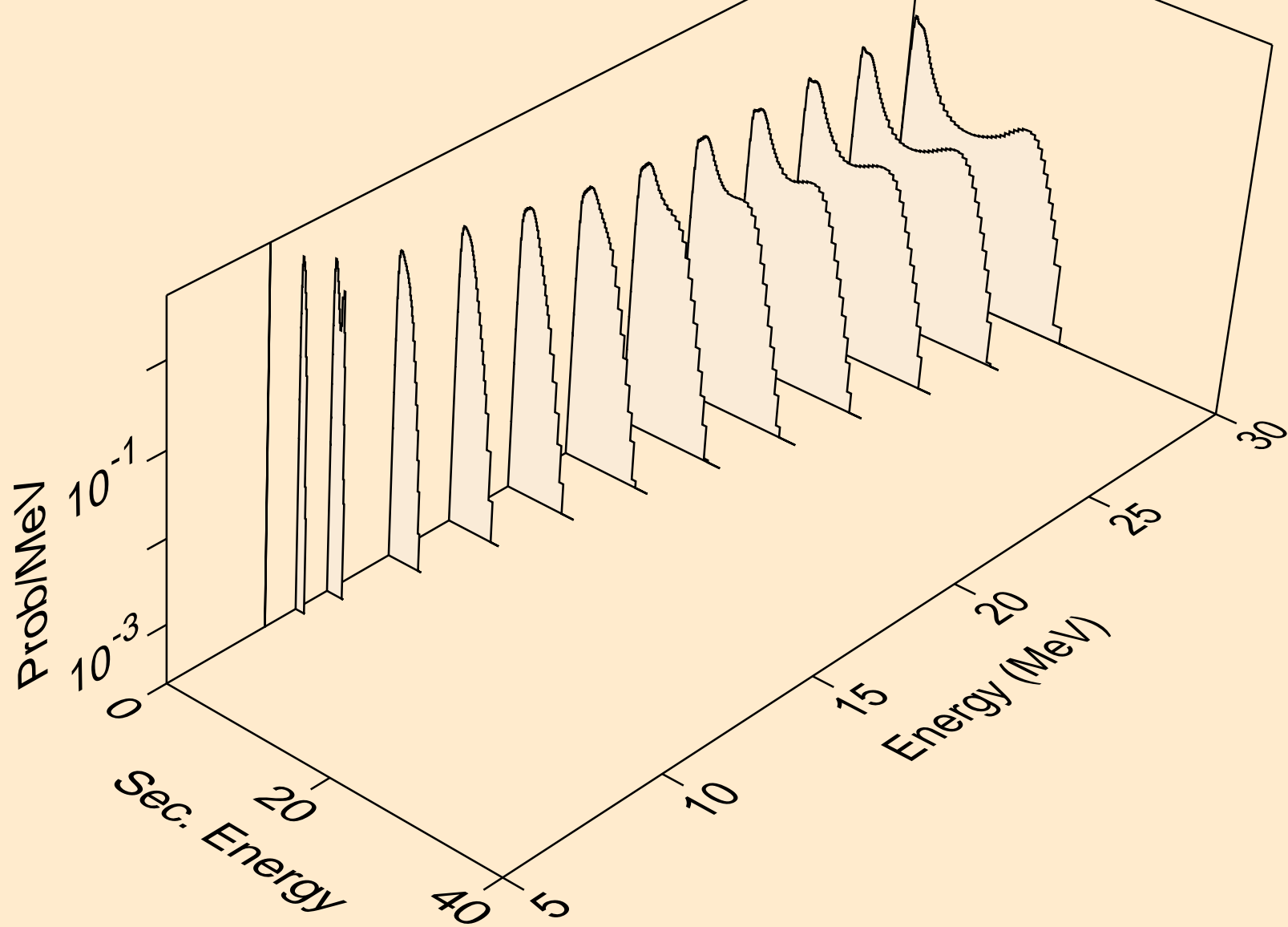

PA232 TRITON ACER TENDL-2021 LIBRARY; T=0.K  
neutrons from (t,n\*)a

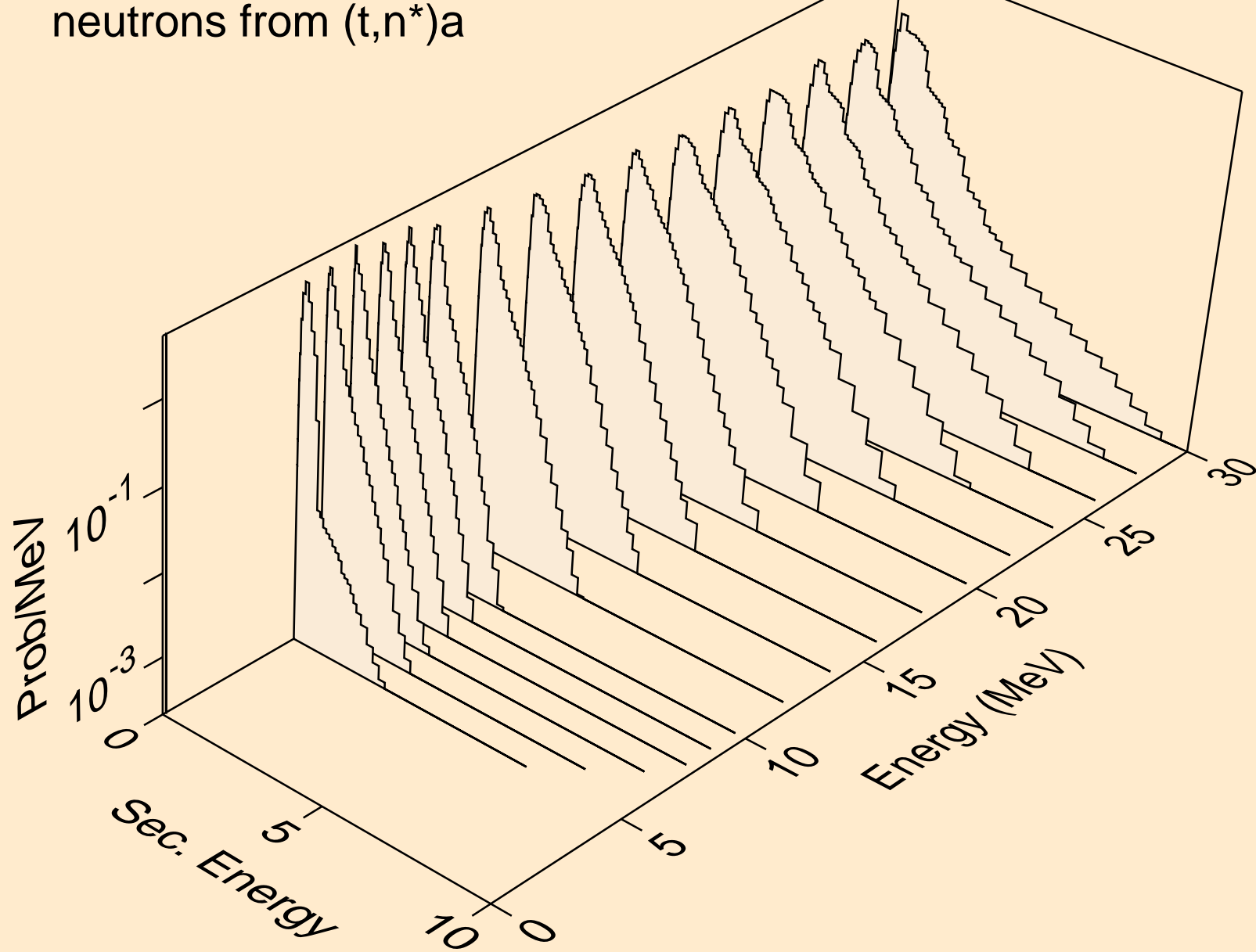

PA232 TRITON ACER TENDL-2021 LIBRARY; T=0.K  
neutrons from (t,2n)a

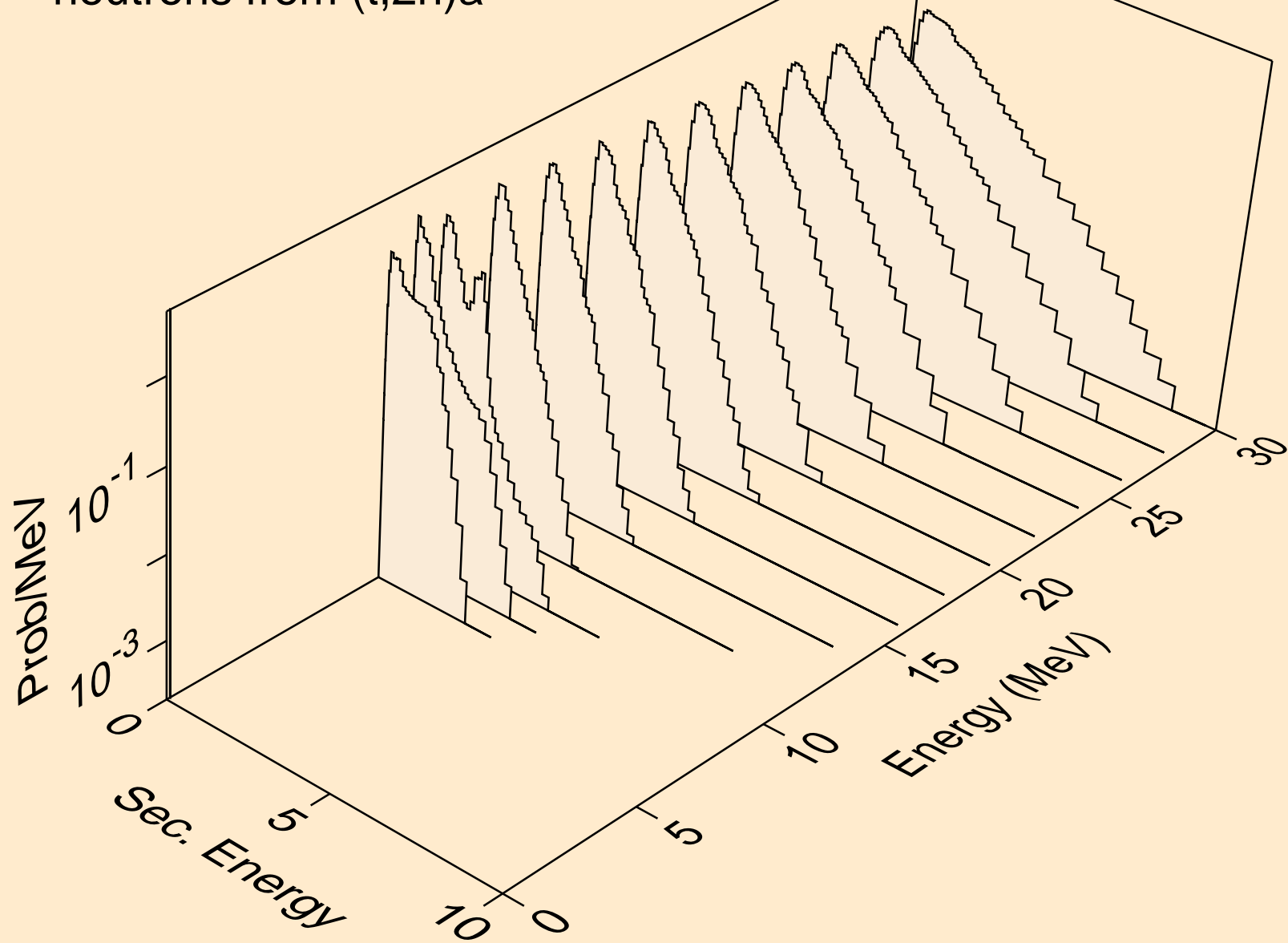

PA232 TRITON ACER TENDL-2021 LIBRARY; T=0.K  
neutrons from (t,3n)a

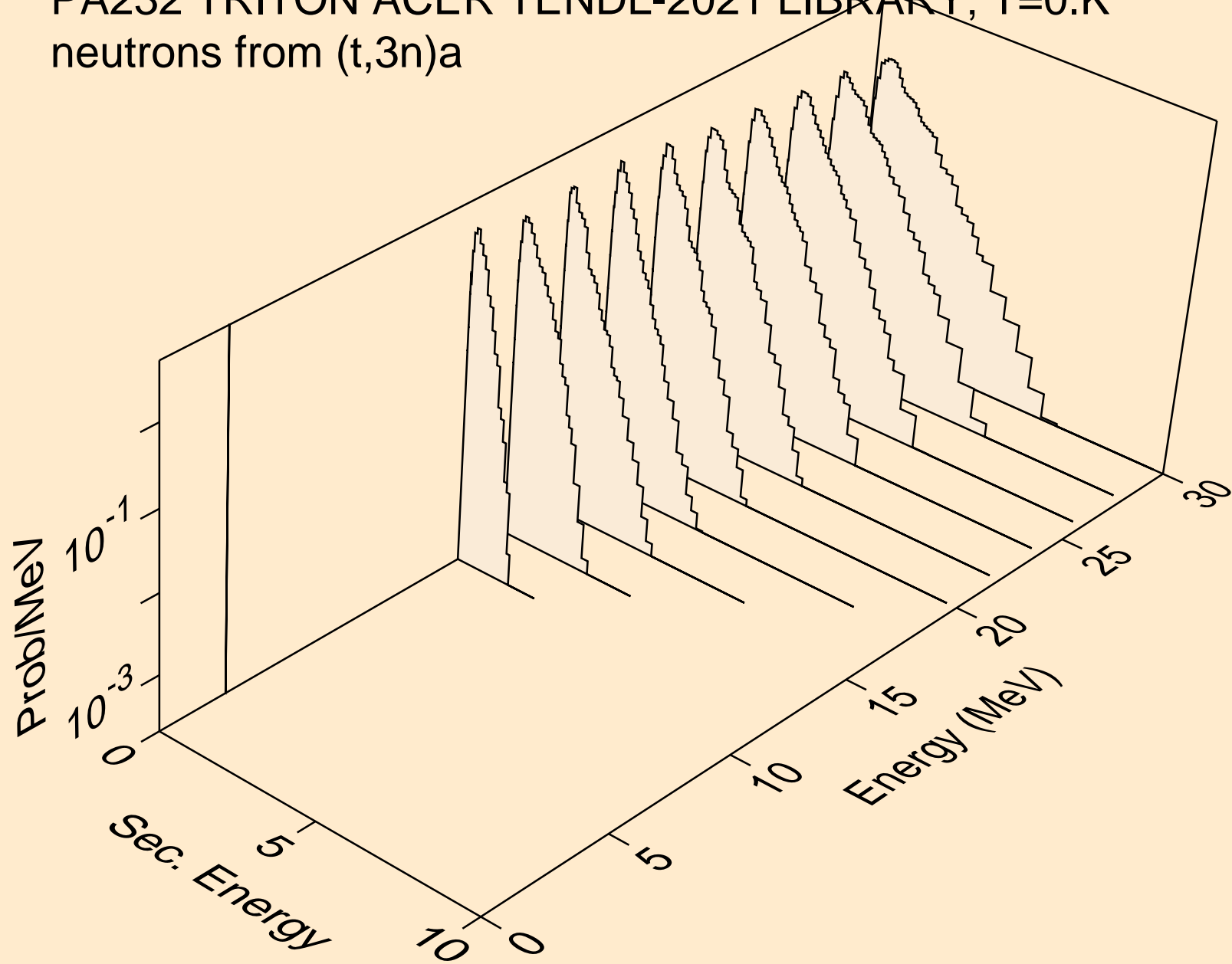

PA232 TRITON ACER TENDL-2021 LIBRARY; T=0.K  
neutrons from (t,n\*)p

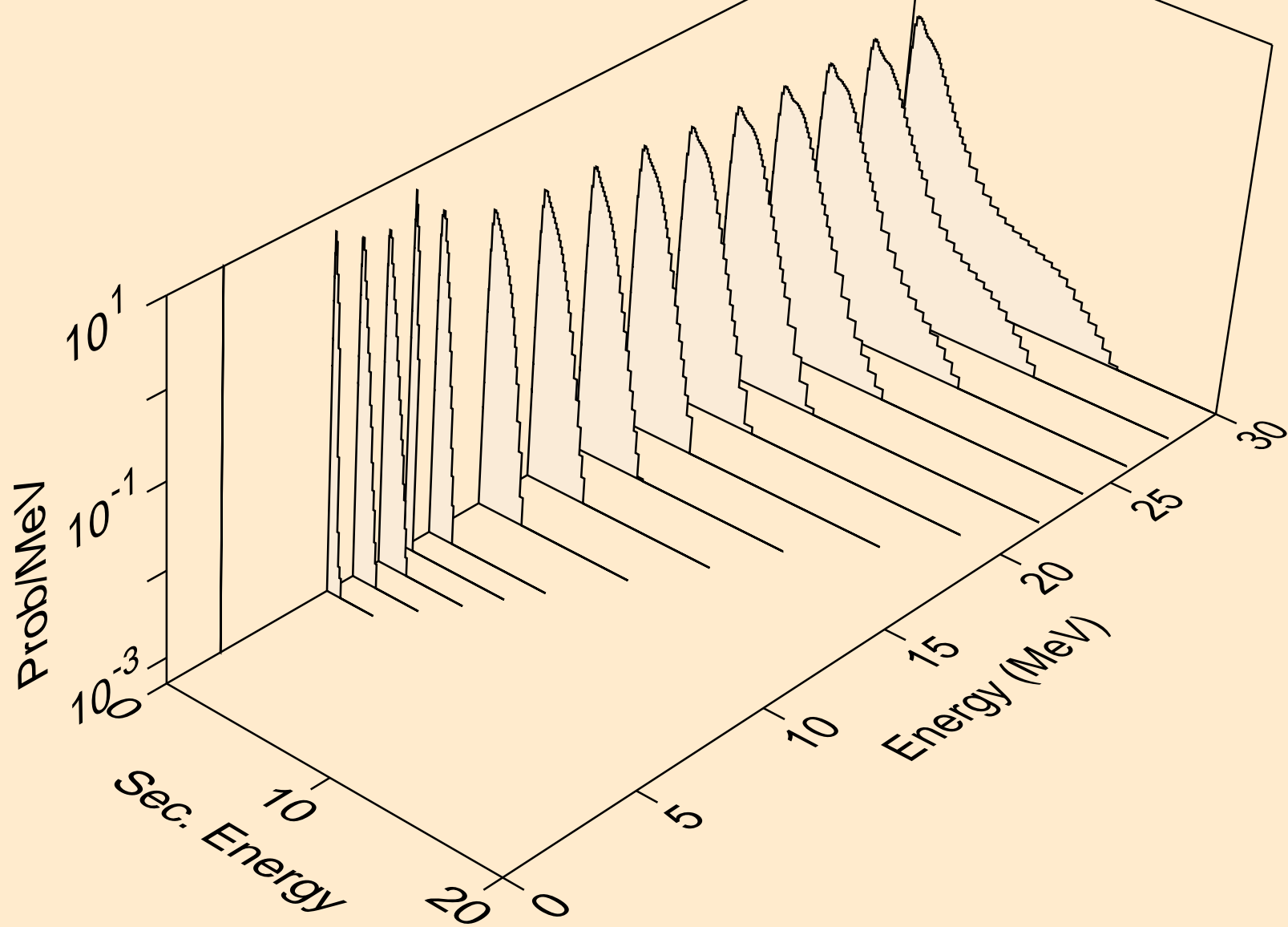



PA232 TRITON ACER TENDL-2021 LIBRARY; T=0.K  
neutrons from (t,n\*)2a

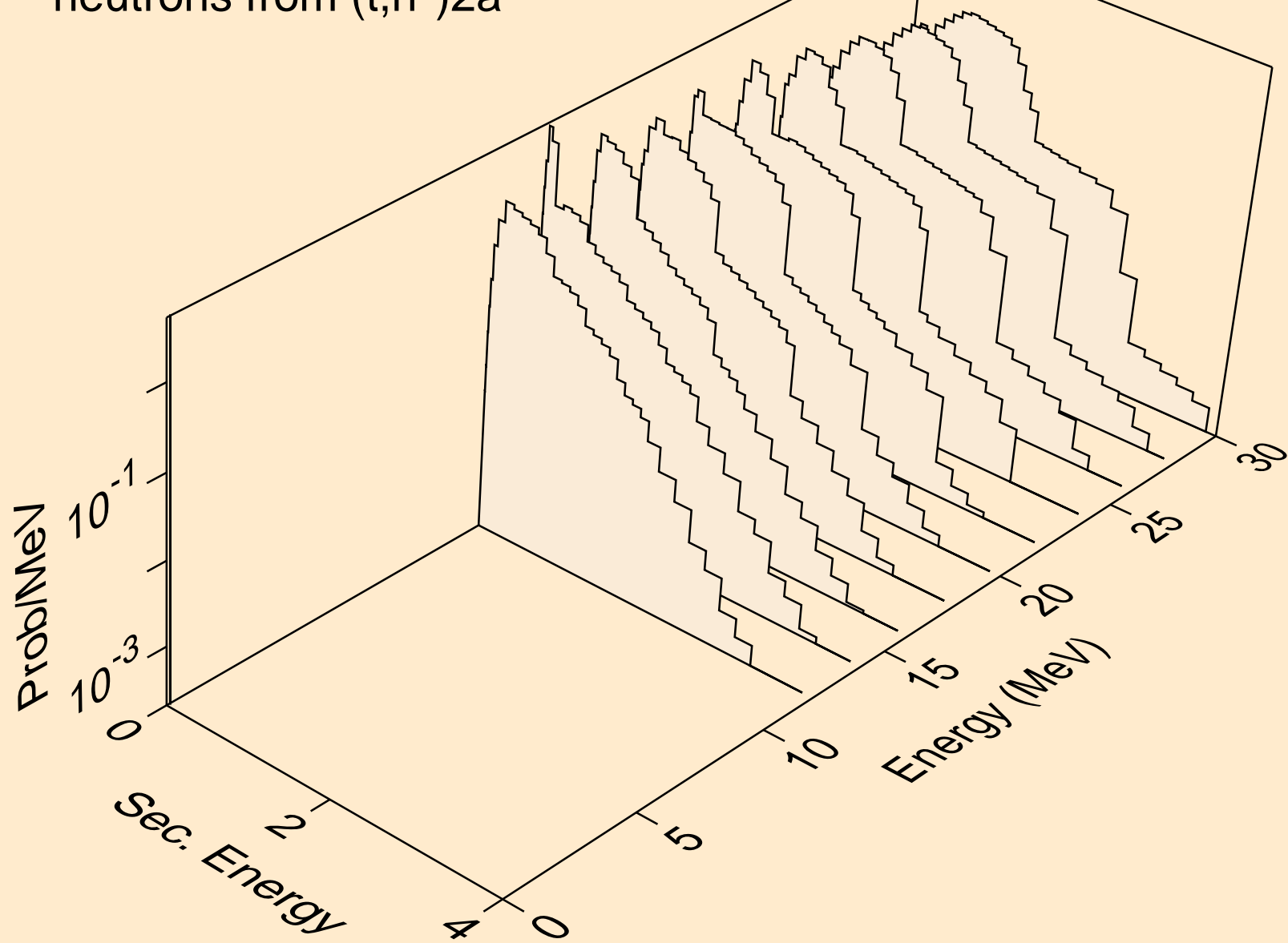

PA232 TRITON ACER TENDL-2021 LIBRARY; T=0.K  
neutrons from (t,2n)2a

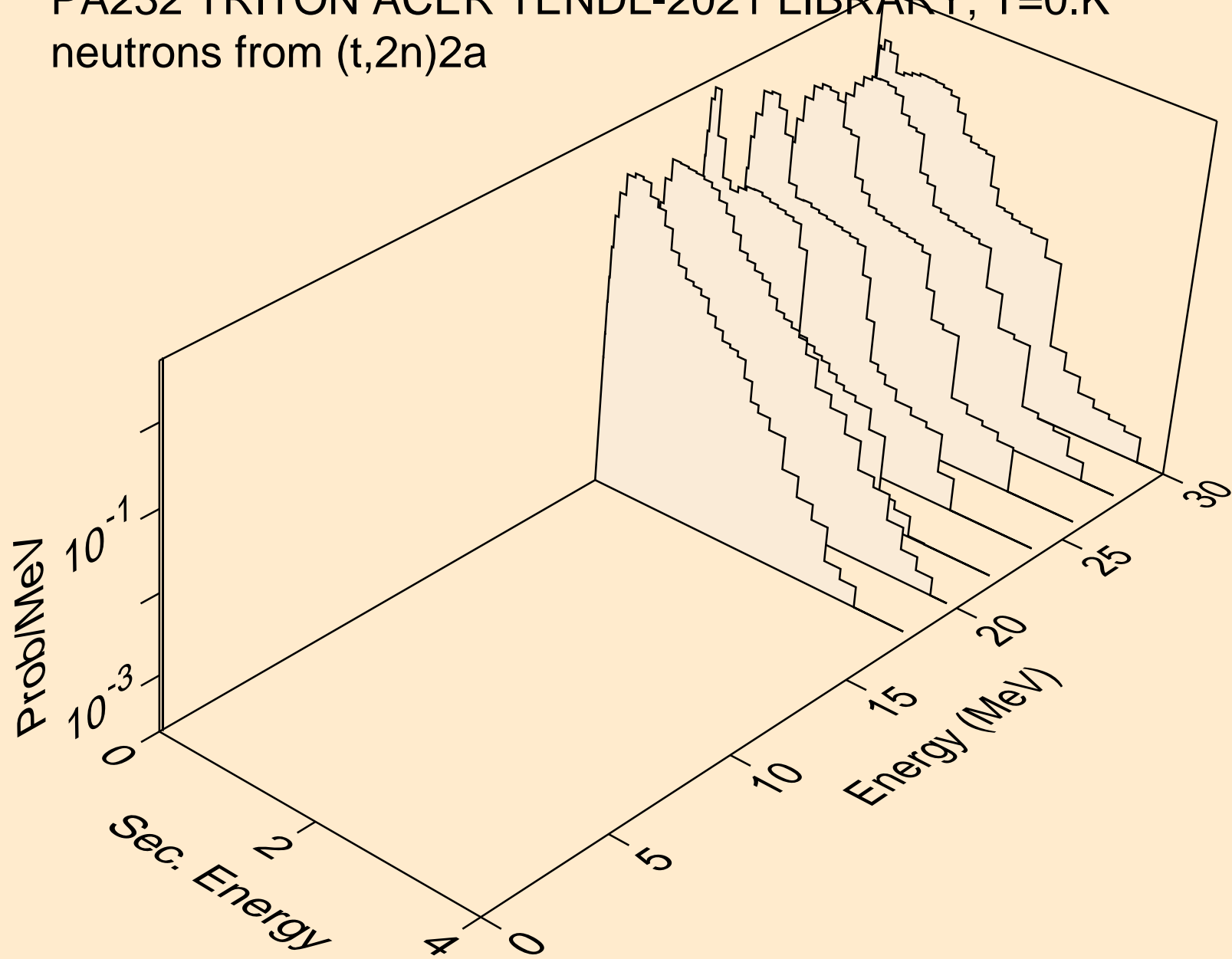

PA232 TRITON ACER TENDL-2021 LIBRARY; T=0.K  
neutrons from (t,n\*)d

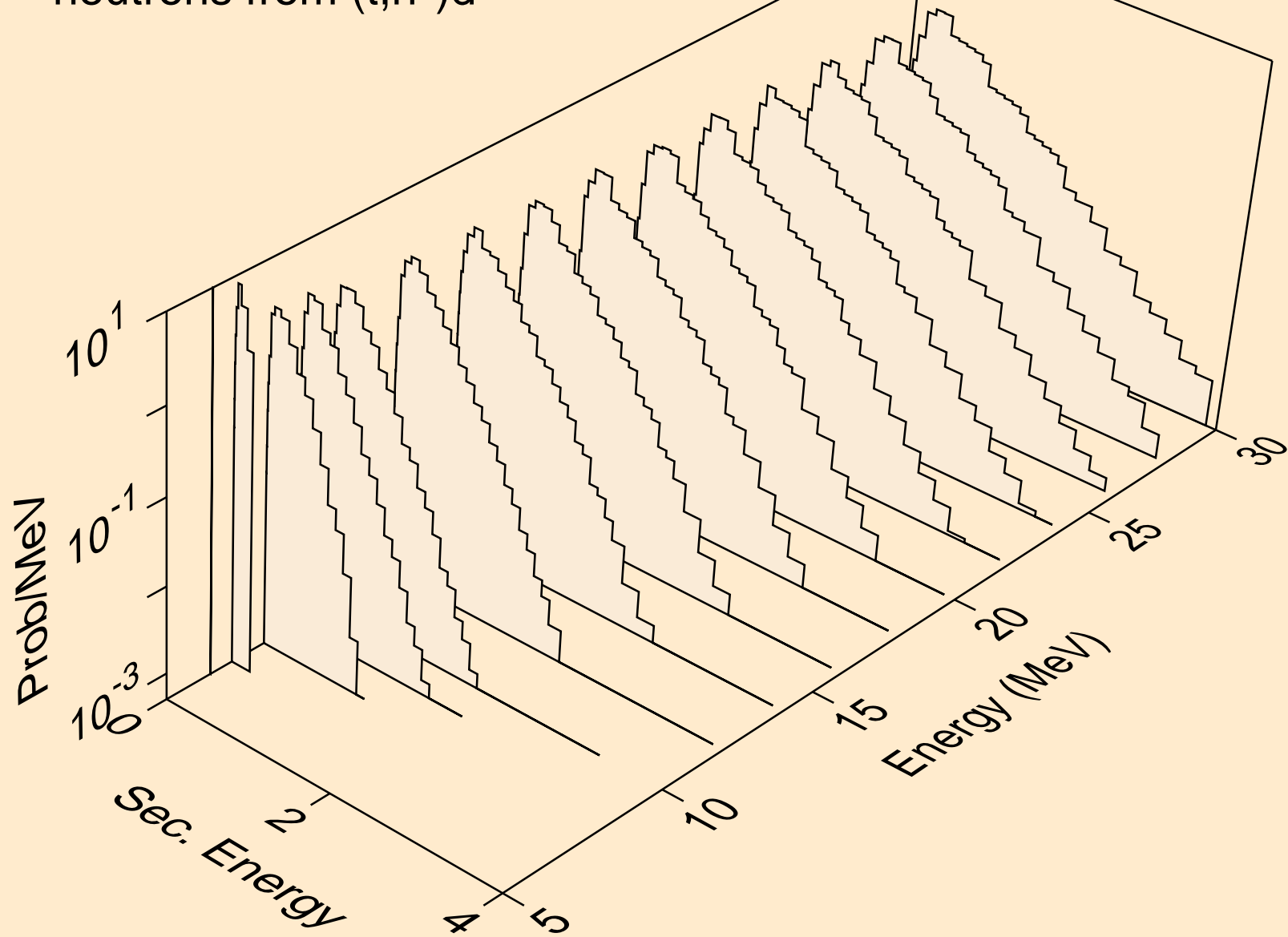

PA232 TRITON ACER TENDL-2021 LIBRARY; T=0.K  
neutrons from (t,n\*)t

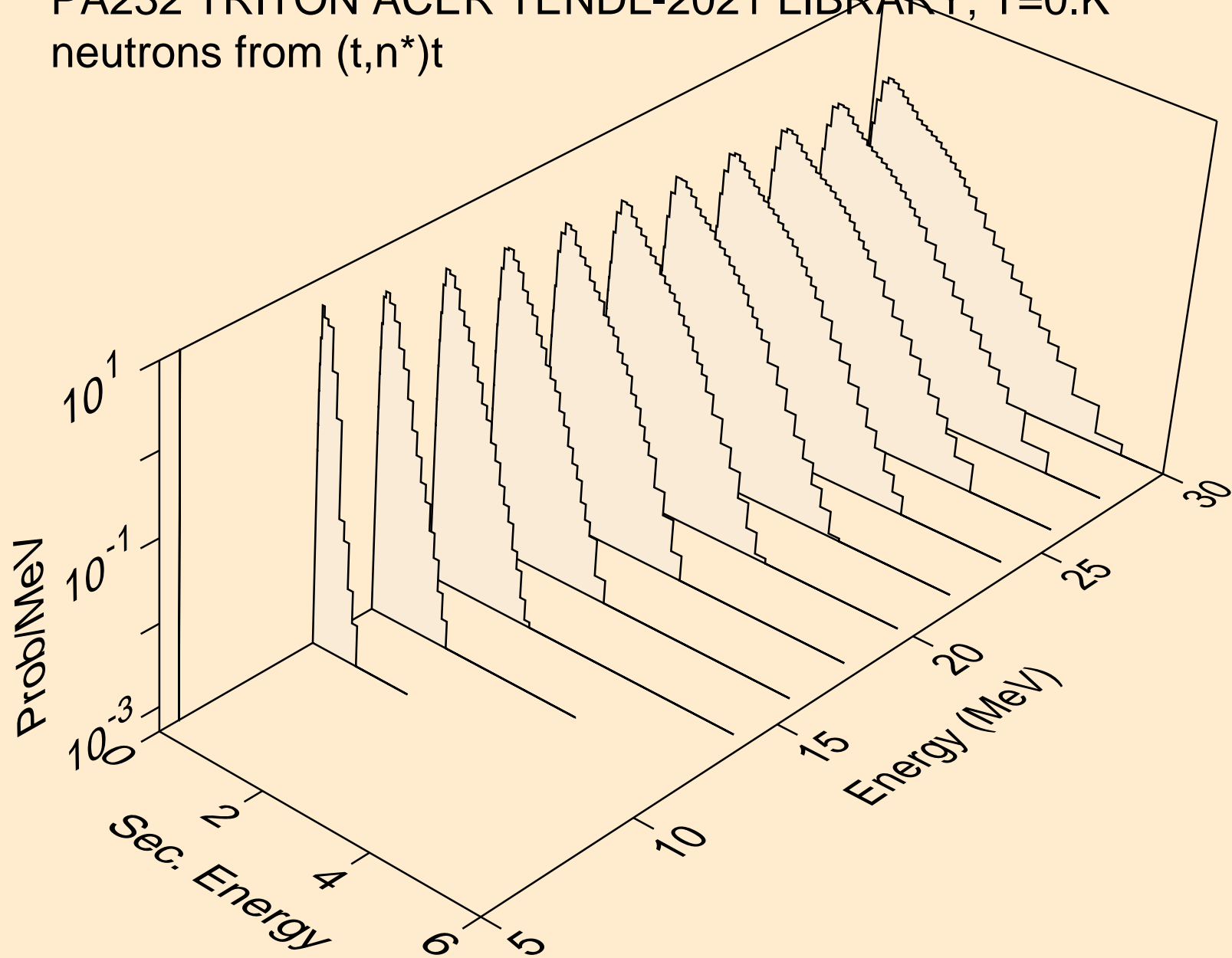

PA232 TRITON ACER TENDL-2021 LIBRARY; T=0.K  
neutrons from (t,n\*)he3

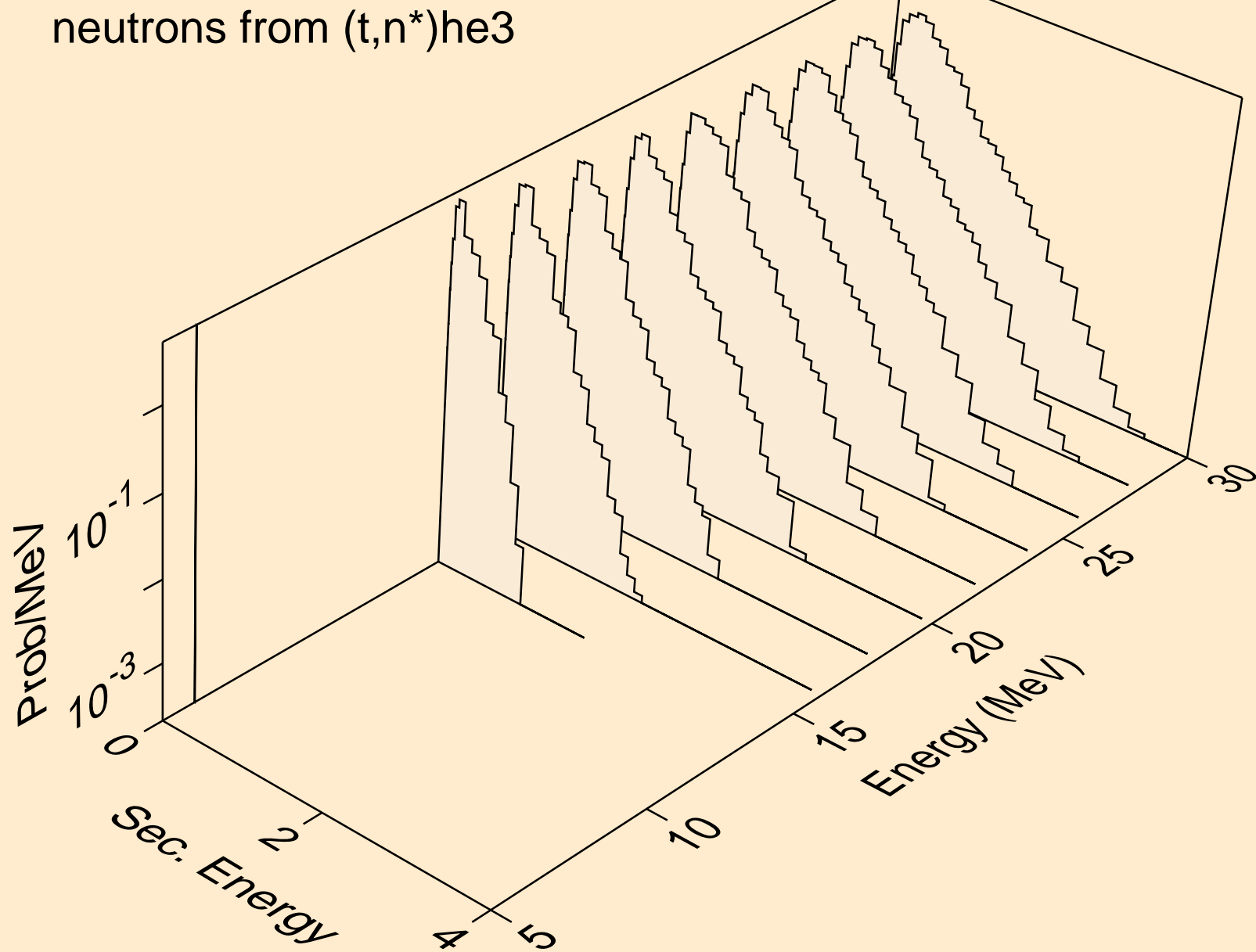

PA232 TRITON ACER TENDL-2021 LIBRARY; T=0.K  
neutrons from (t,4n)

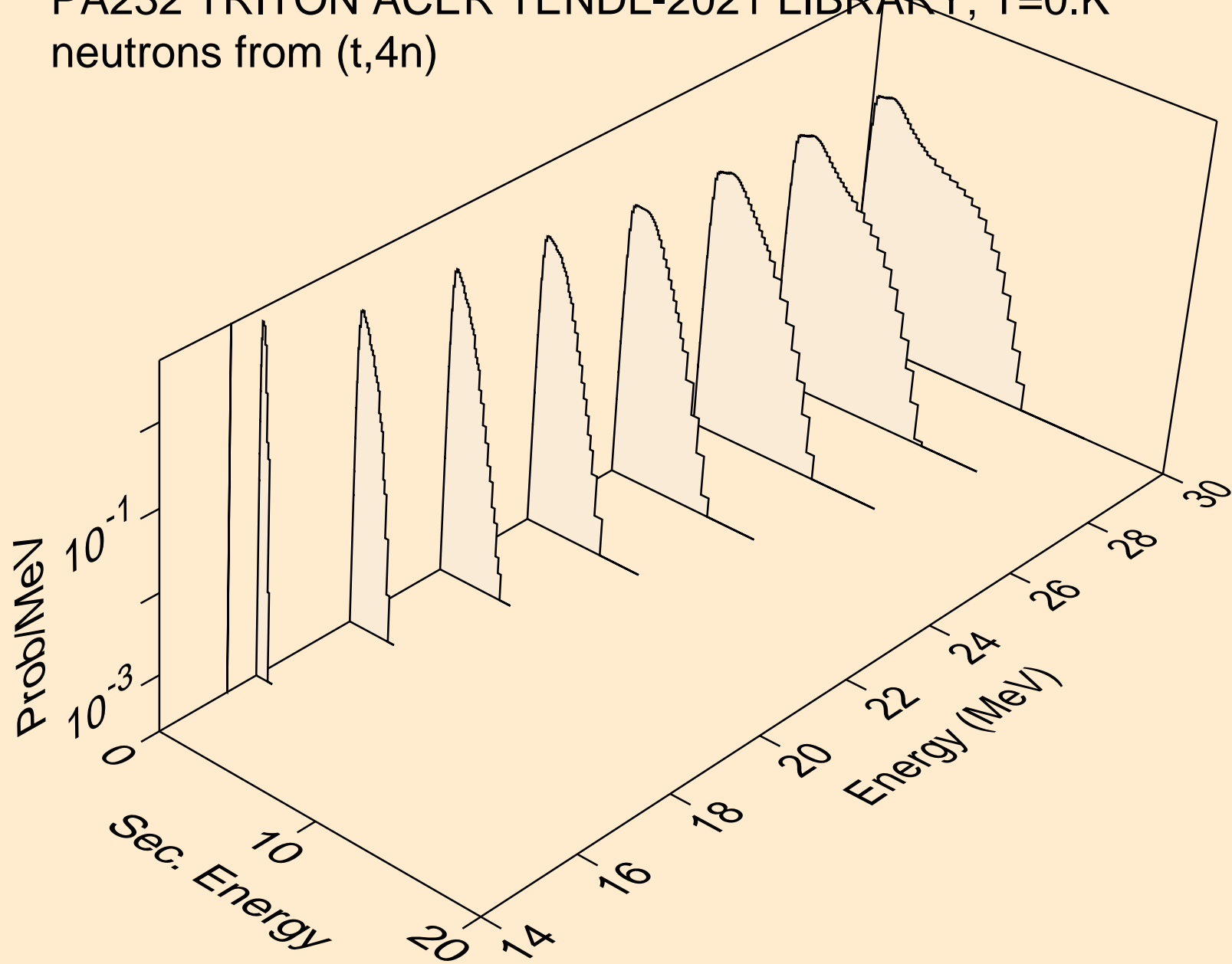

PA232 TRITON ACER TENDL-2021 LIBRARY; T=0.K  
neutrons from (t,2np)

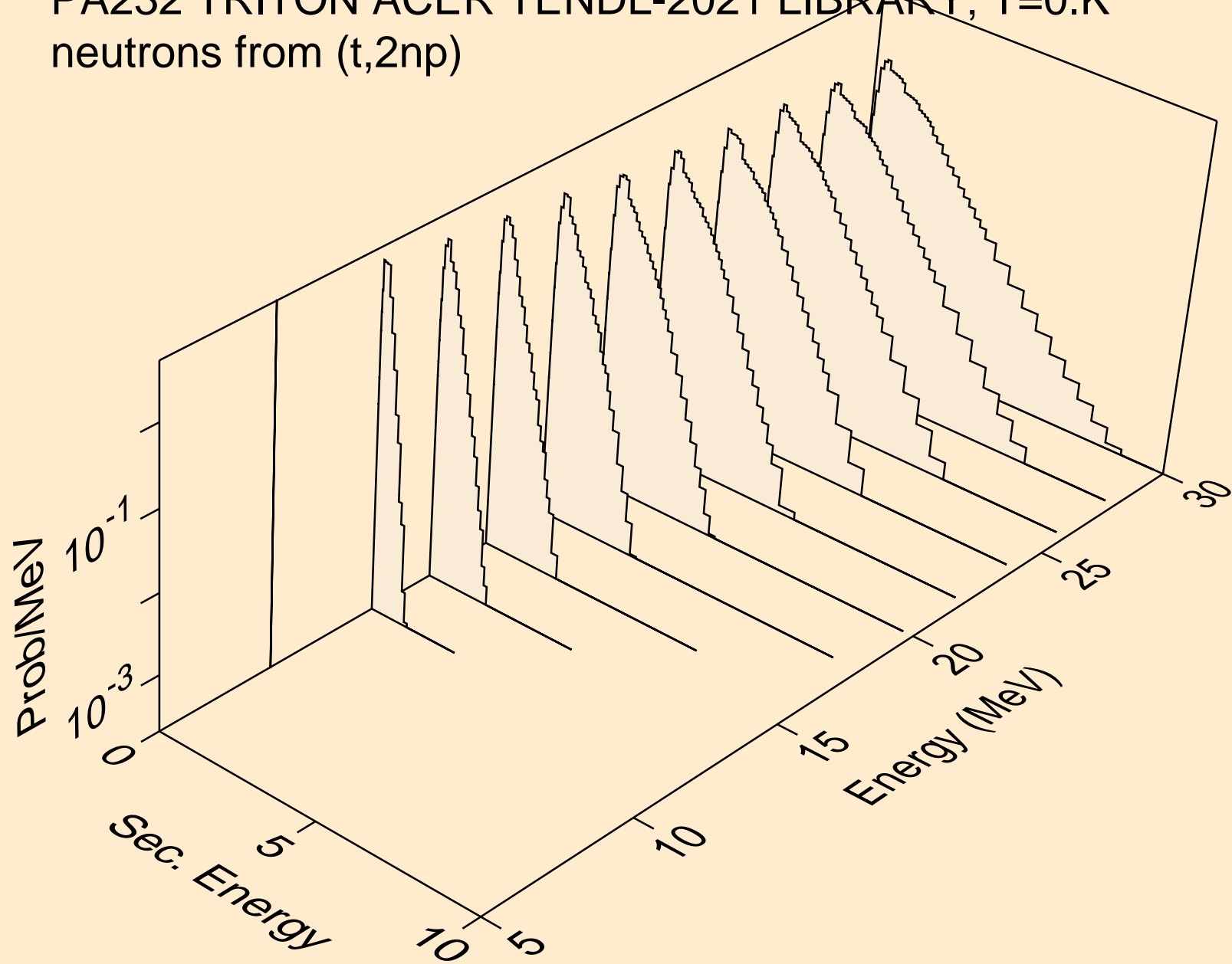

PA232 TRITON ACER TENDL-2021 LIBRARY; T=0.K  
neutrons from (t,3np)

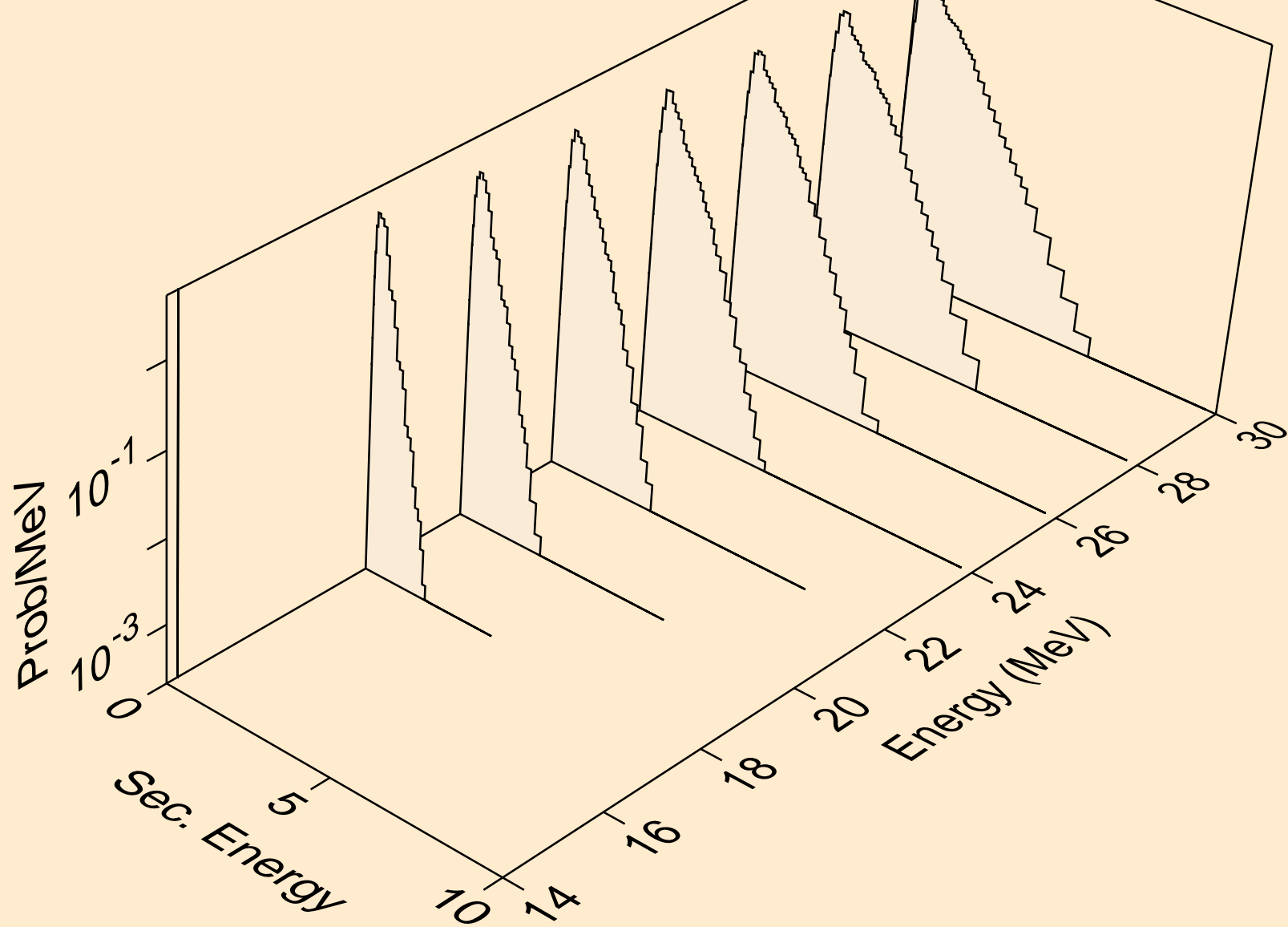



PA232 TRITON ACER TENDL-2021 LIBRARY; T=0.K  
neutrons from (t,2np)

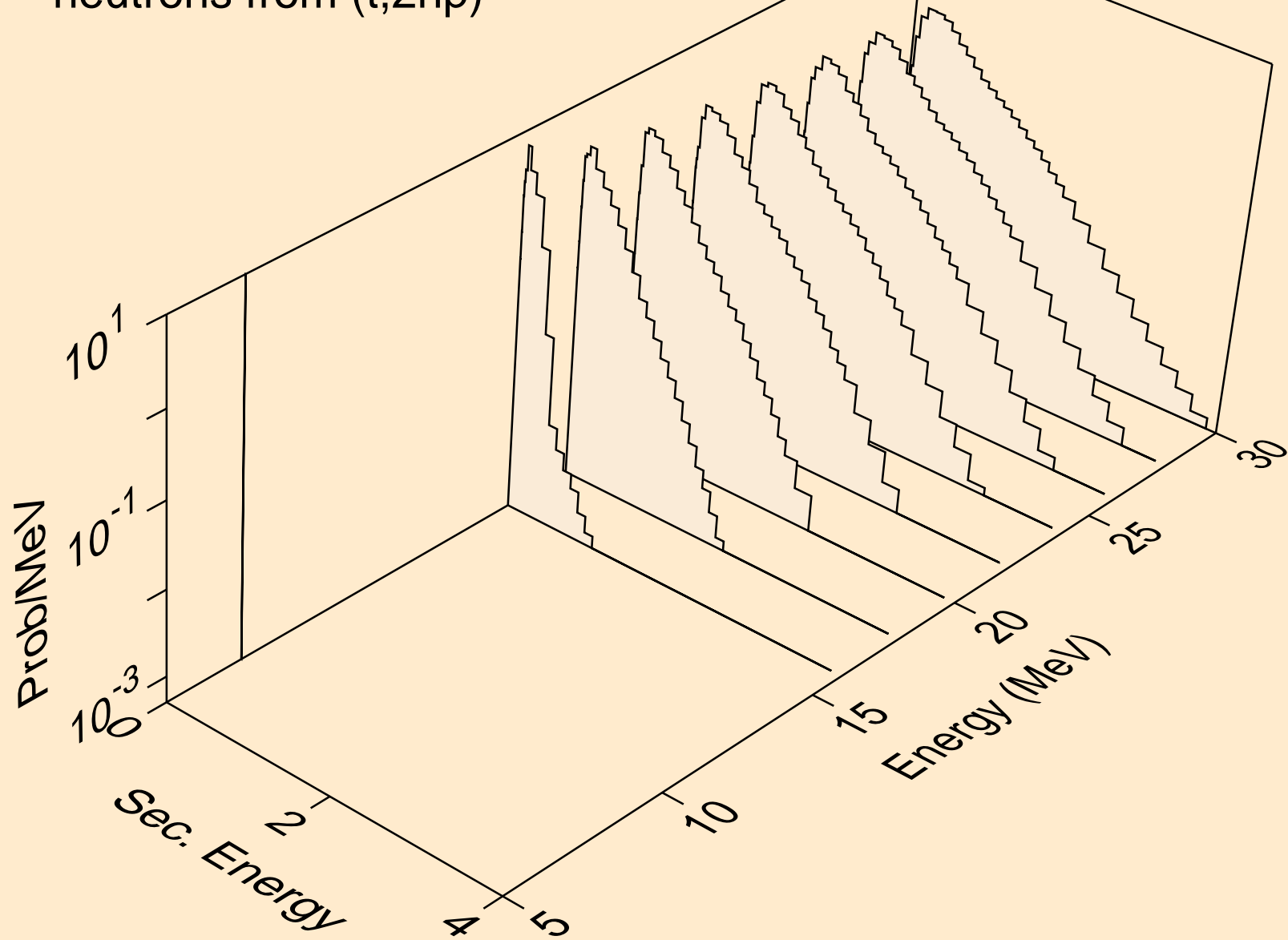

PA232 TRITON ACER TENDL-2021 LIBRARY; T=0.K  
neutrons from (t,npa)

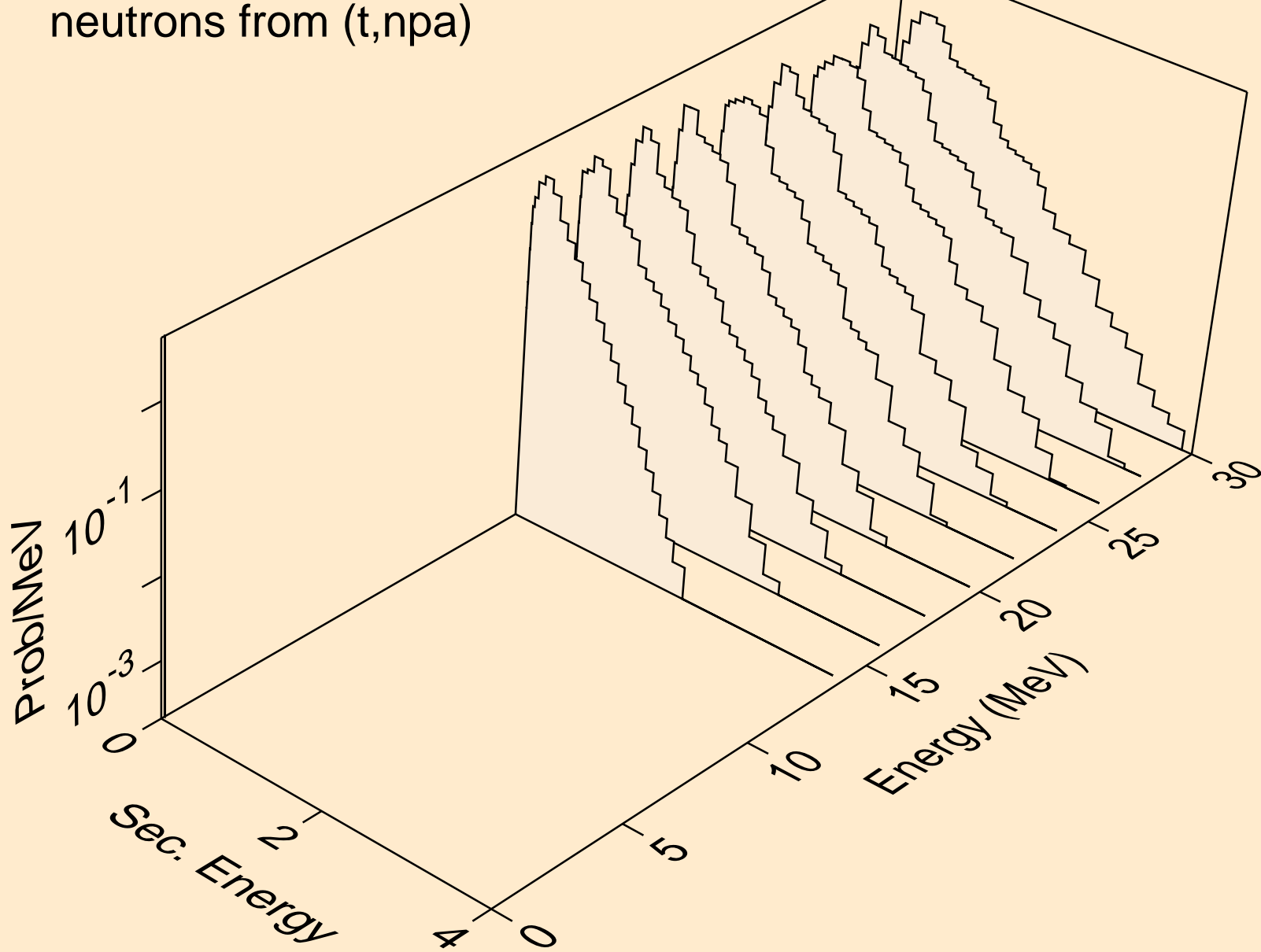

PA232 TRITON ACER TENDL-2021 LIBRARY; T=0.K  
protons from (t,x)

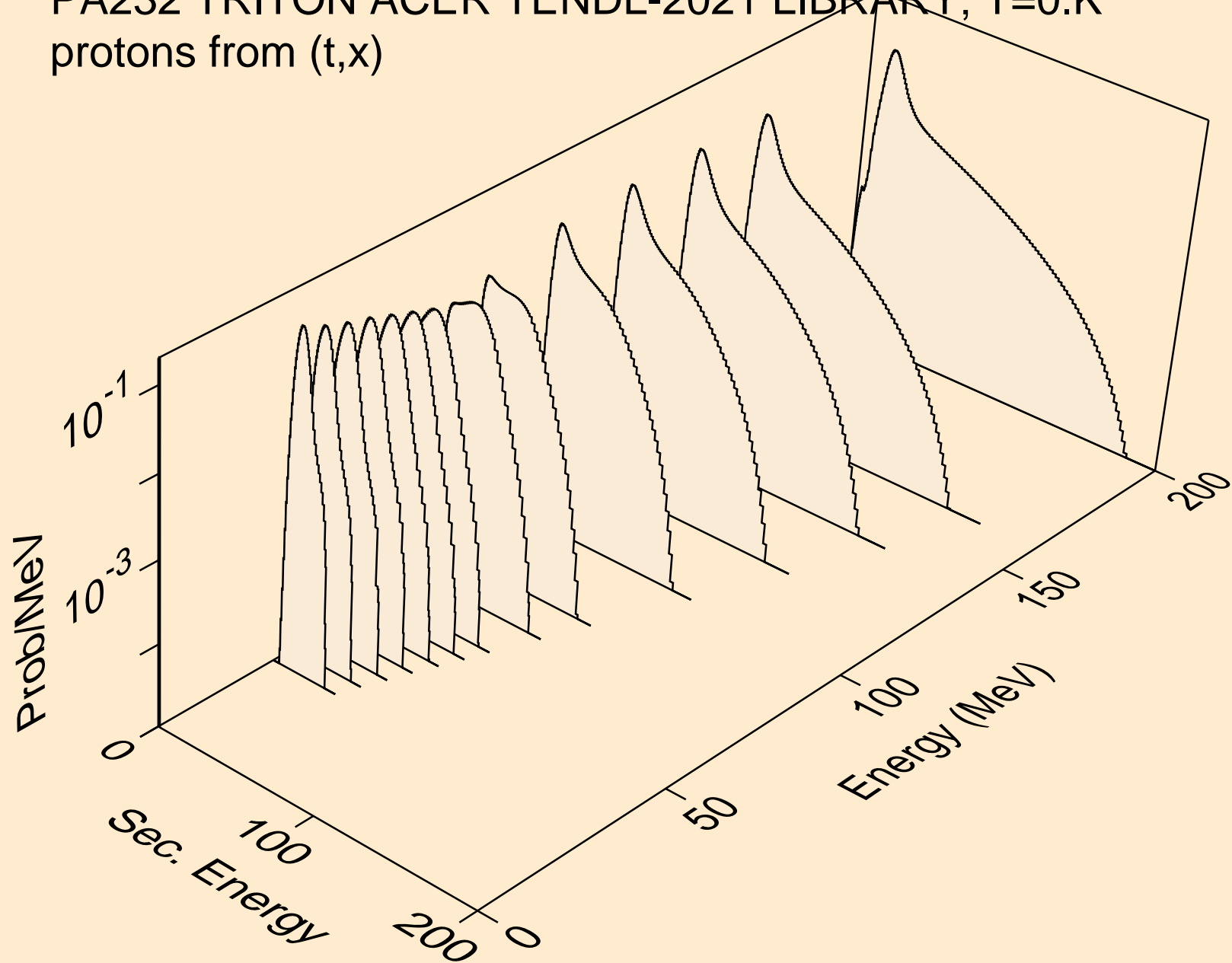

PA232 TRITON ACER TENDL-2021 LIBRARY; T=0.K  
protons from (t,n\*)p

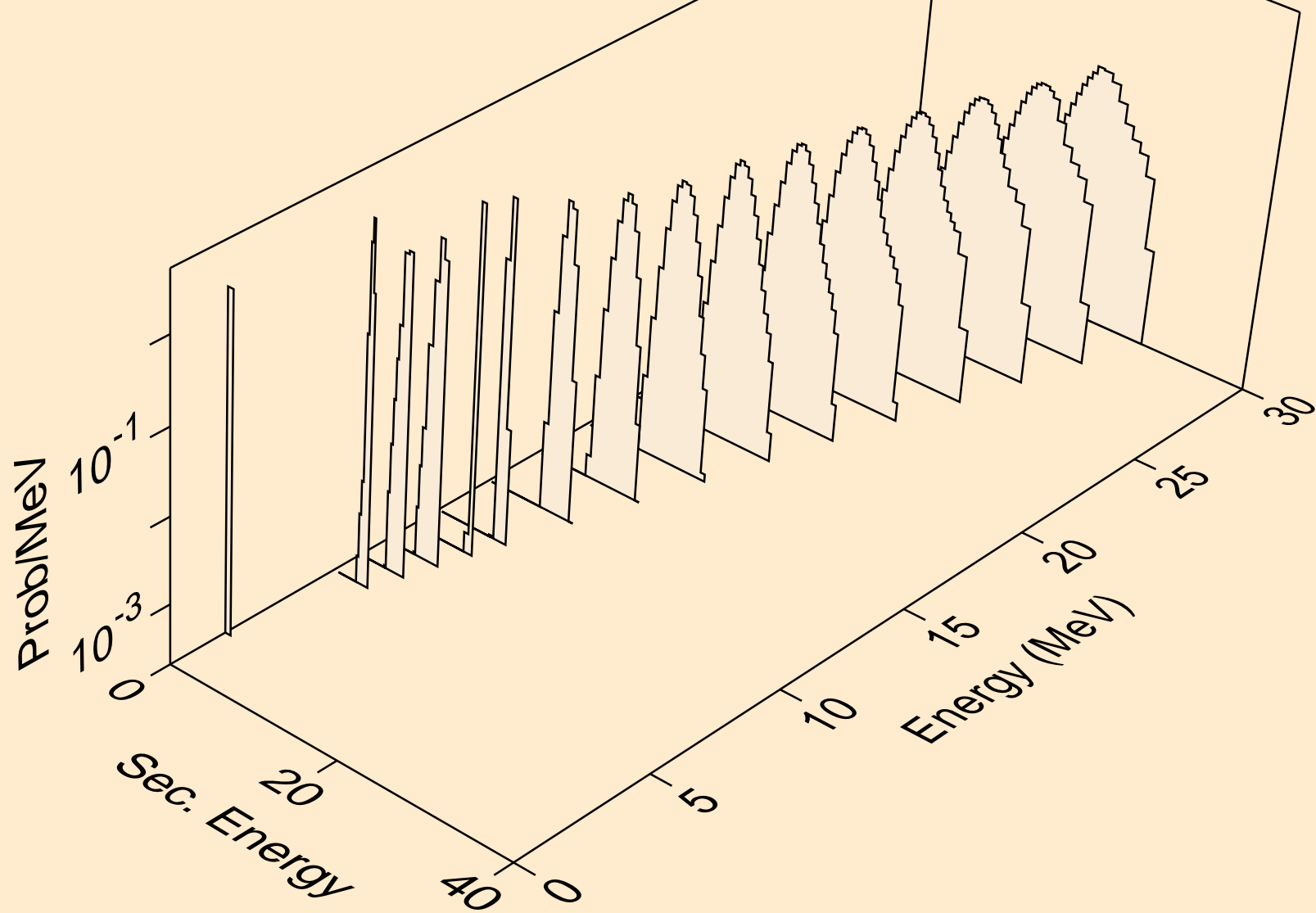

PA232 TRITON ACER TENDL-2021 LIBRARY; T=0.K  
protons from (t,2np)

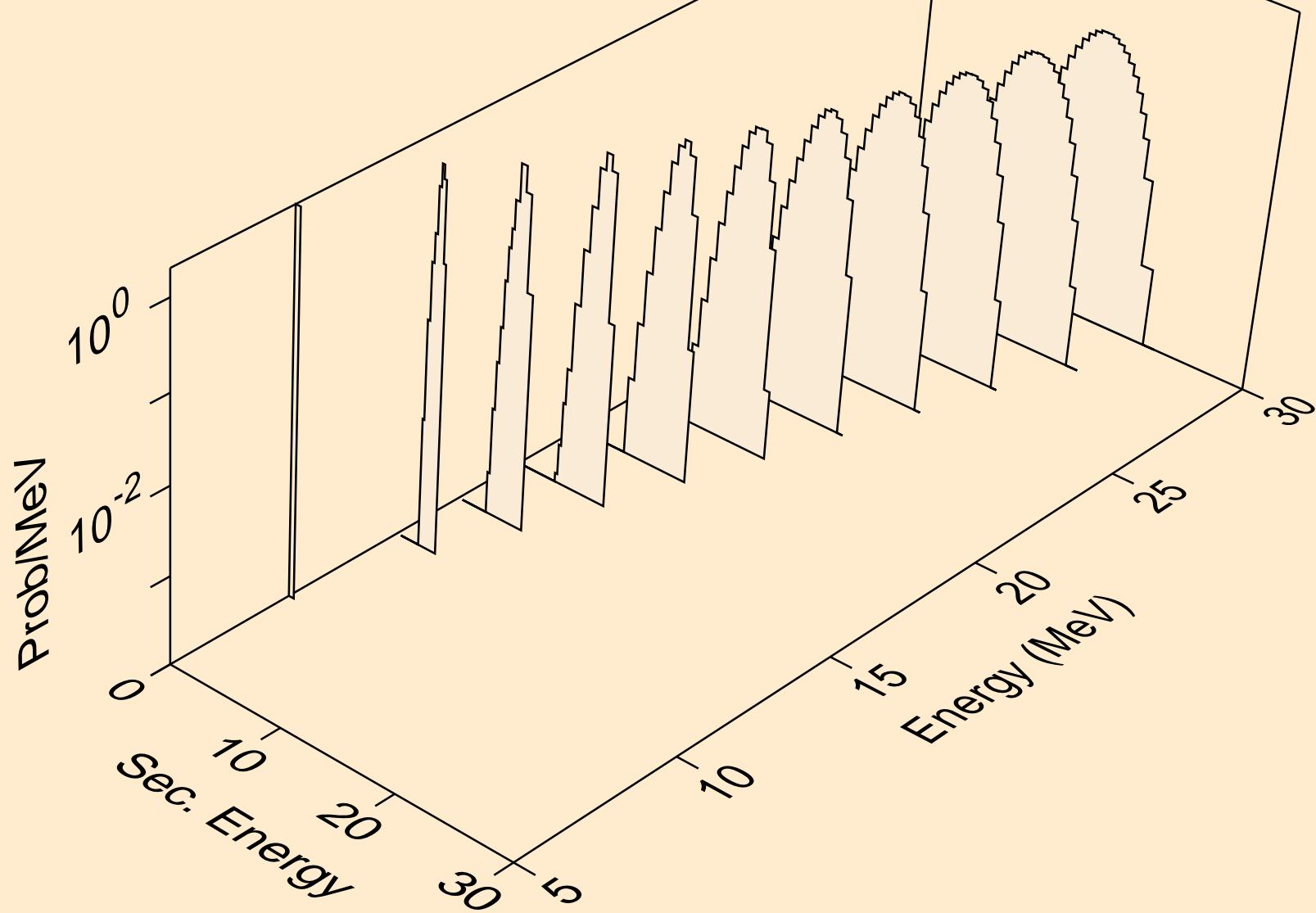

PA232 TRITON ACER TENDL-2021 LIBRARY; T=0.K  
protons from (t,3np)

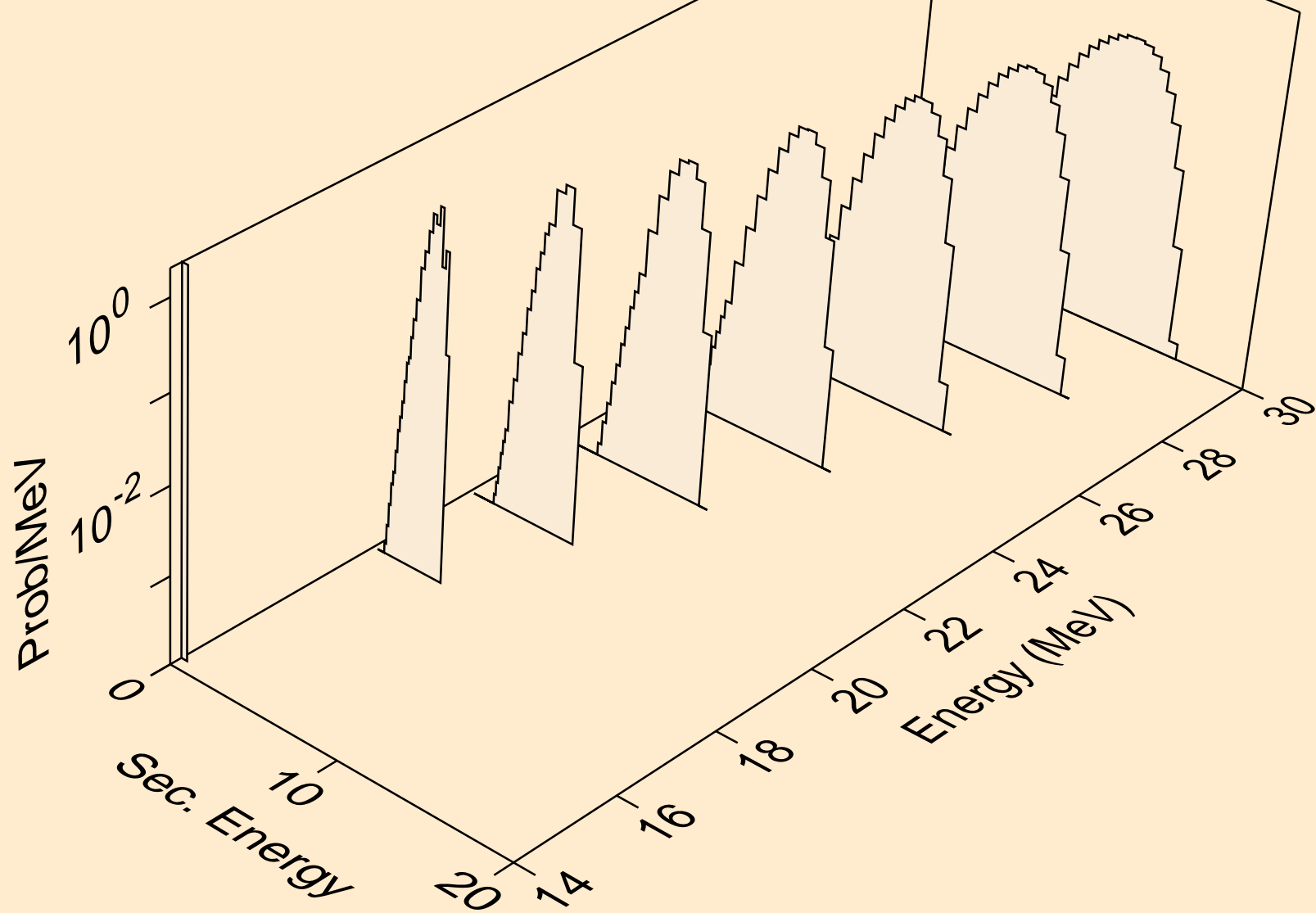

PA232 TRITON ACER TENDL-2021 LIBRARY; T=0.K  
protons from (t,2np)

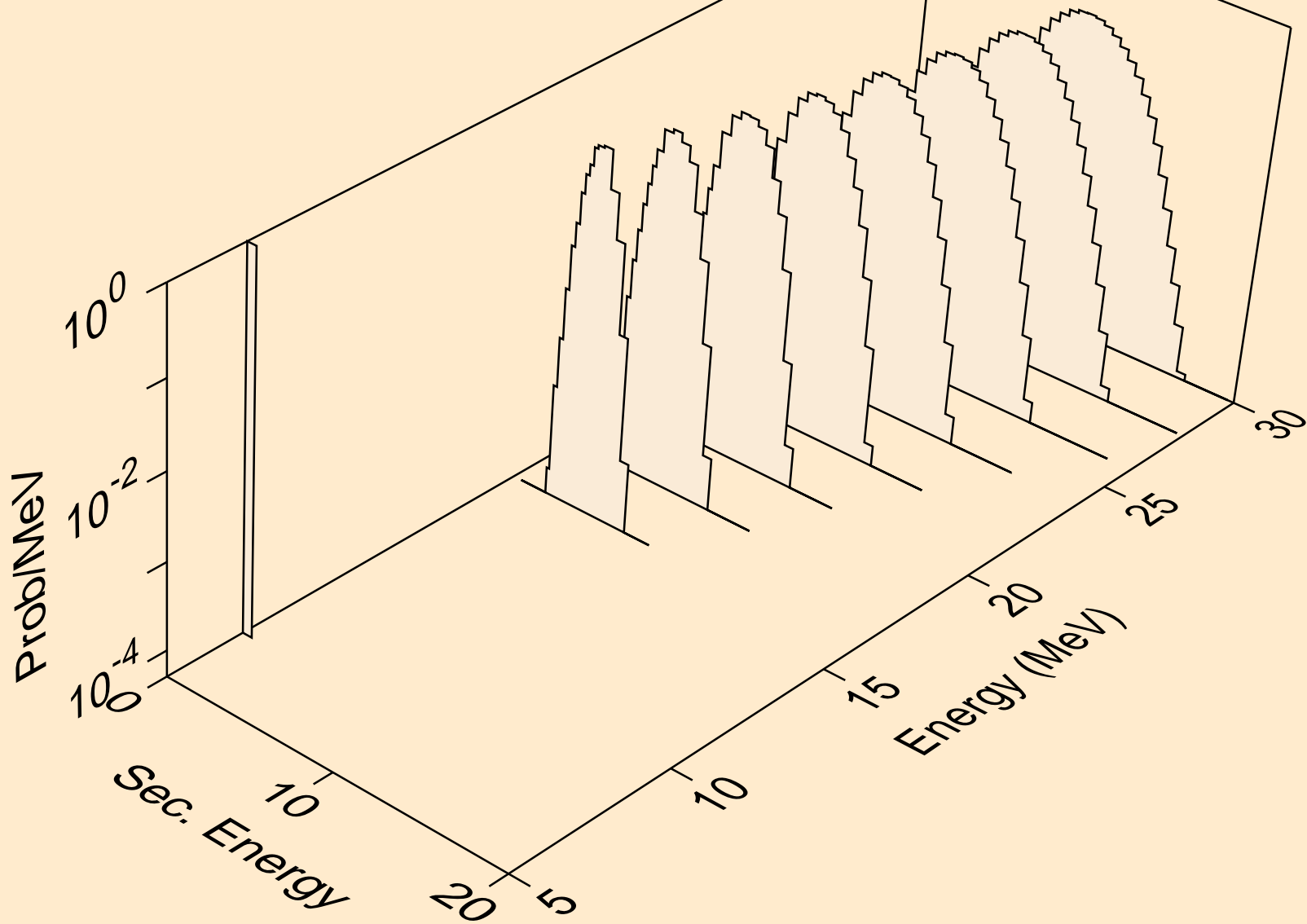

PA232 TRITON ACER TENDL-2021 LIBRARY; T=0.K  
protons from (t,npa)

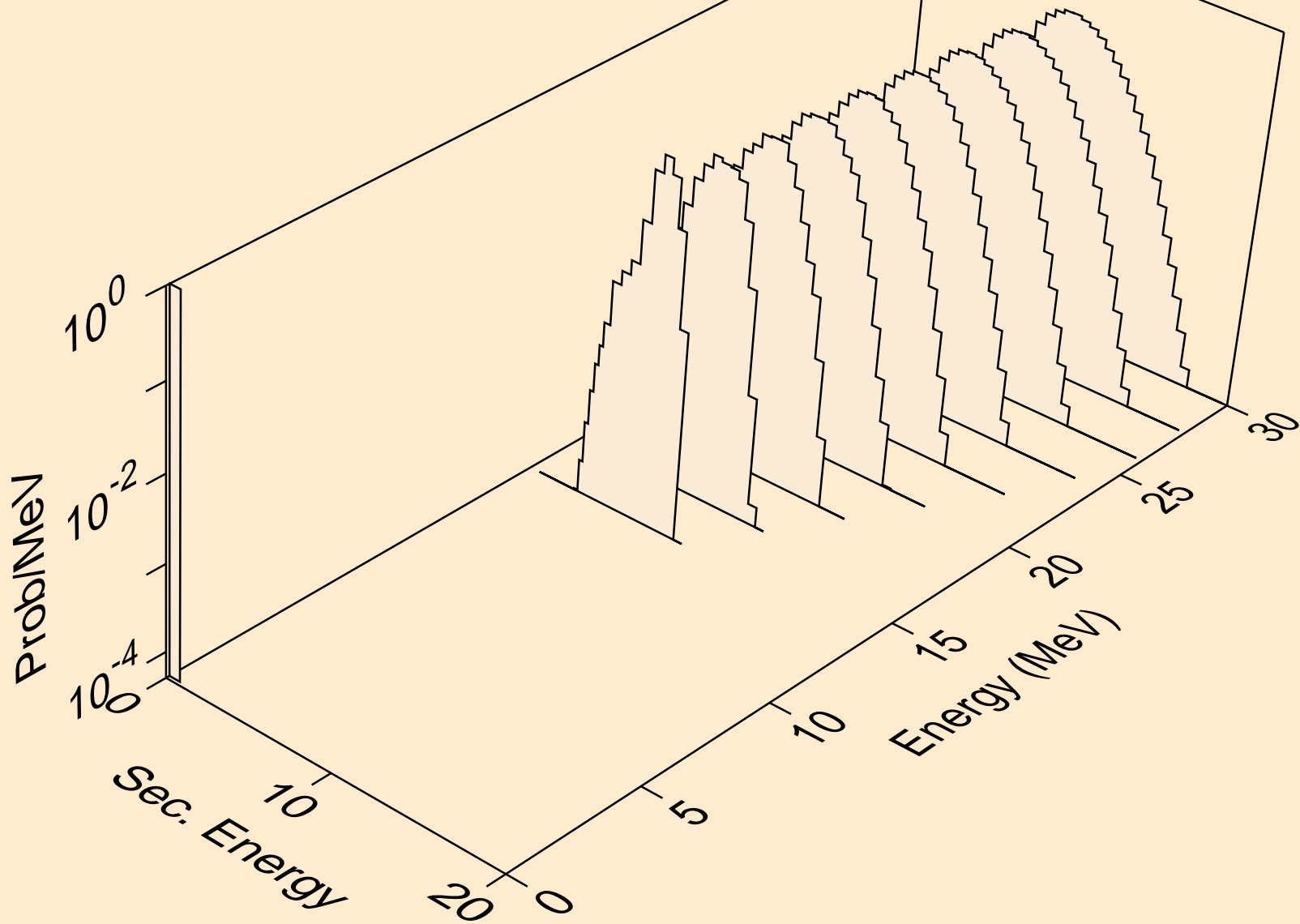



PA232 TRITON ACER TENDL-2021 LIBRARY; T=0.K  
protons from (t,p)

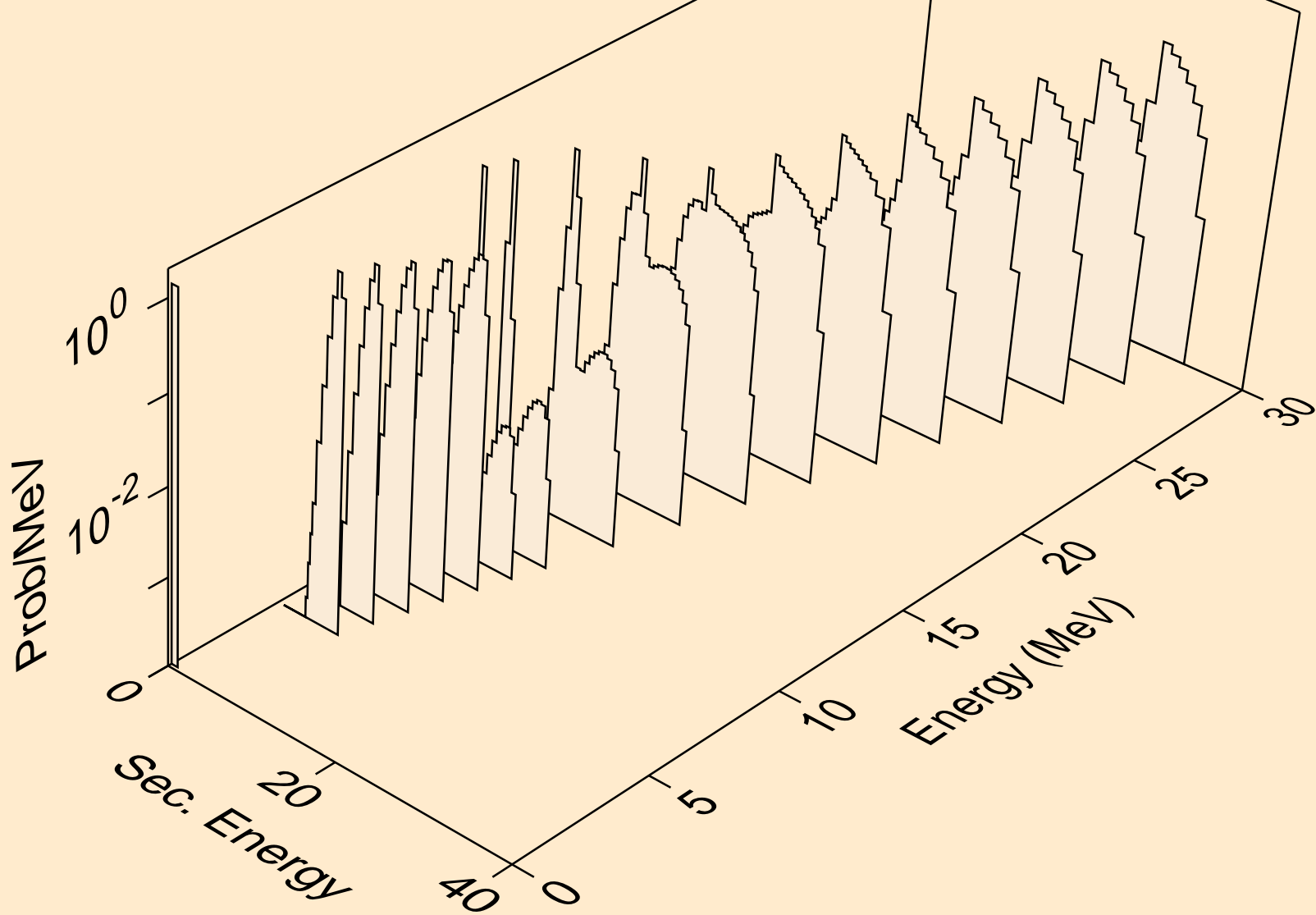

PA232 TRITON ACER TENDL-2021 LIBRARY; T=0.K  
protons from (t,2p)

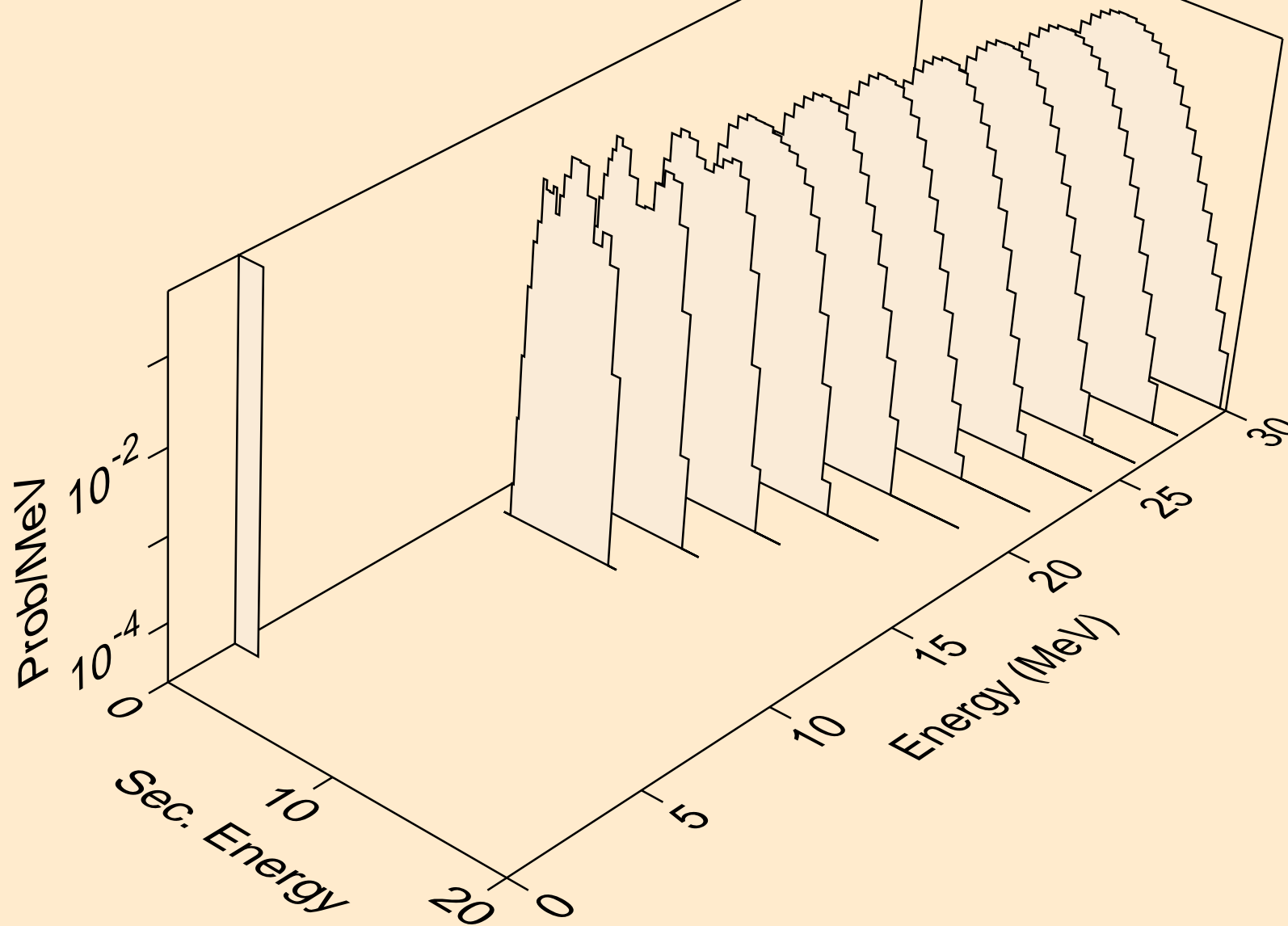

PA232 TRITON ACER TENDL-2021 LIBRARY; T=0.K  
protons from (t,pa)

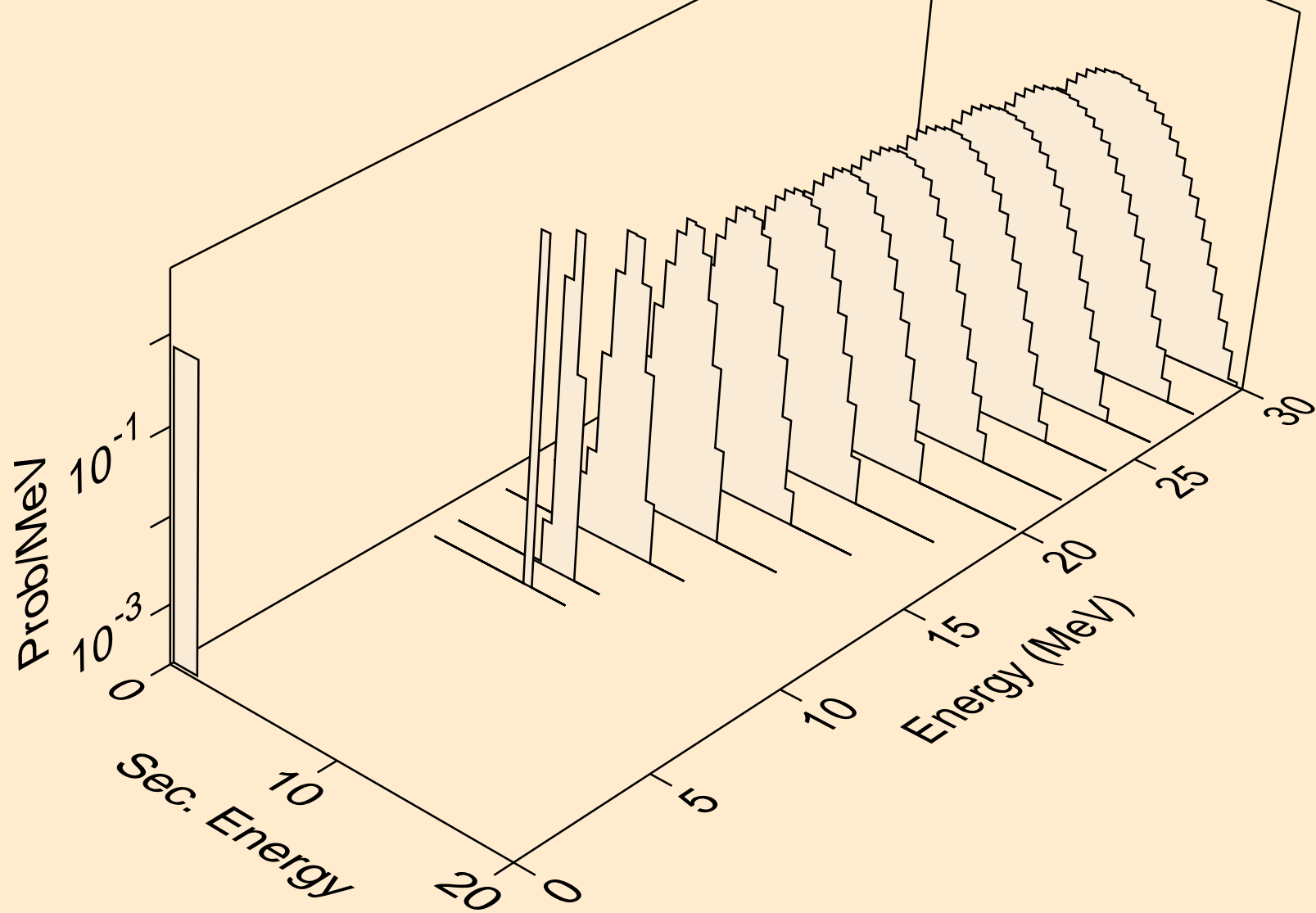

PA232 TRITON ACER TENDL-2021 LIBRARY; T=0.K  
protons from (t,pd)

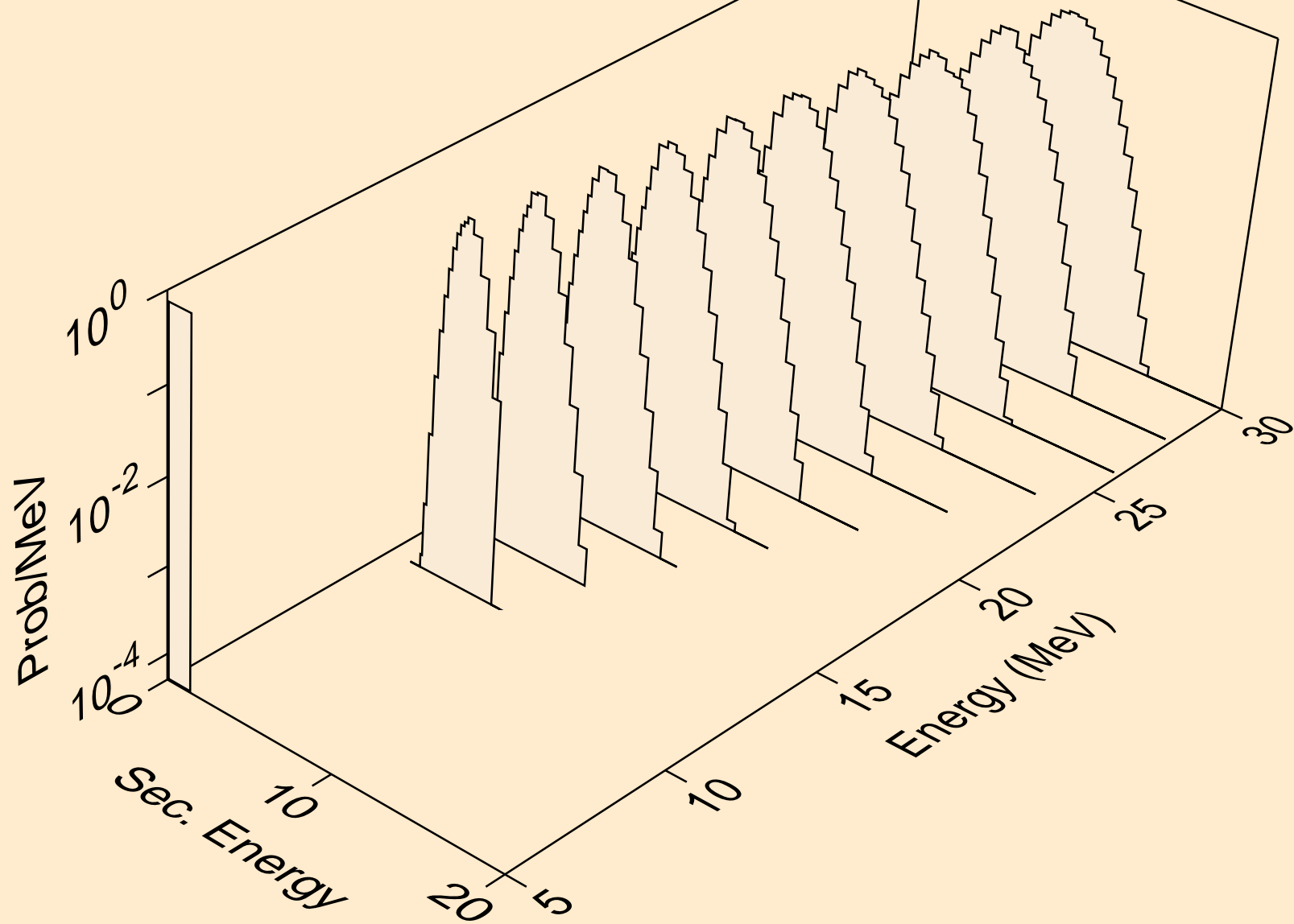

PA232 TRITON ACER TENDL-2021 LIBRARY; T=0.K  
protons from (t,pt)

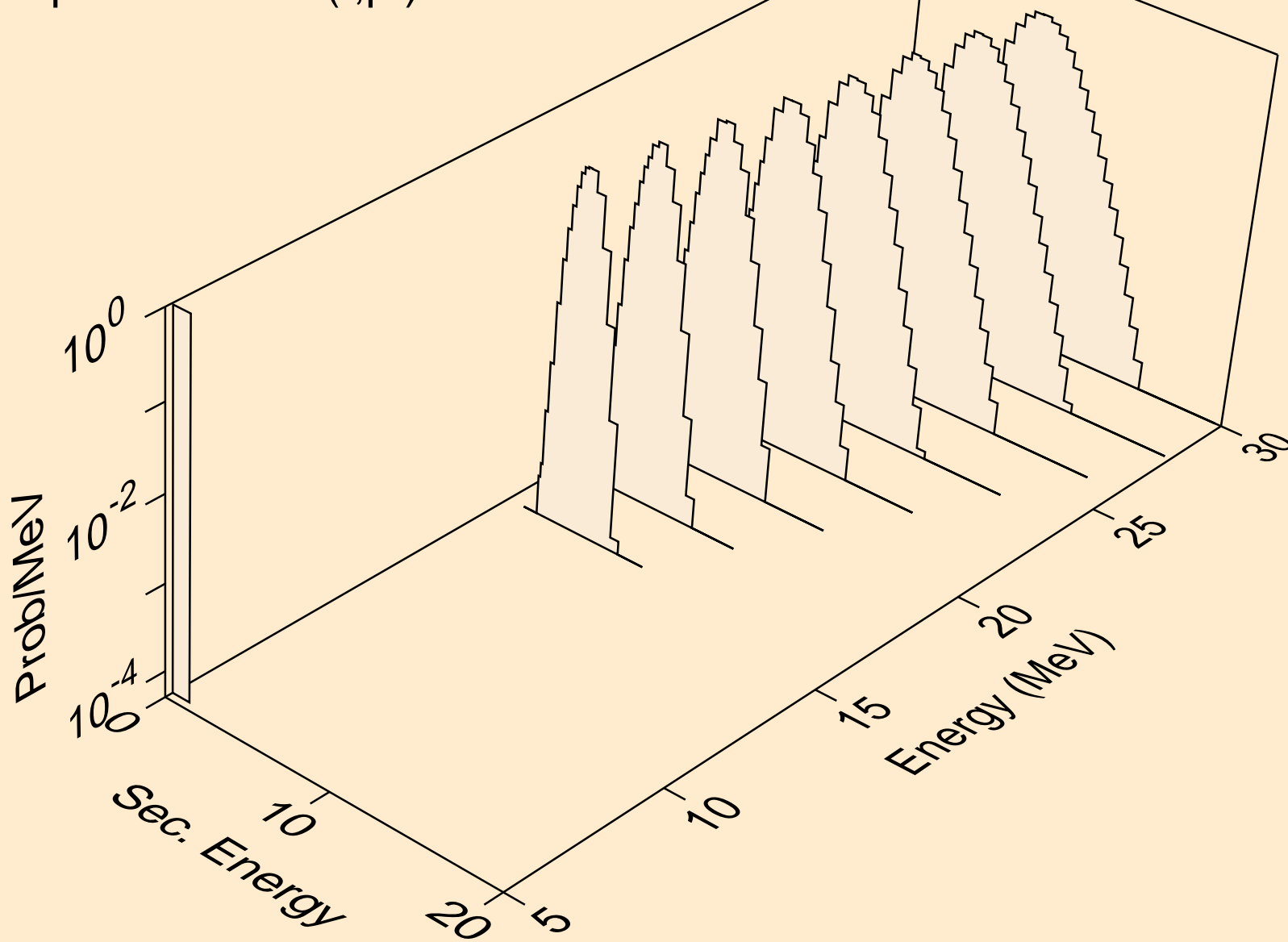

PA232 TRITON ACER TENDL-2021 LIBRARY; T=0.K  
deuterons from (t,x)

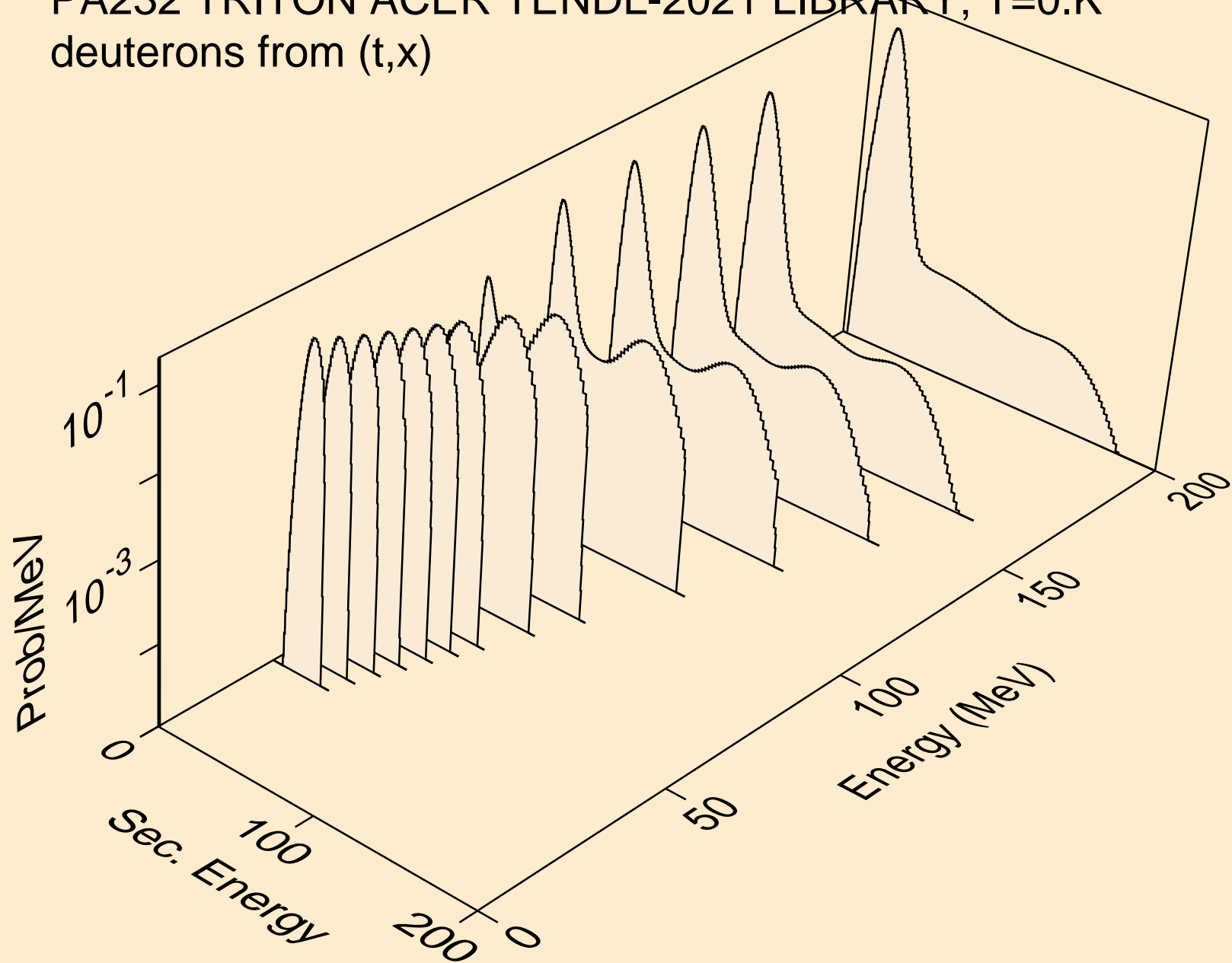

PA232 TRITON ACER TENDL-2021 LIBRARY; T=0.K  
deuterons from (t,2nd)

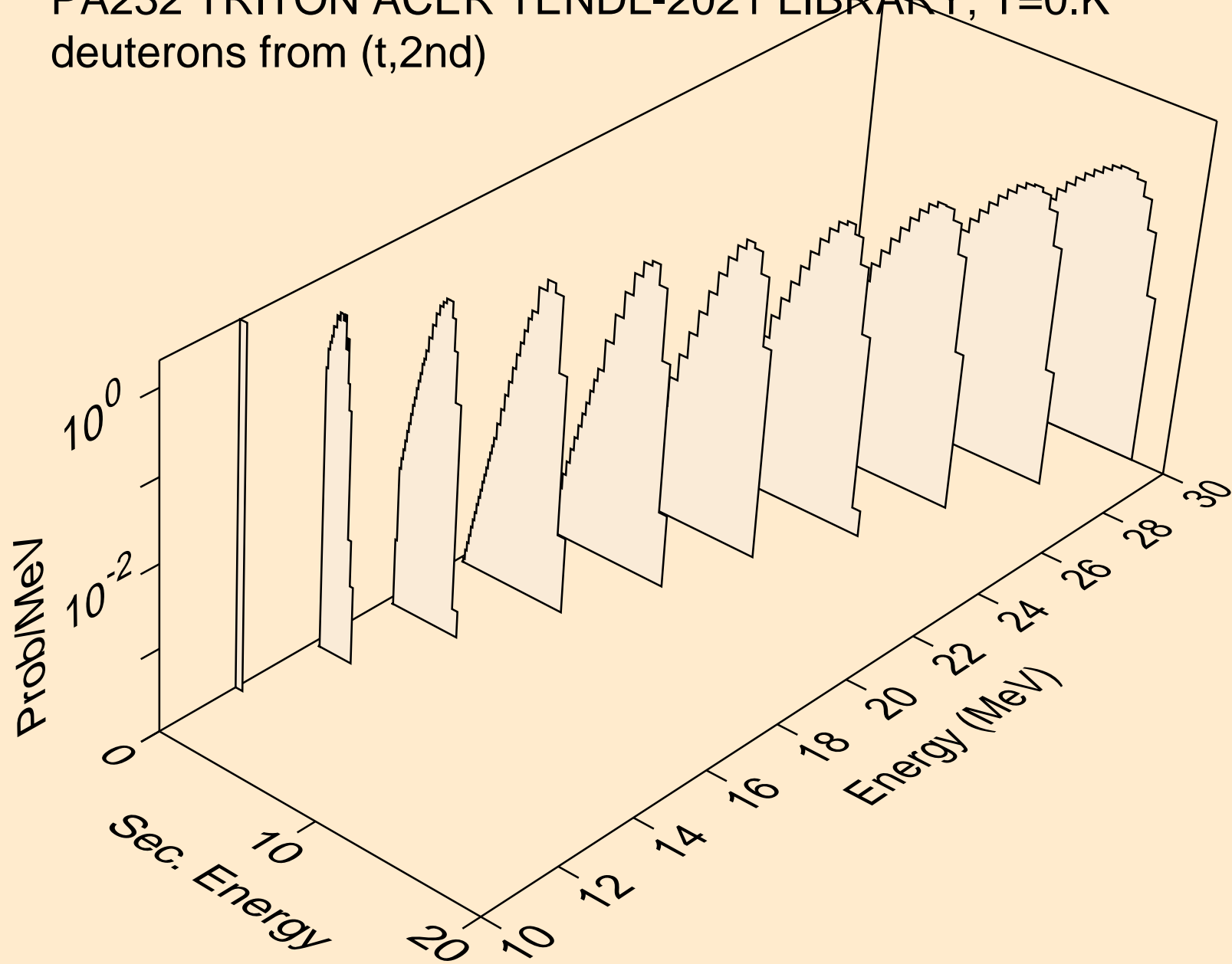

PA232 TRITON ACER TENDL-2021 LIBRARY; T=0.K  
deuterons from (t,n\*)d

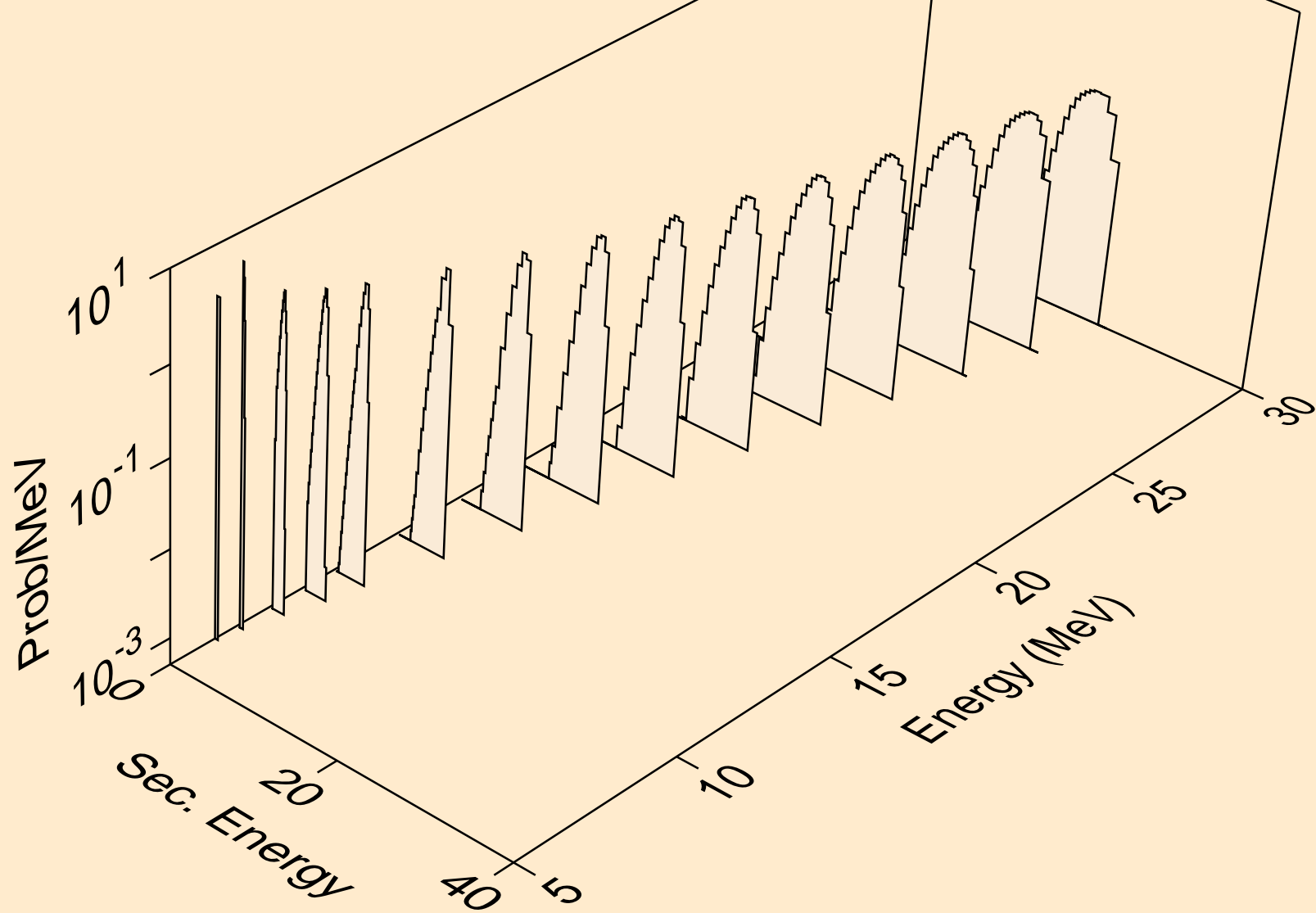



PA232 TRITON ACER TENDL-2021 LIBRARY; T=0.K  
deuterons from (t,d)

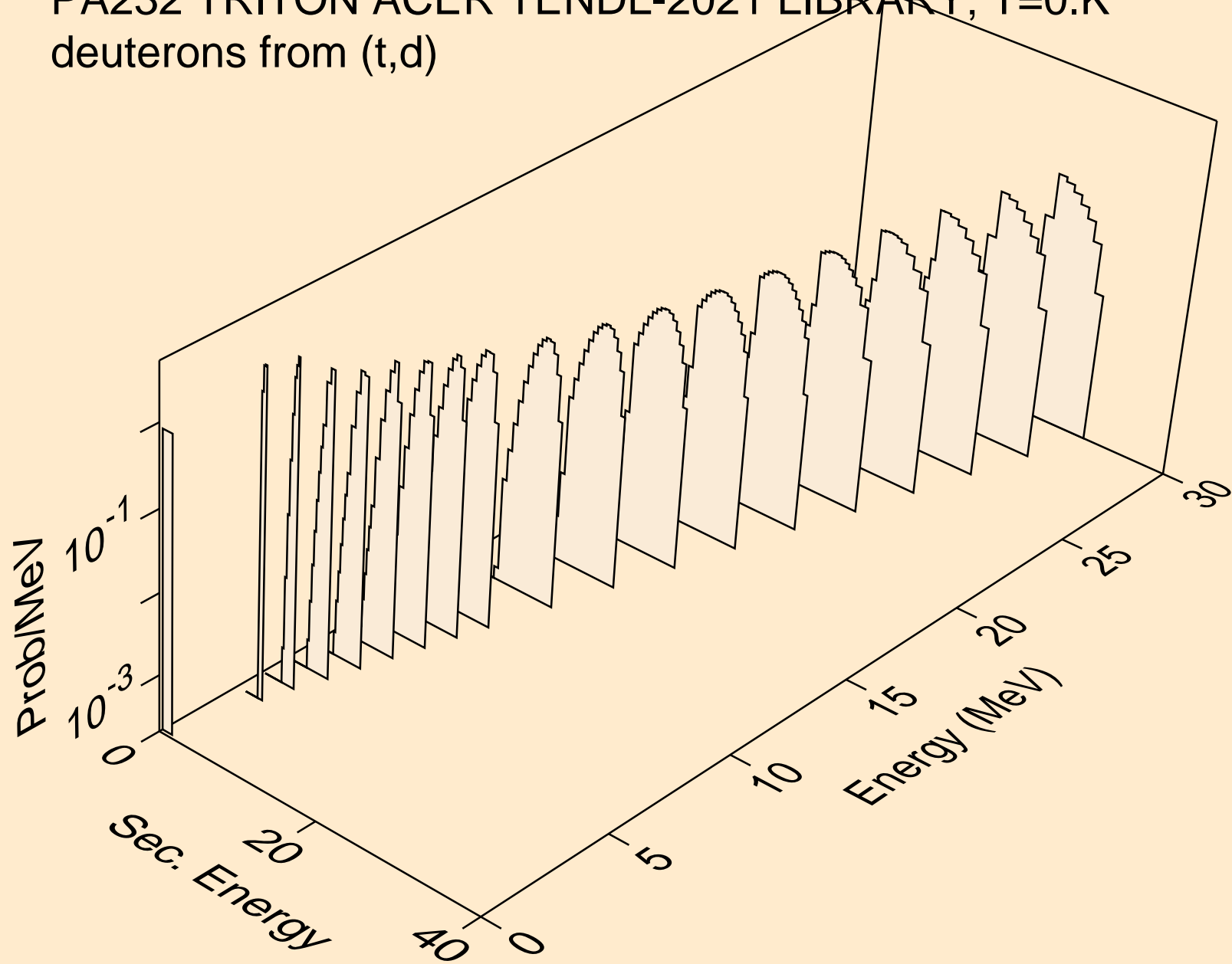

PA232 TRITON ACER TENDL-2021 LIBRARY; T=0.K  
deuterons from (t,pd)

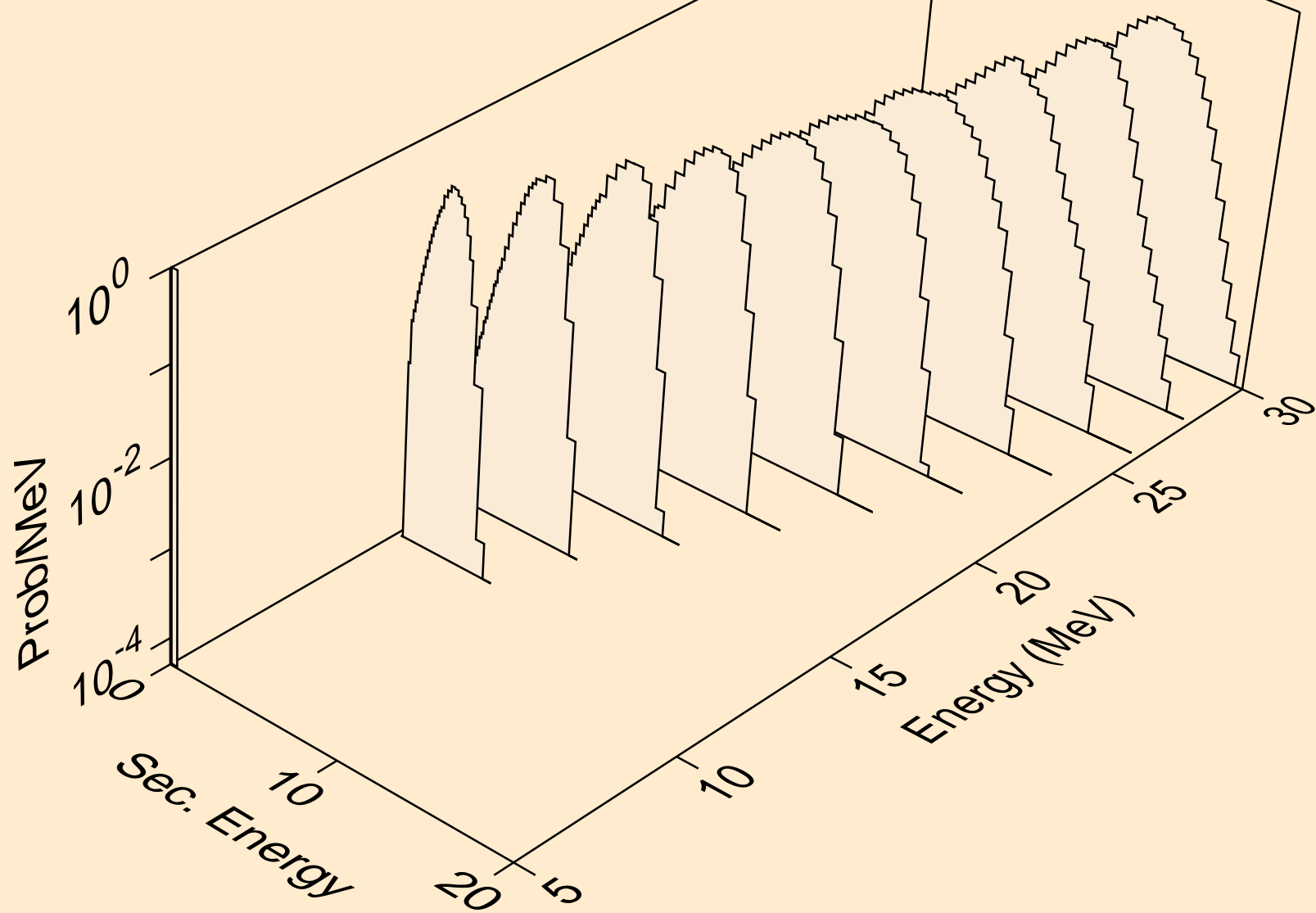

PA232 TRITON ACER TENDL-2021 LIBRARY; T=0.K  
he3s from (t,x)

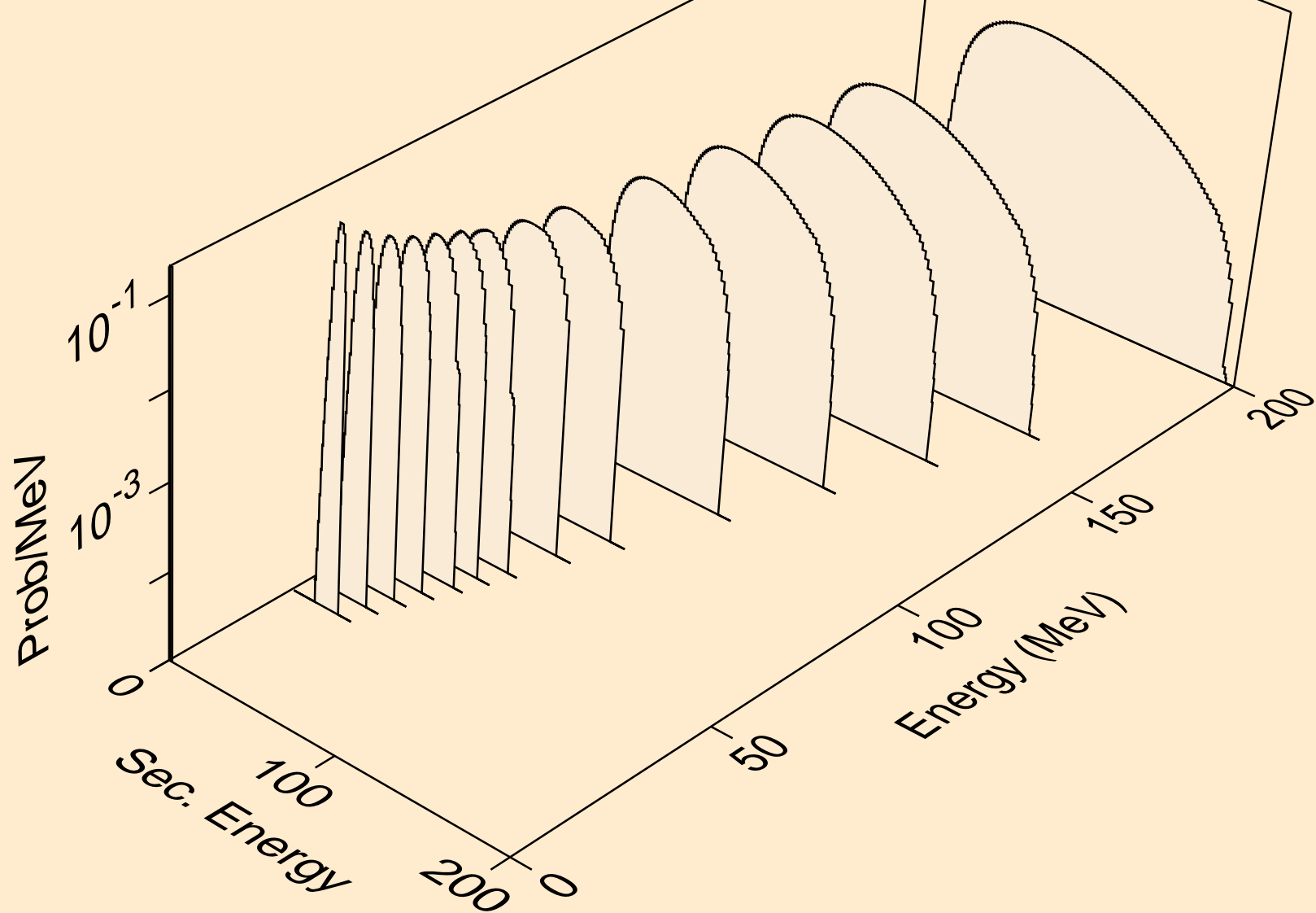

PA232 TRITON ACER TENDL-2021 LIBRARY; T=0.K  
he3s from (t,n\*)he3

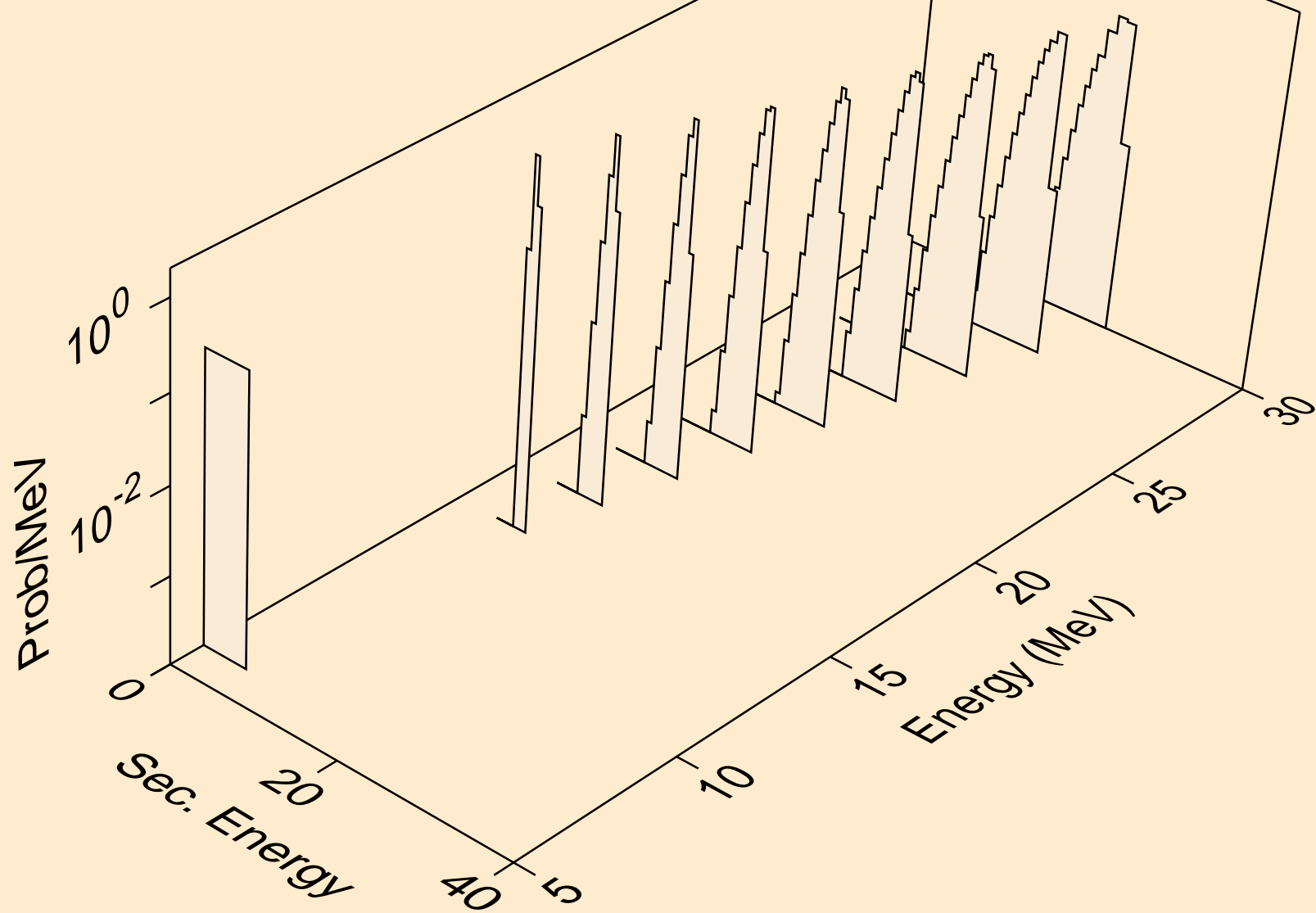

PA232 TRITON ACER TENDL-2021 LIBRARY; T=0.K  
he3s from (t,he3)

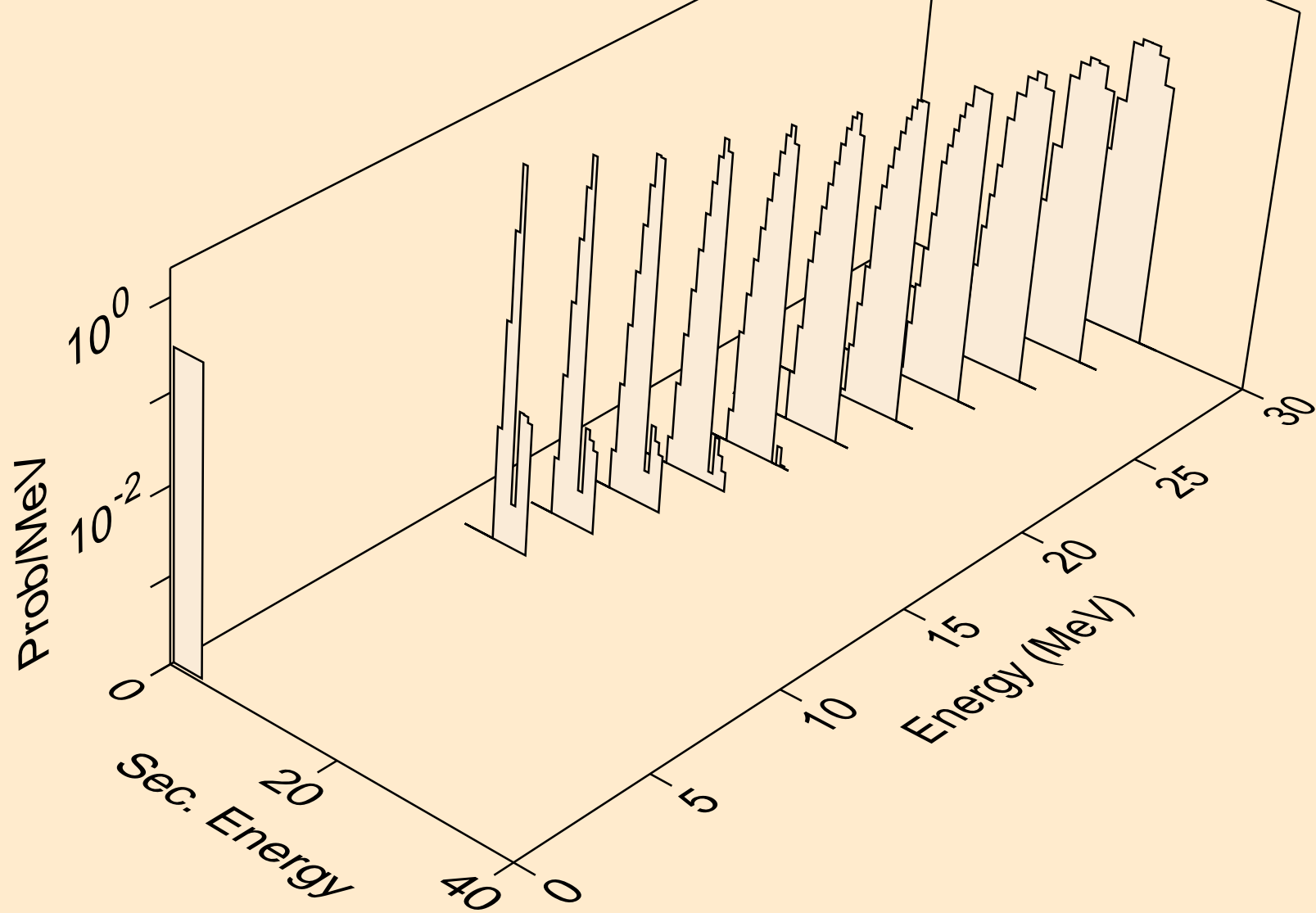

PA232 TRITON ACER TENDL-2021 LIBRARY; T=0.K  
alphas from (t,x)

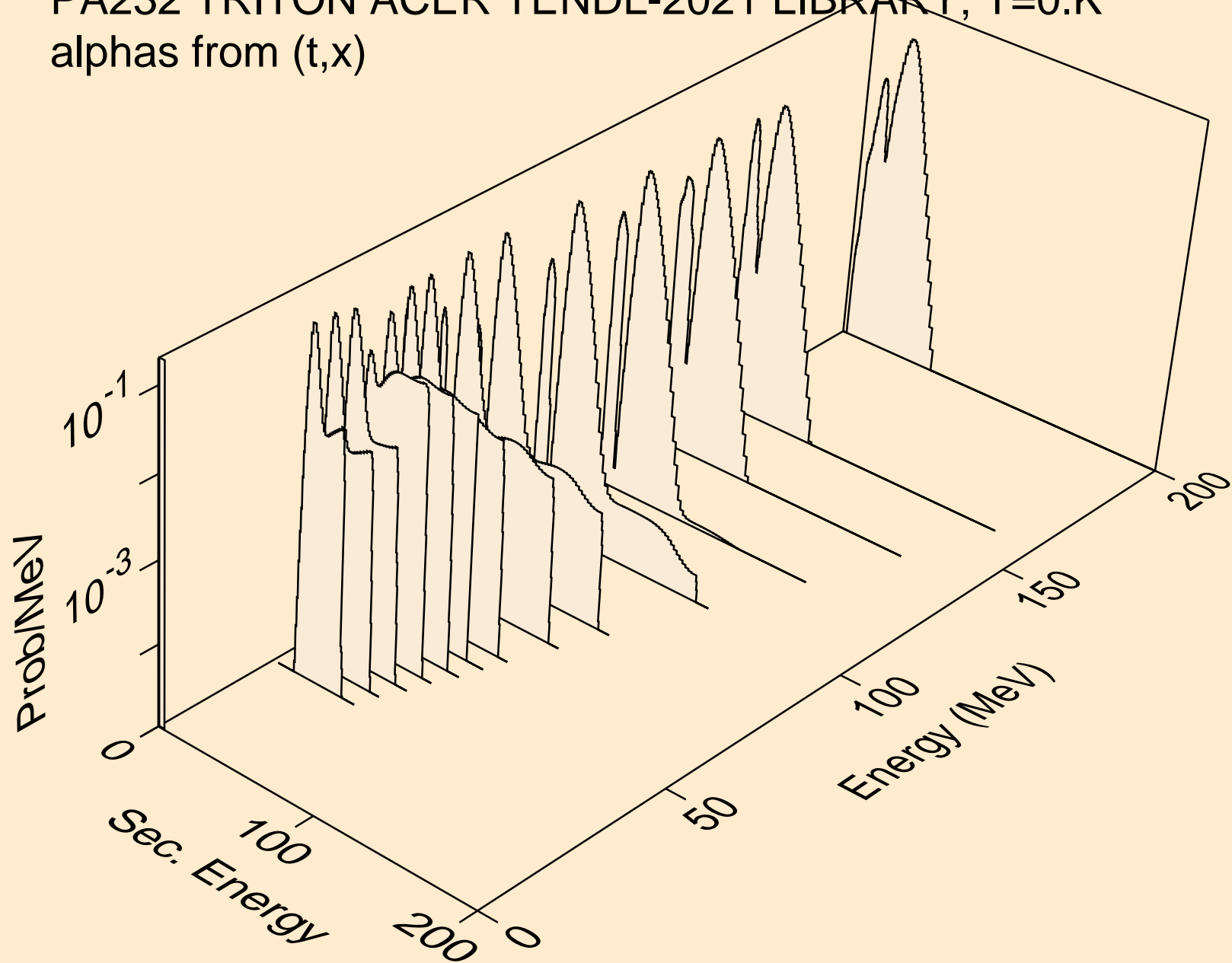

PA232 TRITON ACER TENDL-2021 LIBRARY; T=0.K  
alphas from (t,n\*)a

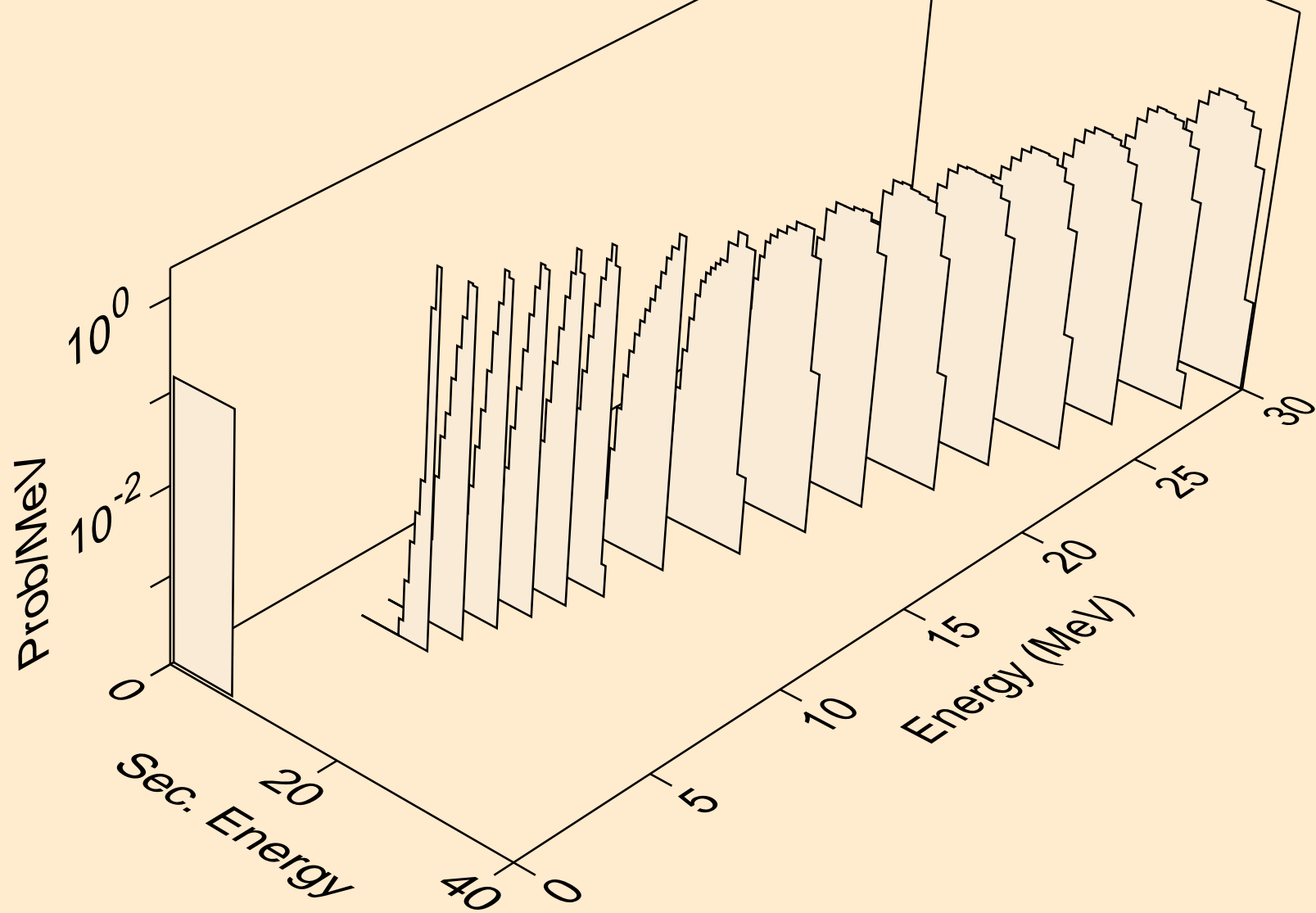

PA232 TRITON ACER TENDL-2021 LIBRARY; T=0.K  
alphas from (t,2n)a

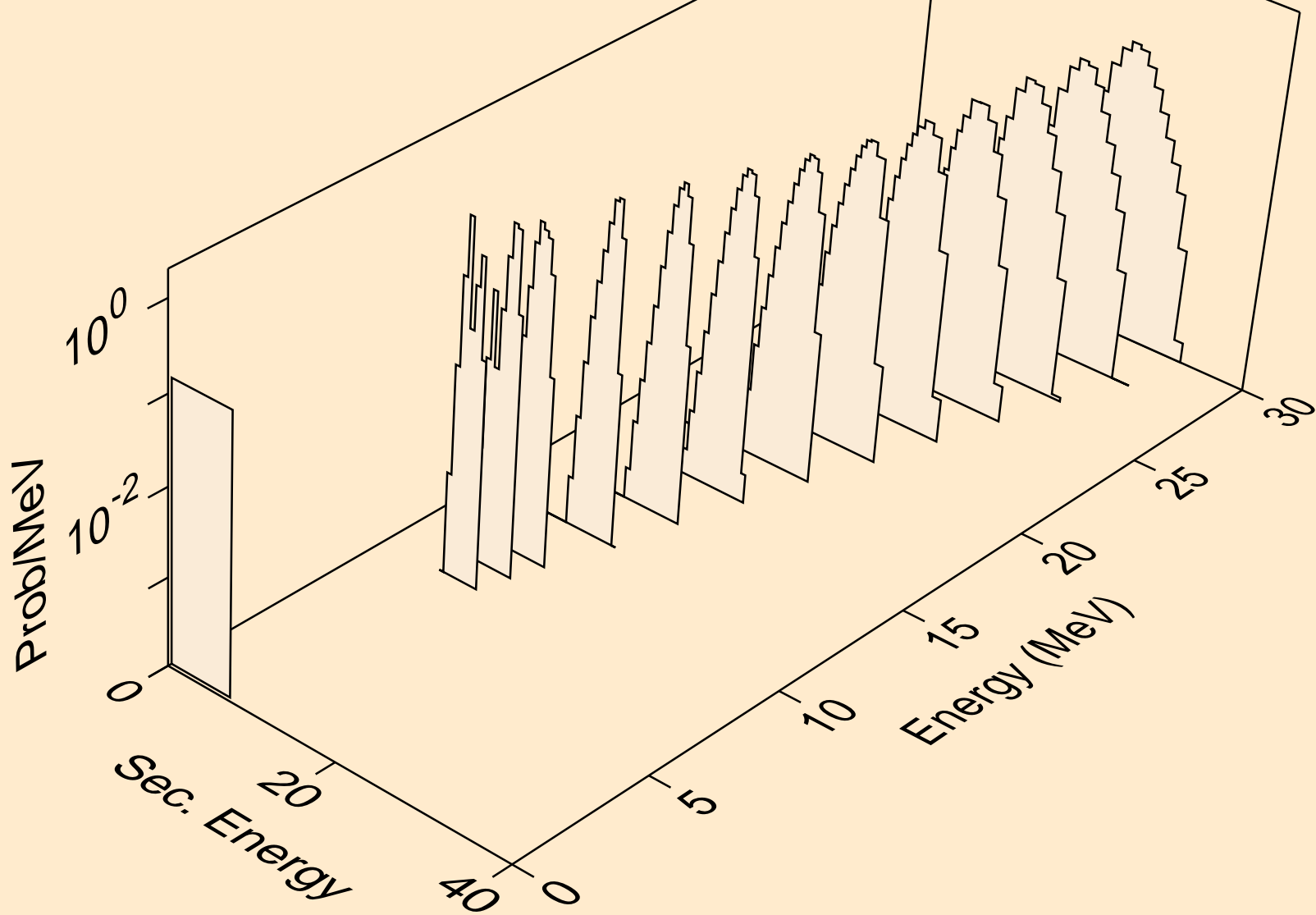



PA232 TRITON ACER TENDL-2021 LIBRARY; T=0.K  
alphas from (t,3n)a

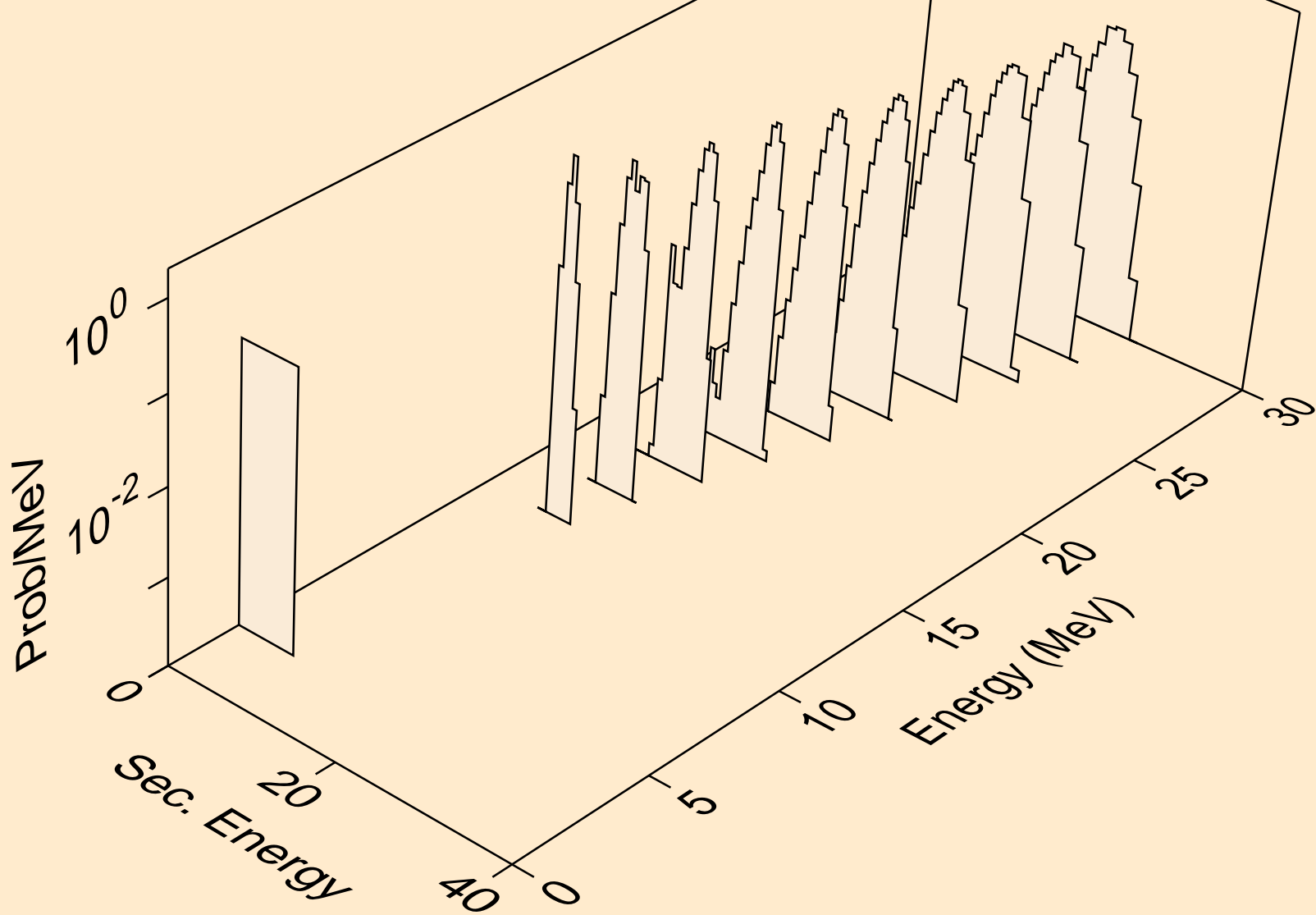

PA232 TRITON ACER TENDL-2021 LIBRARY; T=0.K  
alphas from (t,n\*)2a

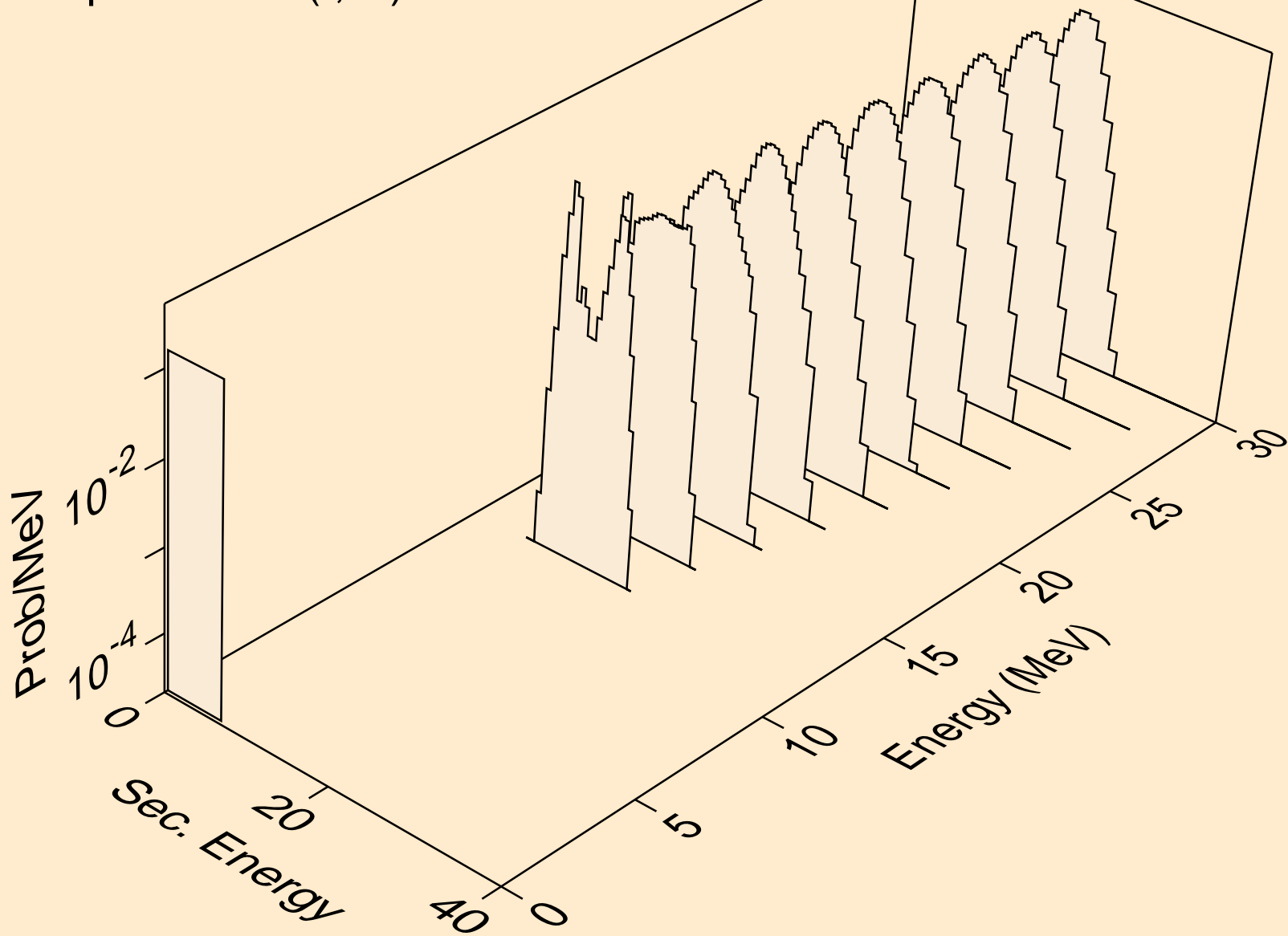

PA232 TRITON ACER TENDL-2021 LIBRARY; T=0.K  
alphas from (t,2n)2a

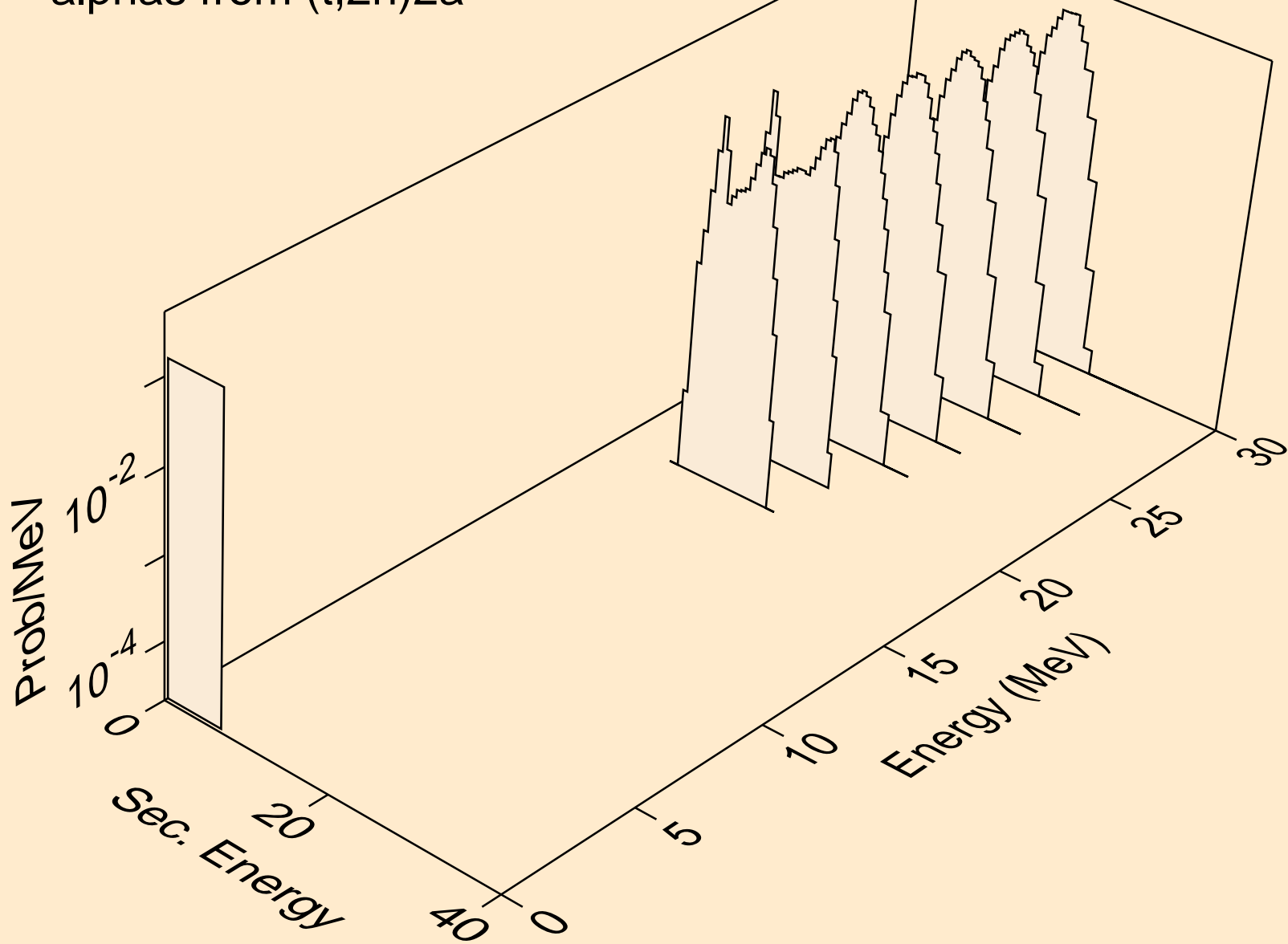

PA232 TRITON ACER TENDL-2021 LIBRARY; T=0.K  
alphas from (t,npa)

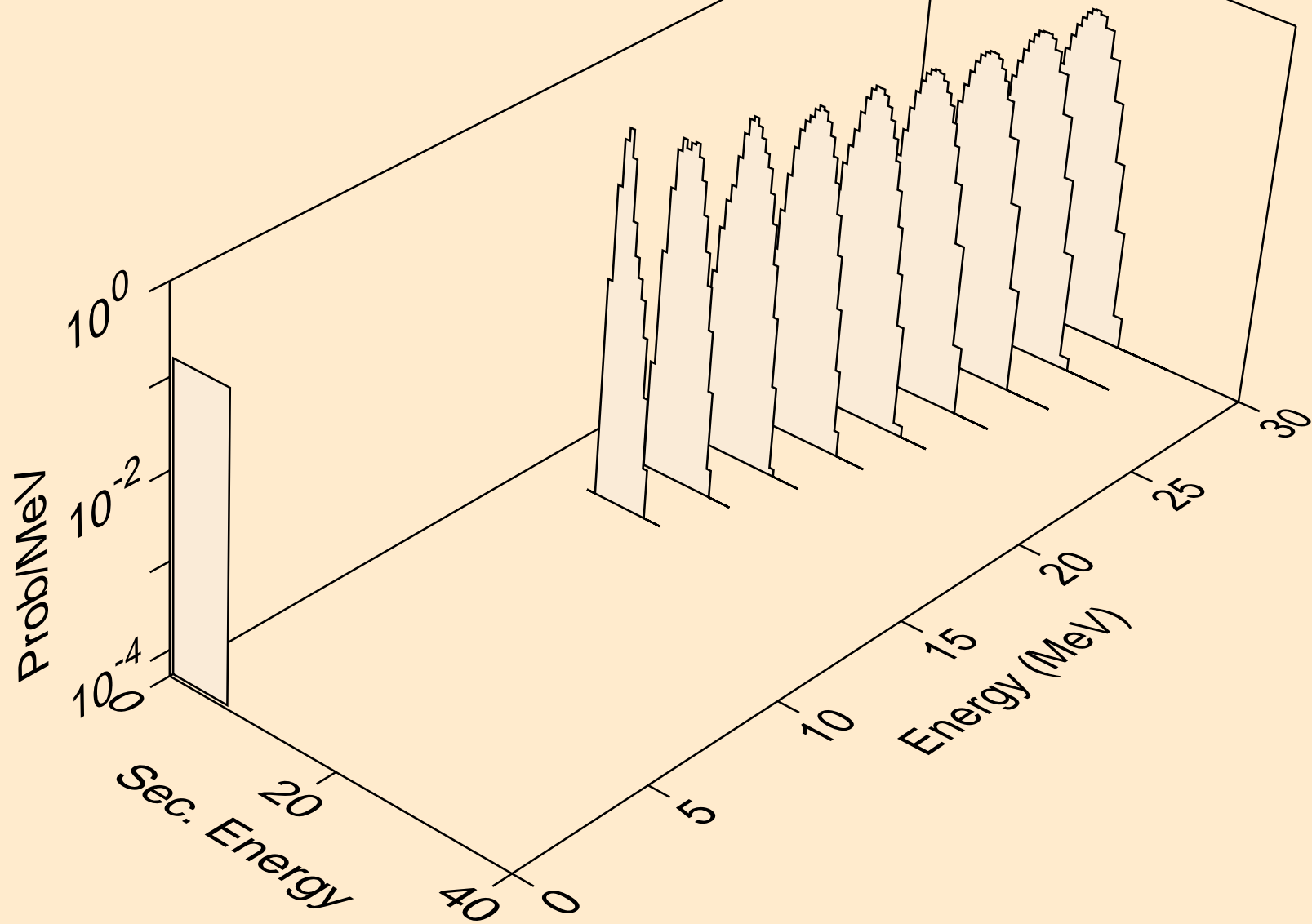

PA232 TRITON ACER TENDL-2021 LIBRARY; T=0.K  
alphas from (t,a)

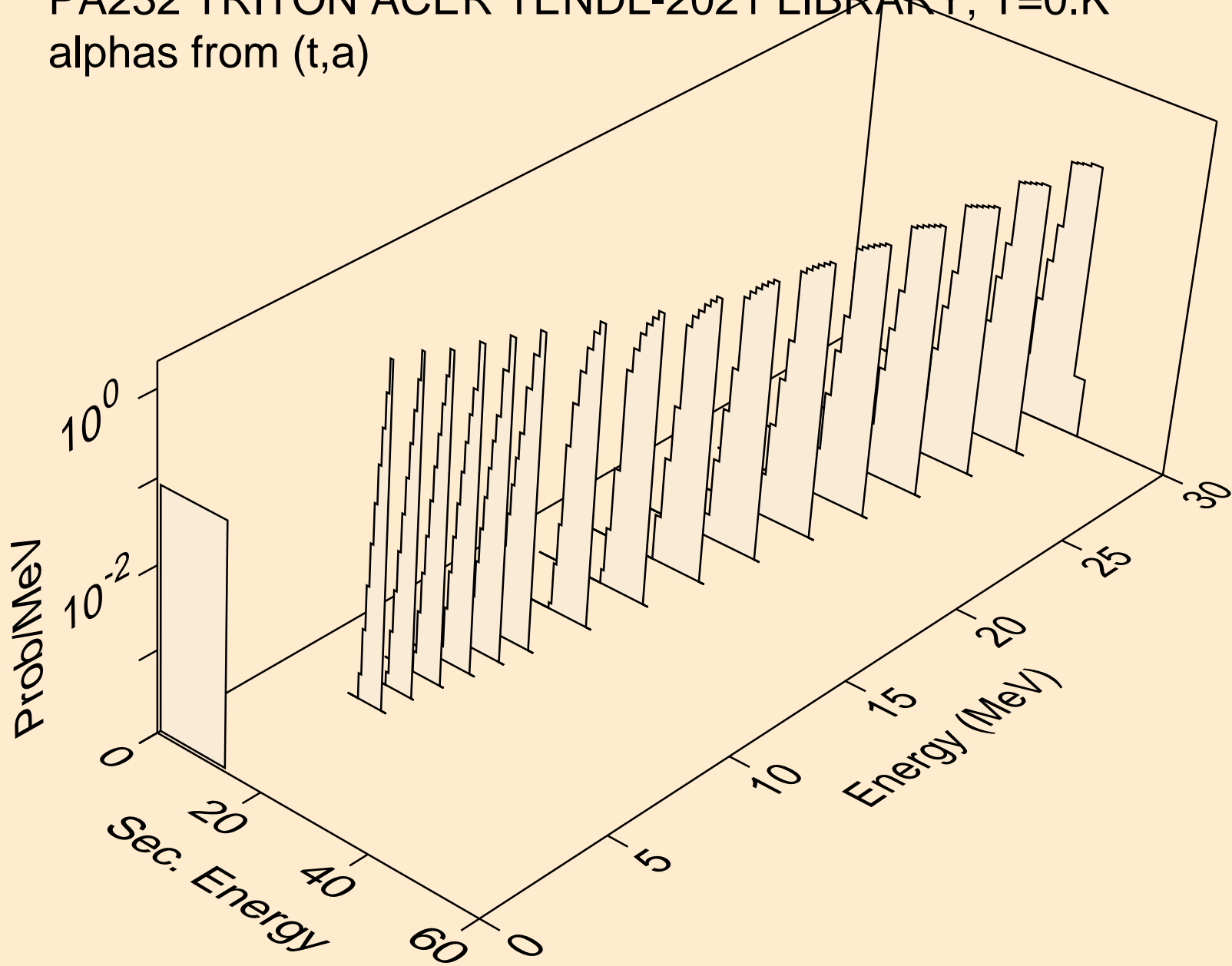

PA232 TRITON ACER TENDL-2021 LIBRARY; T=0.K  
alphas from (t,2a)

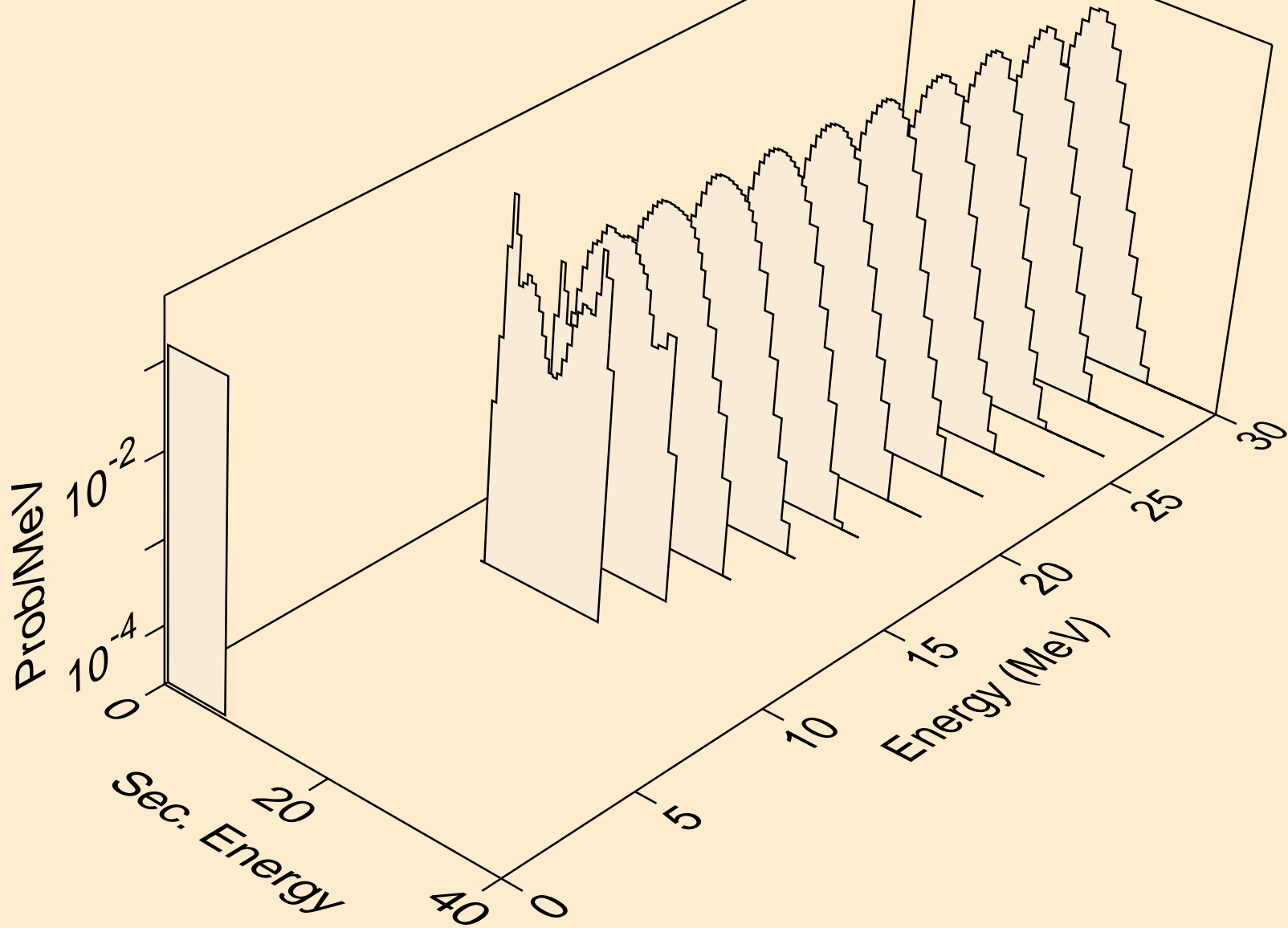

PA232 TRITON ACER TENDL-2021 LIBRARY; T=0.K  
alphas from (t,pa)

