

PB185M TRITON ACER TENDL-2021 LIBRARY; T=0.K  
Principal cross sections

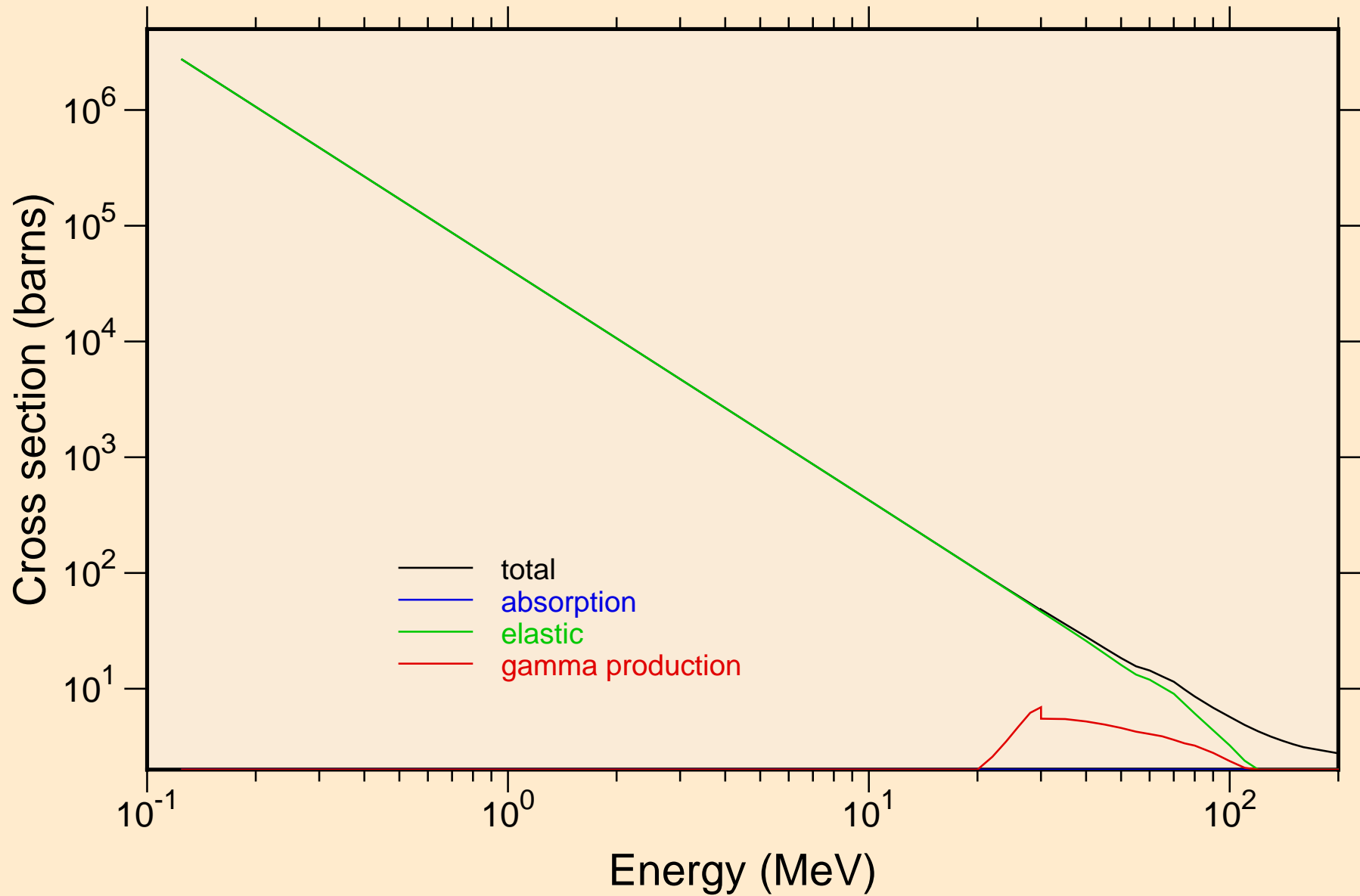

PB185M TRITON ACER TENDL-2021 LIBRARY; T=0.K

Heating

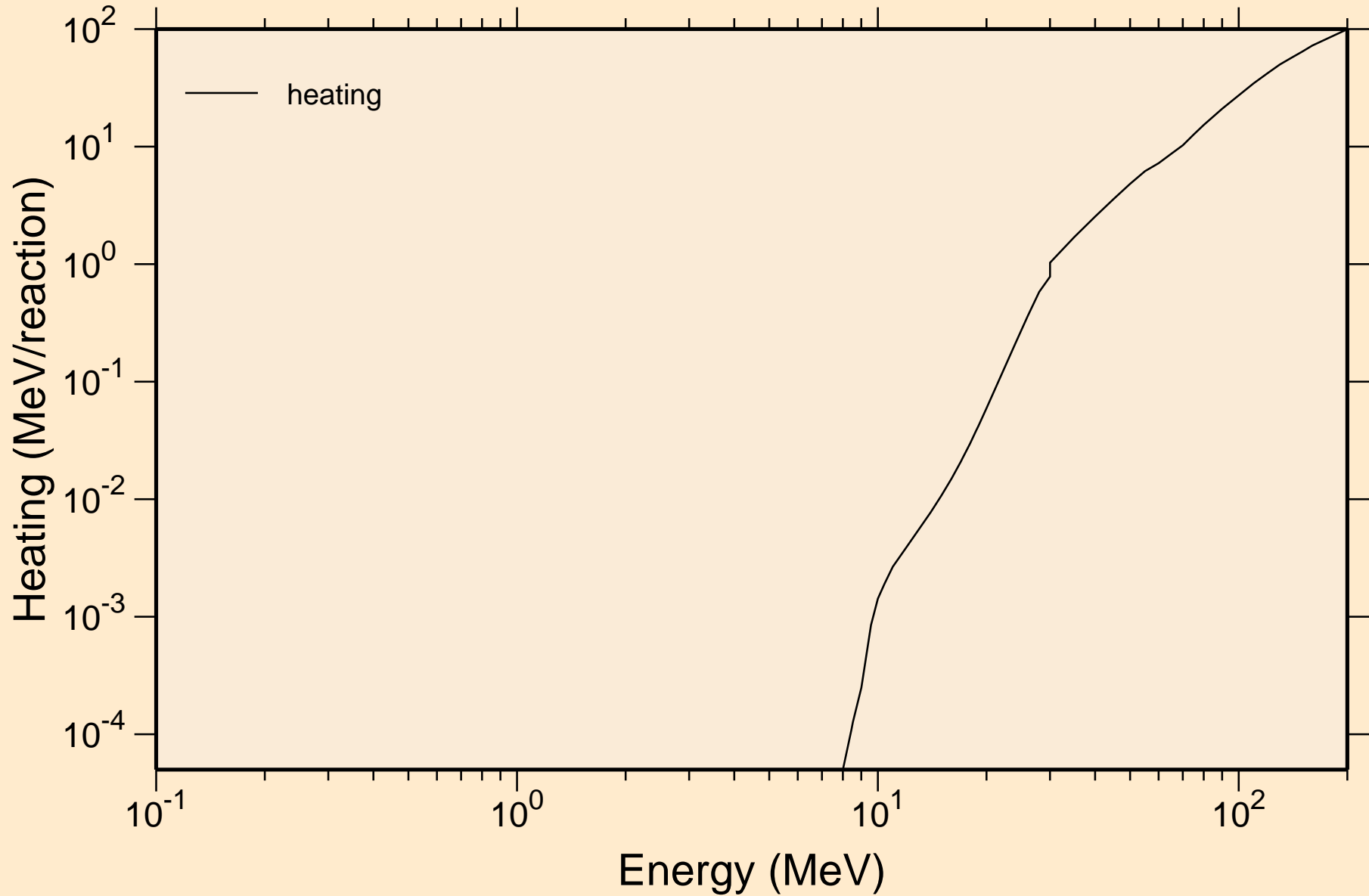

PB185M TRITON ACER TENDL-2021 LIBRARY; T=0.K

Principal cross sections

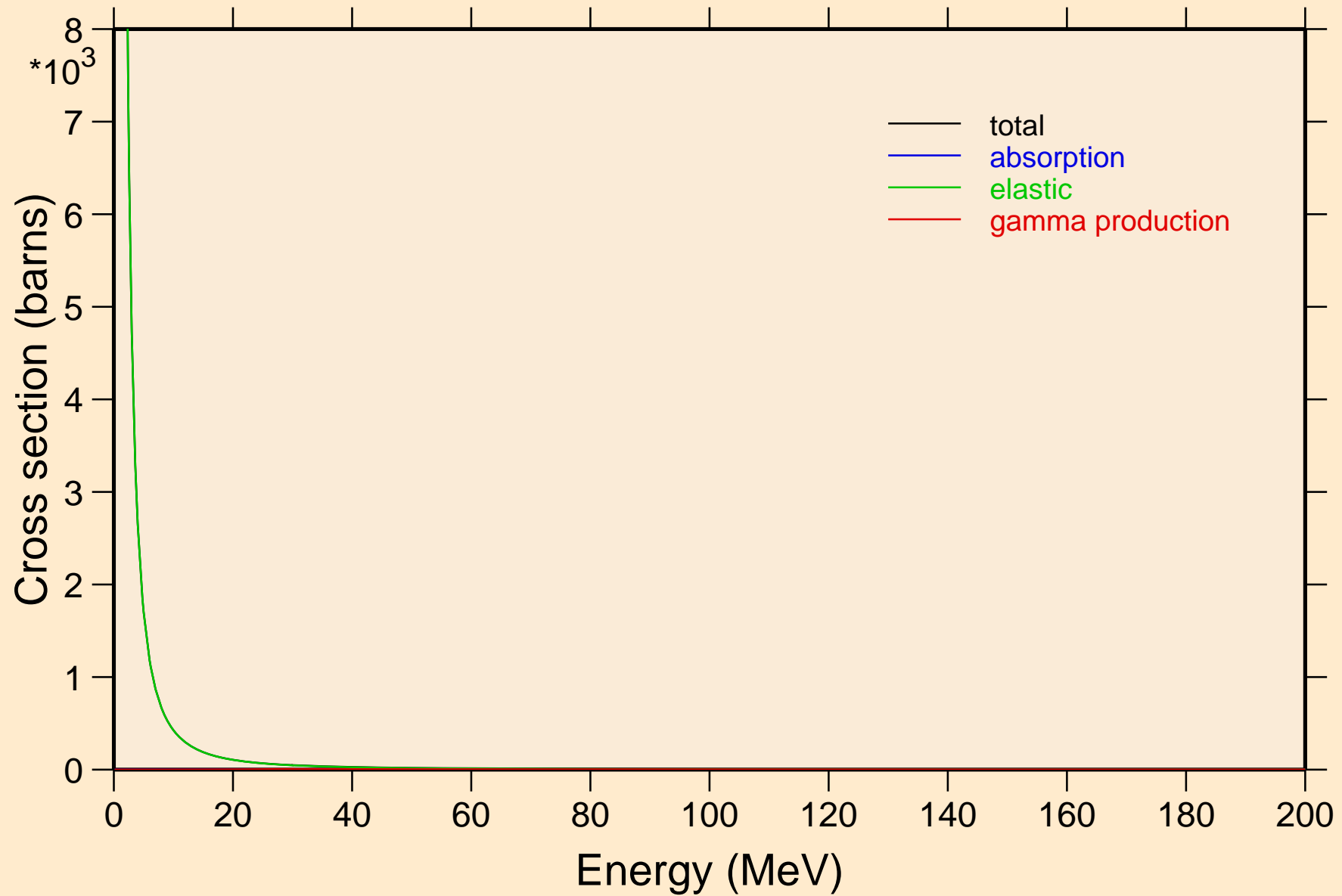

PB185M TRITON ACER TENDL-2021 LIBRARY; T=0.K

Heating

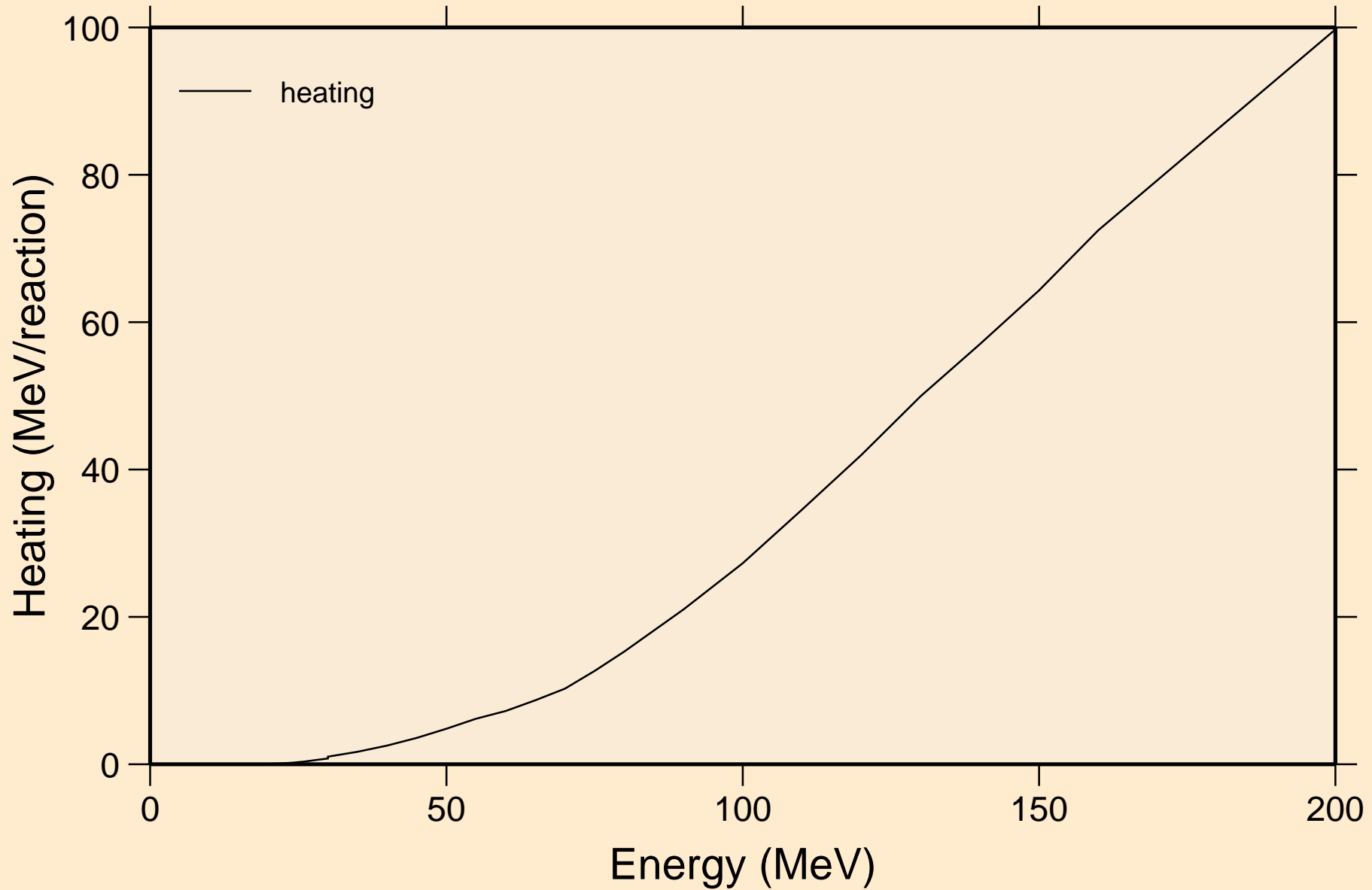

PB185M TRITON ACER TENDL-2021 LIBRARY; T=0.K  
Threshold reactions

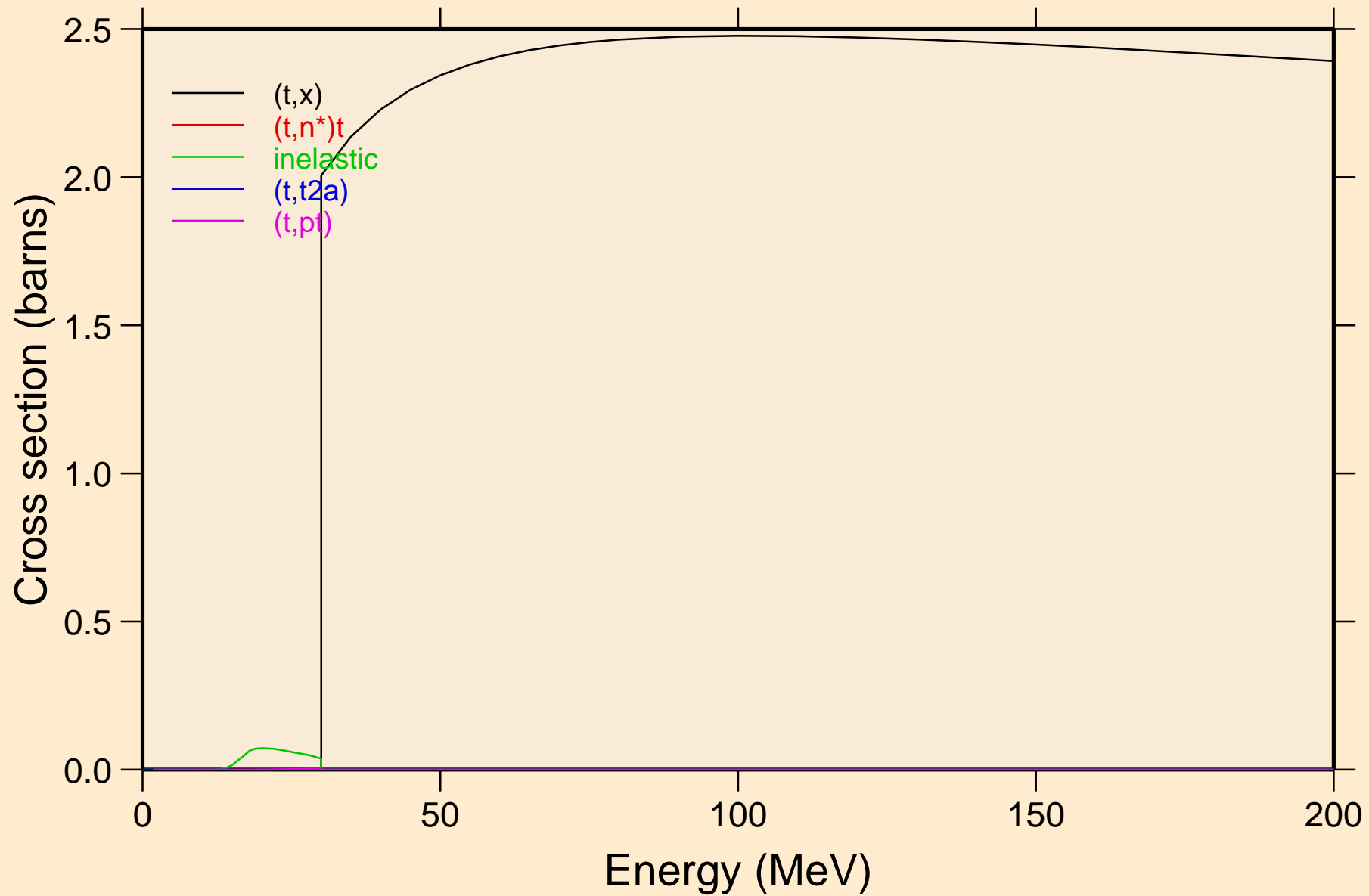

PB185M TRITON ACER TENDL-2021 LIBRARY; T=0.K  
Threshold reactions

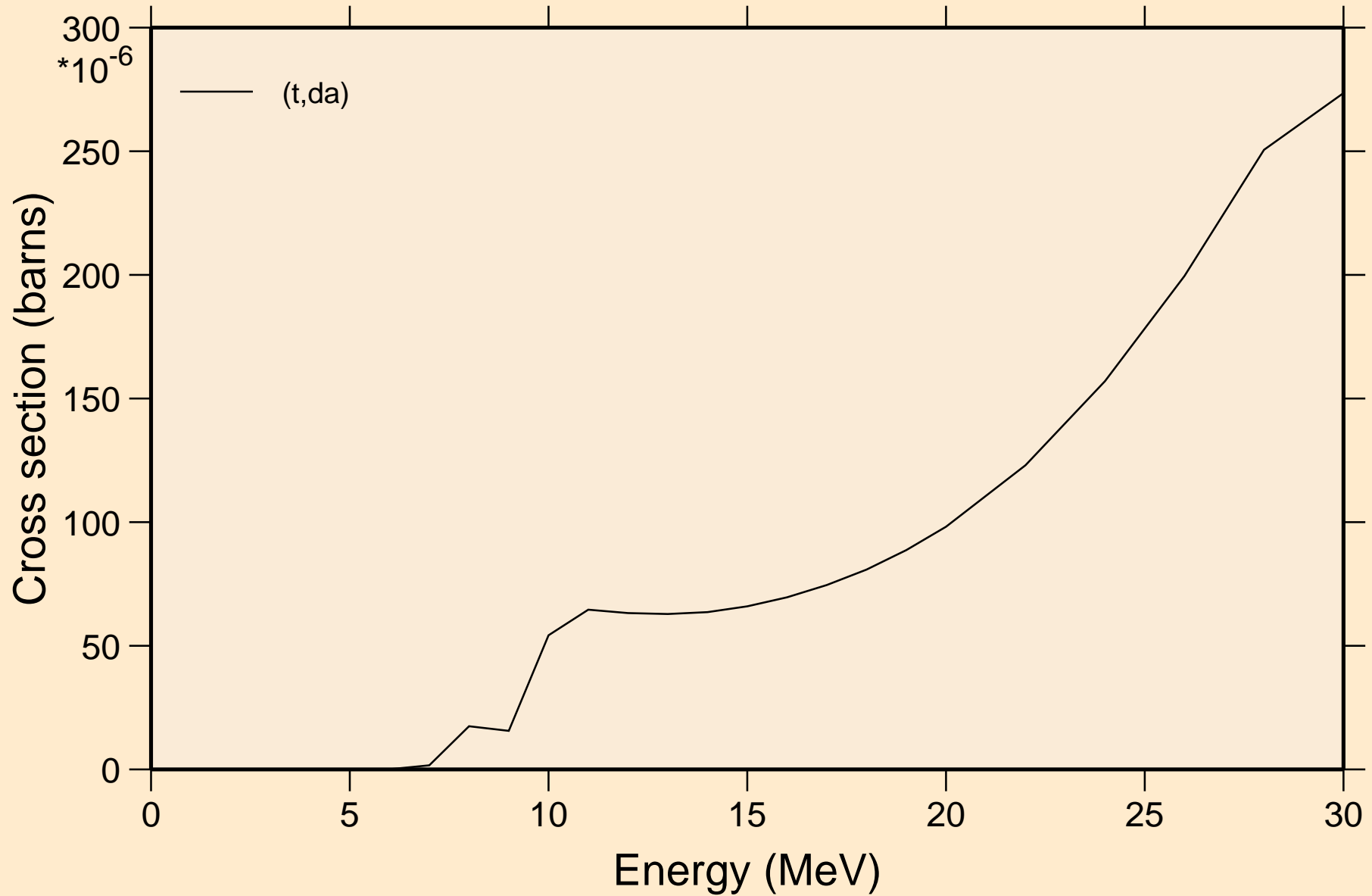

PB185M TRITON ACER TENDL-2021 LIBRARY; T=0.K  
angular distribution for elastic

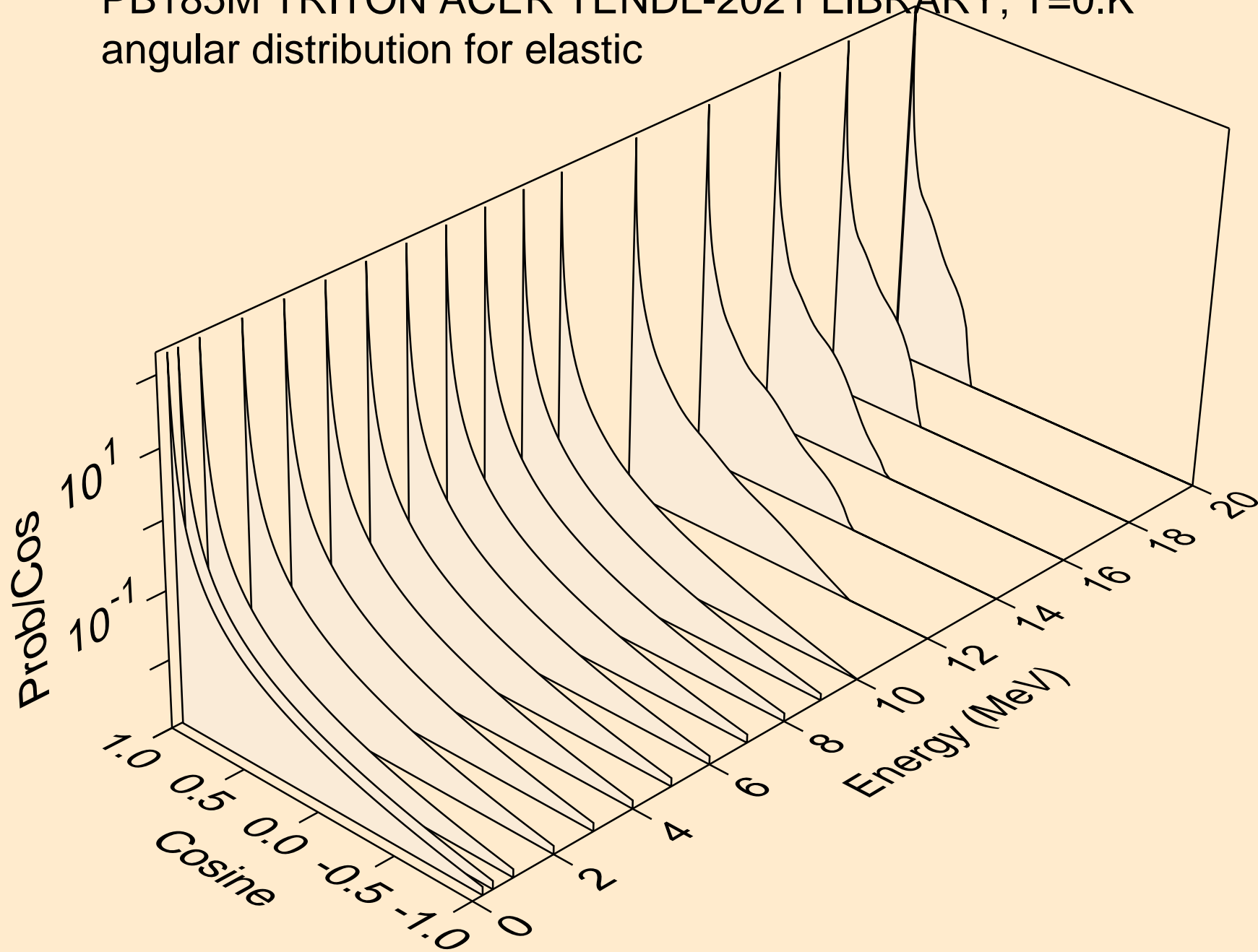

PB185M TRITON ACER TENDL-2021 LIBRARY; T=0.K  
angular distribution for elastic

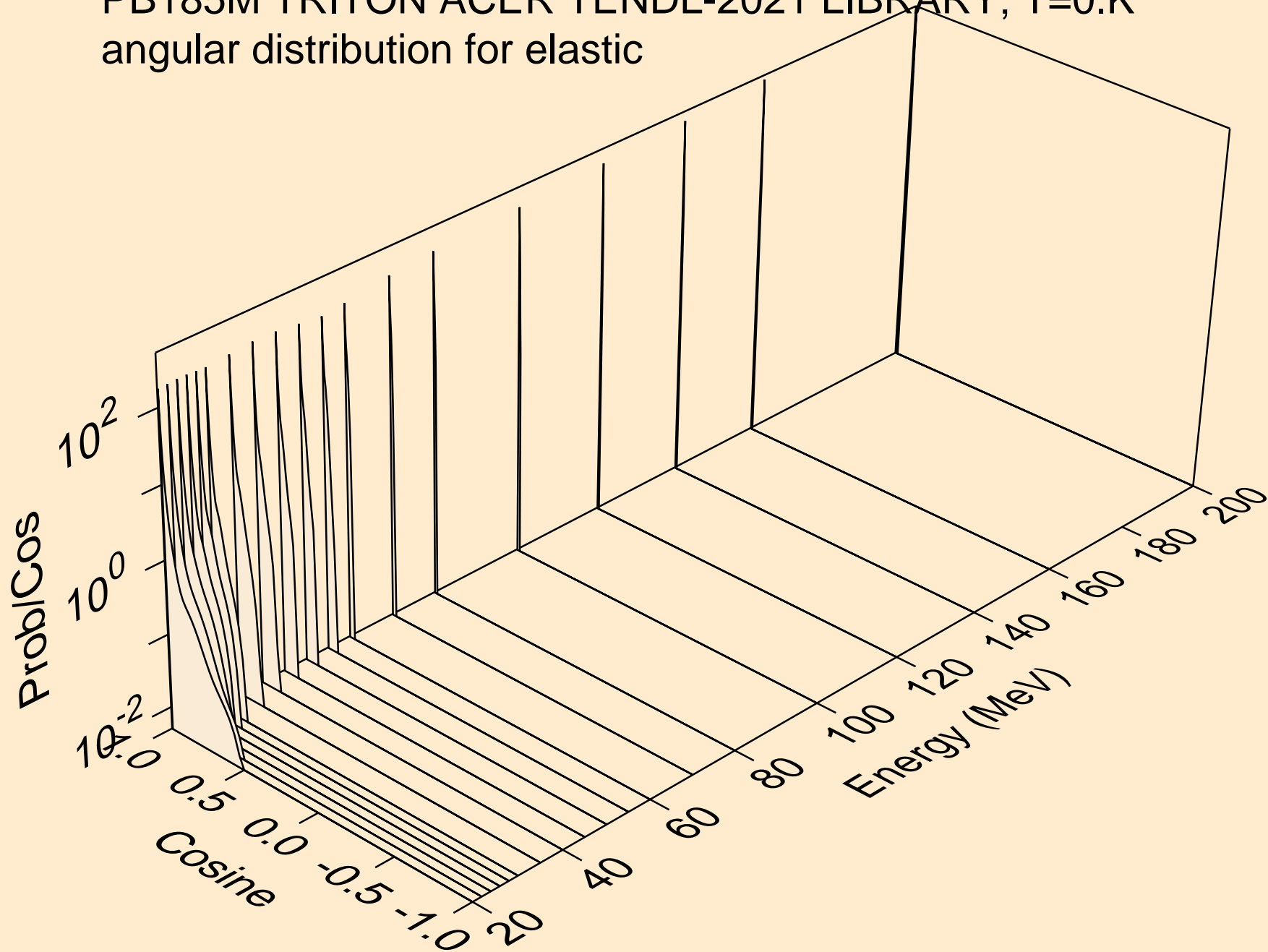



PB185M TRITON ACER TENDL-2021 LIBRARY; T=0.K  
Triton emission for (t,x)

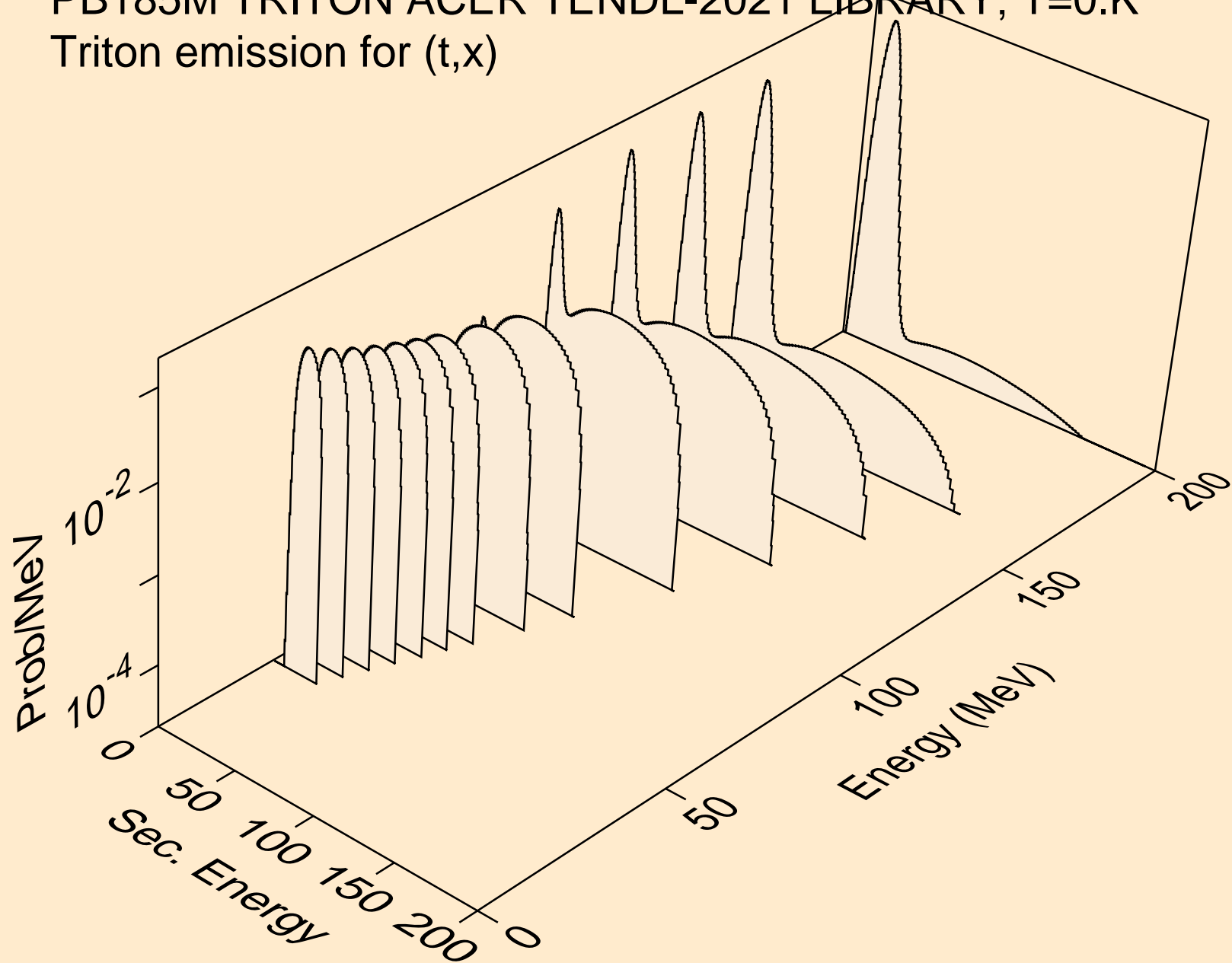

PB185M TRITON ACER TENDL-2021 LIBRARY; T=0.K  
Triton emission for (t,n\*)t

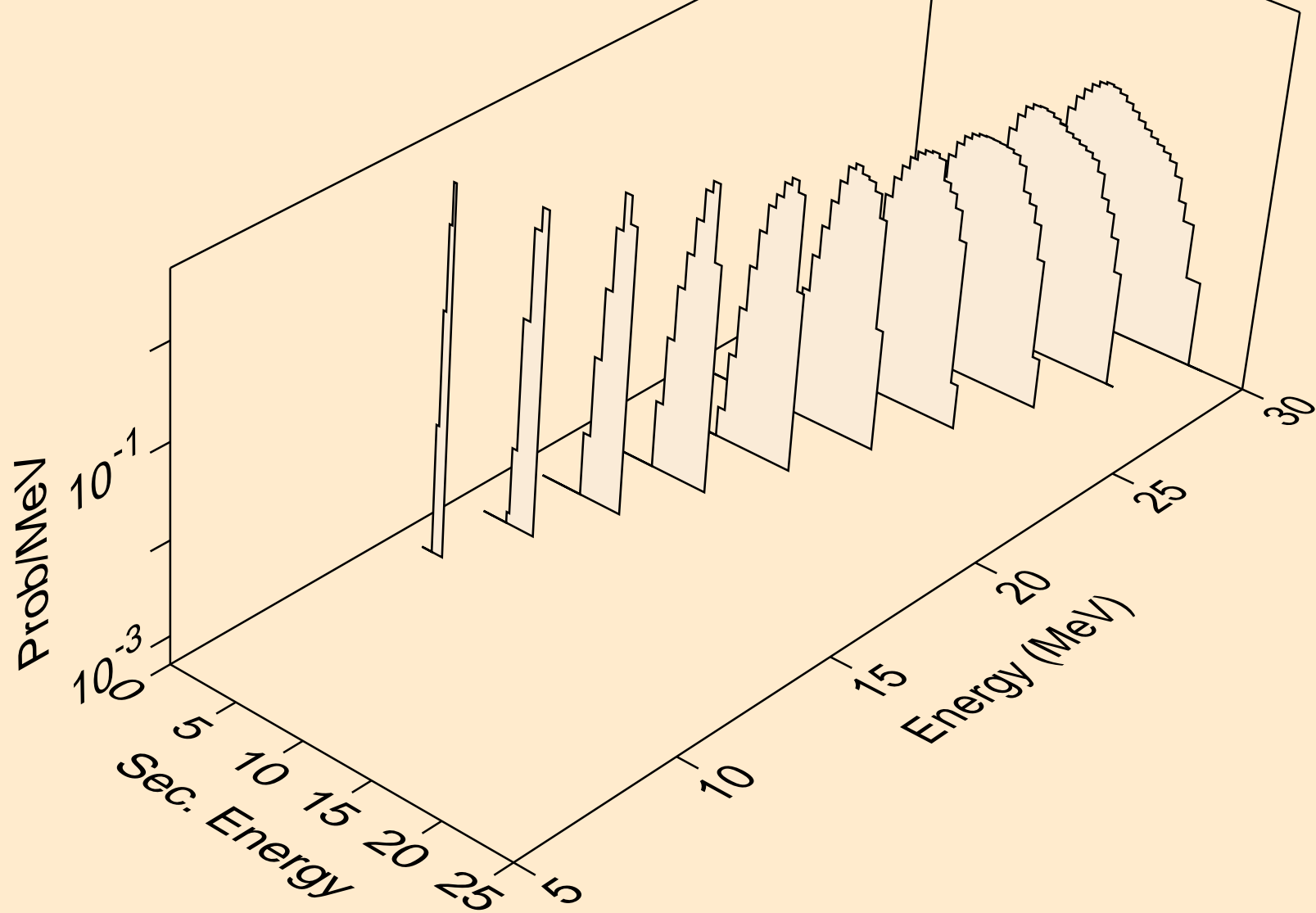

PB185M TRITON ACER TENDL-2021 LIBRARY; T=0.K  
Triton emission for inelastic

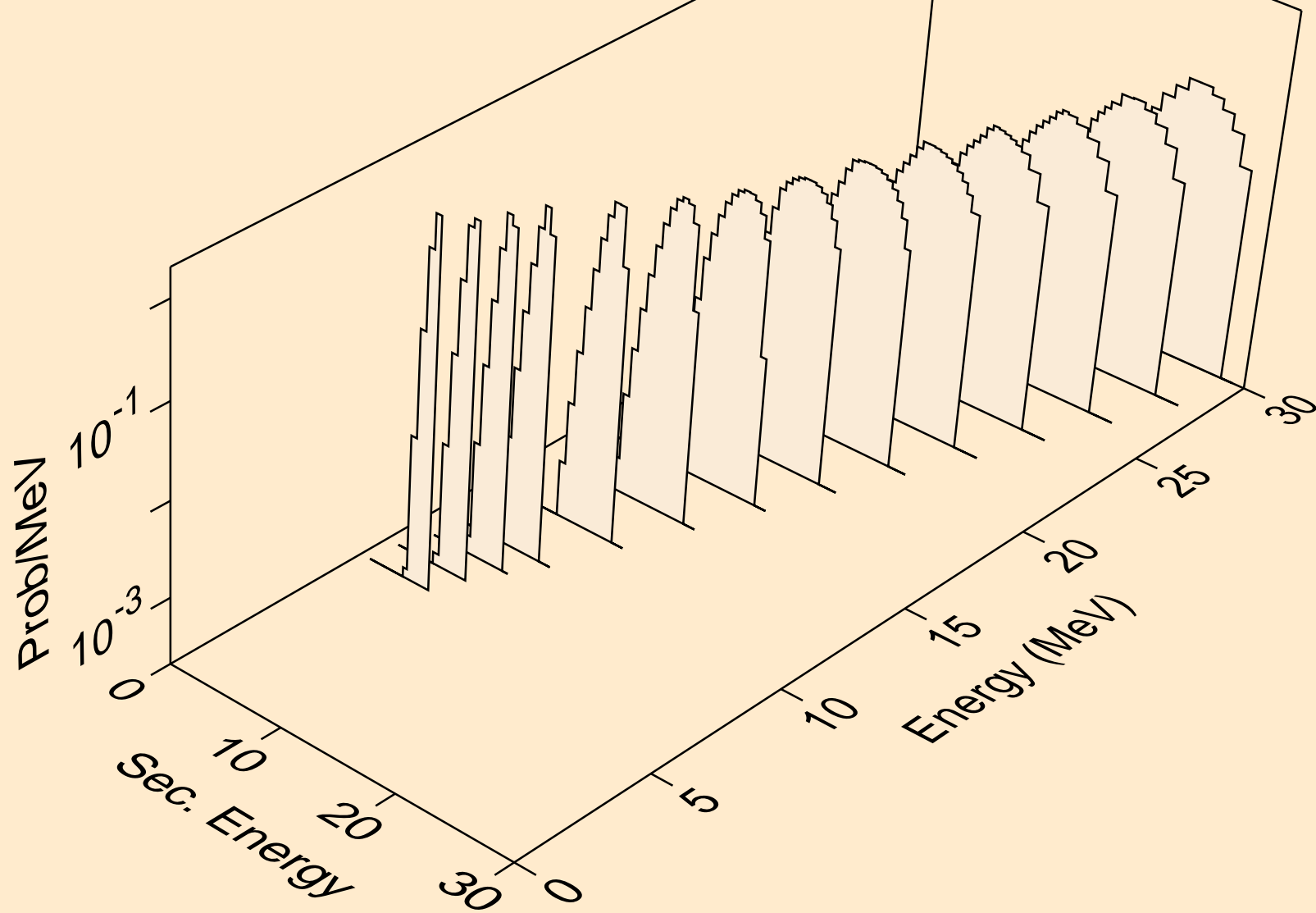

PB185M TRITON ACER TENDL-2021 LIBRARY; T=0.K  
Triton emission for (t,t2a)

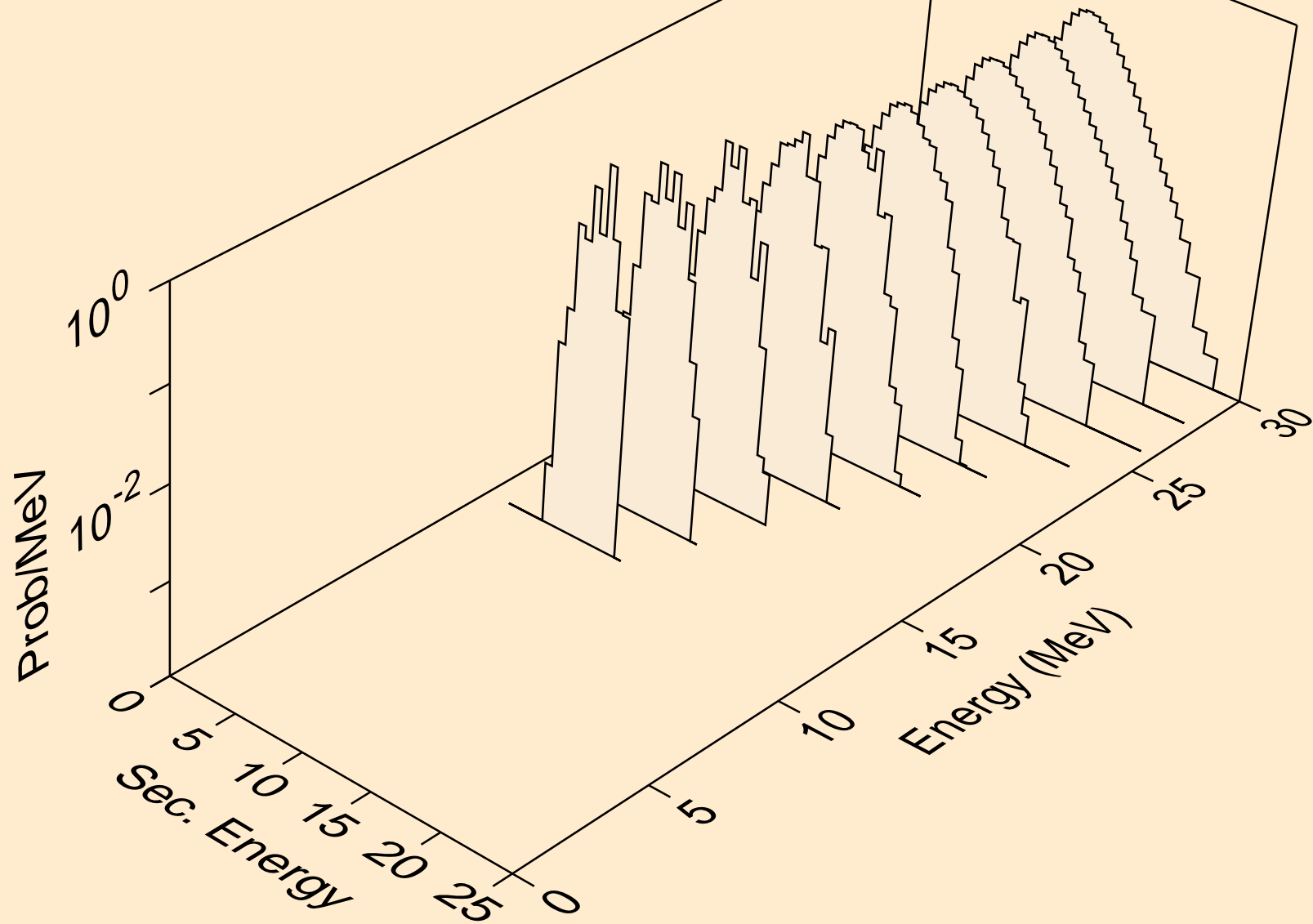

PB185M TRITON ACER TENDL-2021 LIBRARY; T=0.K  
Triton emission for (t,pt)

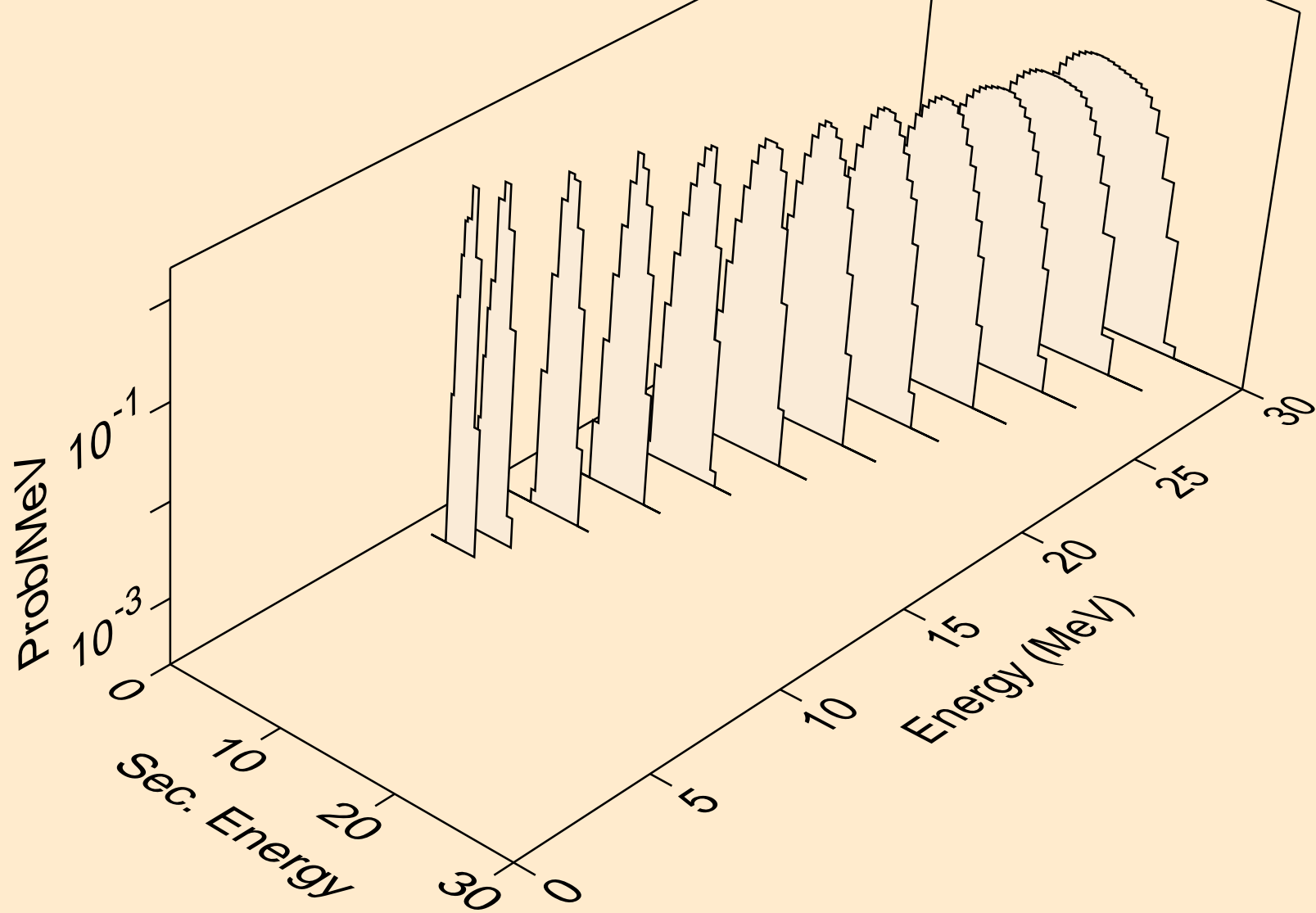

PB185M TRITON ACER TENDL-2021 LIBRARY; T=0.K  
Photon emission for (z,n)

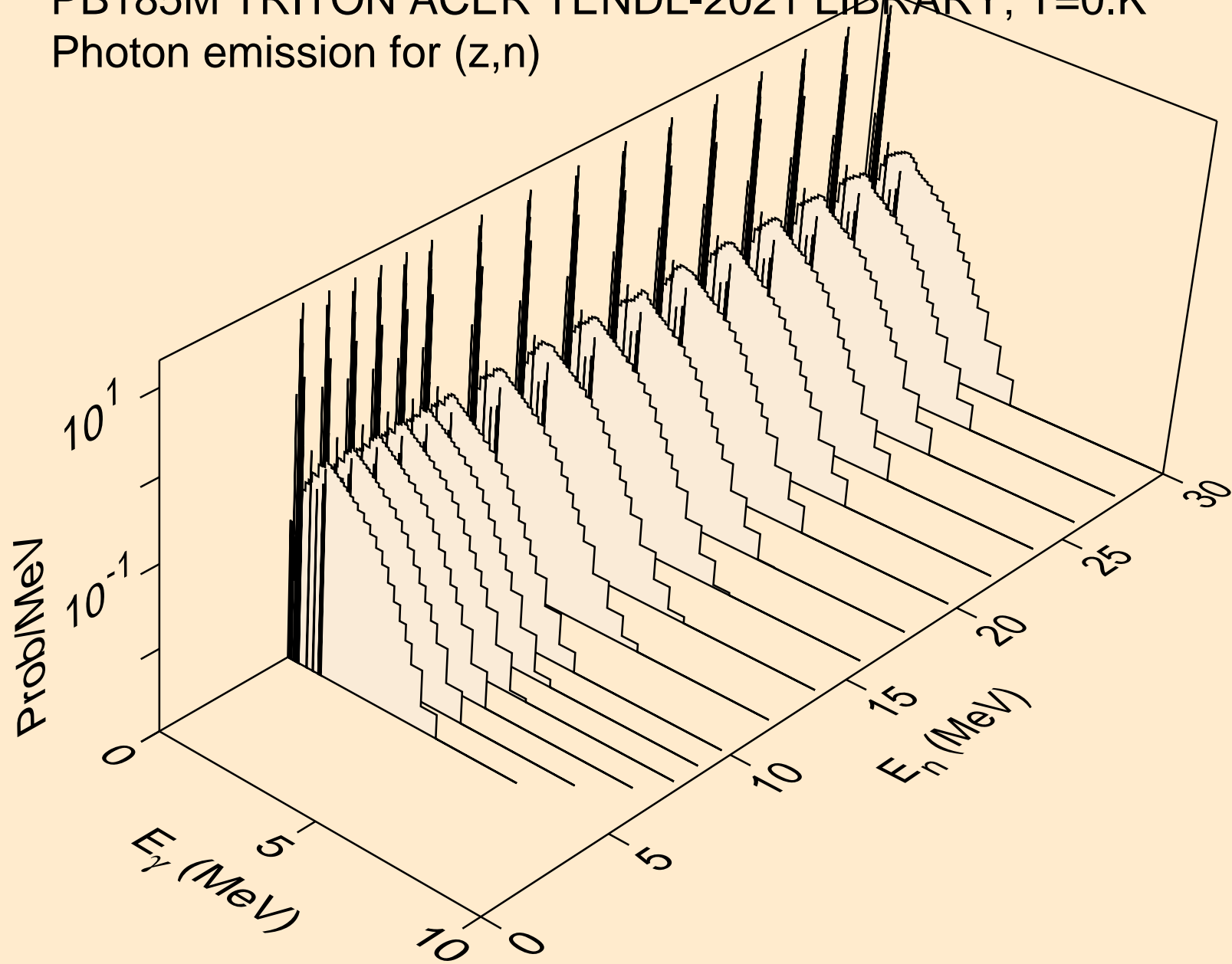

PB185M TRITON ACER TENDL-2021 LIBRARY; T=0.K  
Photon emission for (n,x)

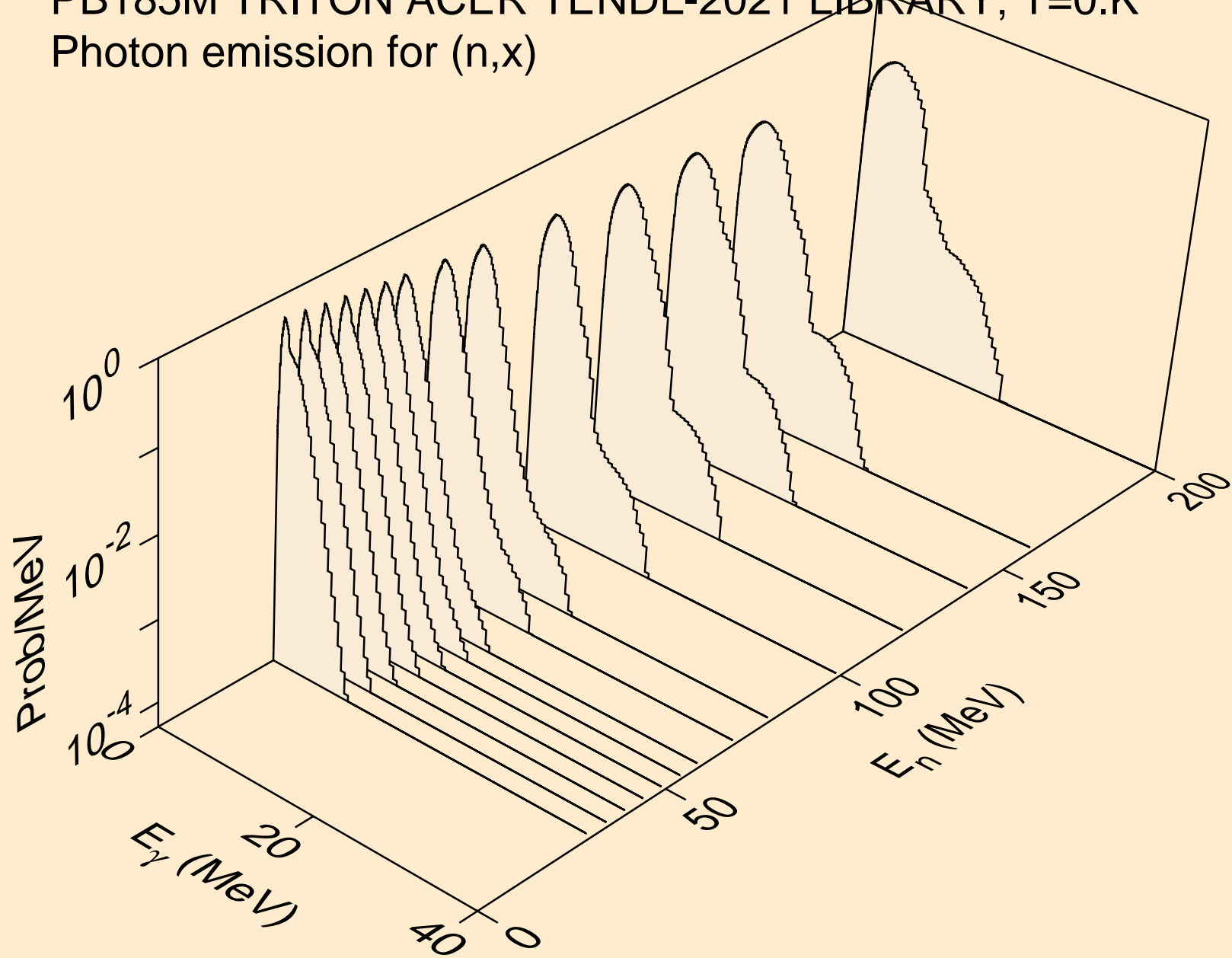

PB185M TRITON ACER TENDL-2021 LIBRARY; T=0.K  
Photon emission for (n,2nd)

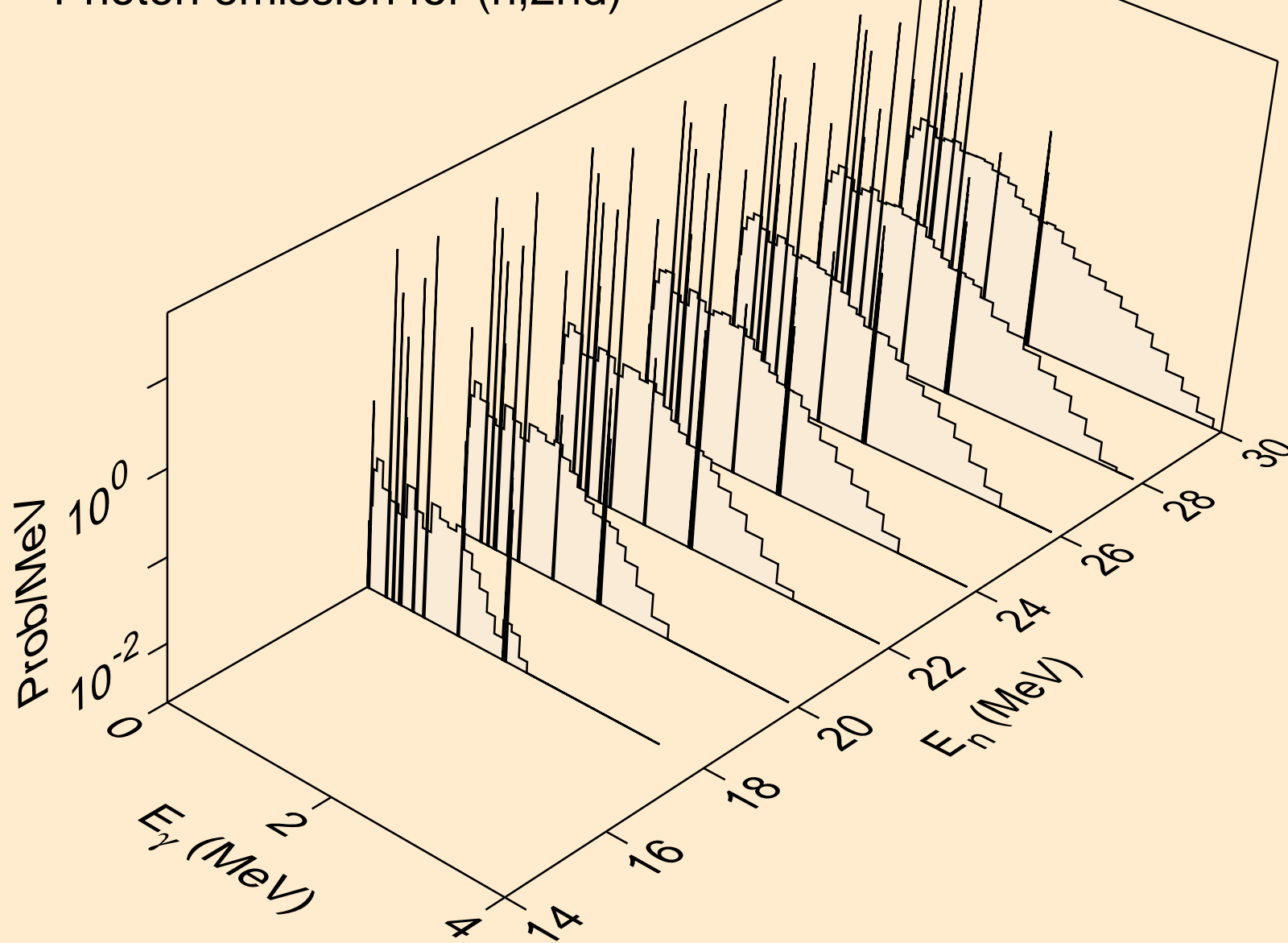



PB185M TRITON ACER TENDL-2021 LIBRARY; T=0.K  
Photon emission for (n,2n)

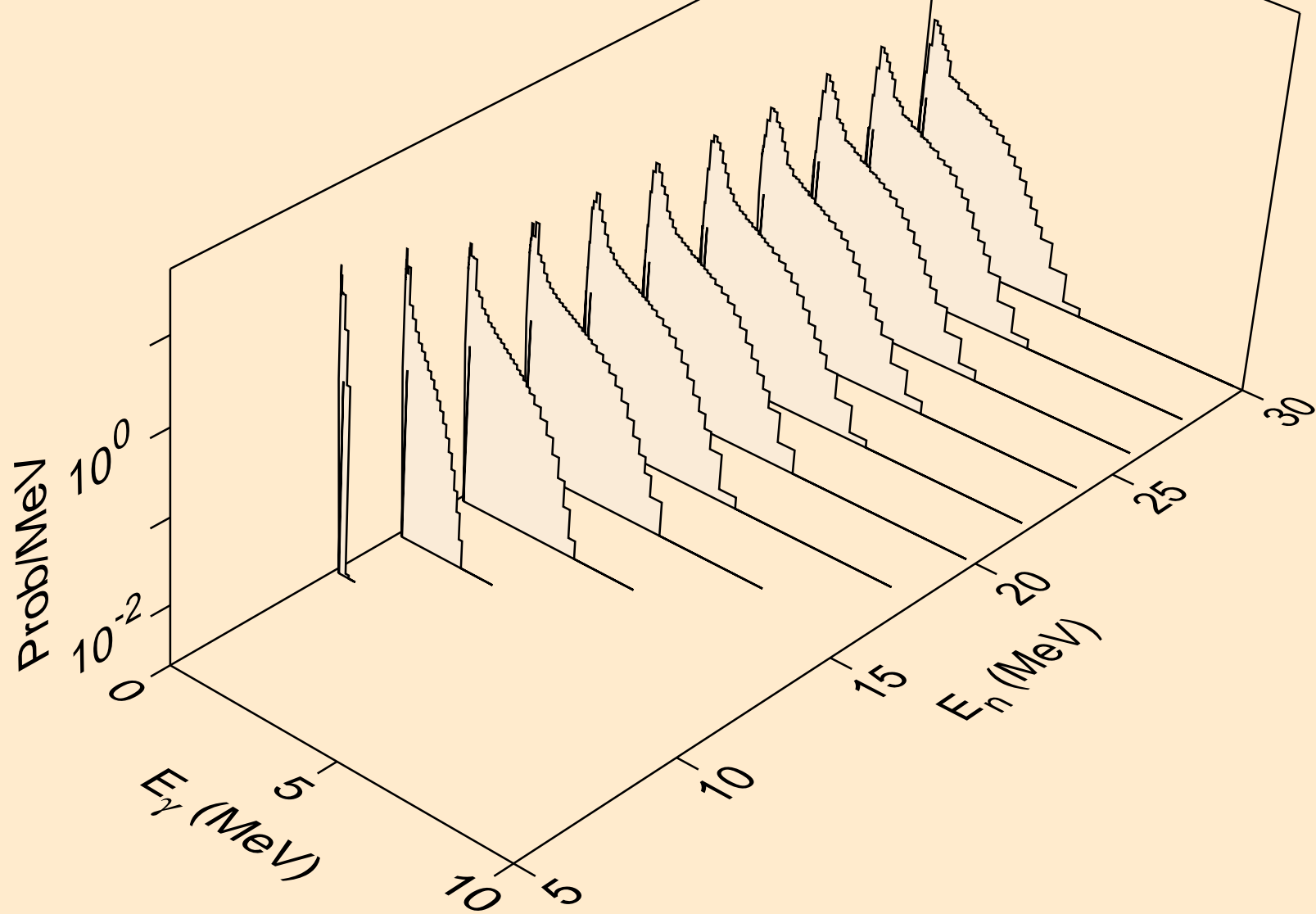

PB185M TRITON ACER TENDL-2021 LIBRARY; T=0.K  
Photon emission for (n,3n)

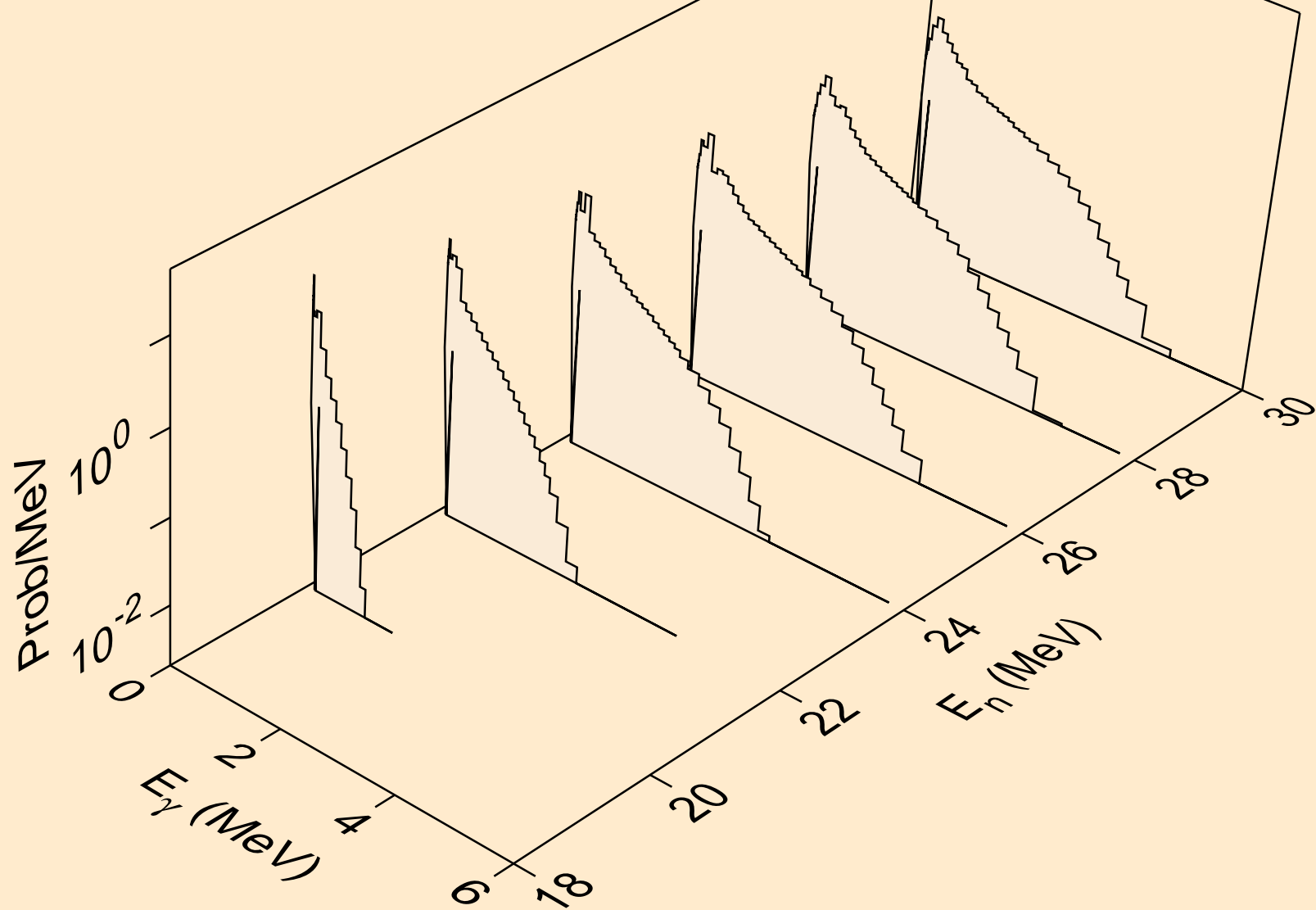

PB185M TRITON ACER TENDL-2021 LIBRARY; T=0.K  
Photon emission for (n,n\*)a

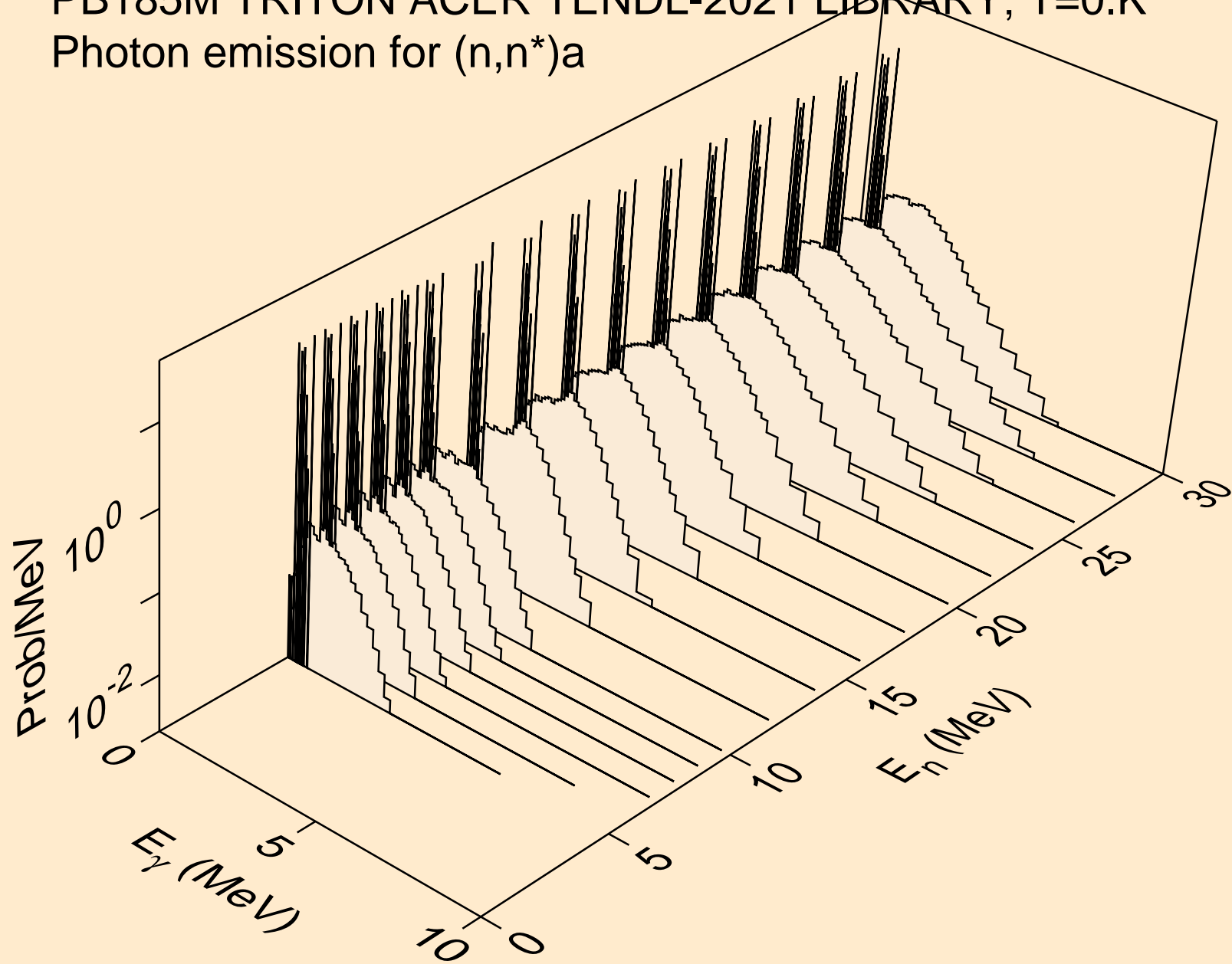

PB185M TRITON ACER TENDL-2021 LIBRARY; T=0.K  
Photon emission for (n,n\*)3a

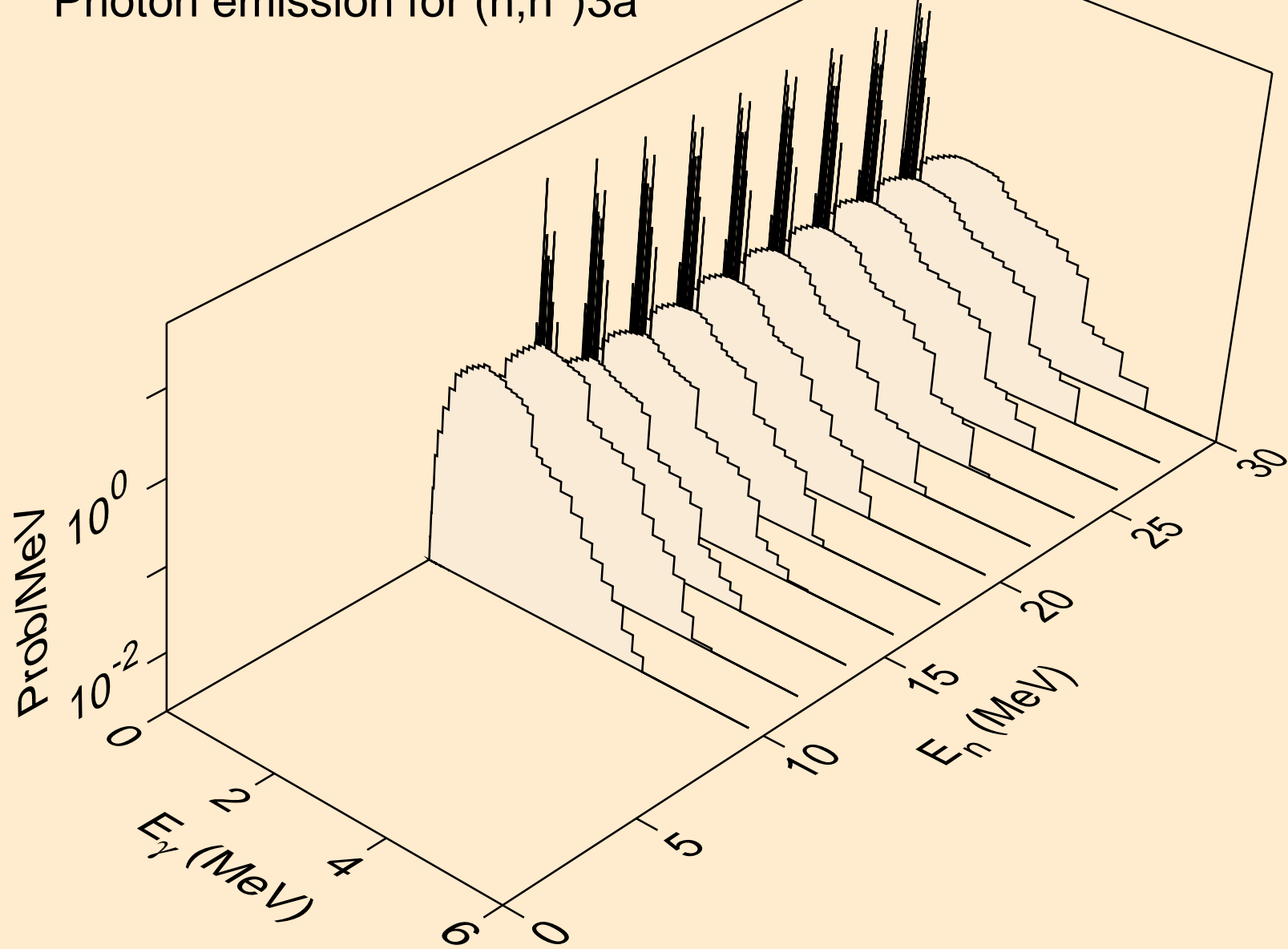

PB185M TRITON ACER TENDL-2021 LIBRARY; T=0.K  
Photon emission for (n,2n)a

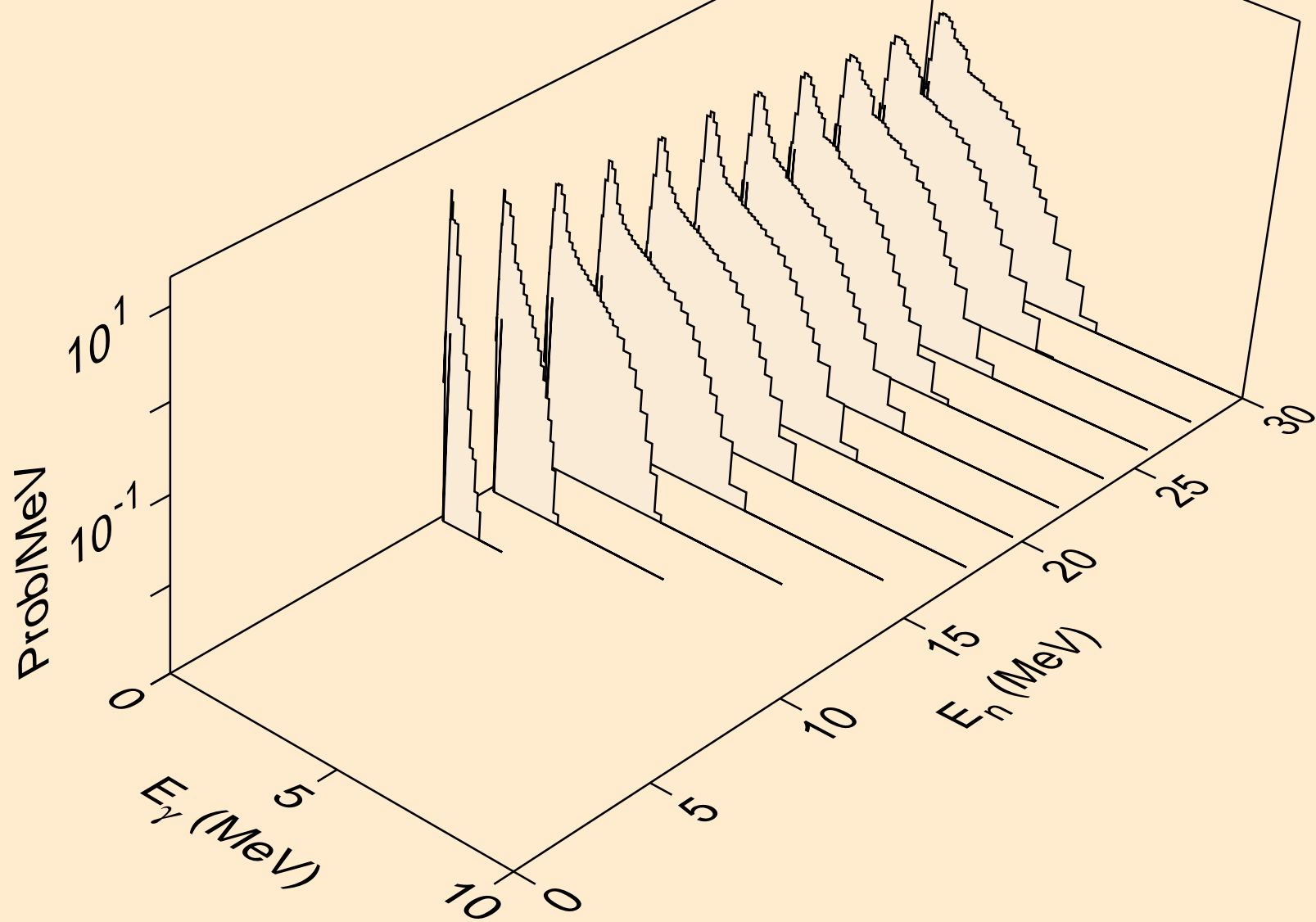

PB185M TRITON ACER TENDL-2021 LIBRARY; T=0.K  
Photon emission for (n,3n)a

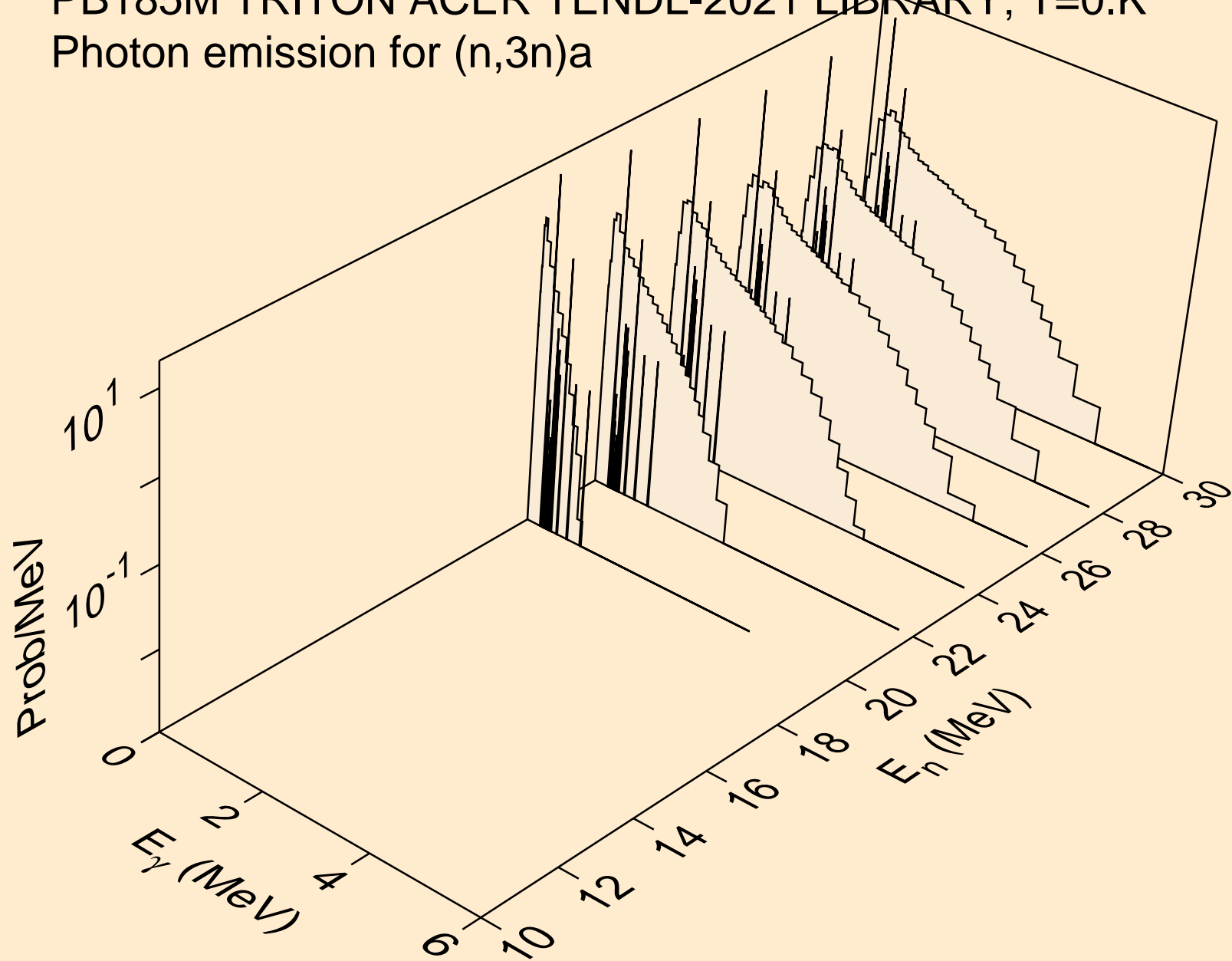

PB185M TRITON ACER TENDL-2021 LIBRARY; T=0.K  
Photon emission for (n,n\*)p

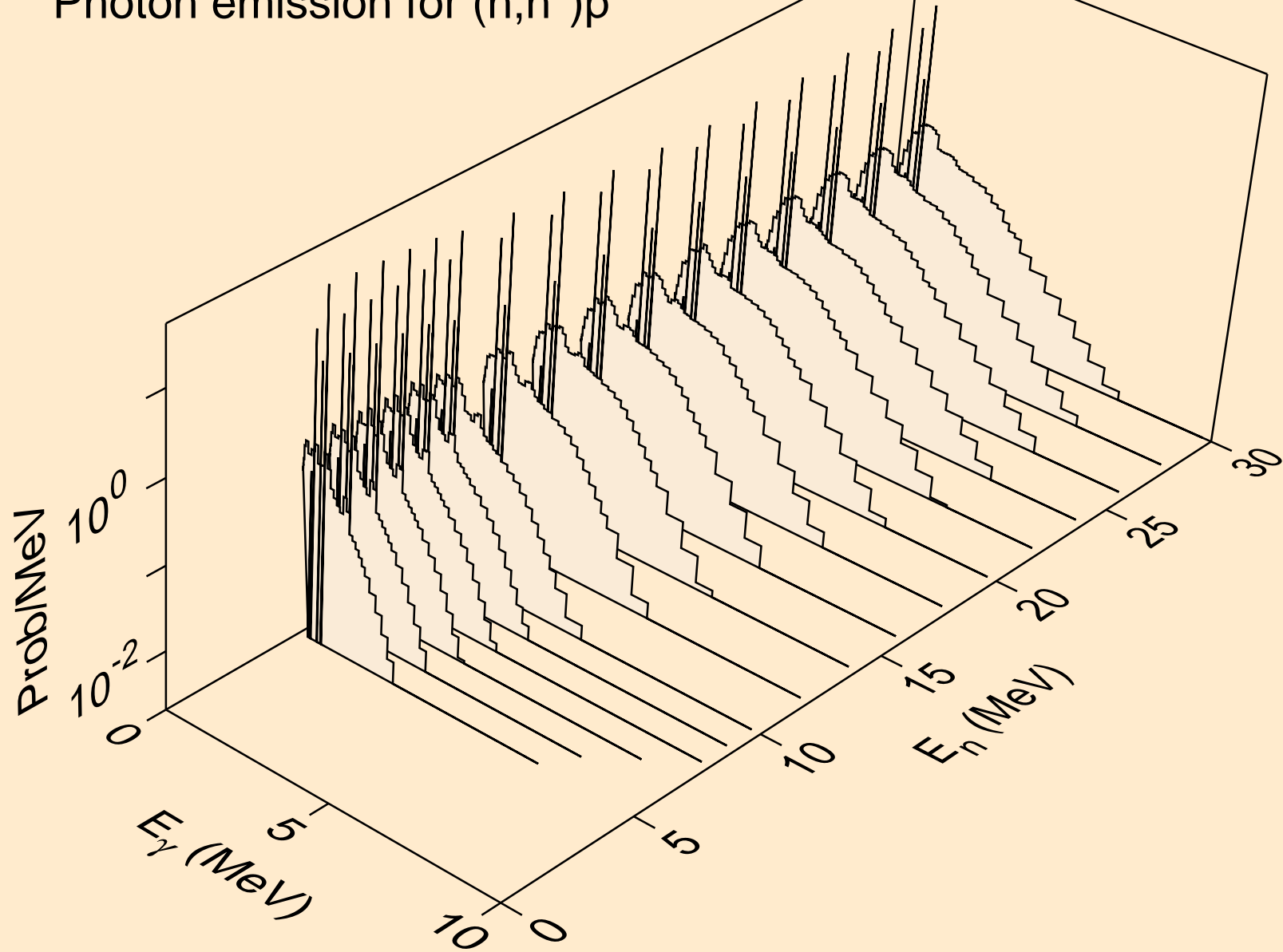

PB185M TRITON ACER TENDL-2021 LIBRARY; T=0.K  
Photon emission for (n,n\*)2a

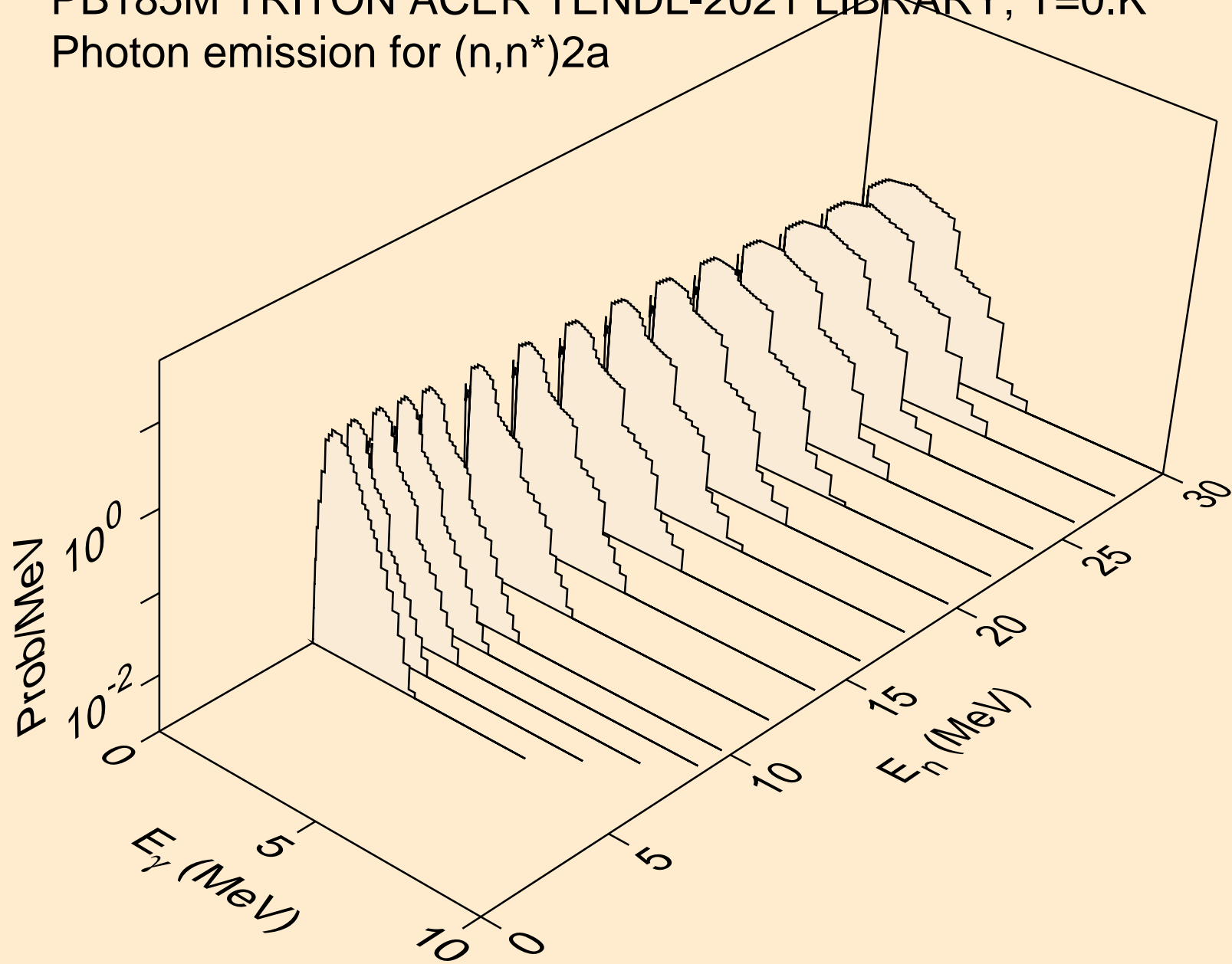



PB185M TRITON ACER TENDL-2021 LIBRARY; T=0.K  
Photon emission for (n,2n)2a

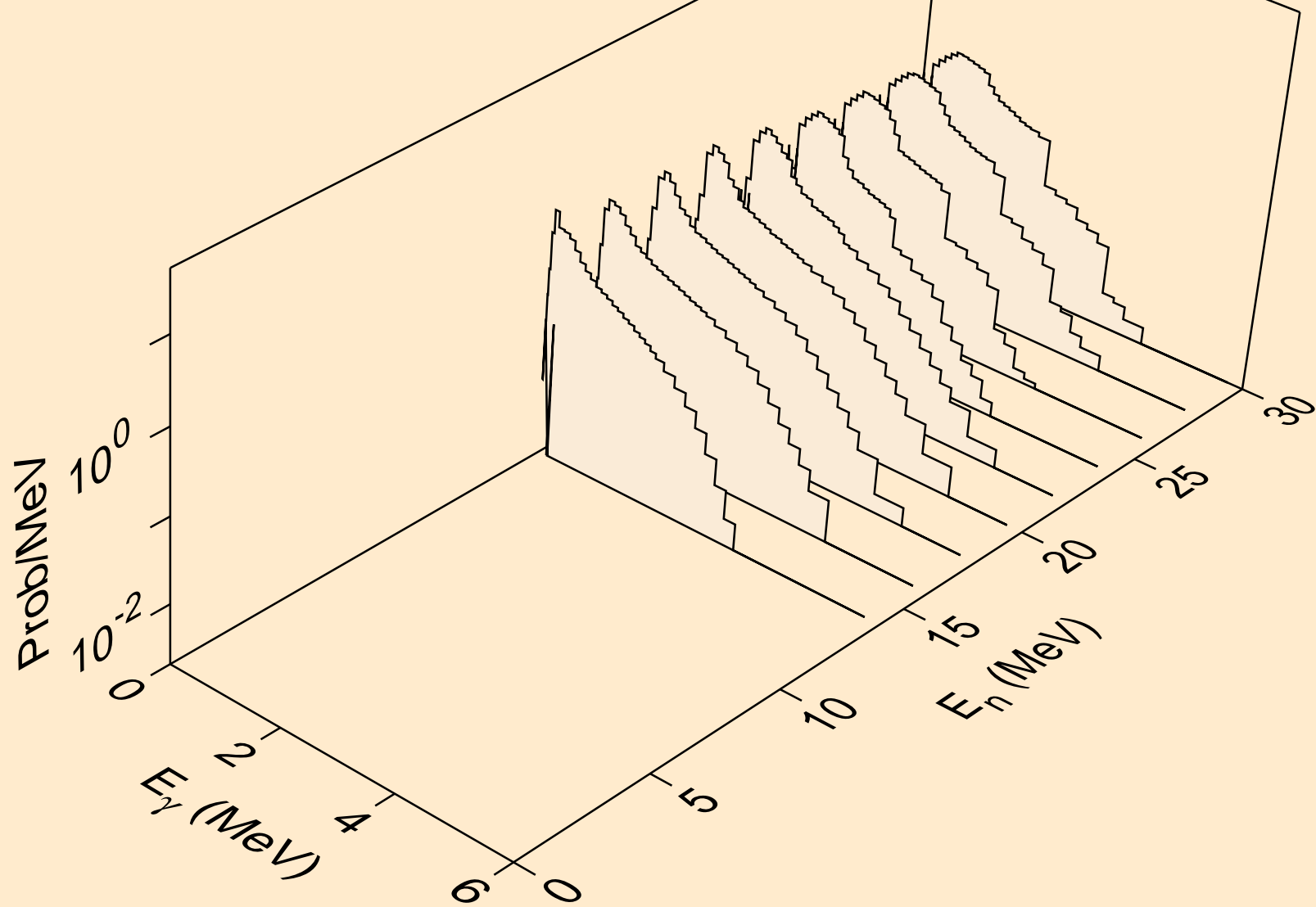

PB185M TRITON ACER TENDL-2021 LIBRARY; T=0.K  
Photon emission for (n,n\*)d

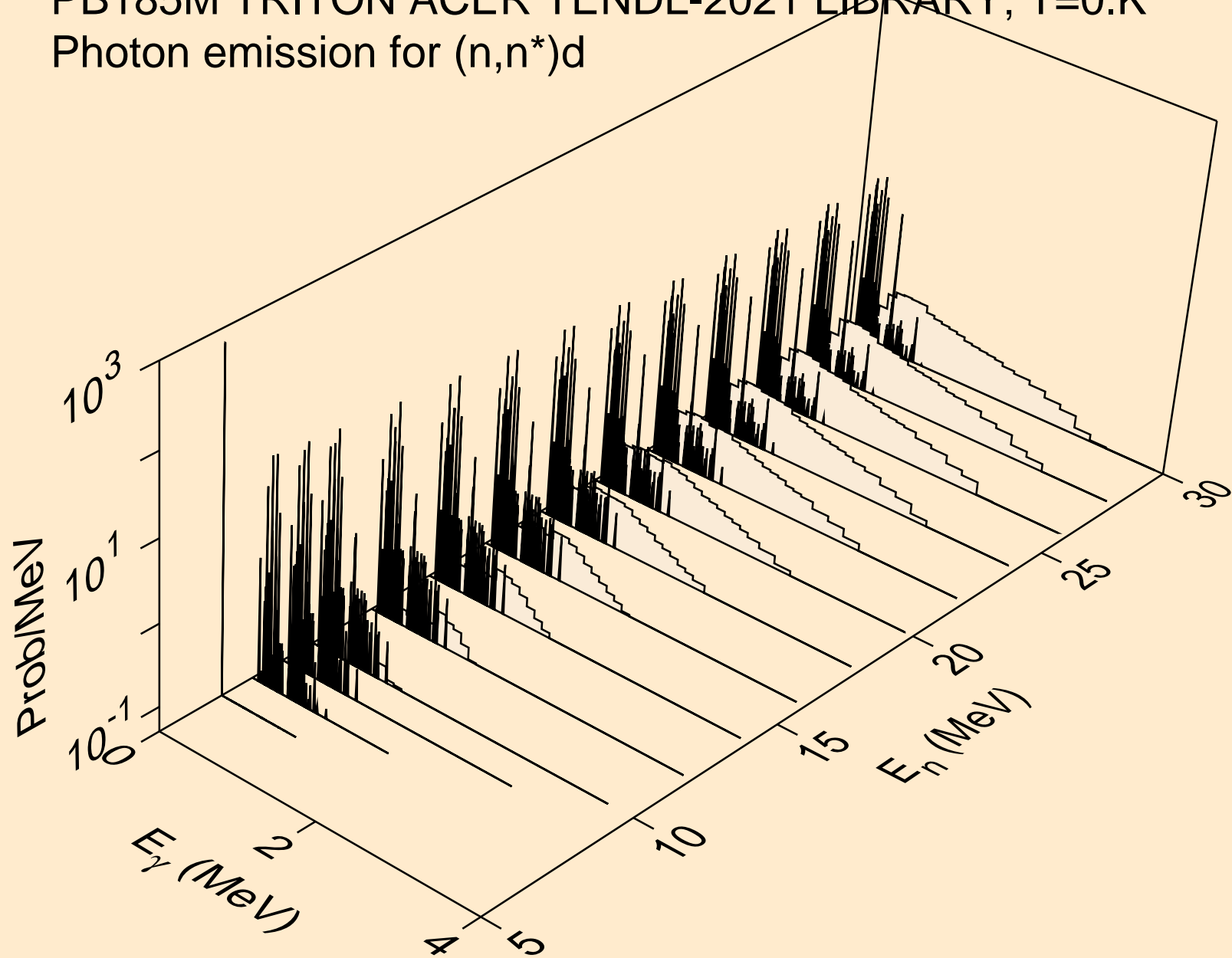

PB185M TRITON ACER TENDL-2021 LIBRARY; T=0.K  
Photon emission for (n,n\*)t

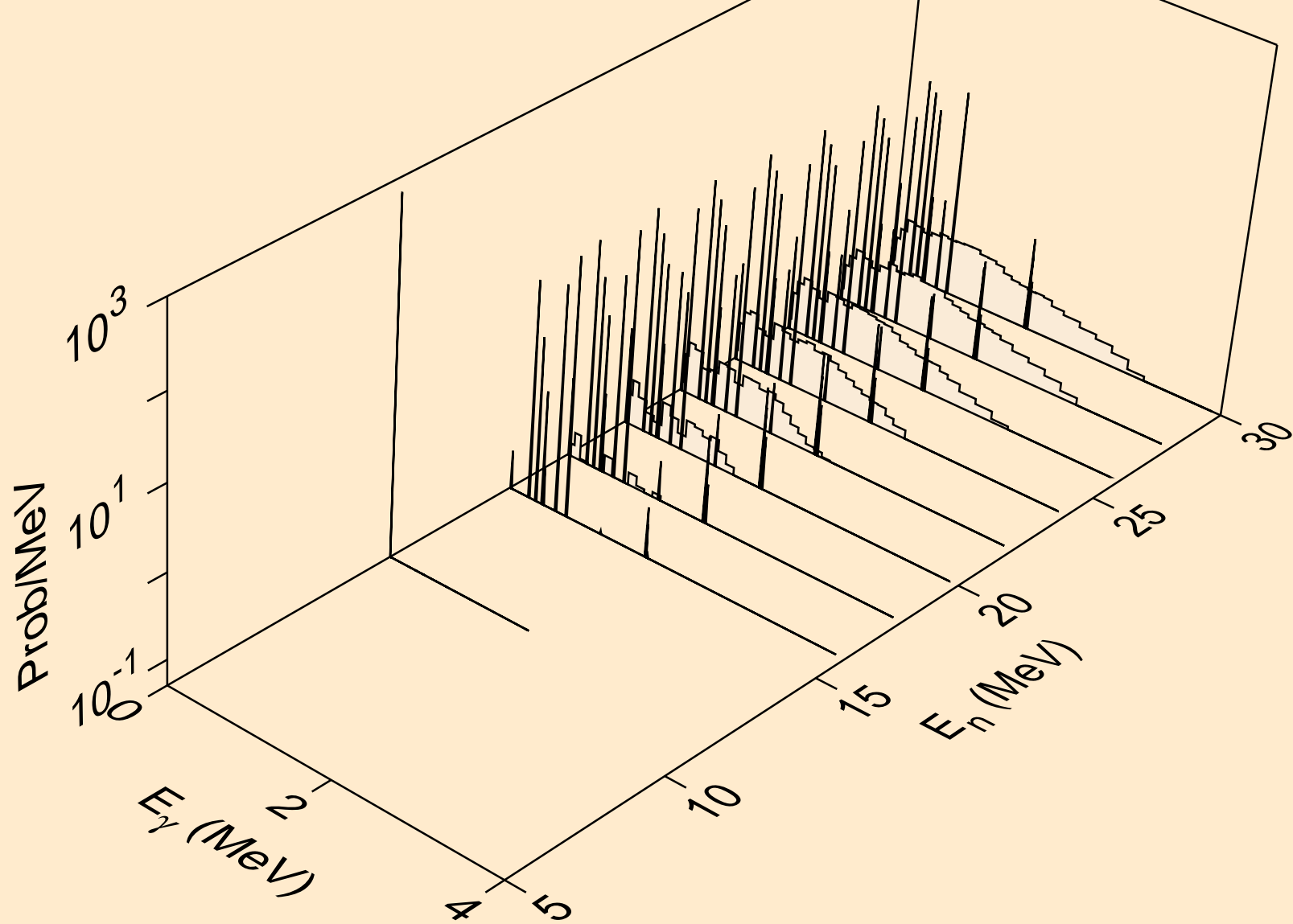

PB185M TRITON ACER TENDL-2021 LIBRARY; T=0.K  
Photon emission for (n,n\*)he3

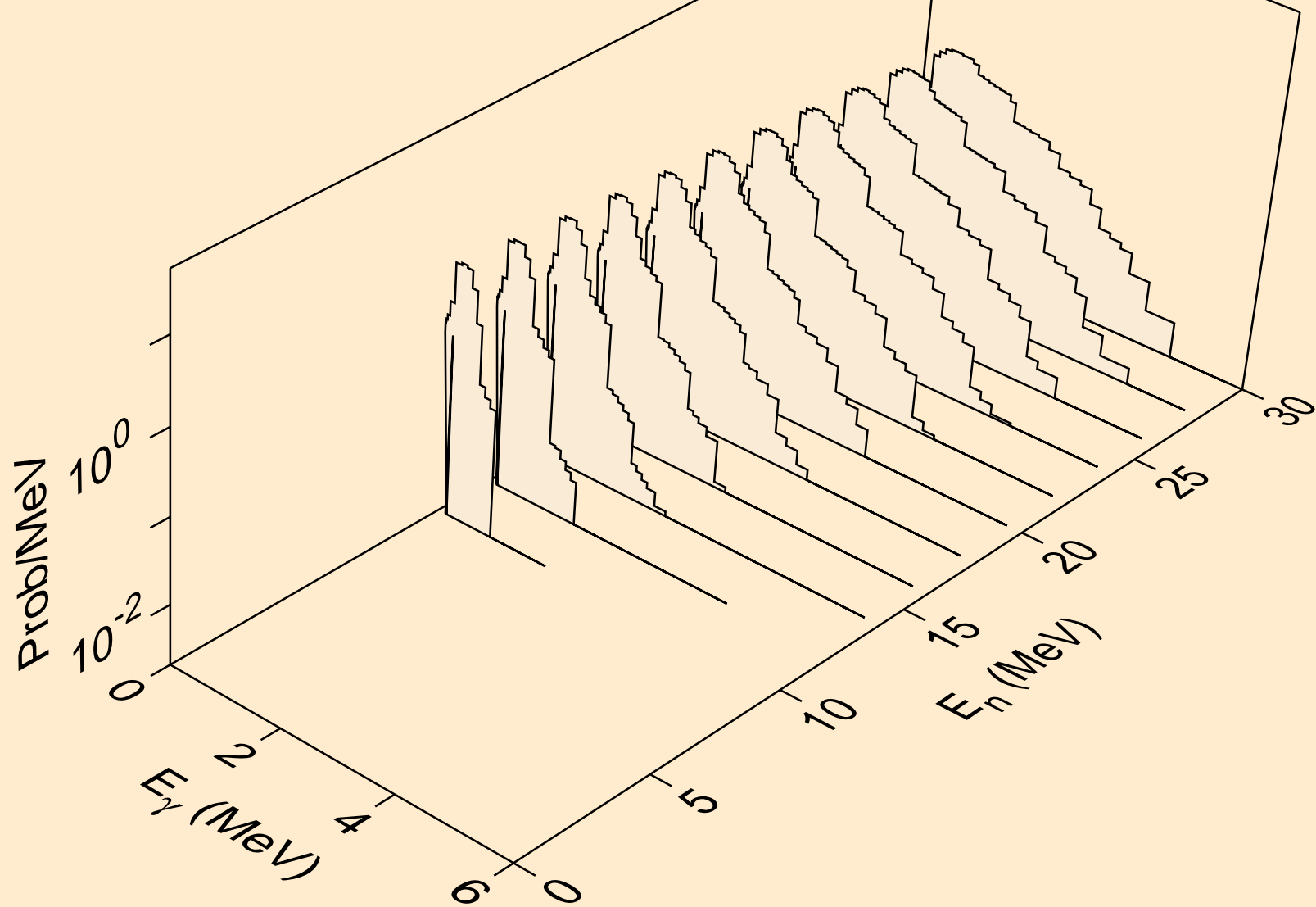

PB185M TRITON ACER TENDL-2021 LIBRARY; T=0.K  
Photon emission for (n,2np)

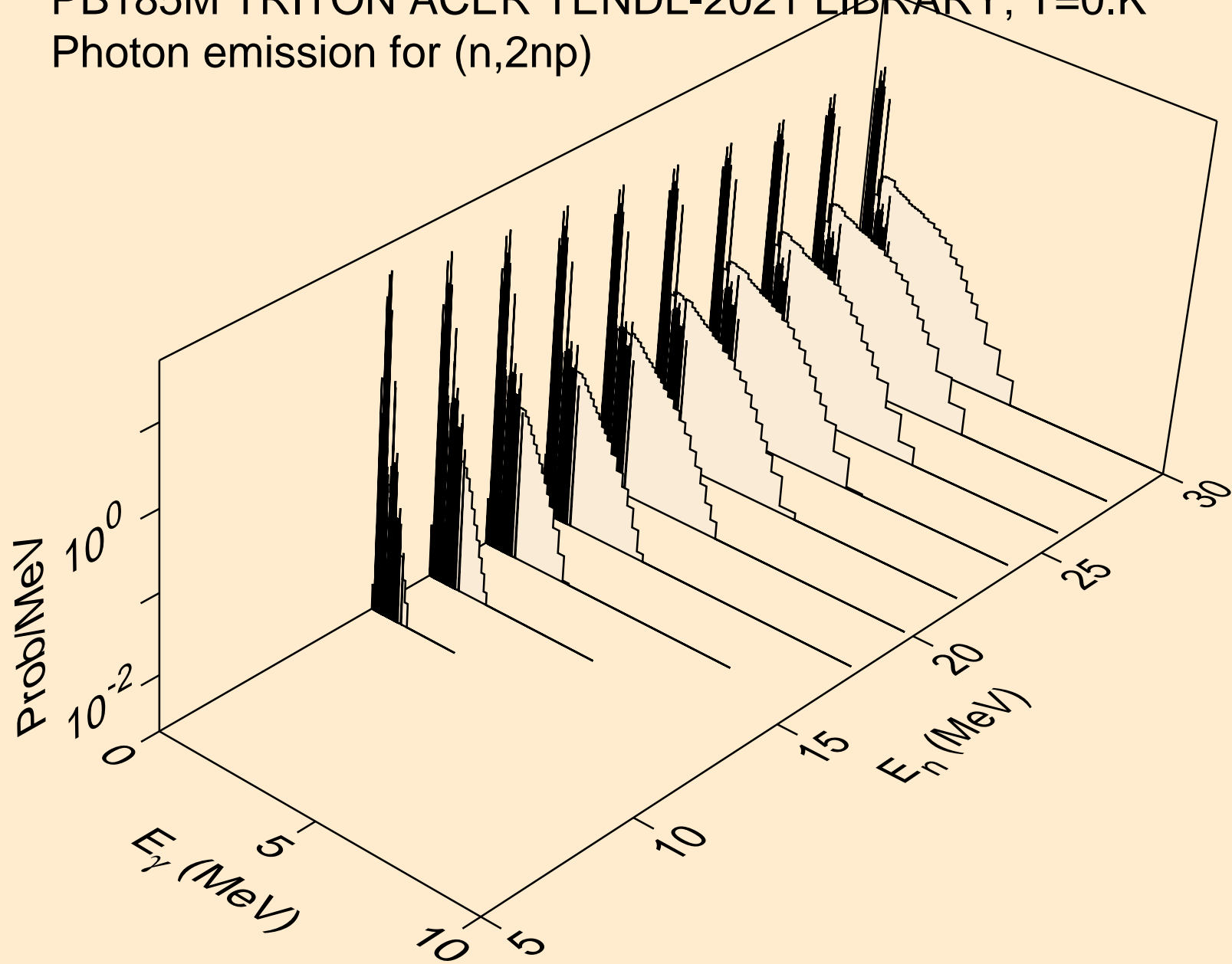

PB185M TRITON ACER TENDL-2021 LIBRARY; T=0.K  
Photon emission for (n,3np)

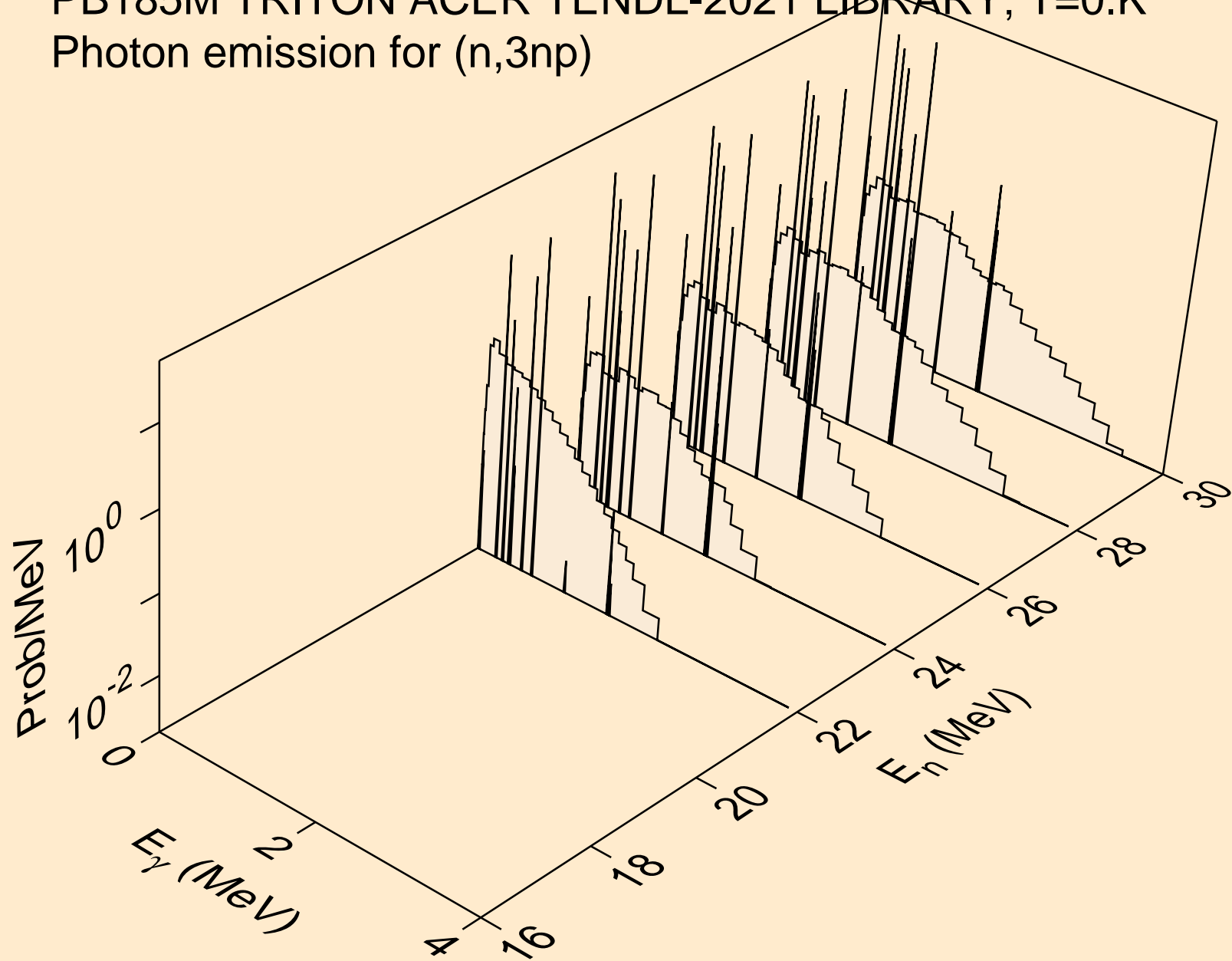

PB185M TRITON ACER TENDL-2021 LIBRARY; T=0.K  
Photon emission for (n,2np)

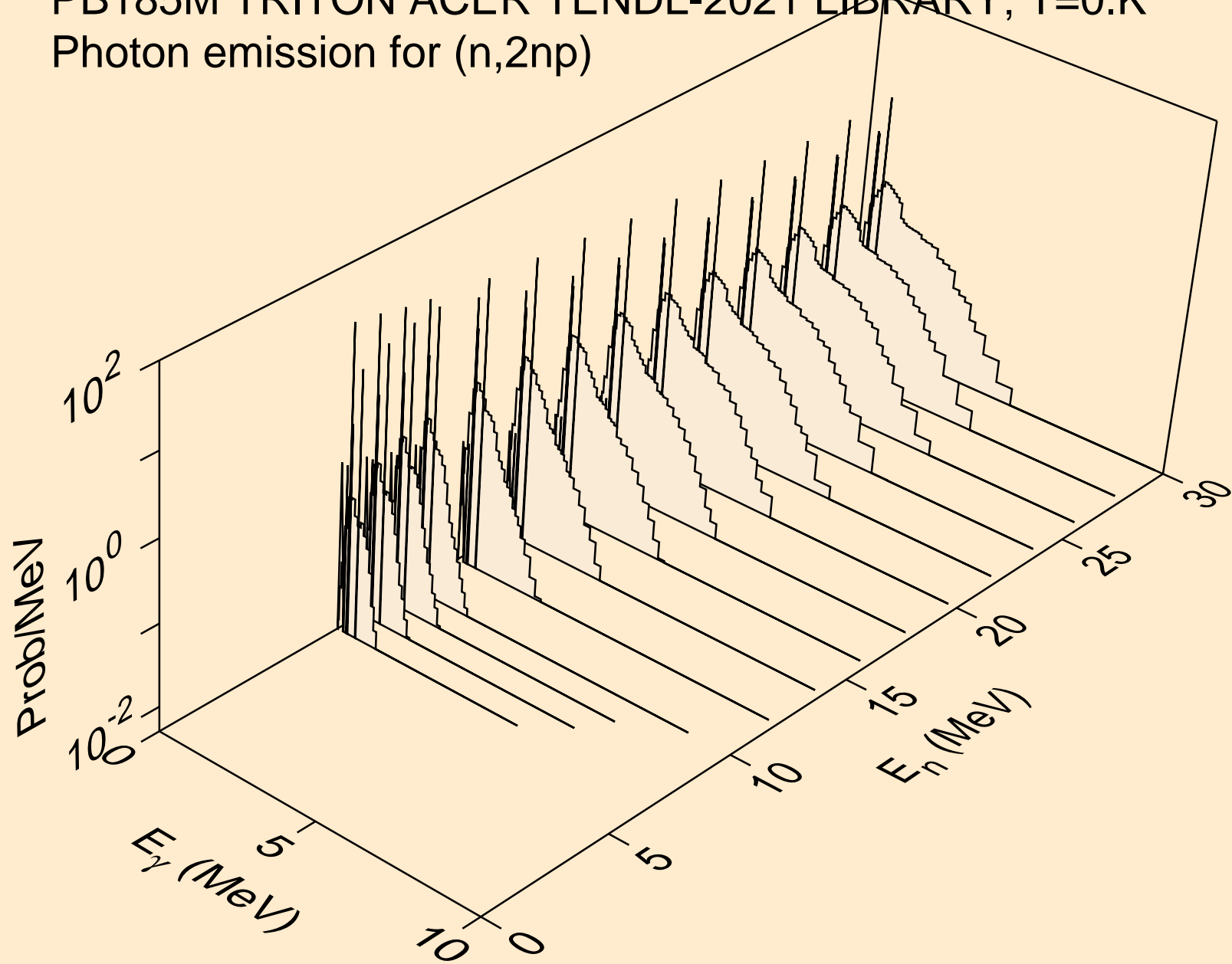

PB185M TRITON ACER TENDL-2021 LIBRARY; T=0.K  
Photon emission for (n,npa)

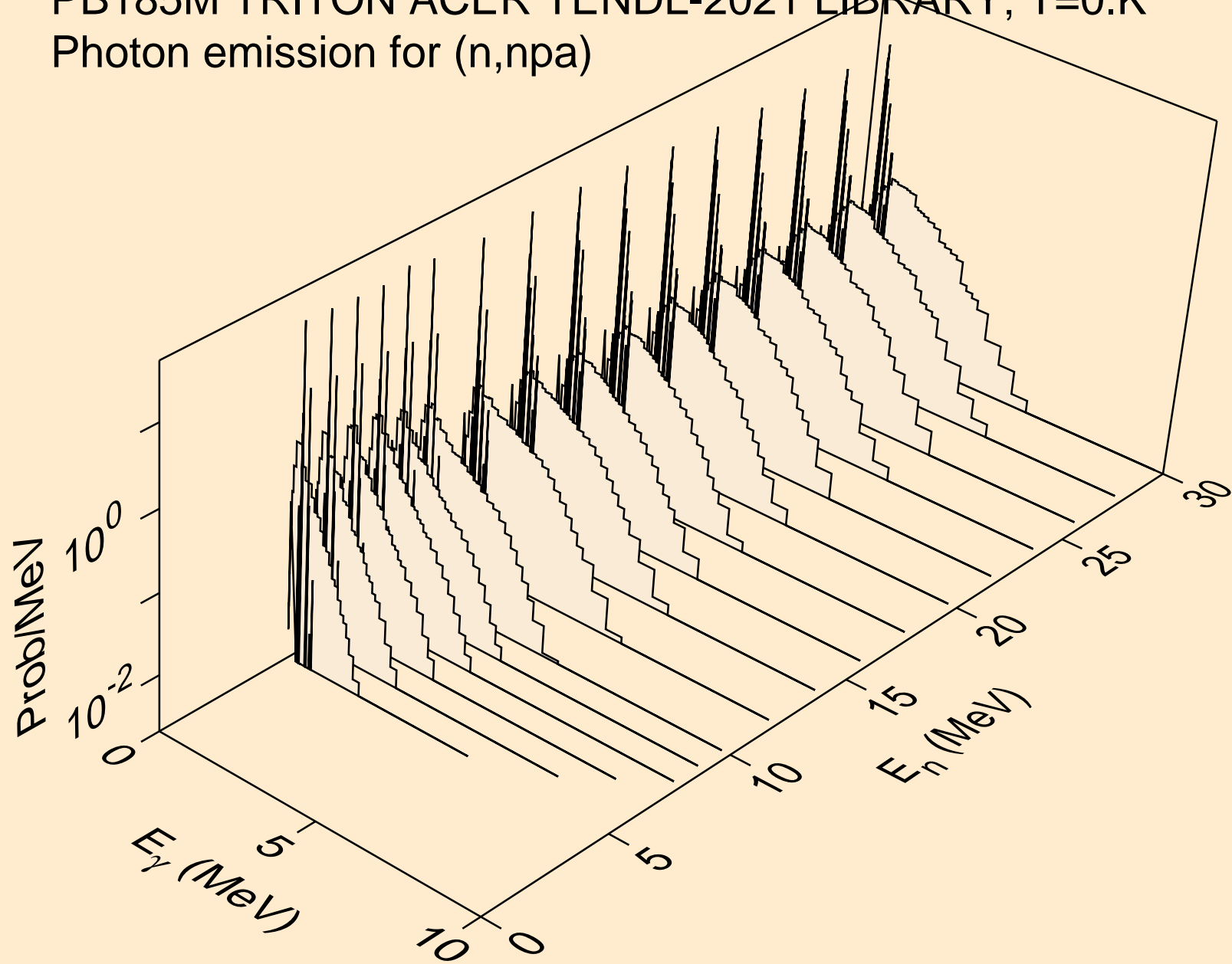



PB185M TRITON ACER TENDL-2021 LIBRARY; T=0.K  
Photon emission for (n,gma)

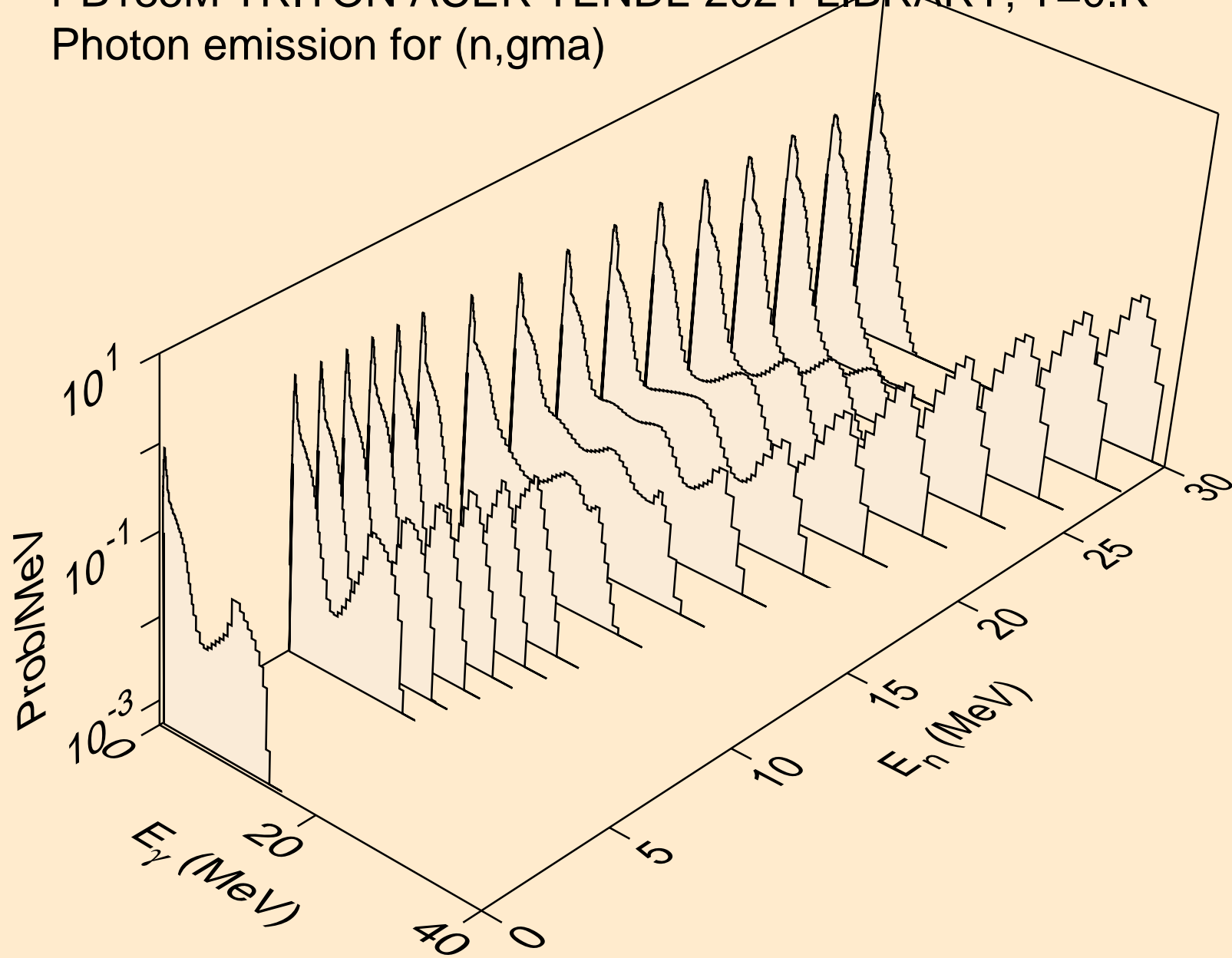

PB185M TRITON ACER TENDL-2021 LIBRARY; T=0.K  
Photon emission for (n,p)

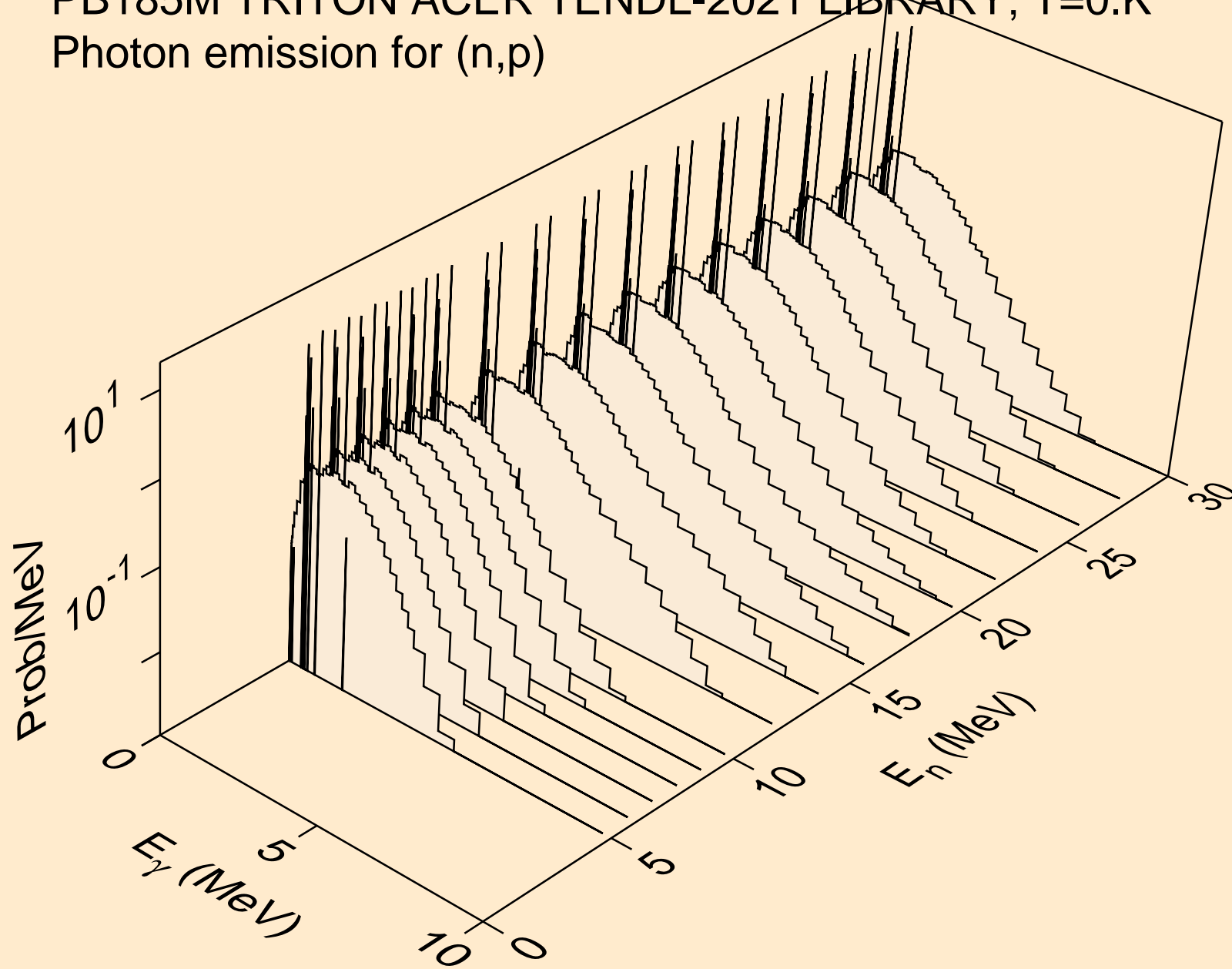

PB185M TRITON ACER TENDL-2021 LIBRARY; T=0.K  
Photon emission for (n,d)

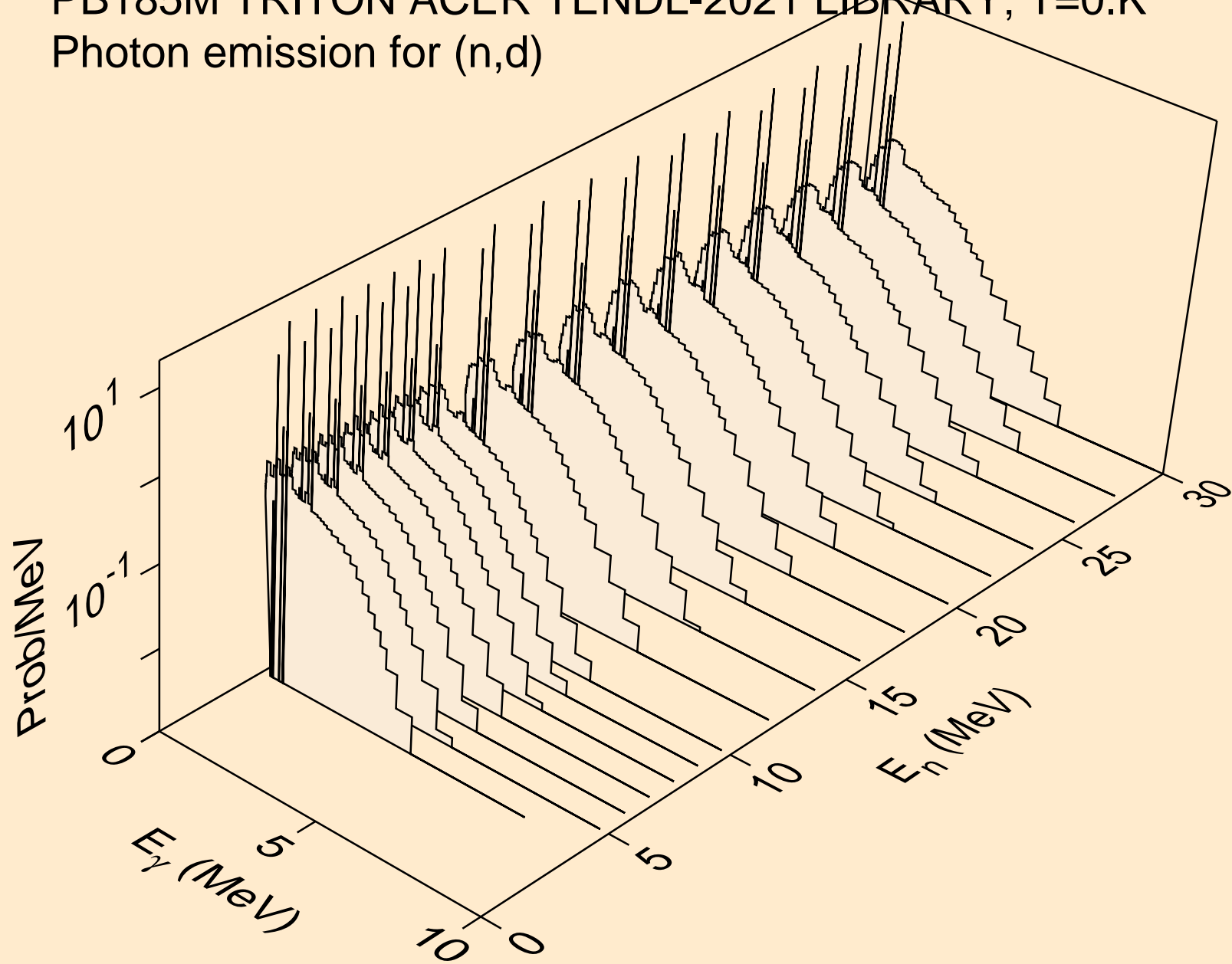

PB185M TRITON ACER TENDL-2021 LIBRARY; T=0.K  
Photon emission for inelastic

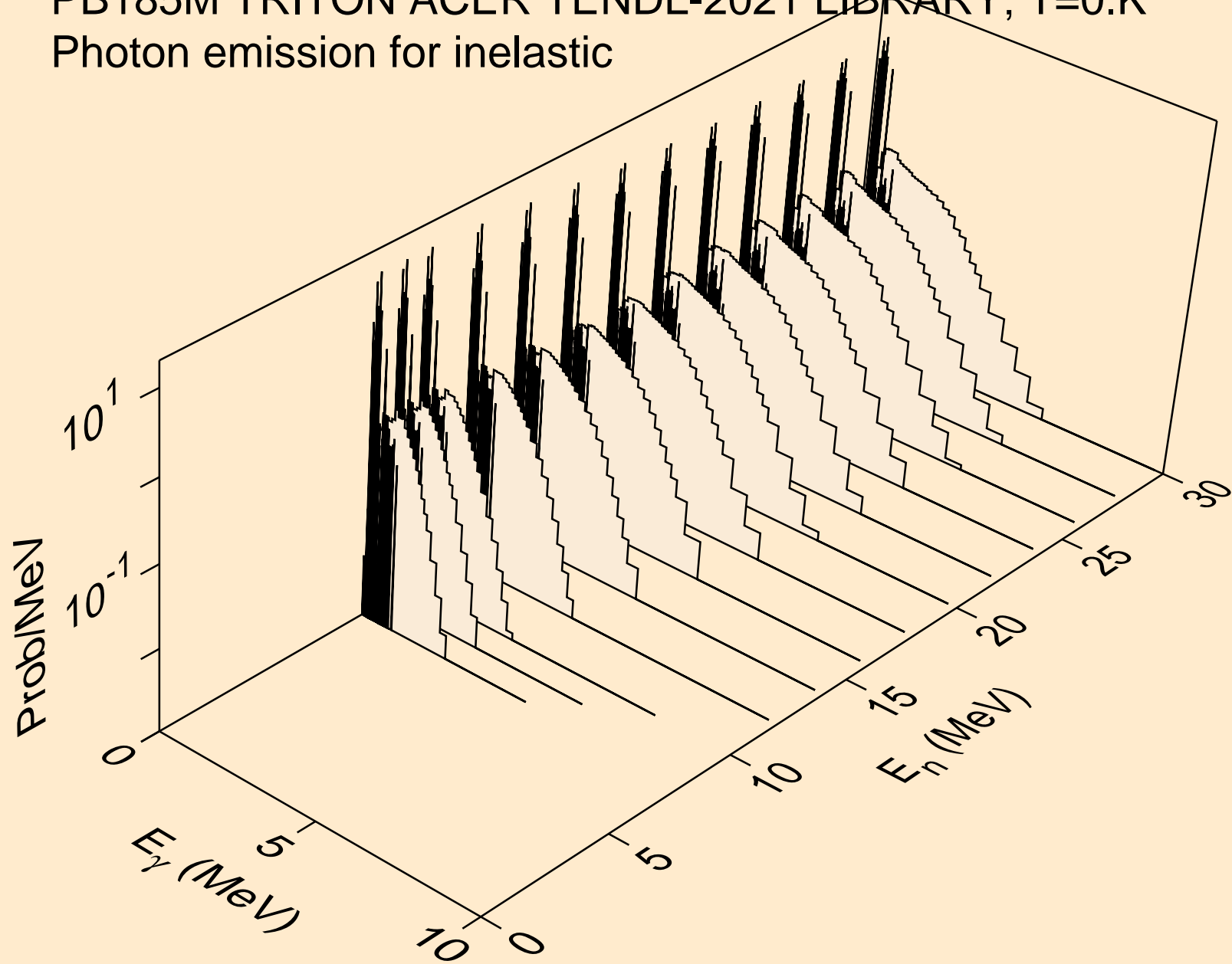

PB185M TRITON ACER TENDL-2021 LIBRARY; T=0.K  
Photon emission for (n,he3)

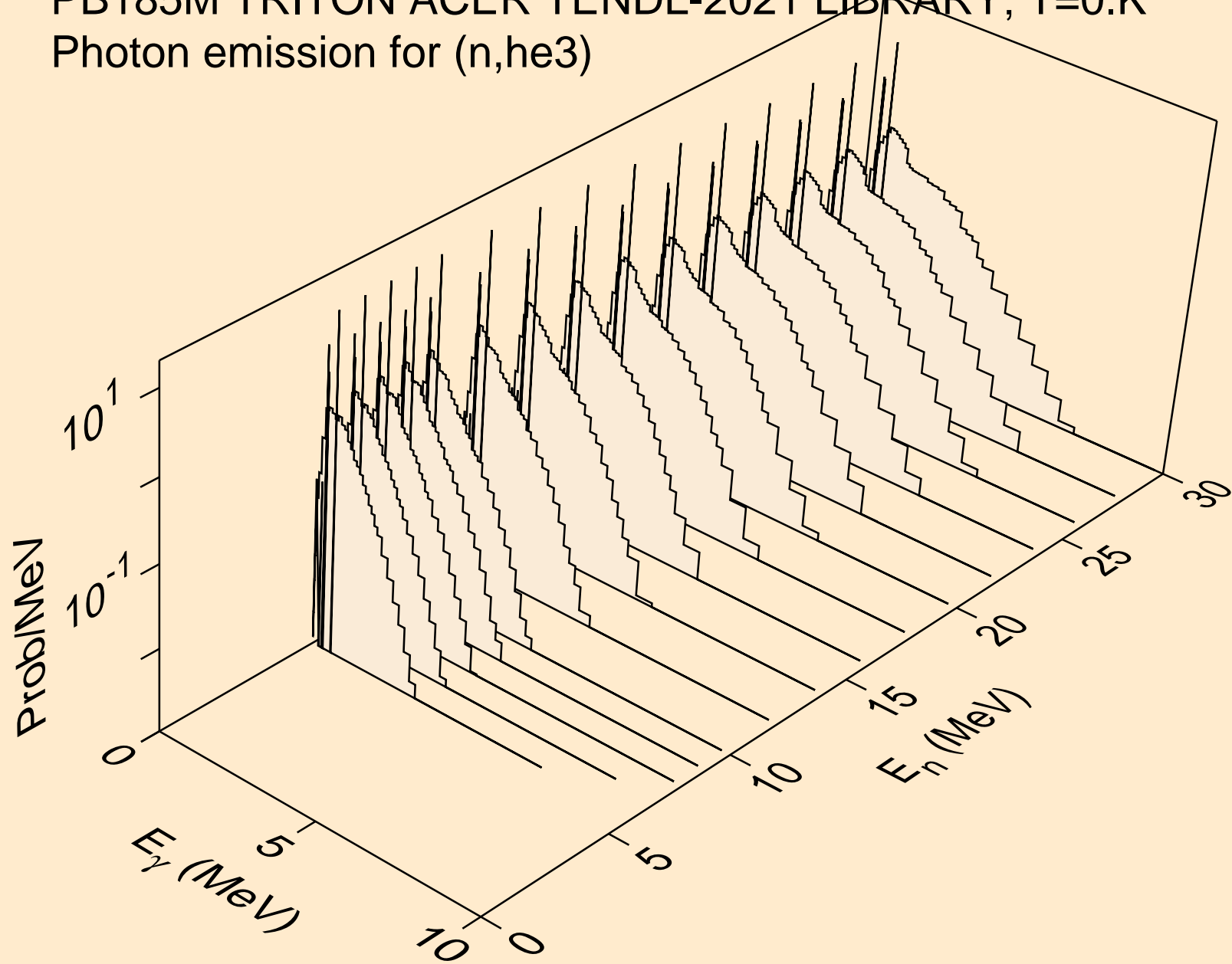

PB185M TRITON ACER TENDL-2021 LIBRARY; T=0.K  
Photon emission for (n,a)

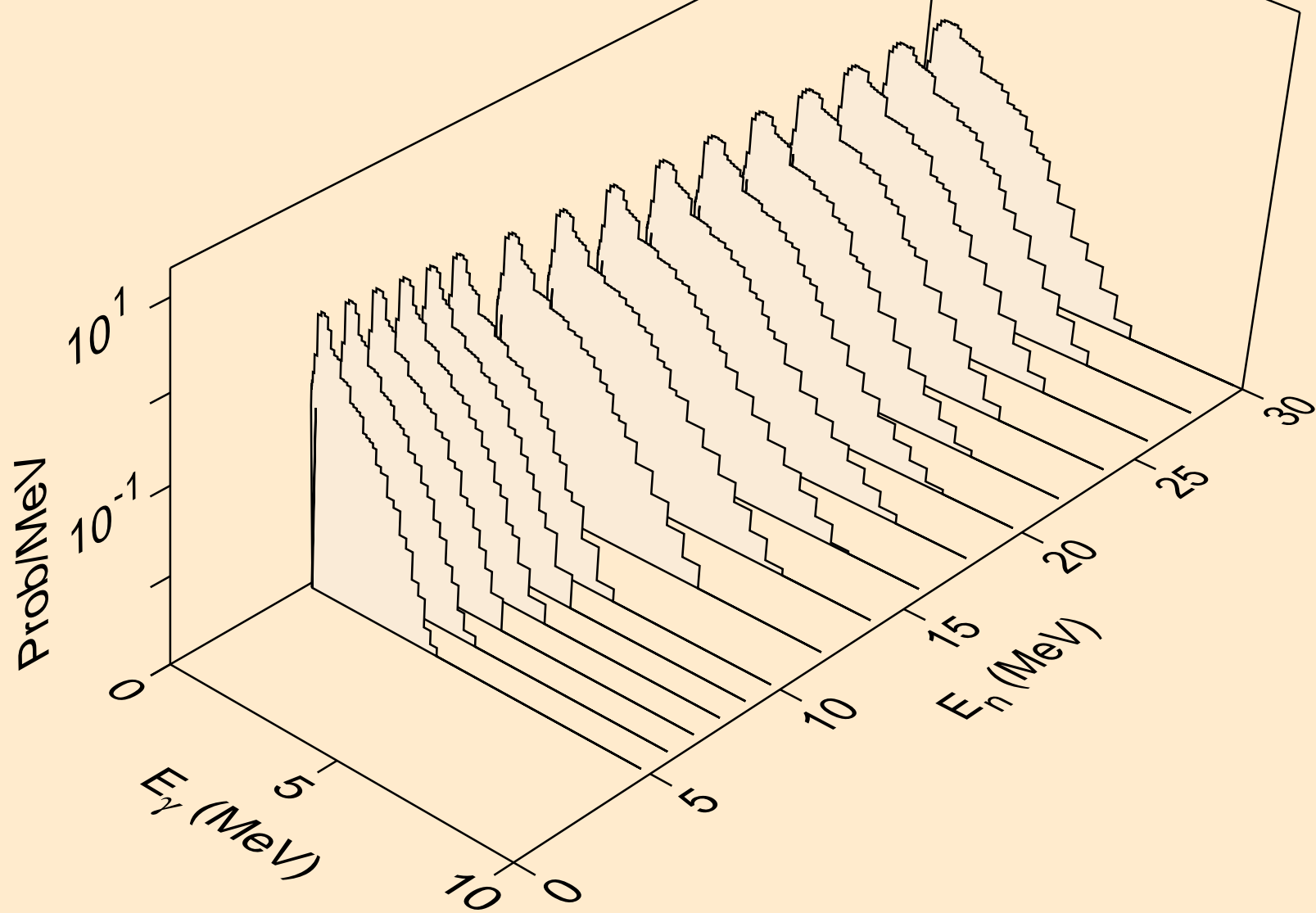

PB185M TRITON ACER TENDL-2021 LIBRARY; T=0.K  
Photon emission for (n,2a)

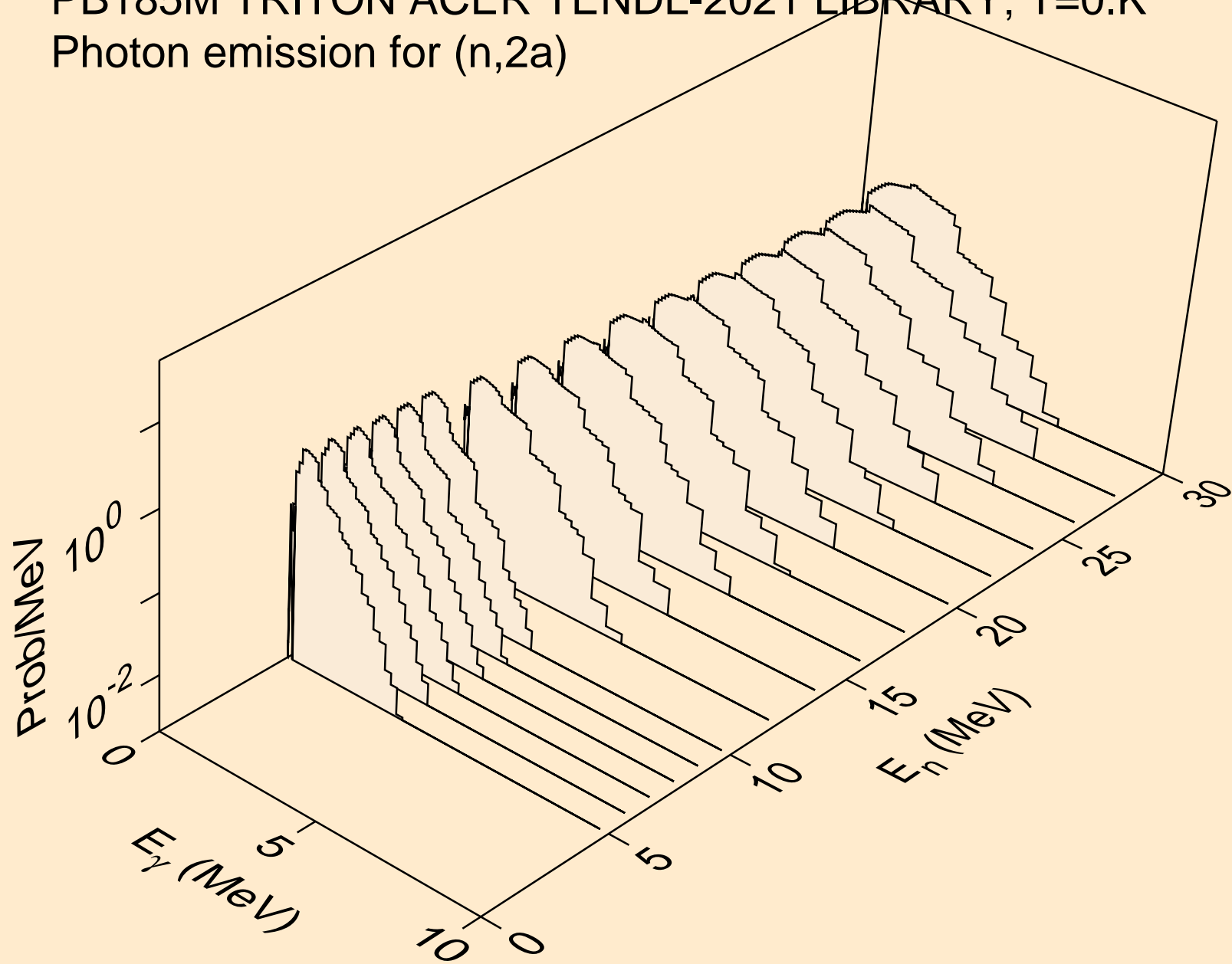

PB185M TRITON ACER TENDL-2021 LIBRARY; T=0.K  
Photon emission for (n,3a)

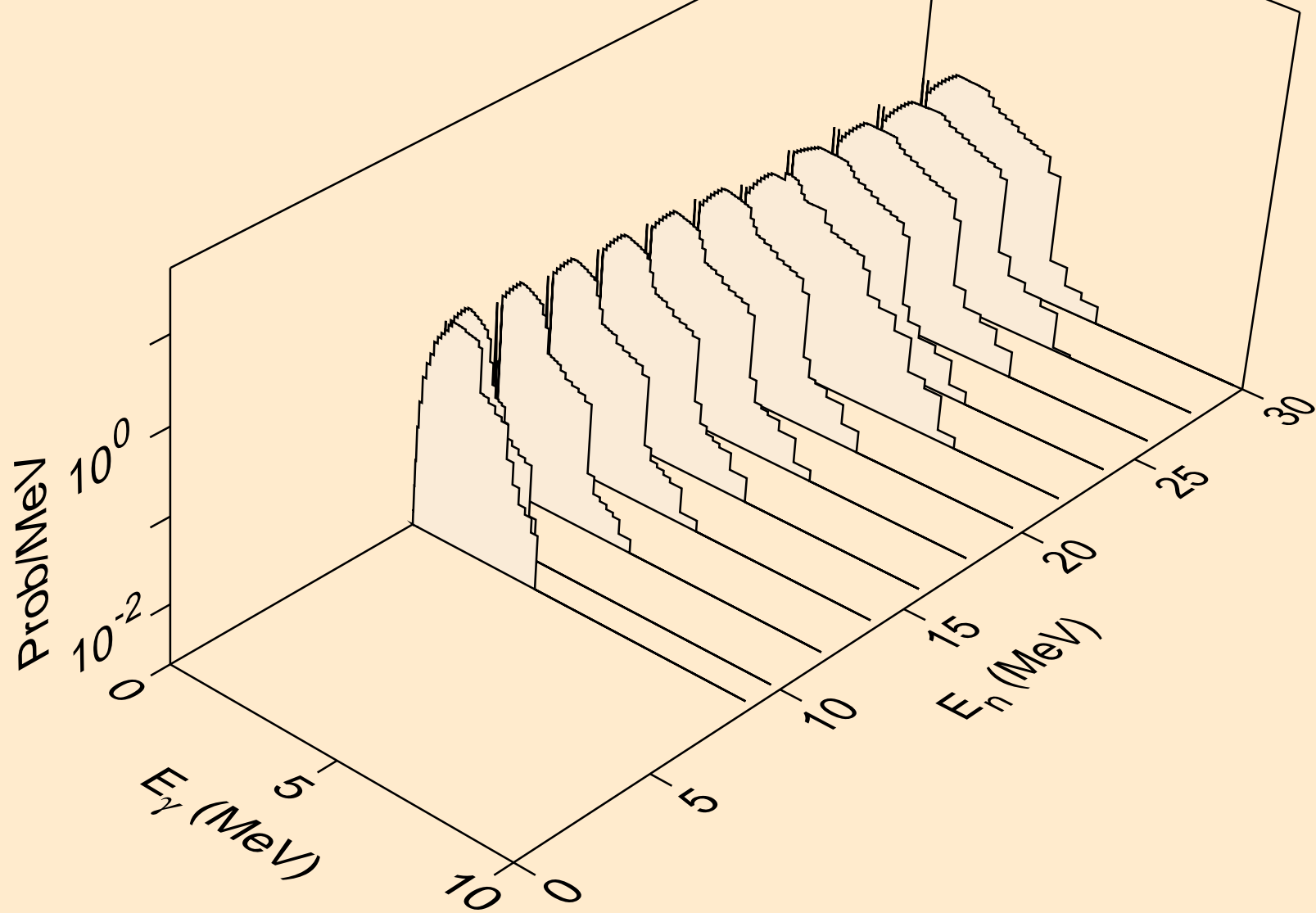



PB185M TRITON ACER TENDL-2021 LIBRARY; T=0.K  
Photon emission for (n,2p)

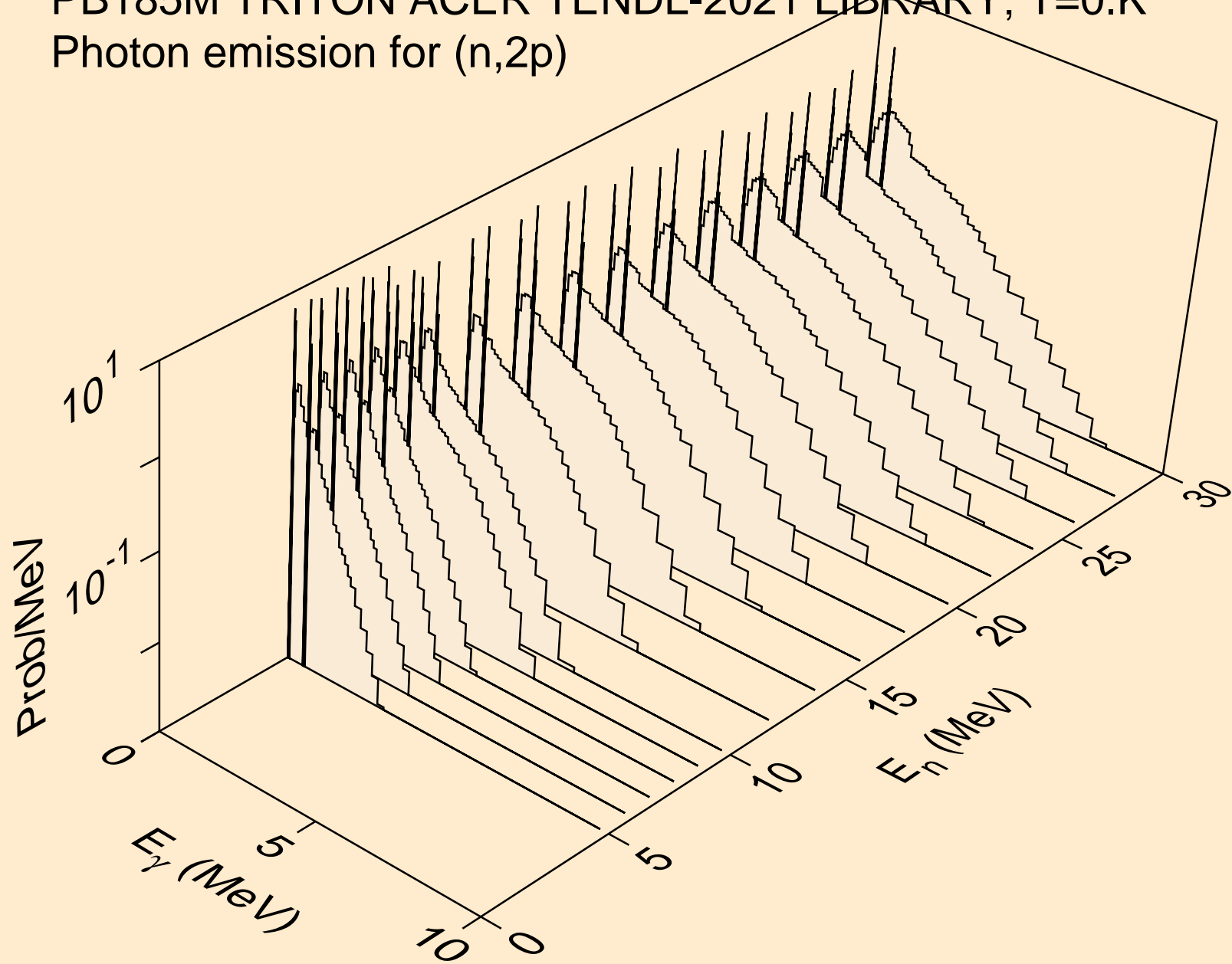

PB185M TRITON ACER TENDL-2021 LIBRARY; T=0.K  
Photon emission for (n,pa)

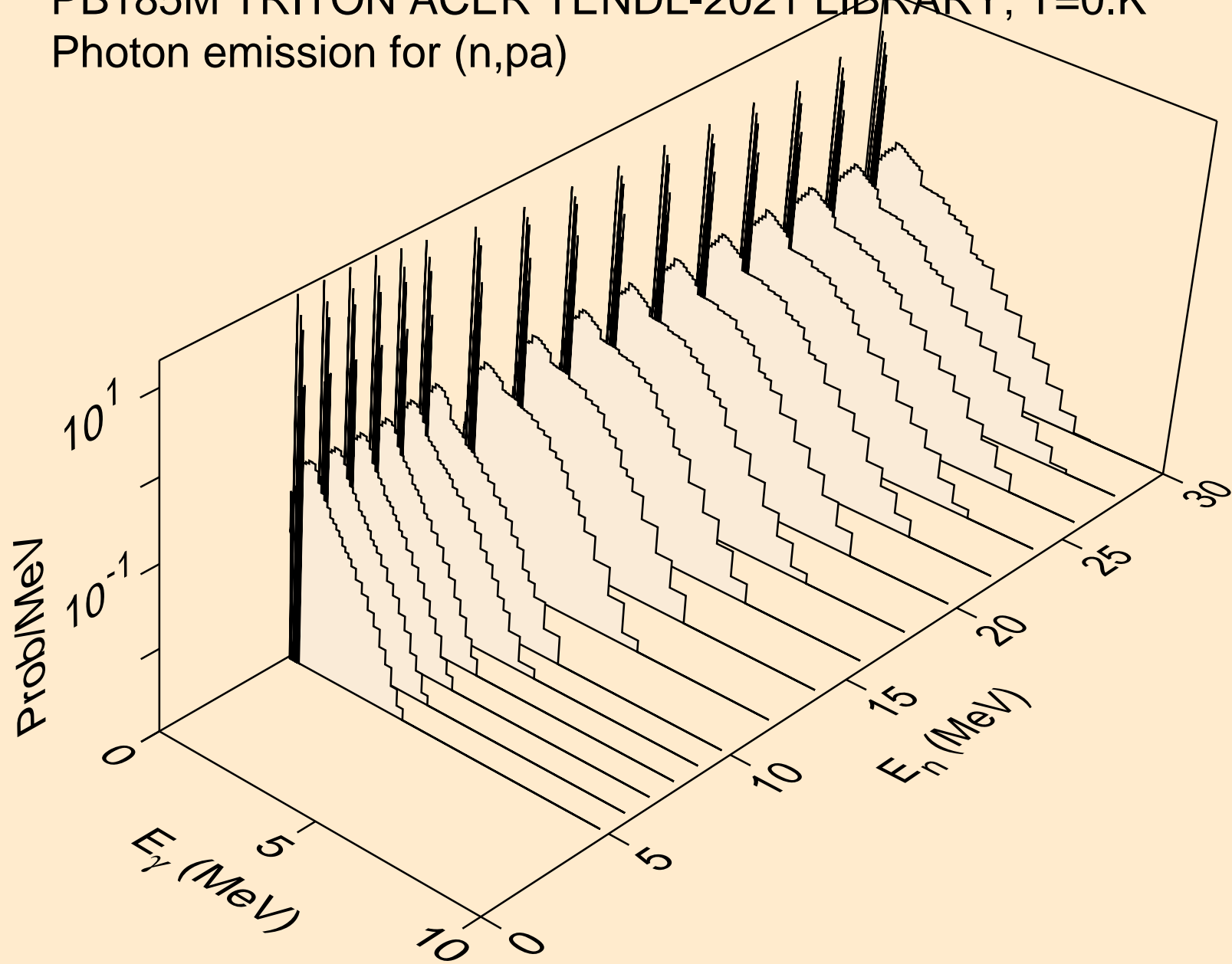

PB185M TRITON ACER TENDL-2021 LIBRARY; T=0.K  
Photon emission for (n,t2a)

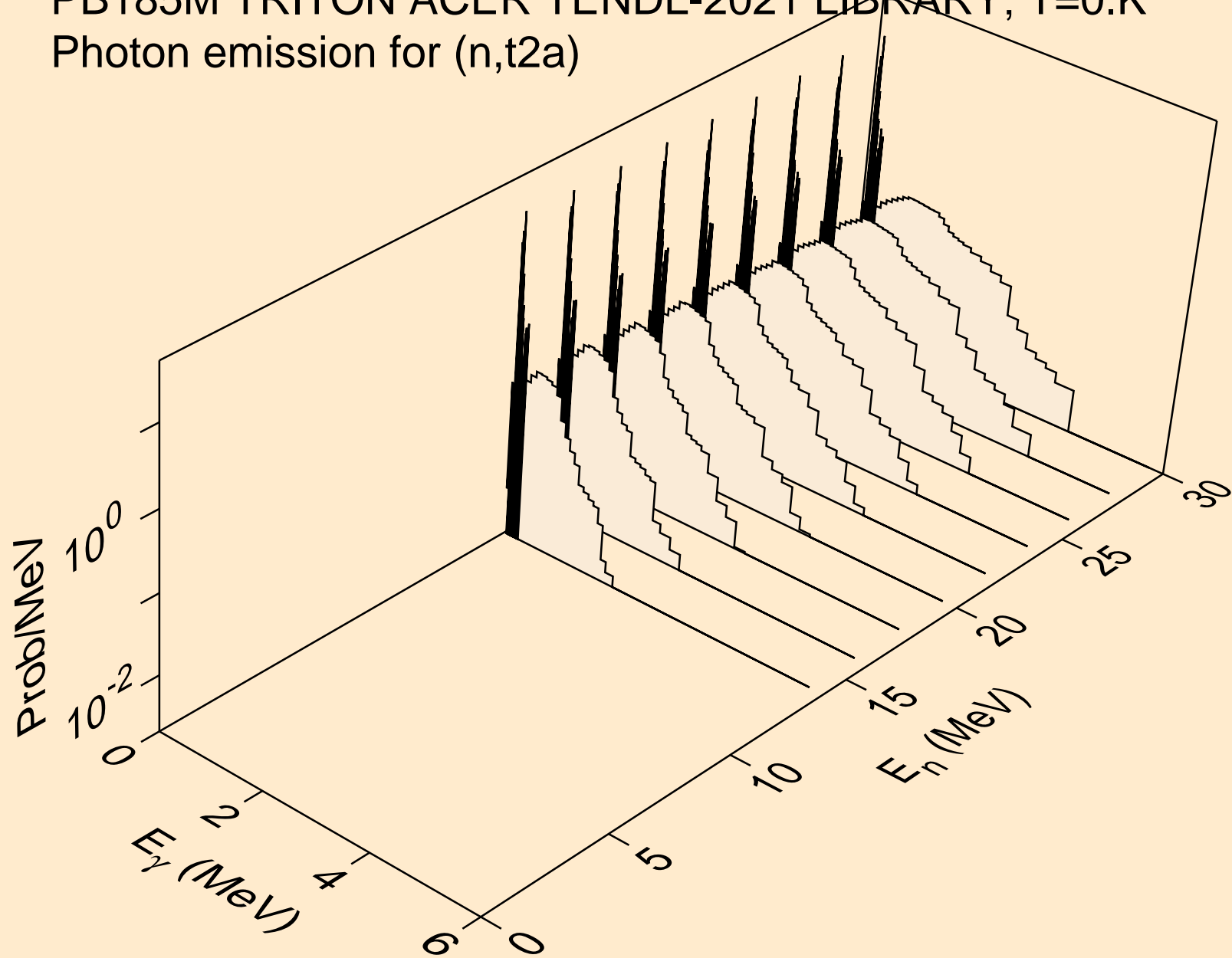

PB185M TRITON ACER TENDL-2021 LIBRARY; T=0.K  
Photon emission for (n,d2a)

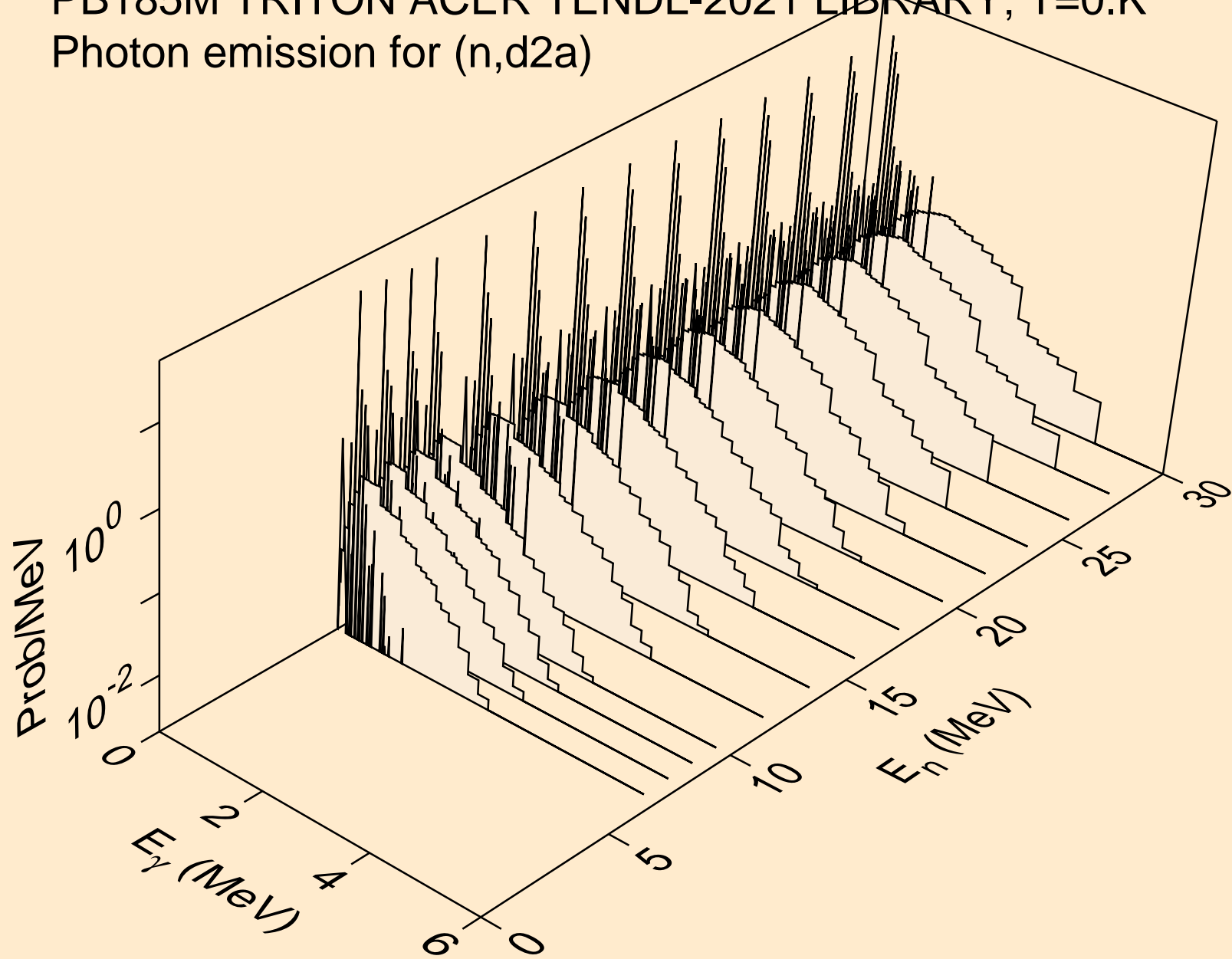

PB185M TRITON ACER TENDL-2021 LIBRARY; T=0.K  
Photon emission for (n,pd)

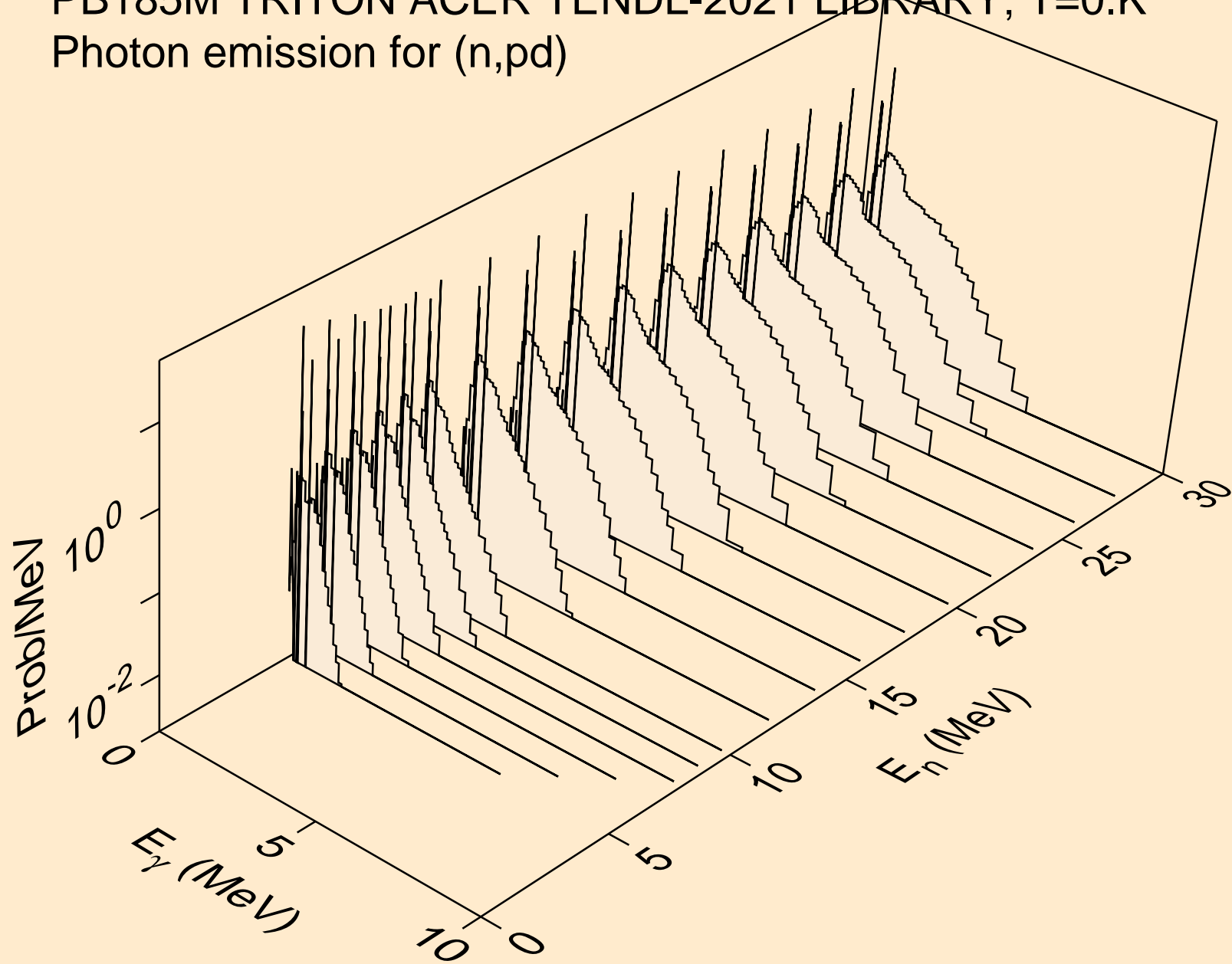

PB185M TRITON ACER TENDL-2021 LIBRARY; T=0.K  
Photon emission for (n,pt)

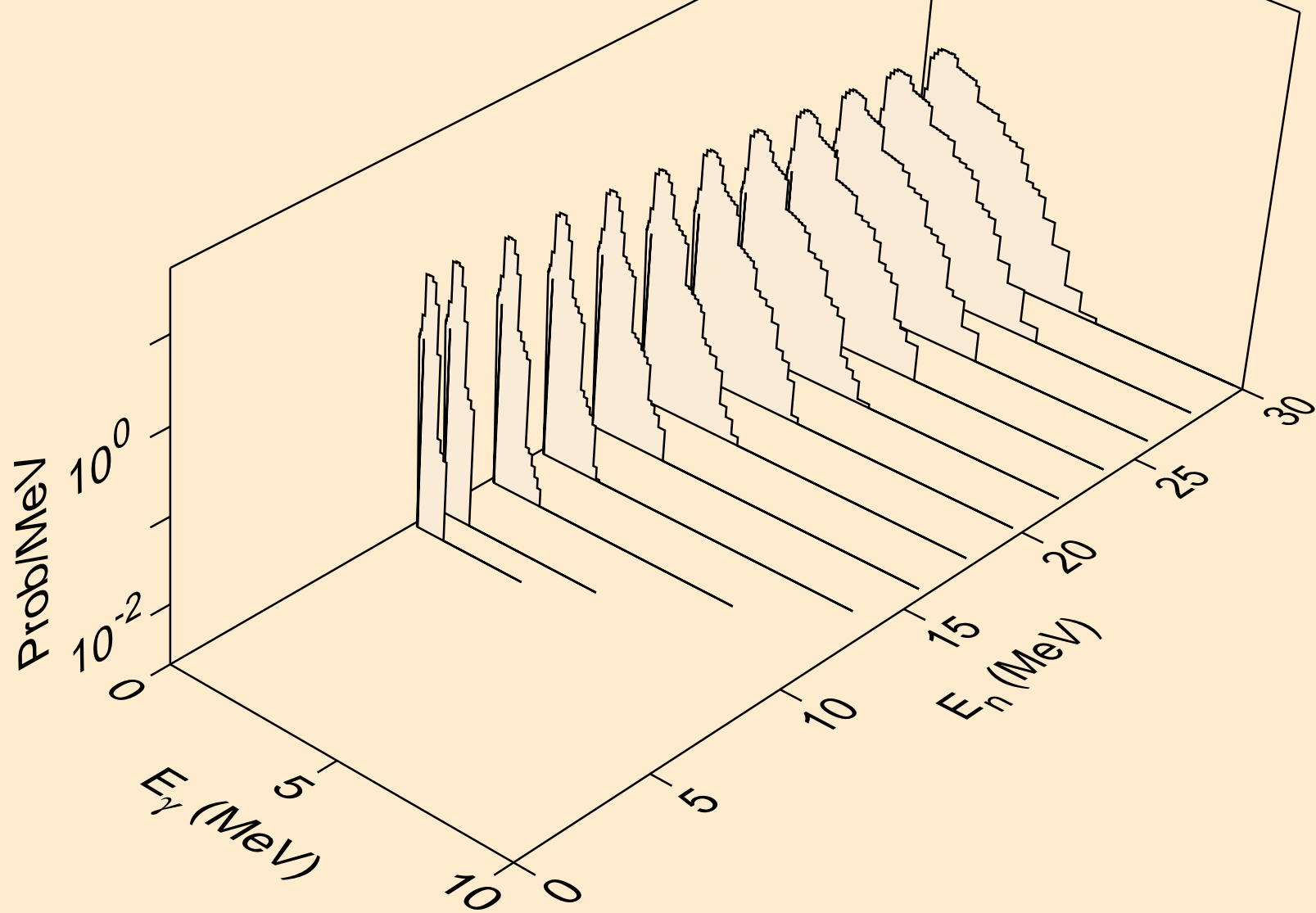

PB185M TRITON ACER TENDL-2021 LIBRARY; T=0.K  
Photon emission for (n,da)

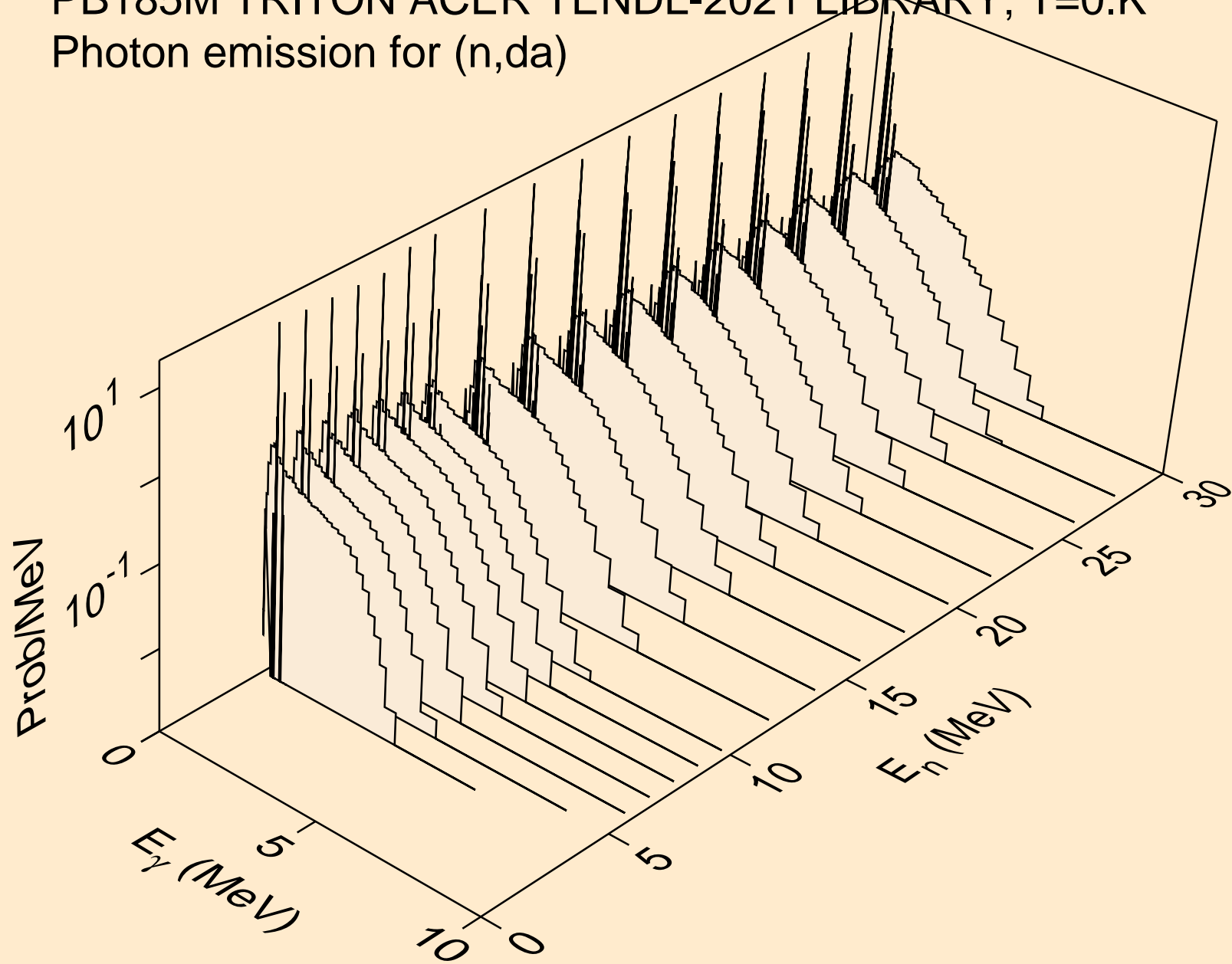

PB185M TRITON ACER TENDL-2021 LIBRARY; T=0.K  
Particle heating contributions

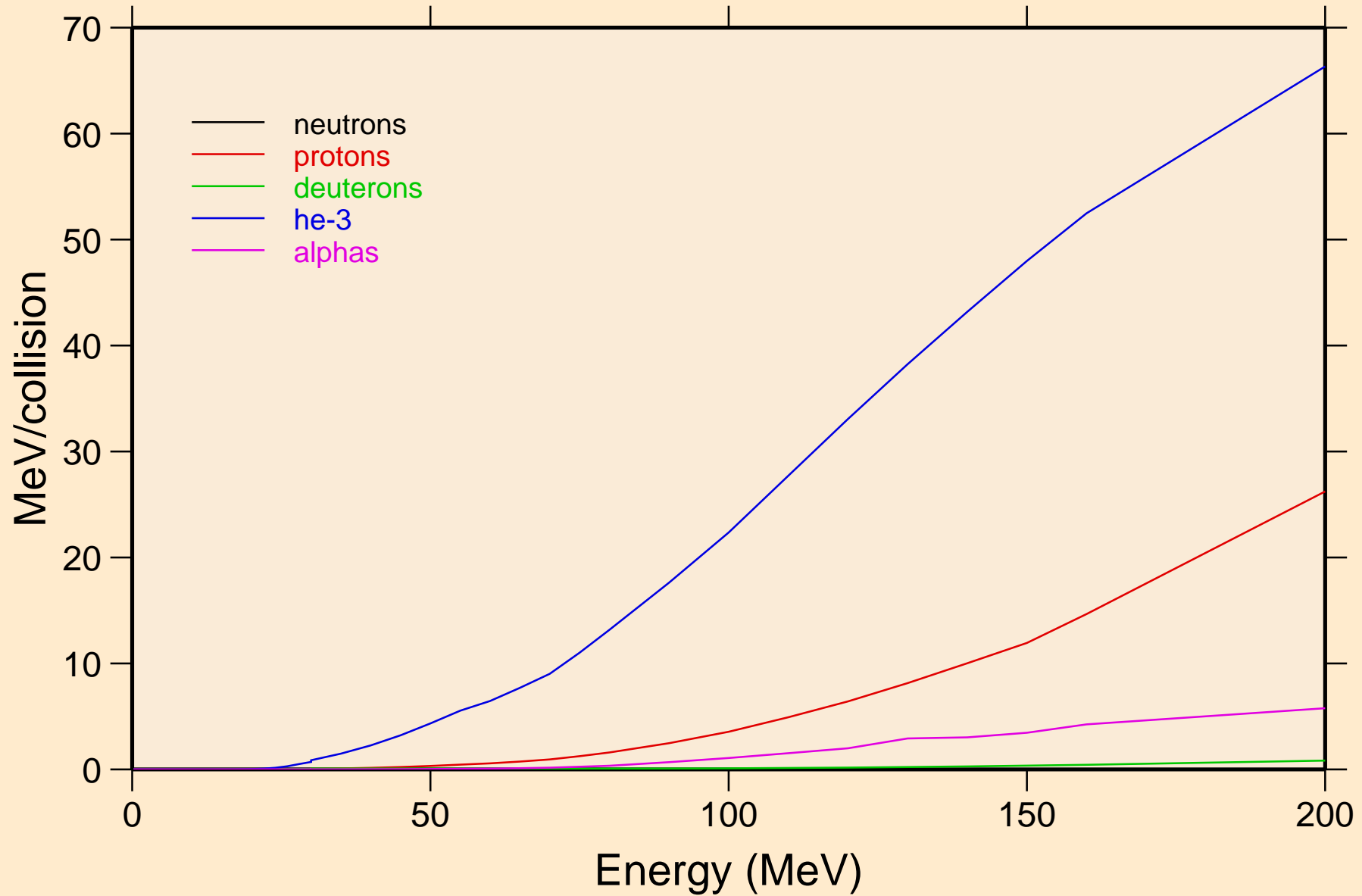



PB185M TRITON ACER TENDL-2021 LIBRARY; T=0.K  
Recoil Heating

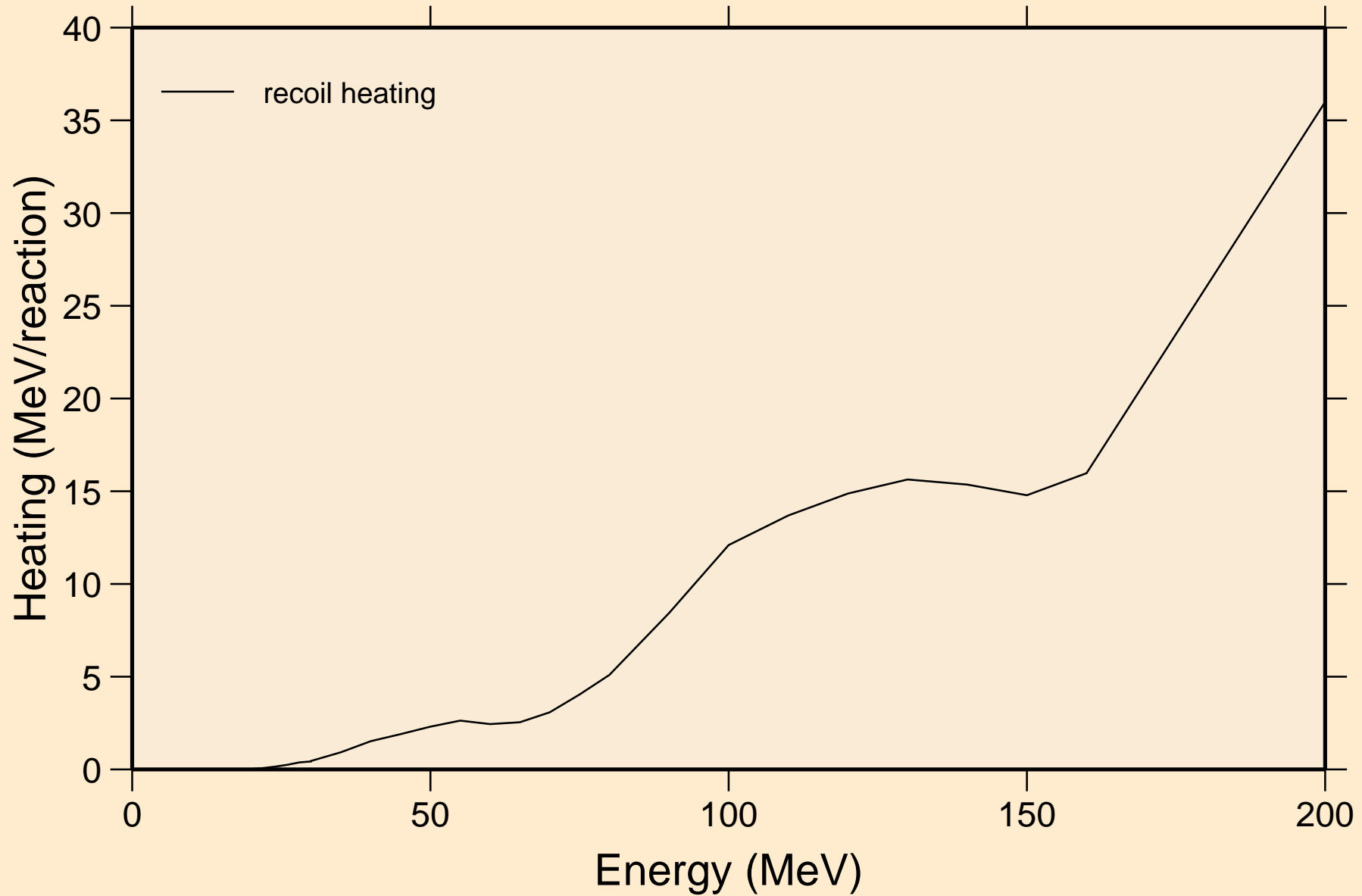

PB185M TRITON ACER TENDL-2021 LIBRARY; T=0.K  
Particle production cross sections

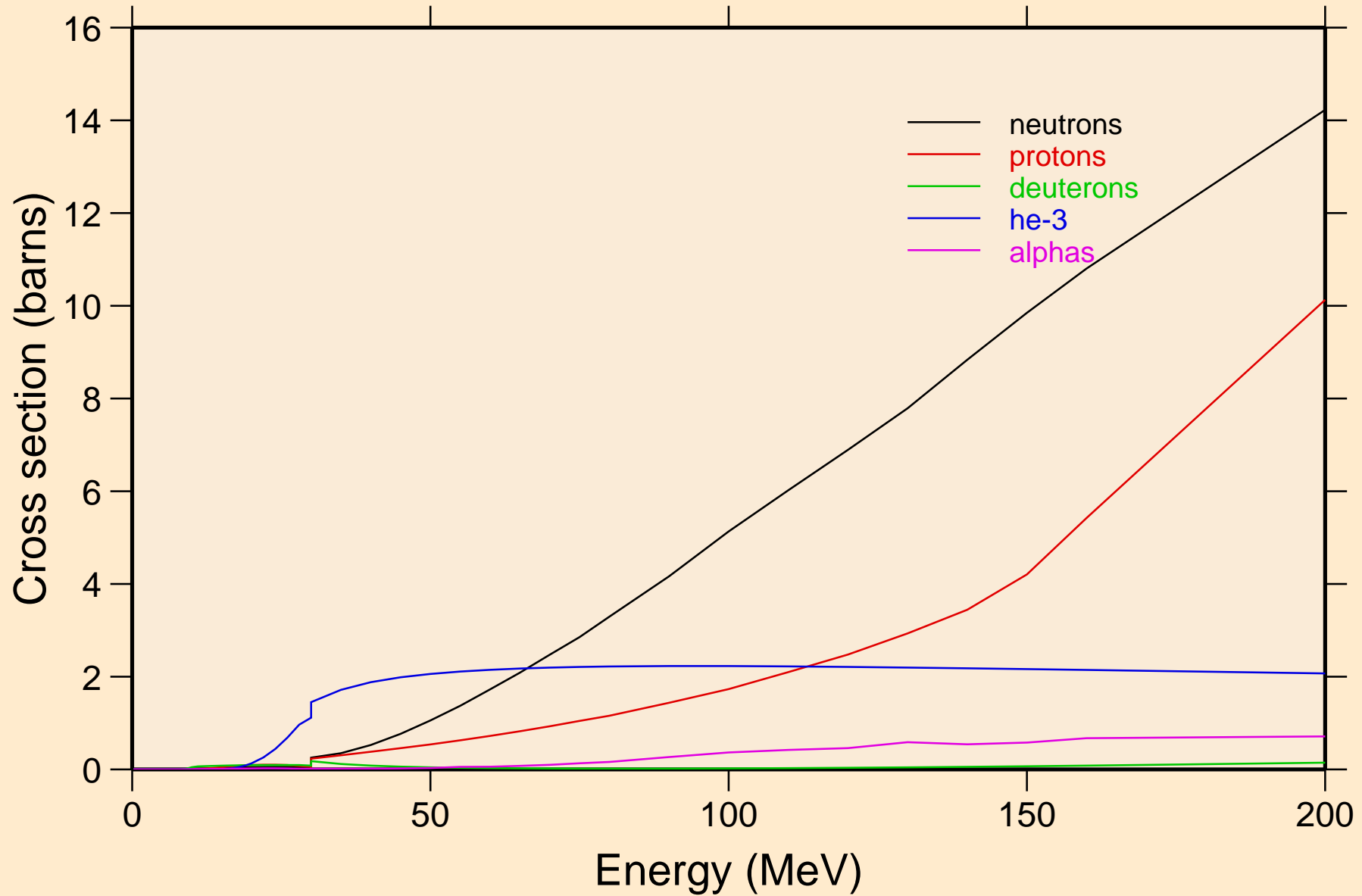

PB185M TRITON ACER TENDL-2021 LIBRARY; T=0.K  
neutrons from (t,n)

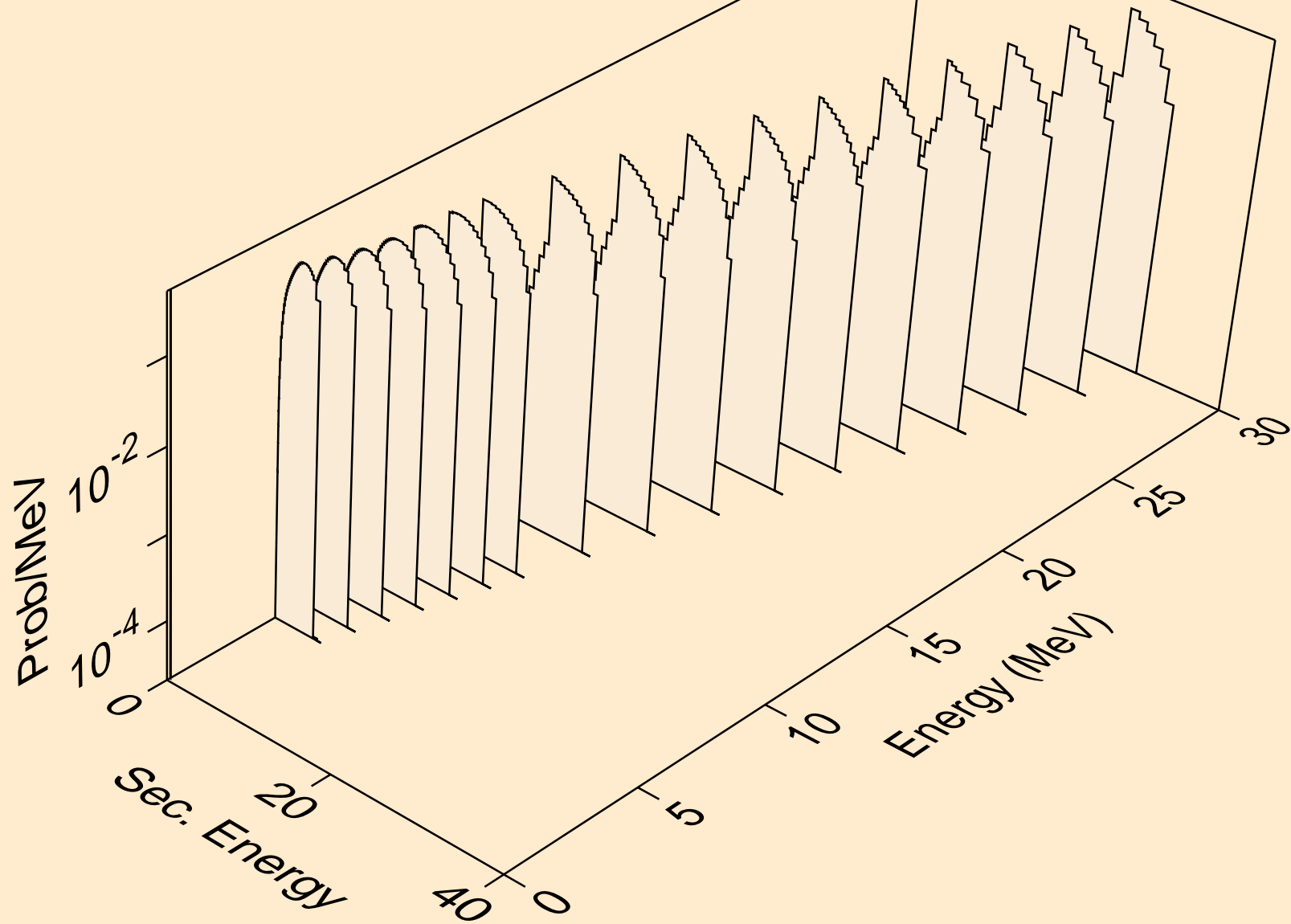

PB185M TRITON ACER TENDL-2021 LIBRARY; T=0.K  
neutrons from (t,x)

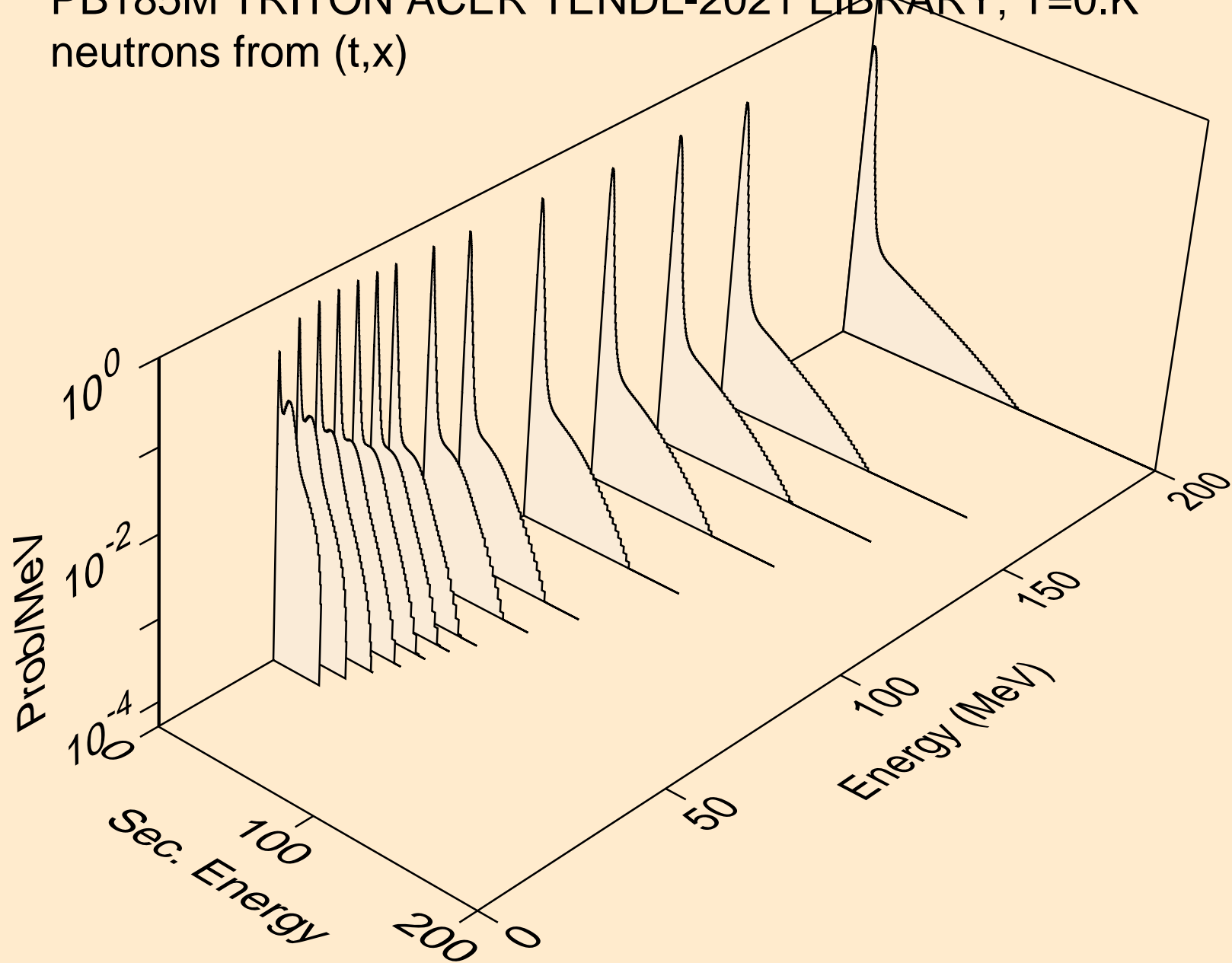

PB185M TRITON ACER TENDL-2021 LIBRARY; T=0.K  
neutrons from (t,2nd)

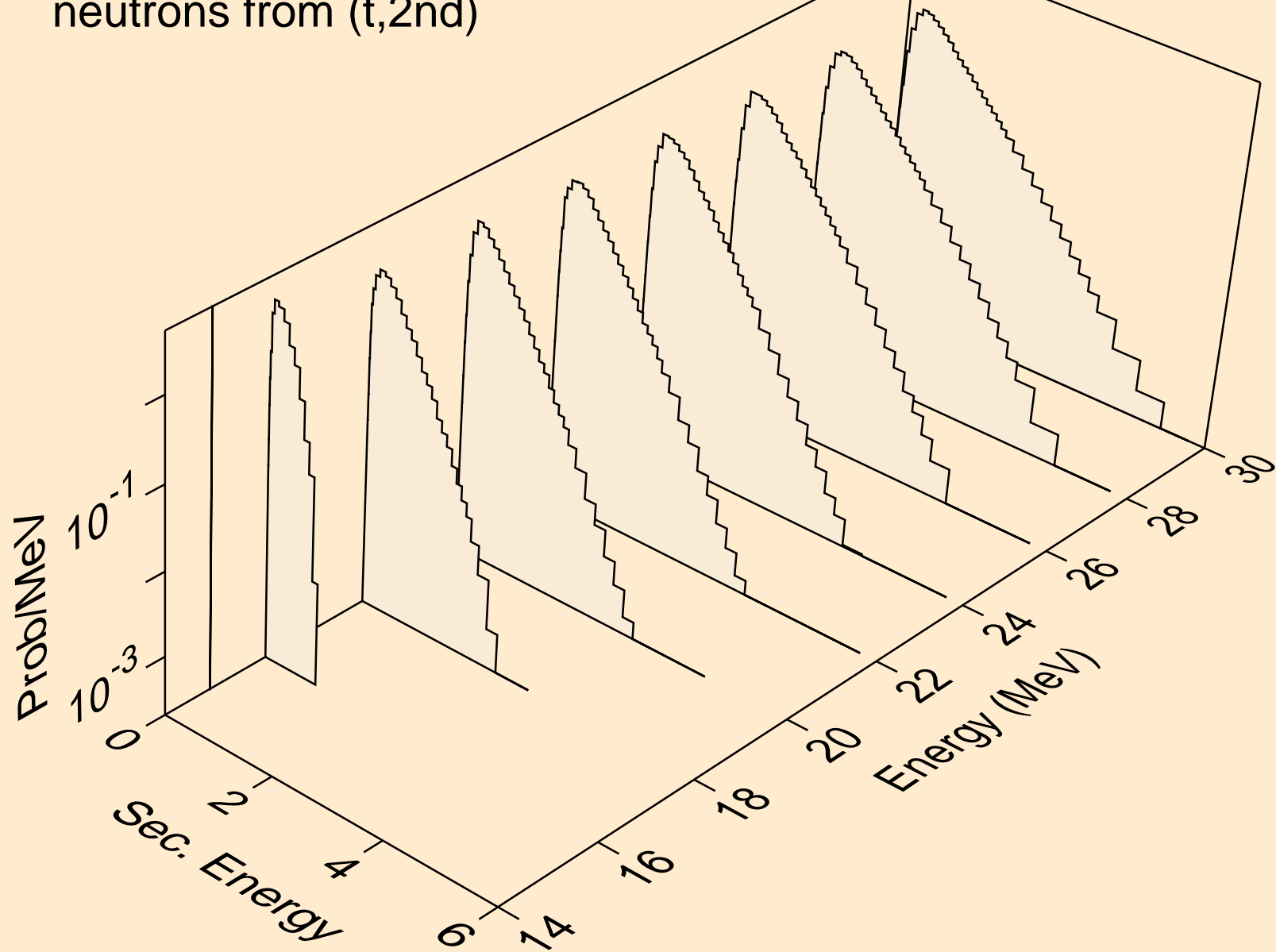

PB185M TRITON ACER TENDL-2021 LIBRARY; T=0.K  
neutrons from (t,2n)

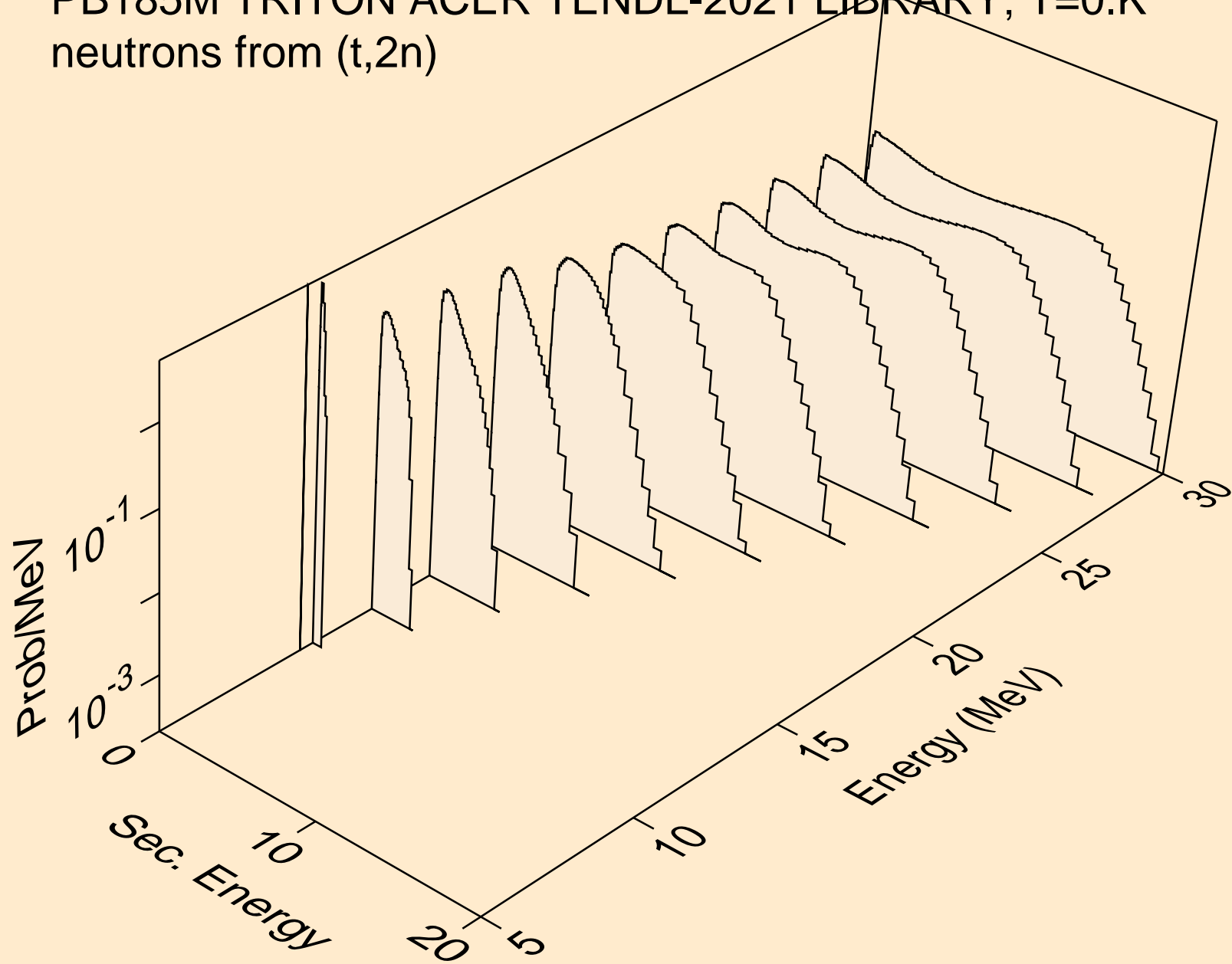

PB185M TRITON ACER TENDL-2021 LIBRARY; T=0.K  
neutrons from (t,3n)

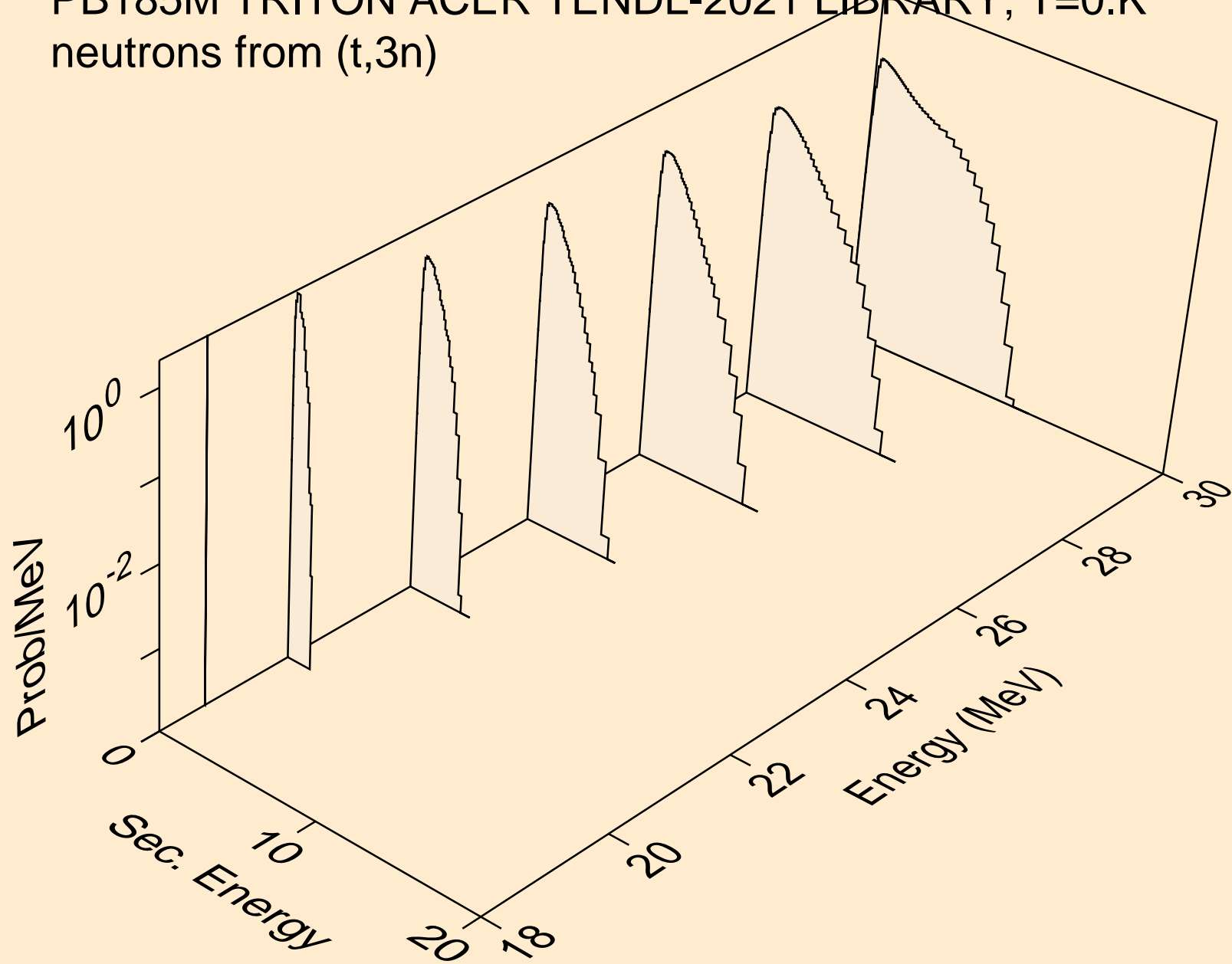

PB185M TRITON ACER TENDL-2021 LIBRARY; T=0.K  
neutrons from (t,n\*)a

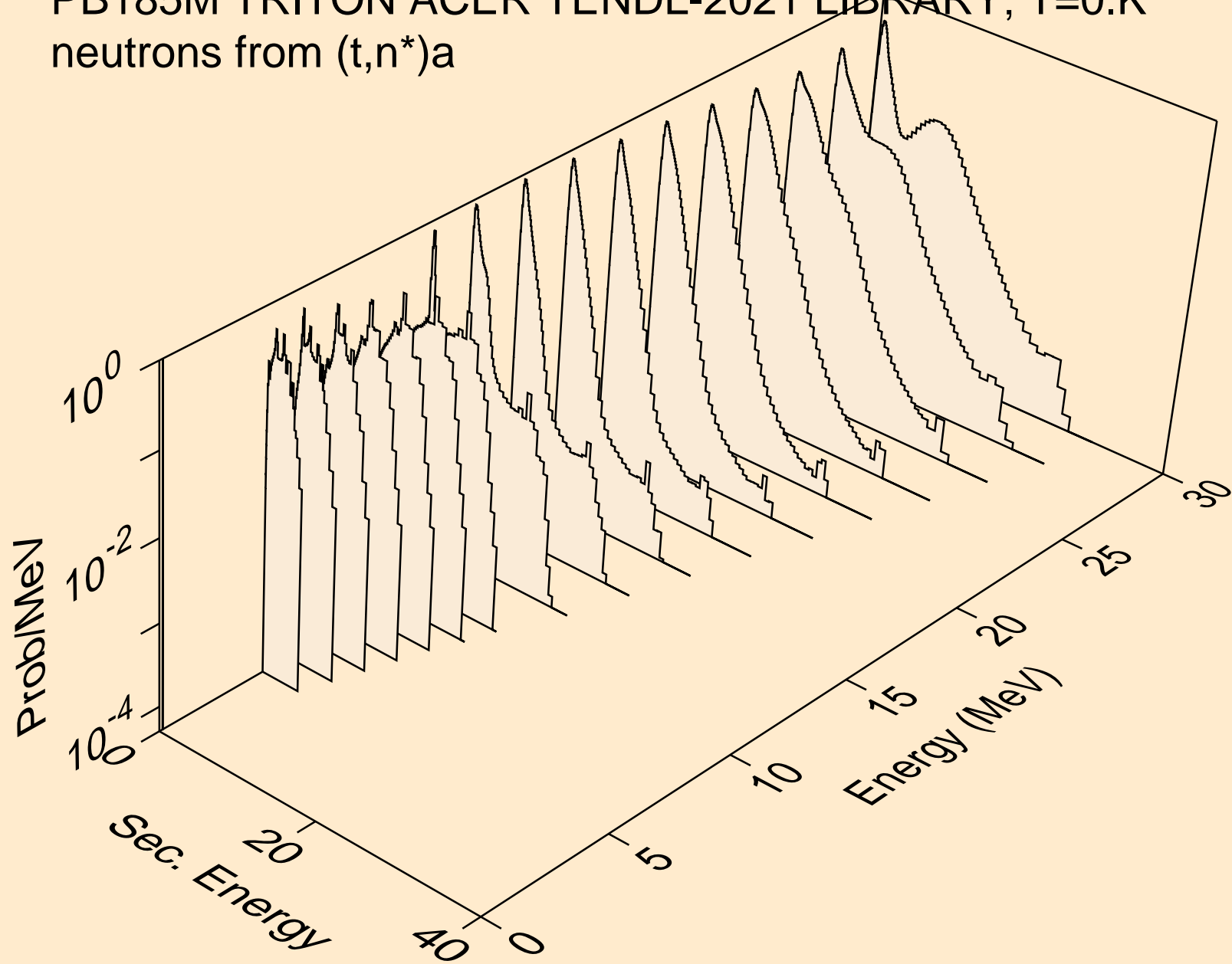



PB185M TRITON ACER TENDL-2021 LIBRARY; T=0.K  
neutrons from (t,n\*)3a

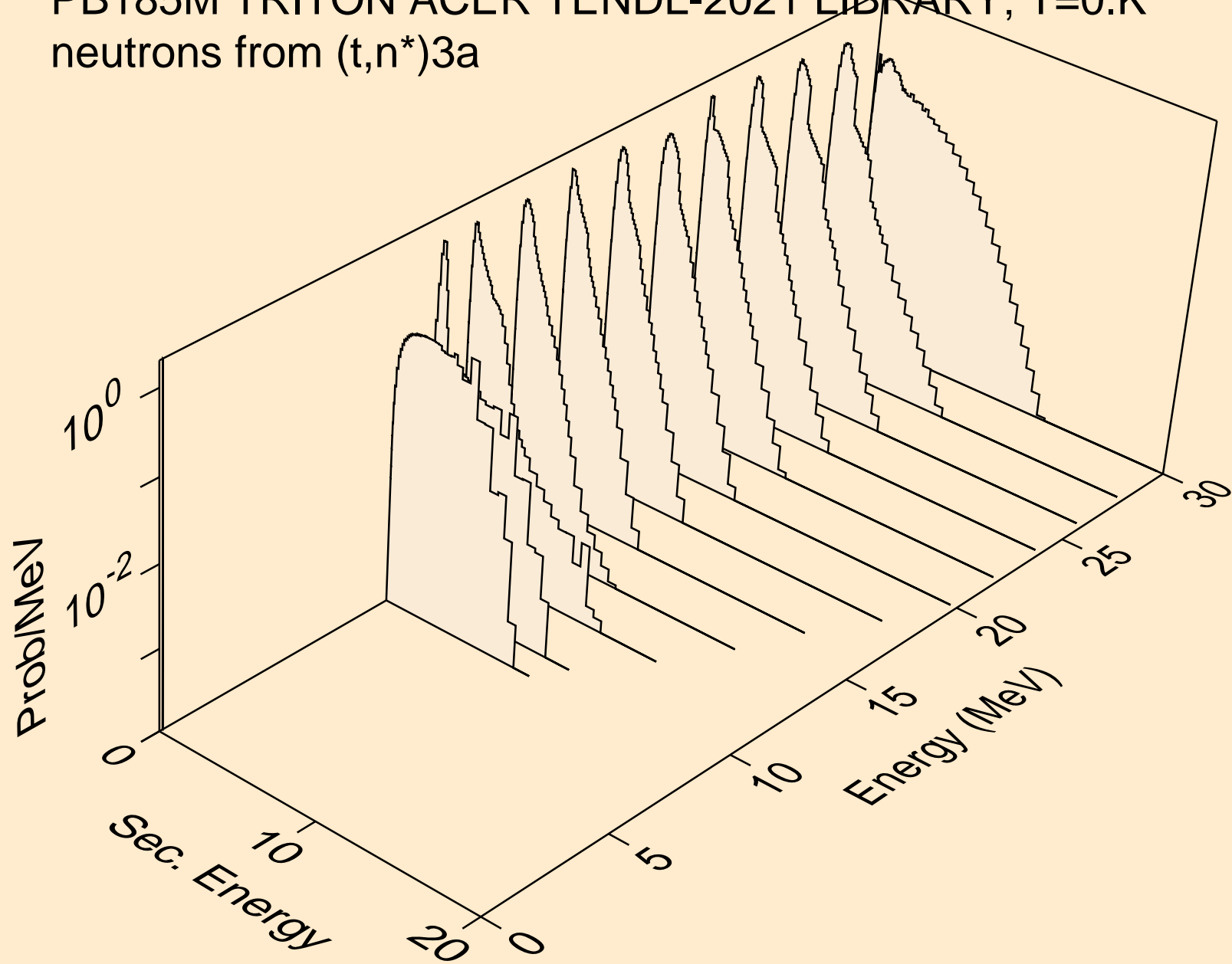

PB185M TRITON ACER TENDL-2021 LIBRARY; T=0.K  
neutrons from (t,2n)a

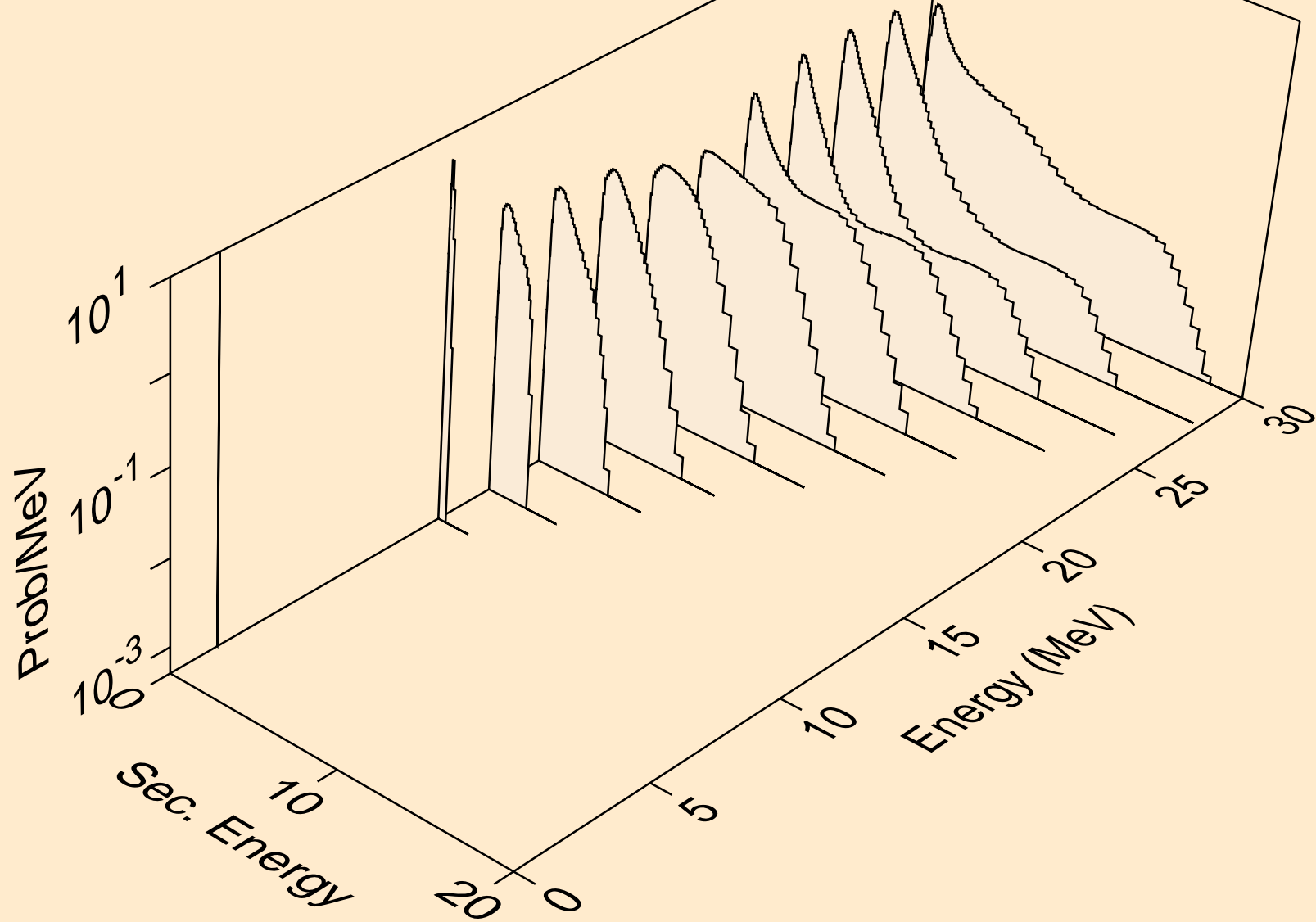

PB185M TRITON ACER TENDL-2021 LIBRARY; T=0.K  
neutrons from (t,3n)a

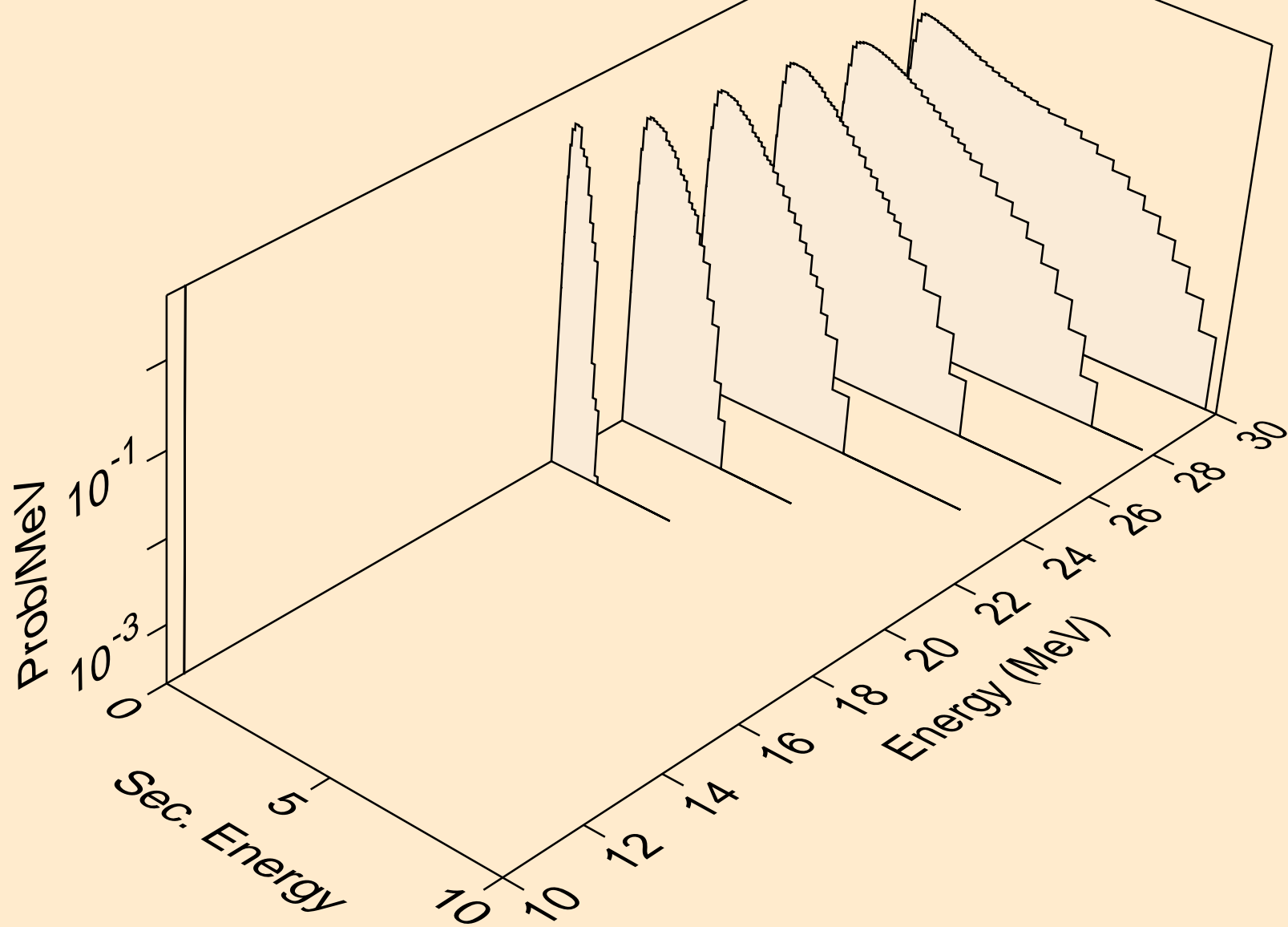

PB185M TRITON ACER TENDL-2021 LIBRARY; T=0.K  
neutrons from (t,n\*)p

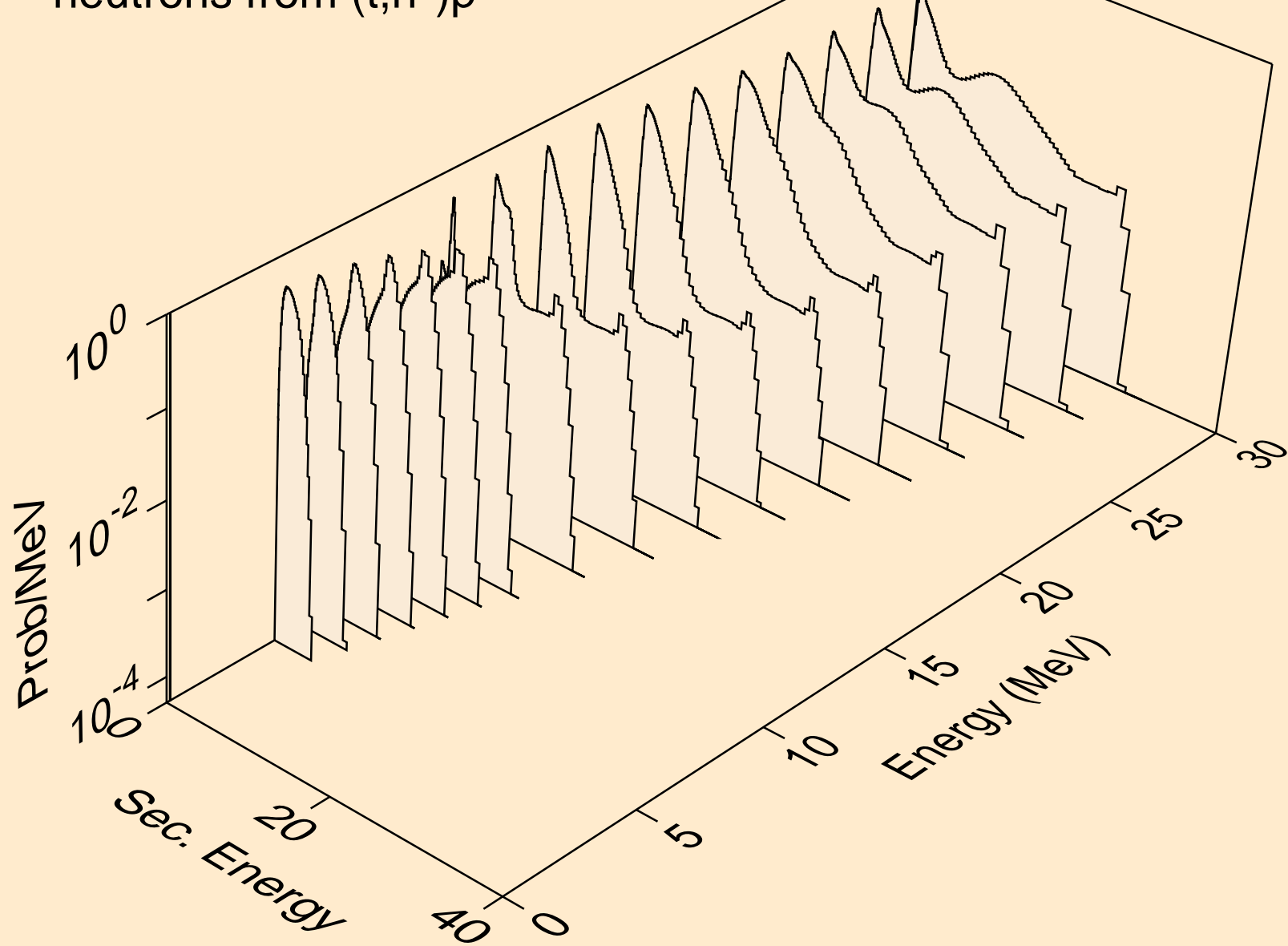

PB185M TRITON ACER TENDL-2021 LIBRARY; T=0.K  
neutrons from (t,n\*)2a

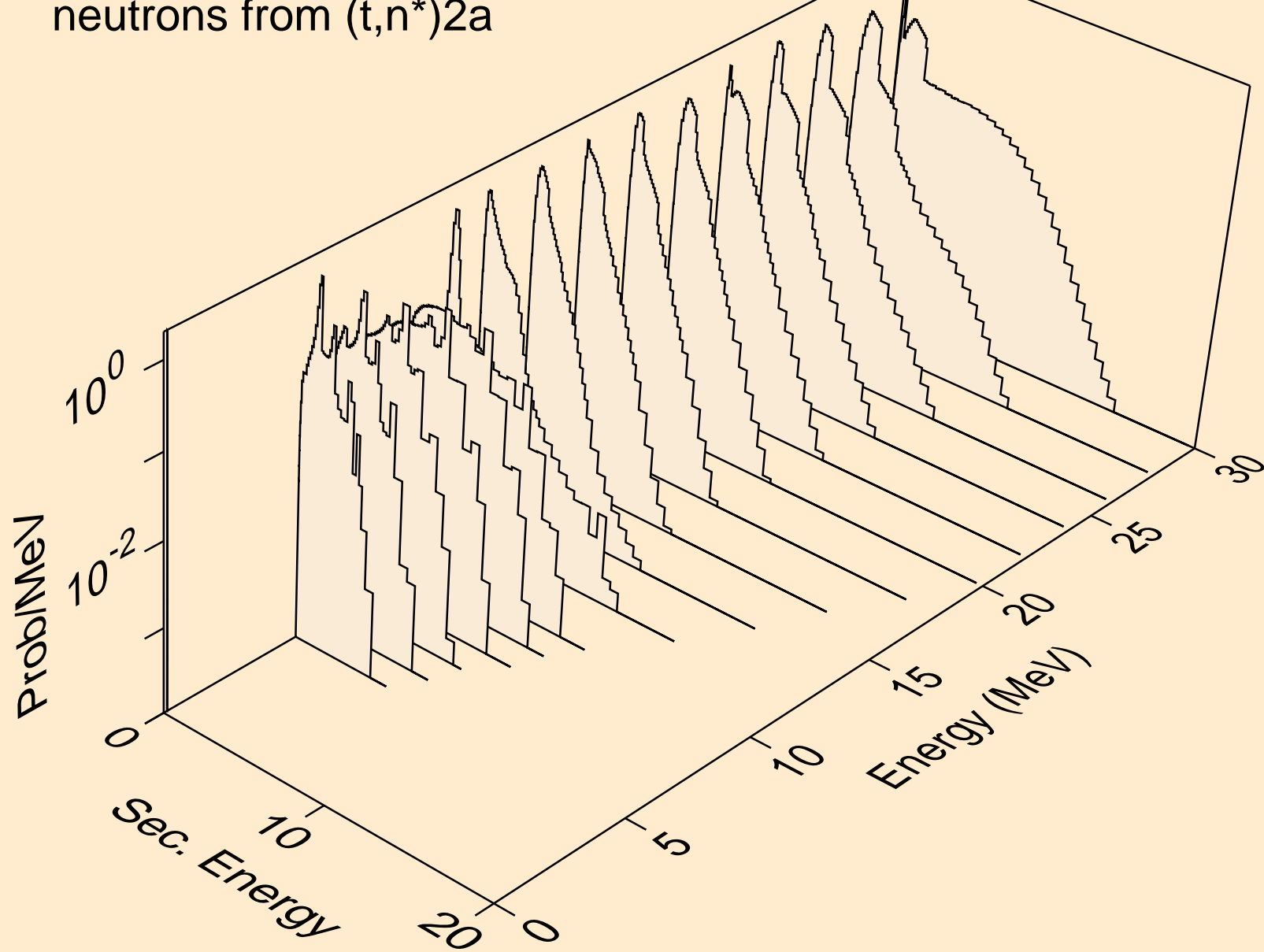

PB185M TRITON ACER TENDL-2021 LIBRARY; T=0.K  
neutrons from (t,2n)2a

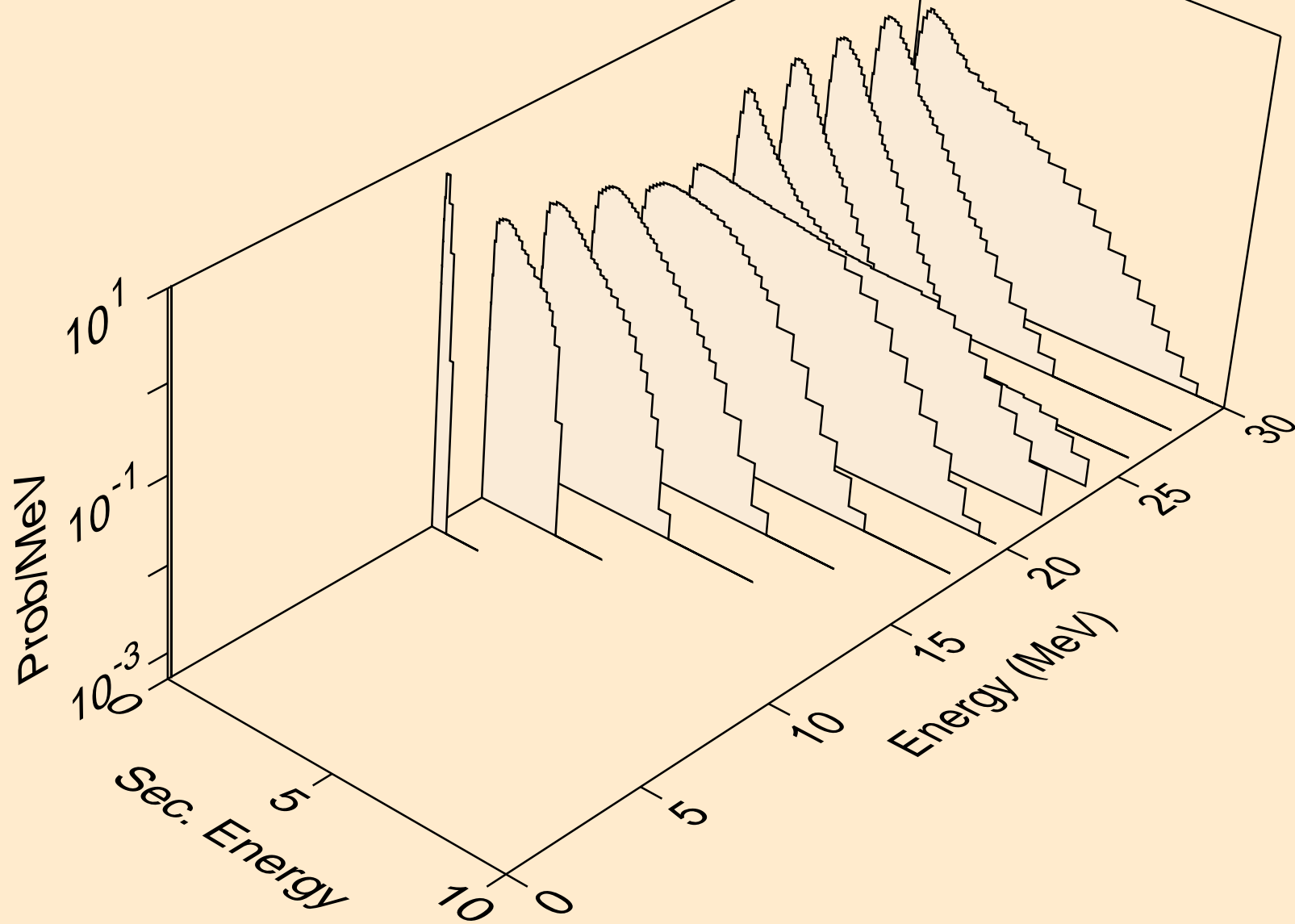

PB185M TRITON ACER TENDL-2021 LIBRARY; T=0.K  
neutrons from (t,n\*)d

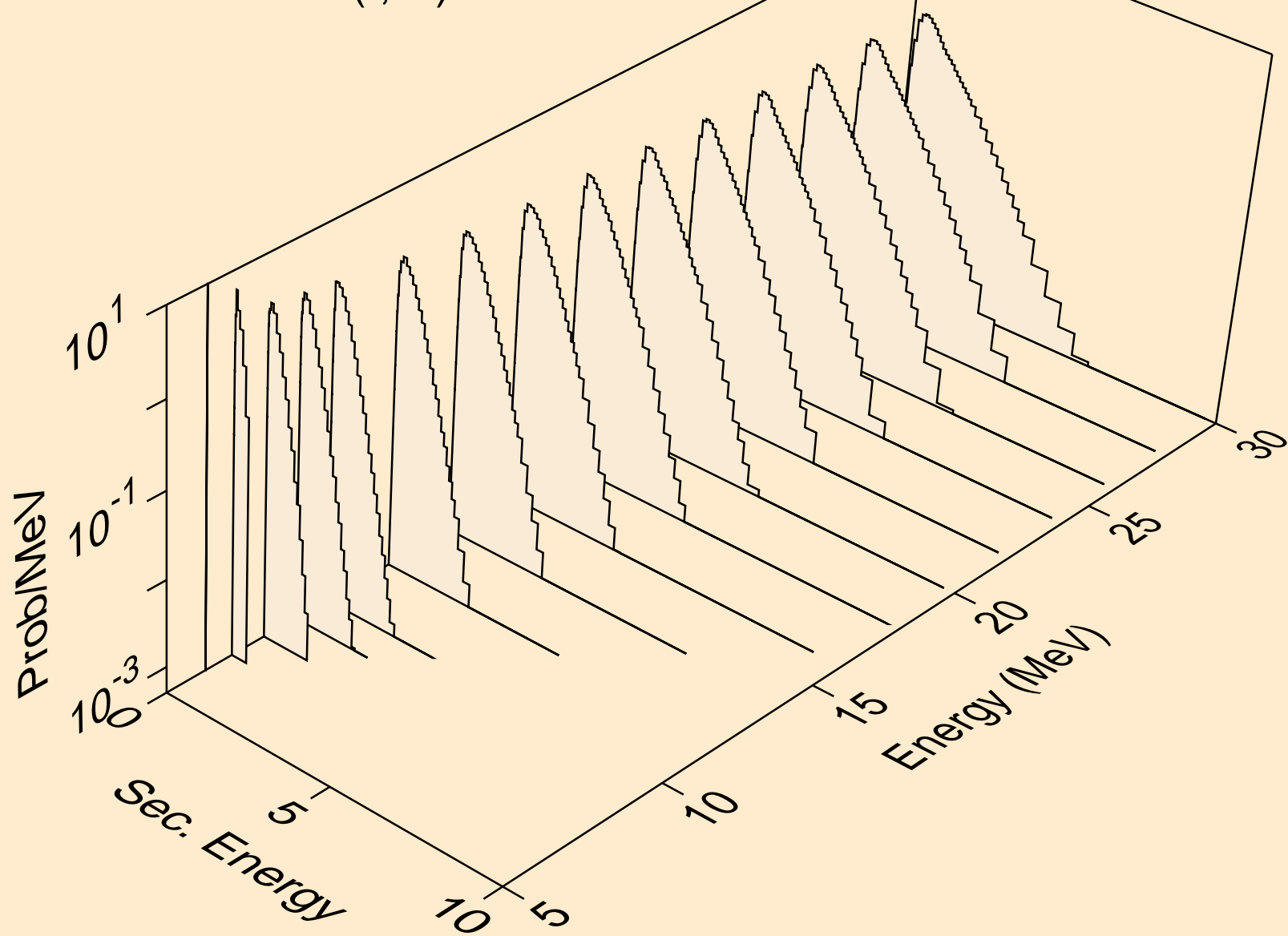

PB185M TRITON ACER TENDL-2021 LIBRARY; T=0.K  
neutrons from (t,n\*)t

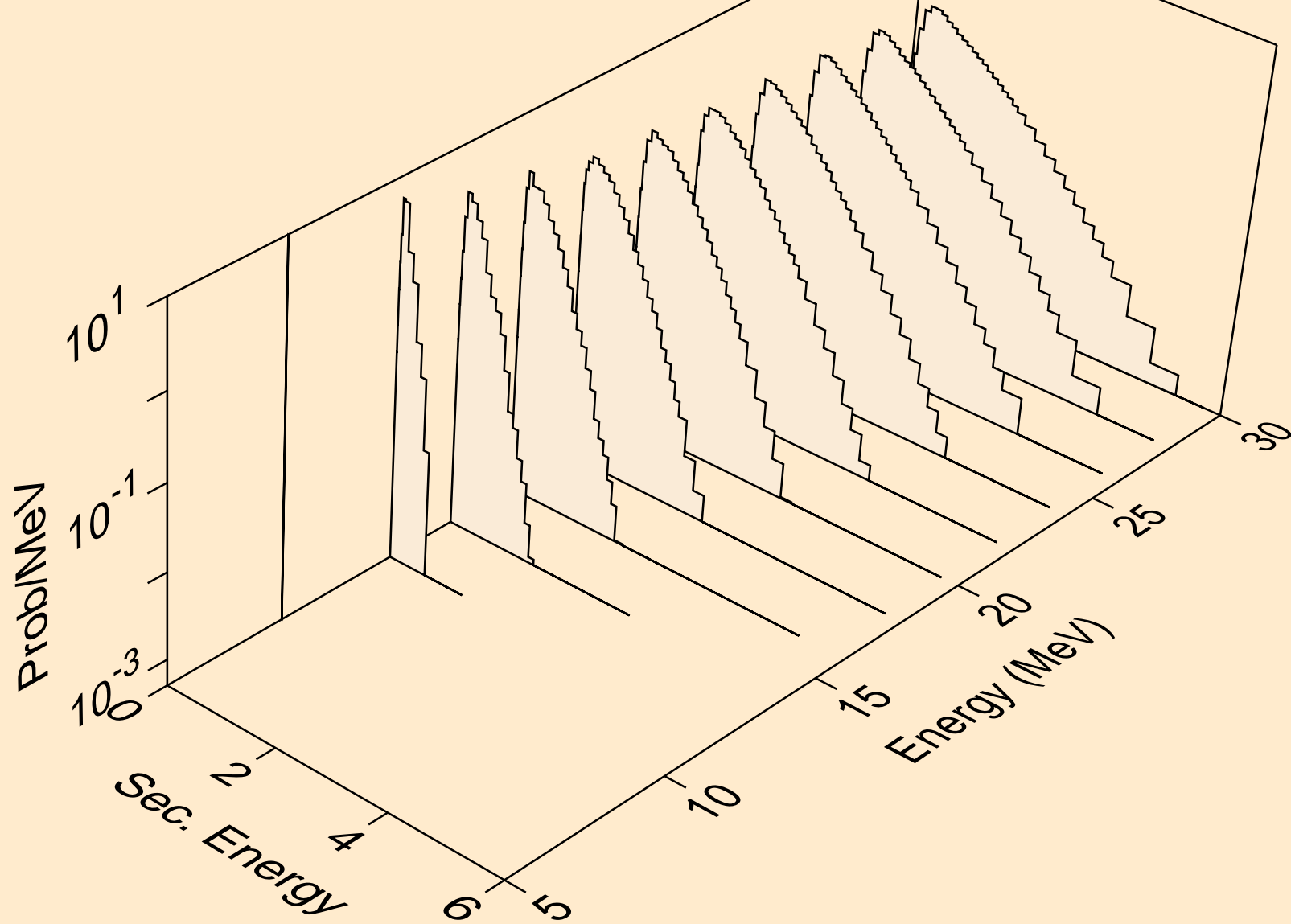



PB185M TRITON ACER TENDL-2021 LIBRARY; T=0.K  
neutrons from (t,n\*)he3

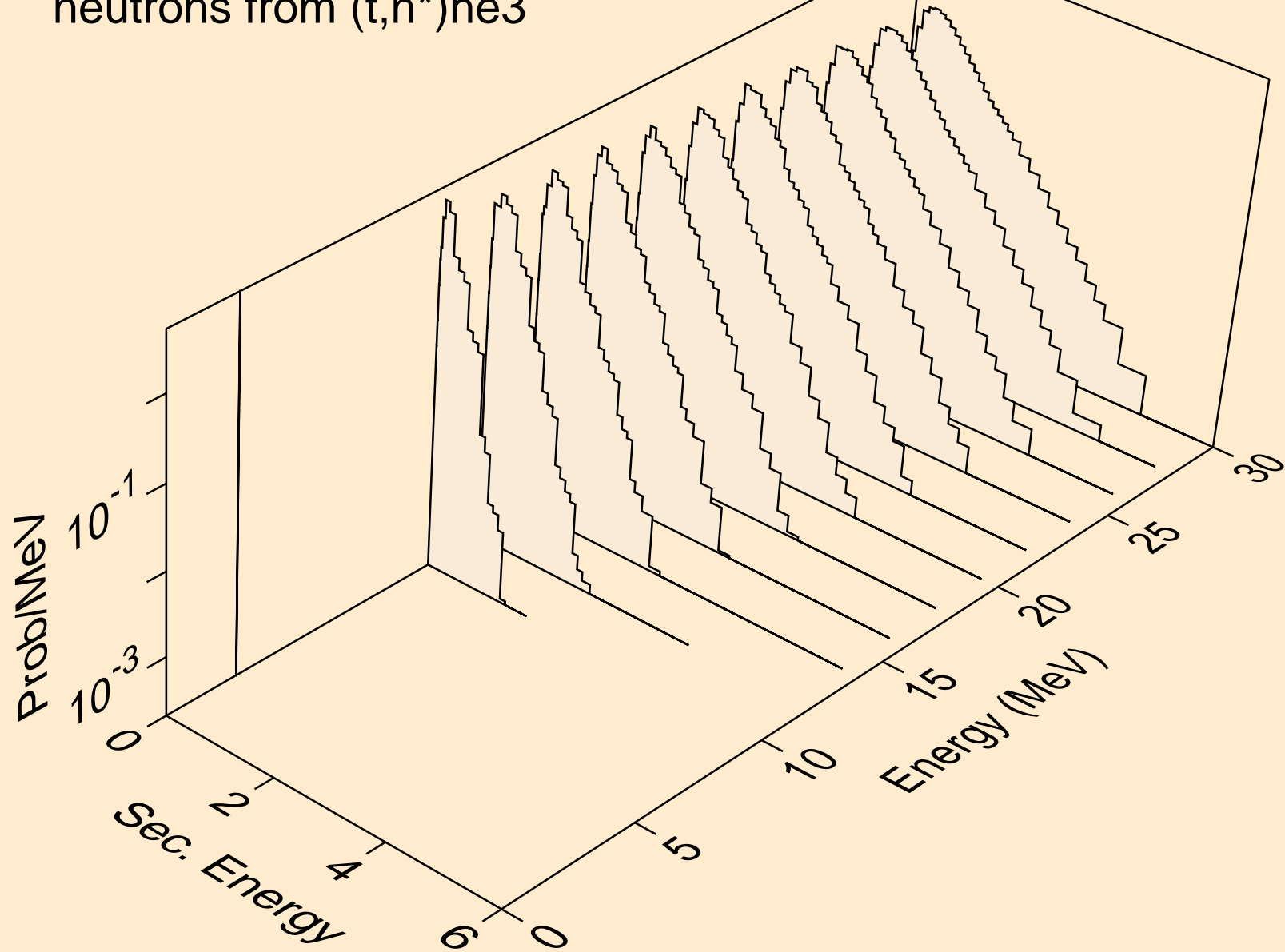

PB185M TRITON ACER TENDL-2021 LIBRARY; T=0.K  
neutrons from (t,2np)

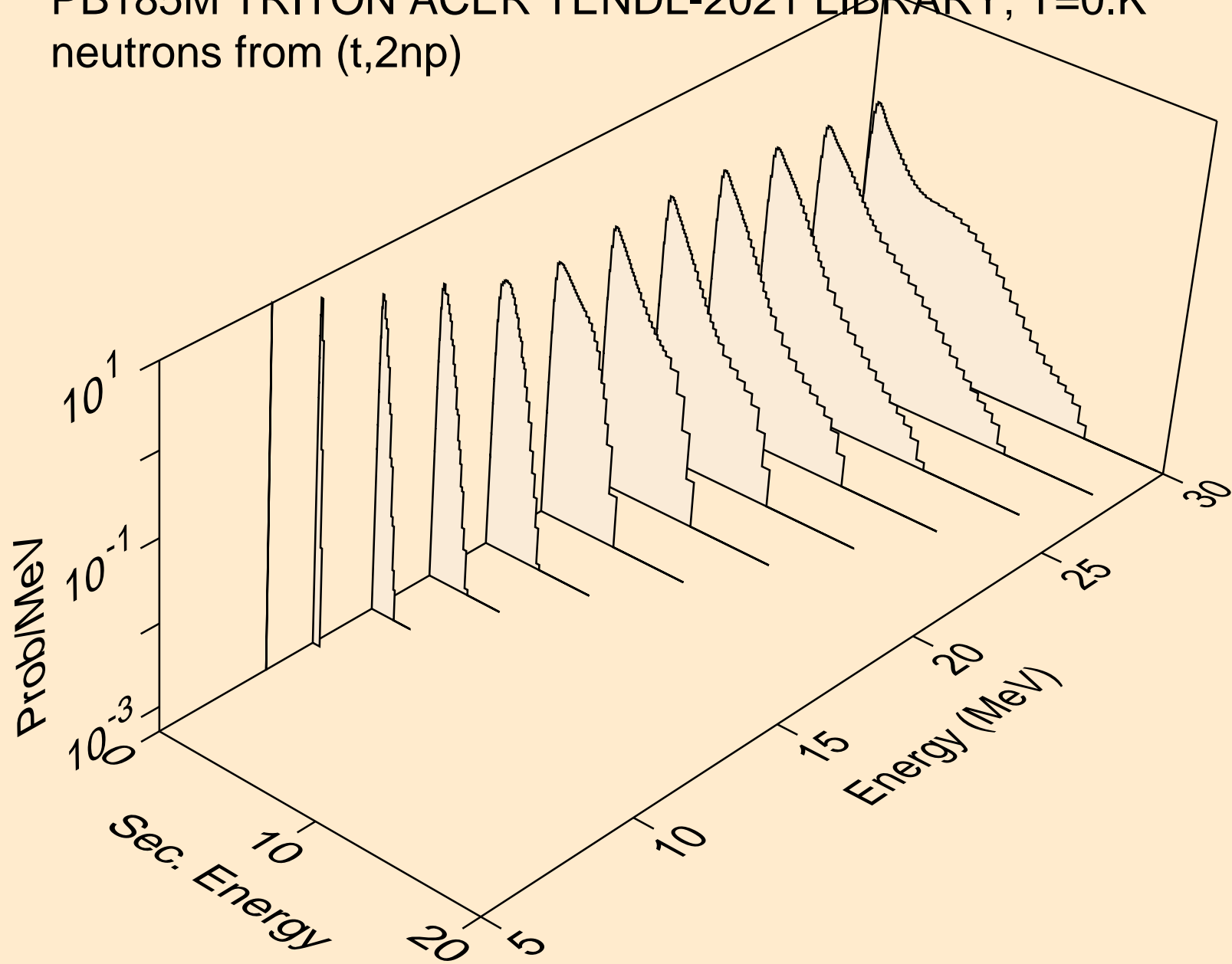

PB185M TRITON ACER TENDL-2021 LIBRARY; T=0.K  
neutrons from (t,3np)

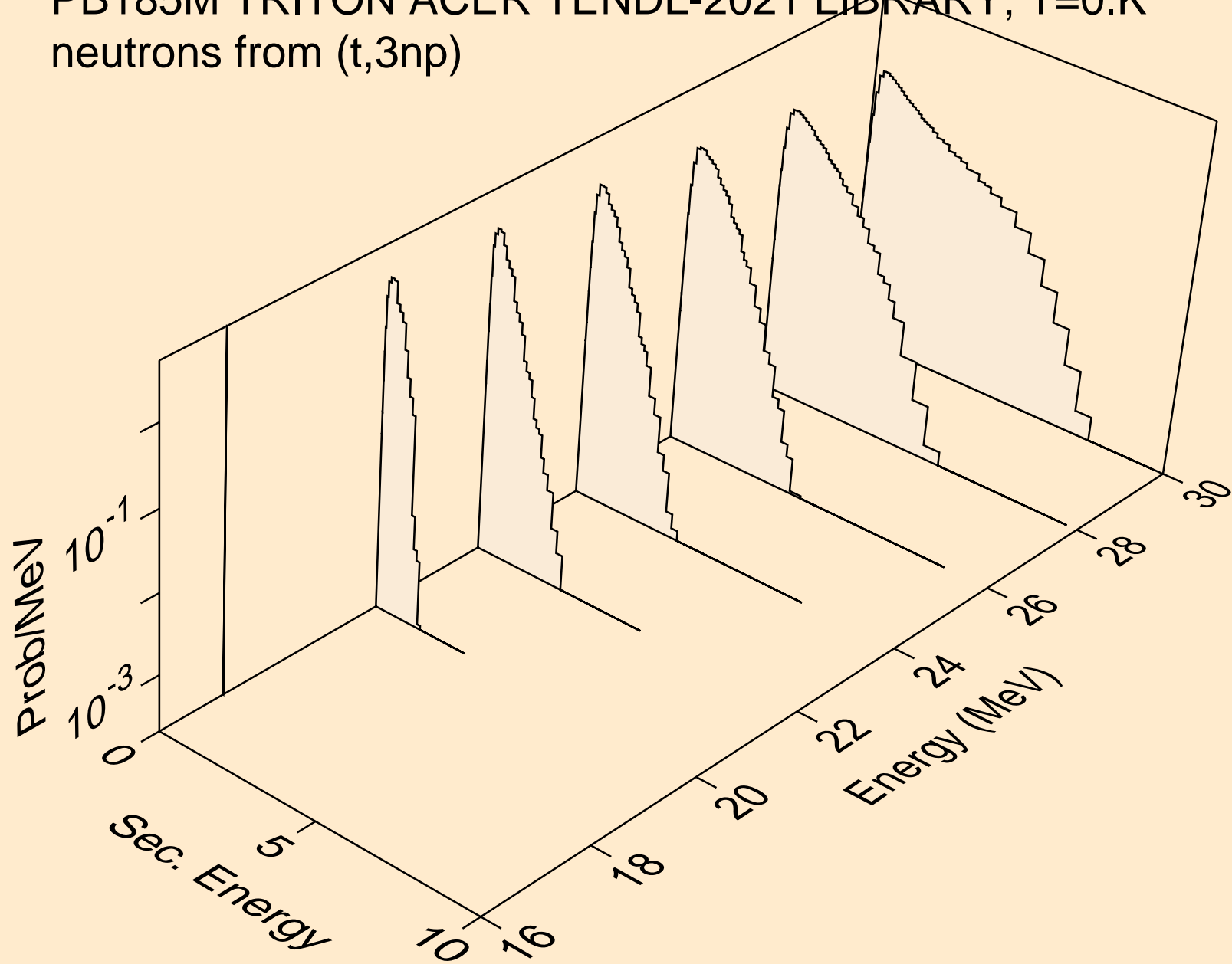

PB185M TRITON ACER TENDL-2021 LIBRARY; T=0.K  
neutrons from (t,2np)

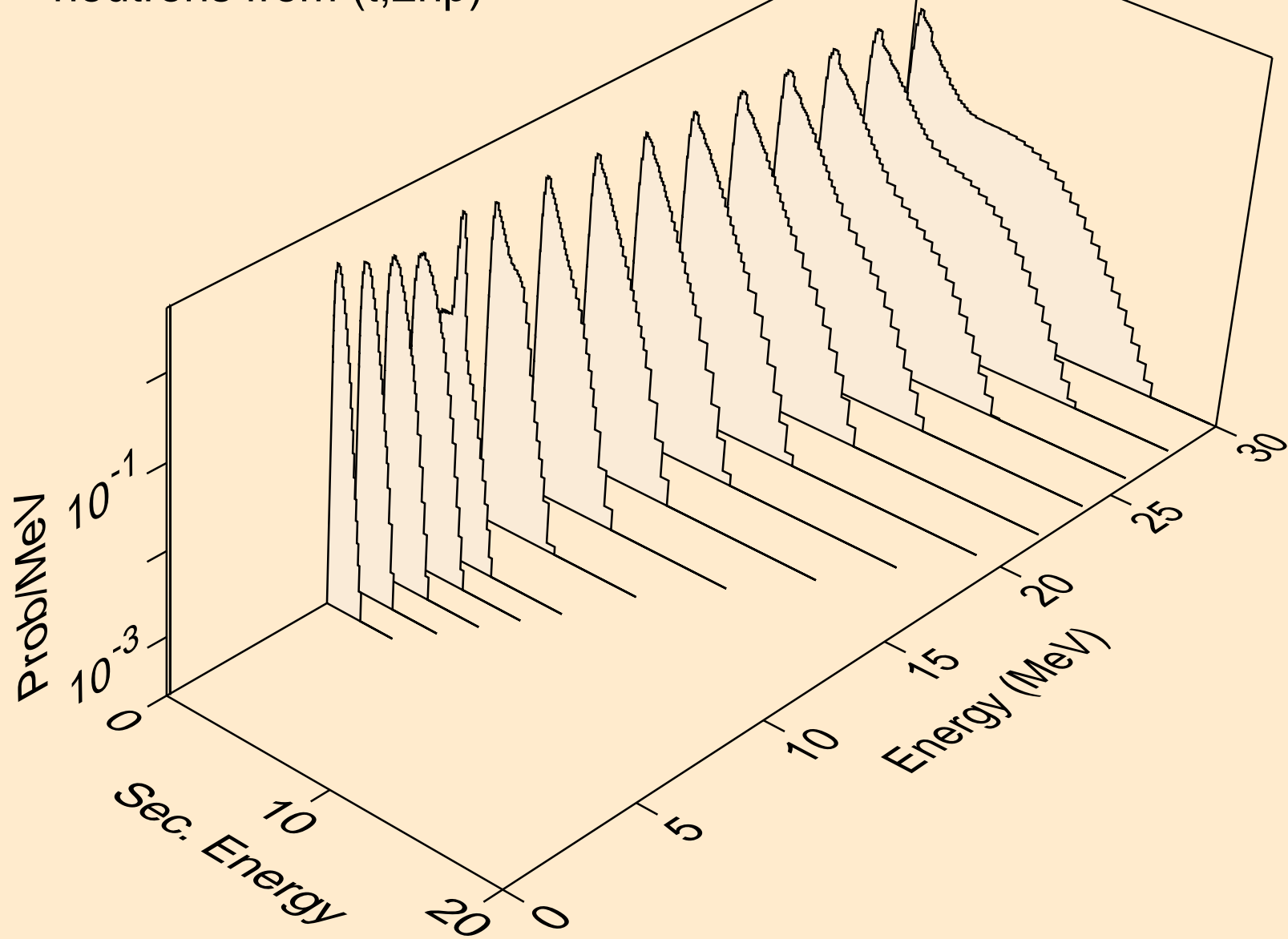

PB185M TRITON ACER TENDL-2021 LIBRARY; T=0.K  
neutrons from (t,npa)

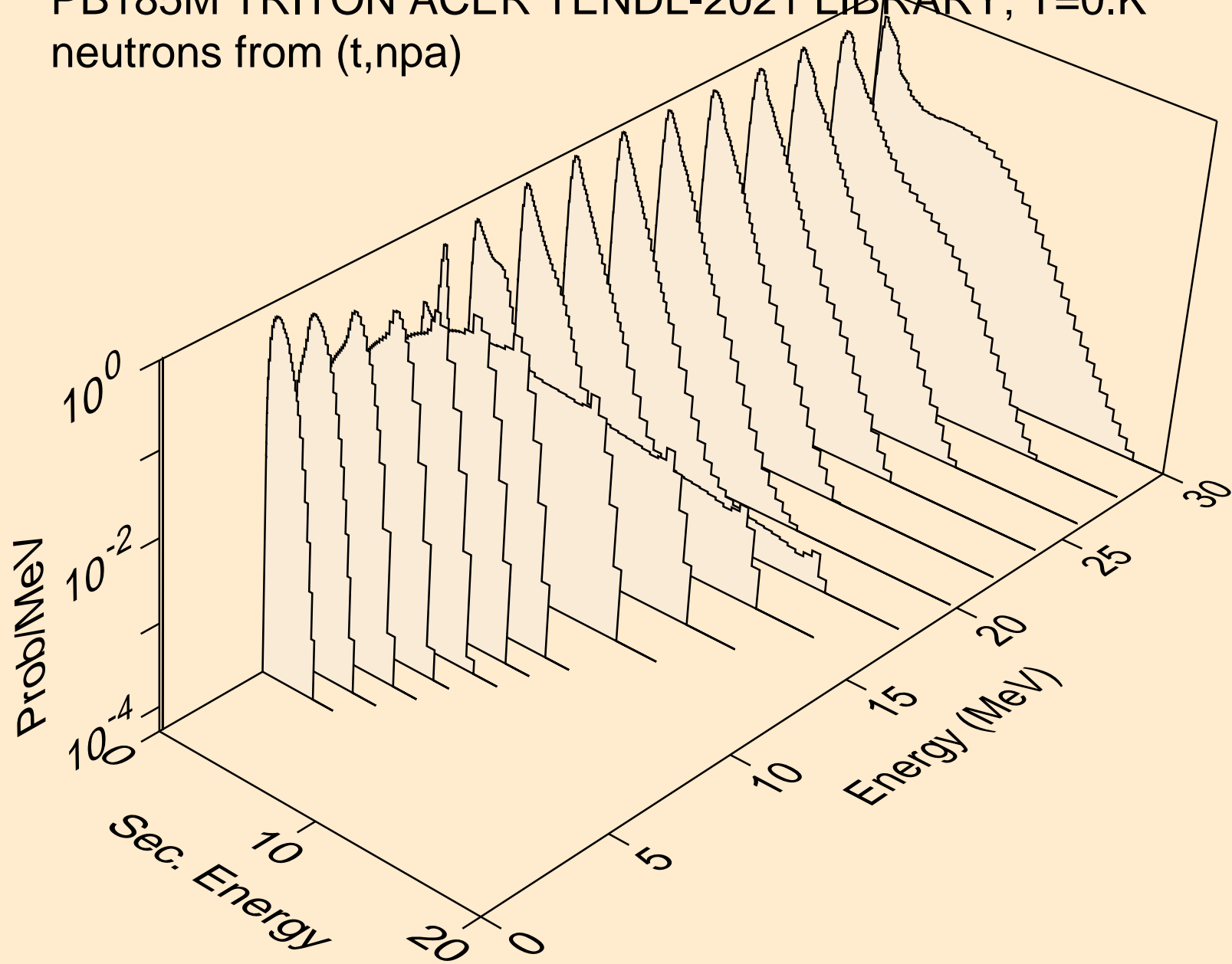

PB185M TRITON ACER TENDL-2021 LIBRARY; T=0.K  
protons from (t,x)

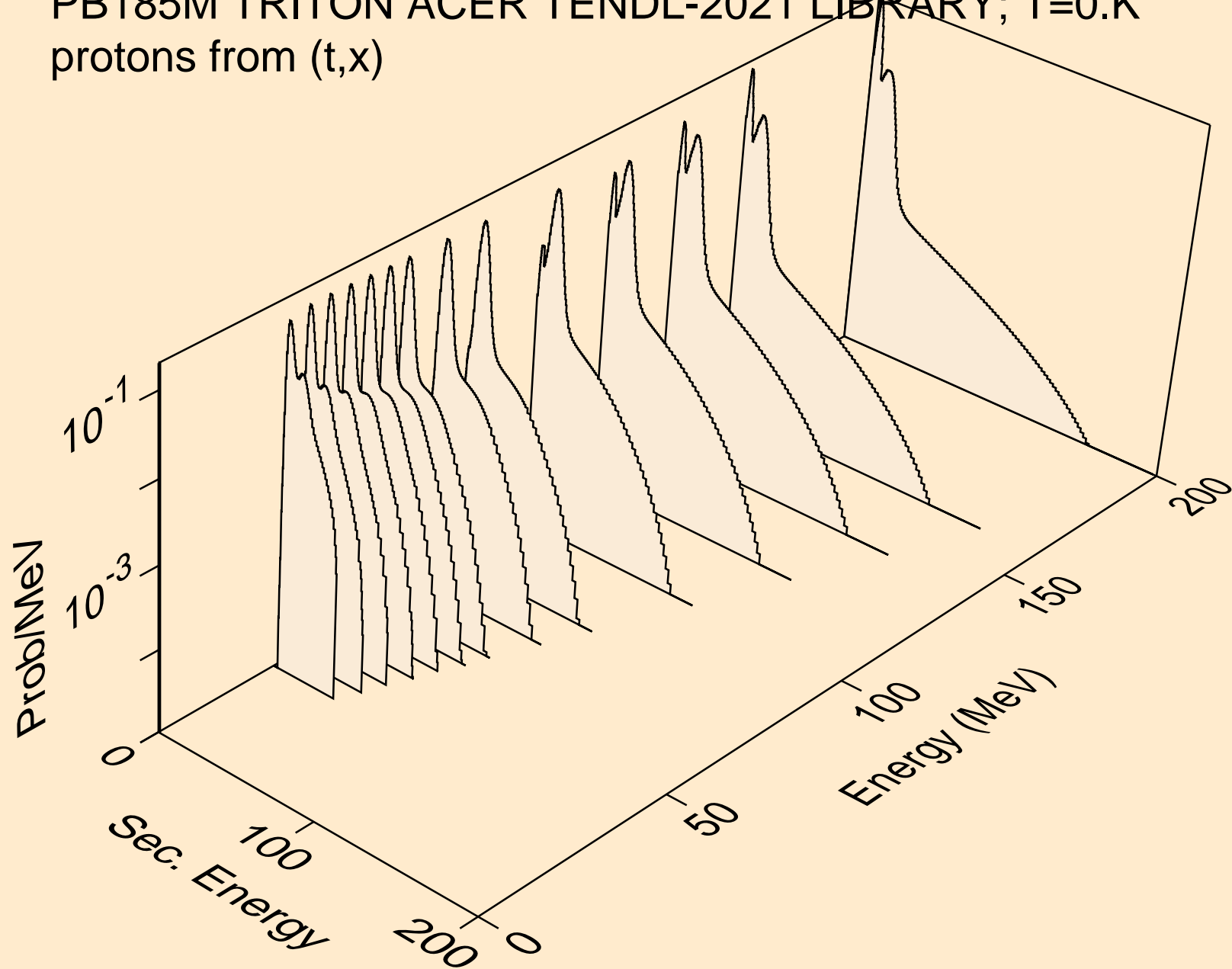

PB185M TRITON ACER TENDL-2021 LIBRARY; T=0.K  
protons from (t,n\*)p

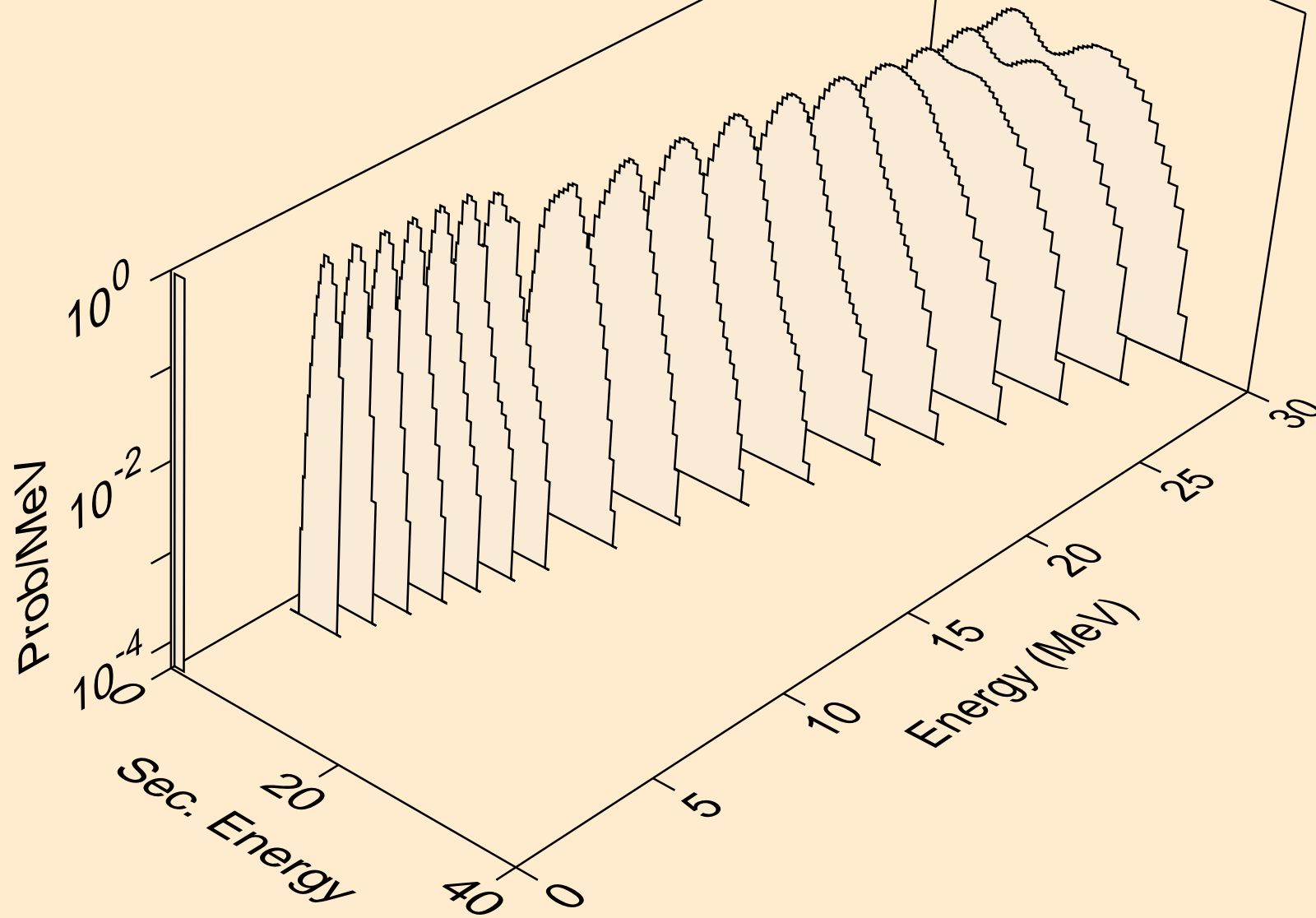

PB185M TRITON ACER TENDL-2021 LIBRARY; T=0.K  
protons from (t,2np)

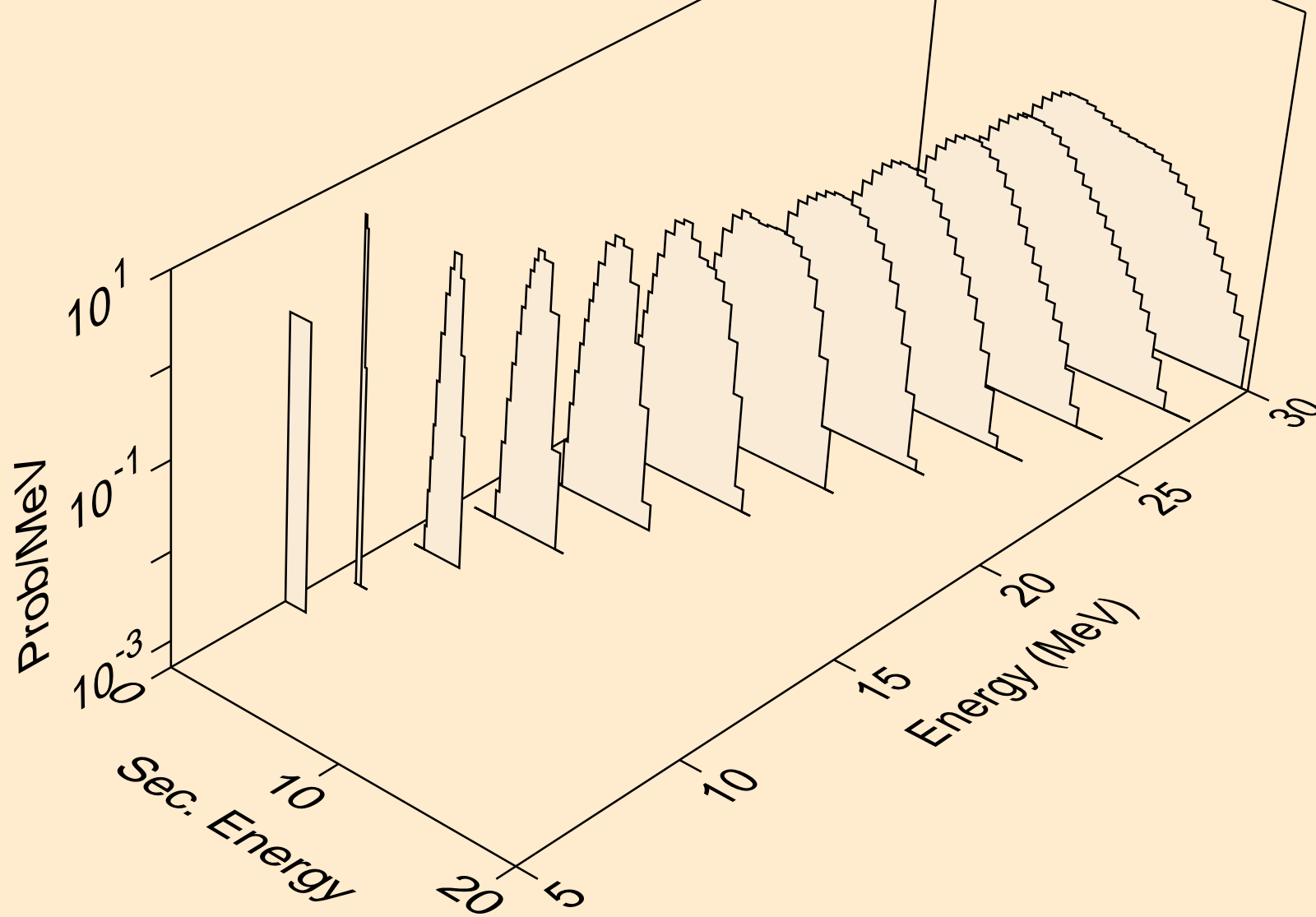



PB185M TRITON ACER TENDL-2021 LIBRARY; T=0.K  
protons from (t,3np)

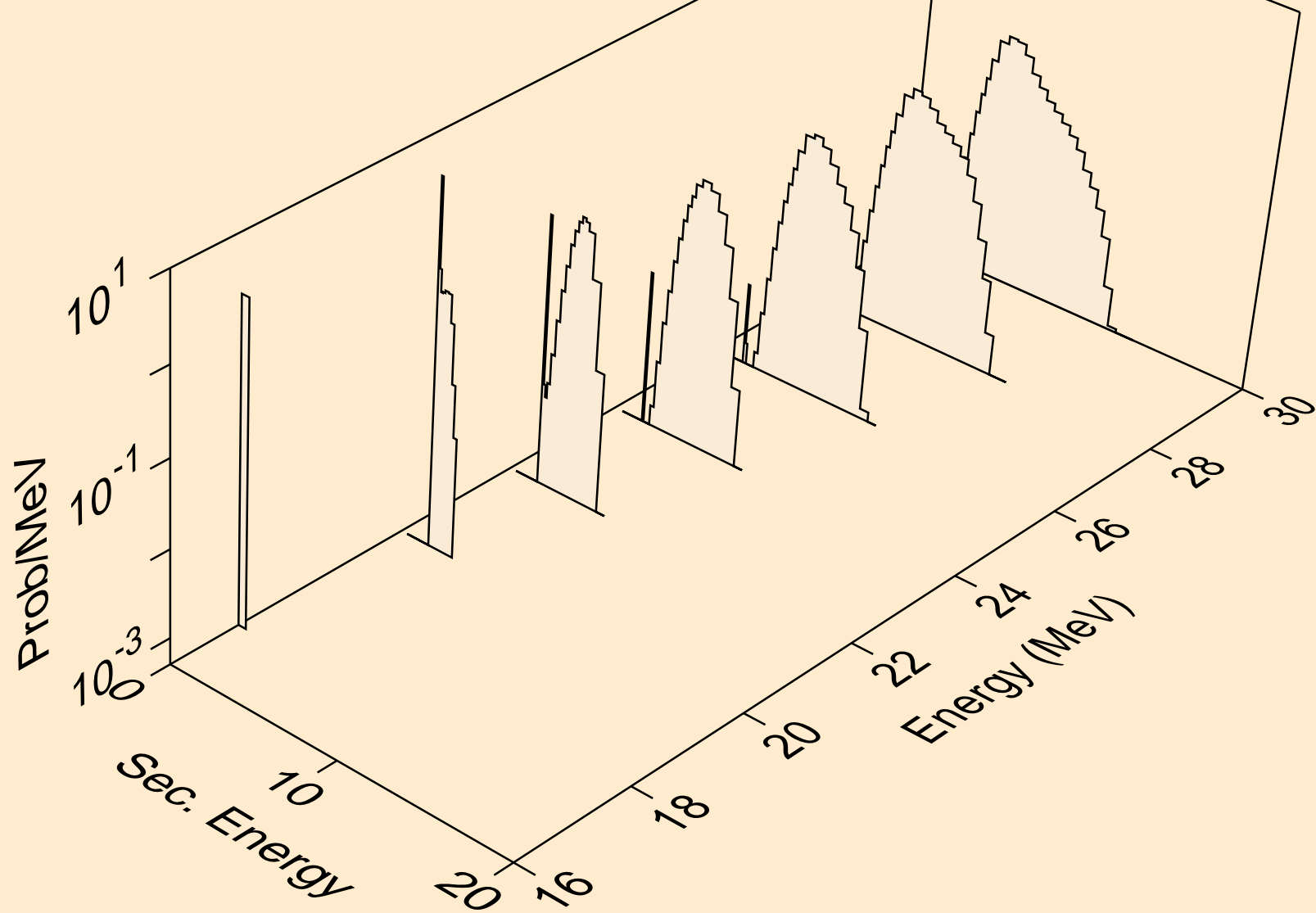

PB185M TRITON ACER TENDL-2021 LIBRARY; T=0.K  
protons from (t,2np)

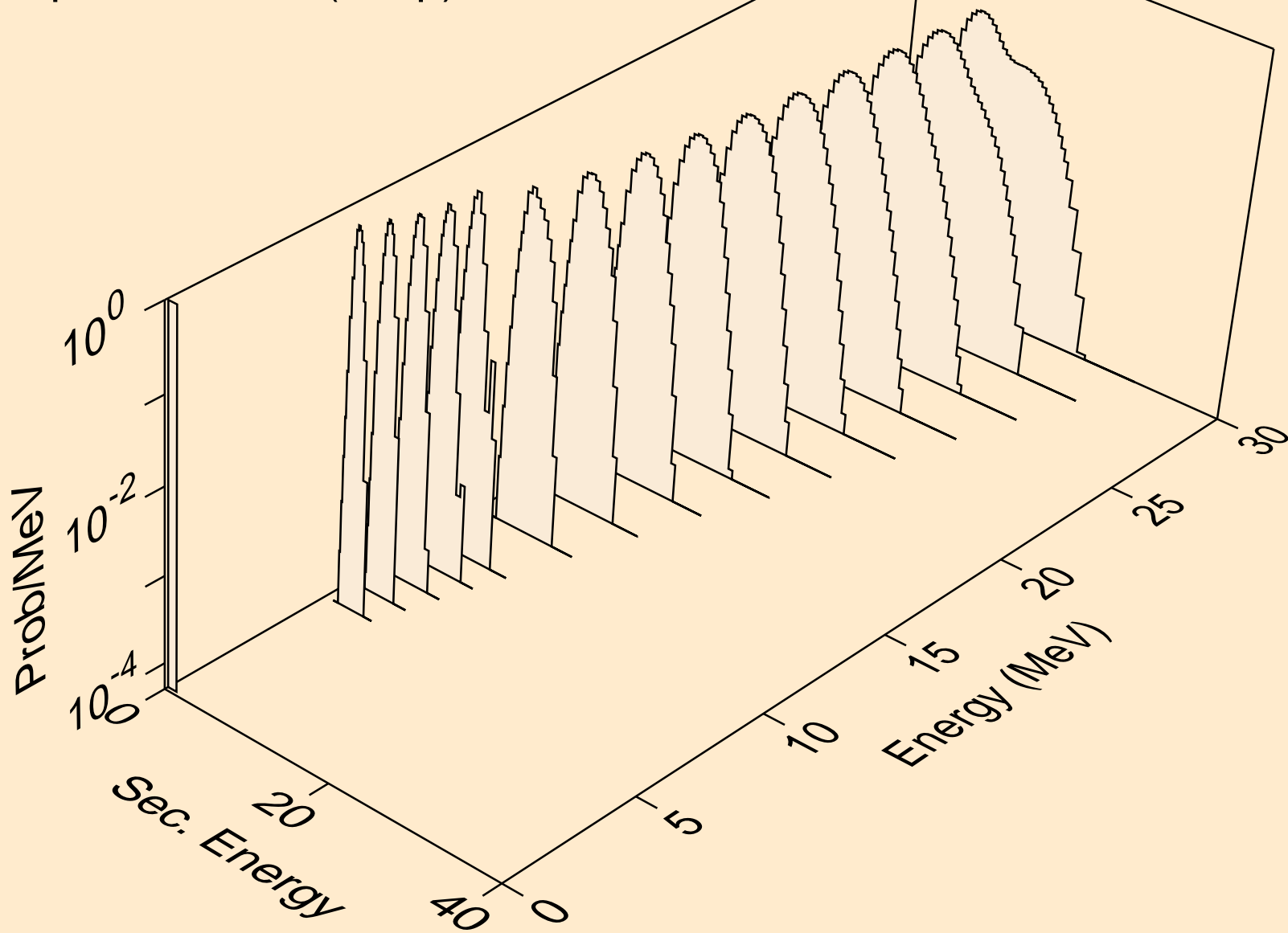

PB185M TRITON ACER TENDL-2021 LIBRARY; T=0.K  
protons from (t,npa)

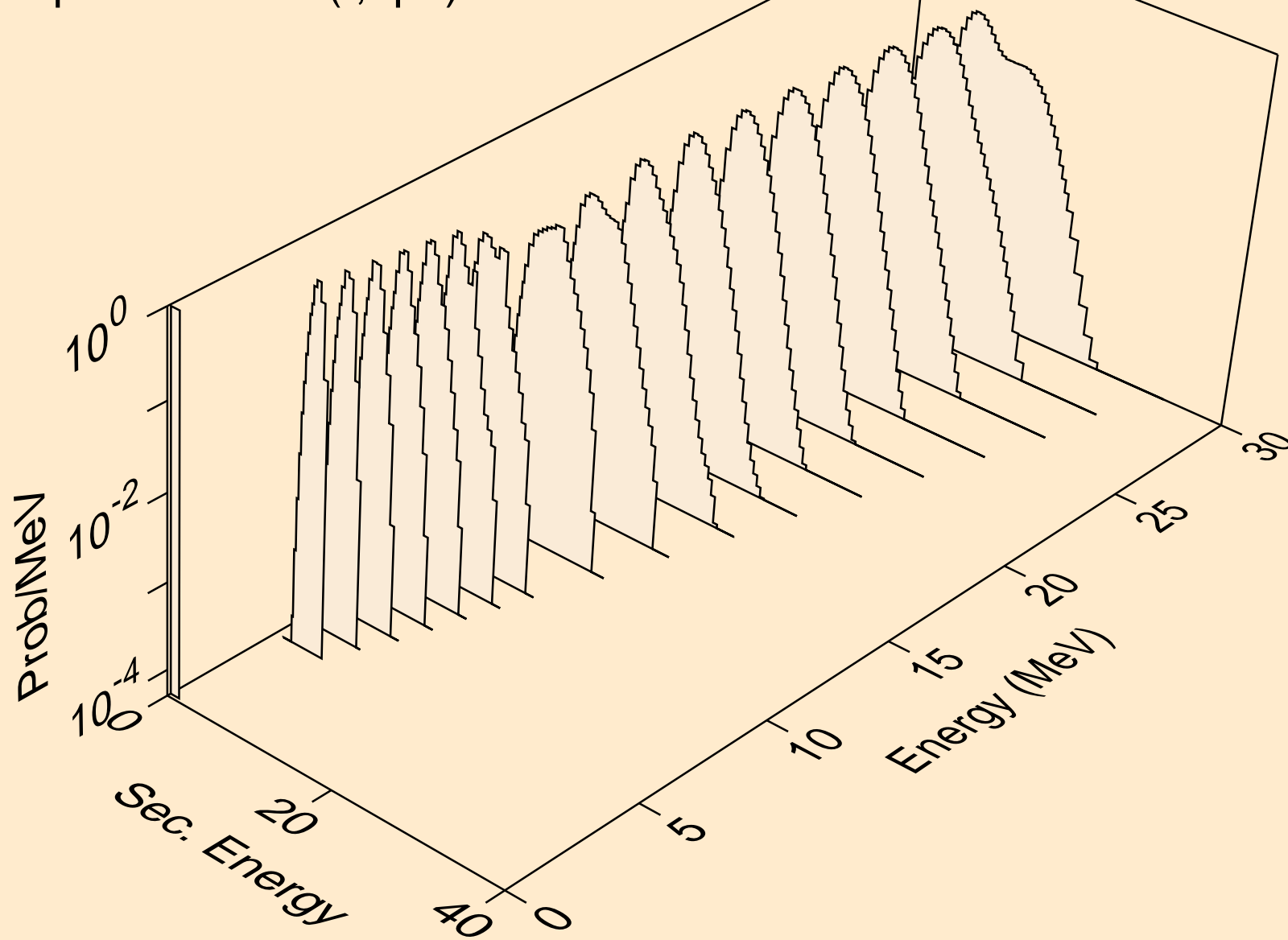

PB185M TRITON ACER TENDL-2021 LIBRARY; T=0.K  
protons from (t,p)

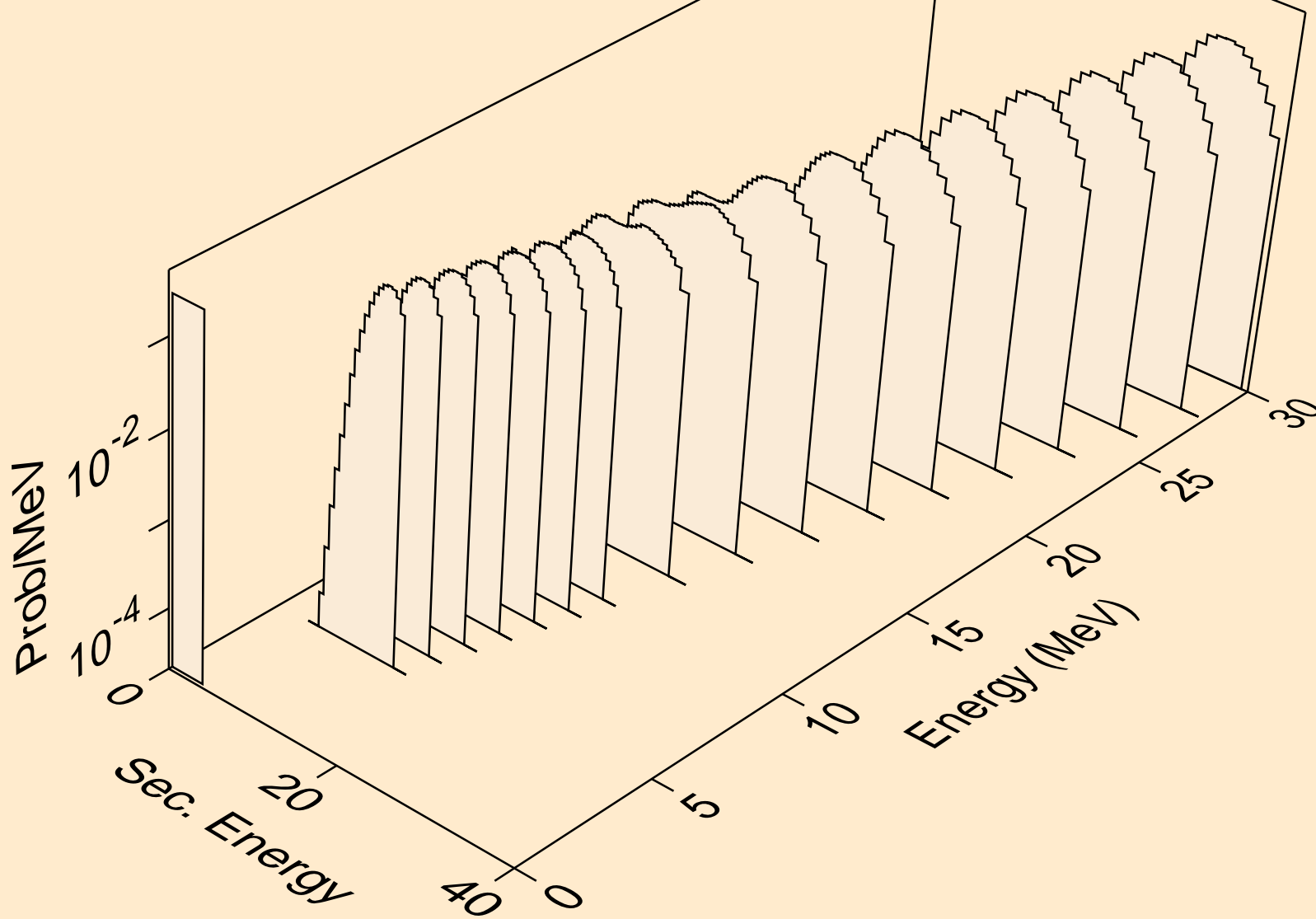

PB185M TRITON ACER TENDL-2021 LIBRARY; T=0.K  
protons from (t,2p)

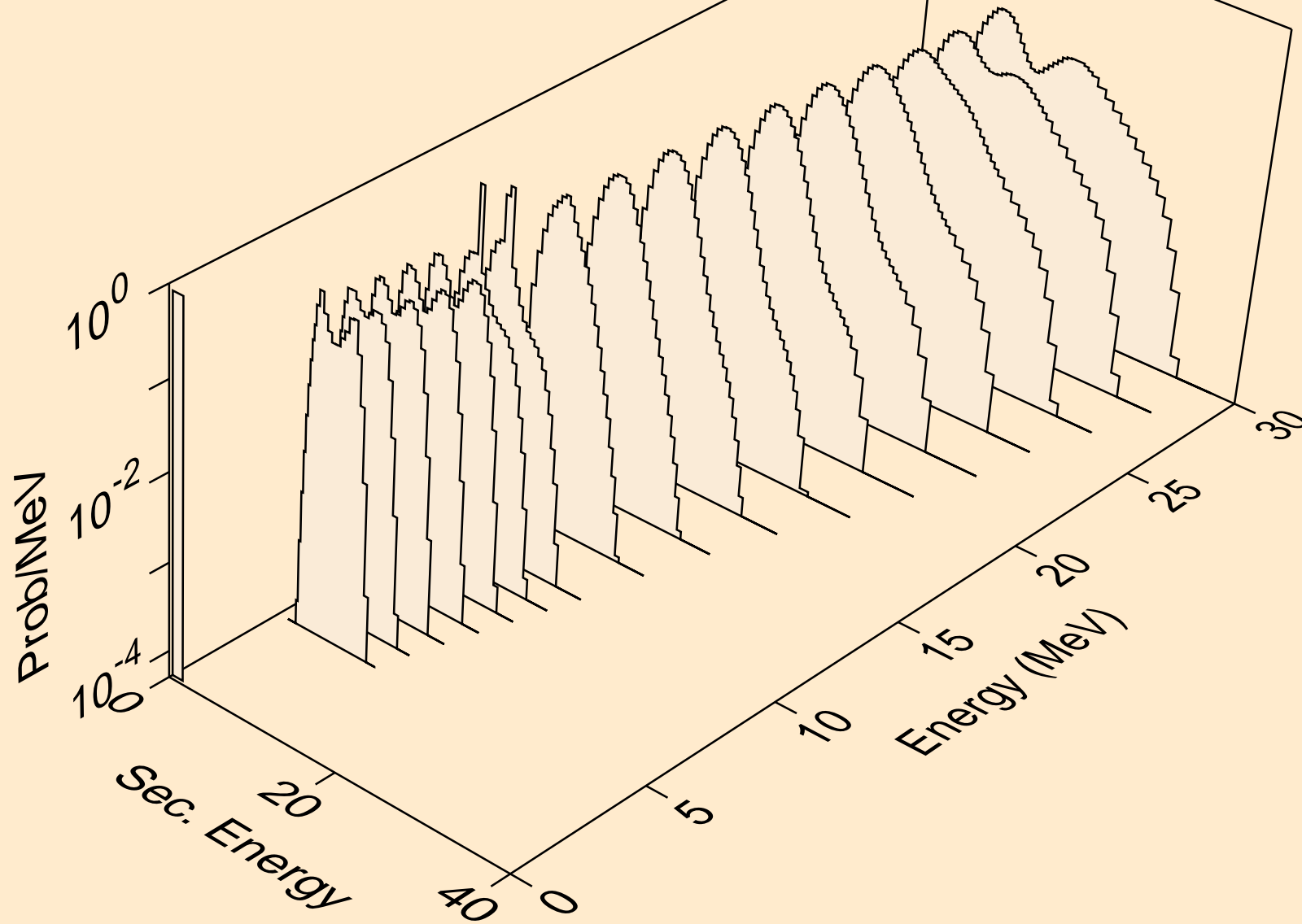

PB185M TRITON ACER TENDL-2021 LIBRARY; T=0.K  
protons from (t,pa)

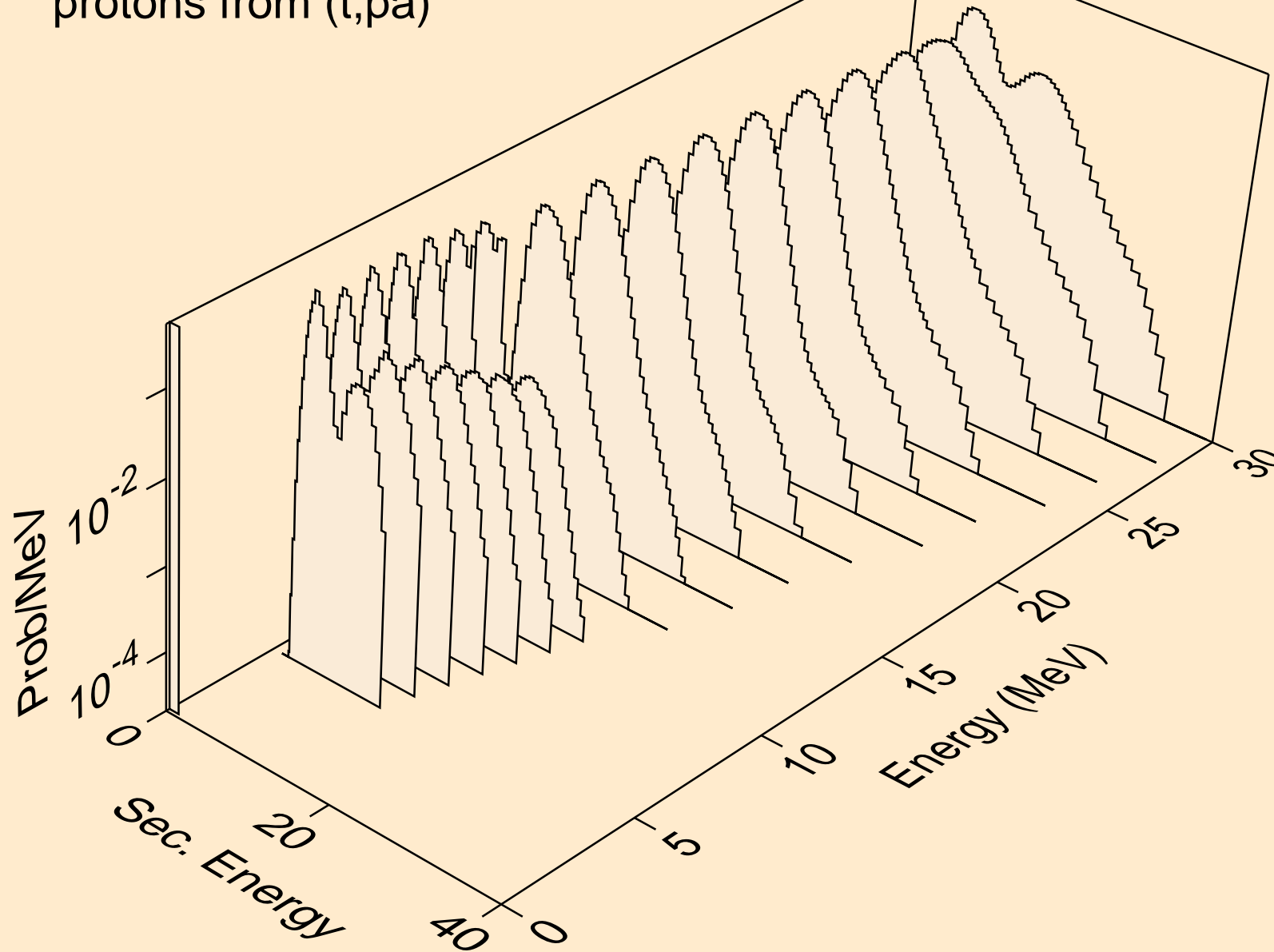

PB185M TRITON ACER TENDL-2021 LIBRARY; T=0.K  
protons from (t,pd)

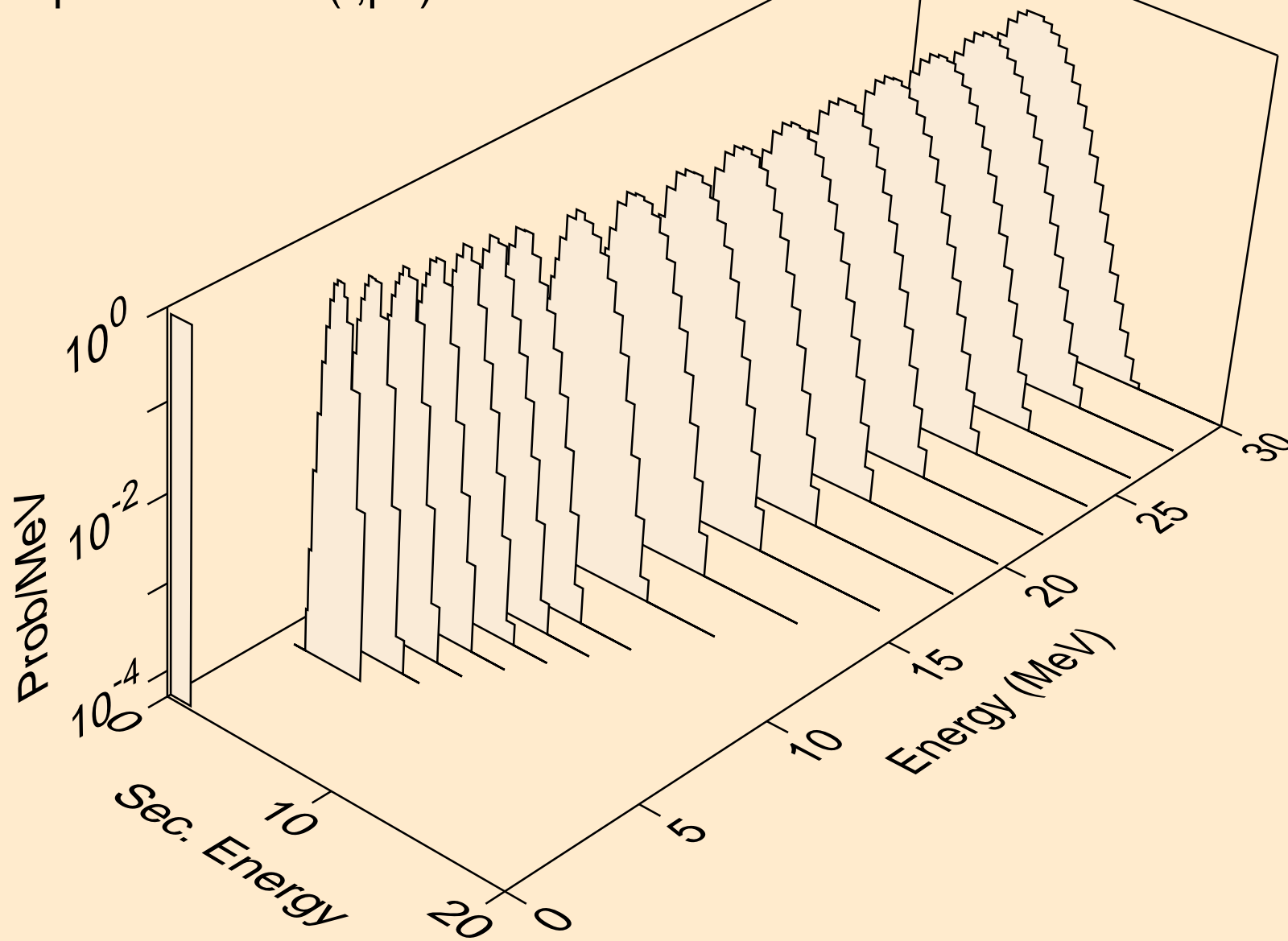

PB185M TRITON ACER TENDL-2021 LIBRARY; T=0.K  
protons from (t,pt)

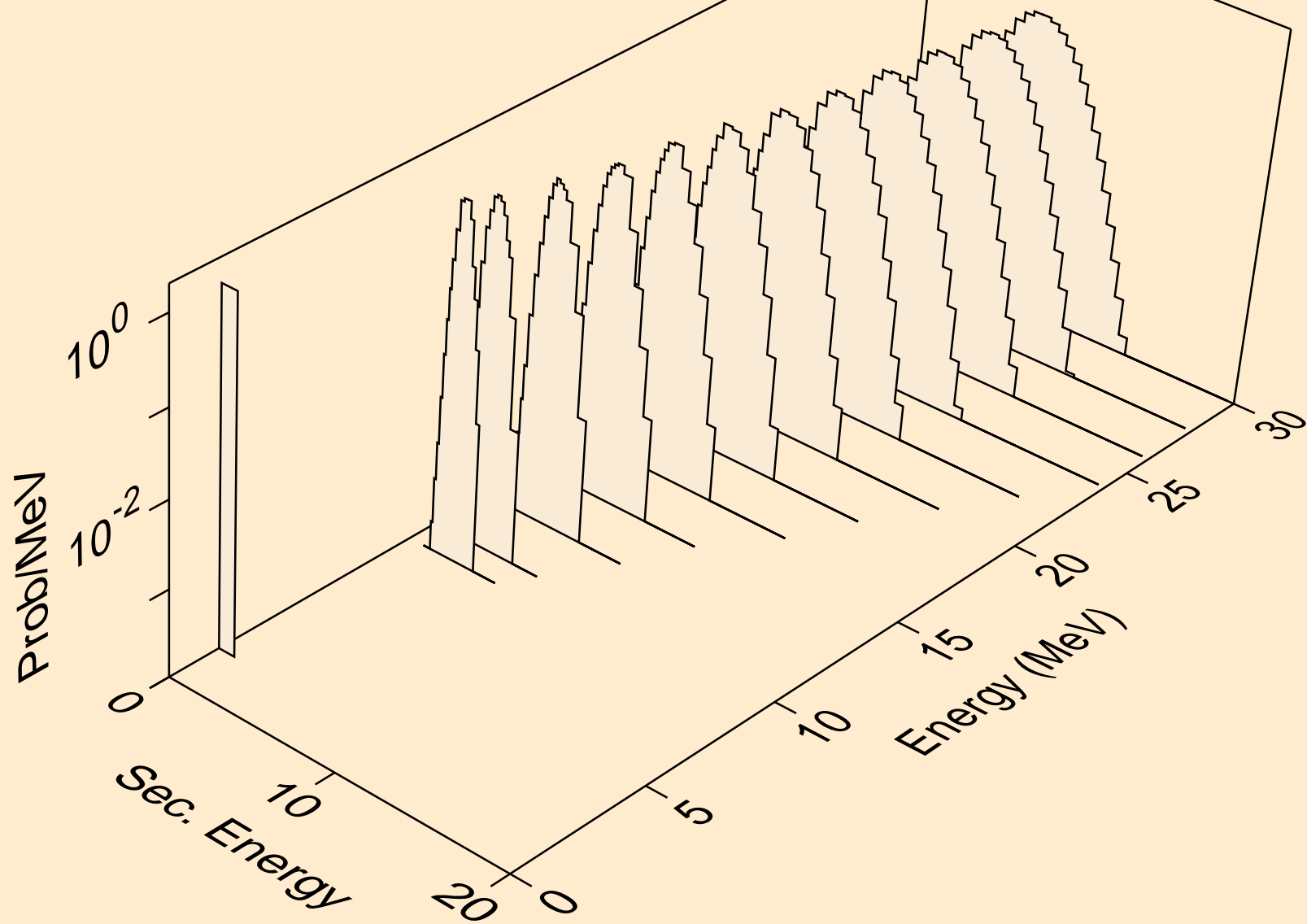



PB185M TRITON ACER TENDL-2021 LIBRARY; T=0.K  
deuterons from (t,x)

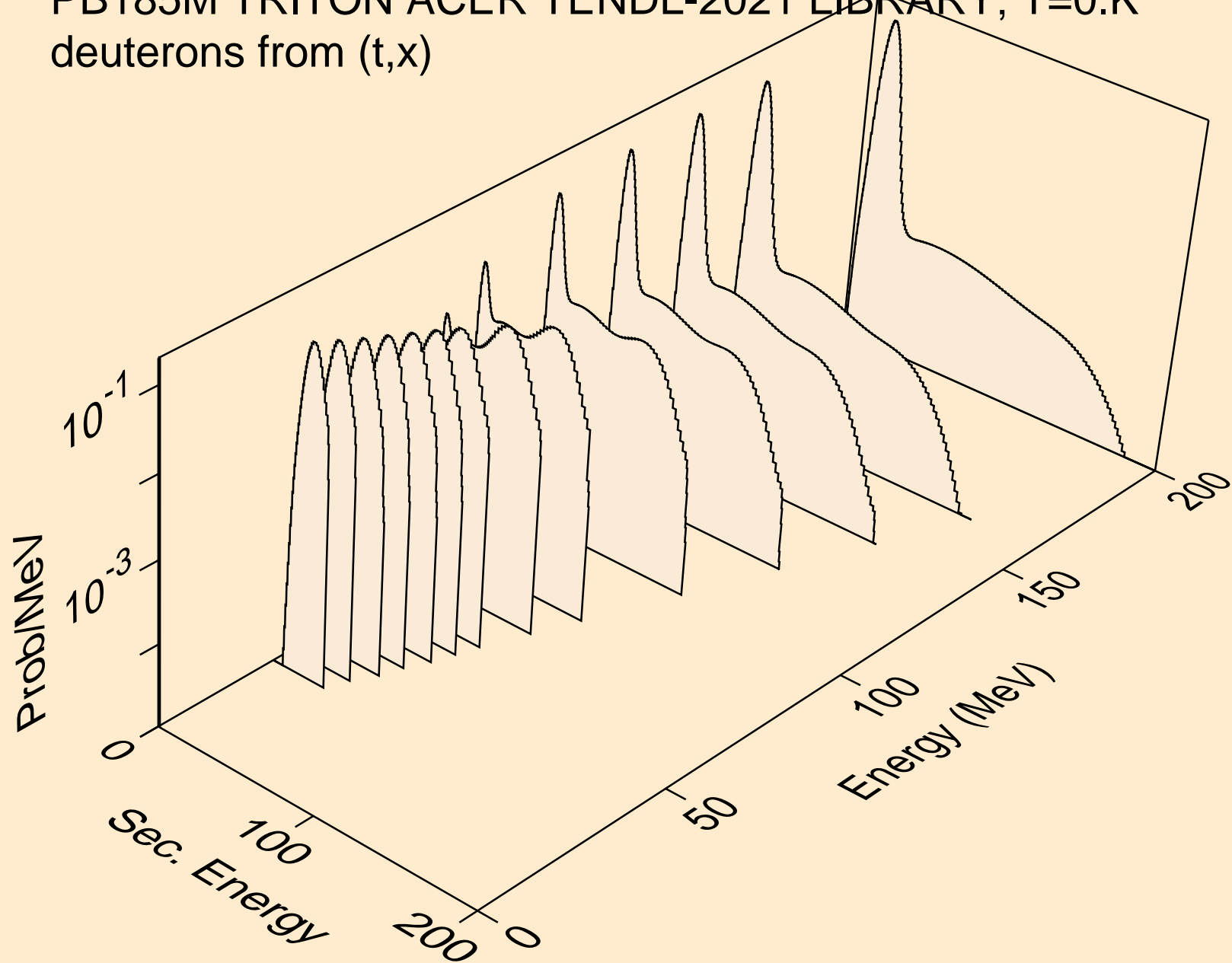

PB185M TRITON ACER TENDL-2021 LIBRARY; T=0.K  
deuterons from (t,2nd)

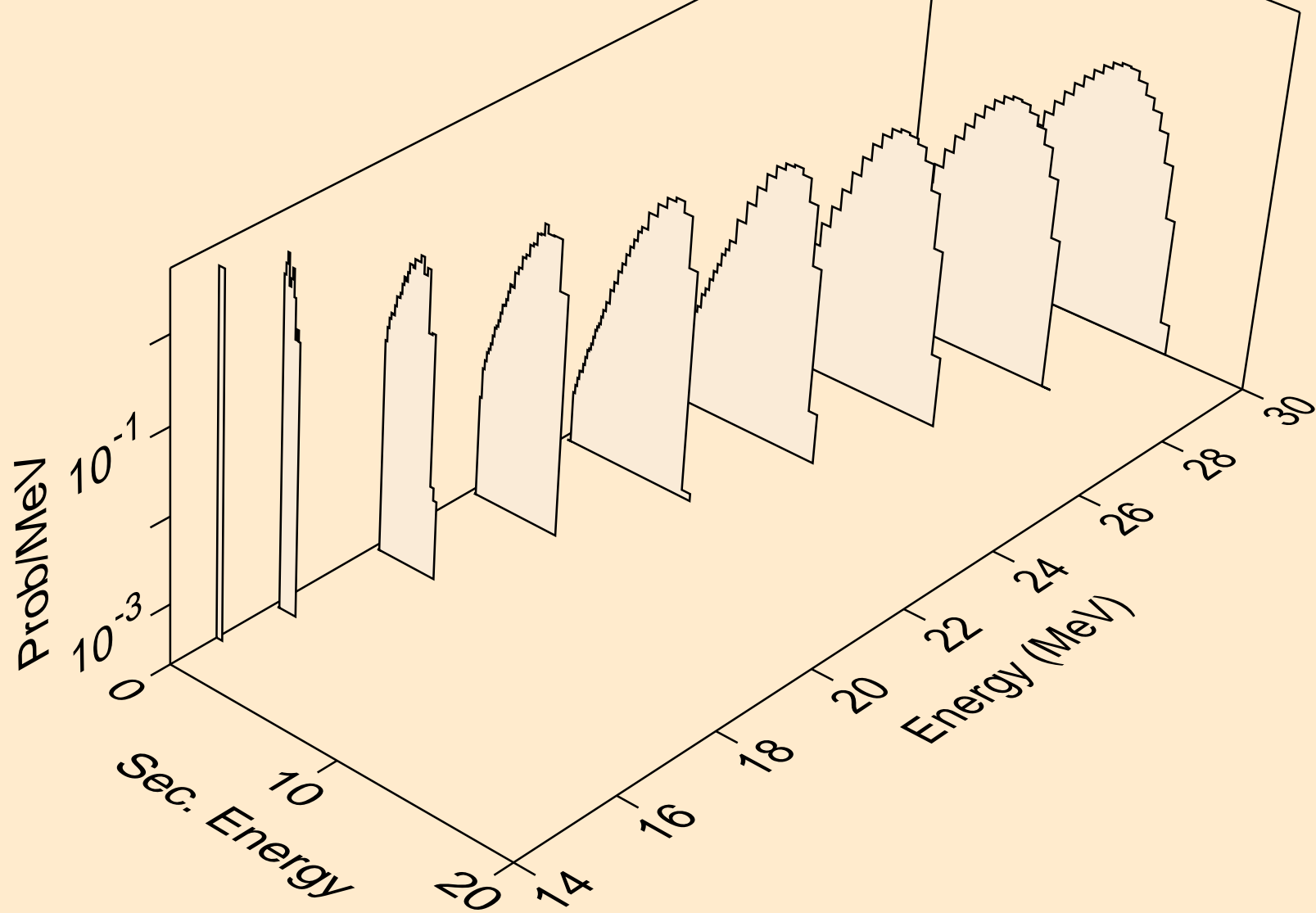

PB185M TRITON ACER TENDL-2021 LIBRARY; T=0.K  
deuterons from (t,n\*)d

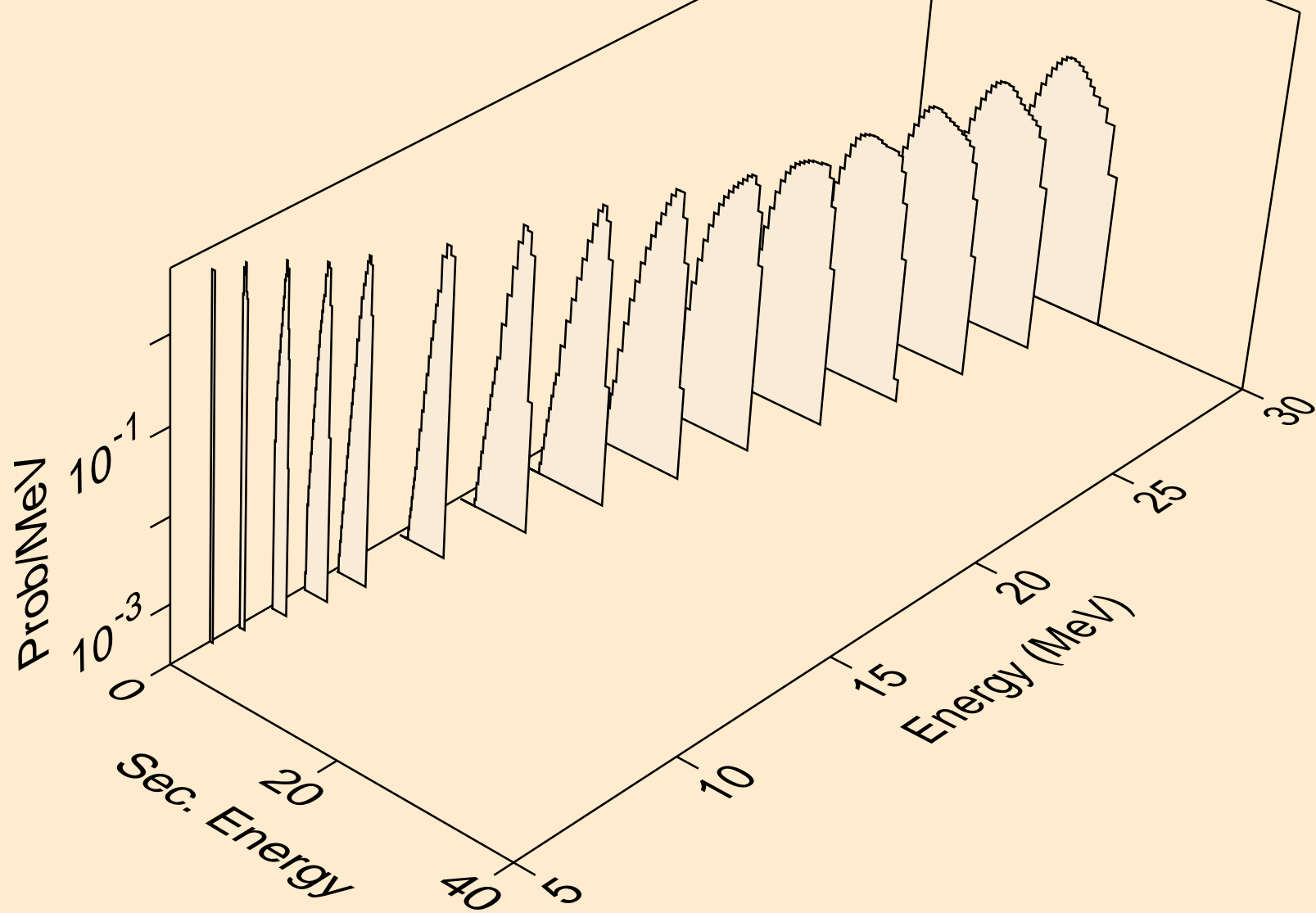

PB185M TRITON ACER TENDL-2021 LIBRARY; T=0.K  
deuterons from (t,d)

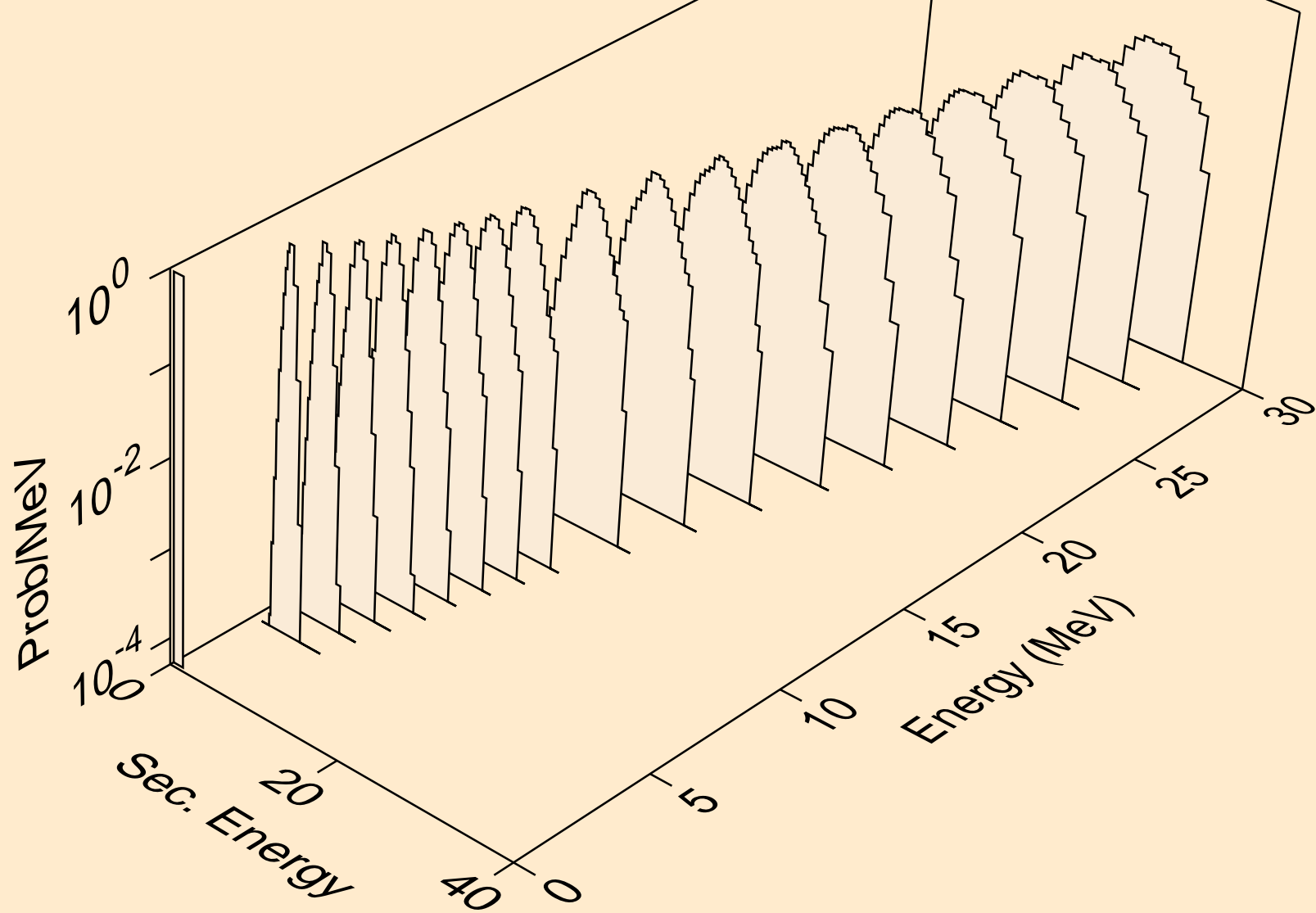

PB185M TRITON ACER TENDL-2021 LIBRARY; T=0.K  
deuterons from (t,d2a)

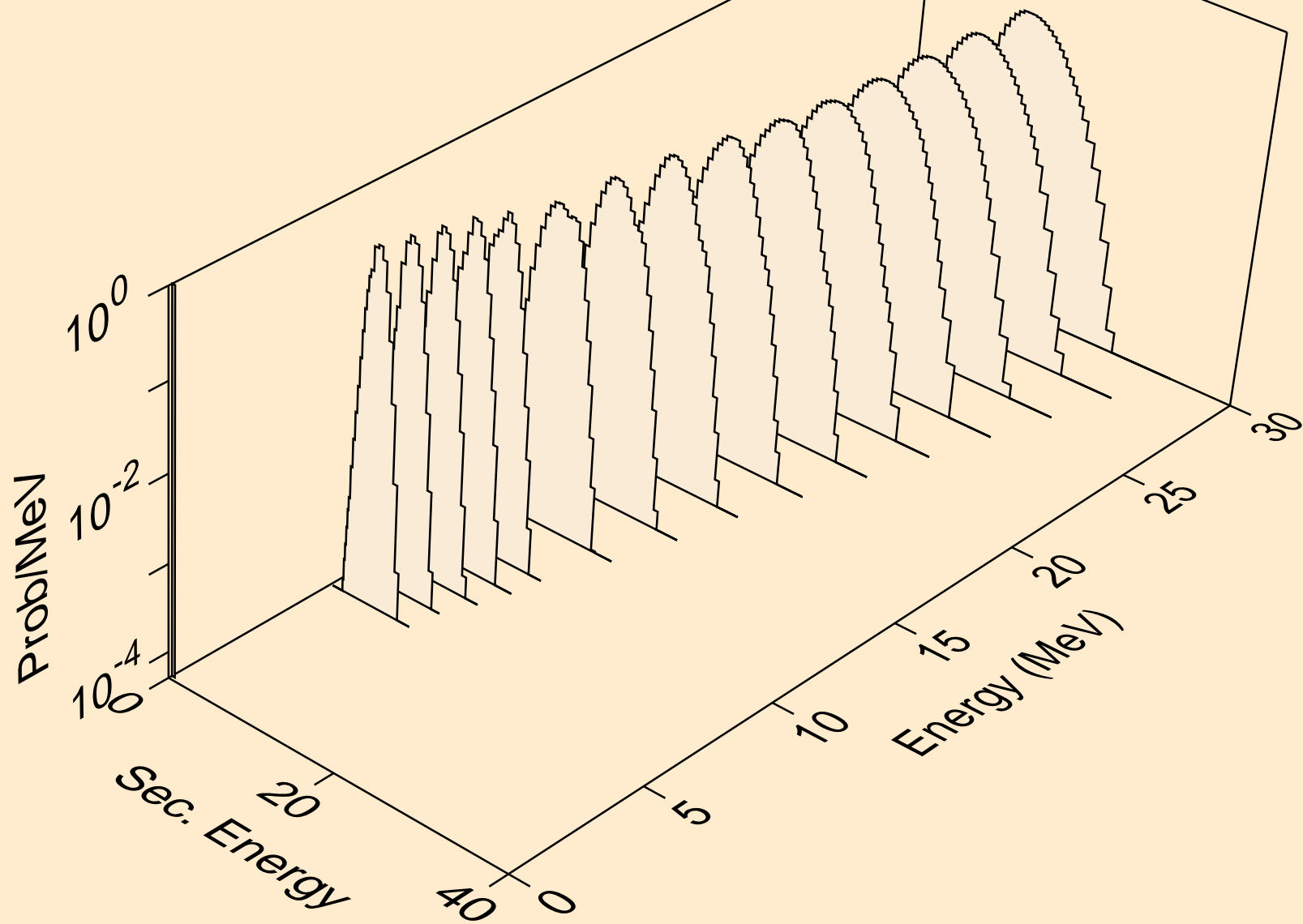

PB185M TRITON ACER TENDL-2021 LIBRARY; T=0.K  
deuterons from (t,pd)

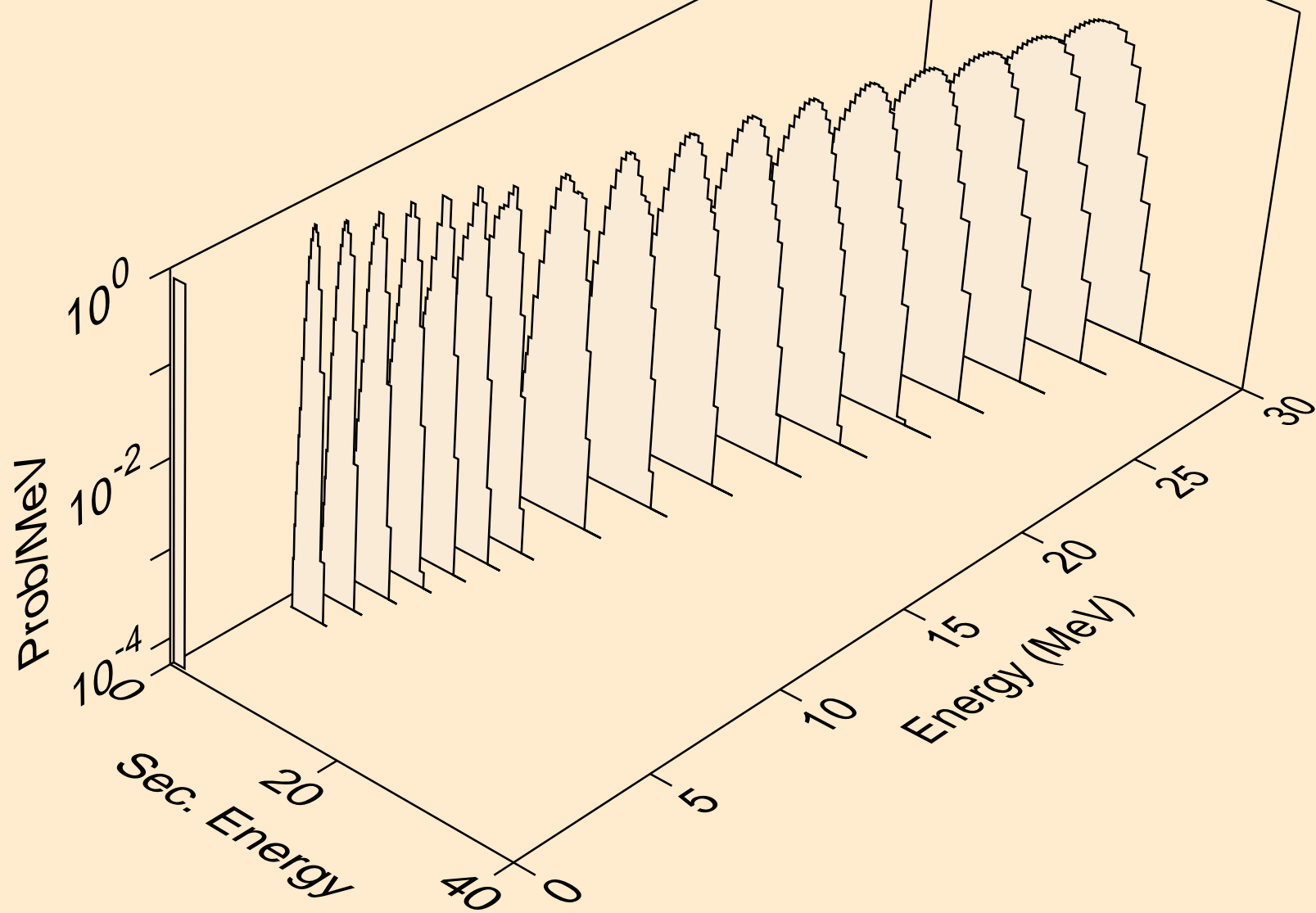

PB185M TRITON ACER TENDL-2021 LIBRARY; T=0.K  
deuterons from (t,da)

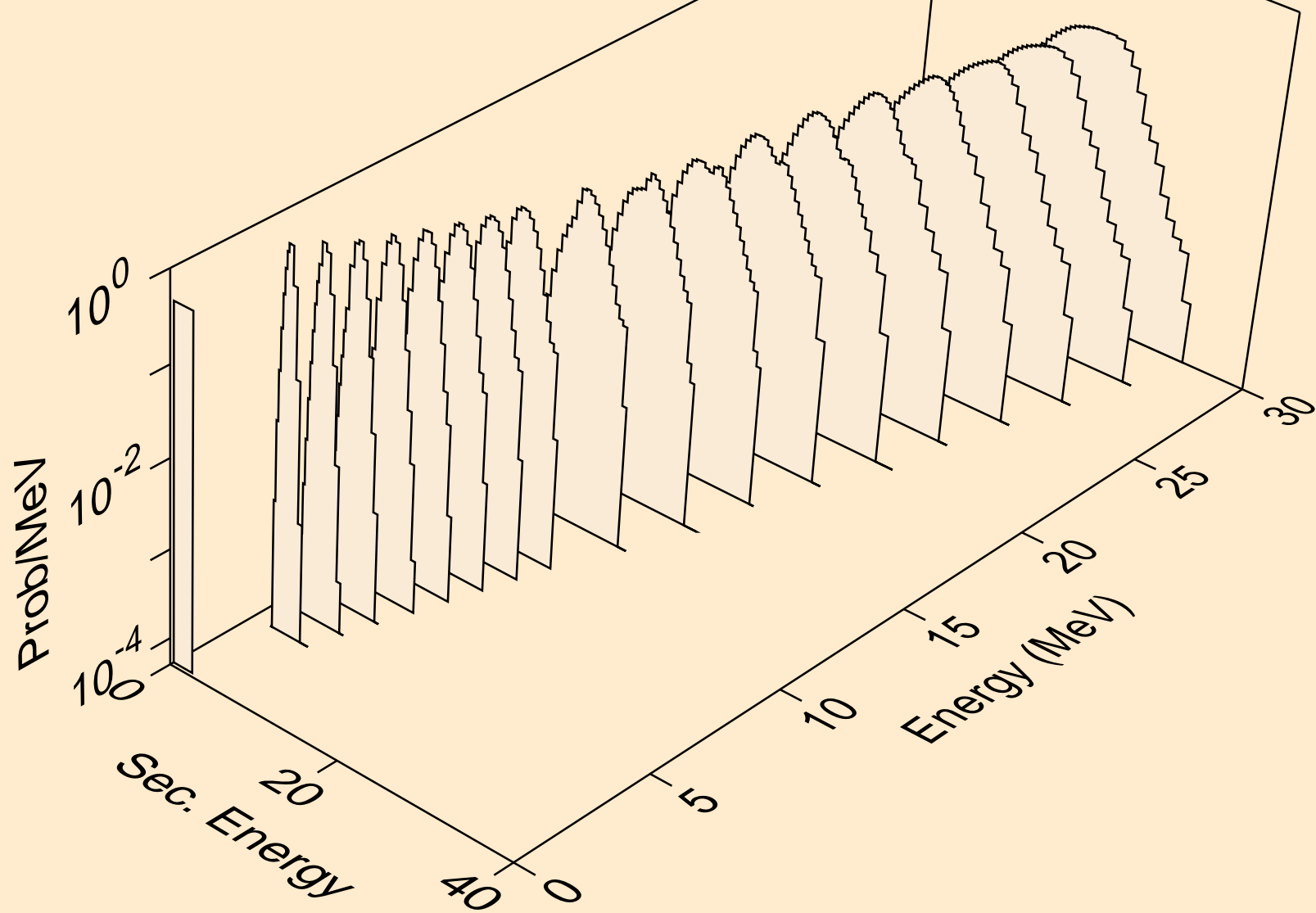

PB185M TRITON ACER TENDL-2021 LIBRARY; T=0.K  
he3s from (t,x)

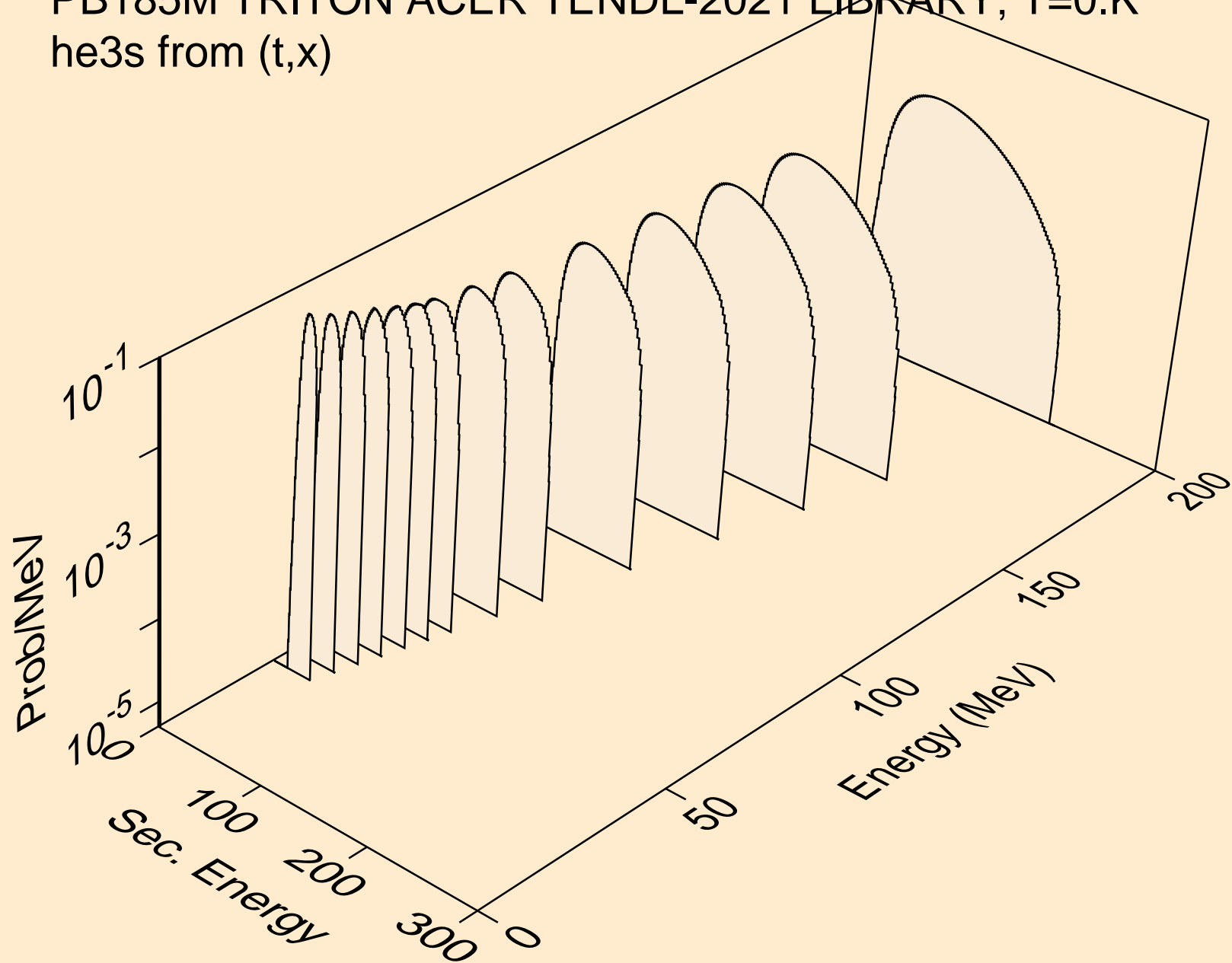



PB185M TRITON ACER TENDL-2021 LIBRARY; T=0.K  
he3s from (t,n\*)he3

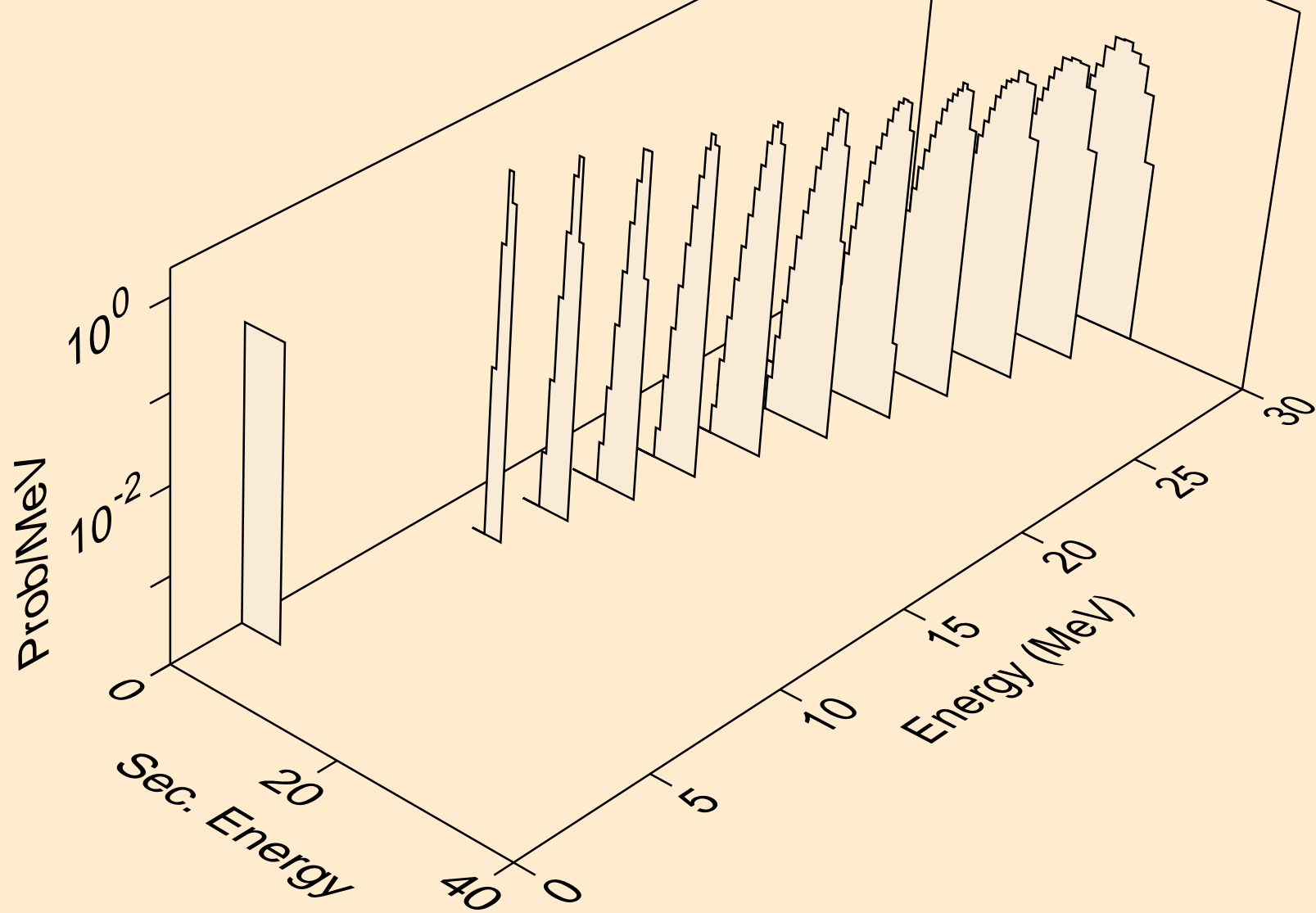

PB185M TRITON ACER TENDL-2021 LIBRARY; T=0.K  
he3s from (t,he3)

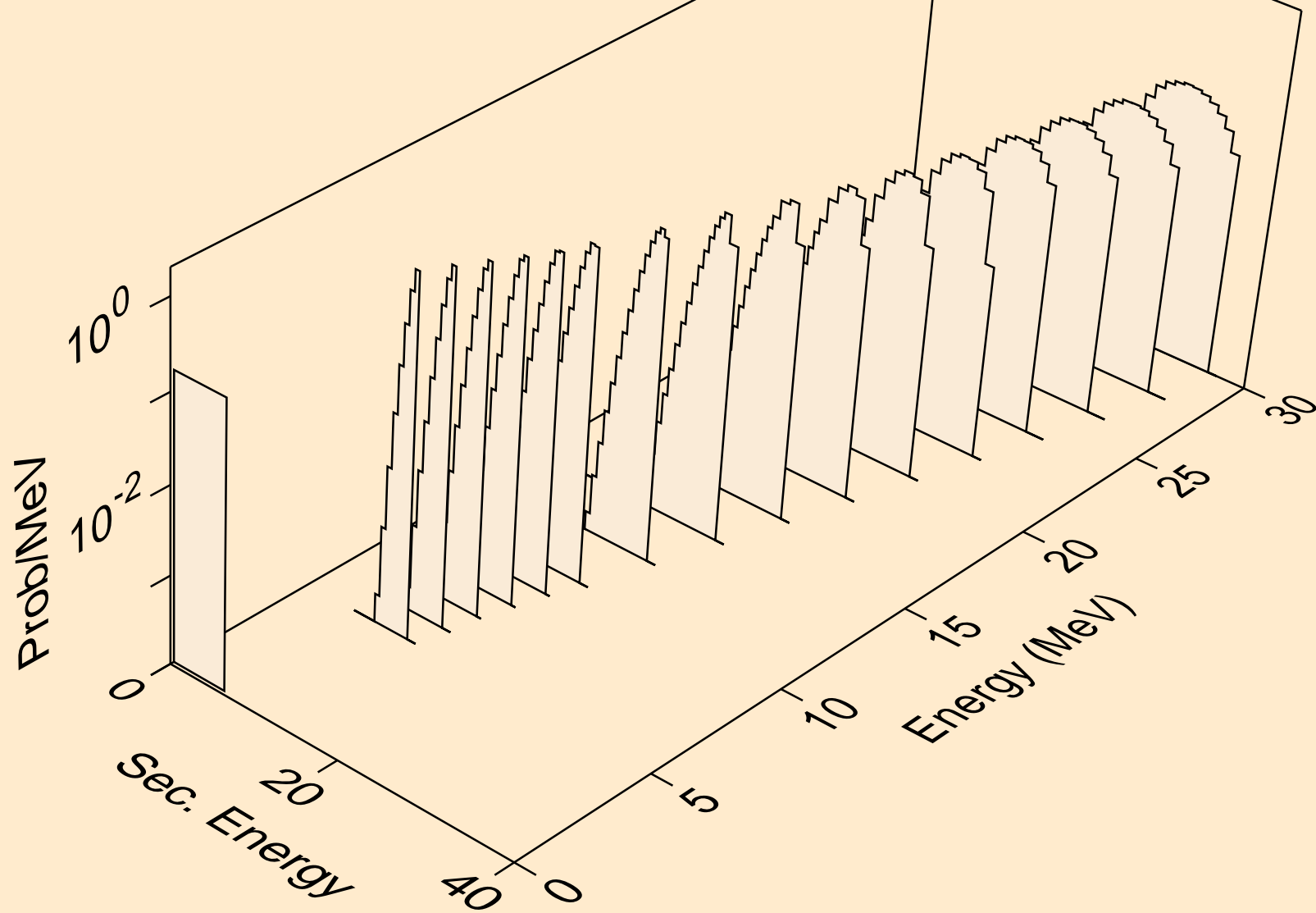

PB185M TRITON ACER TENDL-2021 LIBRARY; T=0.K  
alphas from (t,x)

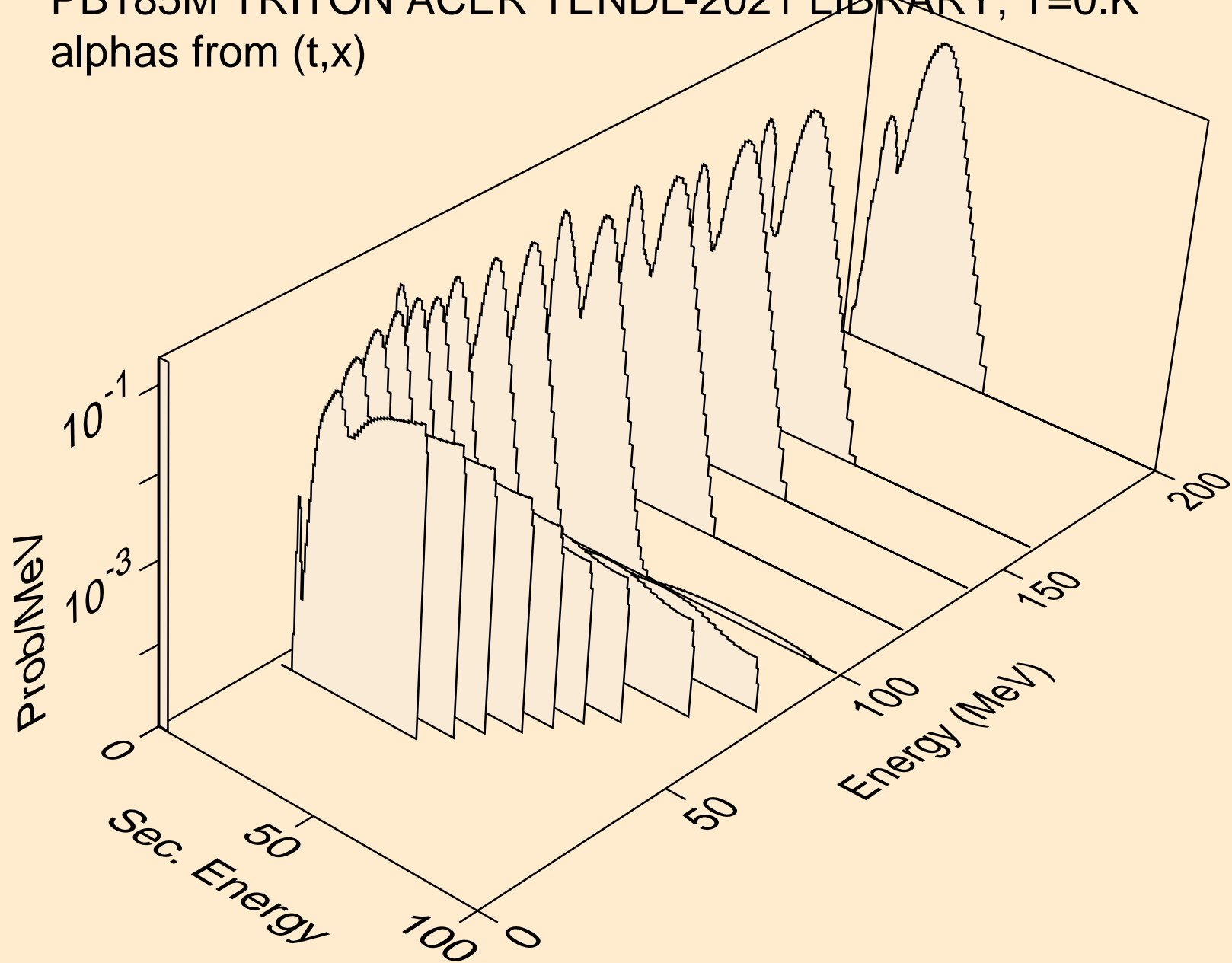

PB185M TRITON ACER TENDL-2021 LIBRARY; T=0.K  
alphas from (t,n\*)a

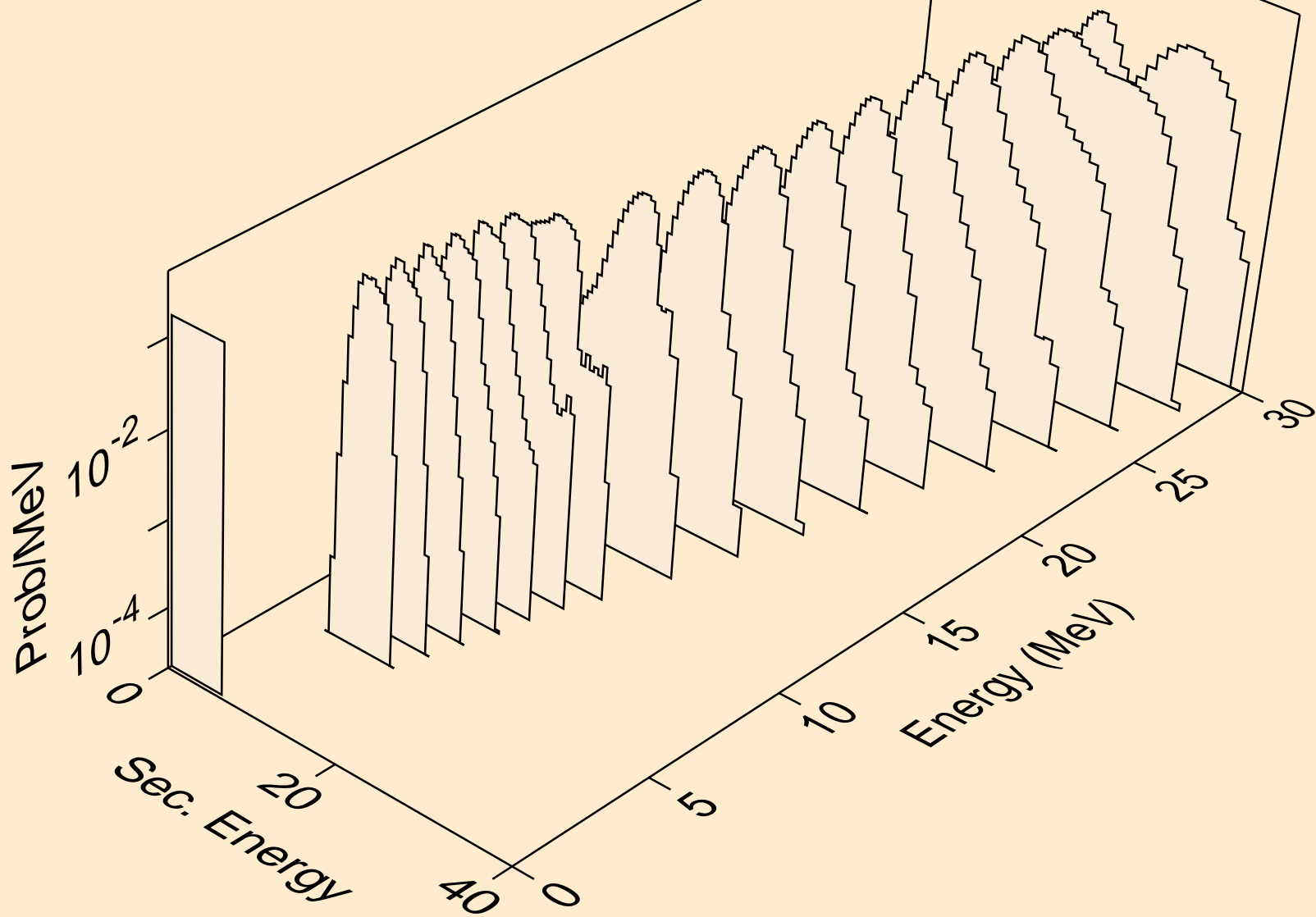

PB185M TRITON ACER TENDL-2021 LIBRARY; T=0.K  
alphas from (t,n\*)3a

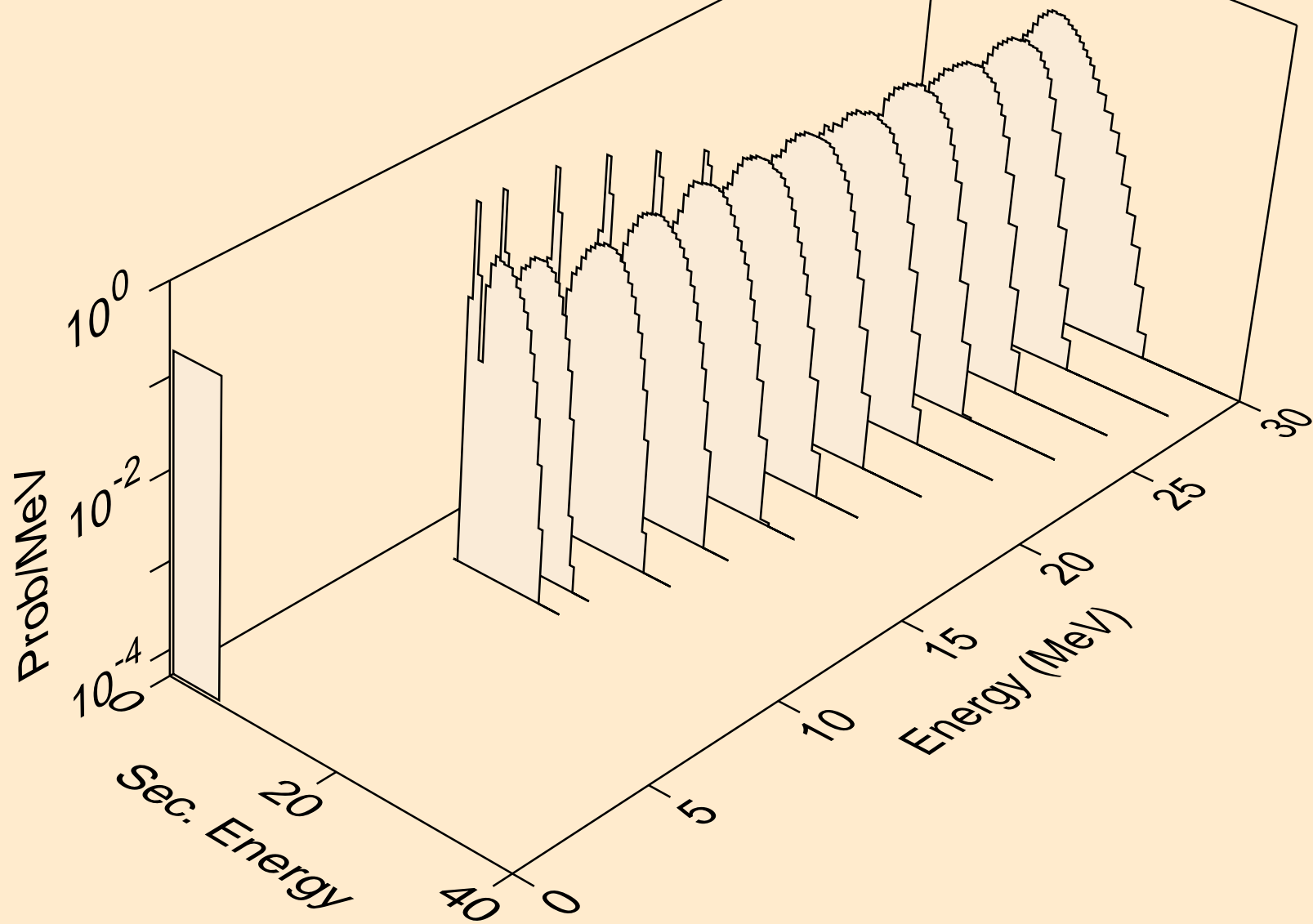

PB185M TRITON ACER TENDL-2021 LIBRARY; T=0.K  
alphas from (t,2n)a

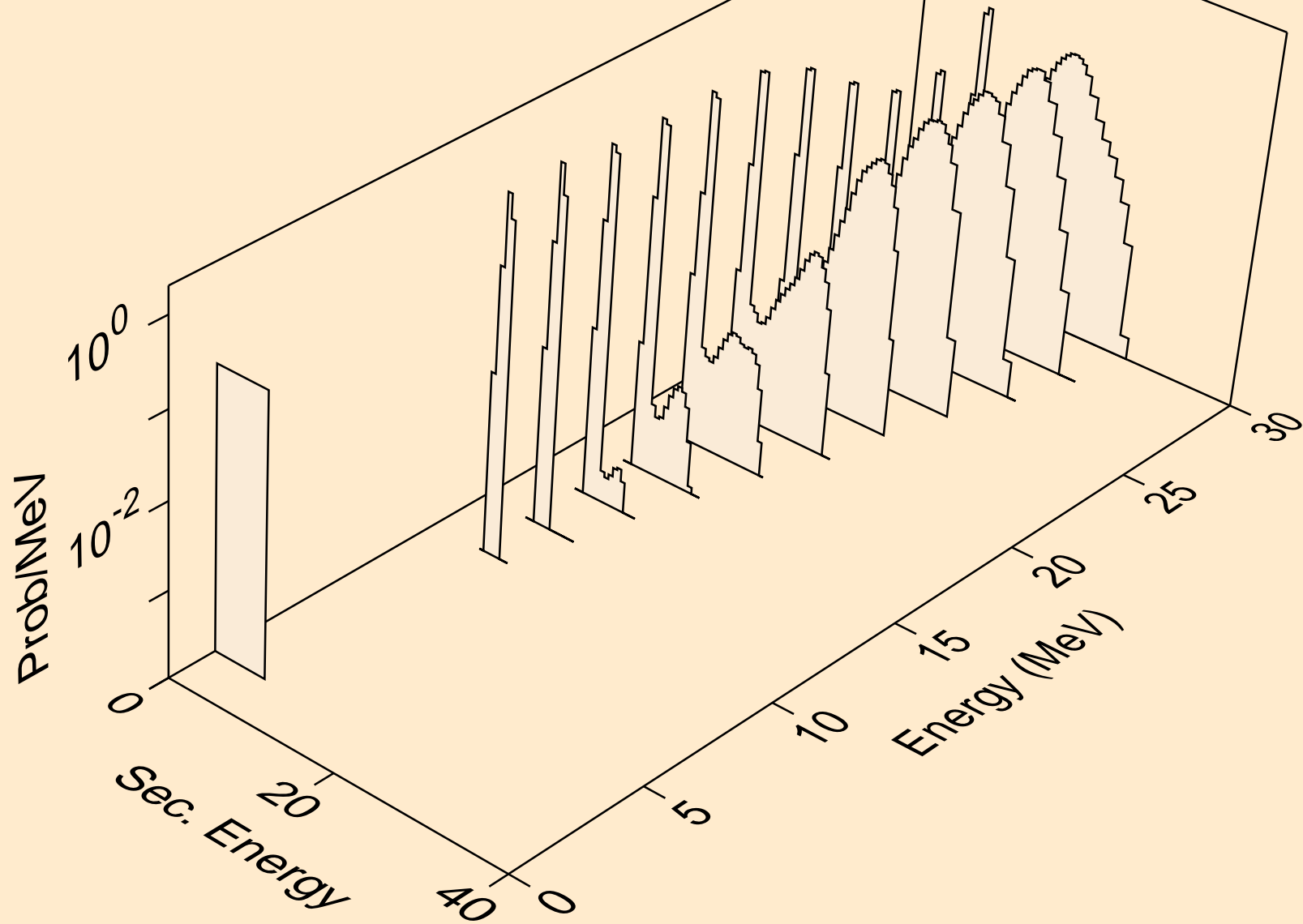

PB185M TRITON ACER TENDL-2021 LIBRARY; T=0.K  
alphas from (t,3n)a

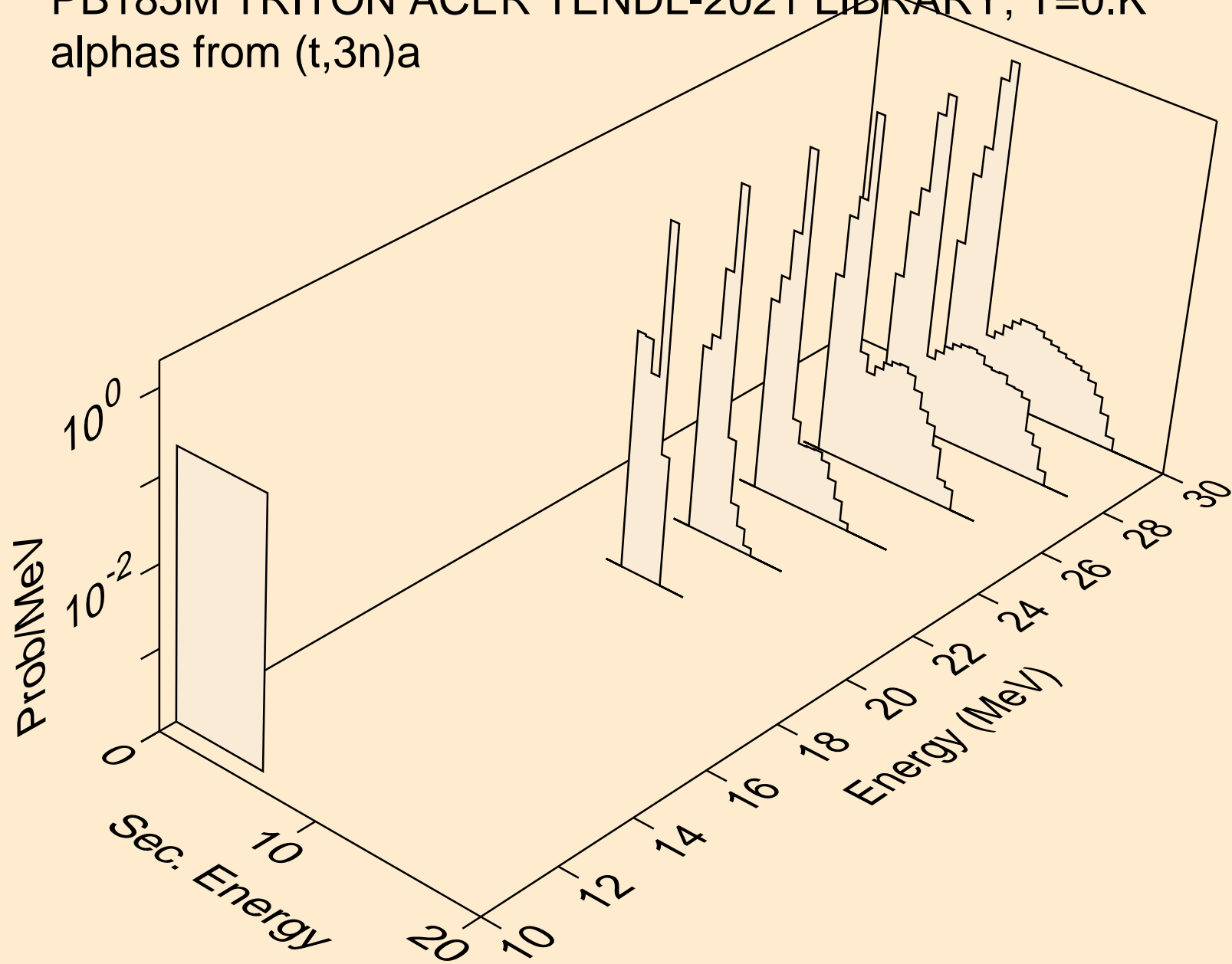

PB185M TRITON ACER TENDL-2021 LIBRARY; T=0.K  
alphas from (t,n\*)2a

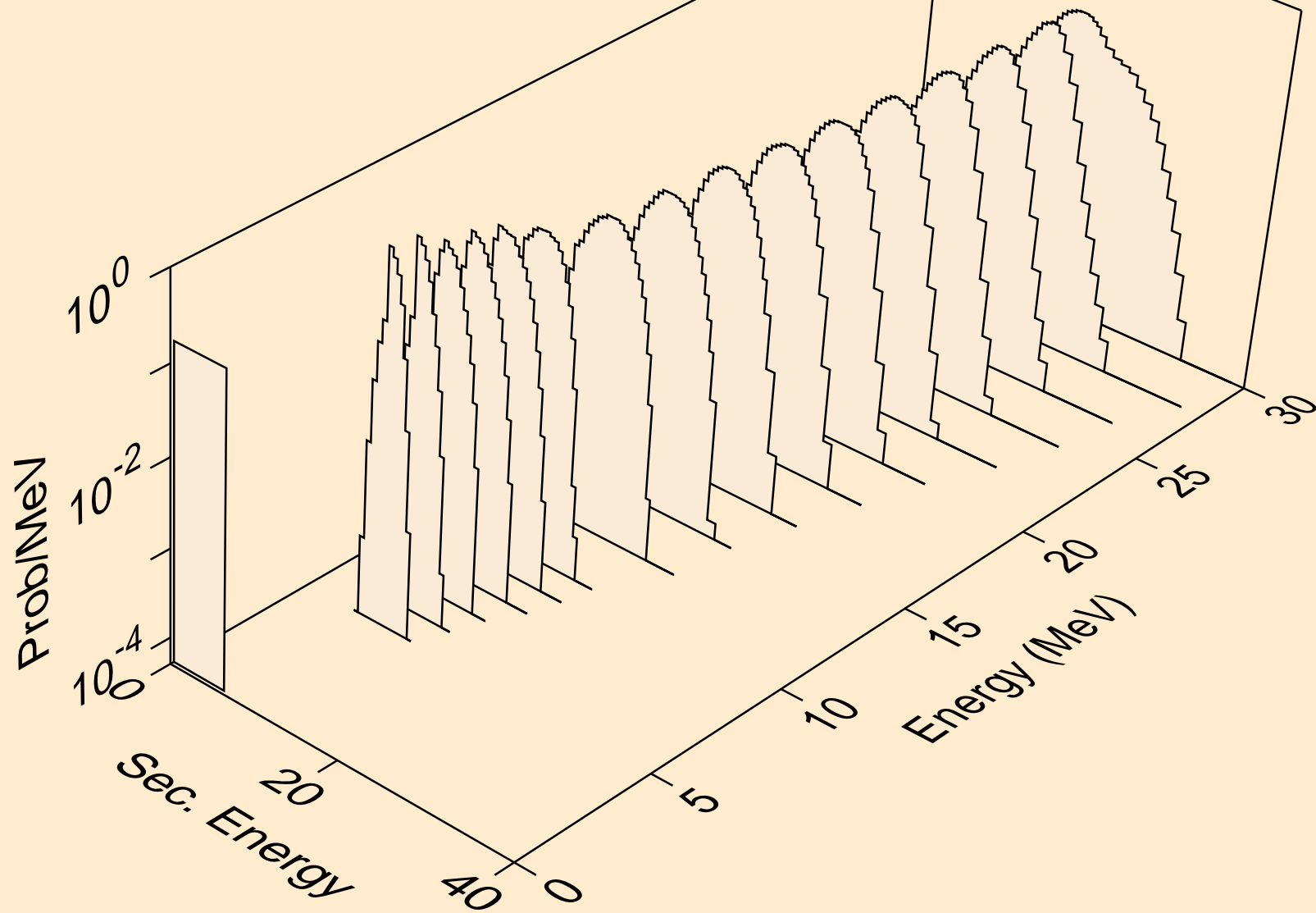



PB185M TRITON ACER TENDL-2021 LIBRARY; T=0.K  
alphas from (t,2n)2a

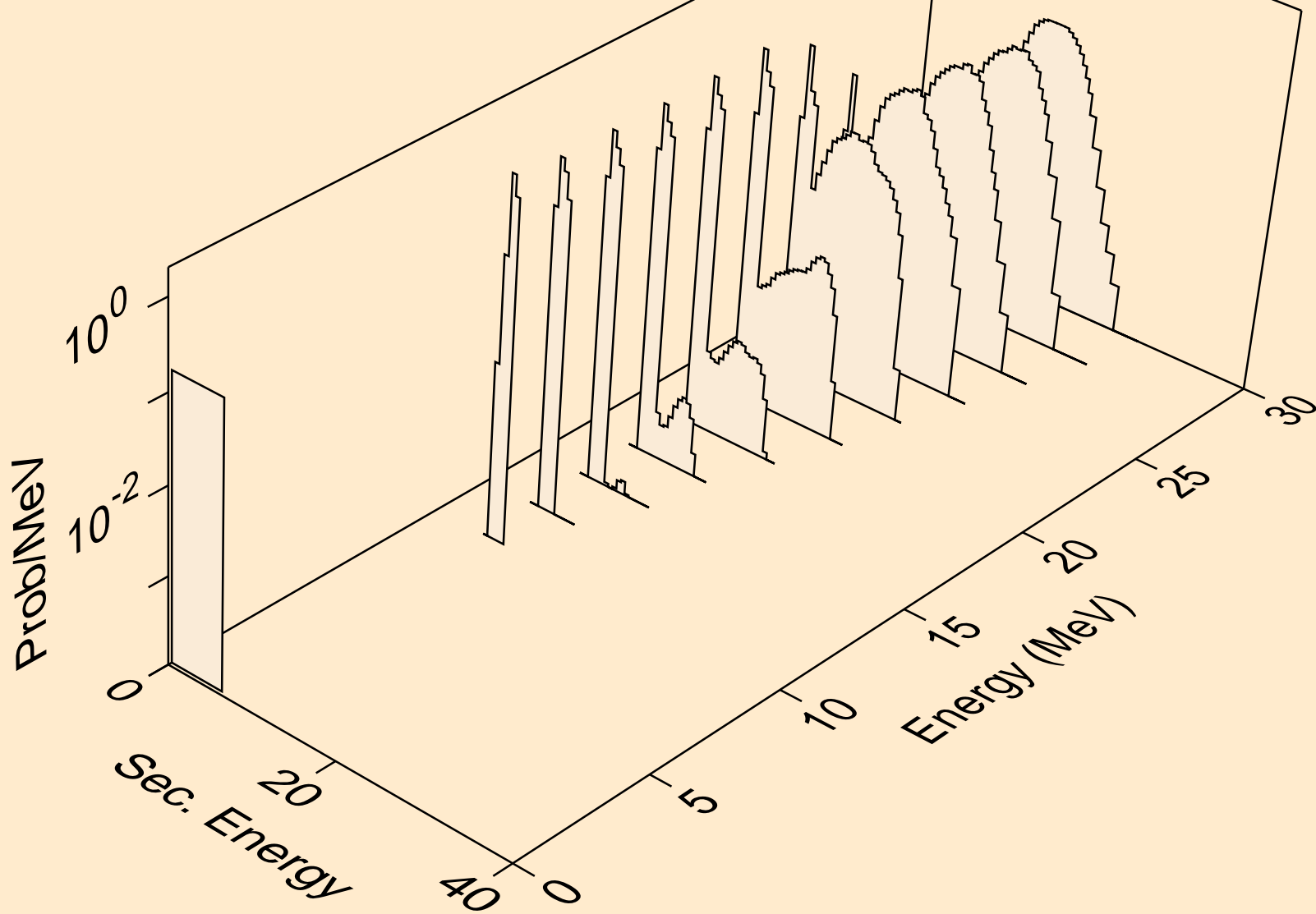

PB185M TRITON ACER TENDL-2021 LIBRARY; T=0.K  
alphas from (t,npa)

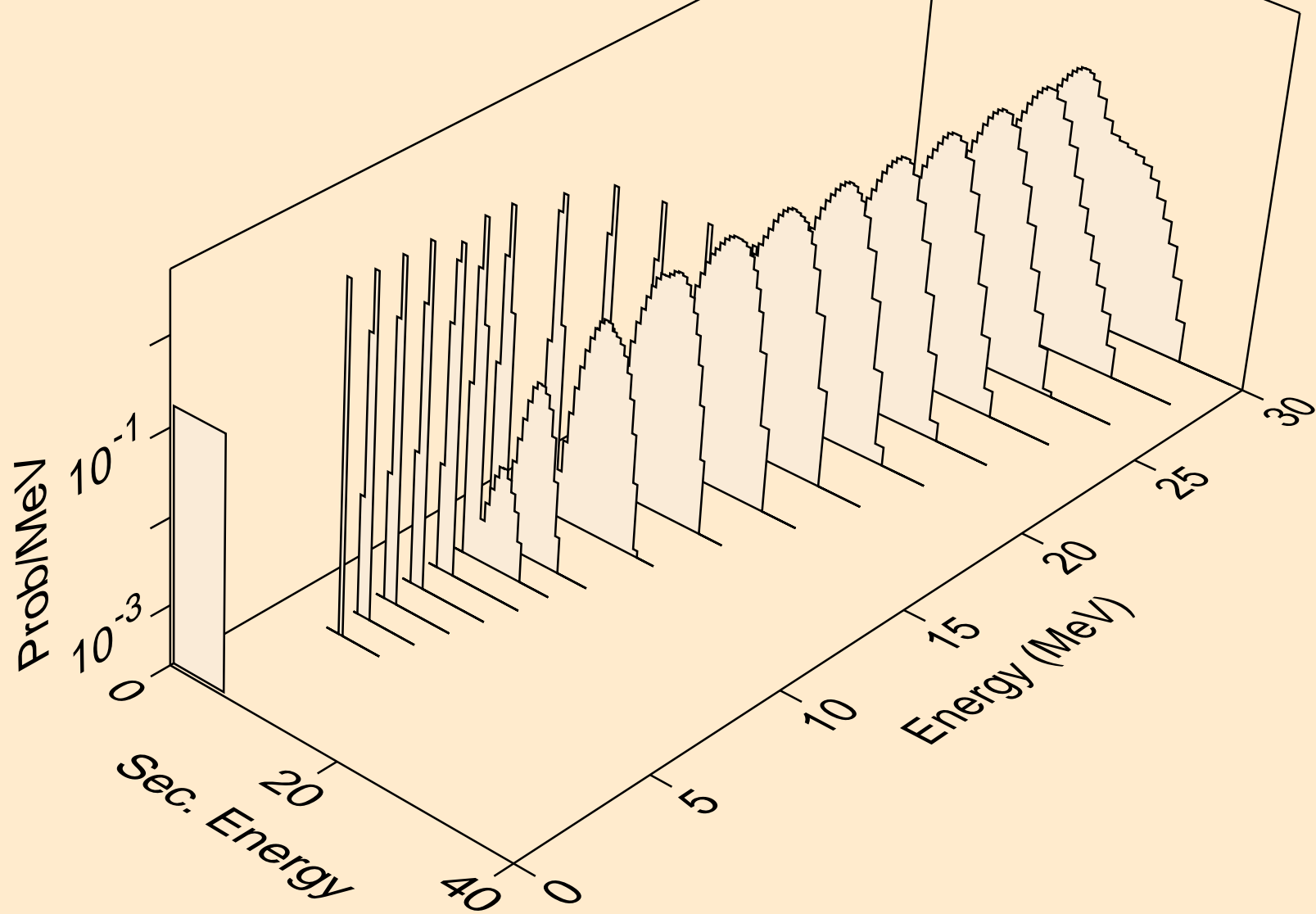

PB185M TRITON ACER TENDL-2021 LIBRARY; T=0.K  
alphas from (t,a)

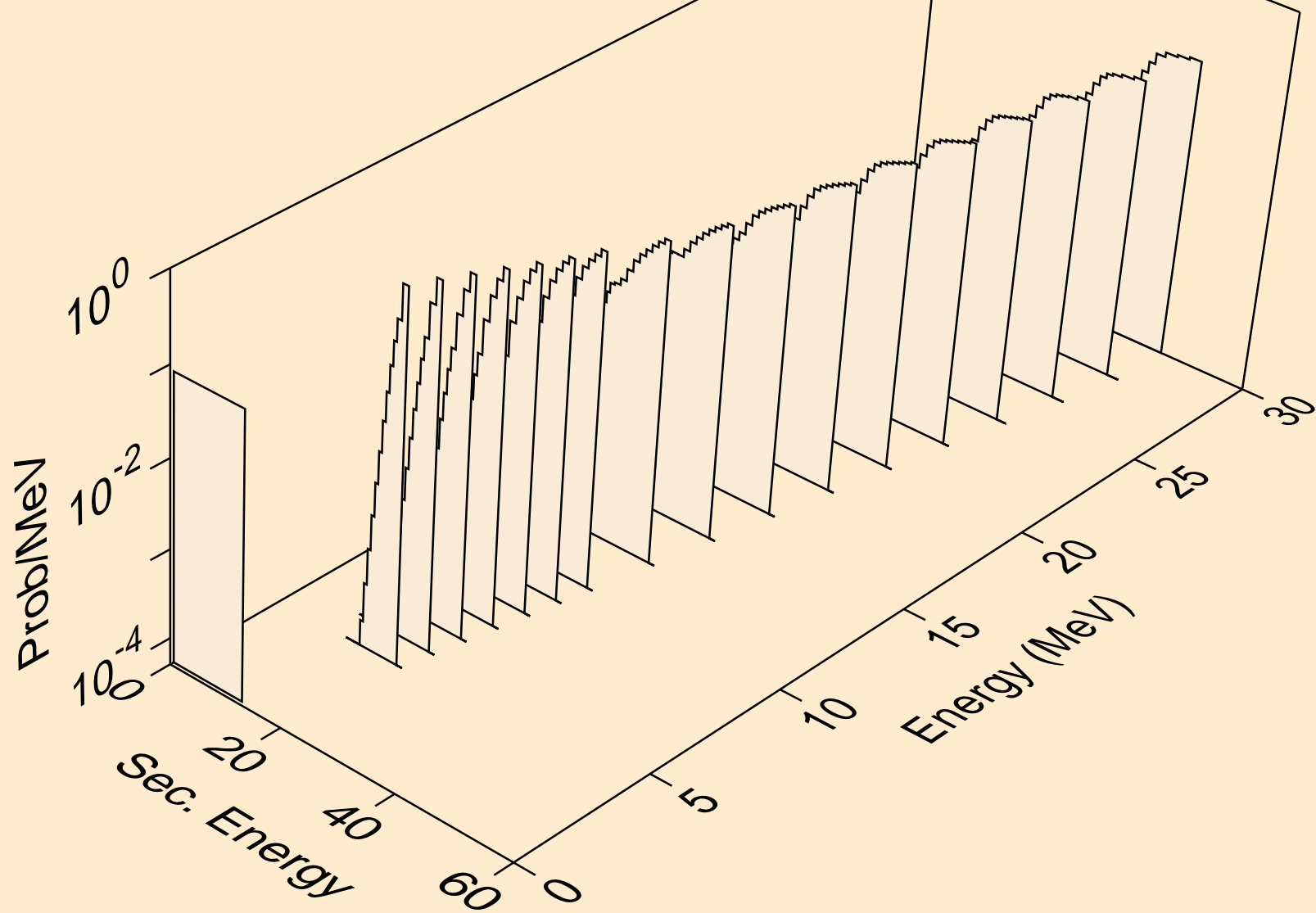

PB185M TRITON ACER TENDL-2021 LIBRARY; T=0.K  
alphas from (t,2a)

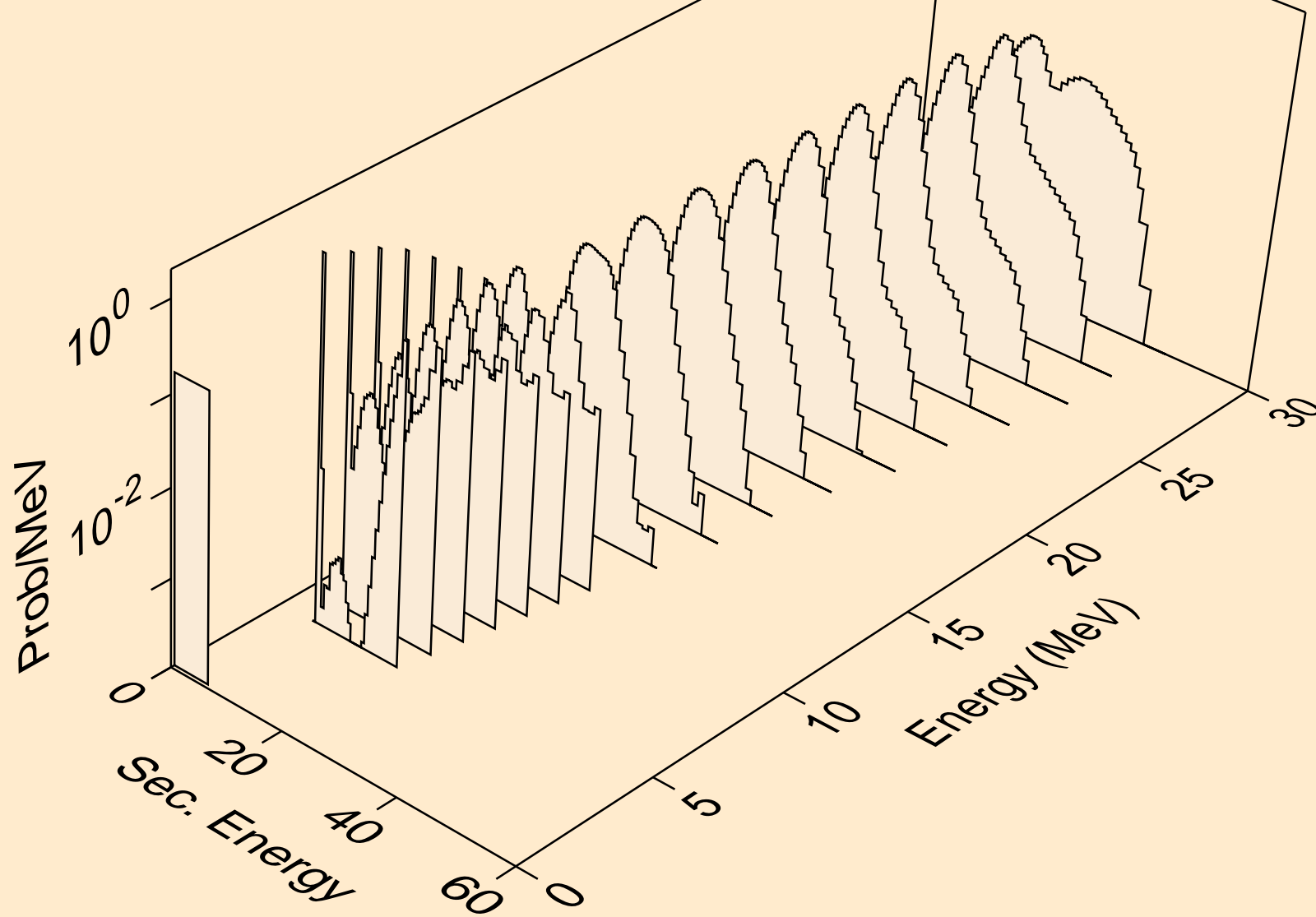

PB185M TRITON ACER TENDL-2021 LIBRARY; T=0.K  
alphas from (t,3a)

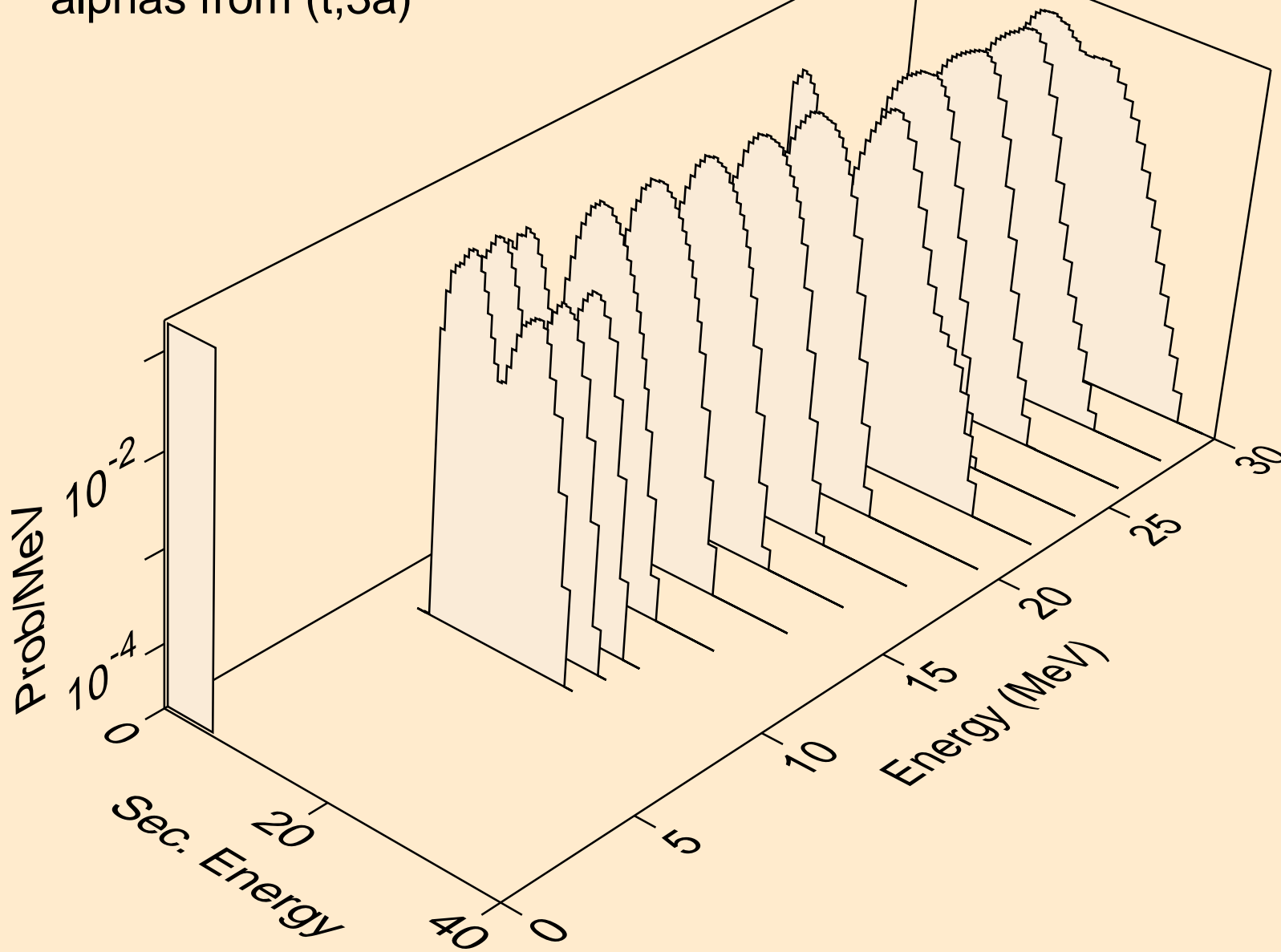

PB185M TRITON ACER TENDL-2021 LIBRARY; T=0.K  
alphas from (t,pa)

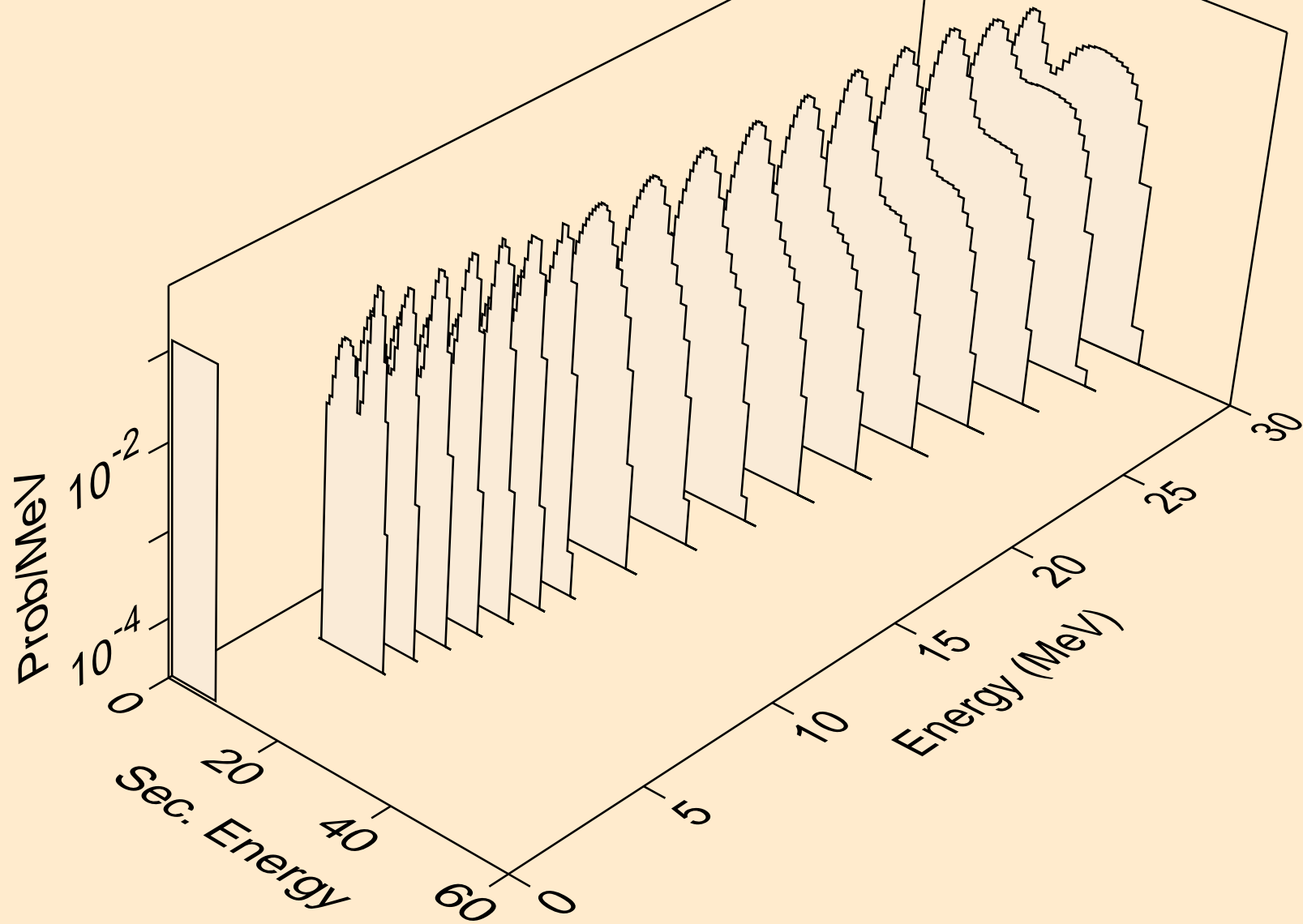

PB185M TRITON ACER TENDL-2021 LIBRARY; T=0.K  
alphas from (t,t2a)

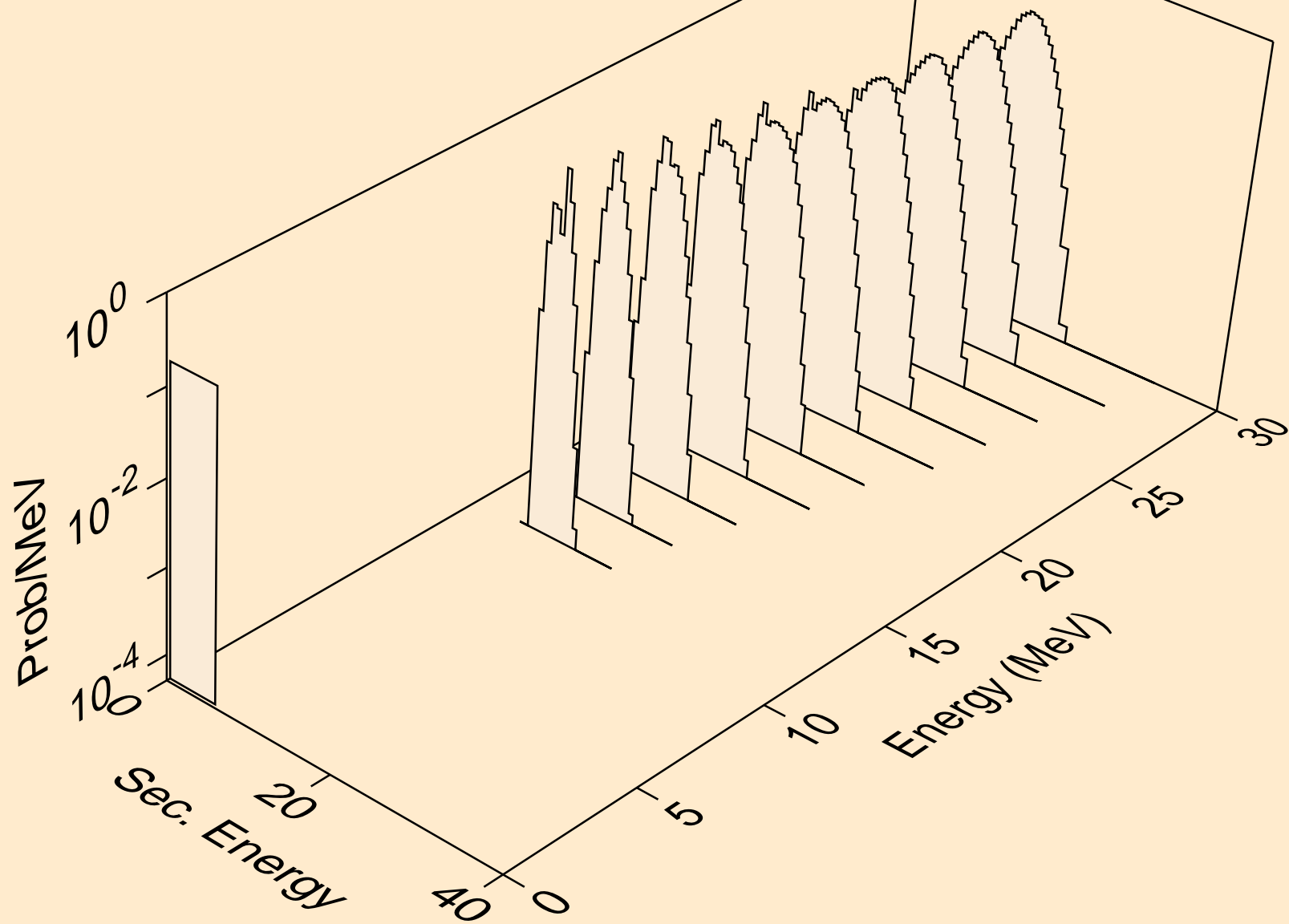

PB185M TRITON ACER TENDL-2021 LIBRARY; T=0.K  
alphas from (t,d2a)

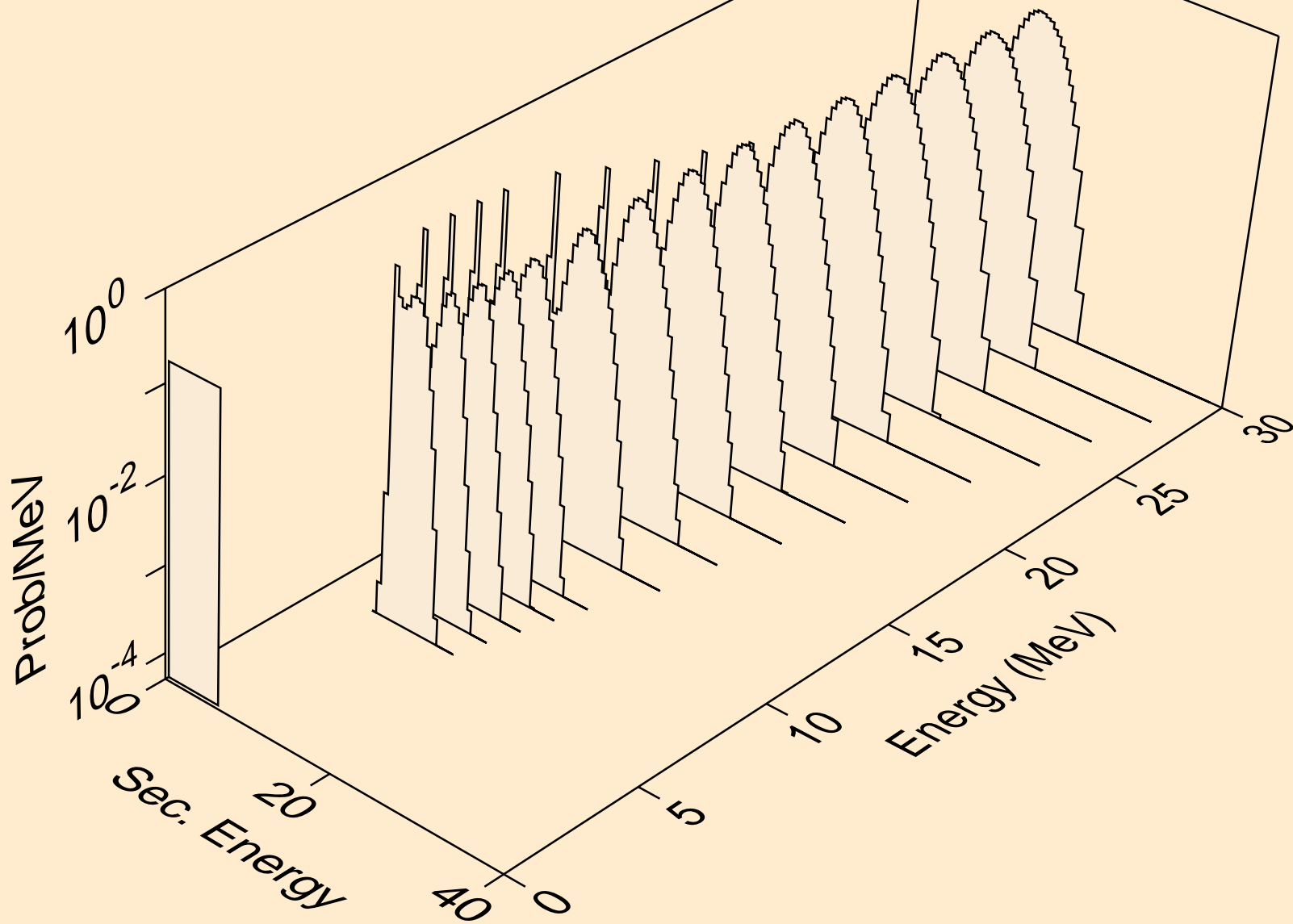



PB185M TRITON ACER TENDL-2021 LIBRARY; T=0.K  
alphas from (t,da)

