

# SN117M TRITON ACER TENDL-2021 LIBRARY; T=0.K

## Principal cross sections

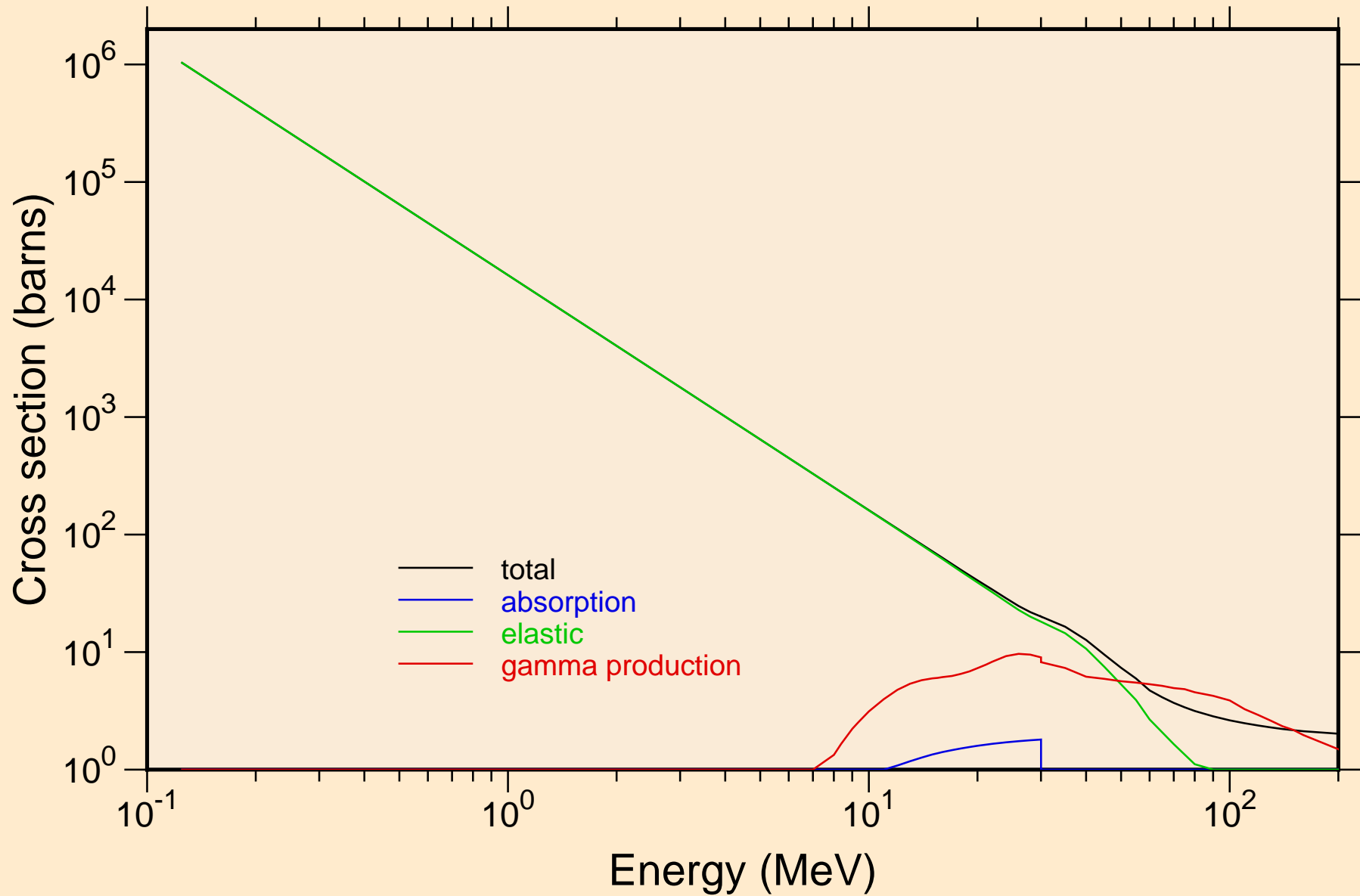

# SN117M TRITON ACER TENDL-2021 LIBRARY; T=0.K

## Heating

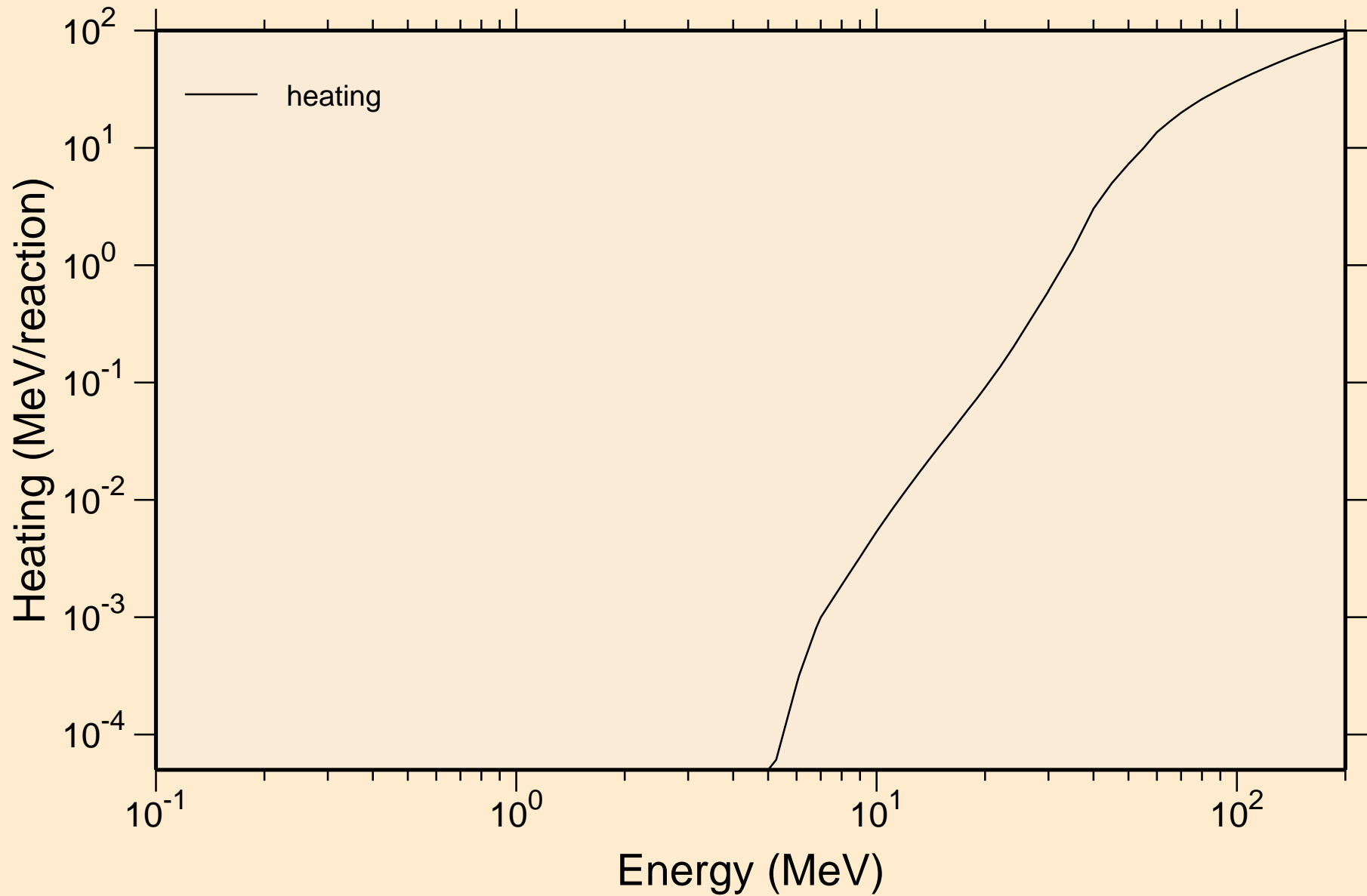

# SN117M TRITON ACER TENDL-2021 LIBRARY; T=0.K

## Principal cross sections

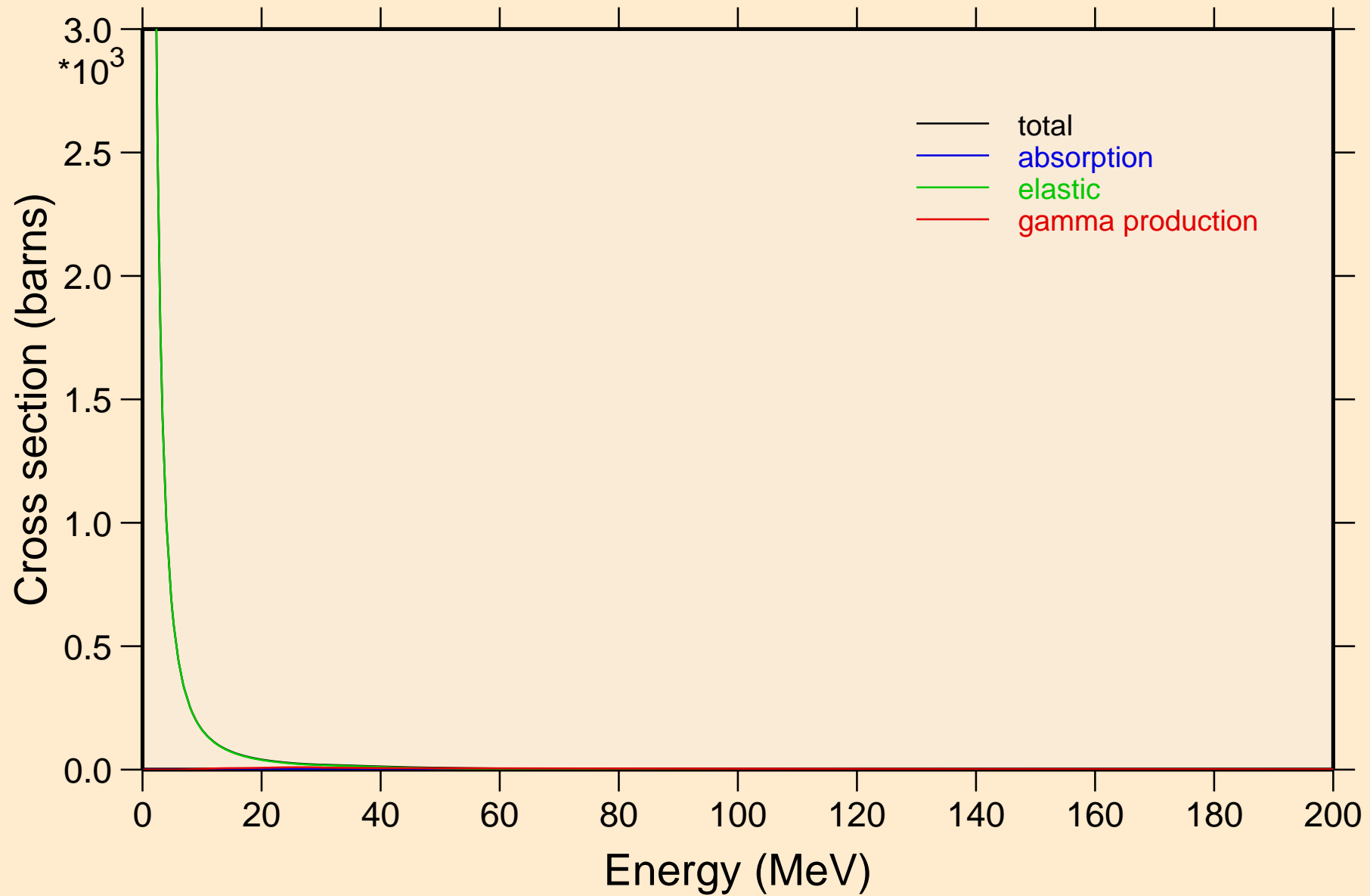

# SN117M TRITON ACER TENDL-2021 LIBRARY; T=0.K

## Heating

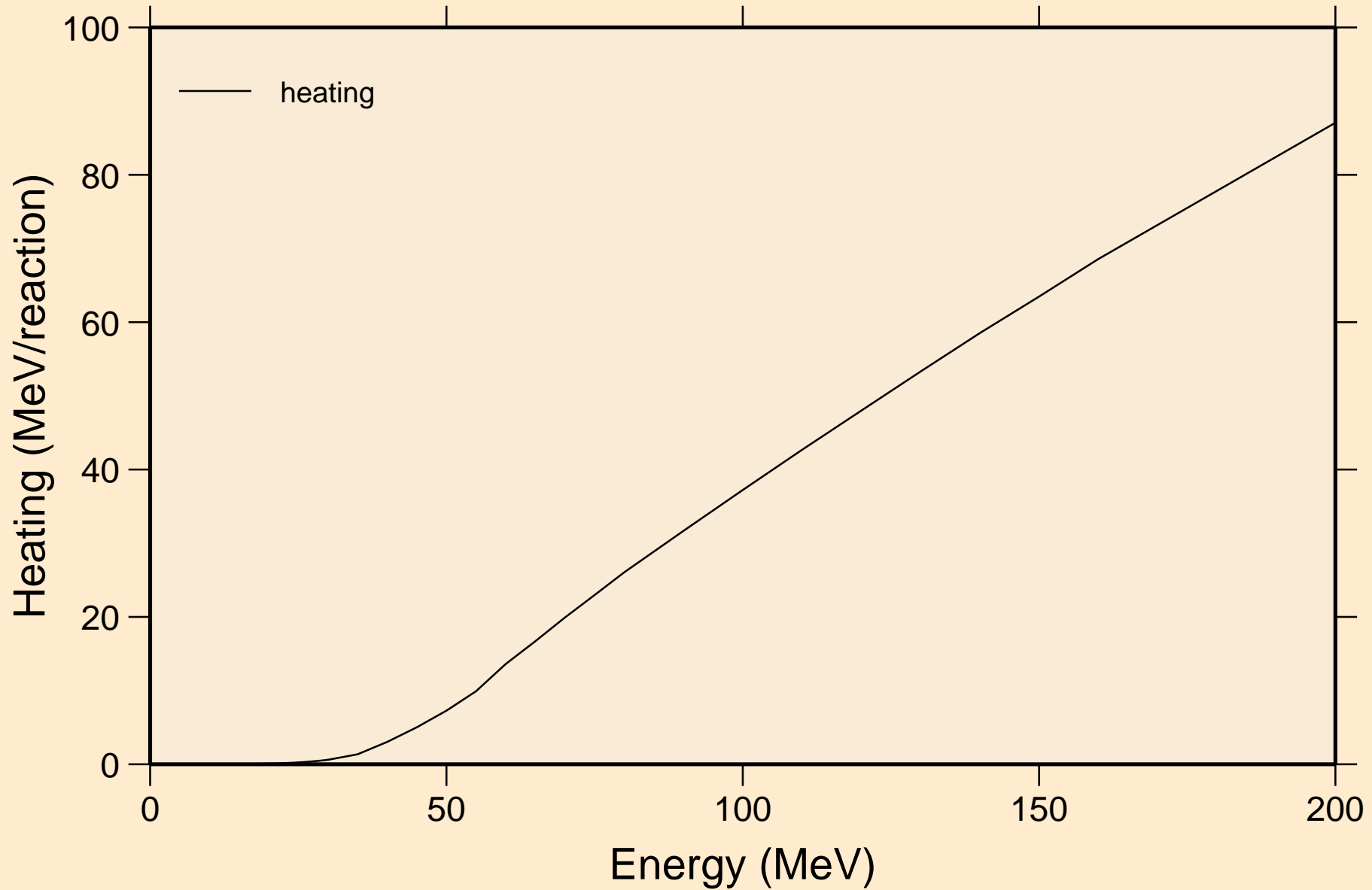

# SN117M TRITON ACER TENDL-2021 LIBRARY; T=0.K

## Threshold reactions

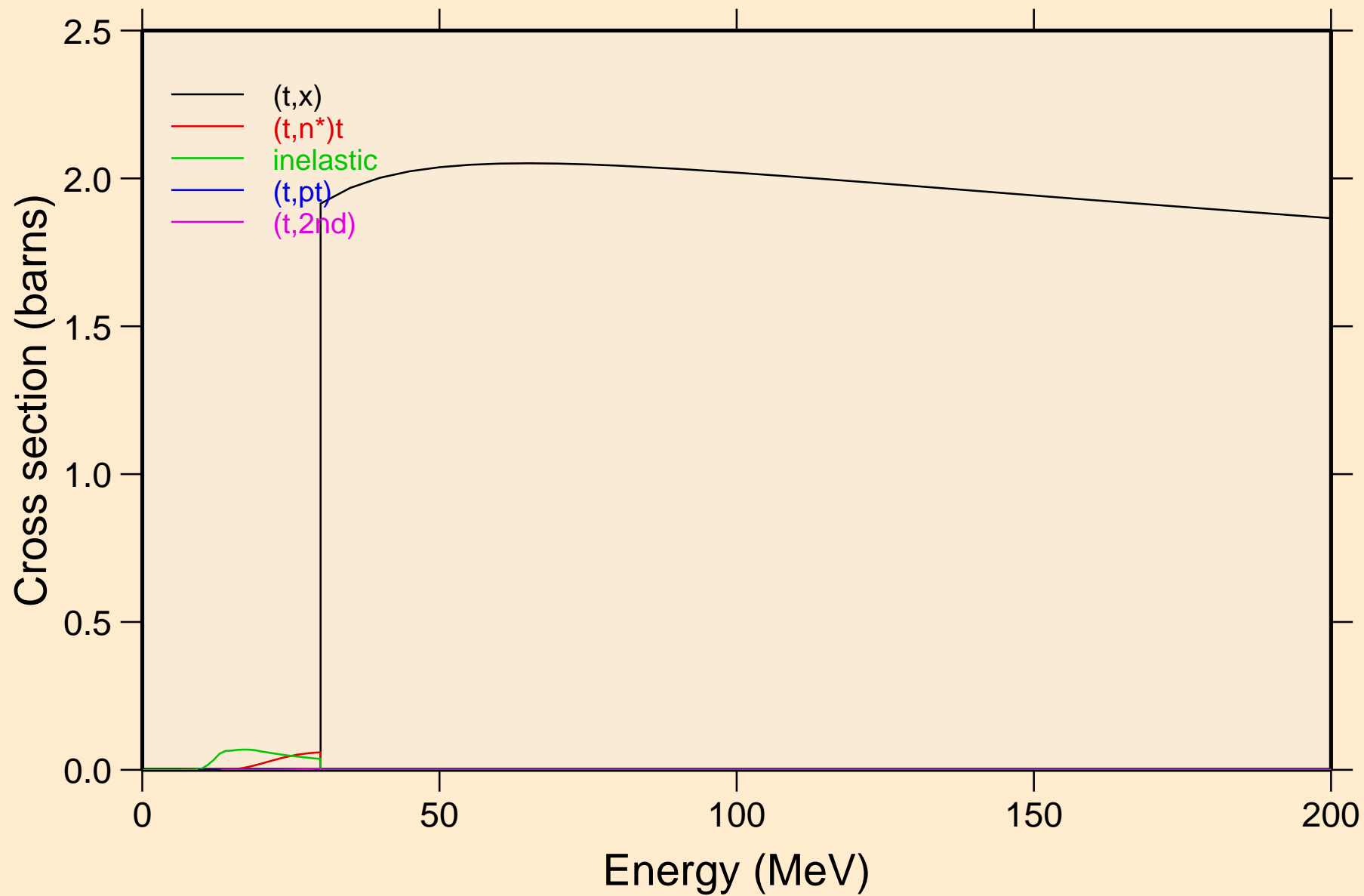

# SN117M TRITON ACER TENDL-2021 LIBRARY; T=0.K

## Threshold reactions

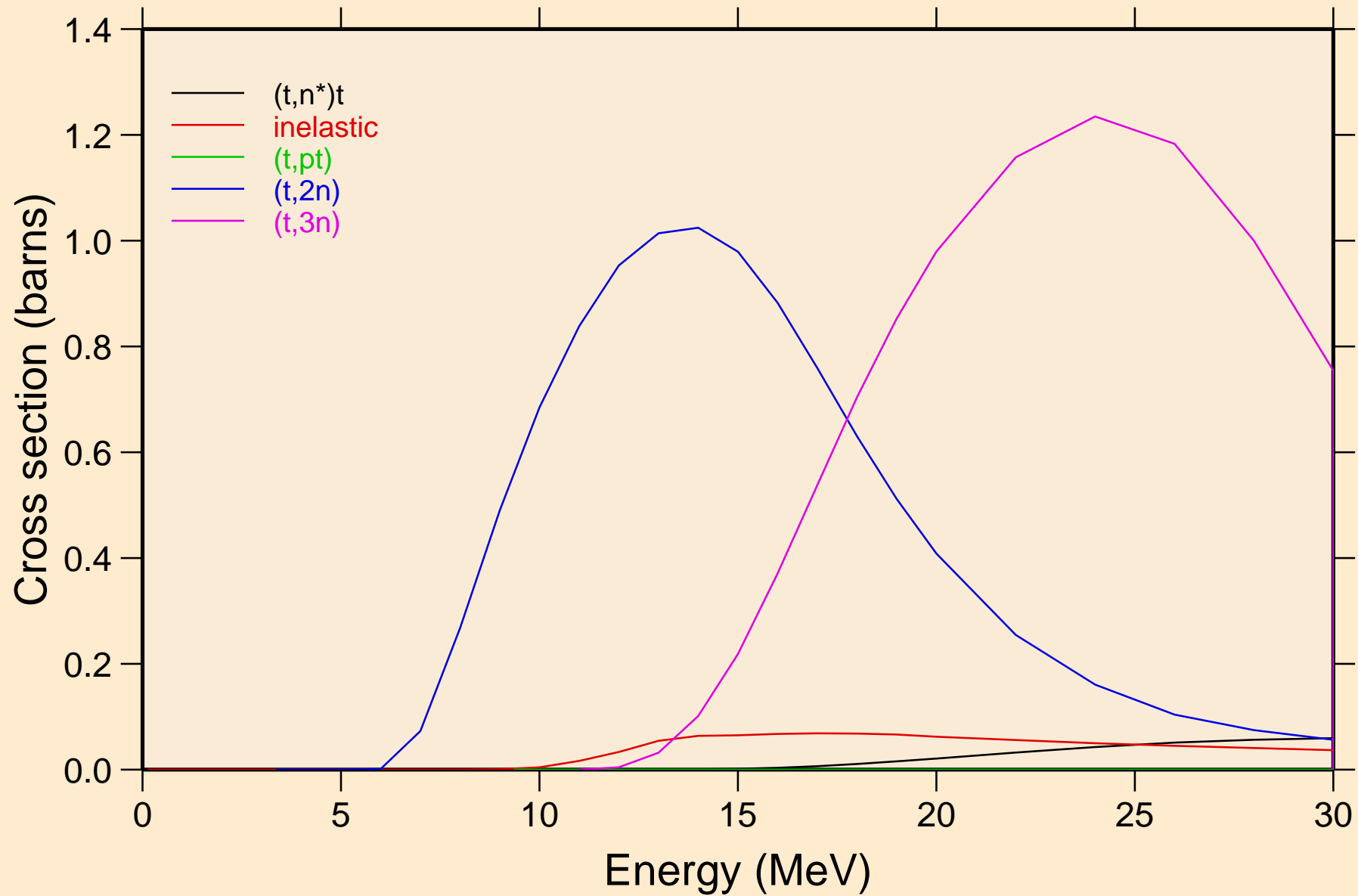

# SN117M TRITON ACER TENDL-2021 LIBRARY; T=0.K

## Threshold reactions

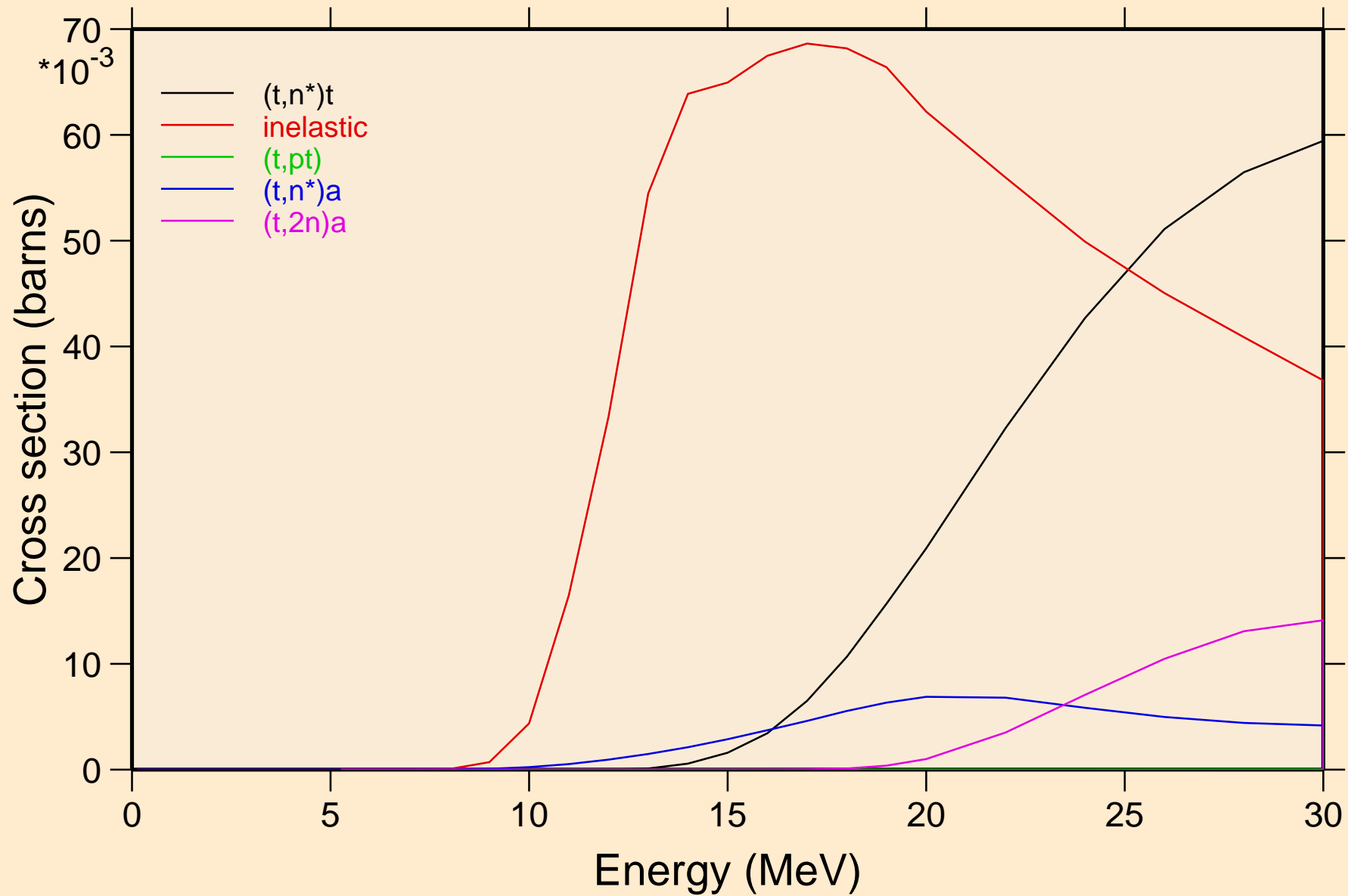

# SN117M TRITON ACER TENDL-2021 LIBRARY; T=0.K

## Threshold reactions

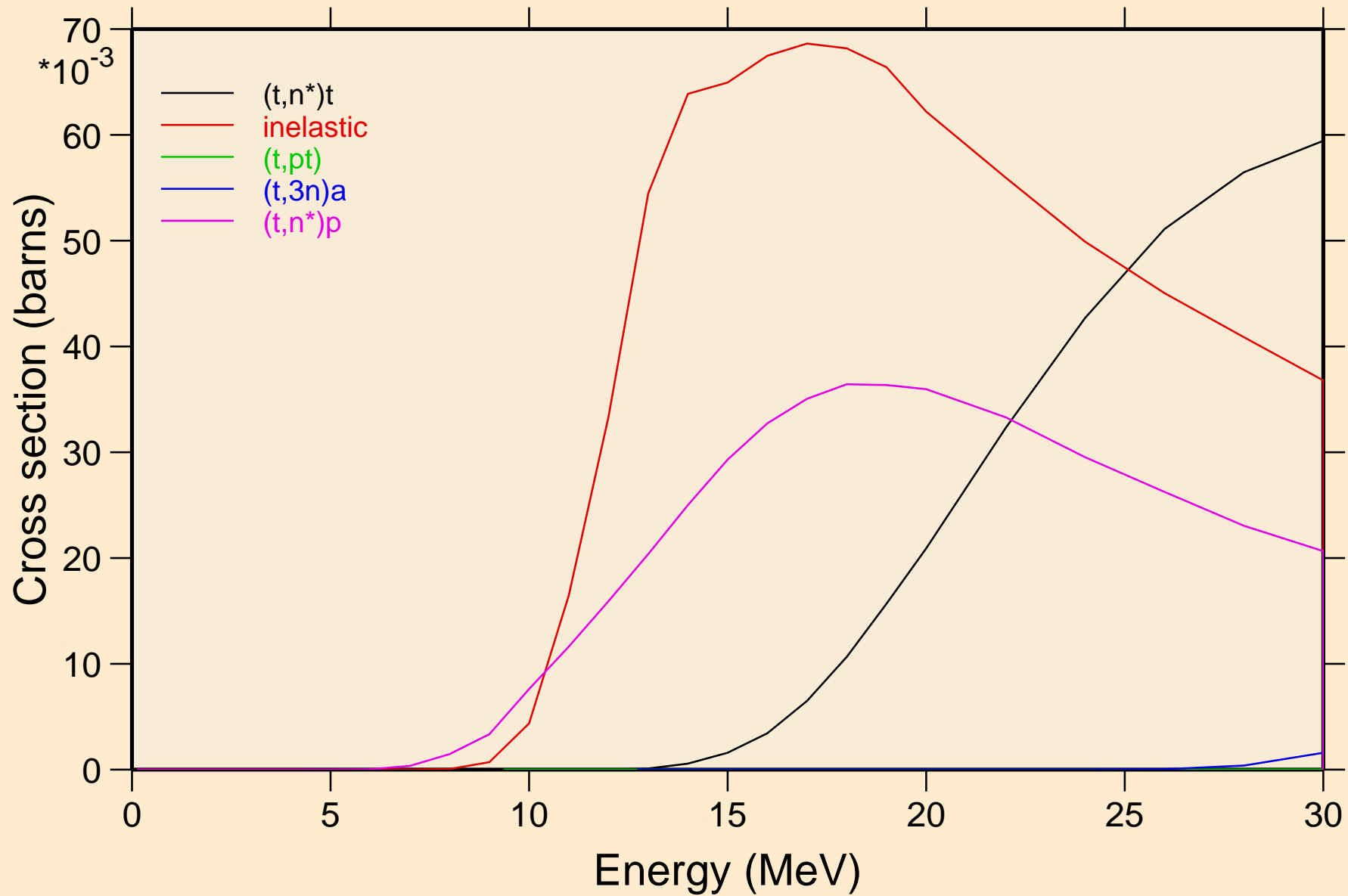



# SN117M TRITON ACER TENDL-2021 LIBRARY; T=0.K

## Threshold reactions

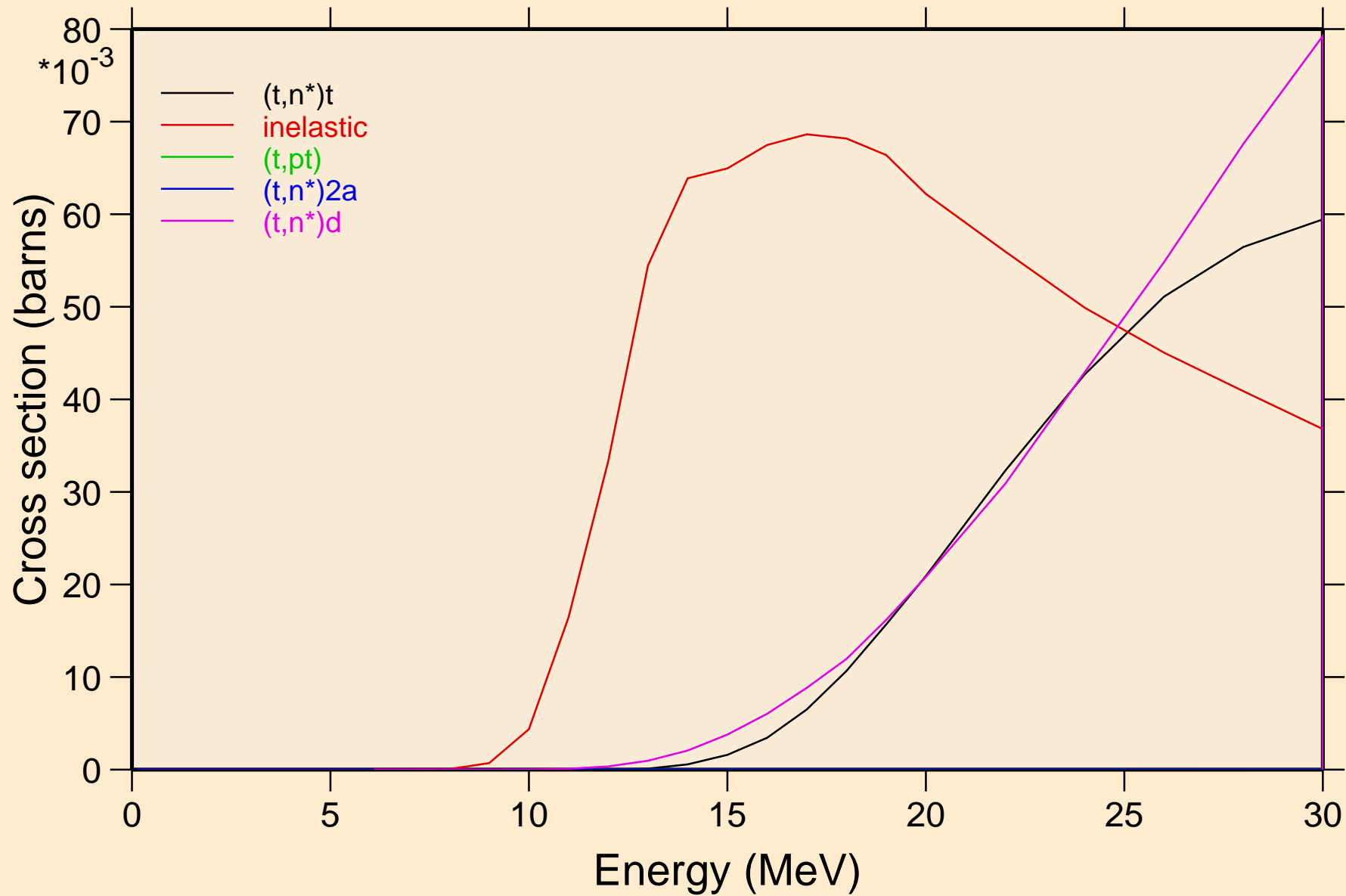

# SN117M TRITON ACER TENDL-2021 LIBRARY; T=0.K

## Threshold reactions

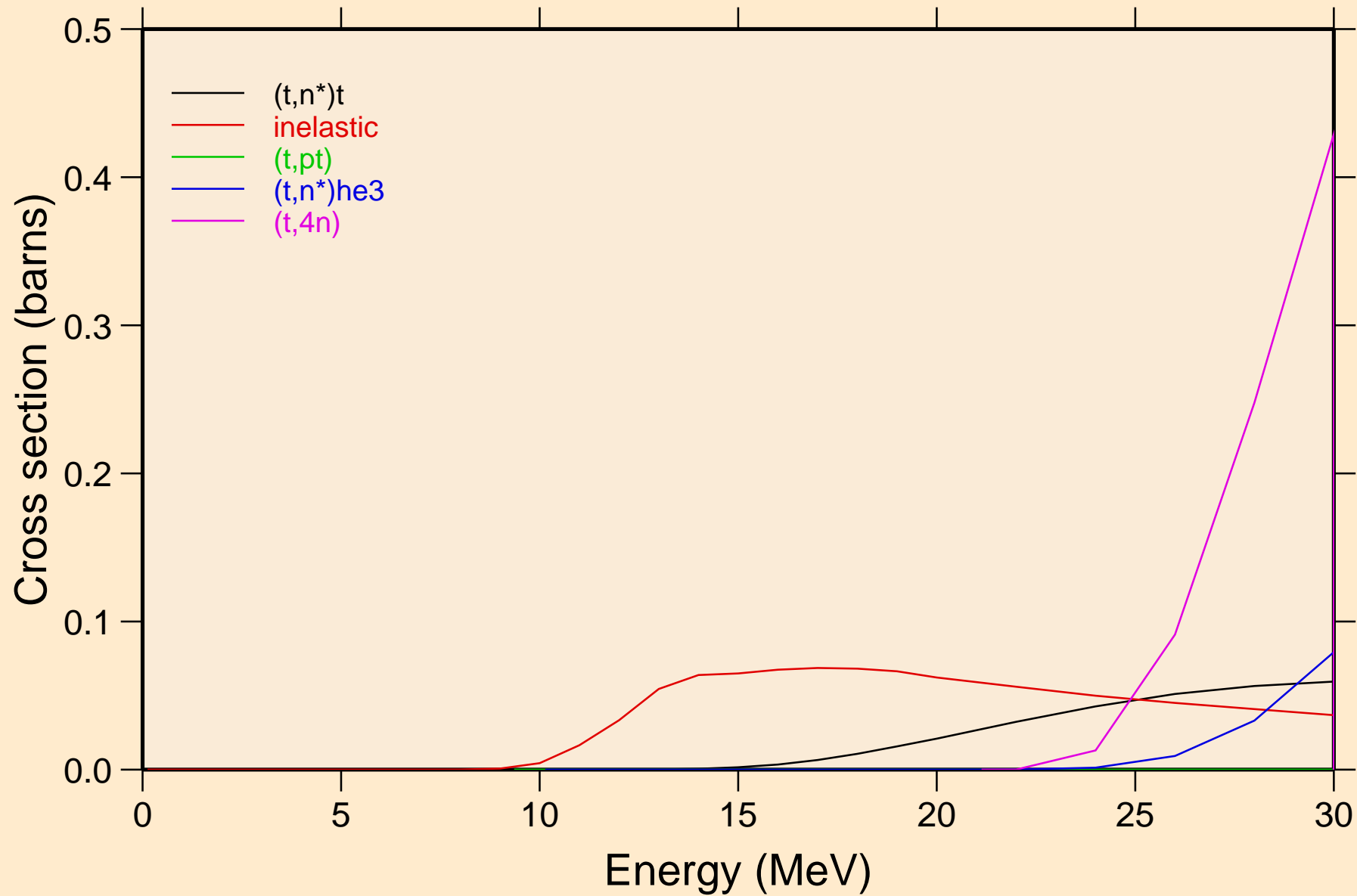

# SN117M TRITON ACER TENDL-2021 LIBRARY; T=0.K

## Threshold reactions

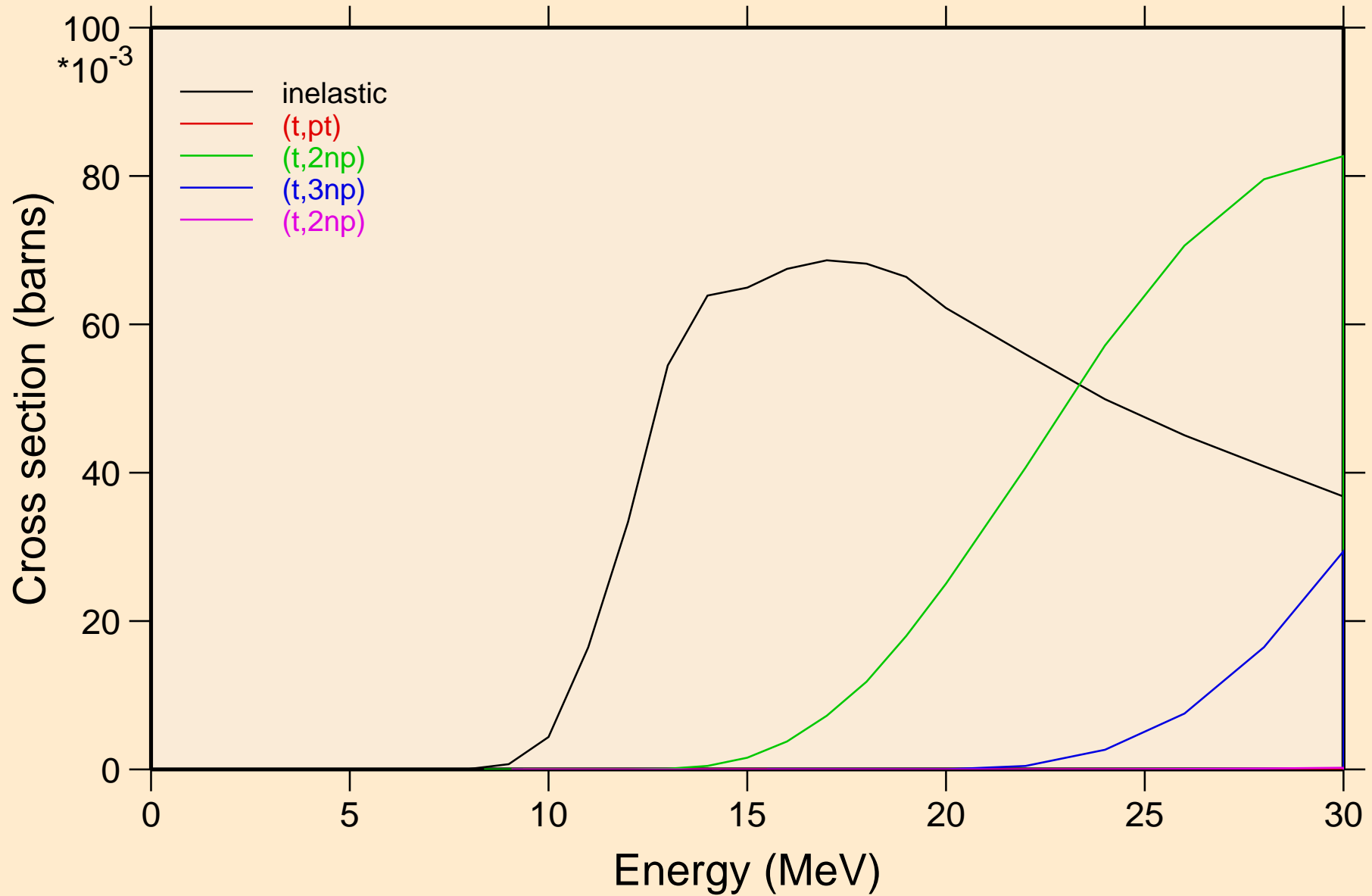

# SN117M TRITON ACER TENDL-2021 LIBRARY; T=0.K

## Threshold reactions

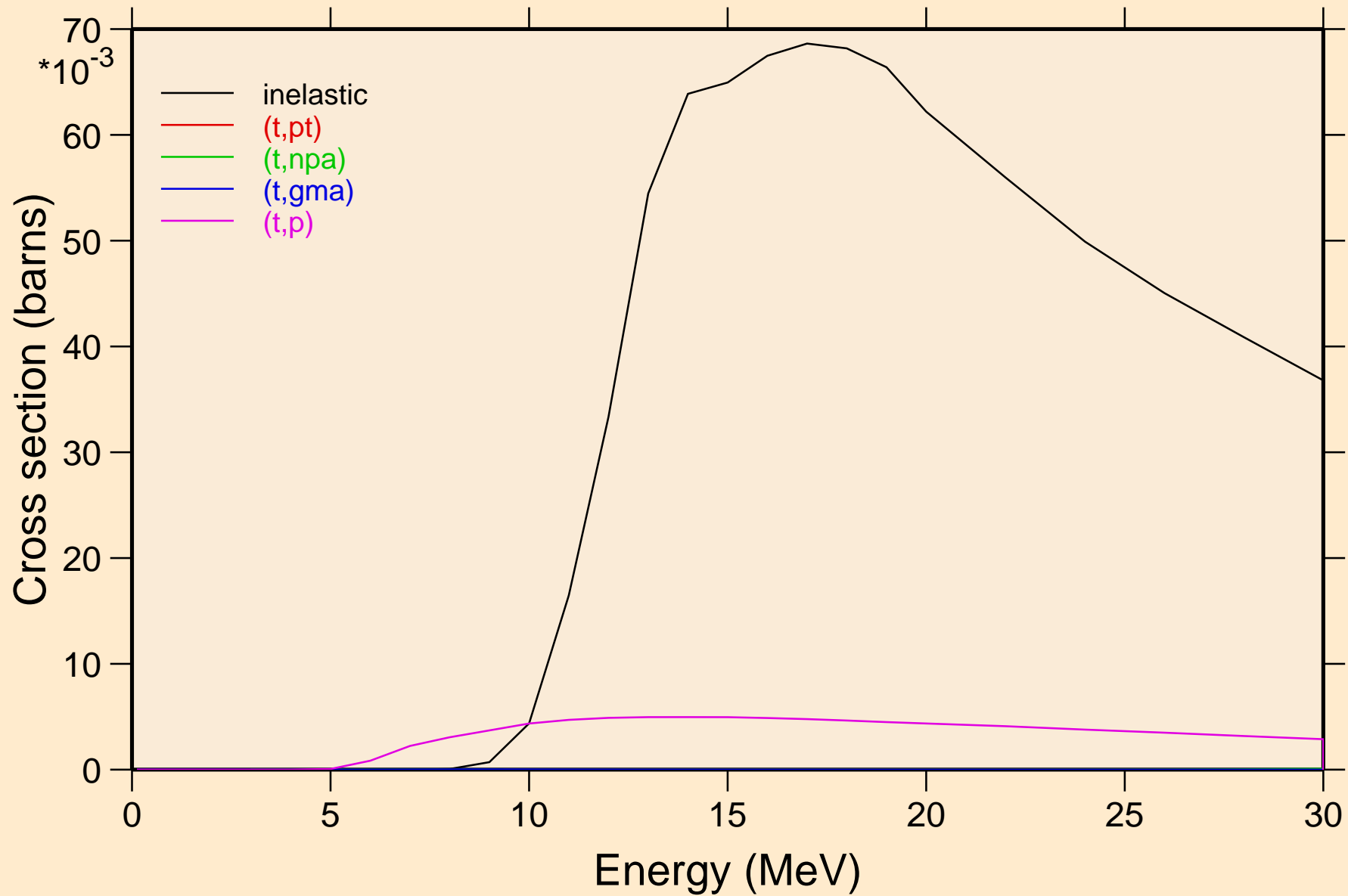

# SN117M TRITON ACER TENDL-2021 LIBRARY; T=0.K

## Threshold reactions

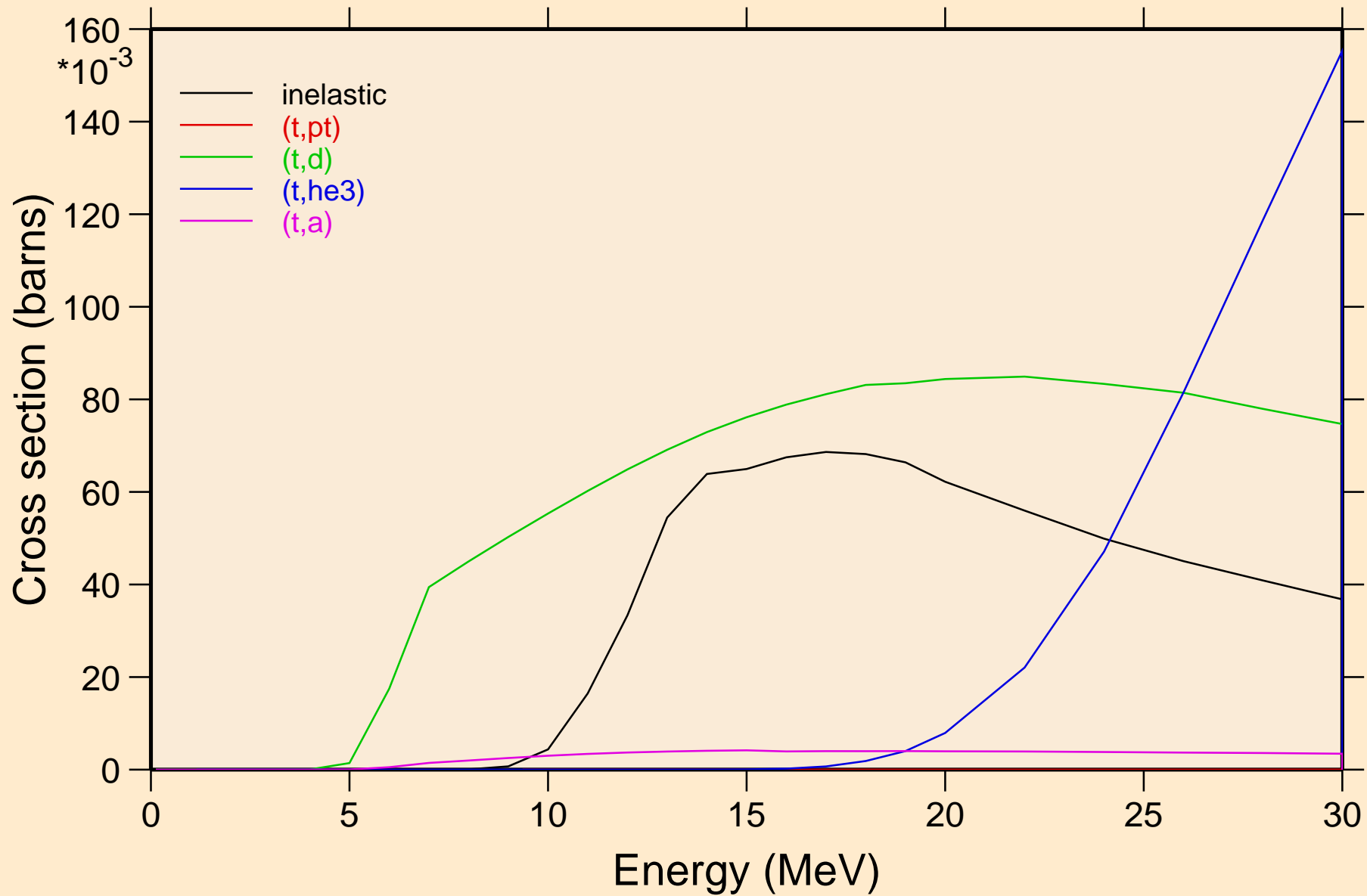

# SN117M TRITON ACER TENDL-2021 LIBRARY; T=0.K

## Threshold reactions

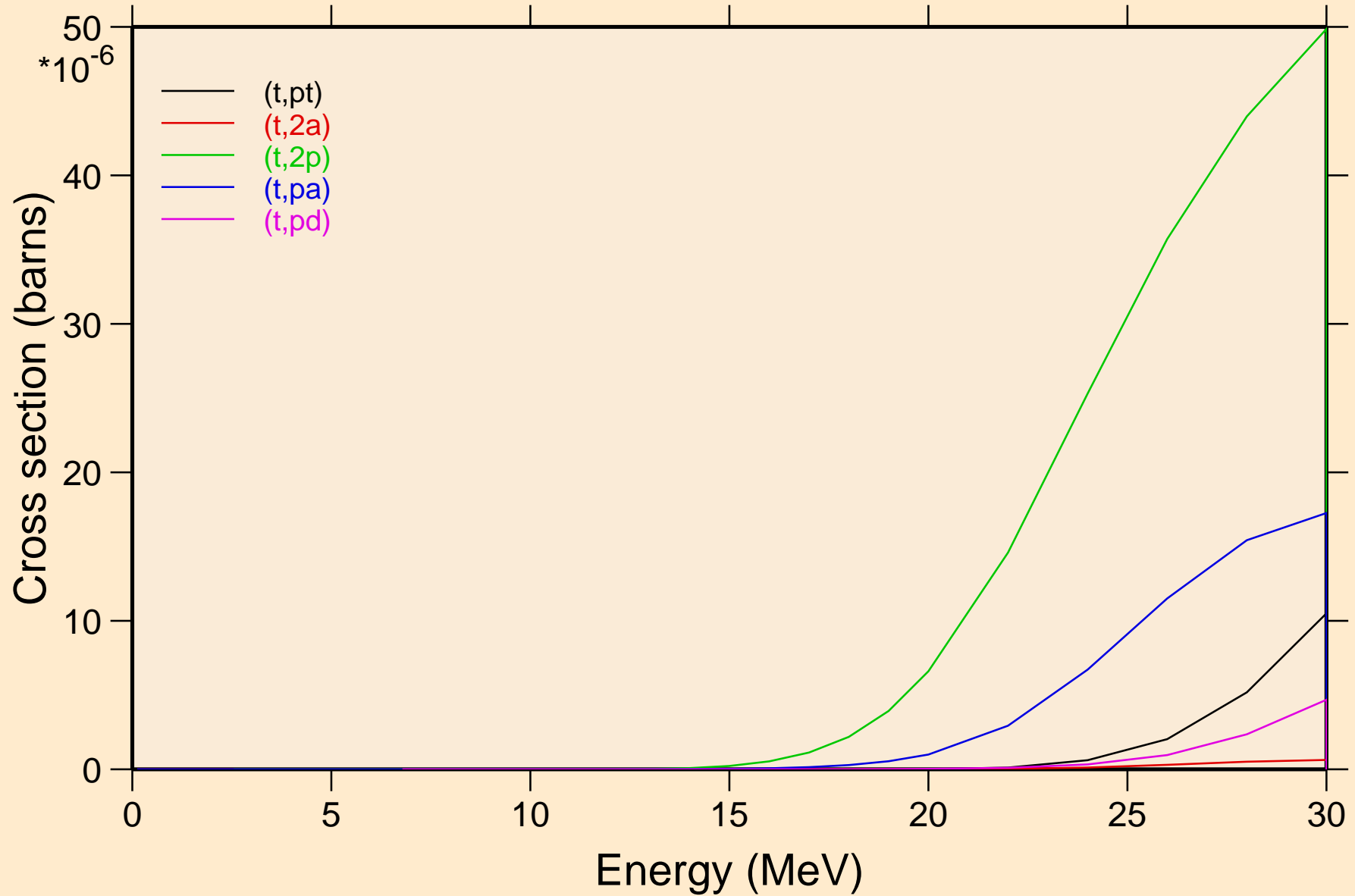

SN117M TRITON ACER TENDL-2021 LIBRARY; T=0.K  
Threshold reactions

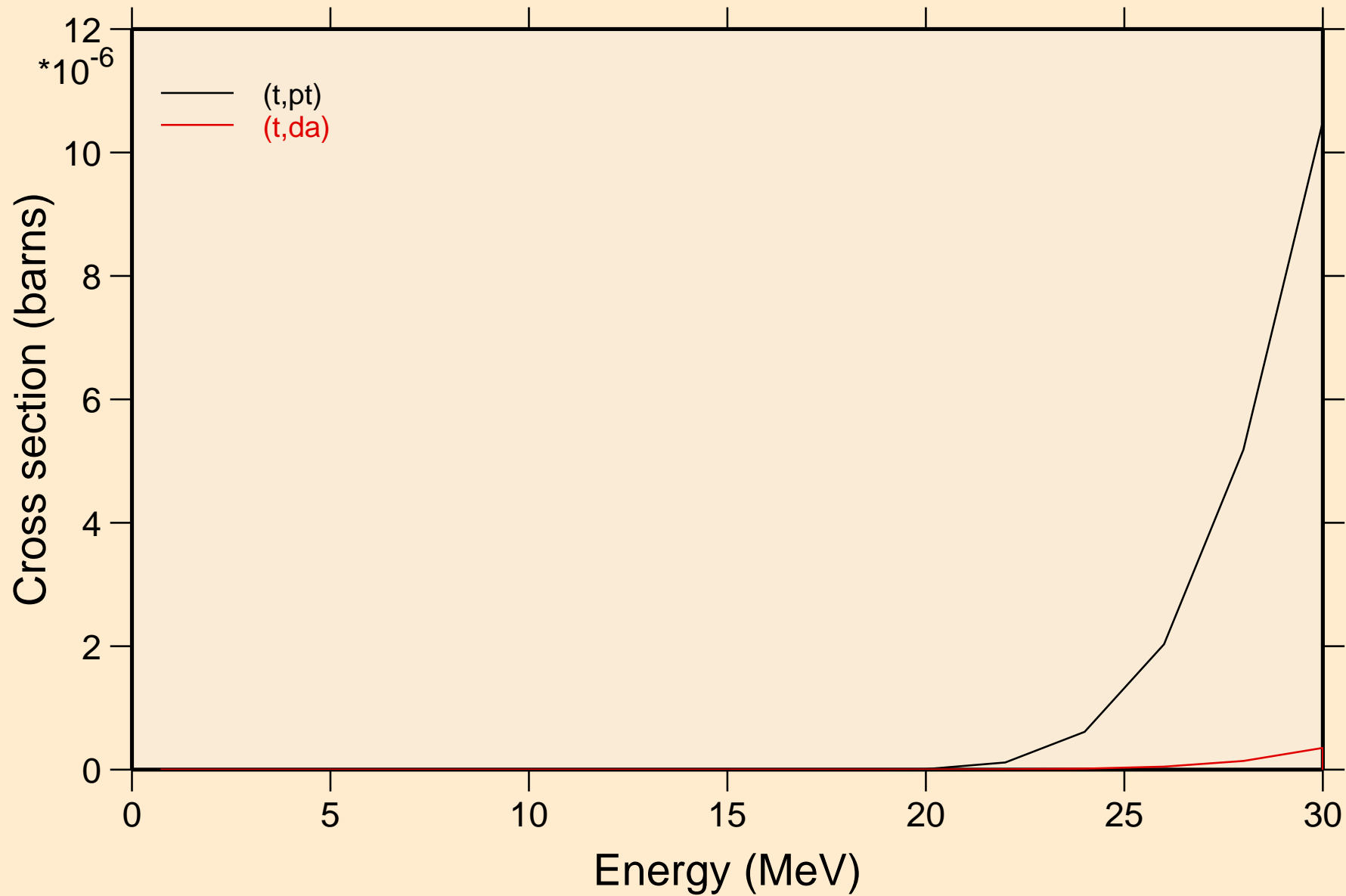

SN117M TRITON ACER TENDL-2021 LIBRARY; T=0.K  
angular distribution for elastic

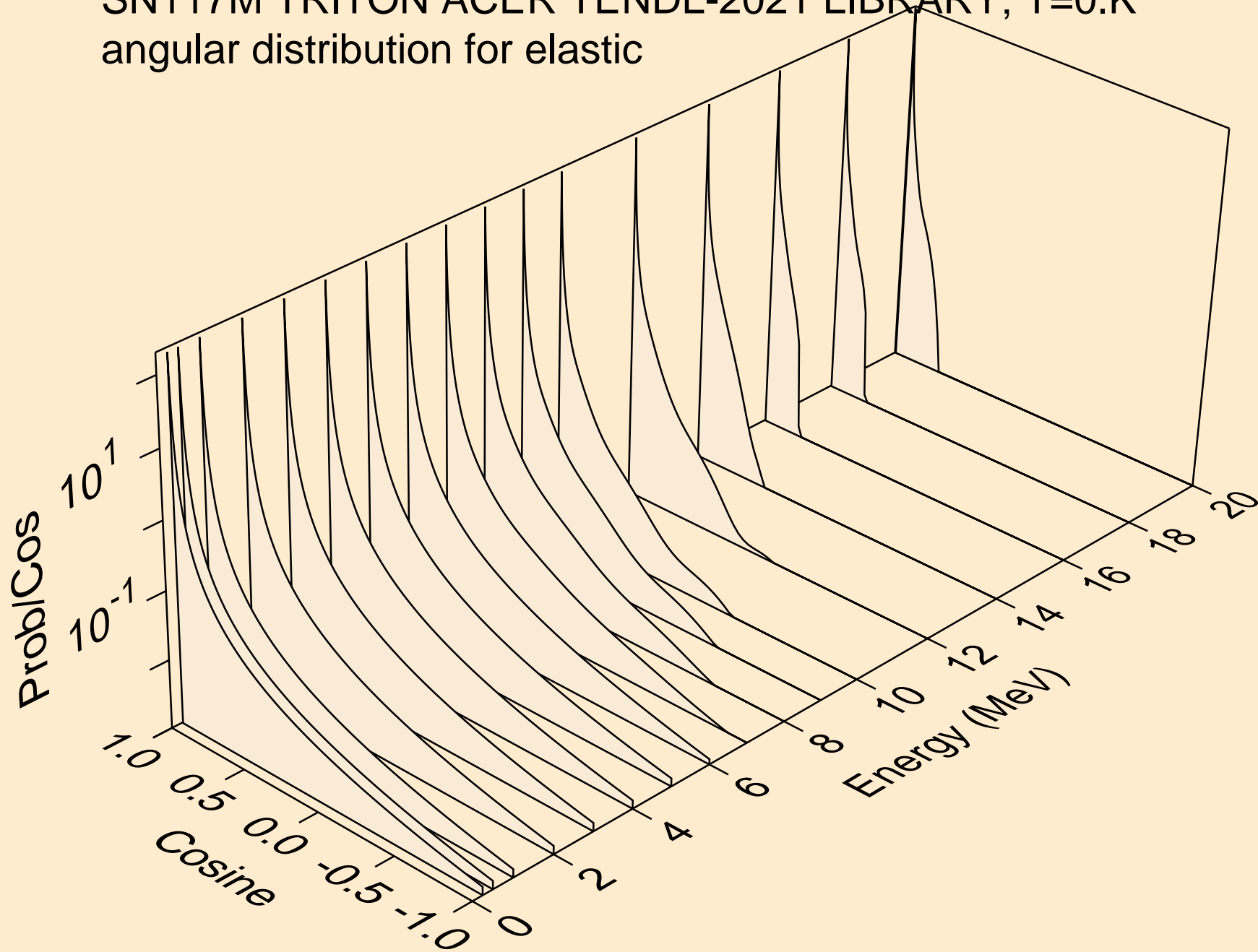



SN117M TRITON ACER TENDL-2021 LIBRARY; T=0.K  
angular distribution for elastic

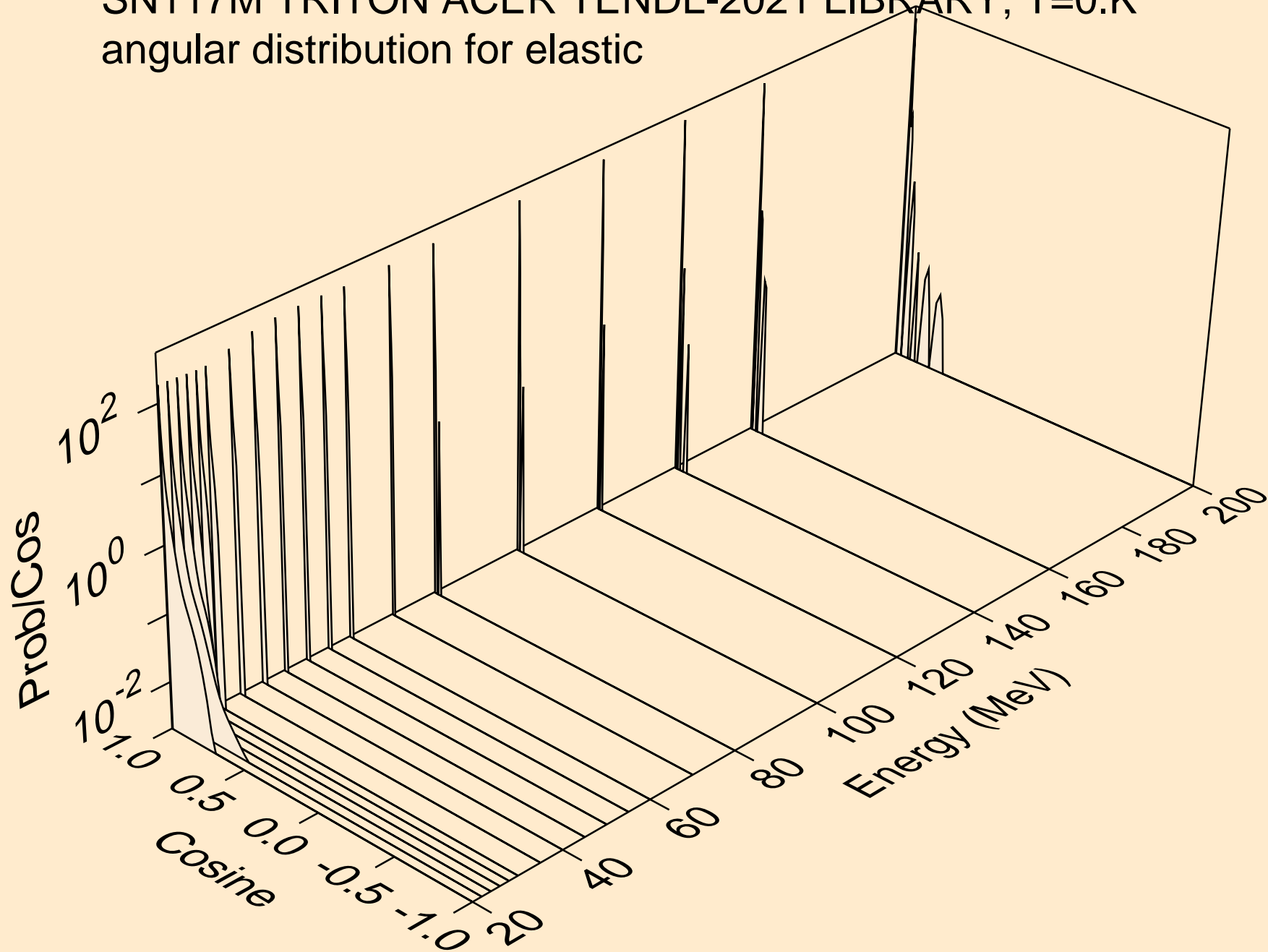

SN117M TRITON ACER TENDL-2021 LIBRARY; T=0.K  
Triton emission for (t,x)

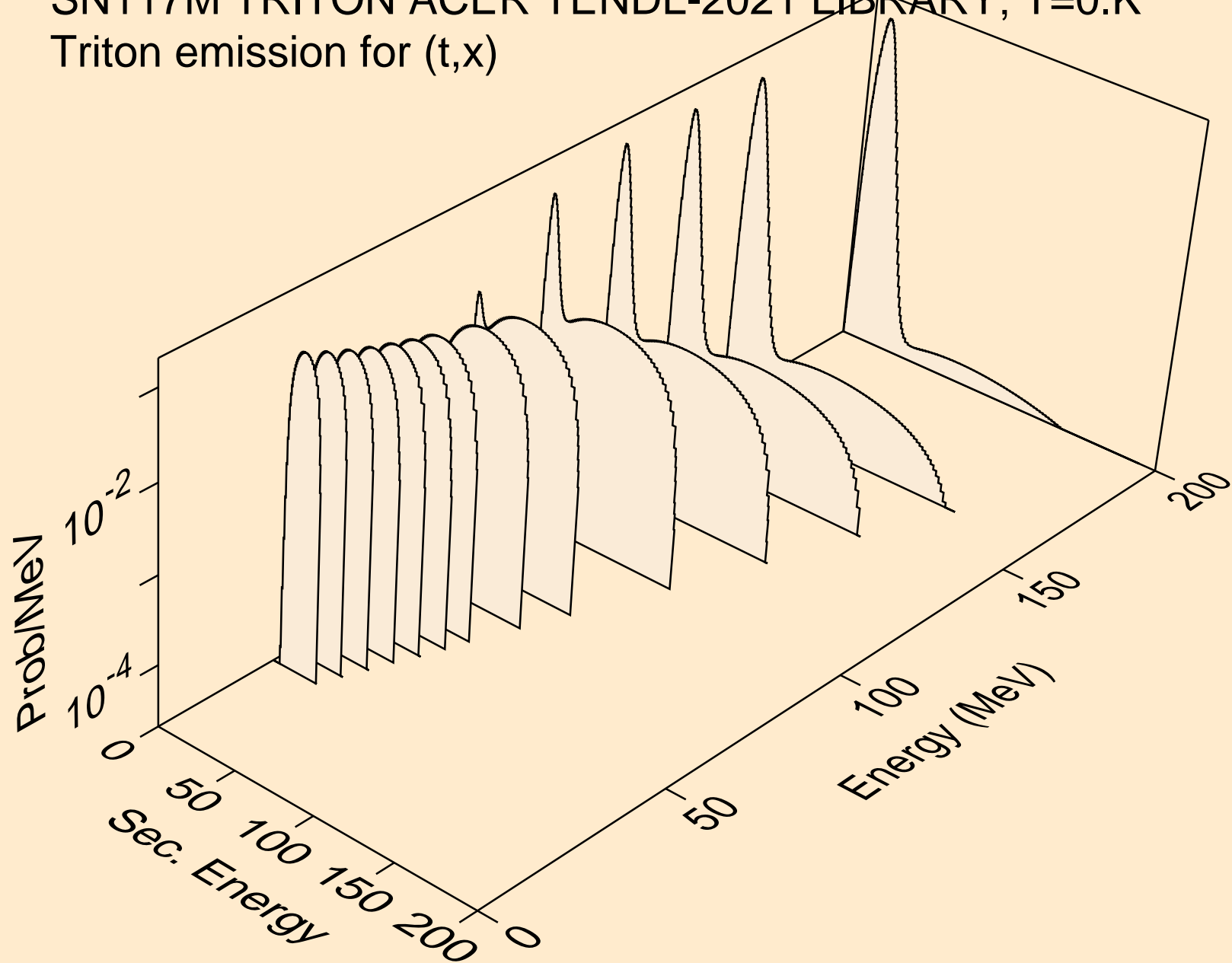

SN117M TRITON ACER TENDL-2021 LIBRARY; T=0.K  
Triton emission for (t,n\*)t

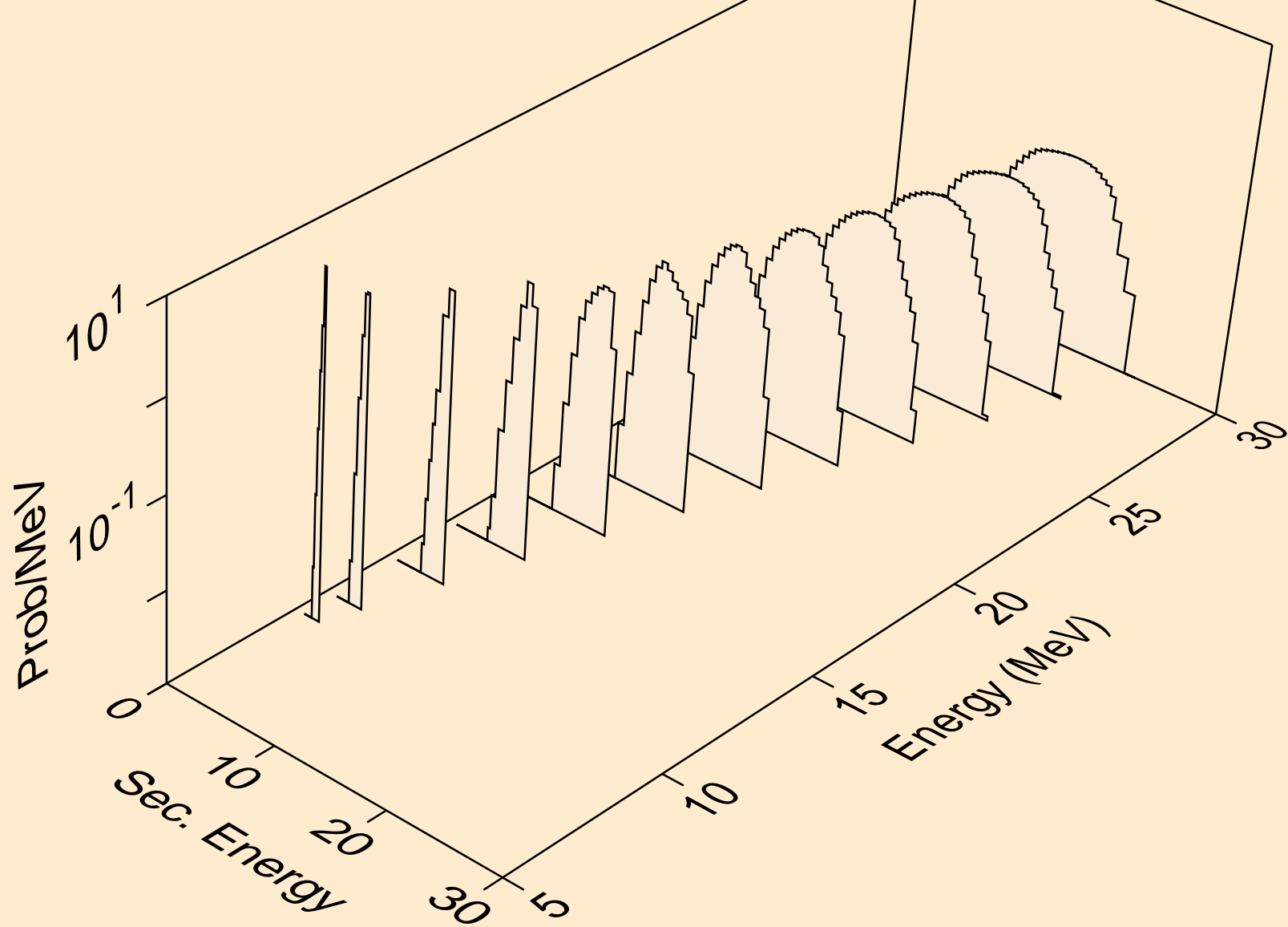

SN117M TRITON ACER TENDL-2021 LIBRARY; T=0.K  
Triton emission for inelastic

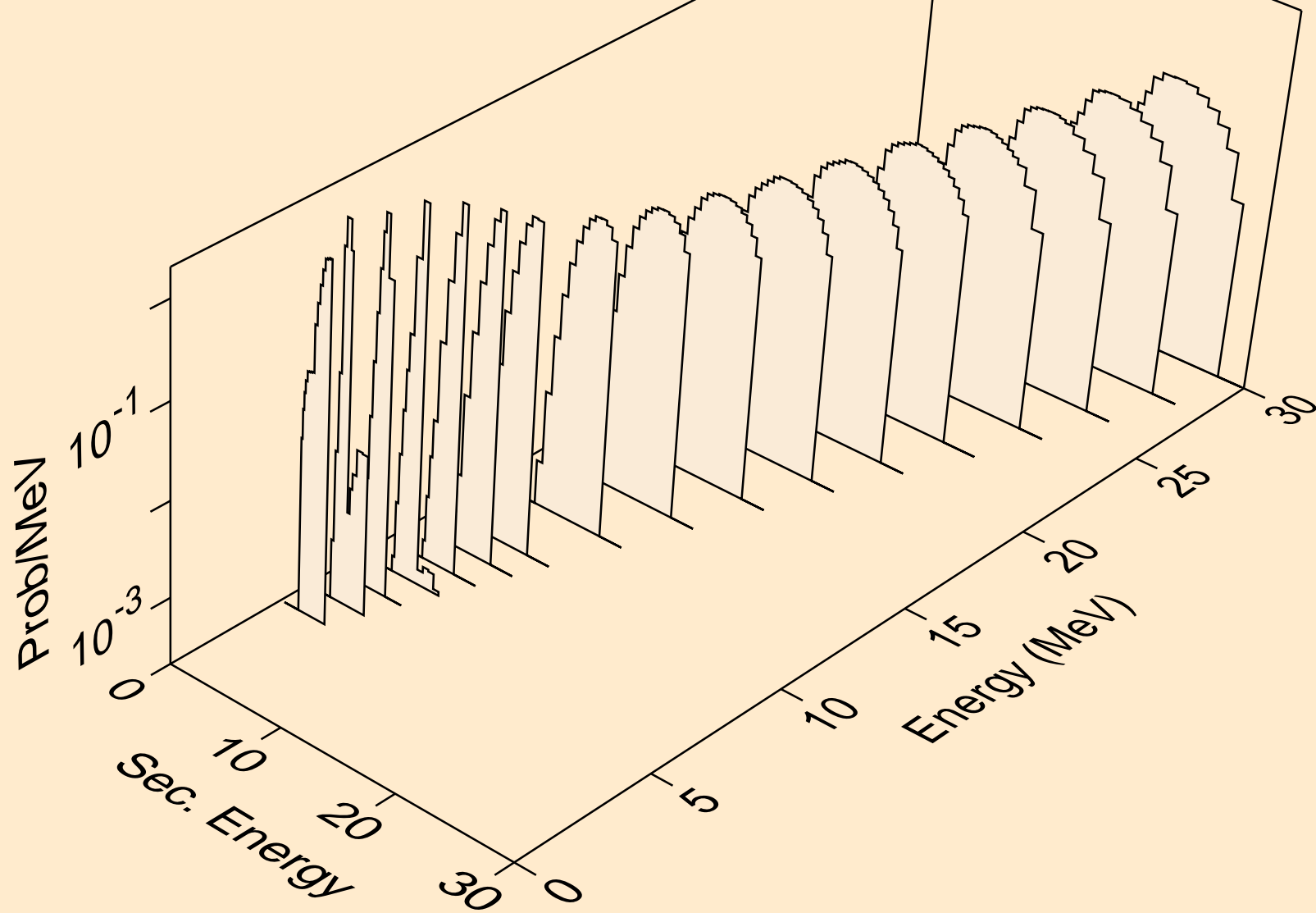

SN117M TRITON ACER TENDL-2021 LIBRARY; T=0.K  
Triton emission for (t,pt)

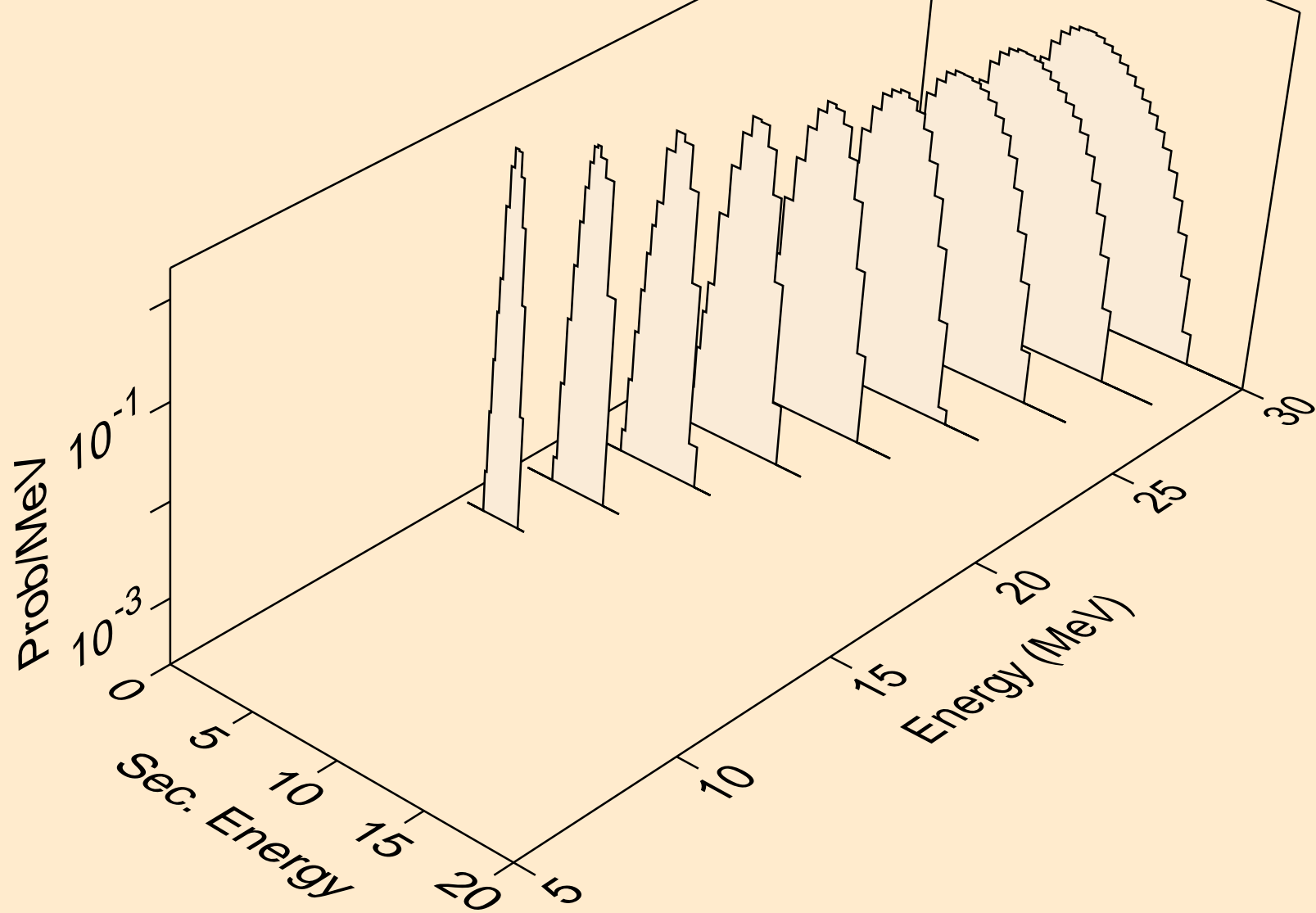

SN117M TRITON ACER TENDL-2021 LIBRARY; T=0.K  
Photon emission for (z,n)

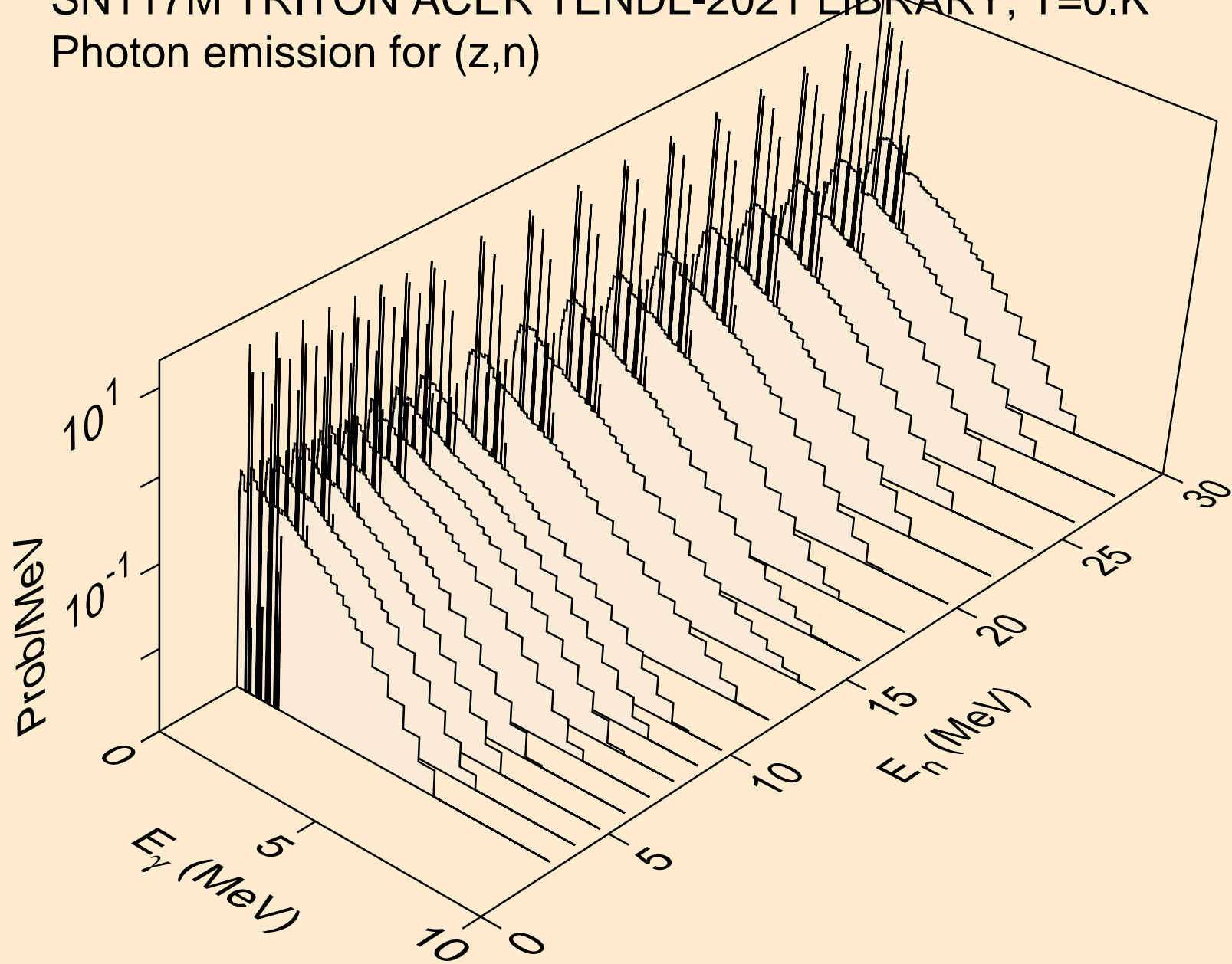

SN117M TRITON ACER TENDL-2021 LIBRARY; T=0.K  
Photon emission for (n,x)

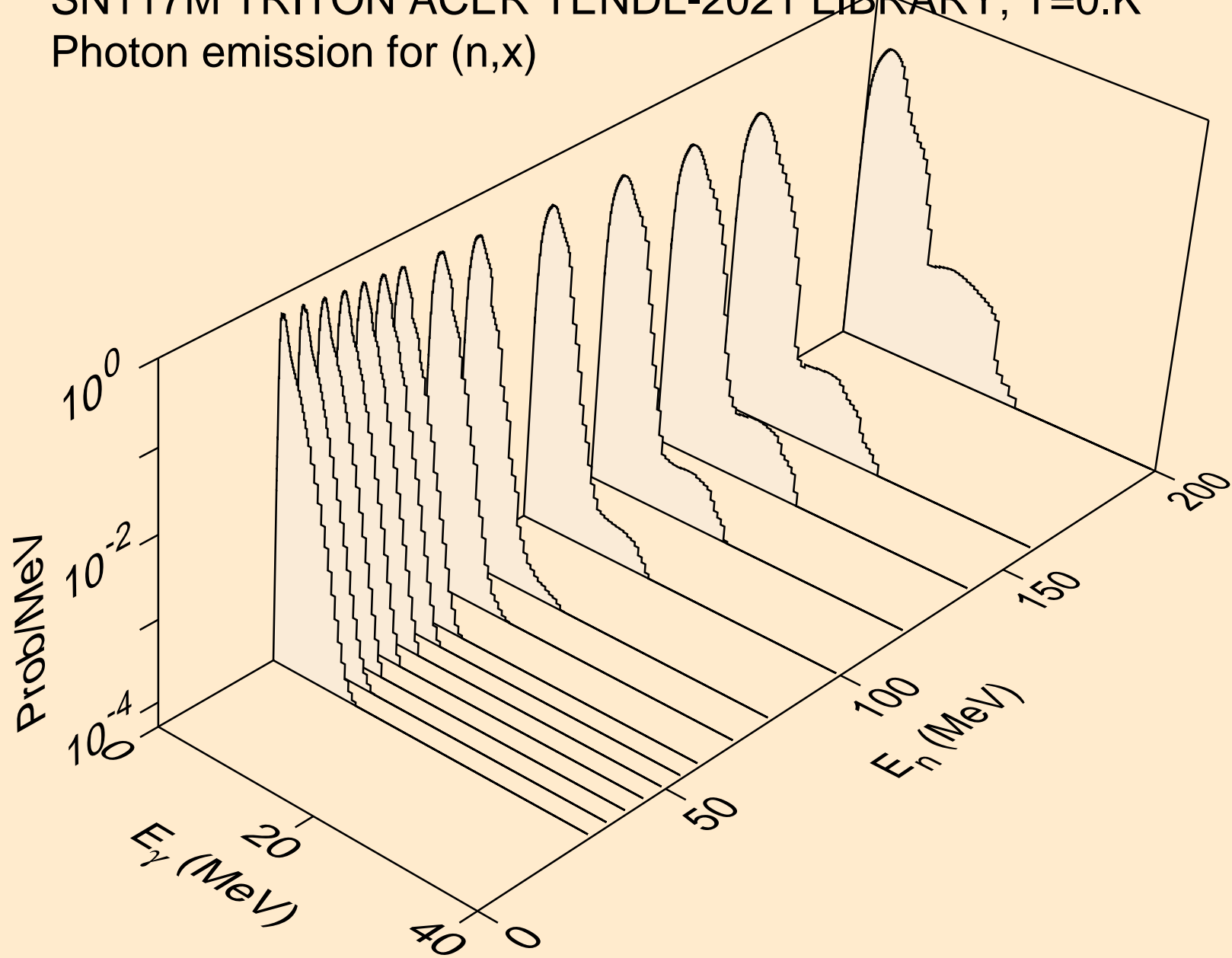

SN117M TRITON ACER TENDL-2021 LIBRARY; T=0.K  
Photon emission for (n,2nd)

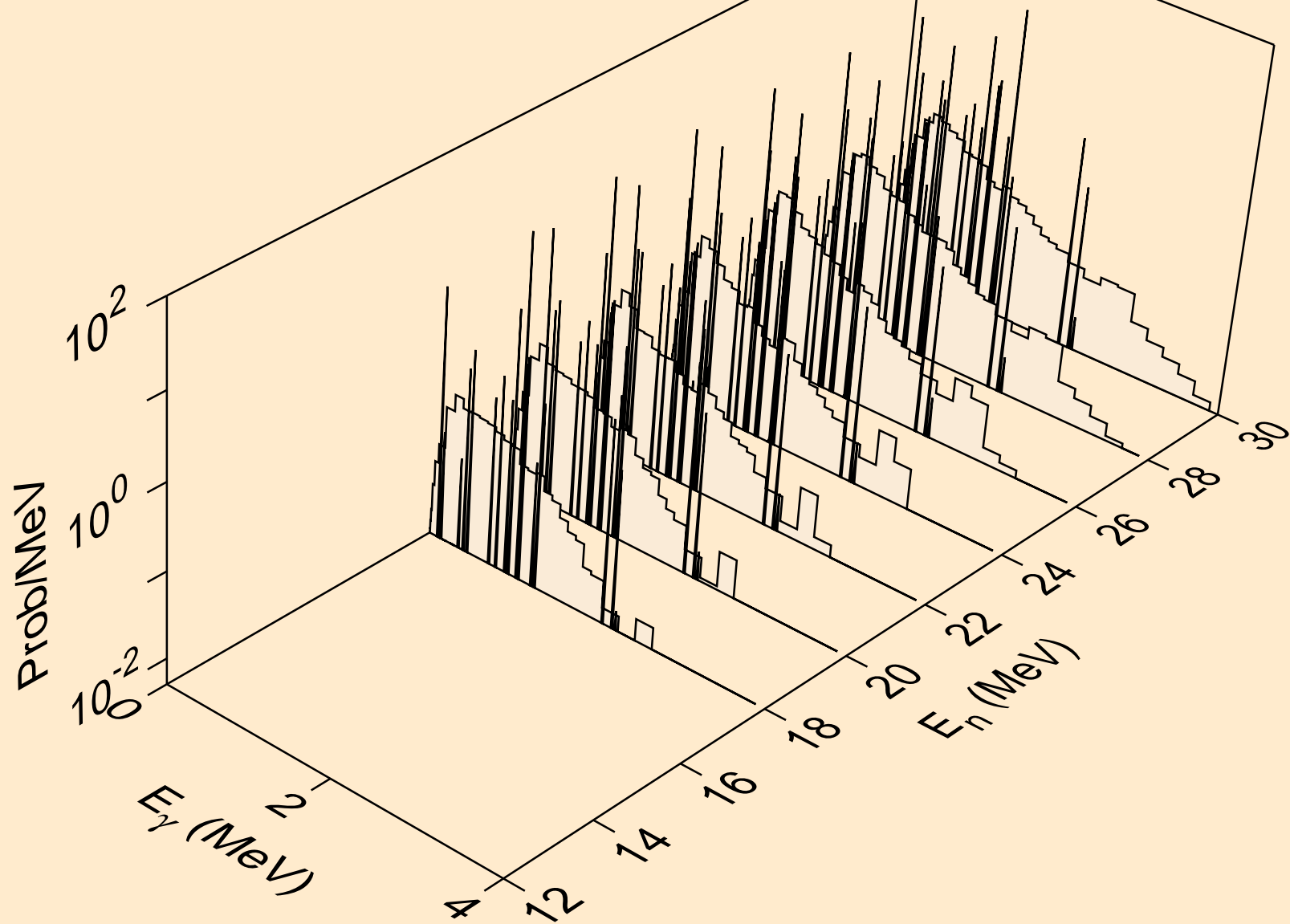



SN117M TRITON ACER TENDL-2021 LIBRARY; T=0.K  
Photon emission for (n,2n)

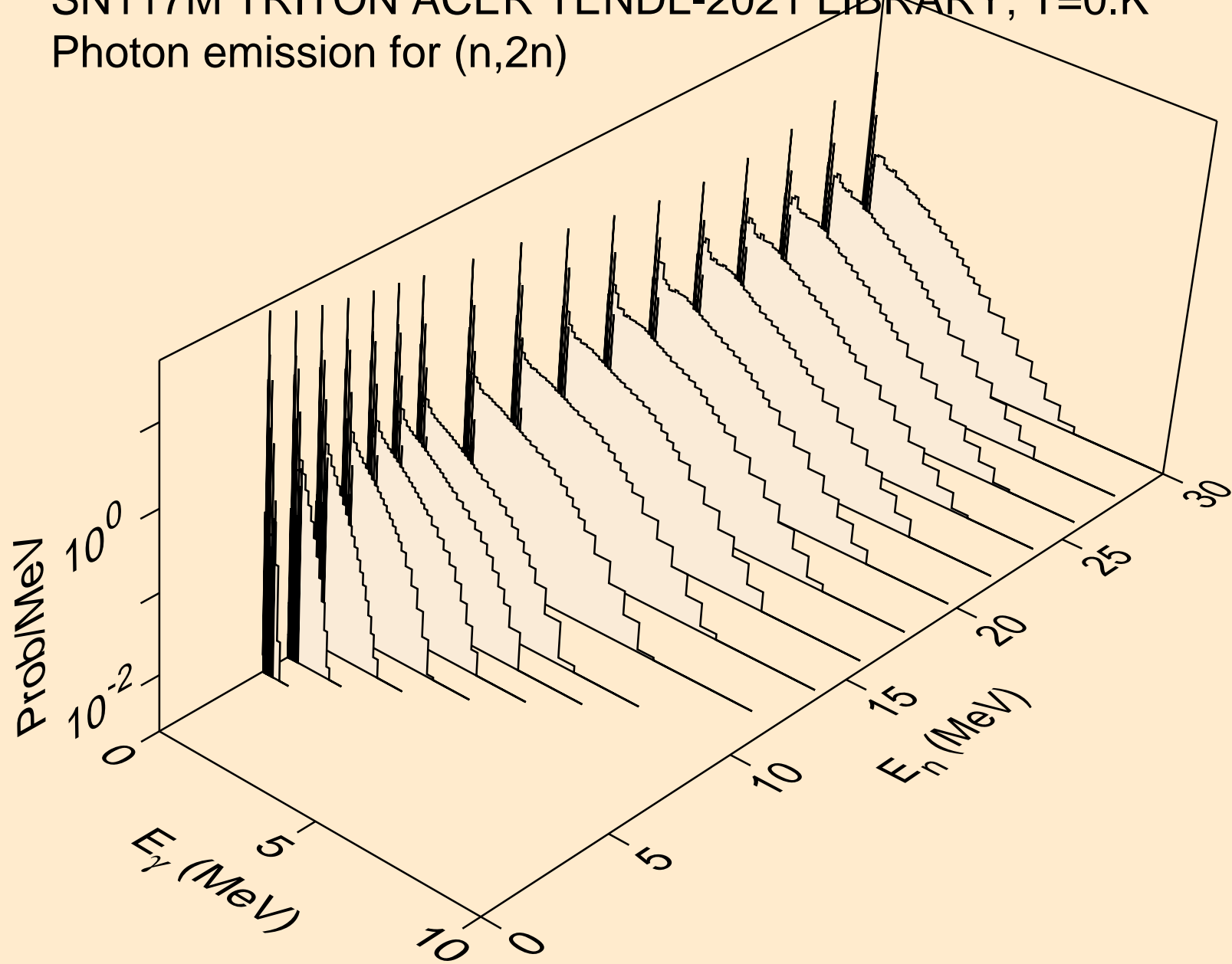

SN117M TRITON ACER TENDL-2021 LIBRARY; T=0.K  
Photon emission for (n,3n)

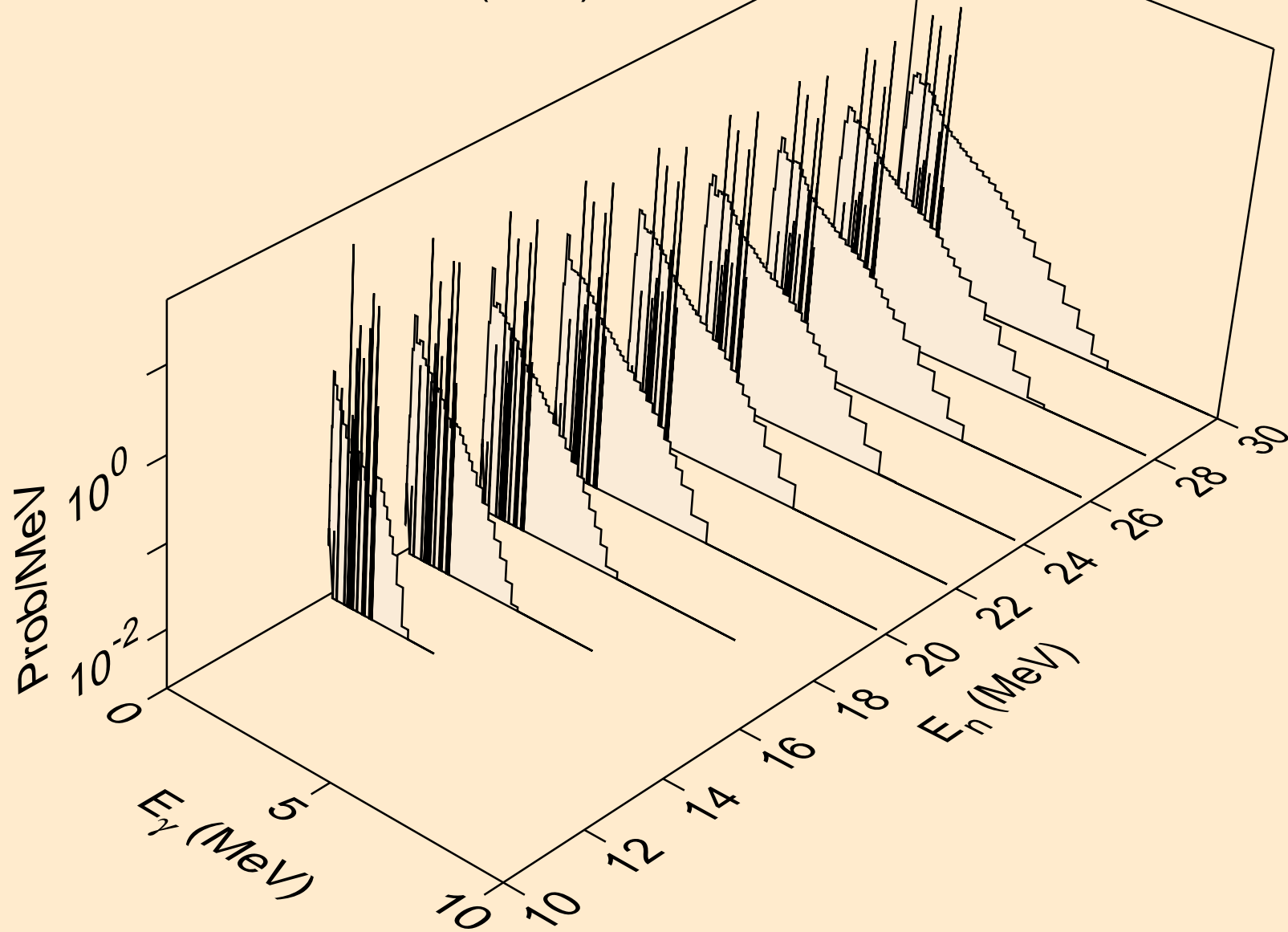

SN117M TRITON ACER TENDL-2021 LIBRARY; T=0.K  
Photon emission for (n,n\*)a

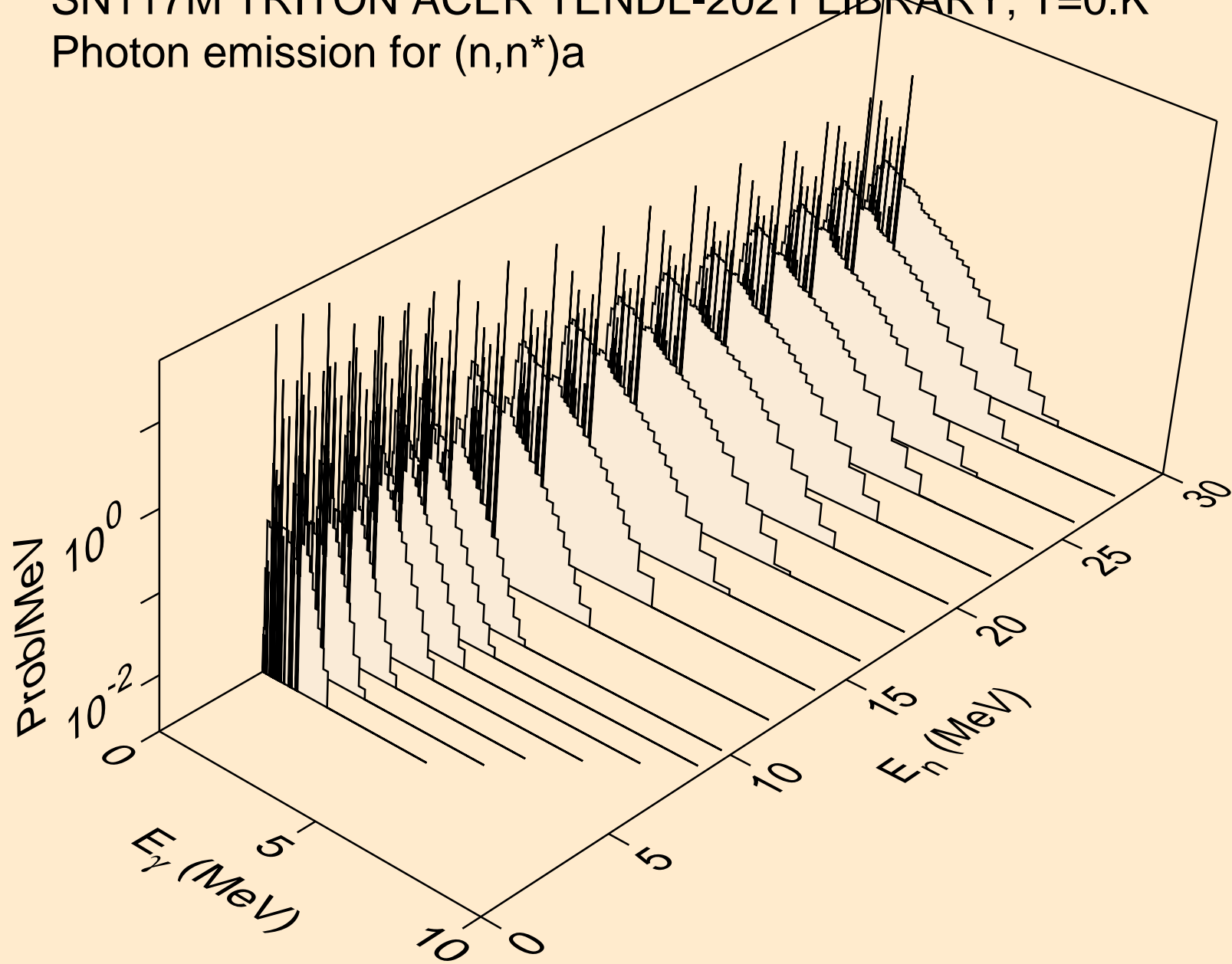

SN117M TRITON ACER TENDL-2021 LIBRARY; T=0.K  
Photon emission for (n,2n)a

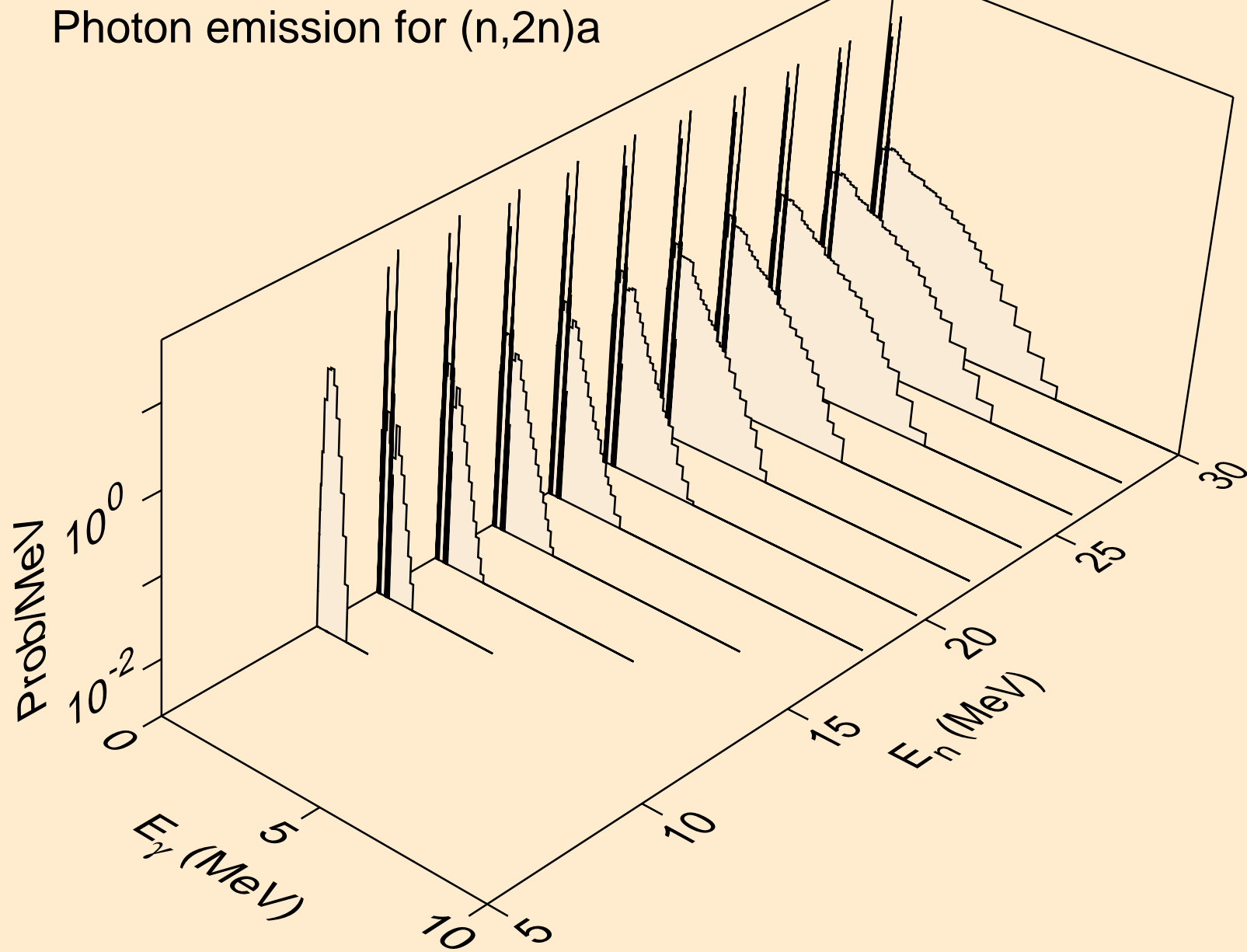

SN117M TRITON ACER TENDL-2021 LIBRARY; T=0.K  
Photon emission for (n,3n)a

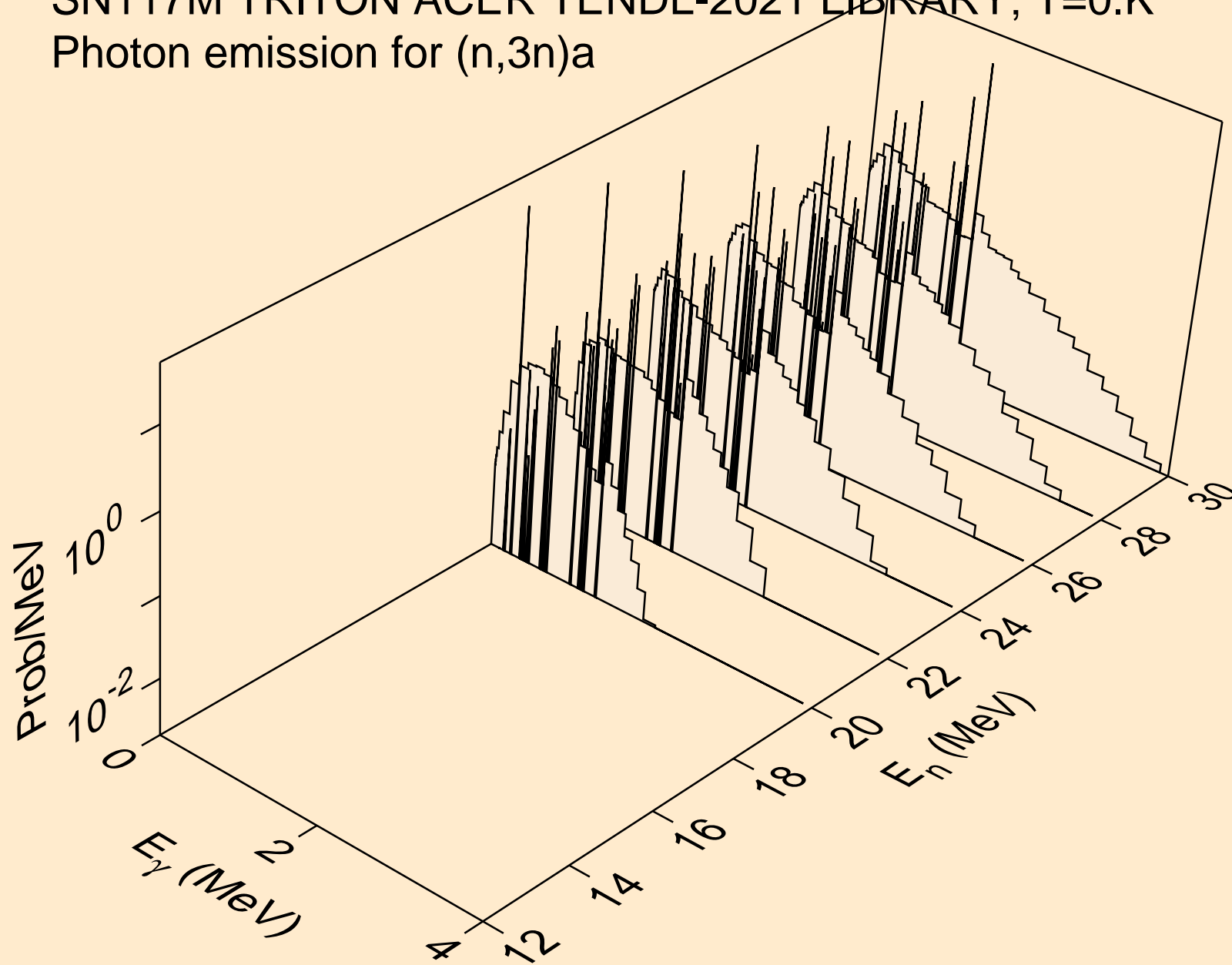

SN117M TRITON ACER TENDL-2021 LIBRARY; T=0.K  
Photon emission for (n,n\*)p

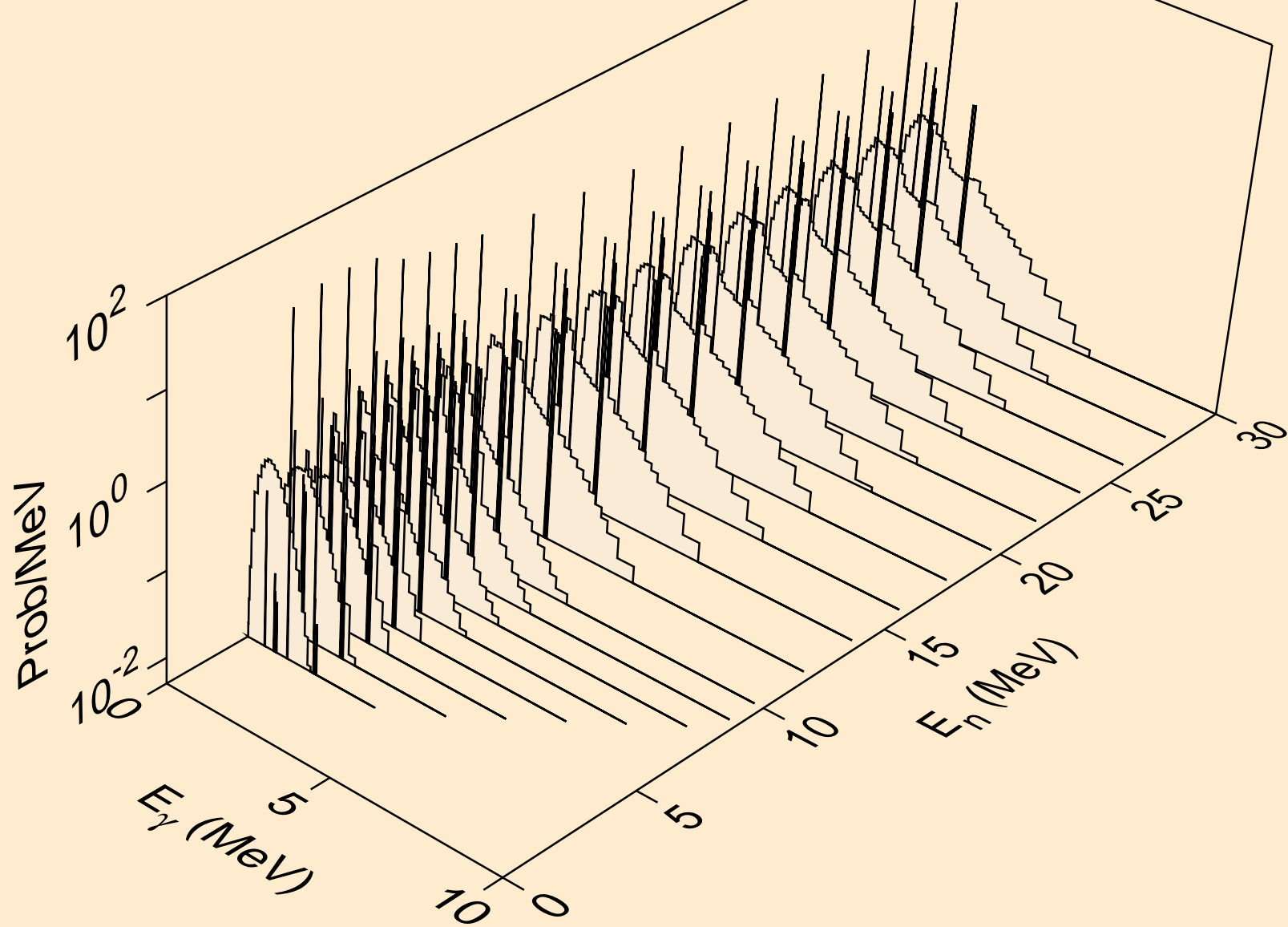

SN117M TRITON ACER TENDL-2021 LIBRARY; T=0.K  
Photon emission for (n,n\*)2a

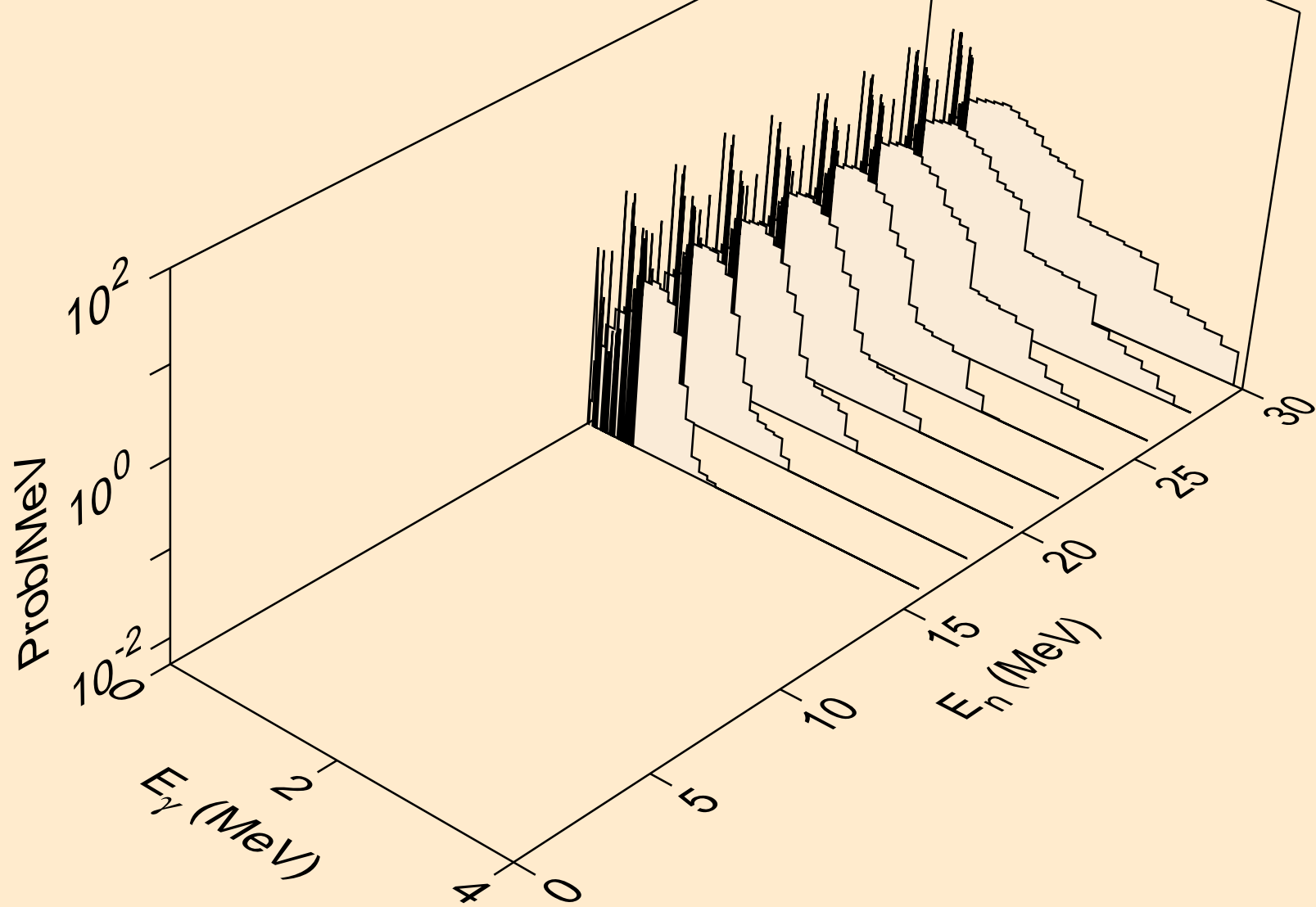

SN117M TRITON ACER TENDL-2021 LIBRARY; T=0.K  
Photon emission for (n,n\*)d

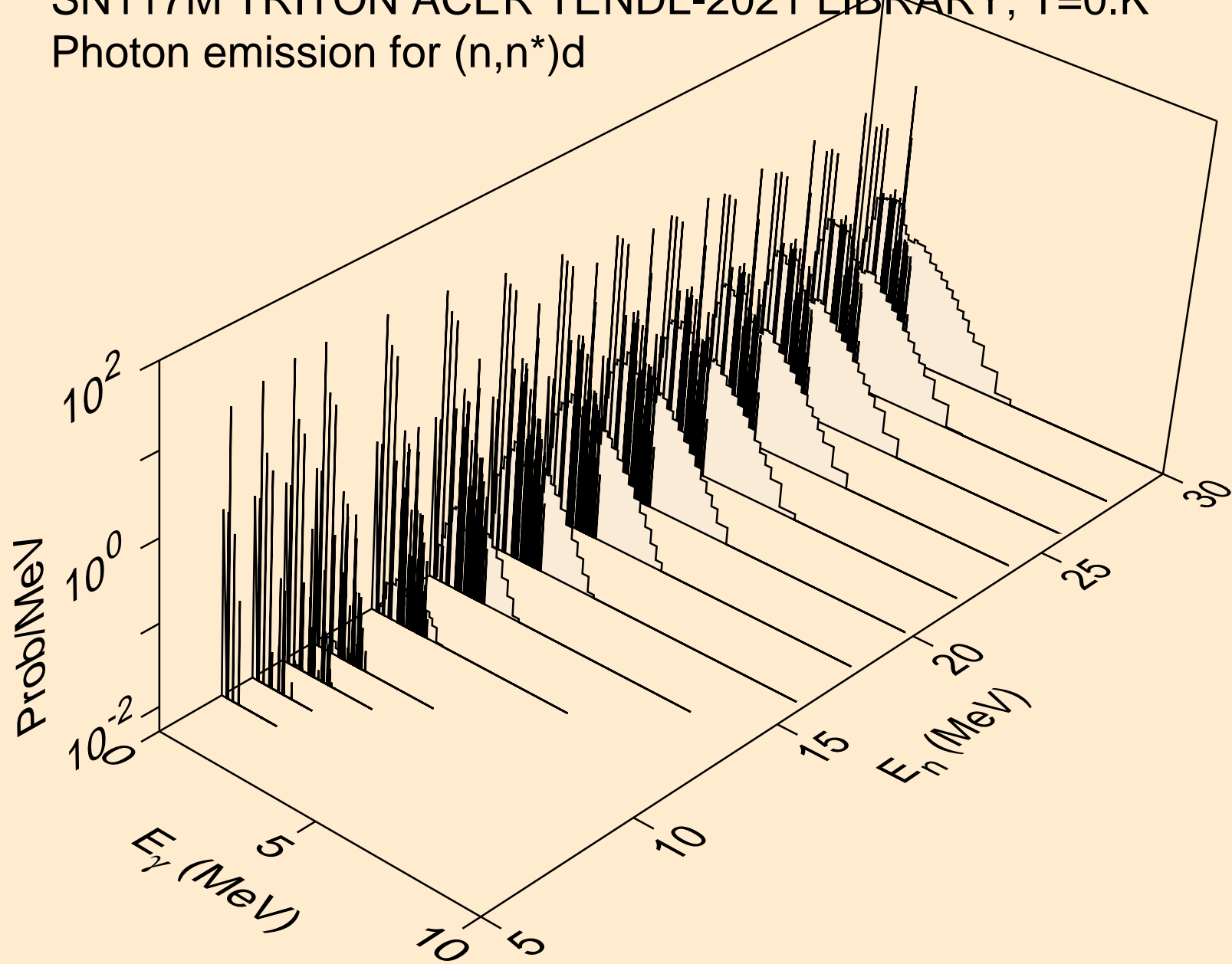



SN117M TRITON ACER TENDL-2021 LIBRARY; T=0.K  
Photon emission for (n,n\*)t

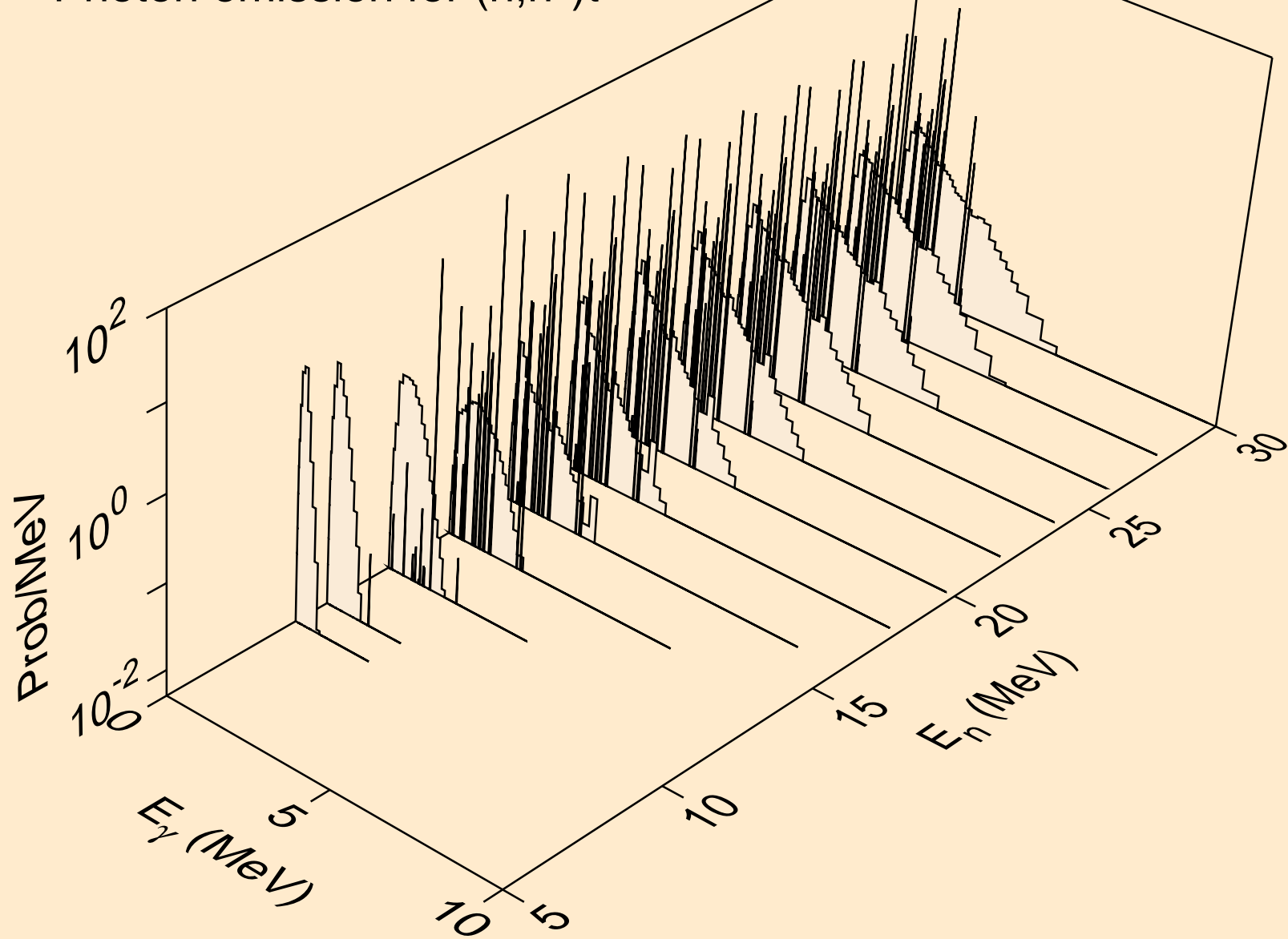

SN117M TRITON ACER TENDL-2021 LIBRARY; T=0.K  
Photon emission for (n,n\*)he3

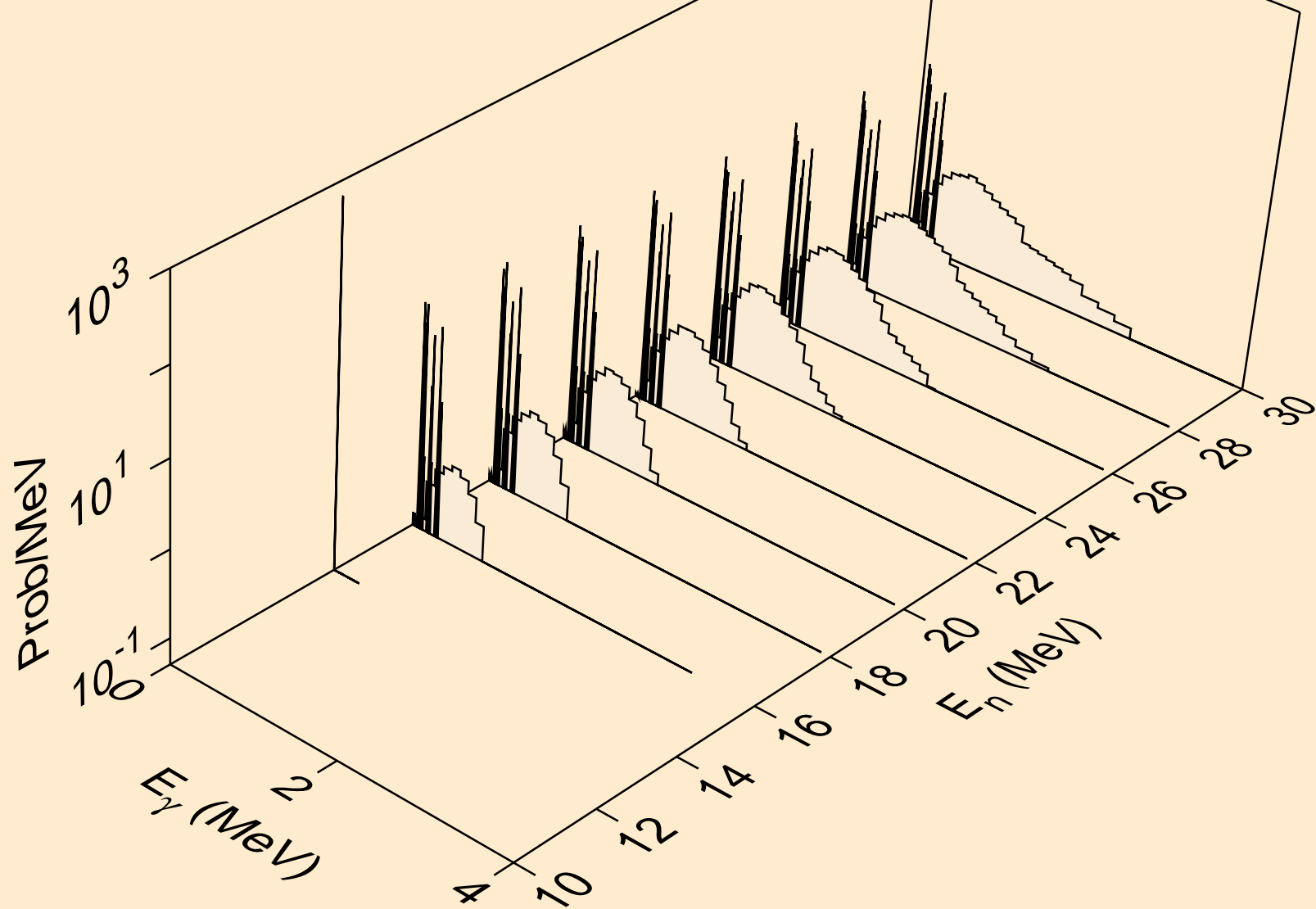

SN117M TRITON ACER TENDL-2021 LIBRARY; T=0.K  
Photon emission for (n,4n)

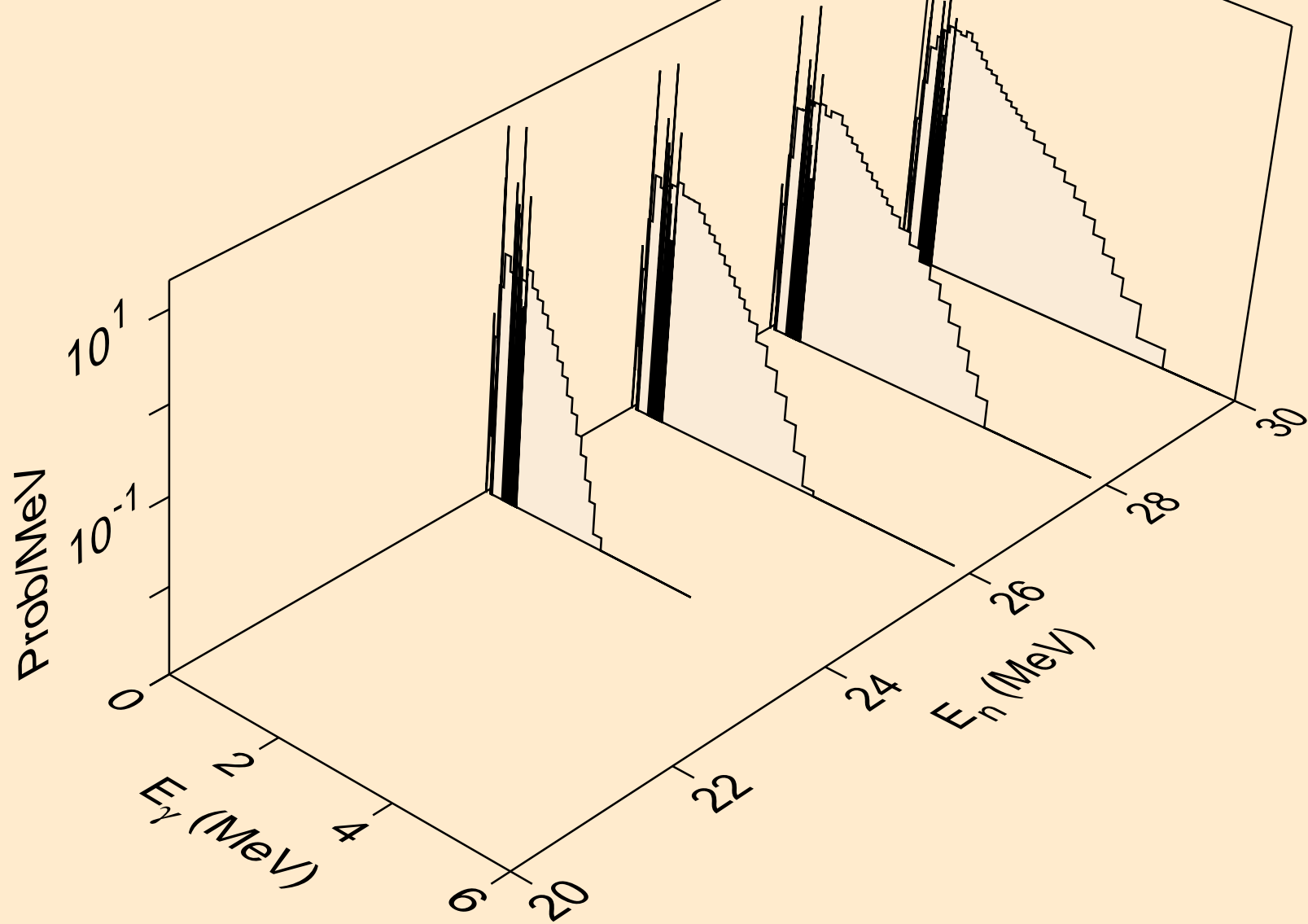

SN117M TRITON ACER TENDL-2021 LIBRARY; T=0.K  
Photon emission for (n,2np)

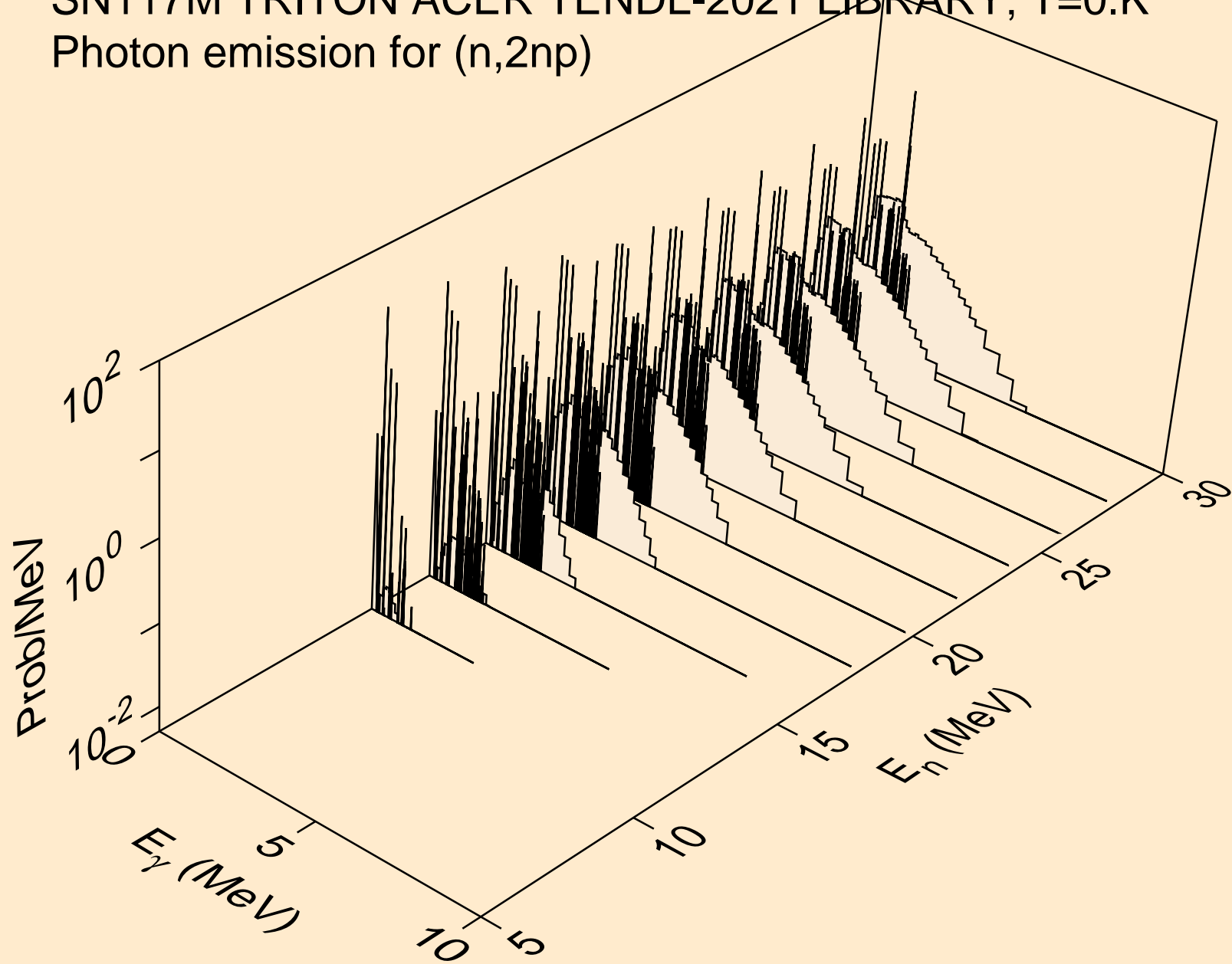

SN117M TRITON ACER TENDL-2021 LIBRARY; T=0.K  
Photon emission for (n,3np)

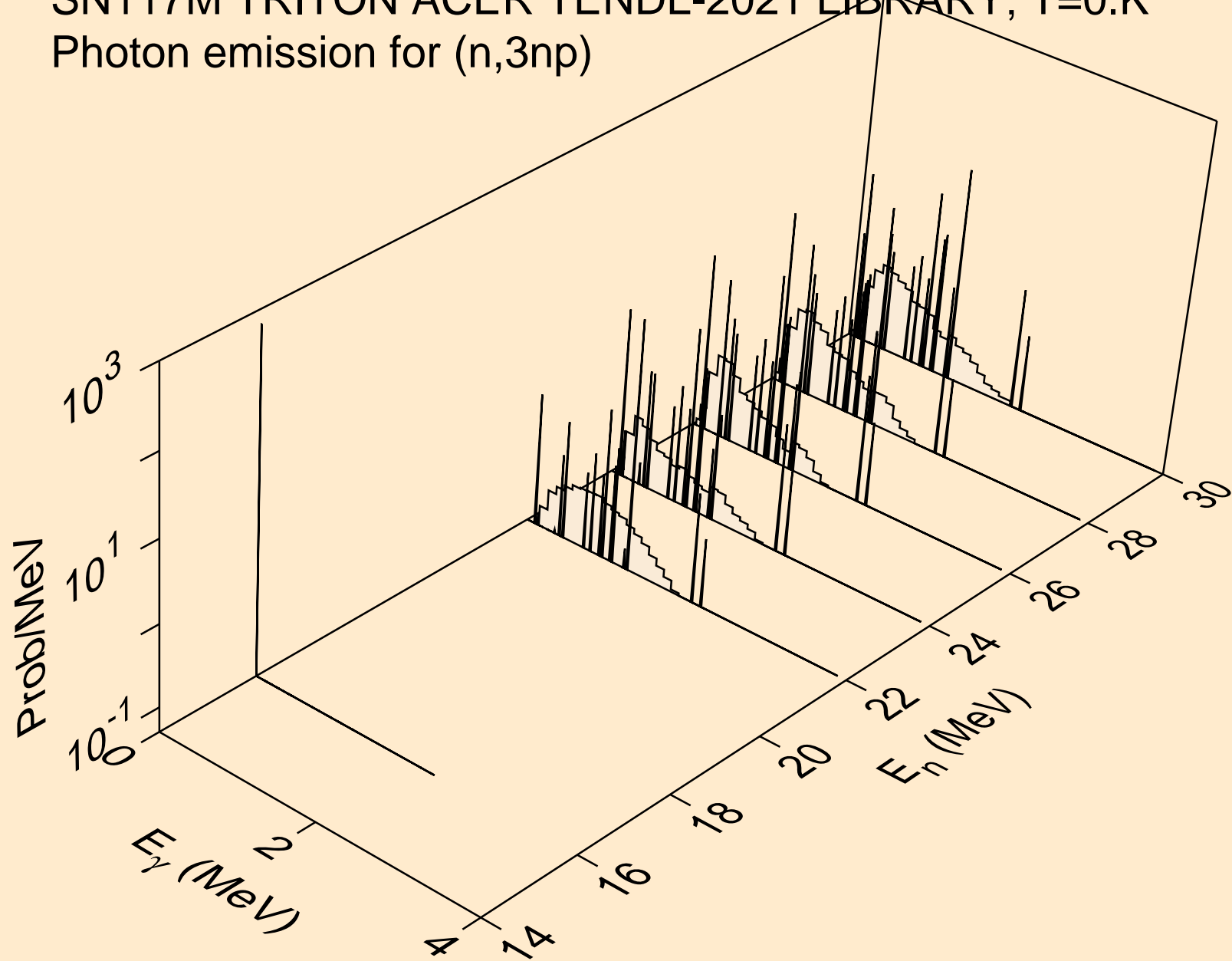

SN117M TRITON ACER TENDL-2021 LIBRARY; T=0.K  
Photon emission for (n,2np)

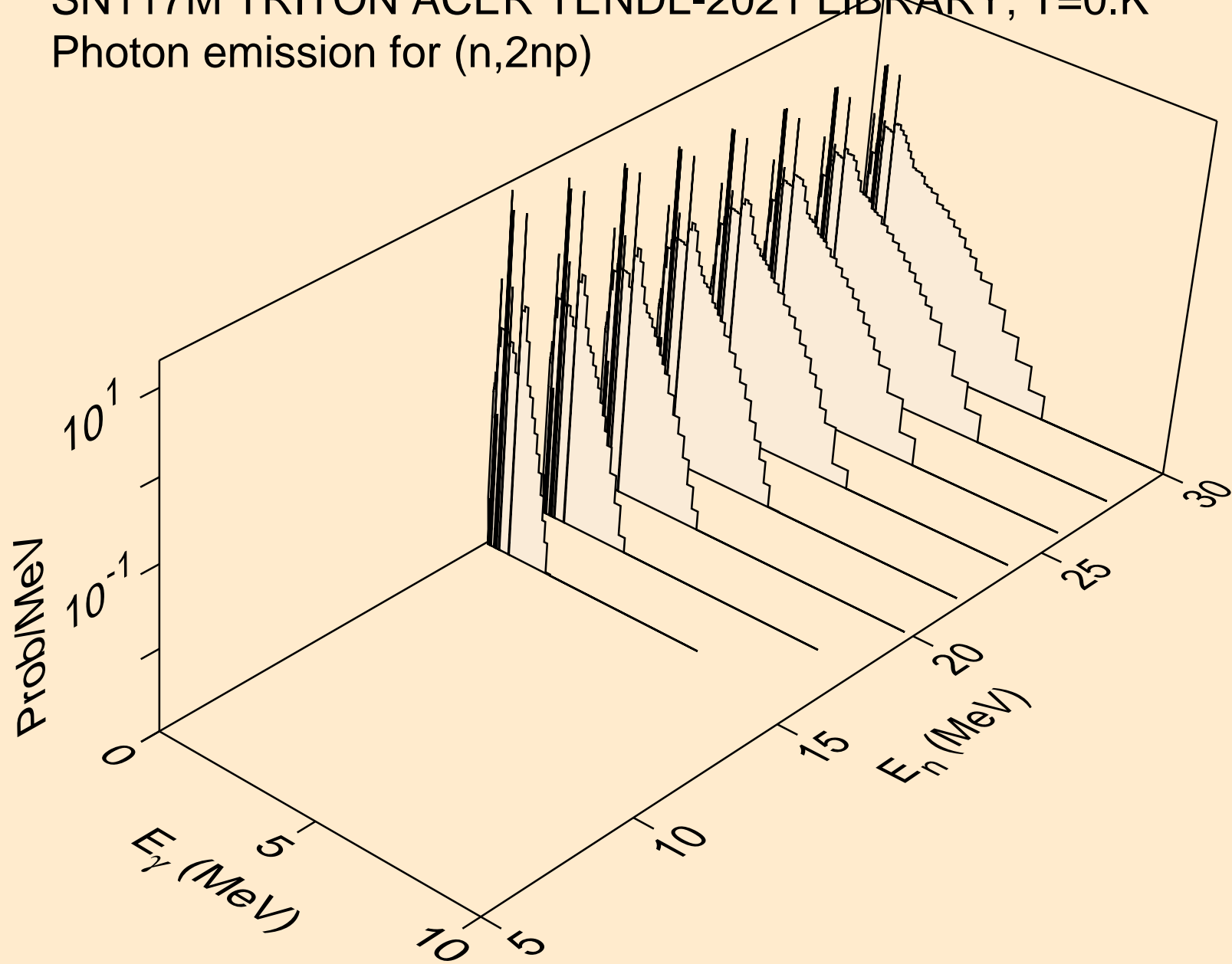

SN117M TRITON ACER TENDL-2021 LIBRARY; T=0.K  
Photon emission for (n,npa)

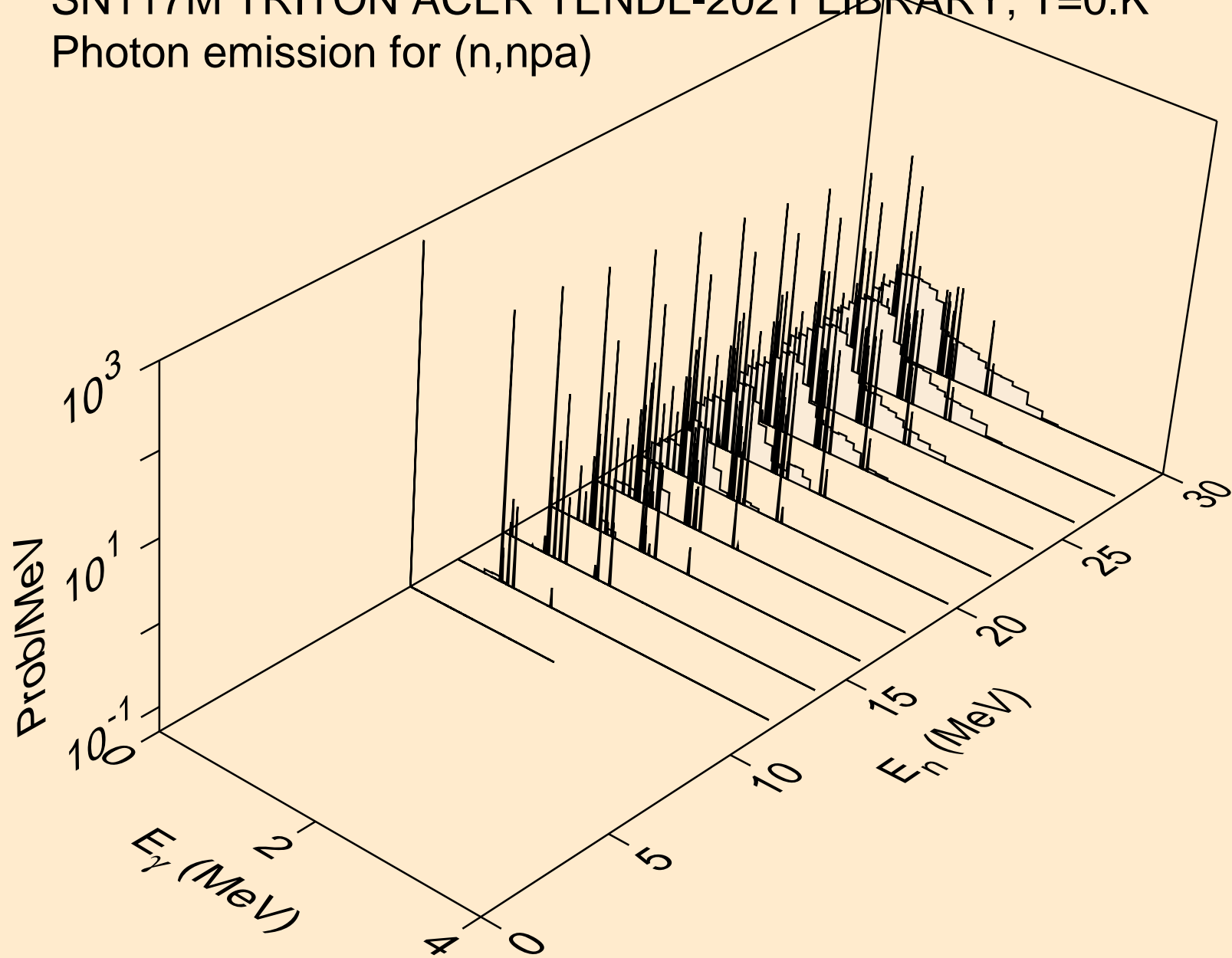

SN117M TRITON ACER TENDL-2021 LIBRARY; T=0.K  
Photon emission for (n,gma)

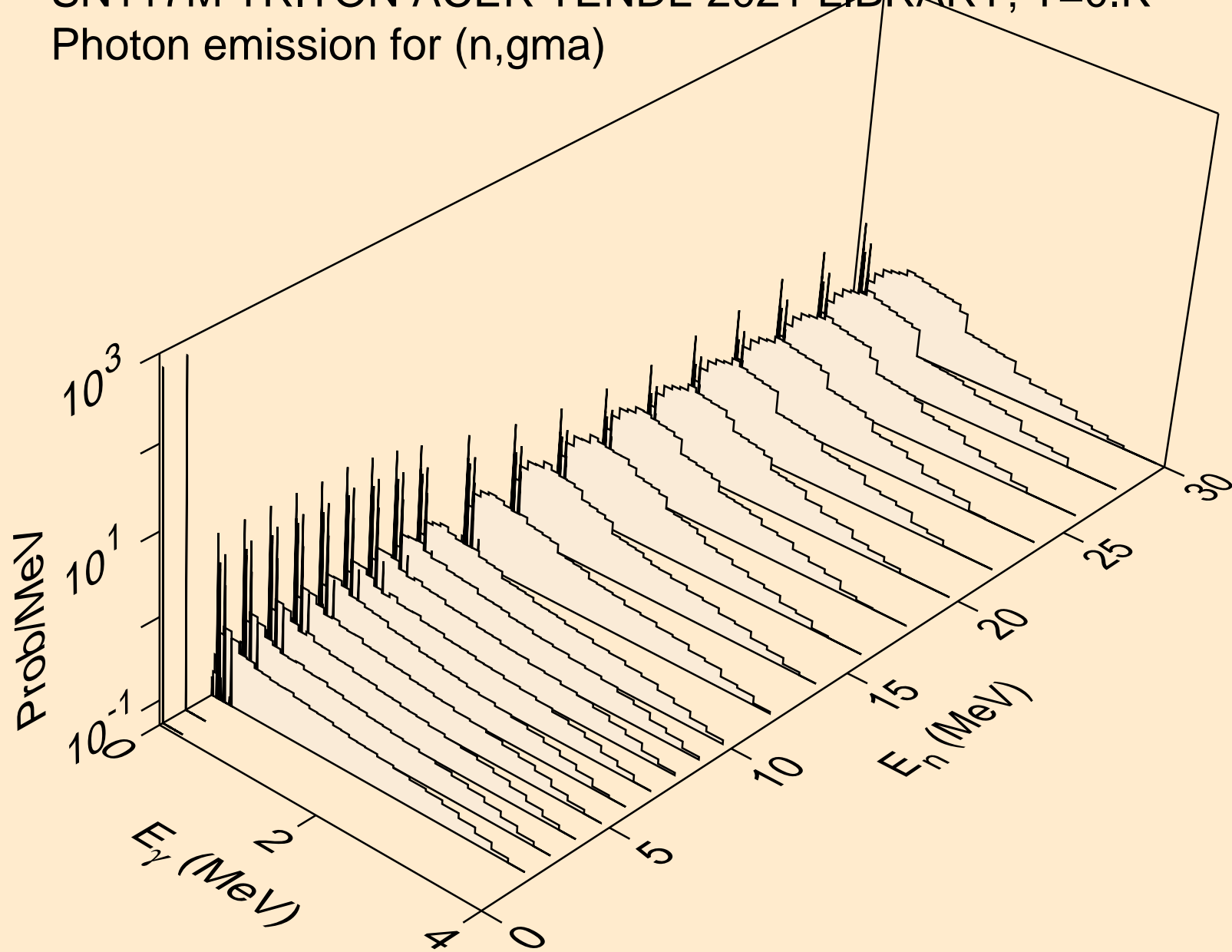



SN117M TRITON ACER TENDL-2021 LIBRARY; T=0.K  
Photon emission for (n,p)

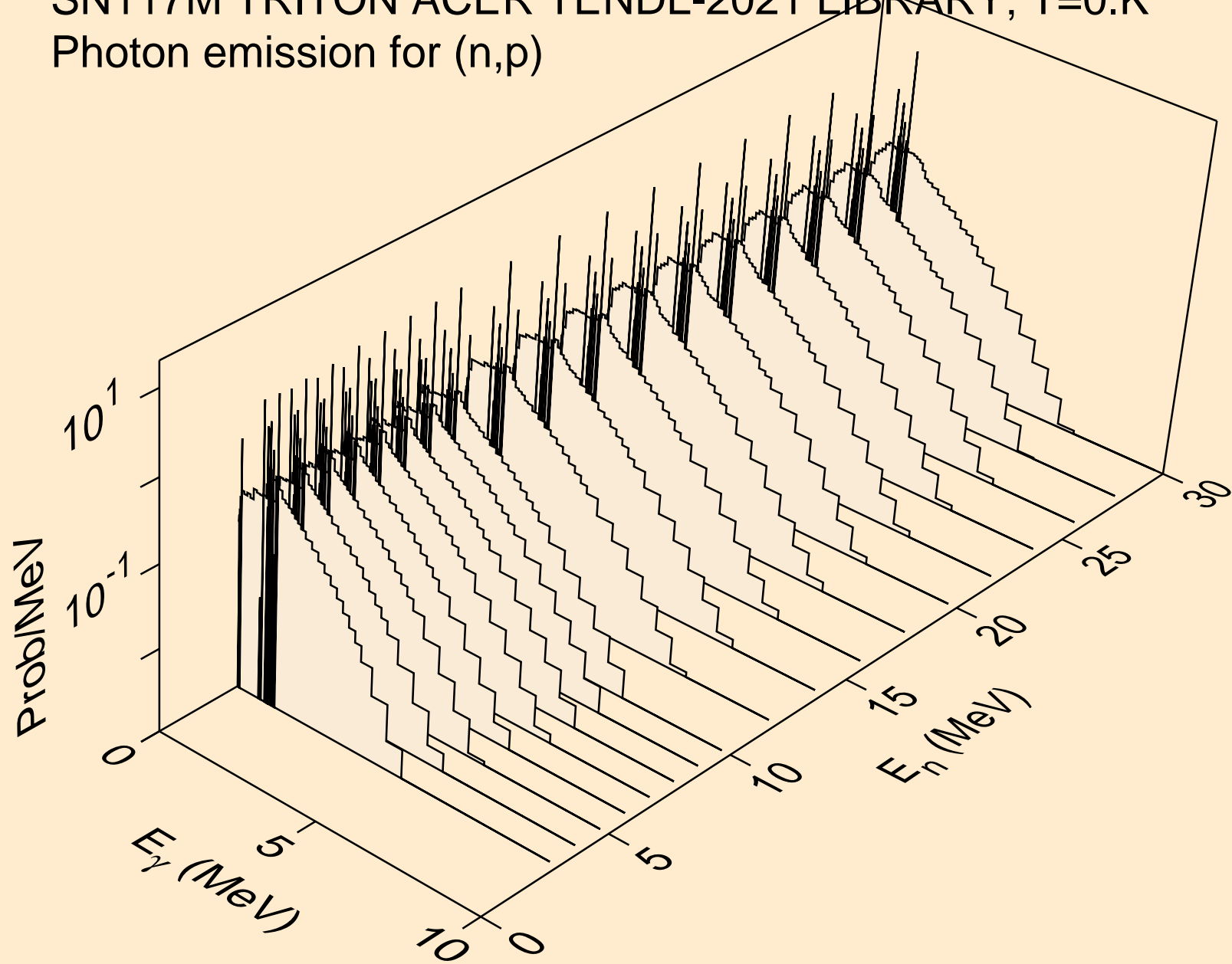

SN117M TRITON ACER TENDL-2021 LIBRARY; T=0.K  
Photon emission for (n,d)

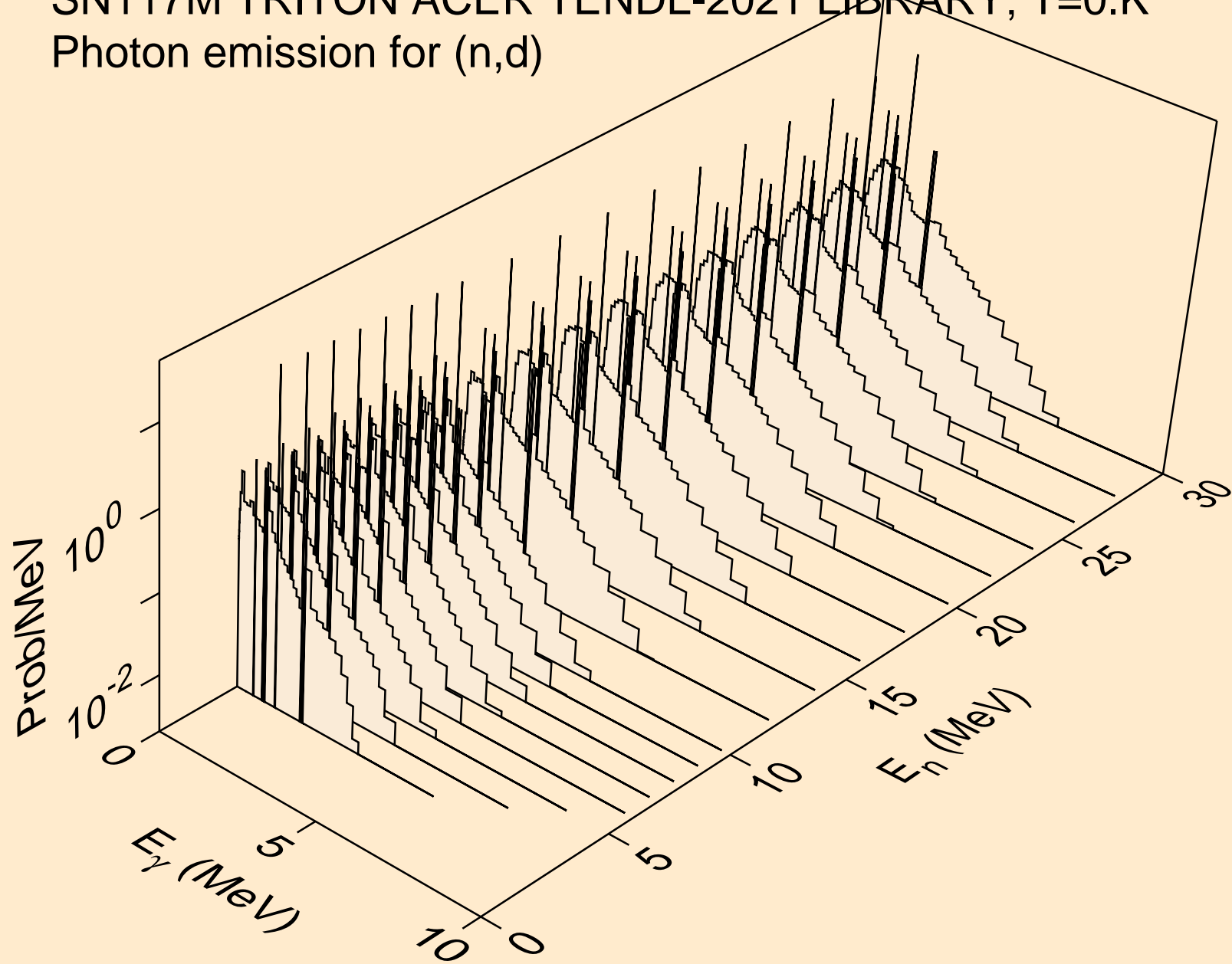

SN117M TRITON ACER TENDL-2021 LIBRARY; T=0.K  
Photon emission for inelastic

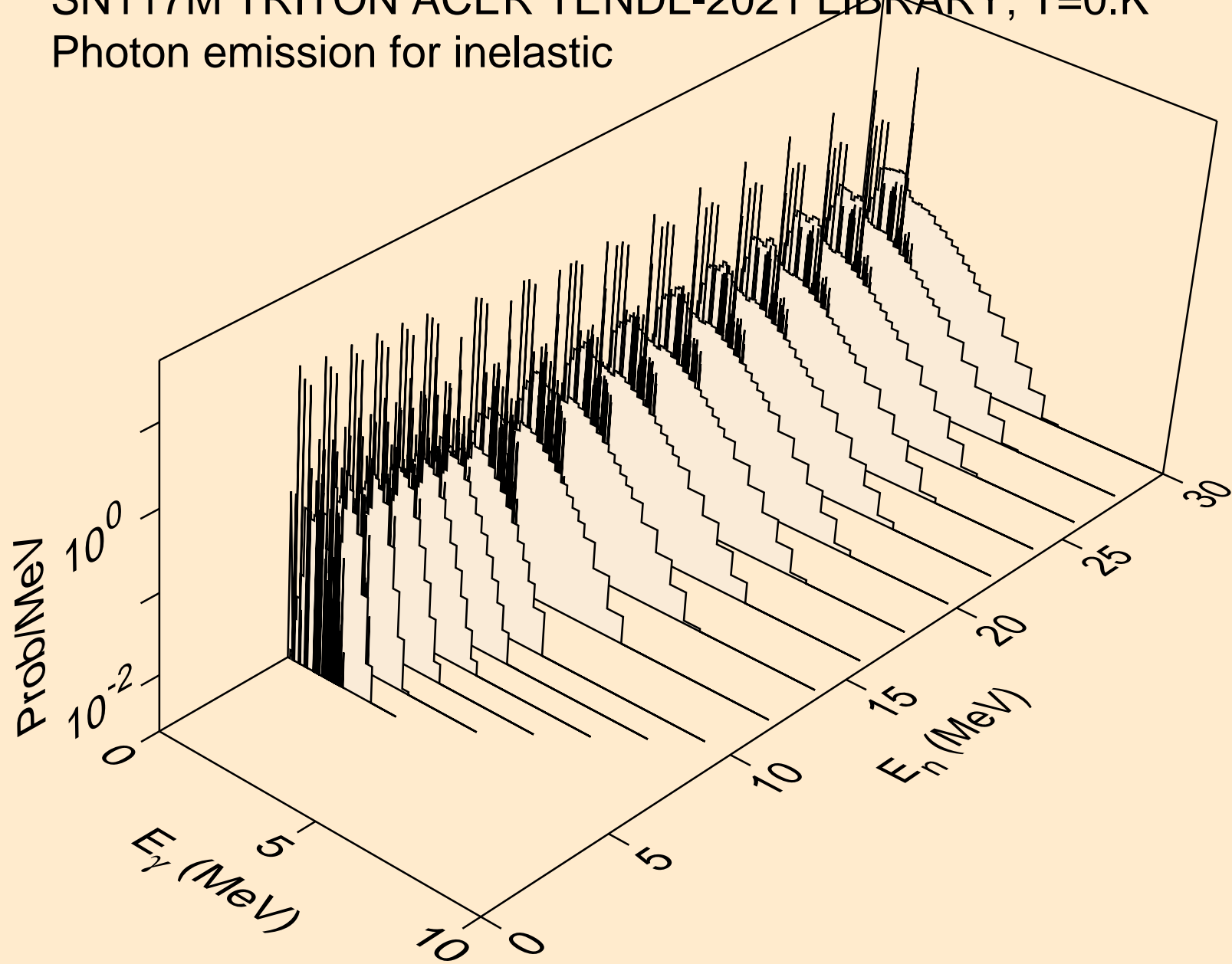

SN117M TRITON ACER TENDL-2021 LIBRARY; T=0.K  
Photon emission for (n,he3)

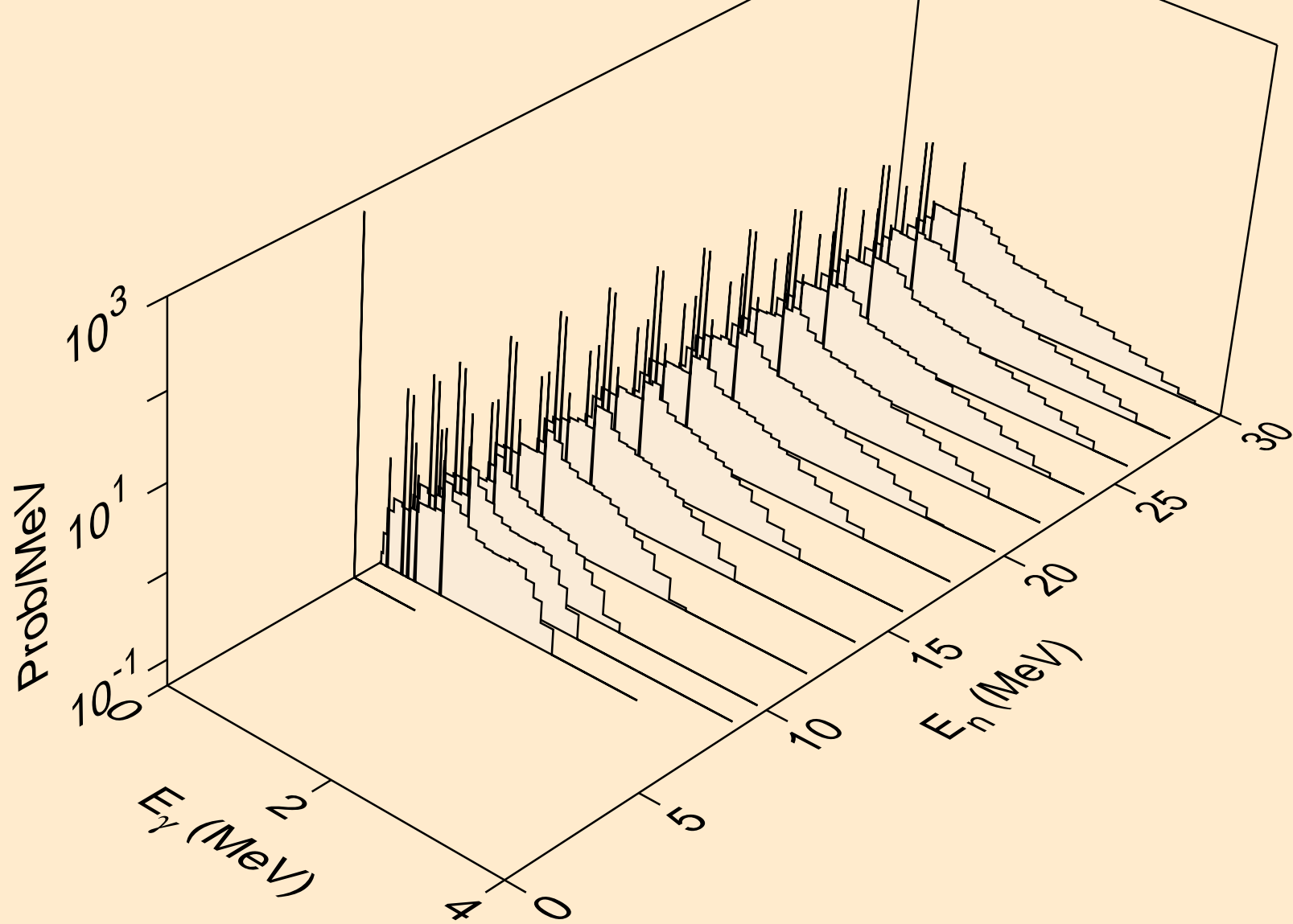

SN117M TRITON ACER TENDL-2021 LIBRARY; T=0.K  
Photon emission for (n,a)

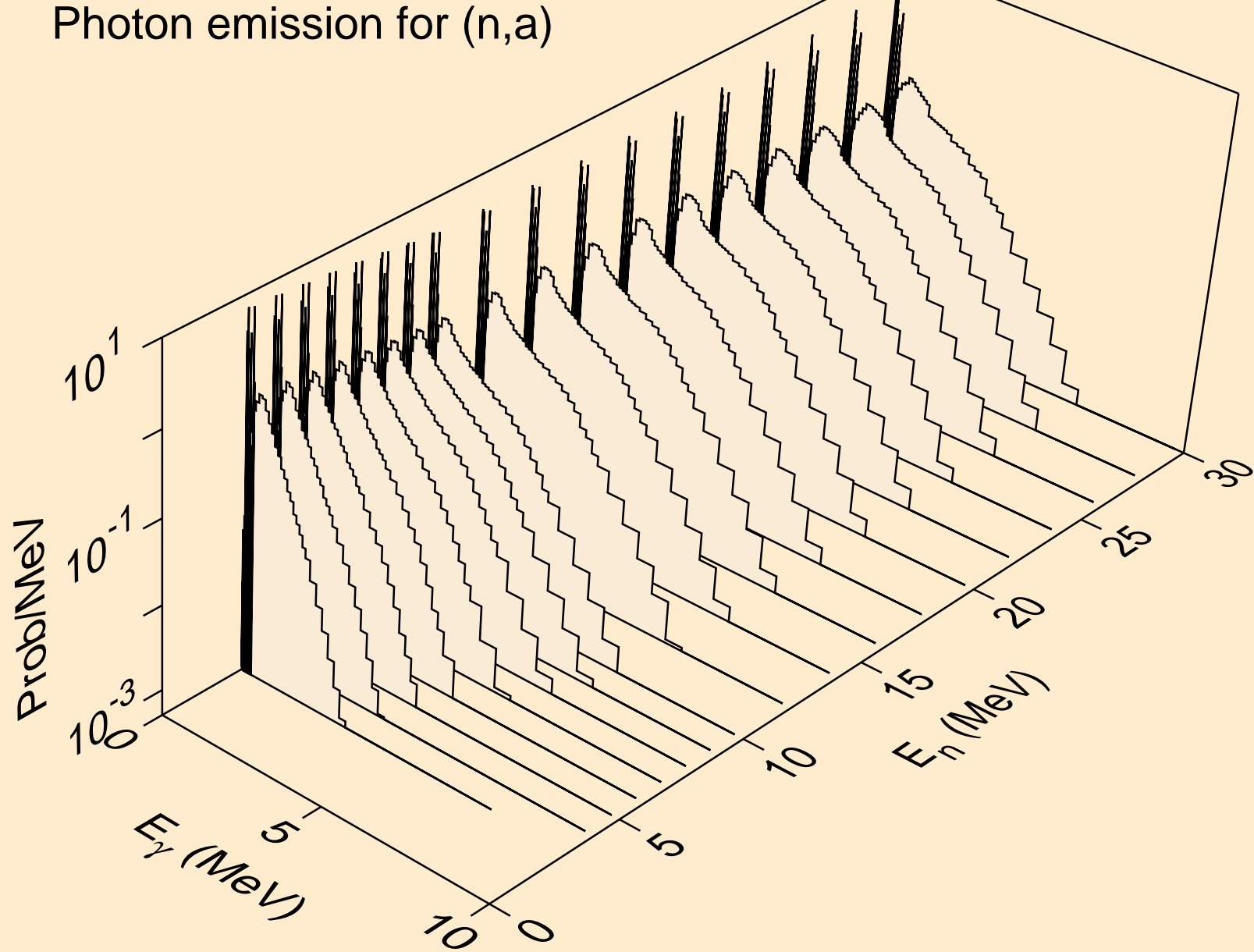

SN117M TRITON ACER TENDL-2021 LIBRARY; T=0.K  
Photon emission for (n,2a)

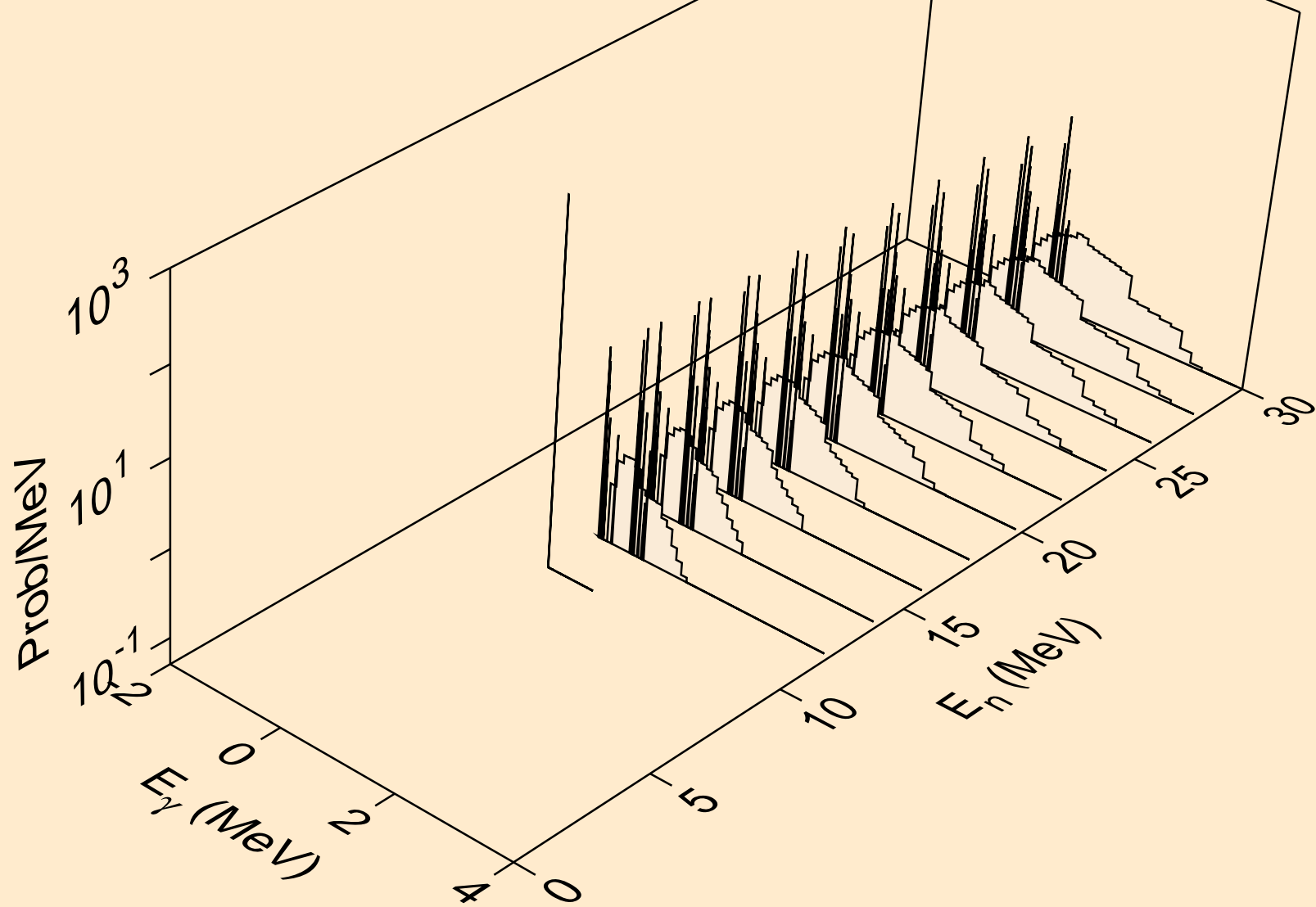

SN117M TRITON ACER TENDL-2021 LIBRARY; T=0.K  
Photon emission for (n,2p)

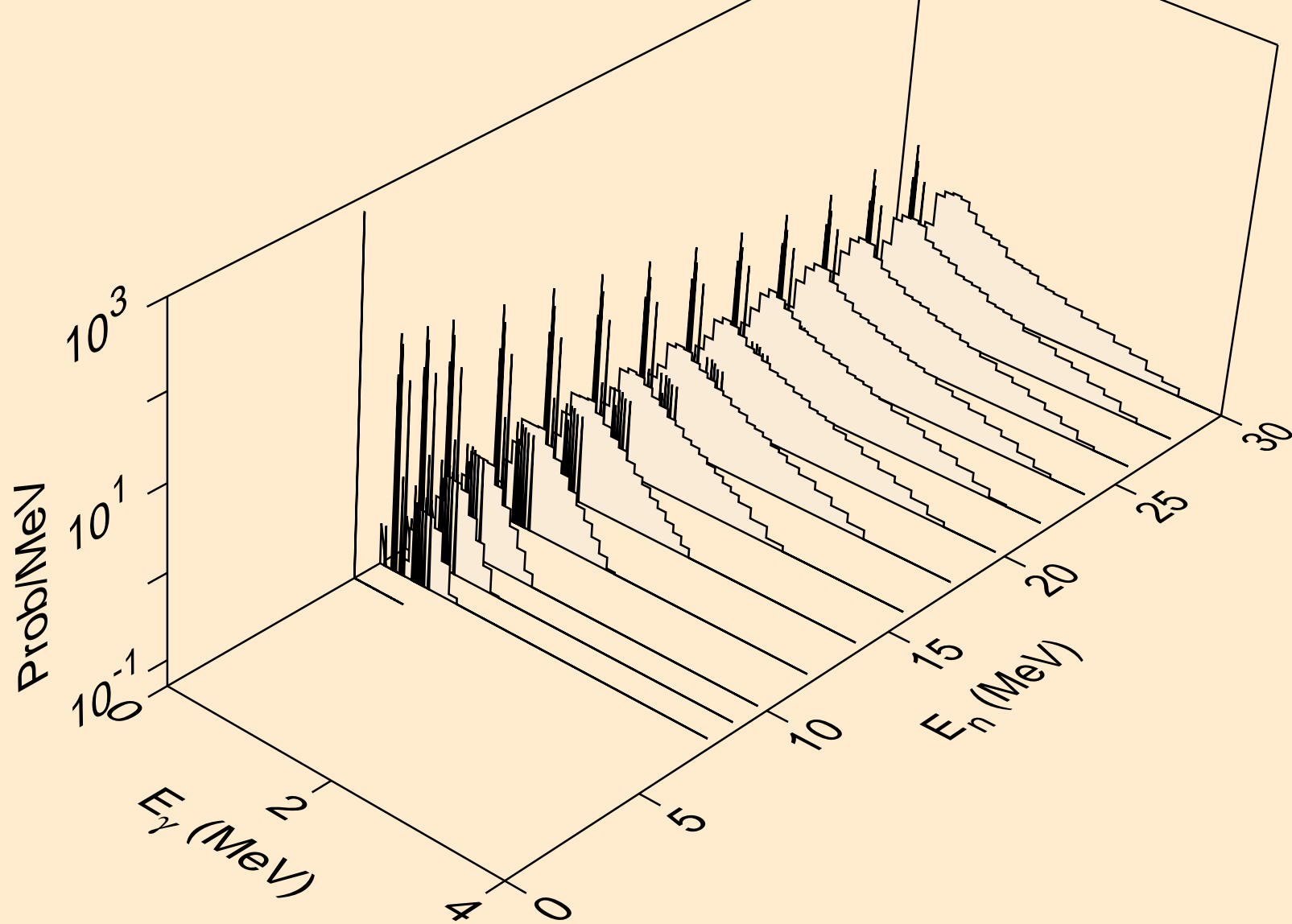

SN117M TRITON ACER TENDL-2021 LIBRARY; T=0.K  
Photon emission for (n,pa)

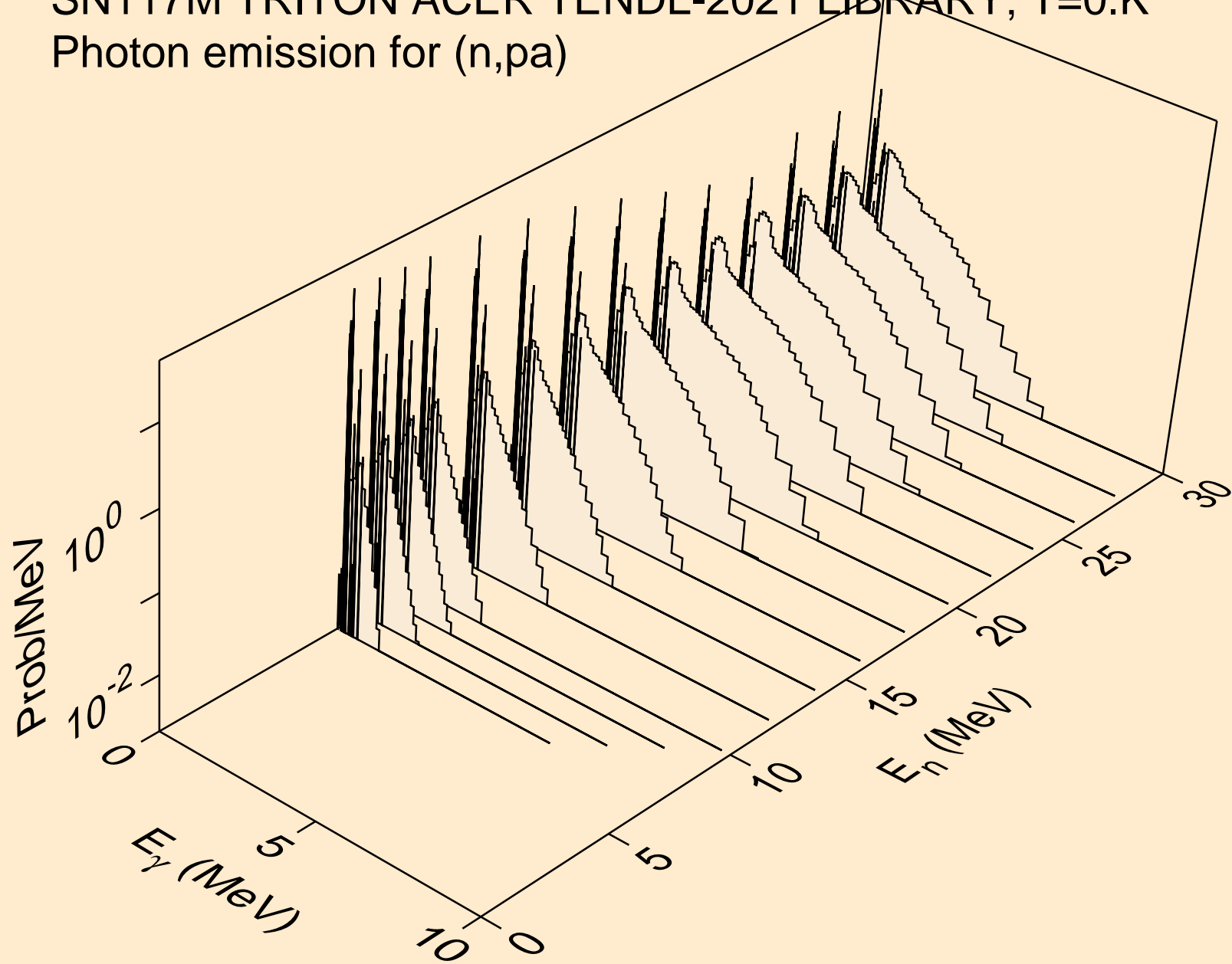



SN117M TRITON ACER TENDL-2021 LIBRARY; T=0.K  
Photon emission for (n,pd)

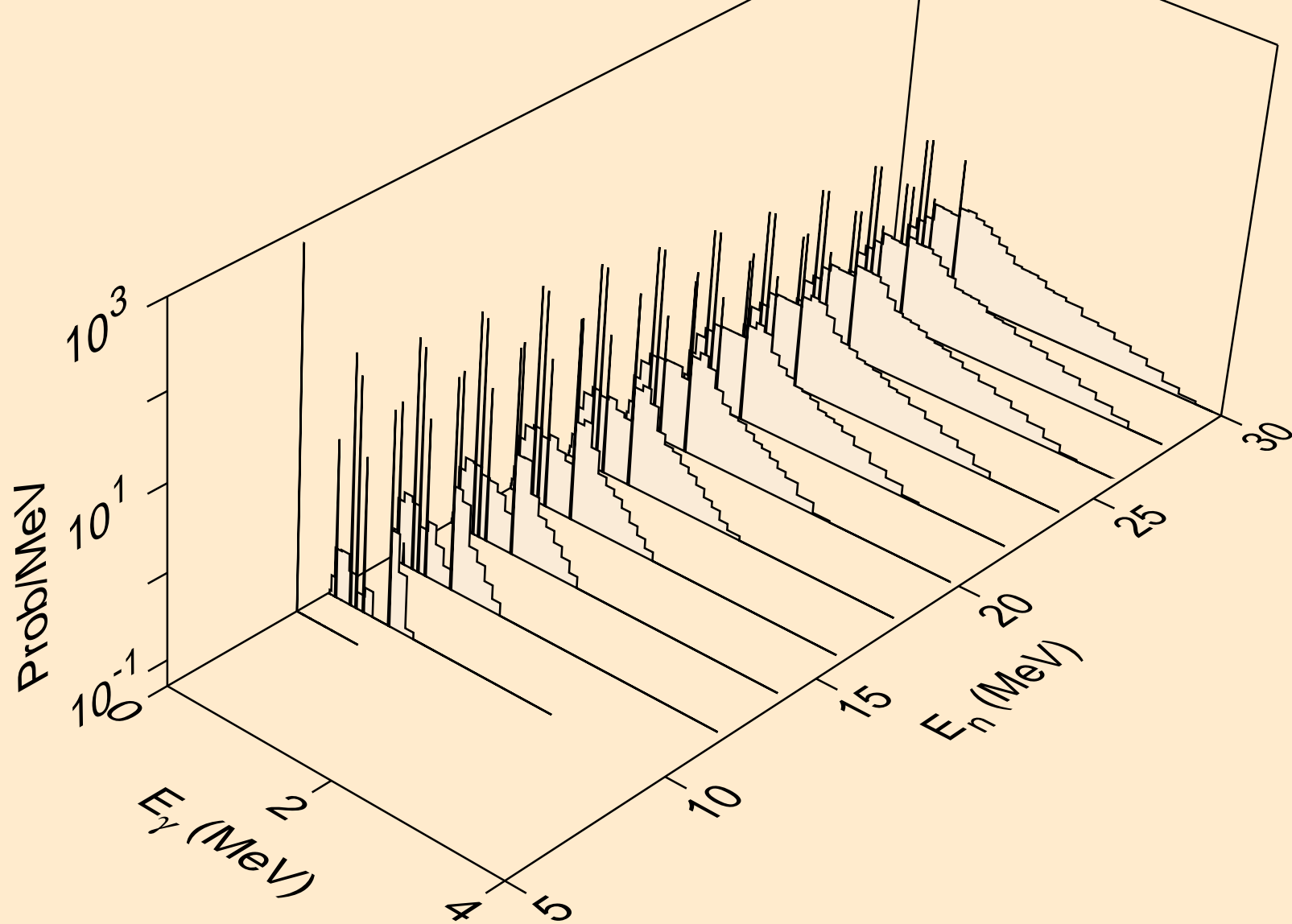

SN117M TRITON ACER TENDL-2021 LIBRARY; T=0.K  
Photon emission for (n,pt)

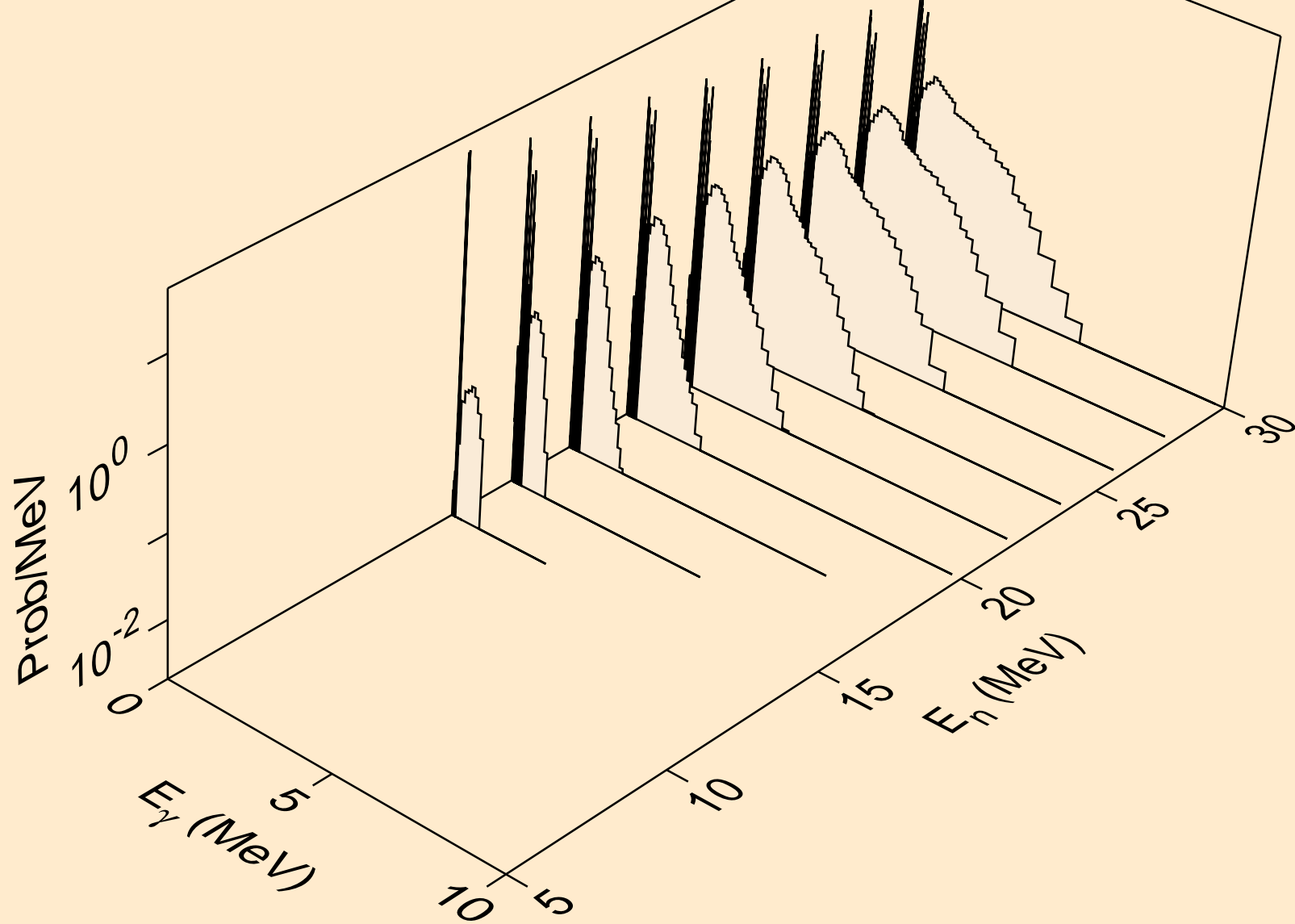

SN117M TRITON ACER TENDL-2021 LIBRARY; T=0.K  
Photon emission for (n,da)

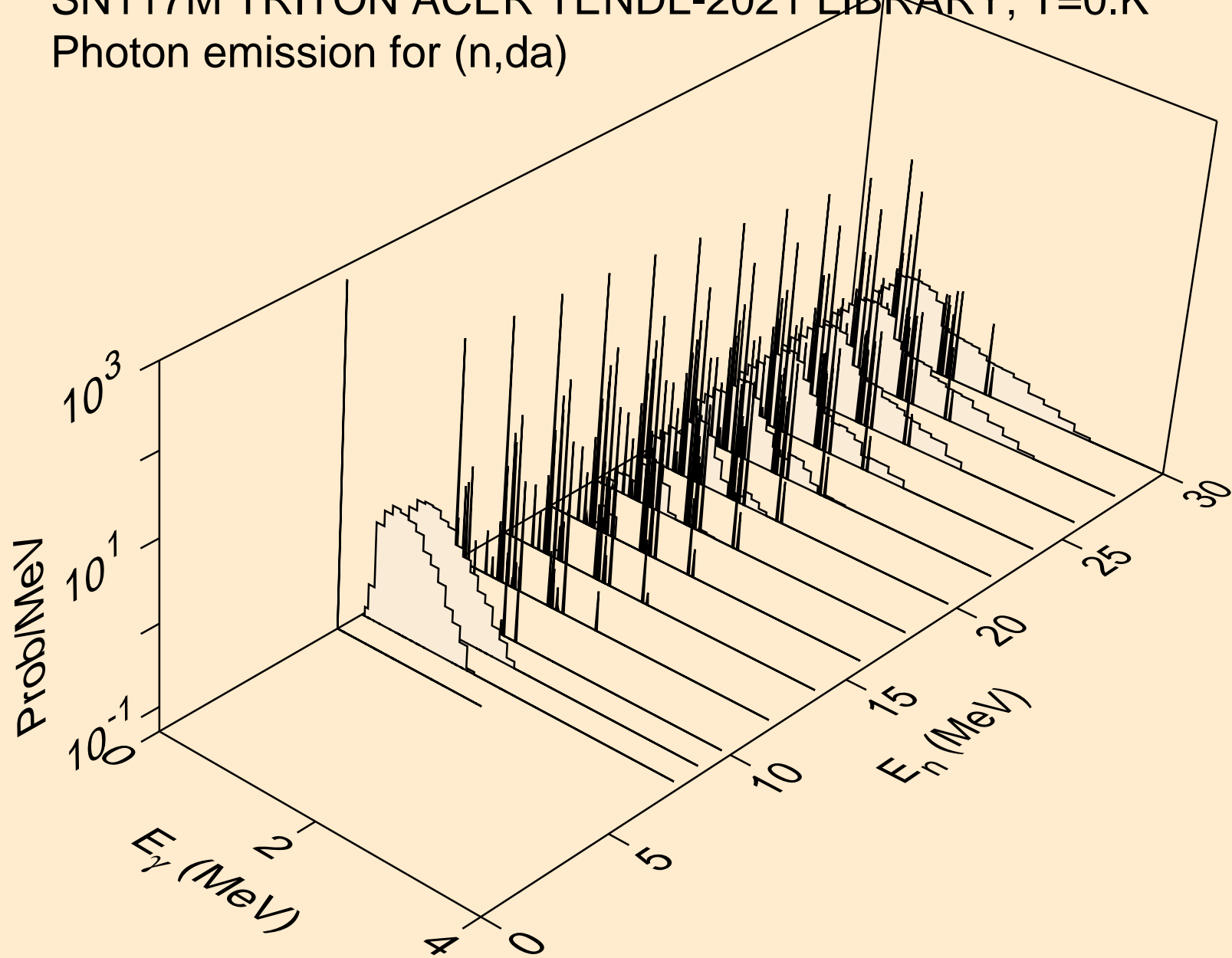

# SN117M TRITON ACER TENDL-2021 LIBRARY; T=0.K

## Particle heating contributions

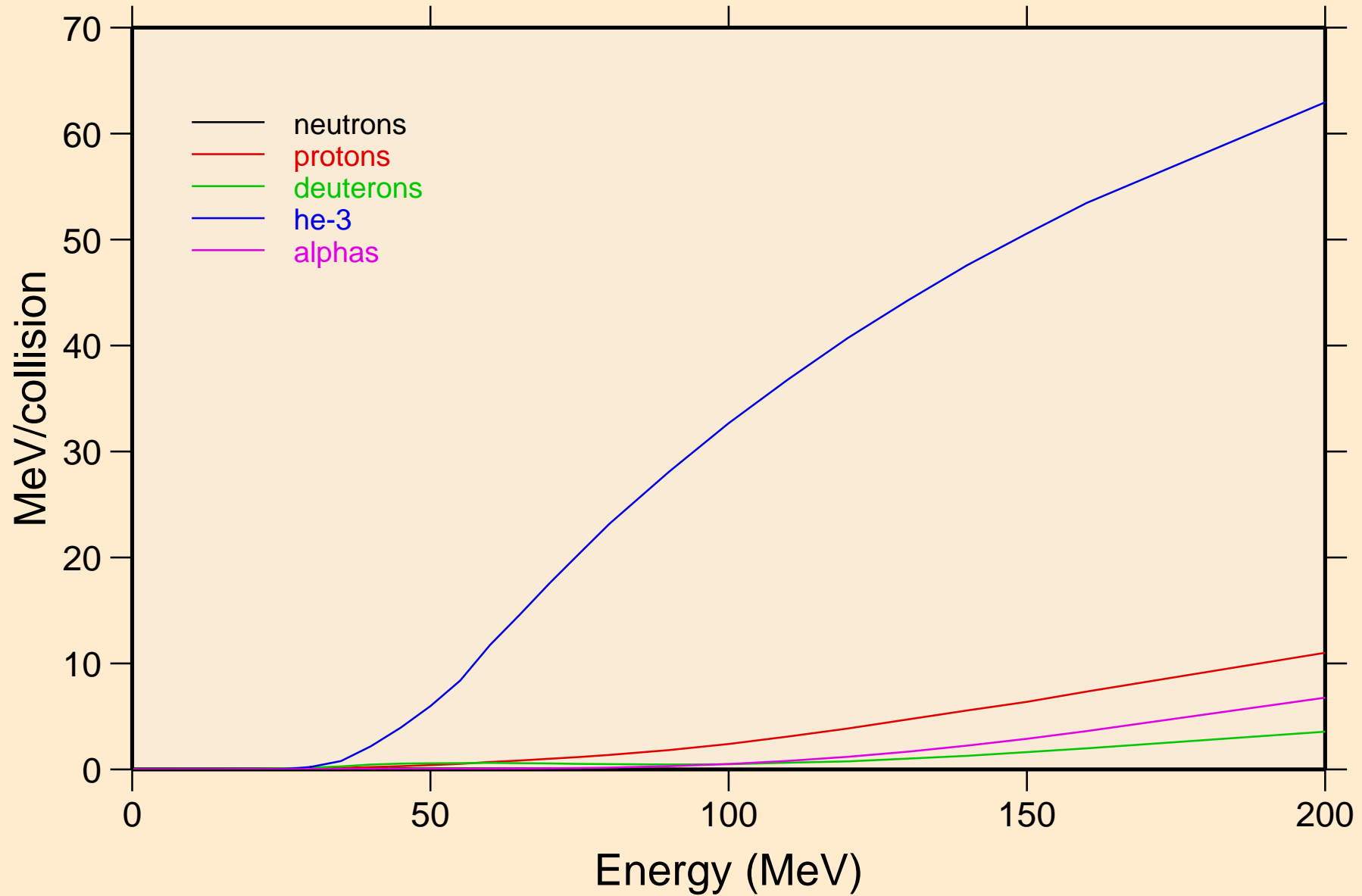

SN117M TRITON ACER TENDL-2021 LIBRARY; T=0.K  
Recoil Heating

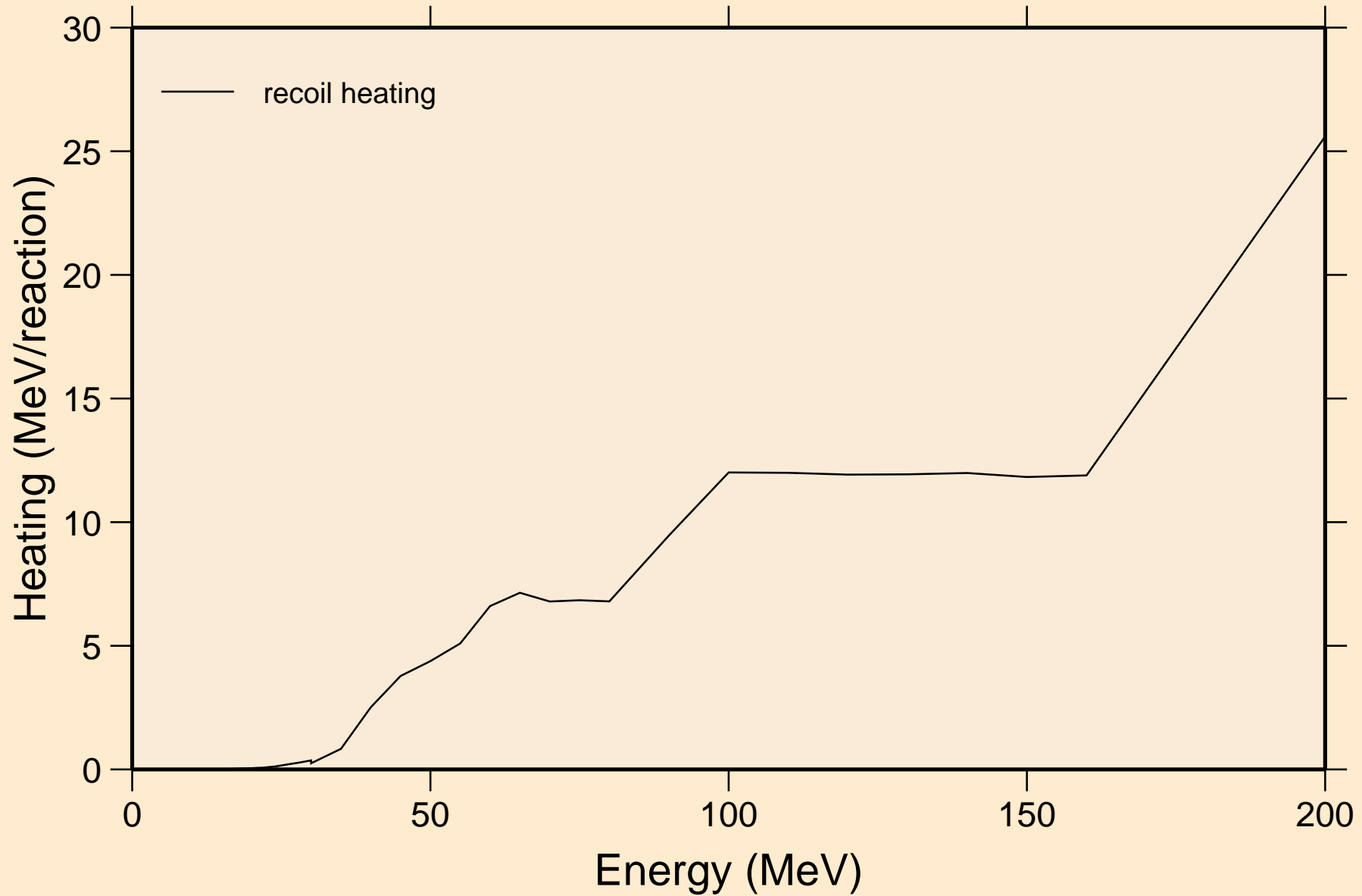

# SN117M TRITON ACER TENDL-2021 LIBRARY; T=0.K

## Particle production cross sections

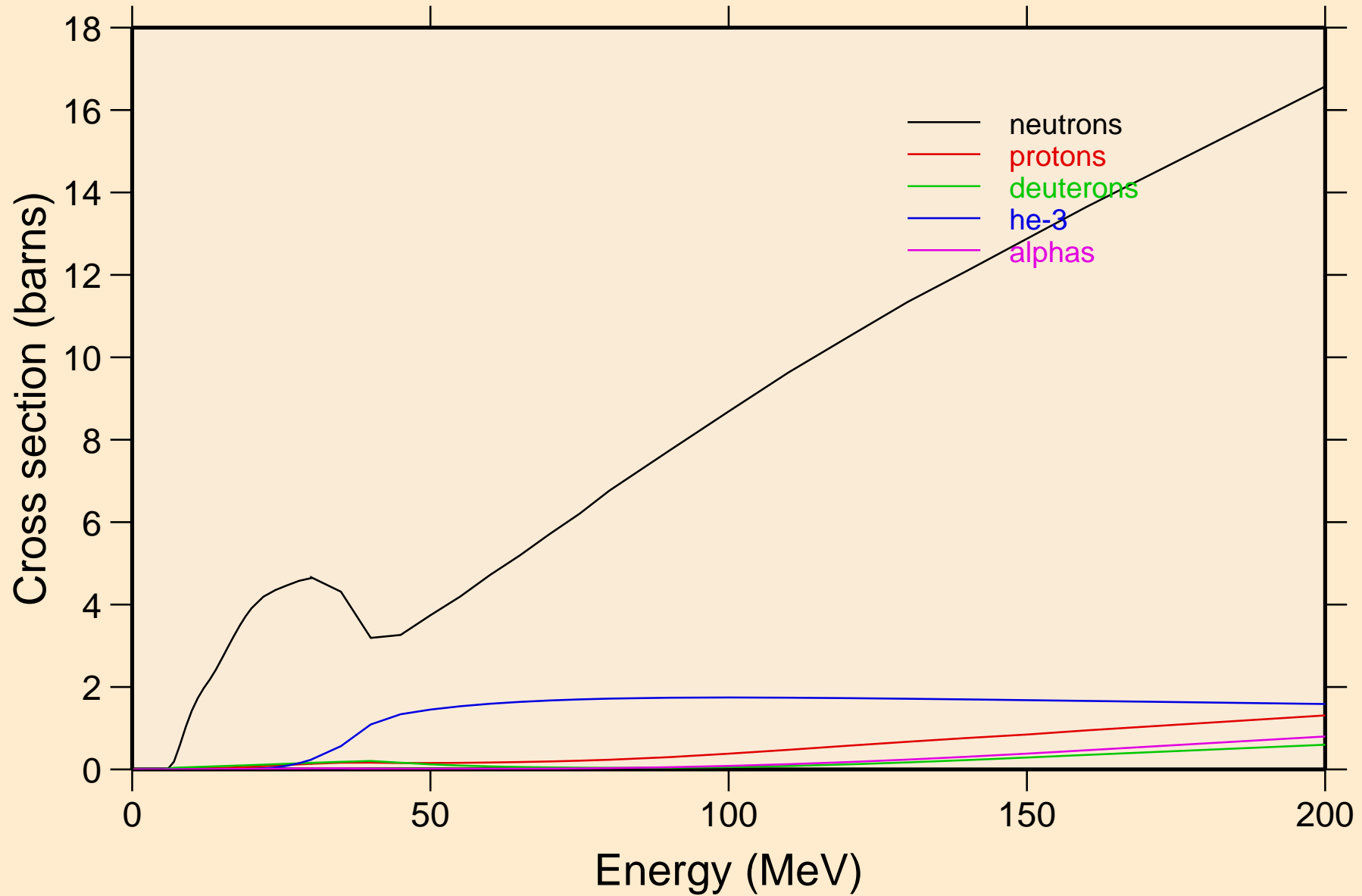

SN117M TRITON ACER TENDL-2021 LIBRARY; T=0.K  
neutrons from (t,n)

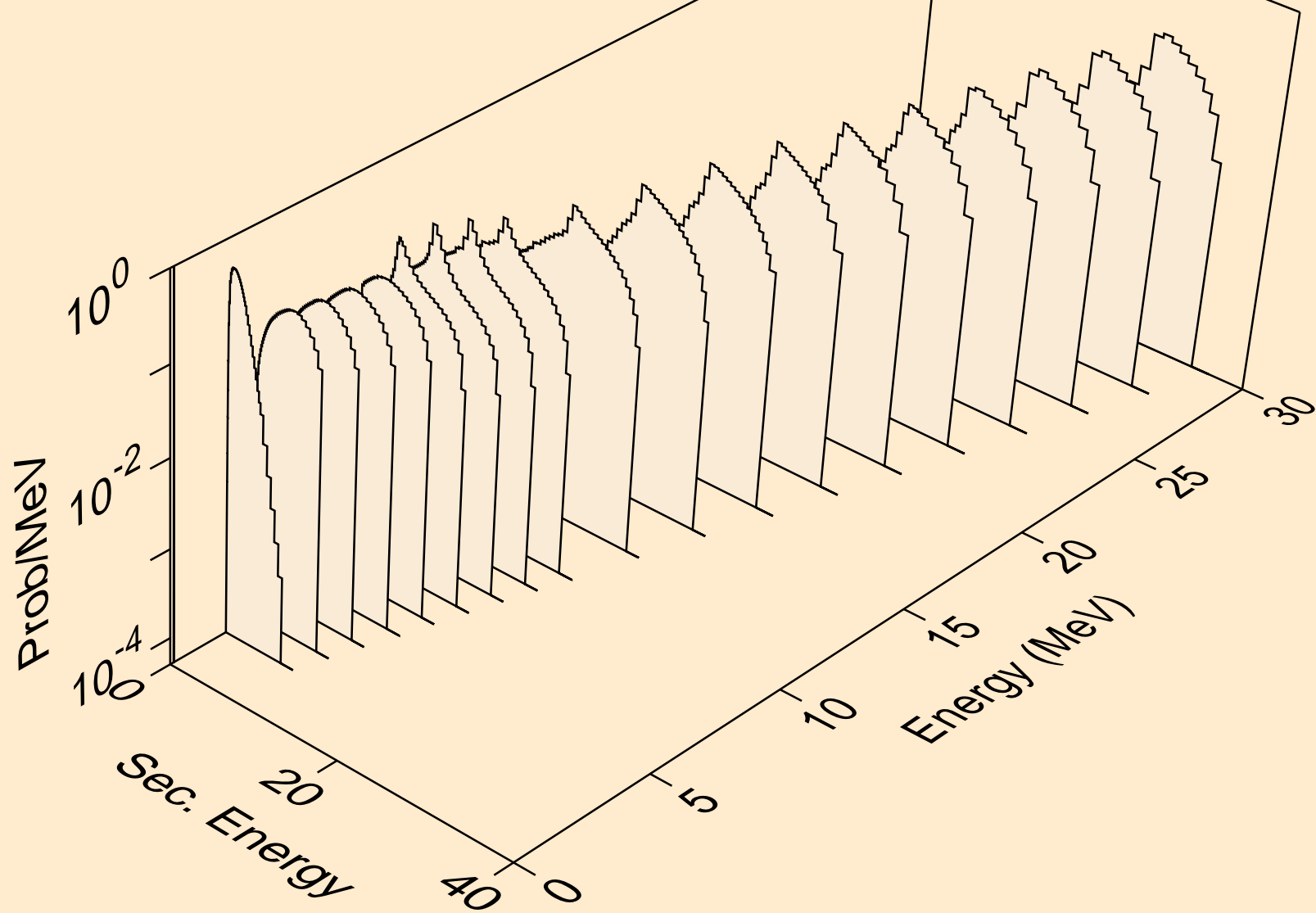

SN117M TRITON ACER TENDL-2021 LIBRARY; T=0.K  
neutrons from (t,x)

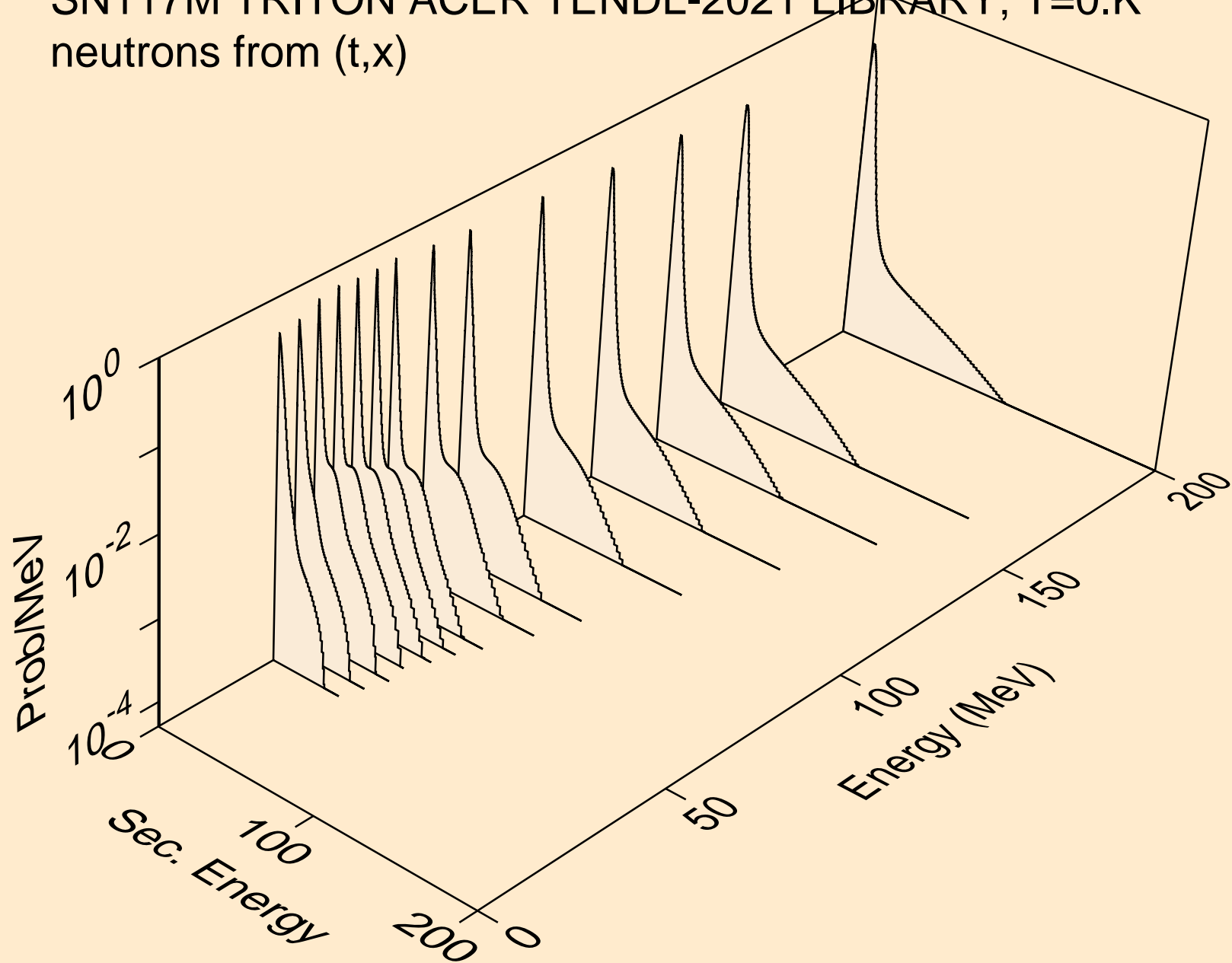



SN117M TRITON ACER TENDL-2021 LIBRARY; T=0.K  
neutrons from (t,2nd)

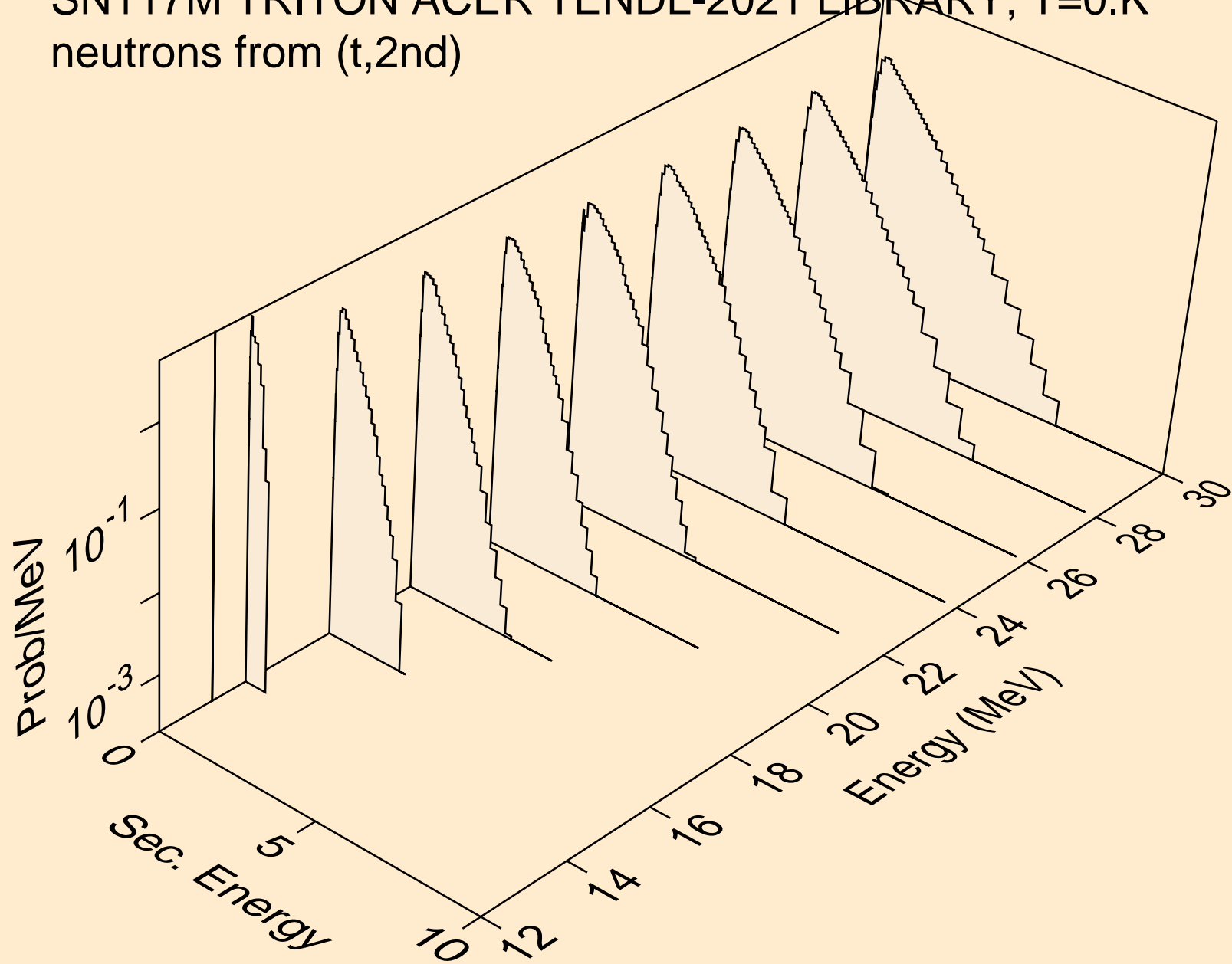

SN117M TRITON ACER TENDL-2021 LIBRARY; T=0.K  
neutrons from (t,2n)

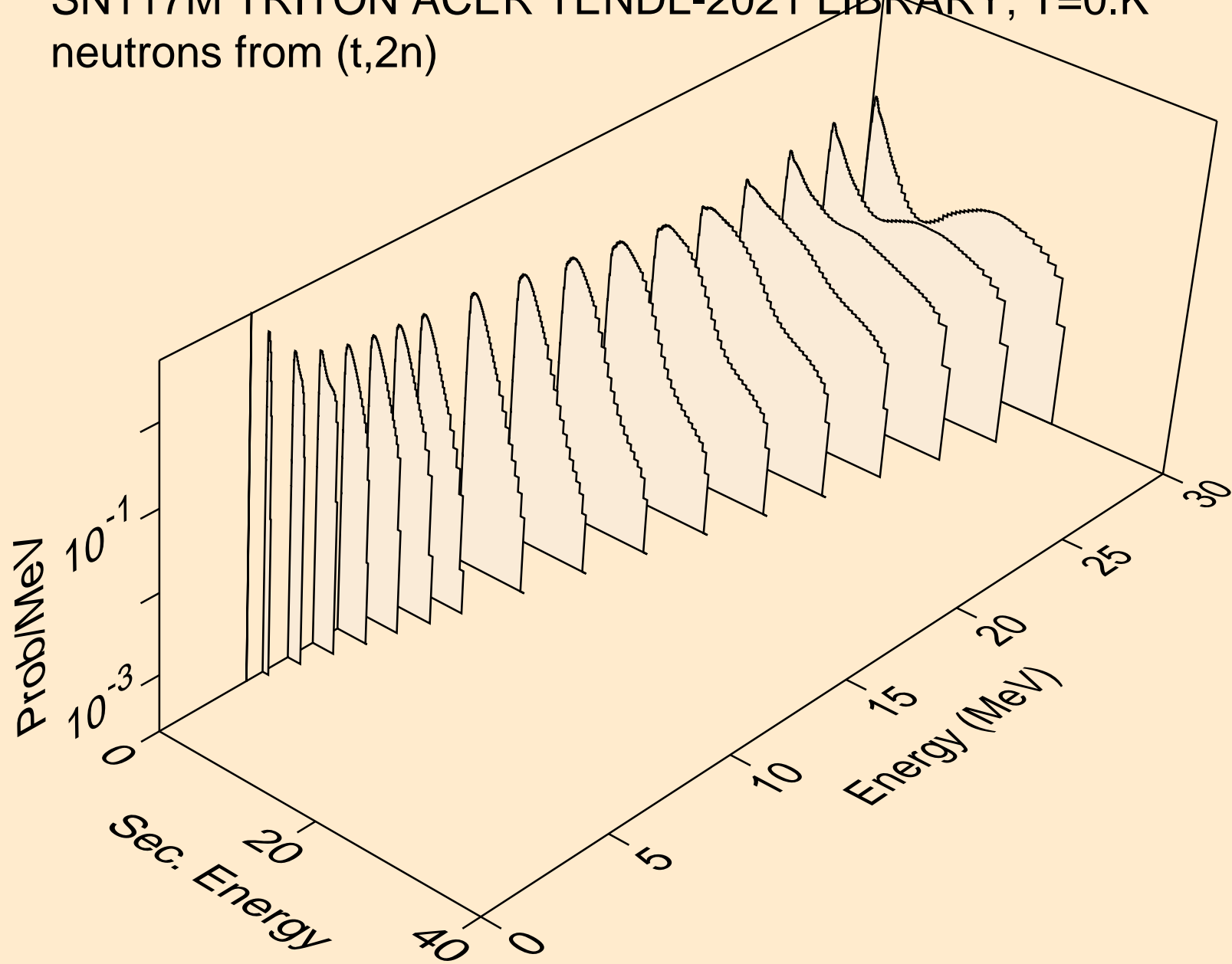

SN117M TRITON ACER TENDL-2021 LIBRARY; T=0.K  
neutrons from (t,3n)

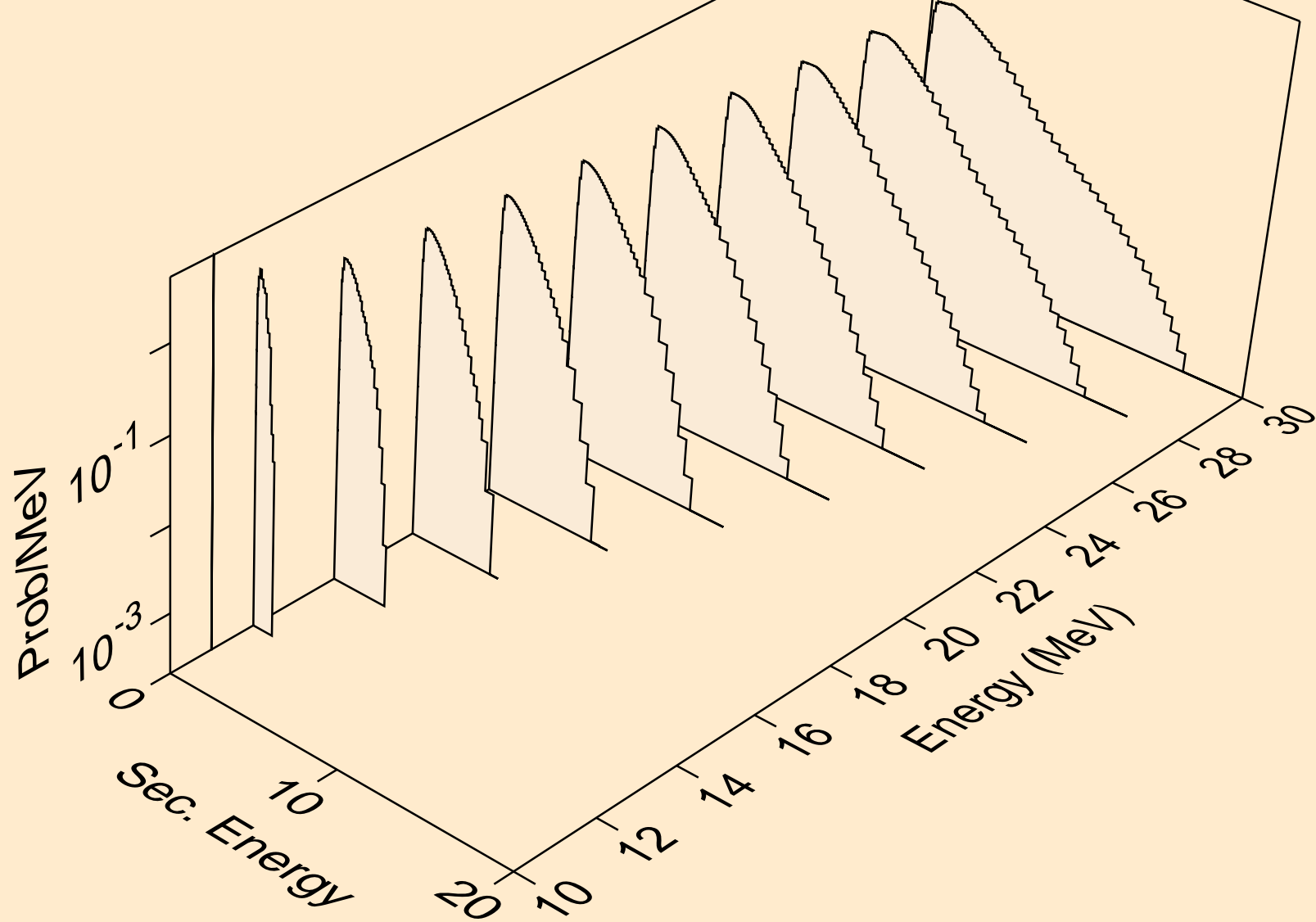

SN117M TRITON ACER TENDL-2021 LIBRARY; T=0.K  
neutrons from (t,n\*)a

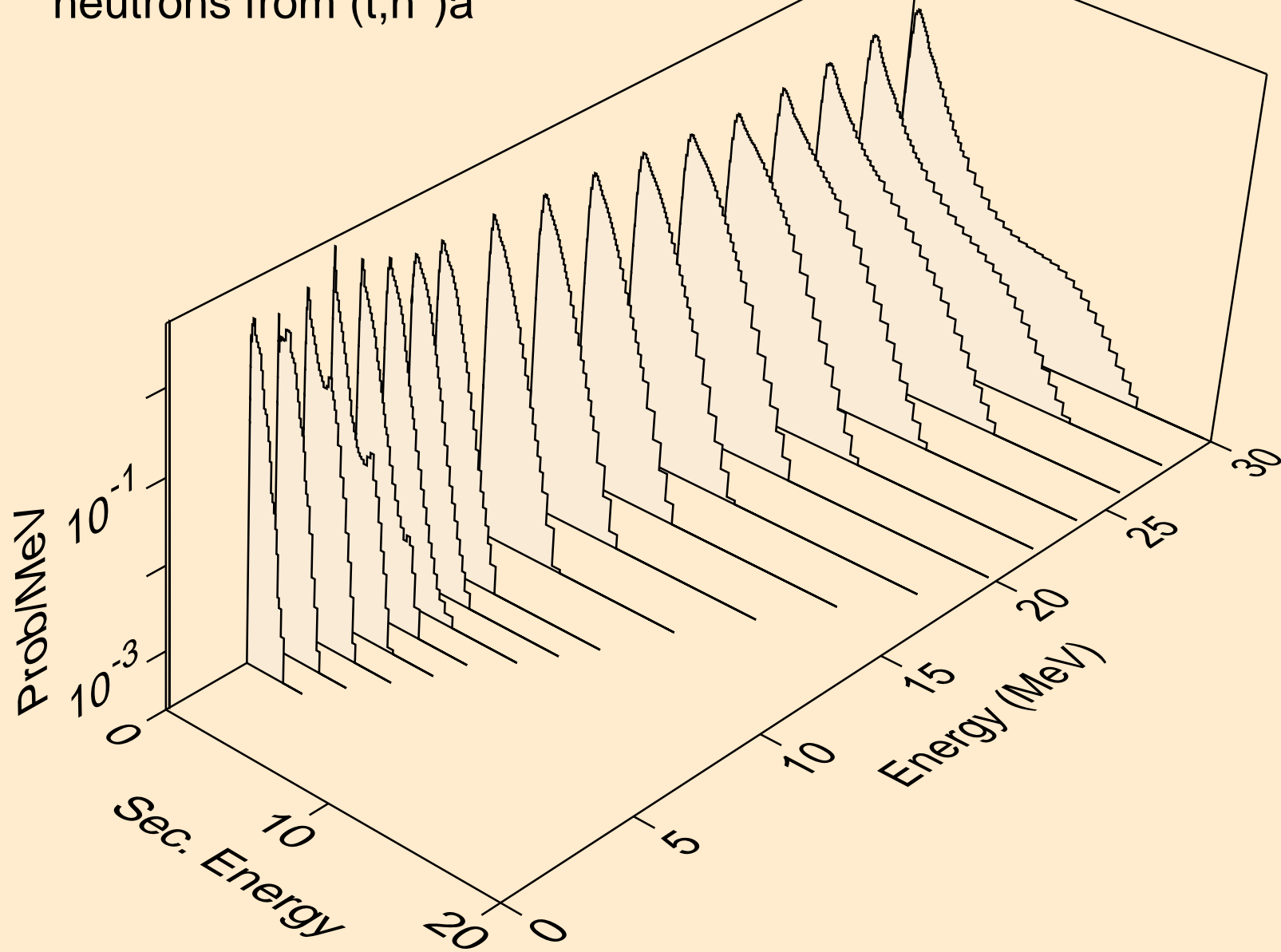

SN117M TRITON ACER TENDL-2021 LIBRARY; T=0.K  
neutrons from (t,2n)a

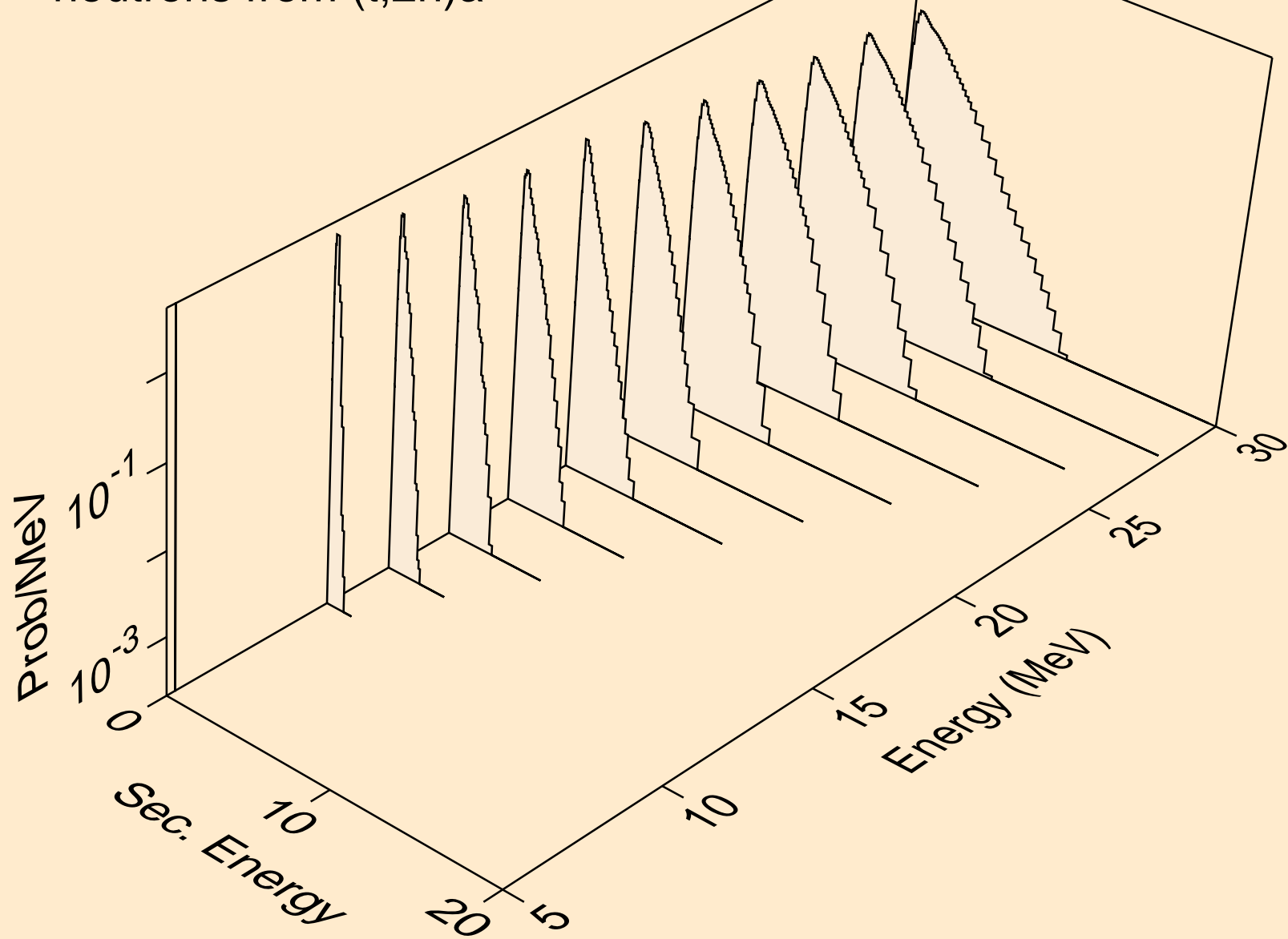

SN117M TRITON ACER TENDL-2021 LIBRARY; T=0.K  
neutrons from (t,3n)a

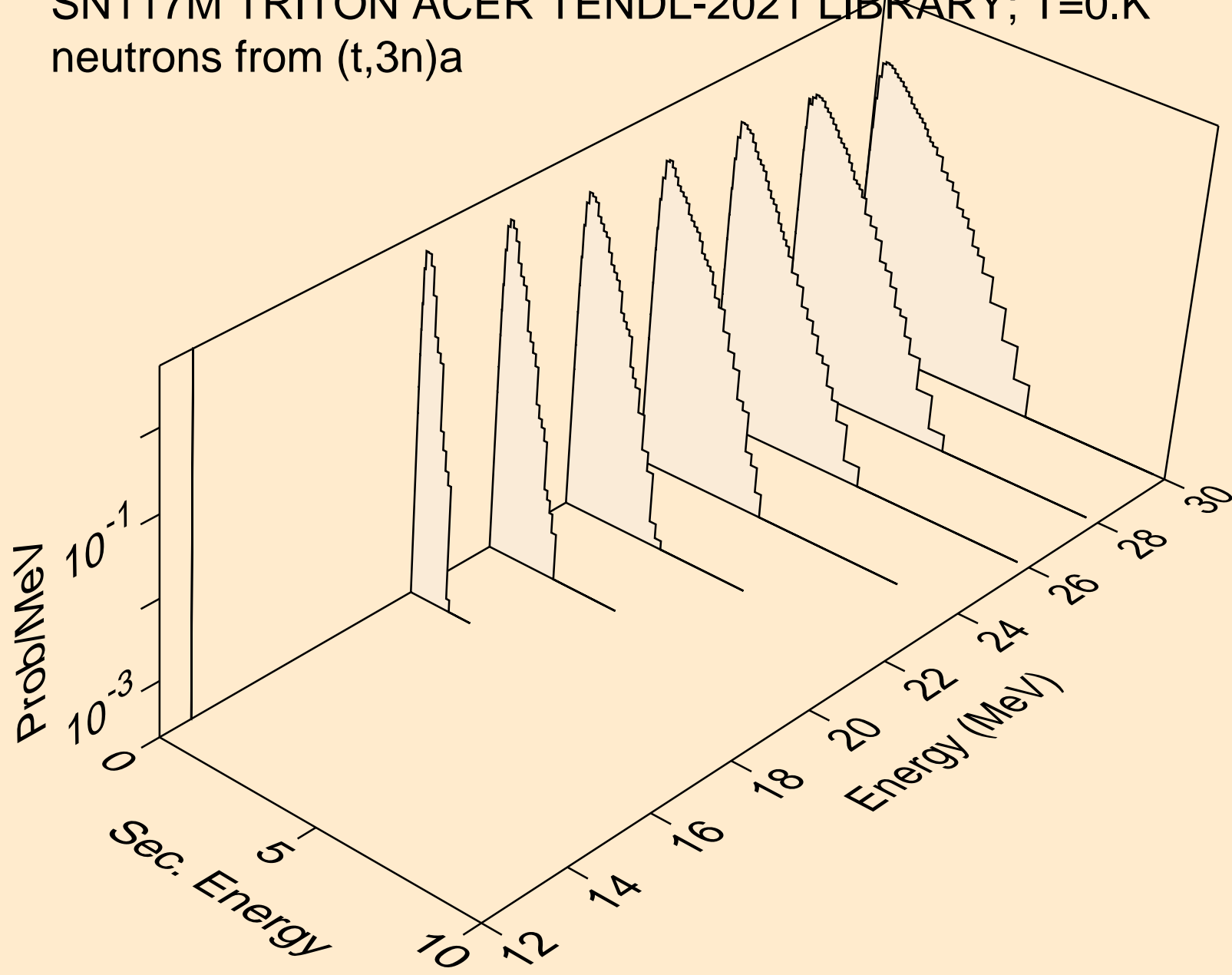

SN117M TRITON ACER TENDL-2021 LIBRARY; T=0.K  
neutrons from (t,n\*)p

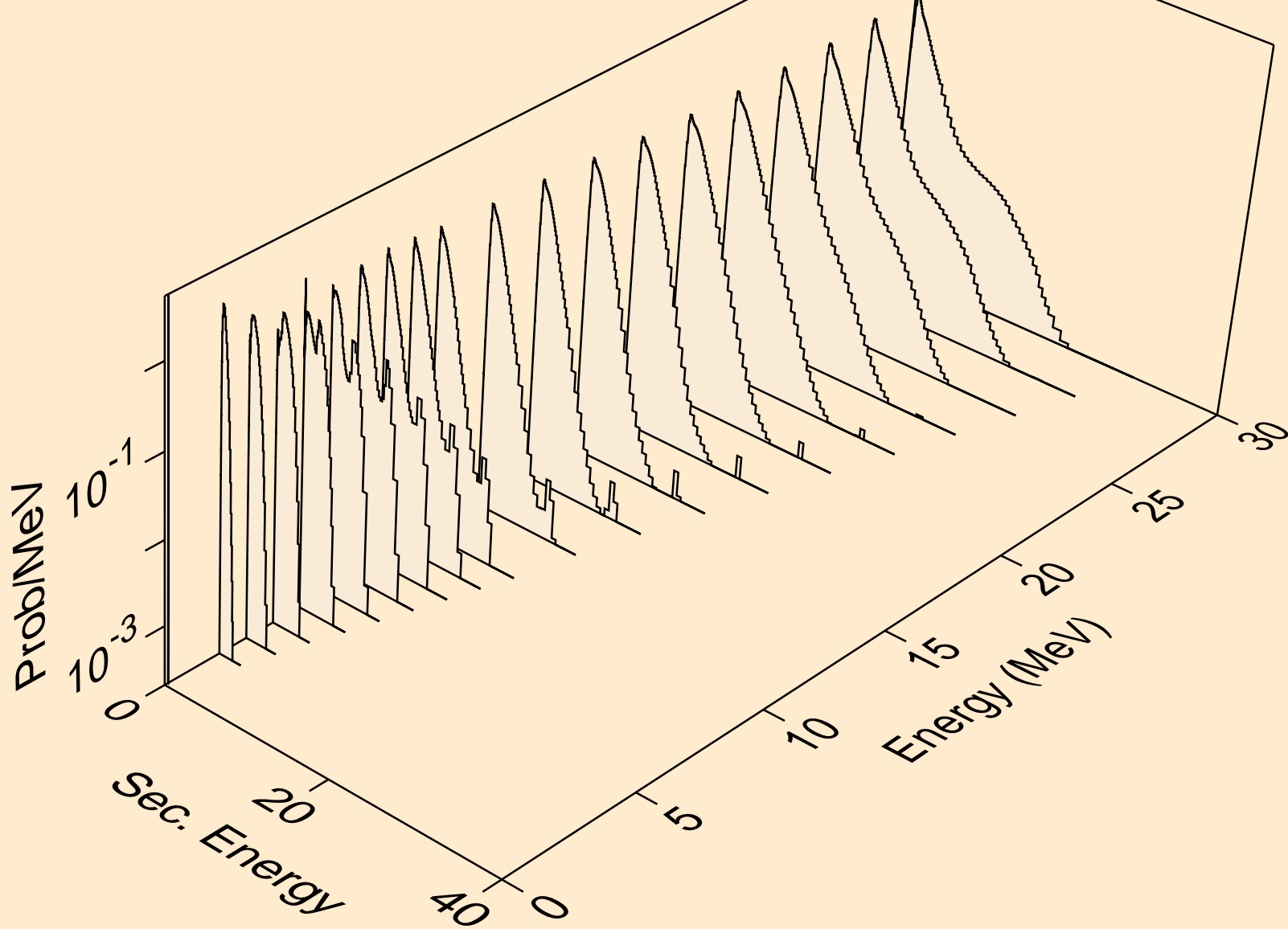

SN117M TRITON ACER TENDL-2021 LIBRARY; T=0.K  
neutrons from (t,n\*)2a

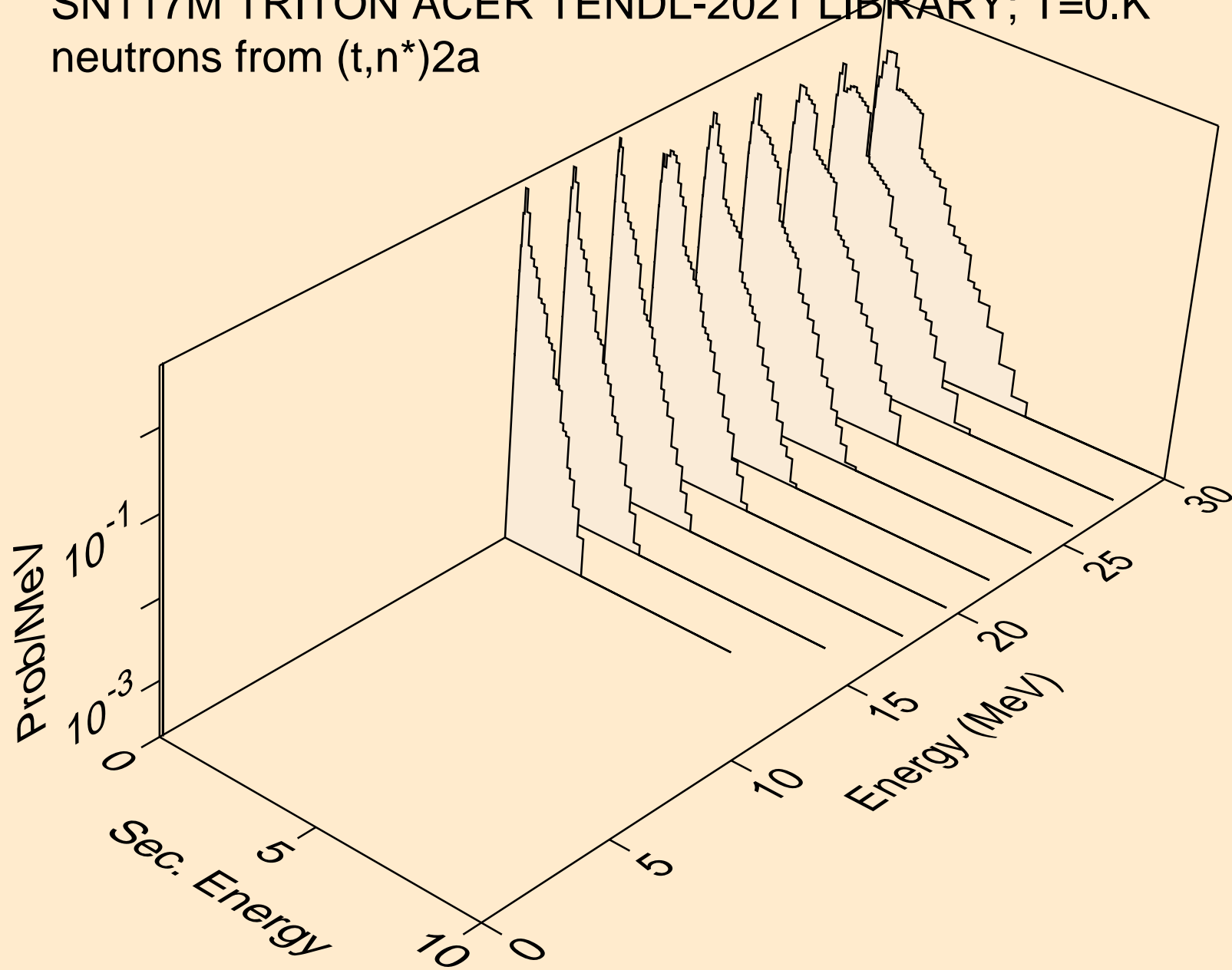



SN117M TRITON ACER TENDL-2021 LIBRARY; T=0.K  
neutrons from (t,n\*)d

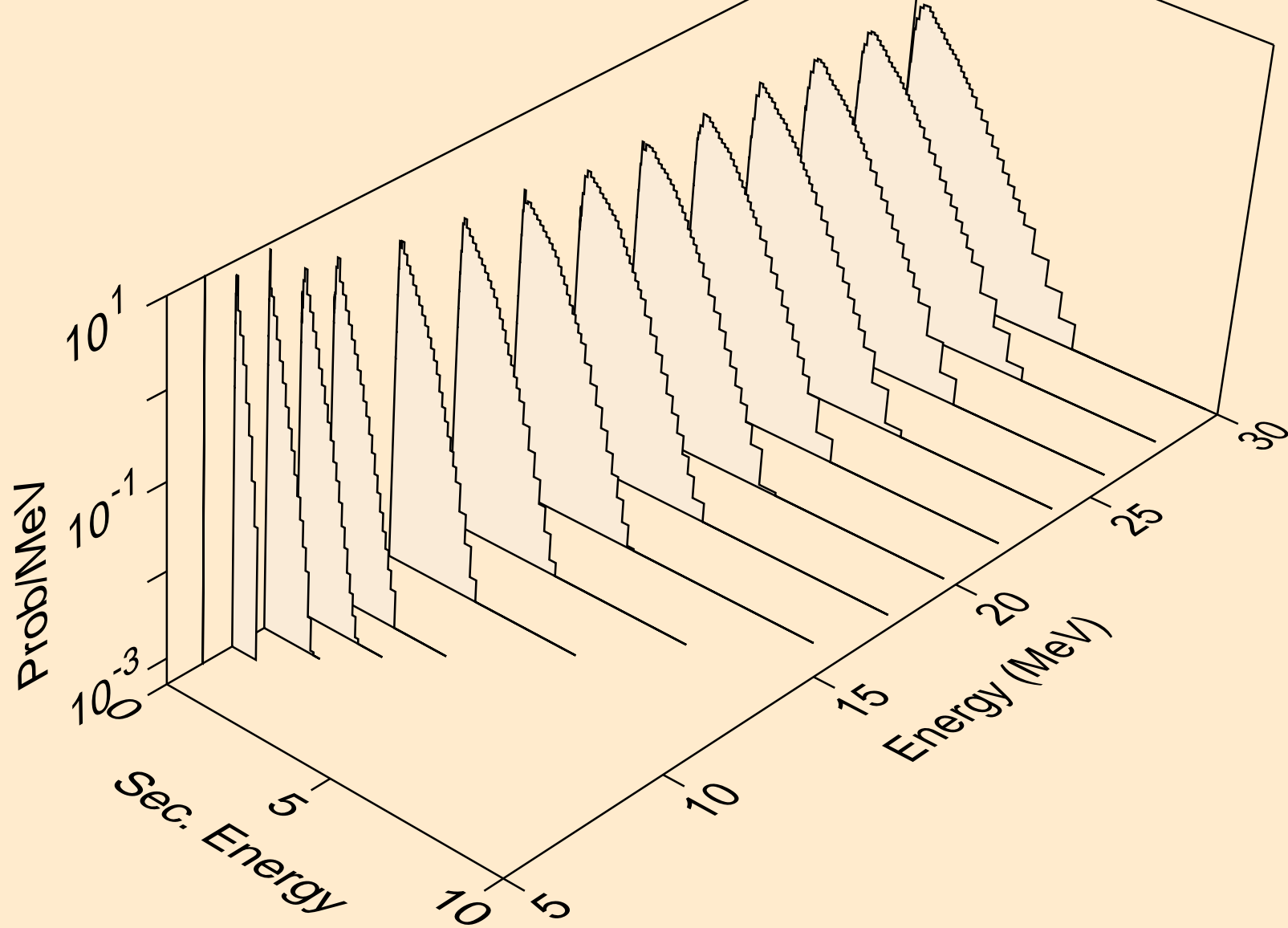

SN117M TRITON ACER TENDL-2021 LIBRARY; T=0.K  
neutrons from (t,n\*)t

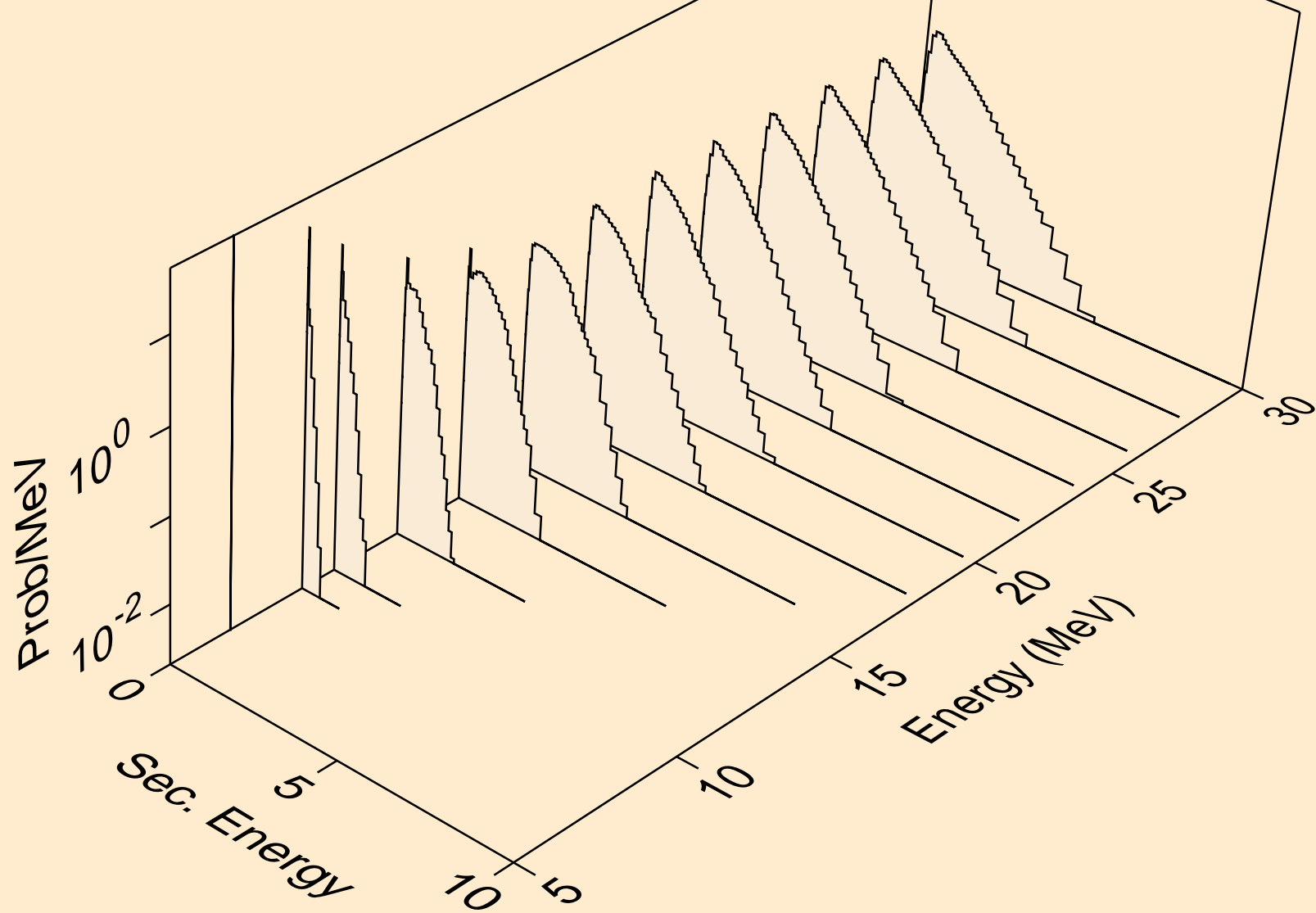

SN117M TRITON ACER TENDL-2021 LIBRARY; T=0.K  
neutrons from (t,n\*)he3

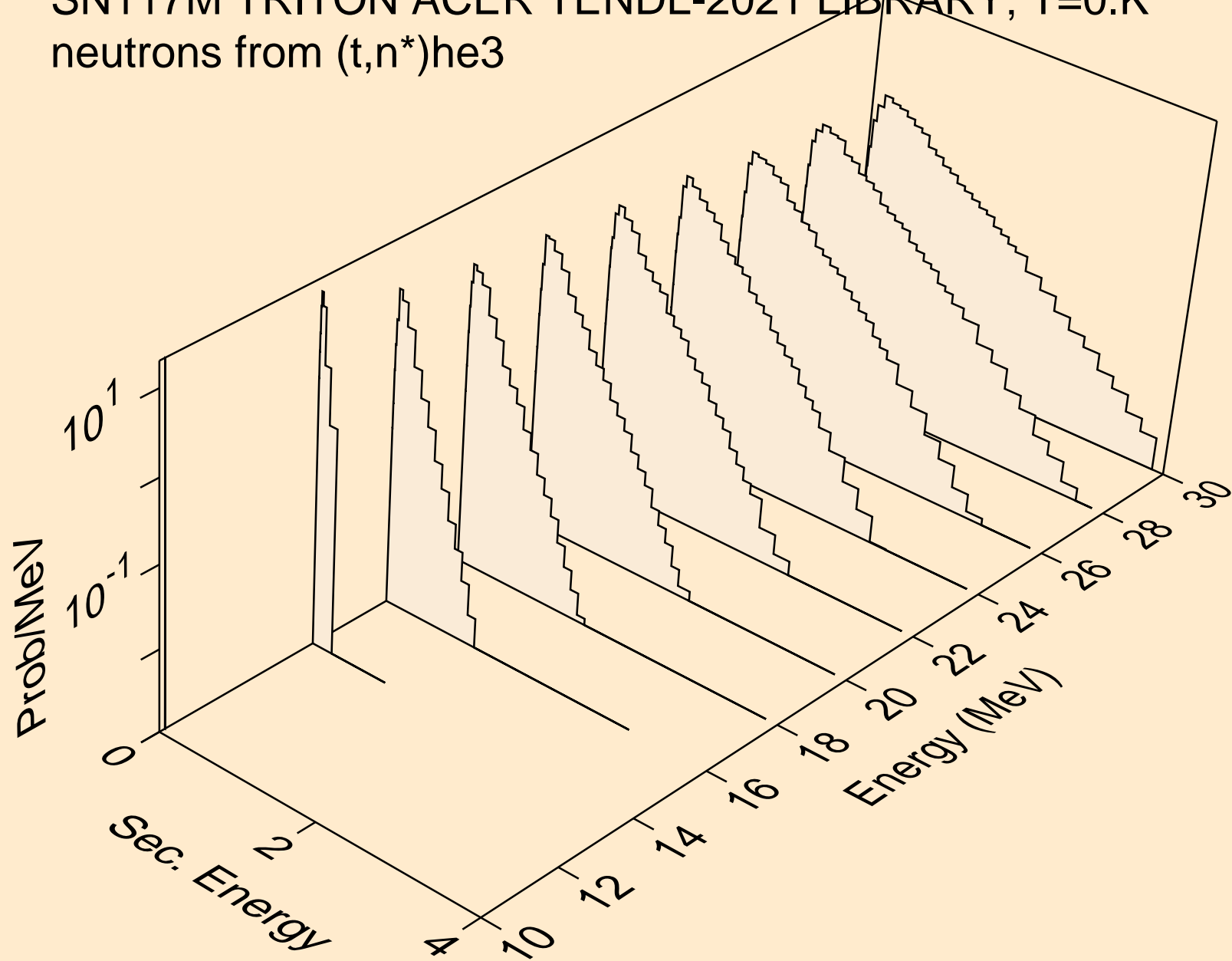

SN117M TRITON ACER TENDL-2021 LIBRARY; T=0.K  
neutrons from (t,4n)

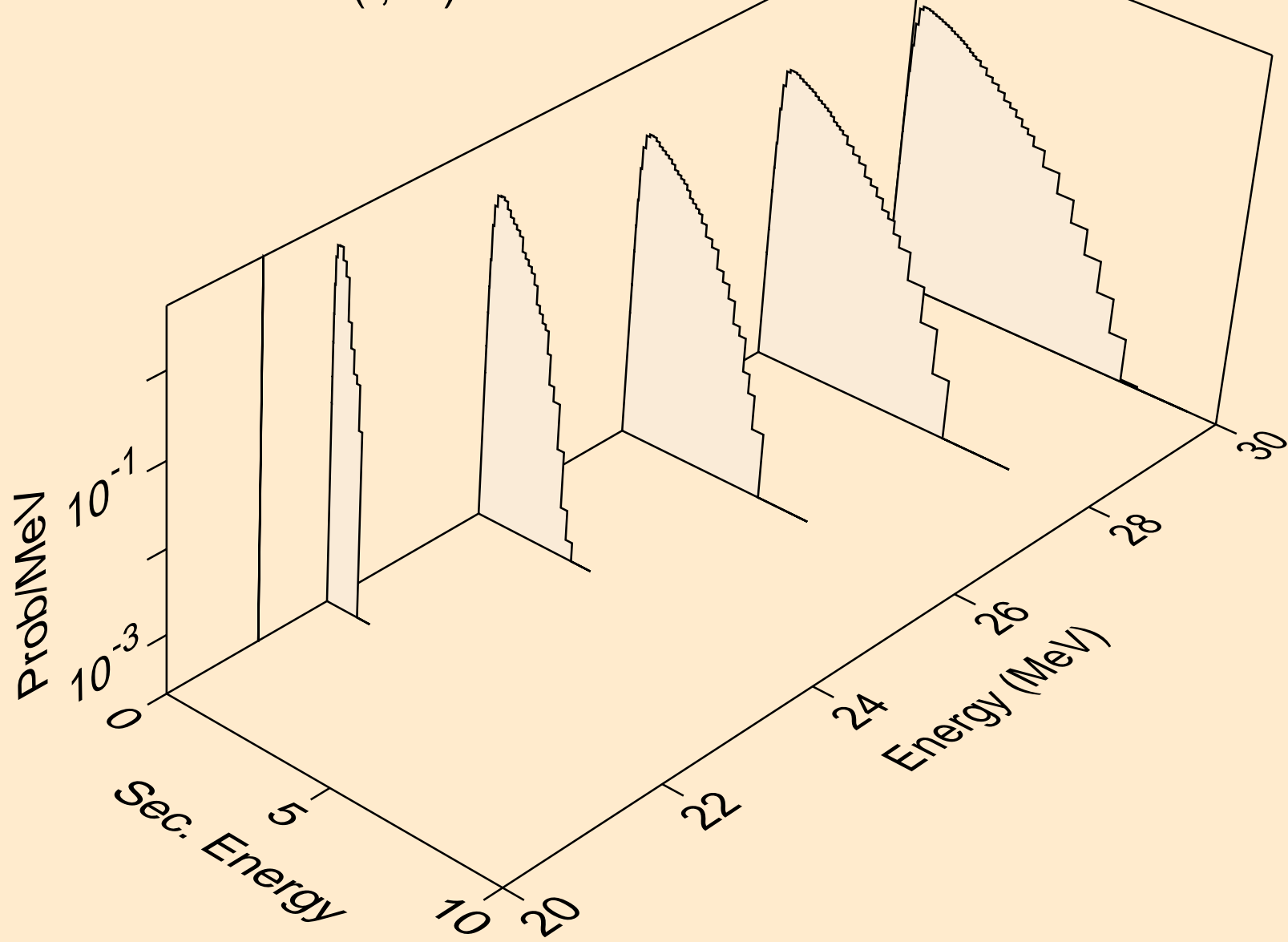

SN117M TRITON ACER TENDL-2021 LIBRARY; T=0.K  
neutrons from (t,2np)

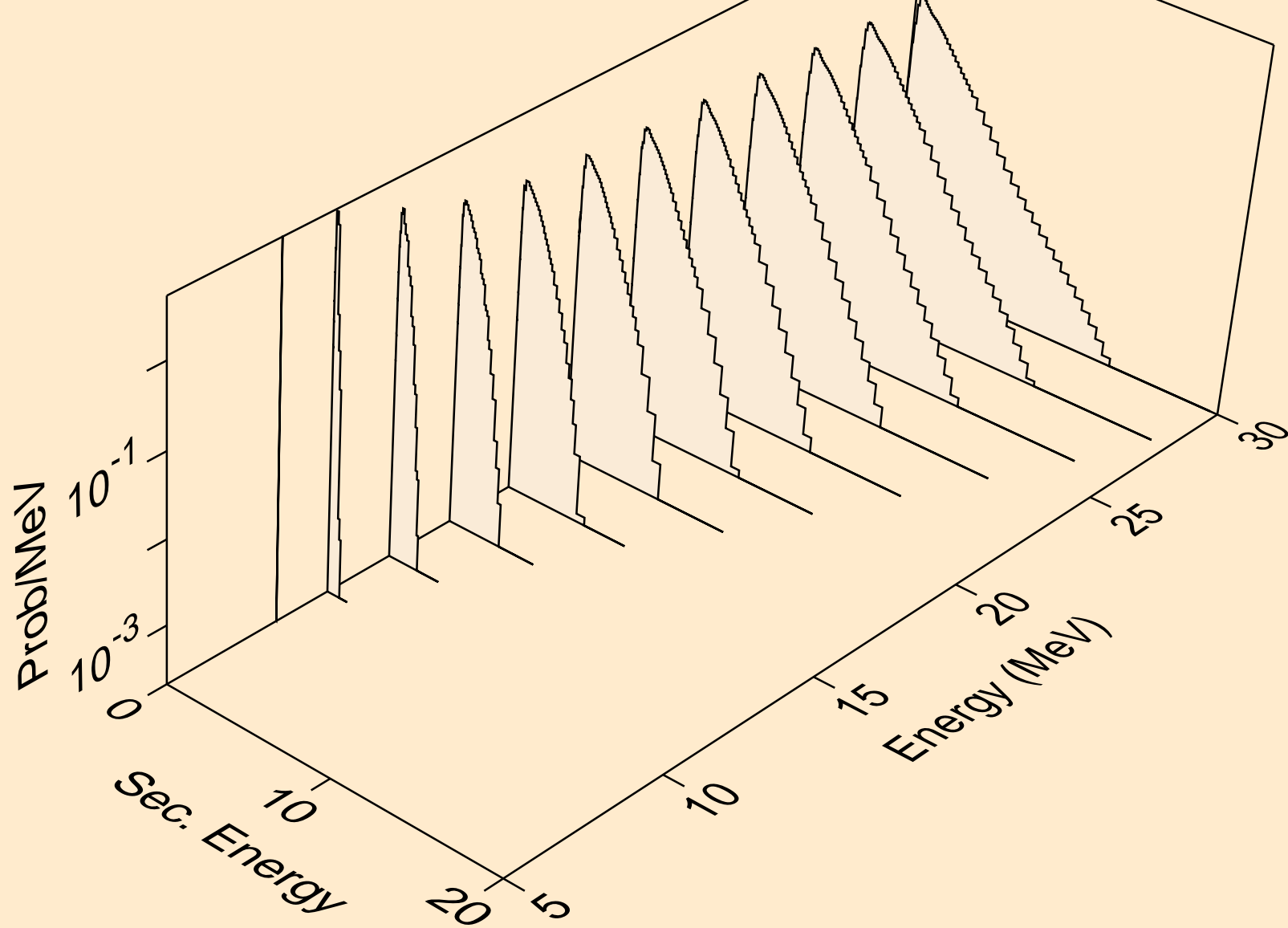

SN117M TRITON ACER TENDL-2021 LIBRARY; T=0.K  
neutrons from (t,3np)

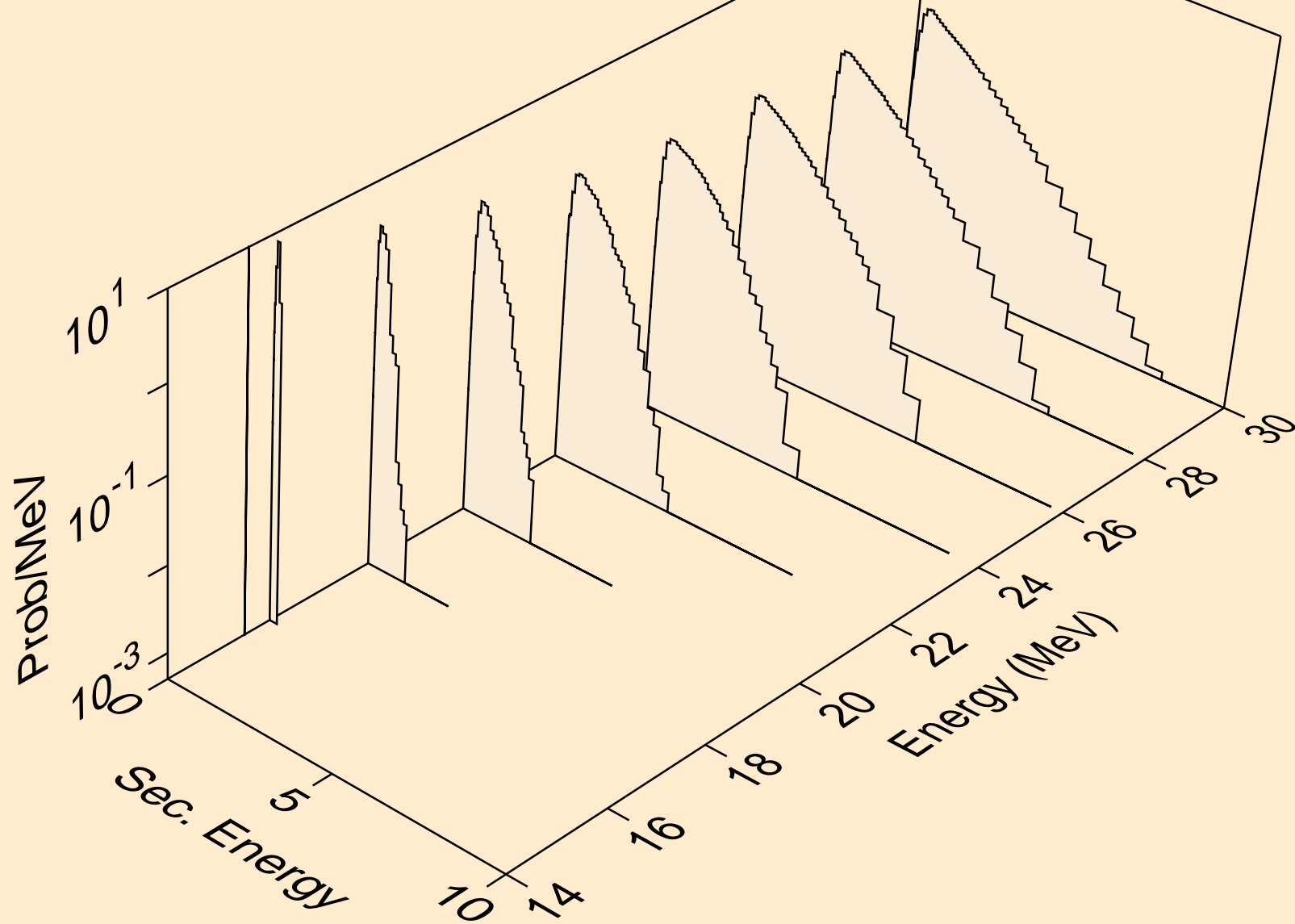

SN117M TRITON ACER TENDL-2021 LIBRARY; T=0.K  
neutrons from (t,2np)

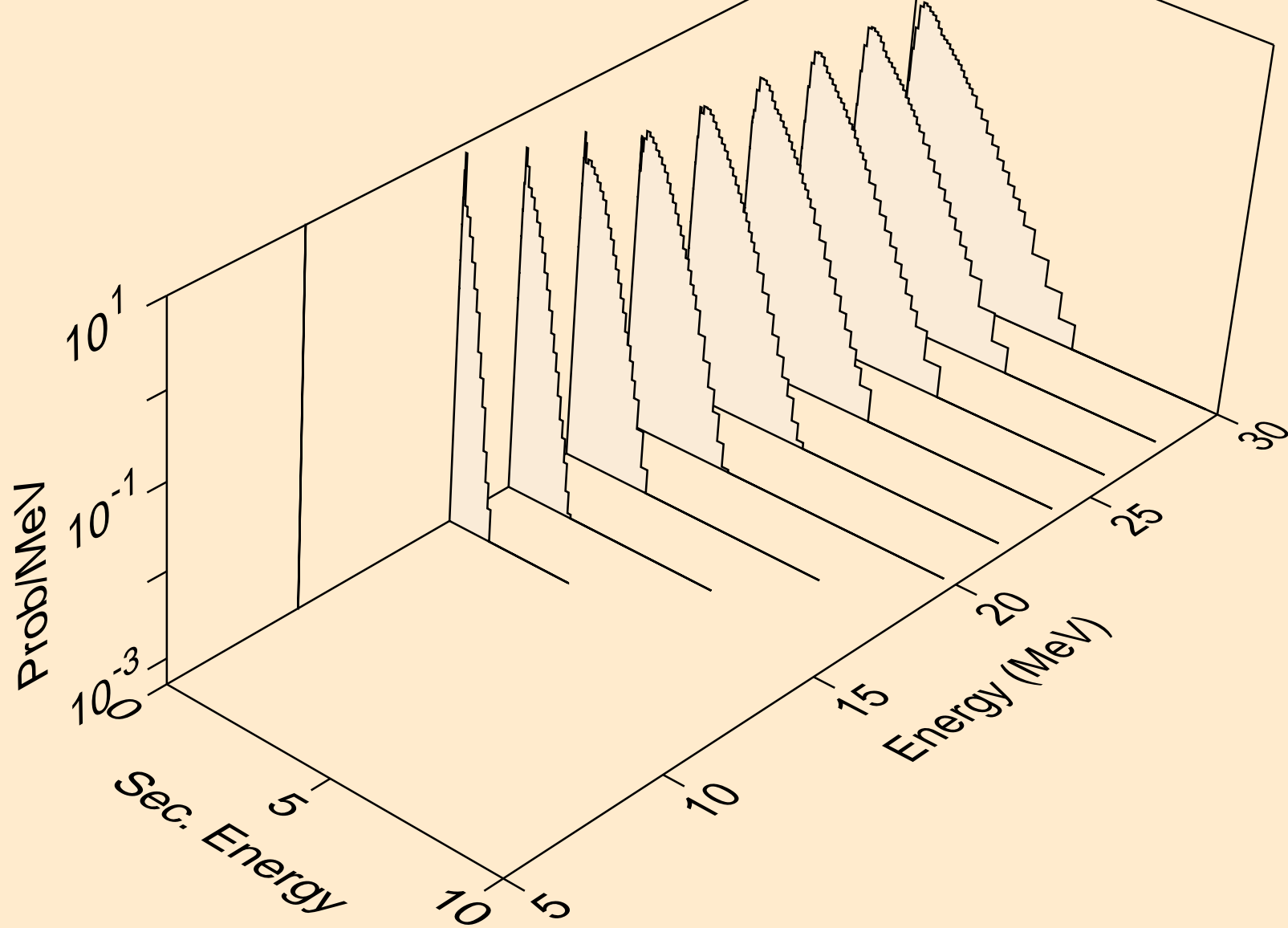

SN117M TRITON ACER TENDL-2021 LIBRARY; T=0.K  
neutrons from (t,npa)

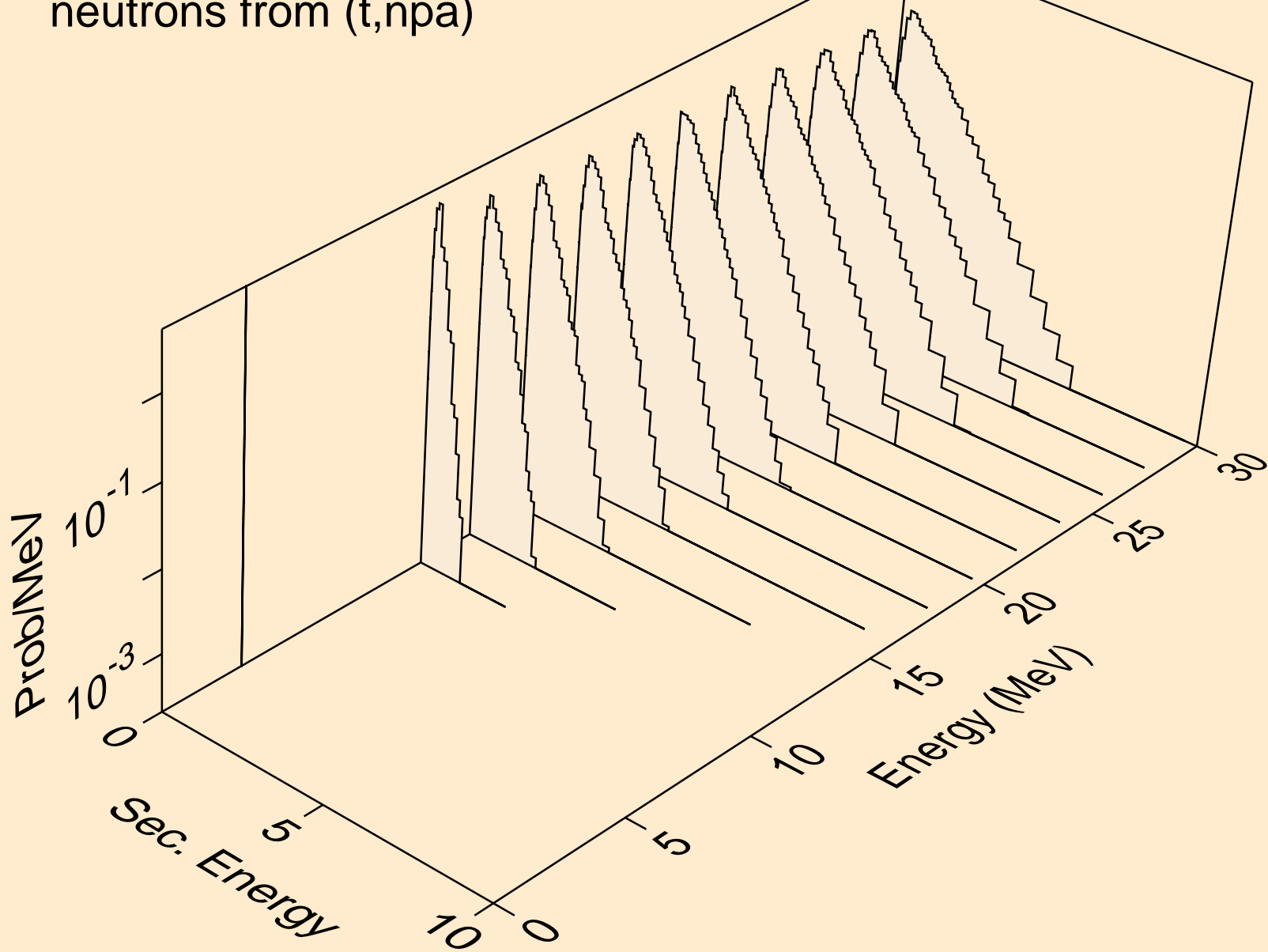



SN117M TRITON ACER TENDL-2021 LIBRARY; T=0.K  
protons from (t,x)

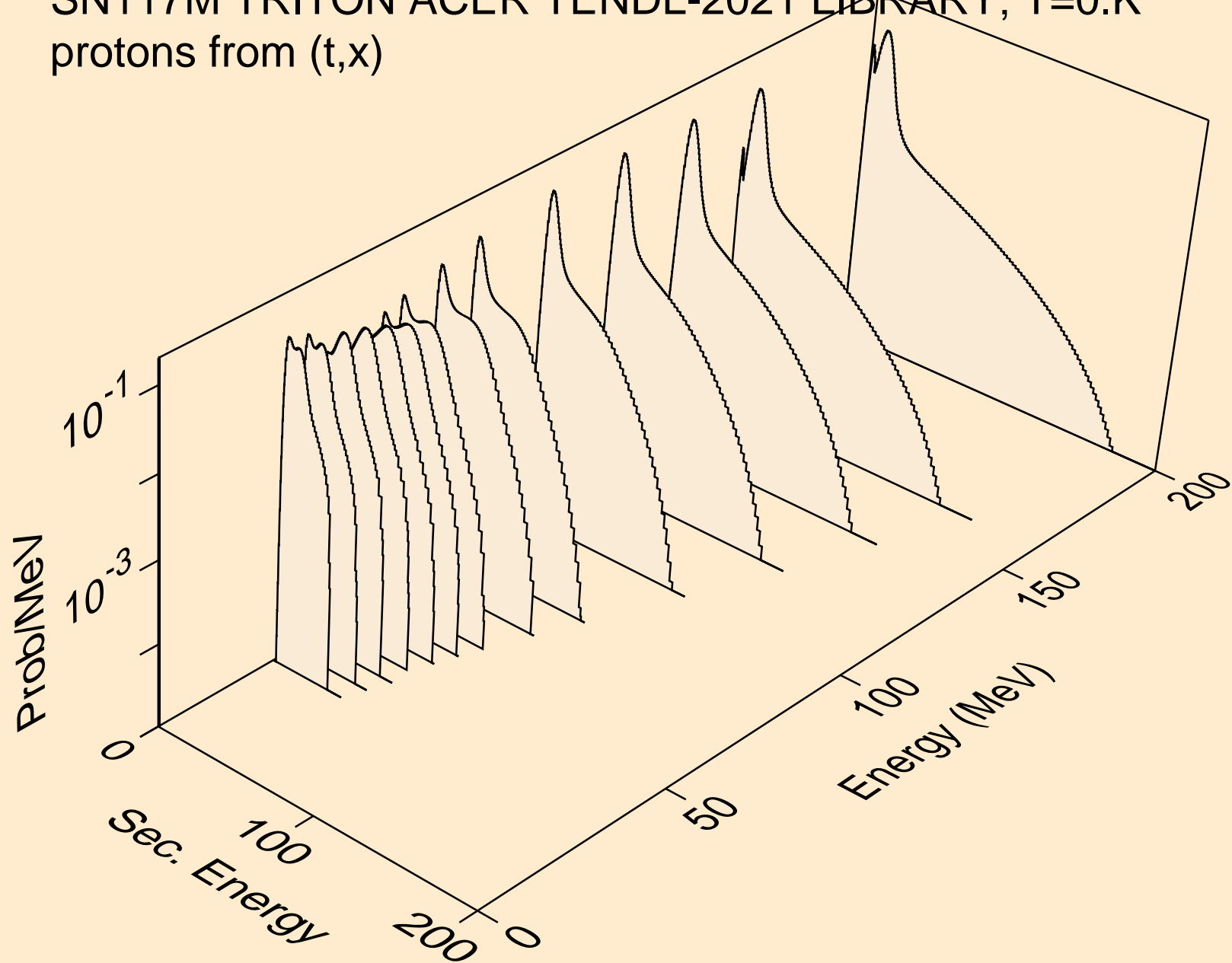

SN117M TRITON ACER TENDL-2021 LIBRARY; T=0.K  
protons from (t,n\*)p

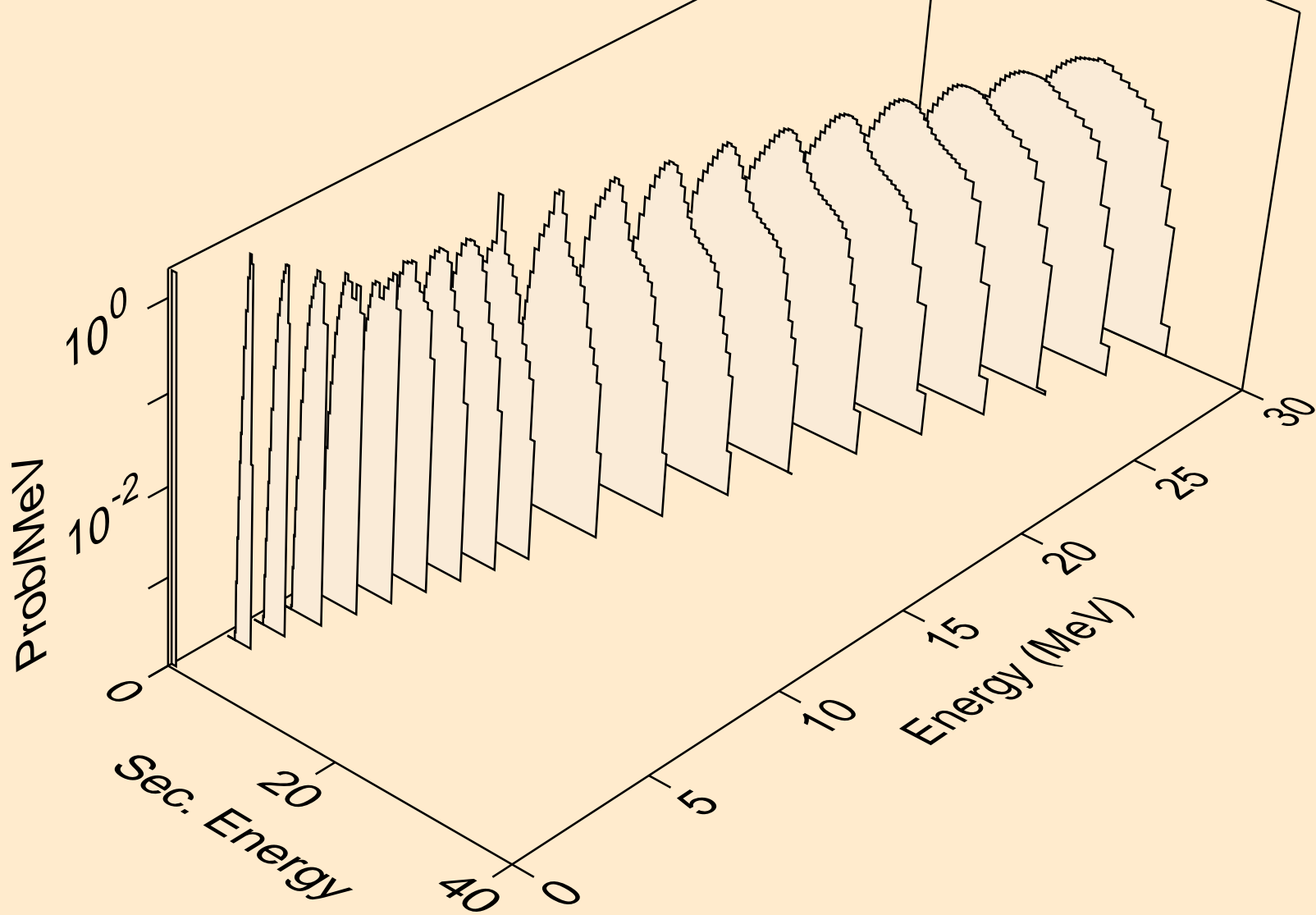

SN117M TRITON ACER TENDL-2021 LIBRARY; T=0.K  
protons from (t,2np)

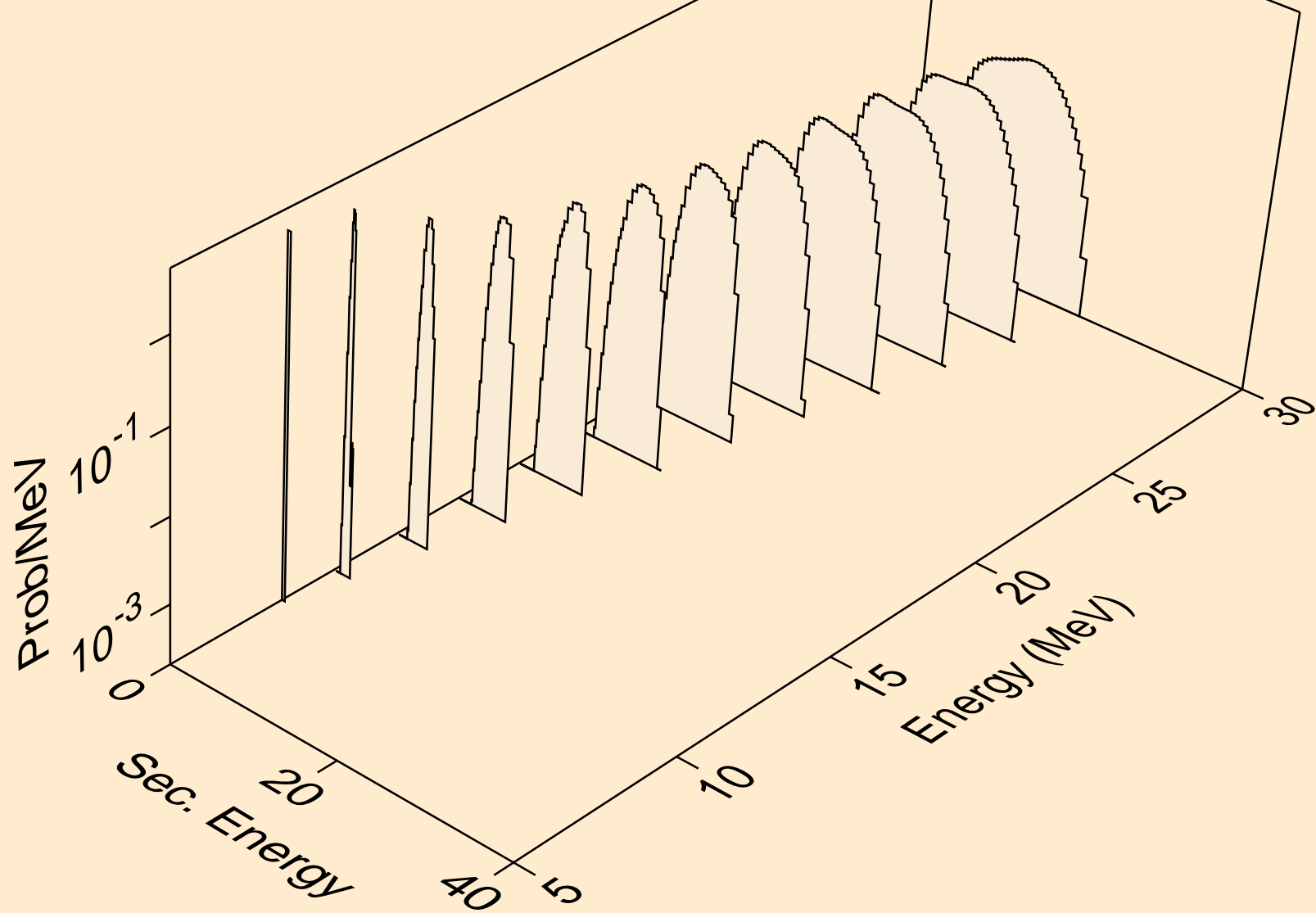

SN117M TRITON ACER TENDL-2021 LIBRARY; T=0.K  
protons from (t,3np)

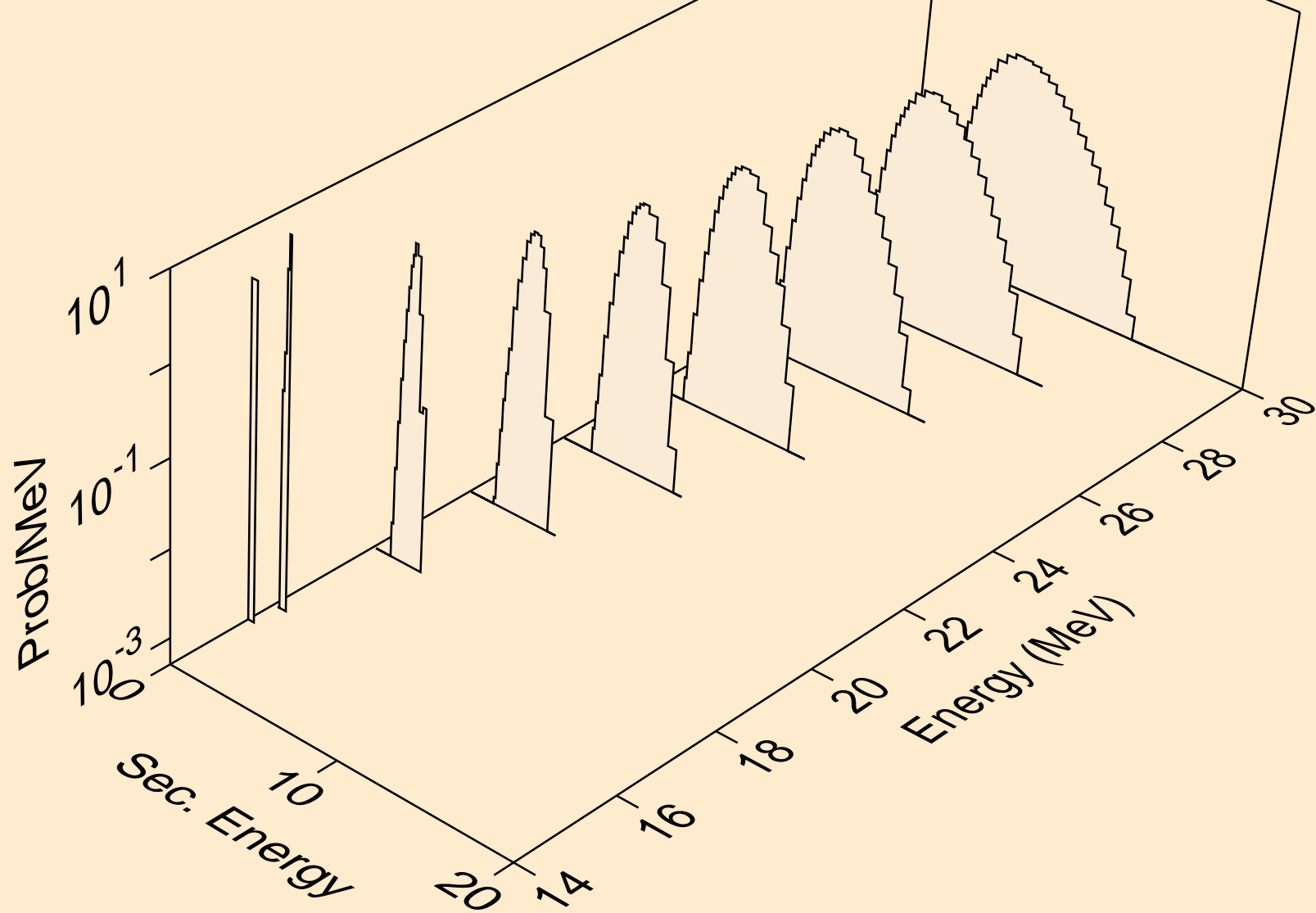

SN117M TRITON ACER TENDL-2021 LIBRARY; T=0.K  
protons from (t,2np)

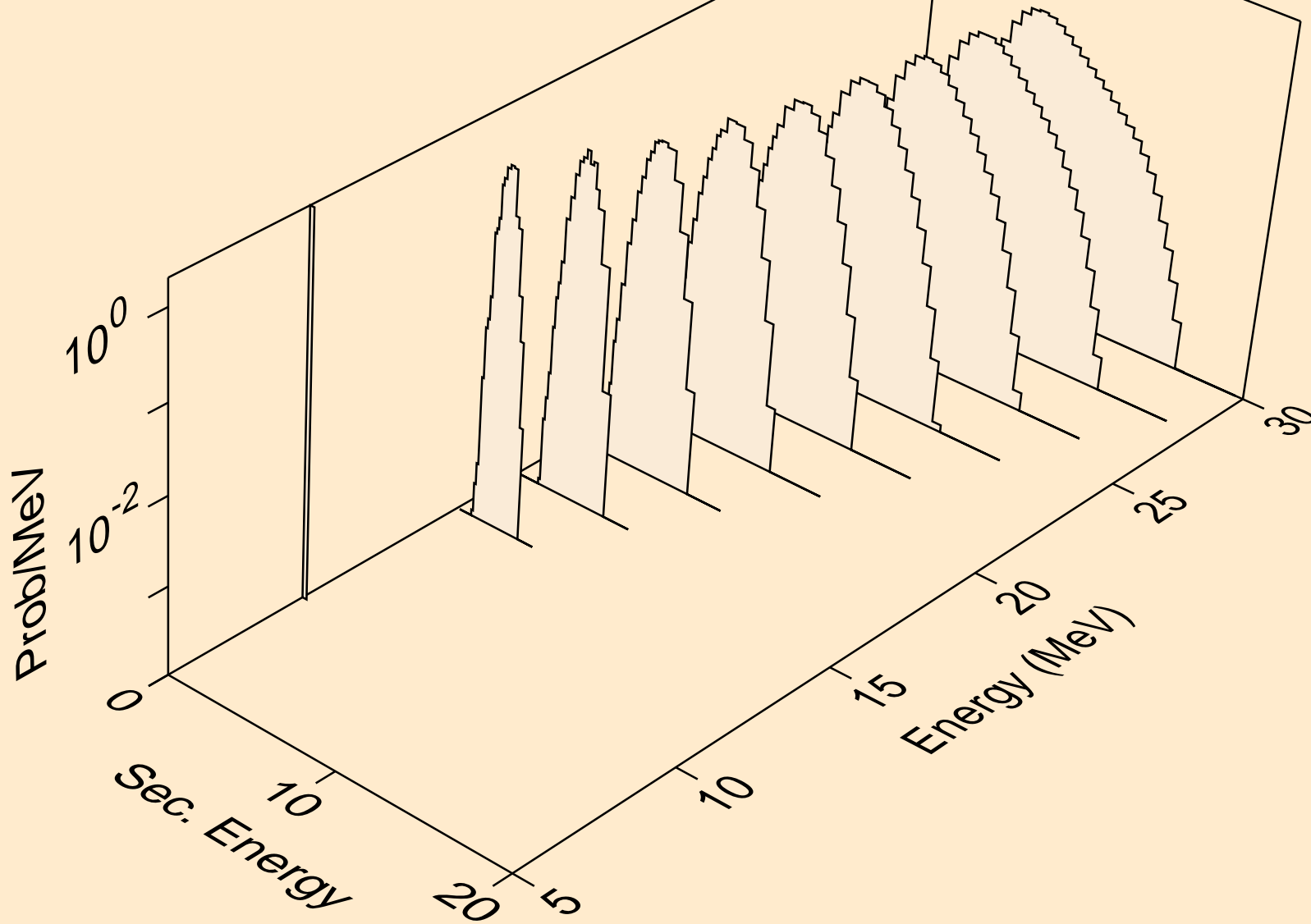

SN117M TRITON ACER TENDL-2021 LIBRARY; T=0.K  
protons from (t,npa)

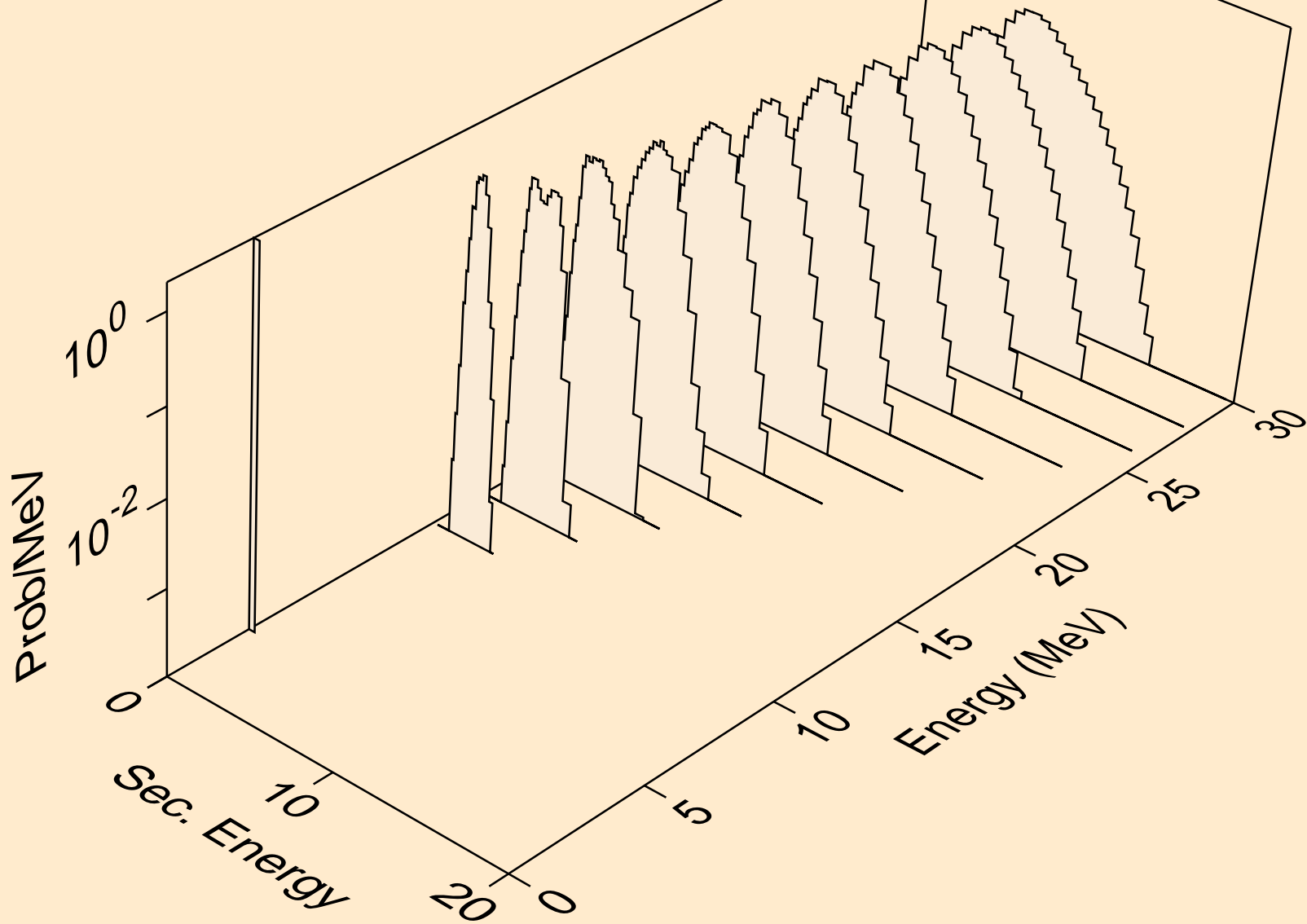

SN117M TRITON ACER TENDL-2021 LIBRARY; T=0.K  
protons from (t,p)

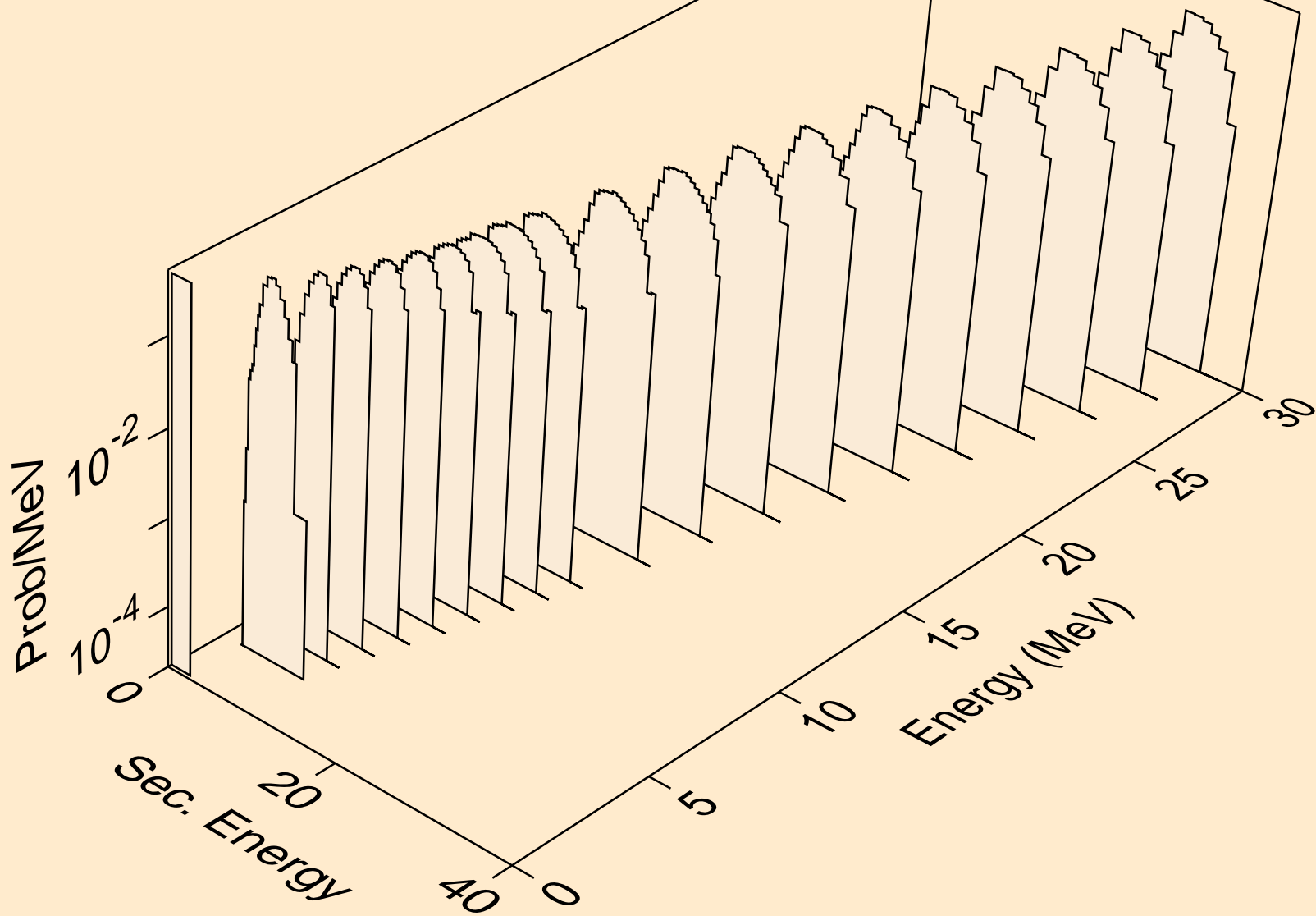

SN117M TRITON ACER TENDL-2021 LIBRARY; T=0.K  
protons from (t,2p)

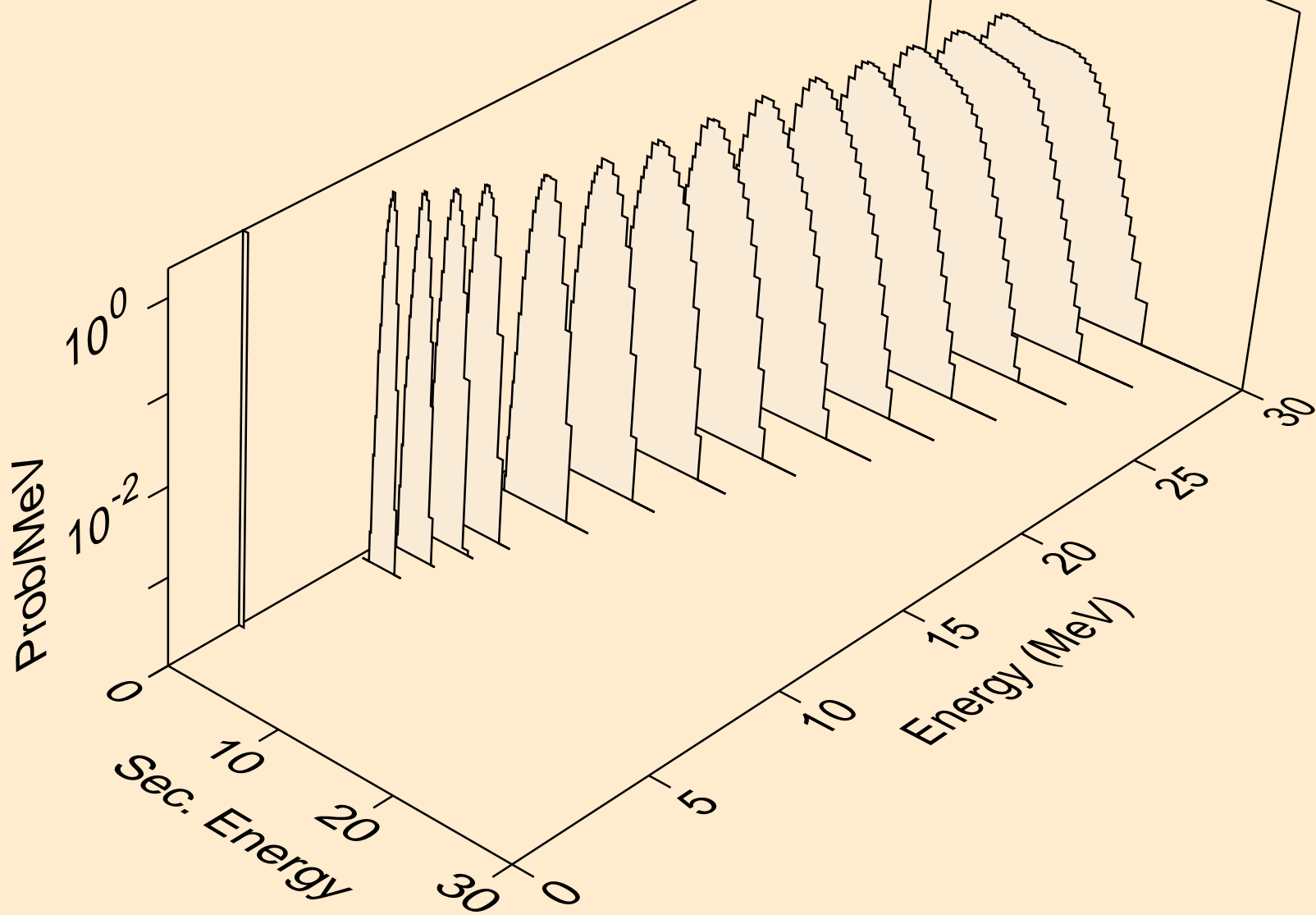



SN117M TRITON ACER TENDL-2021 LIBRARY; T=0.K  
protons from (t,pa)

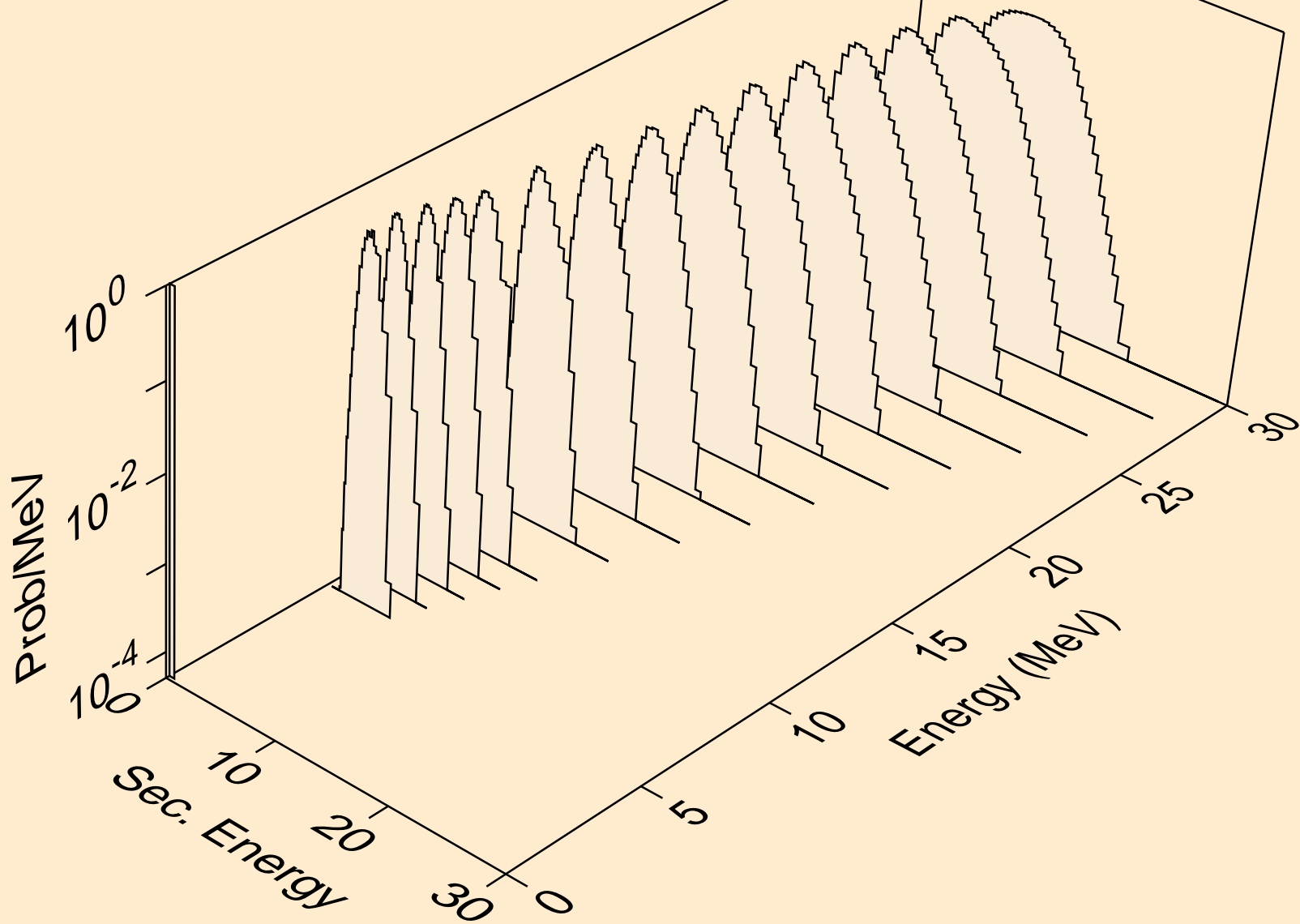

SN117M TRITON ACER TENDL-2021 LIBRARY; T=0.K  
protons from (t,pd)

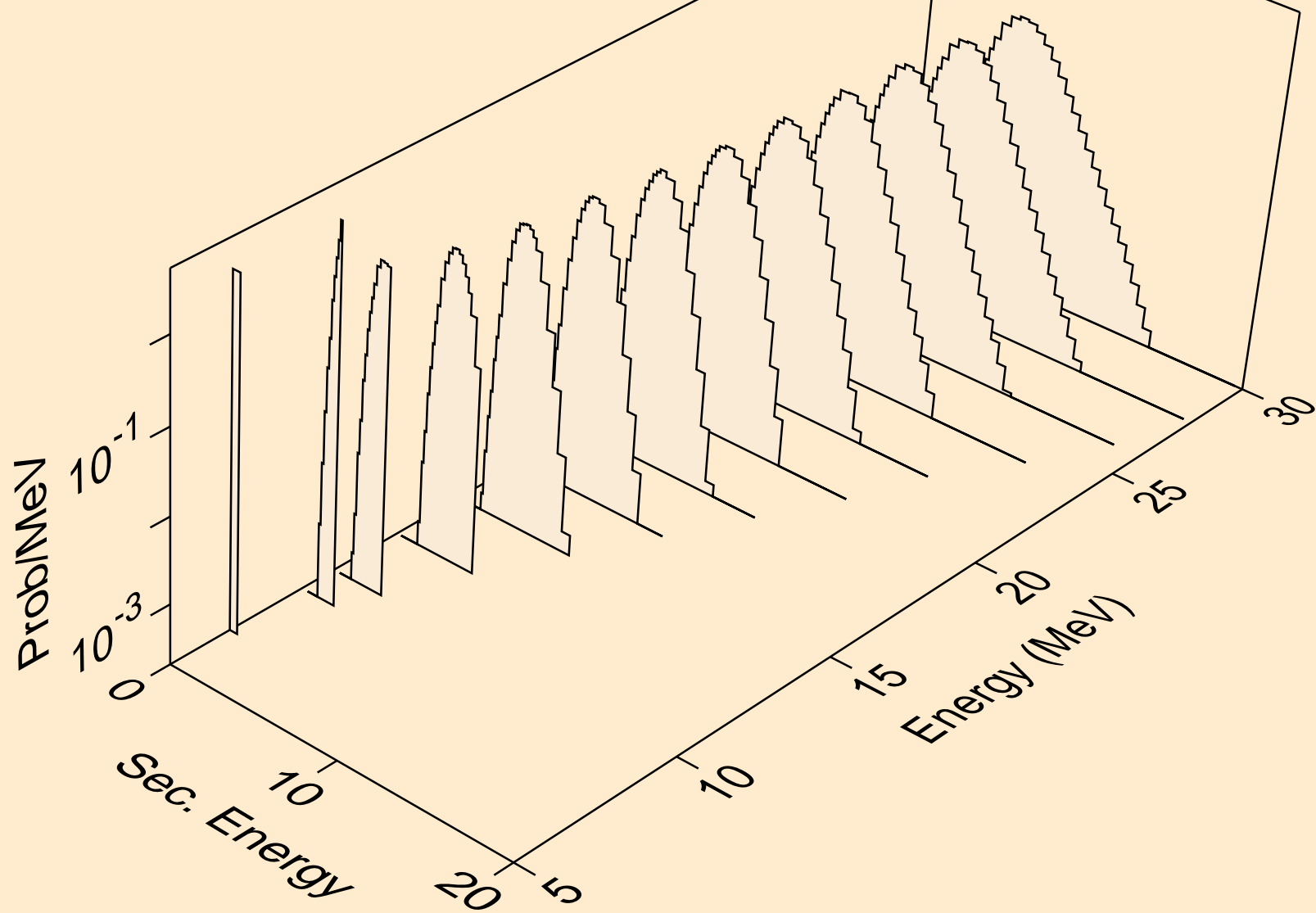

SN117M TRITON ACER TENDL-2021 LIBRARY; T=0.K  
protons from (t,pt)

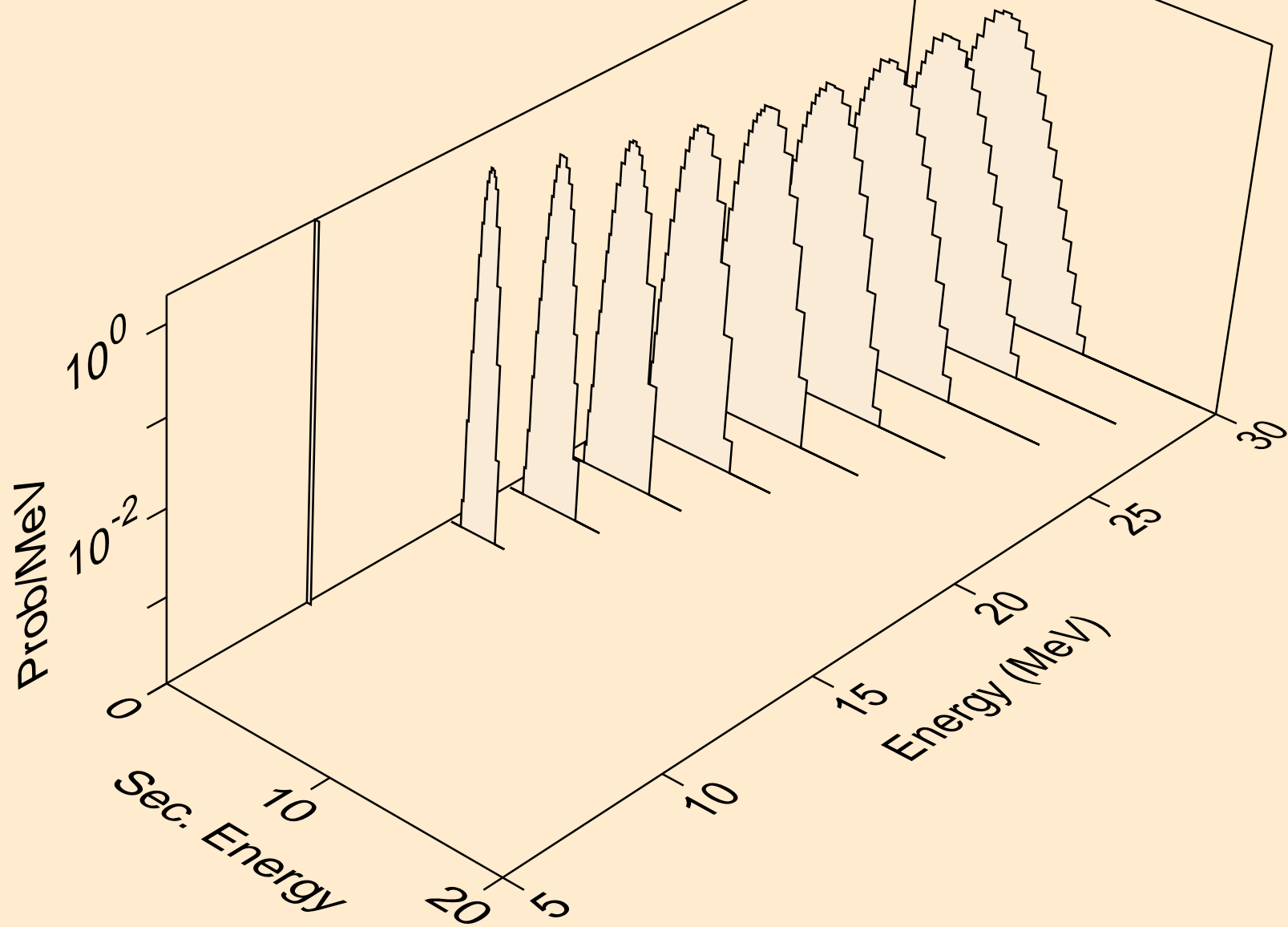

SN117M TRITON ACER TENDL-2021 LIBRARY; T=0.K  
deuterons from (t,x)

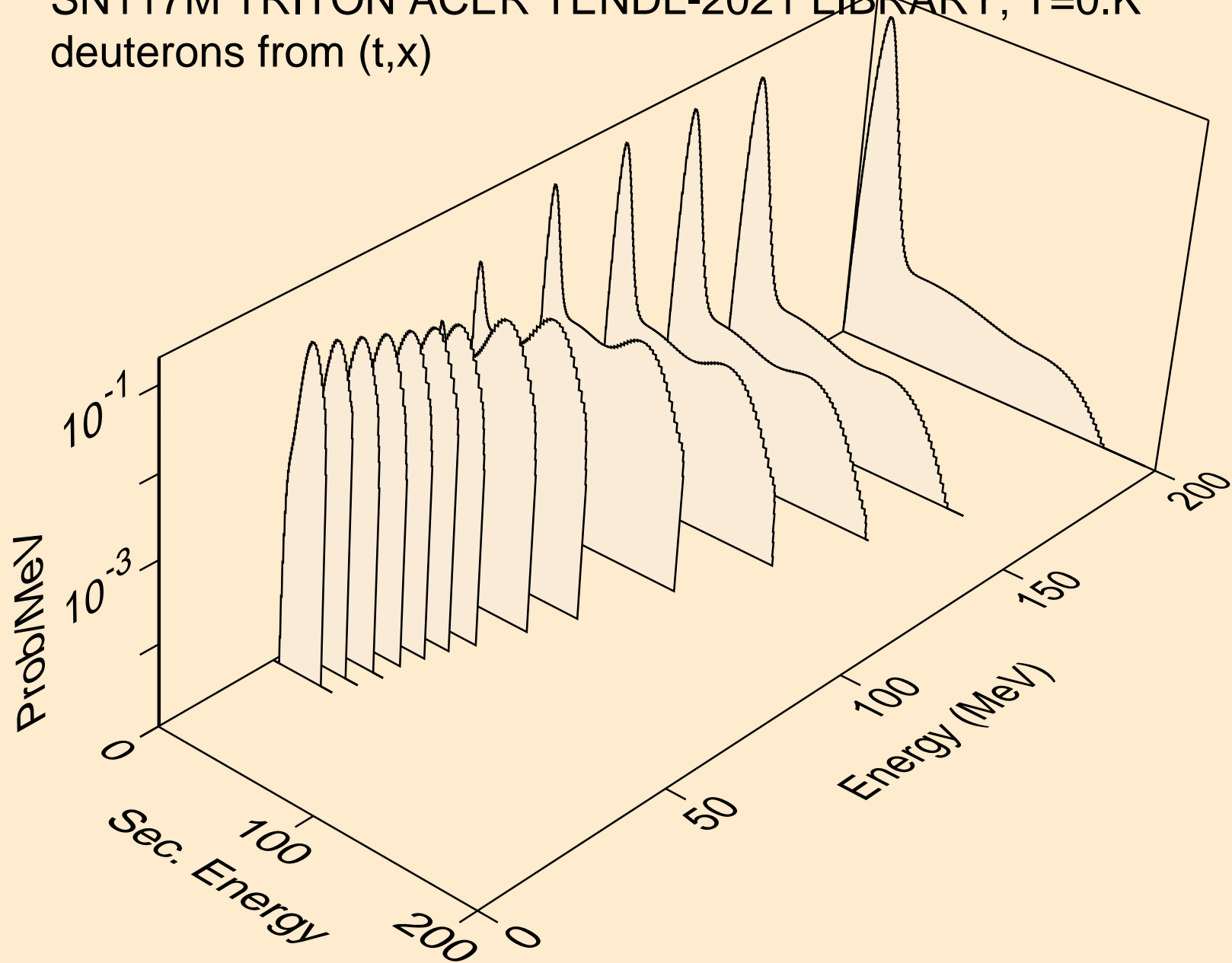

SN117M TRITON ACER TENDL-2021 LIBRARY; T=0.K  
deuterons from (t,2nd)

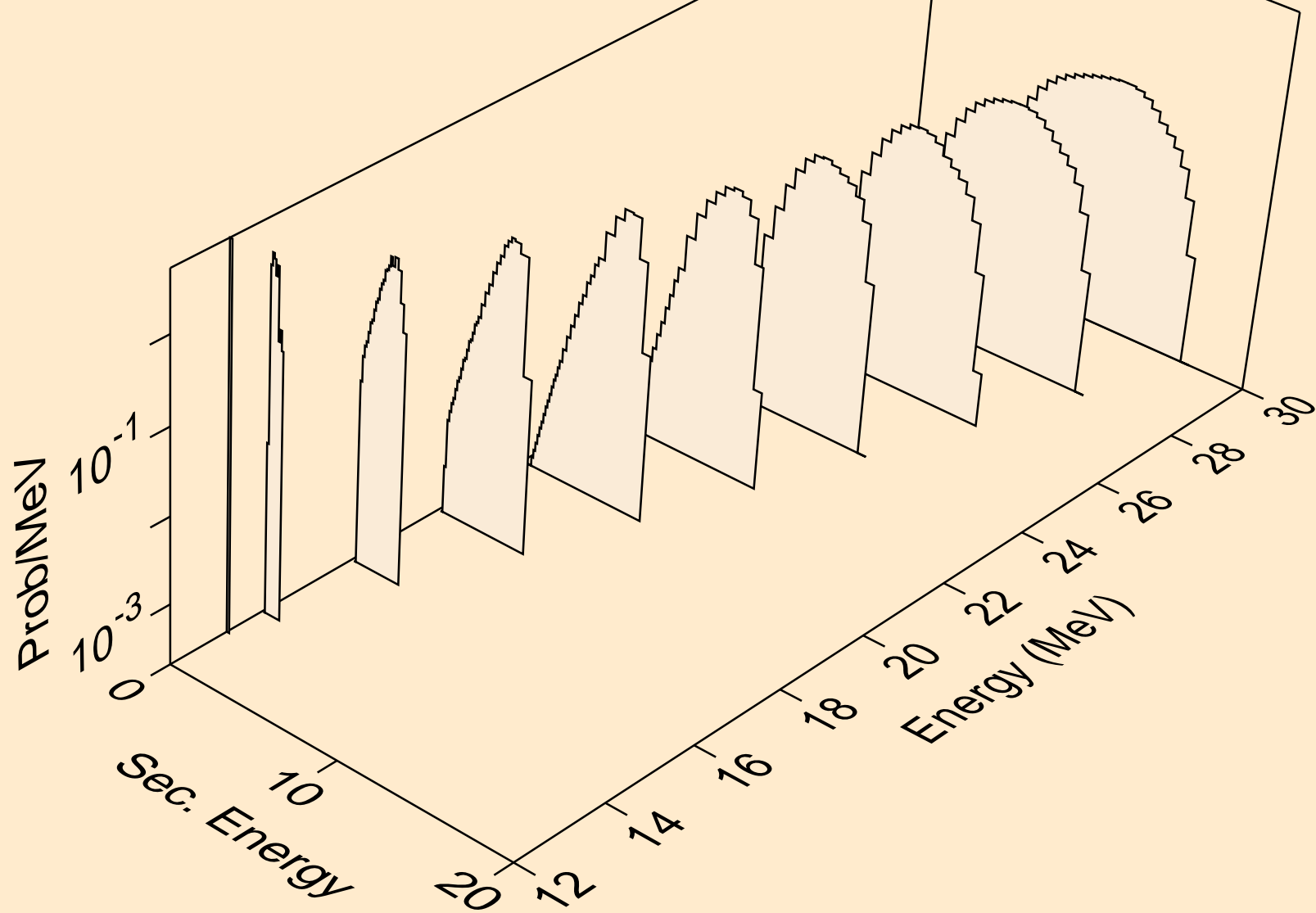

SN117M TRITON ACER TENDL-2021 LIBRARY; T=0.K  
deuterons from (t,n\*)d

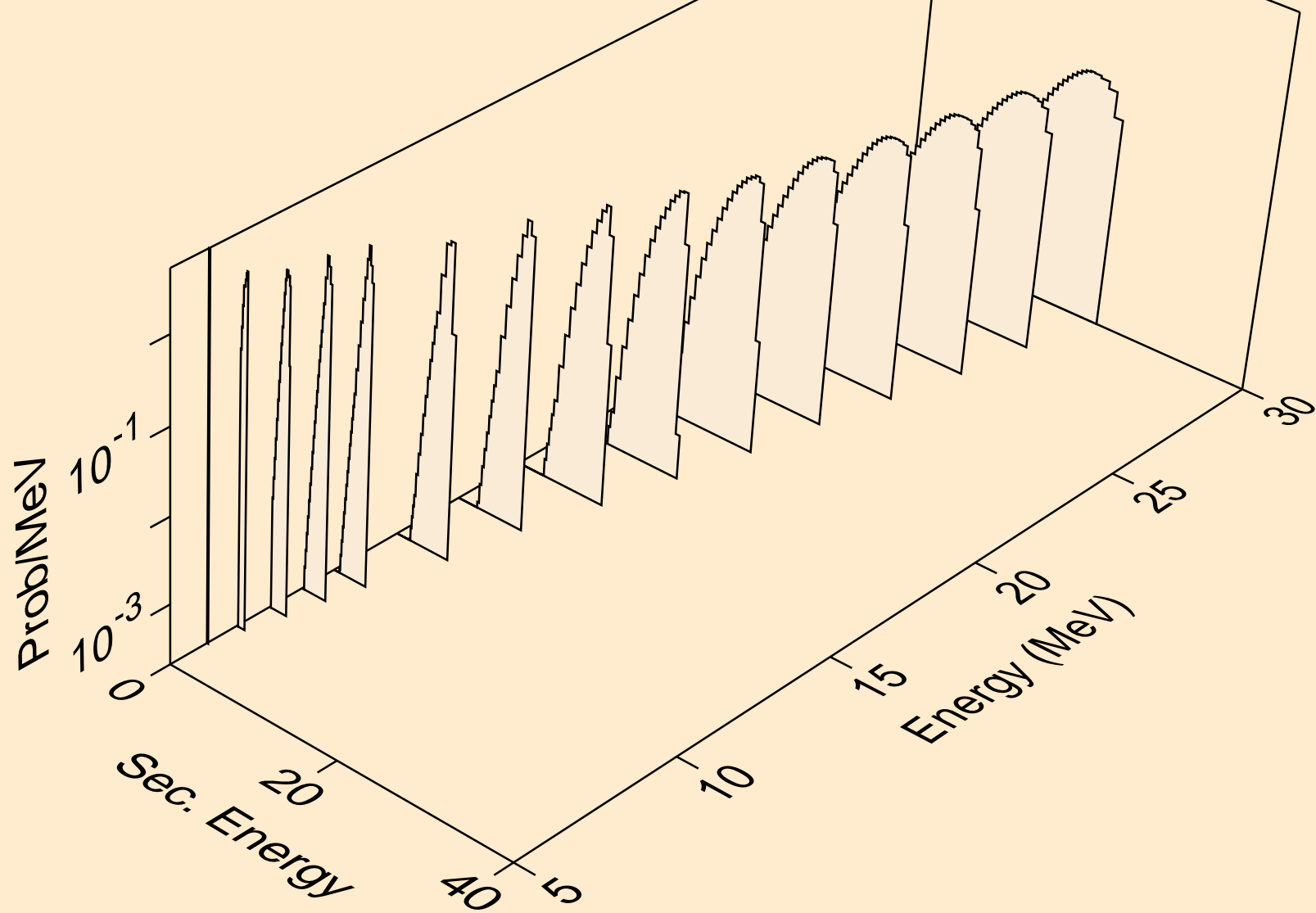

SN117M TRITON ACER TENDL-2021 LIBRARY; T=0.K  
deuterons from (t,d)

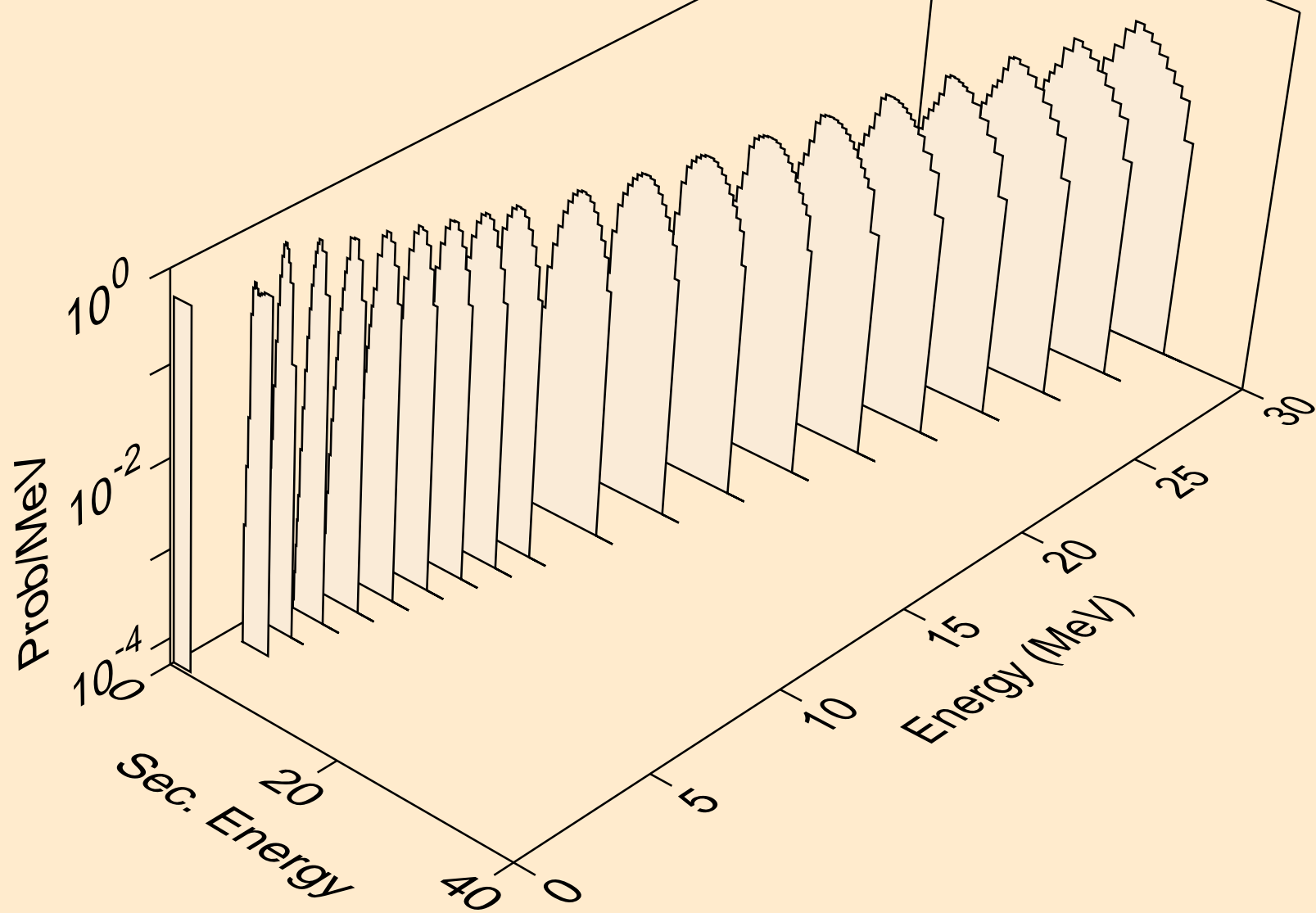

SN117M TRITON ACER TENDL-2021 LIBRARY; T=0.K  
deuterons from (t,pd)

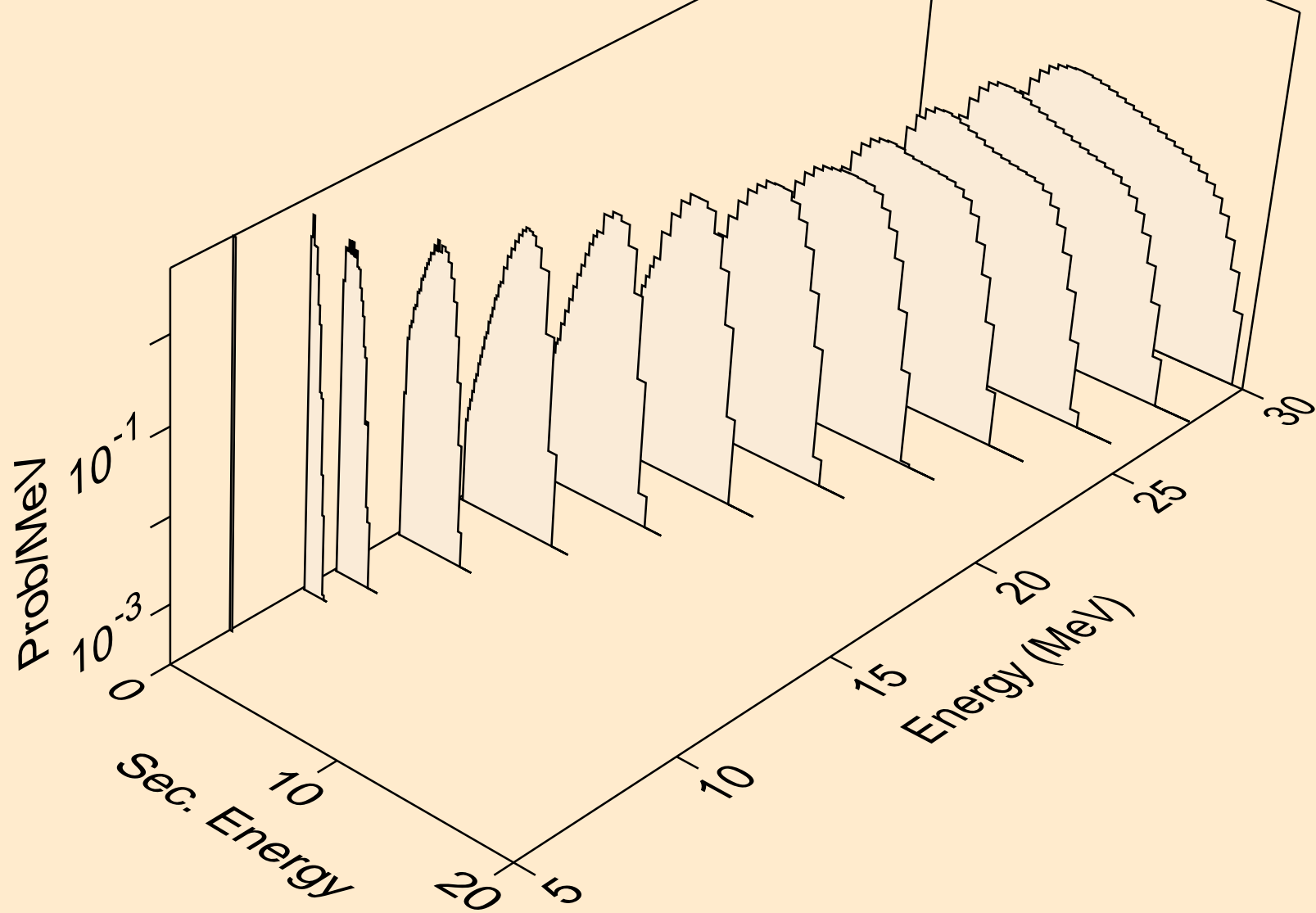



SN117M TRITON ACER TENDL-2021 LIBRARY; T=0.K  
deuterons from (t,da)

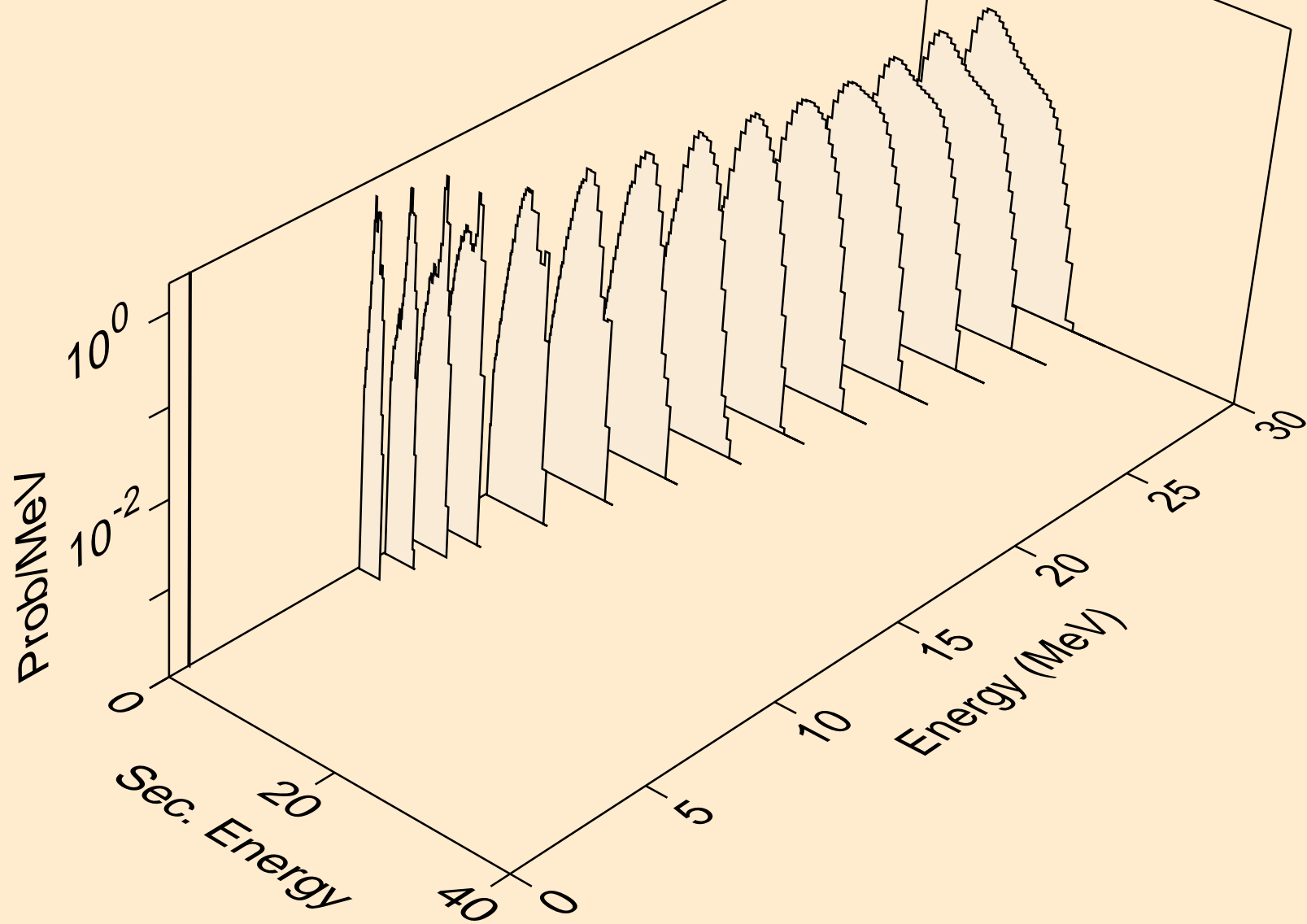

SN117M TRITON ACER TENDL-2021 LIBRARY; T=0.K  
he3s from (t,x)

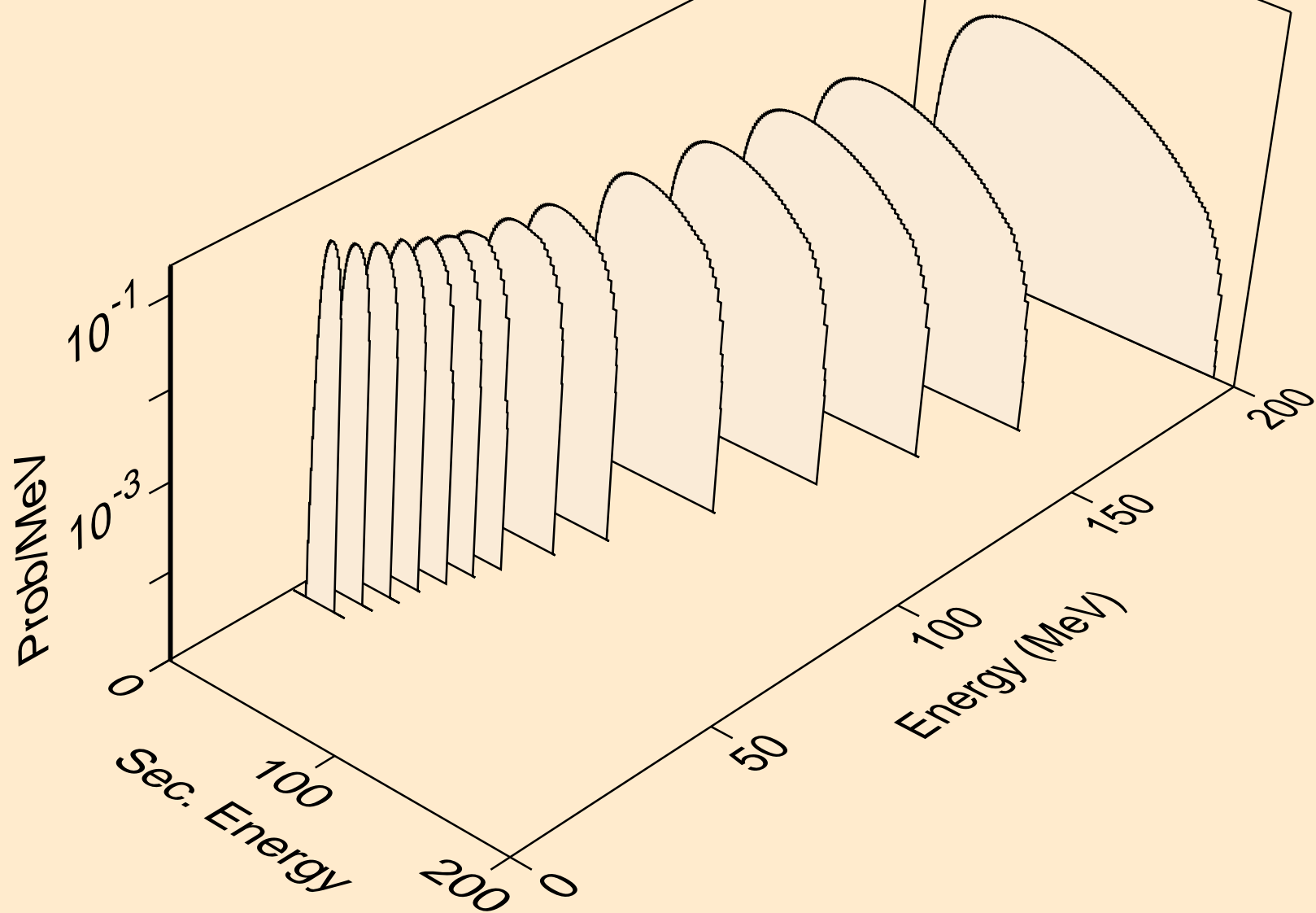

SN117M TRITON ACER TENDL-2021 LIBRARY; T=0.K  
he3s from (t,n\*)he3

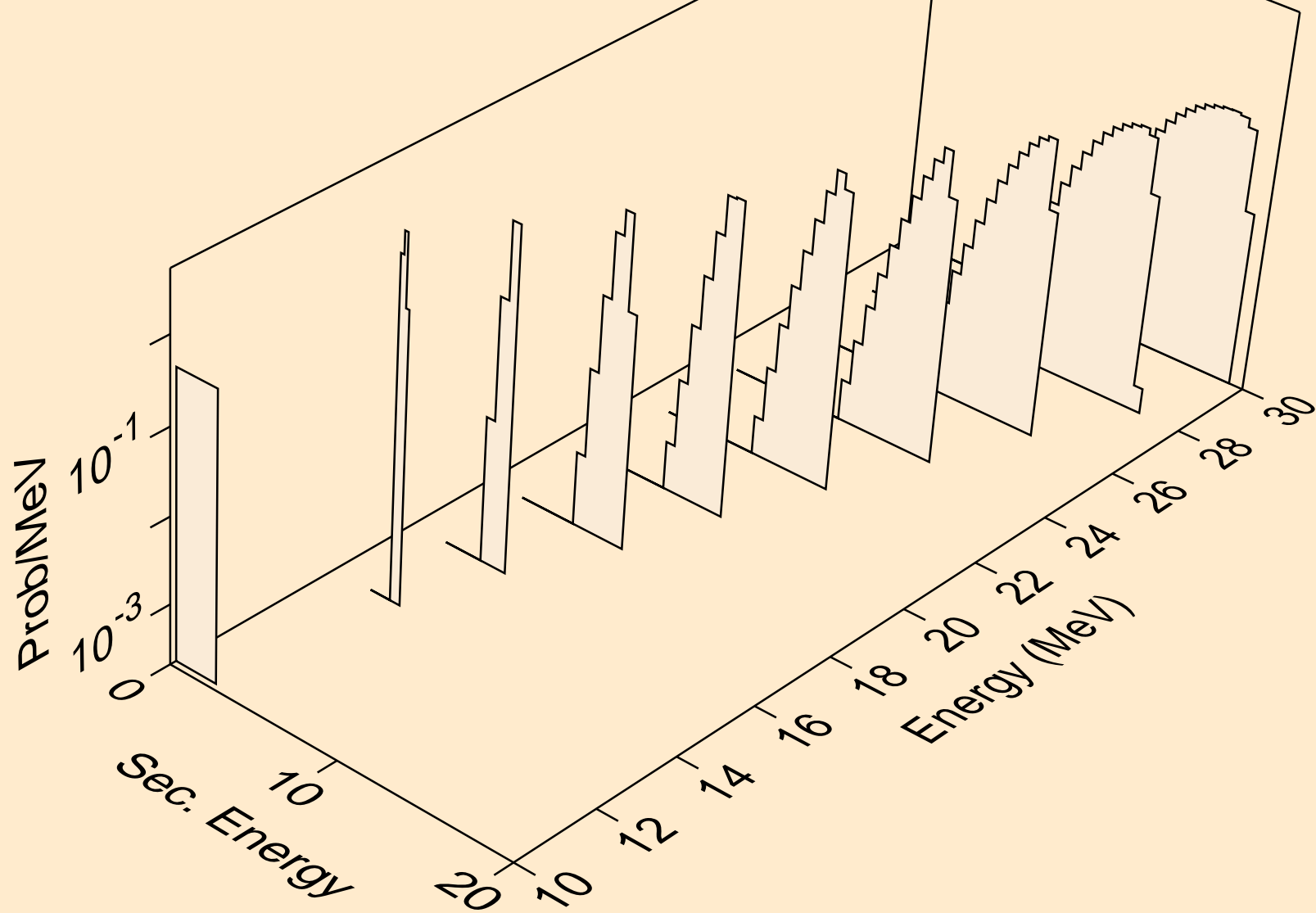

SN117M TRITON ACER TENDL-2021 LIBRARY; T=0.K  
he3s from (t,he3)

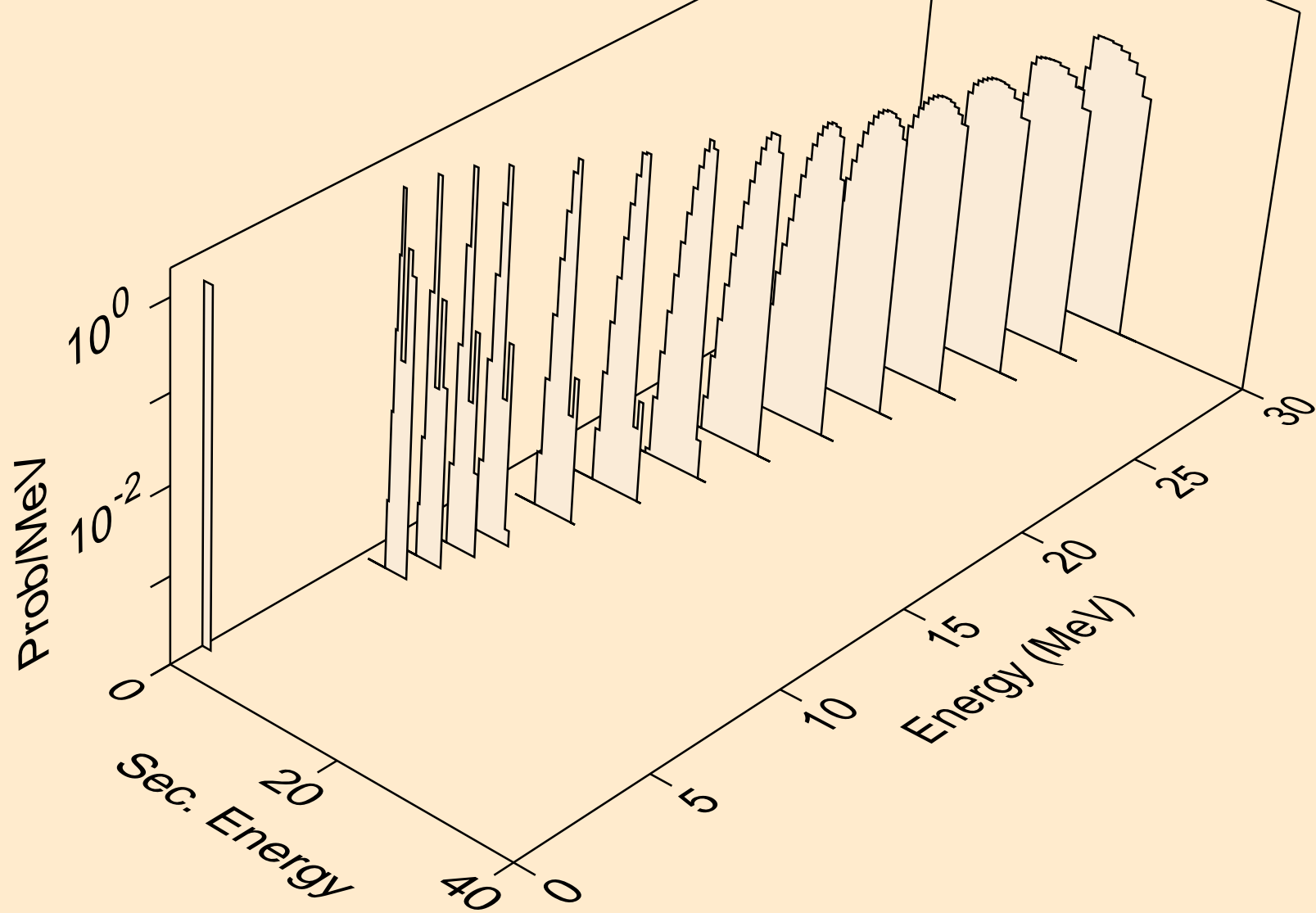

SN117M TRITON ACER TENDL-2021 LIBRARY; T=0.K  
alphas from (t,x)

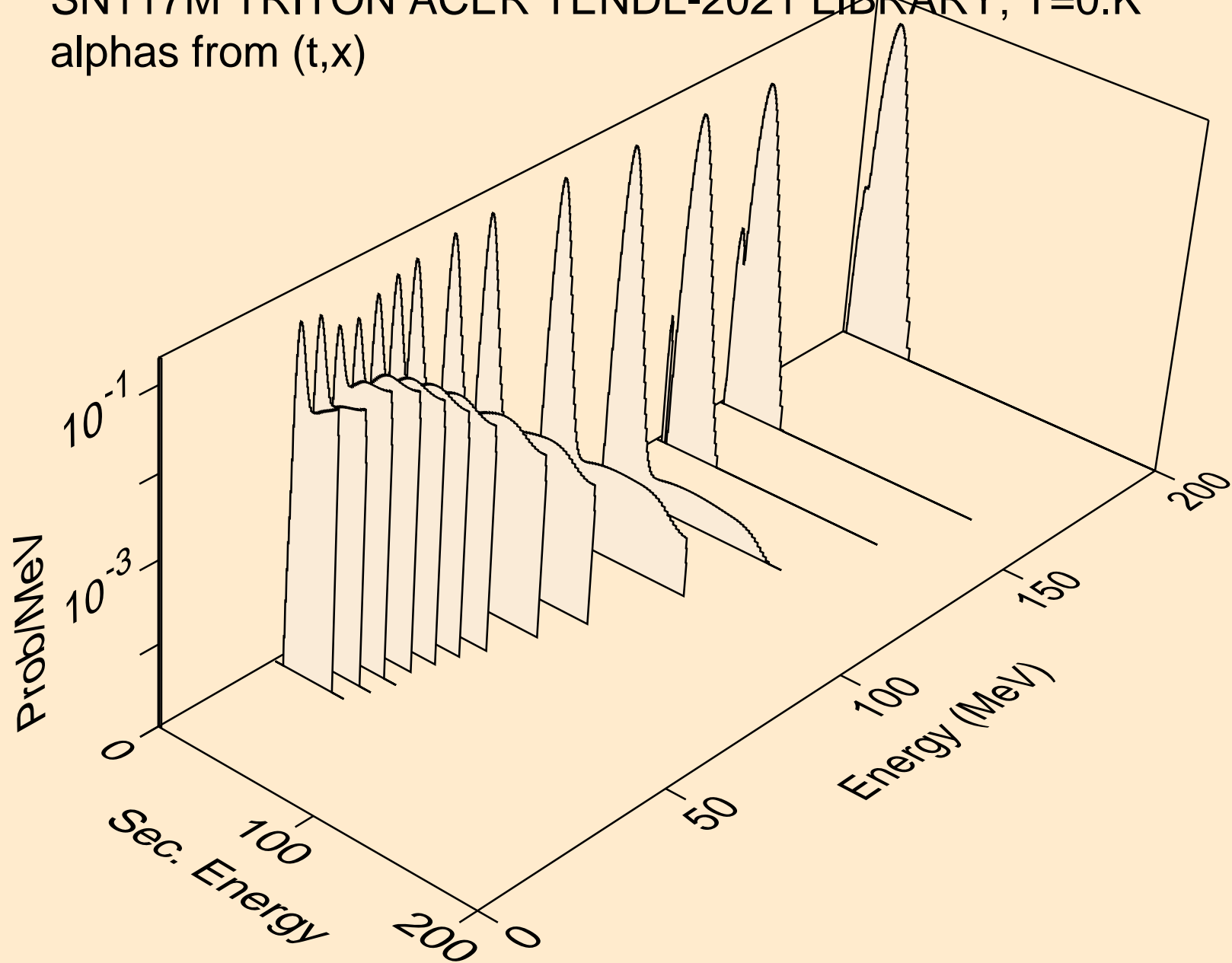

SN117M TRITON ACER TENDL-2021 LIBRARY; T=0.K  
alphas from (t,n\*)a

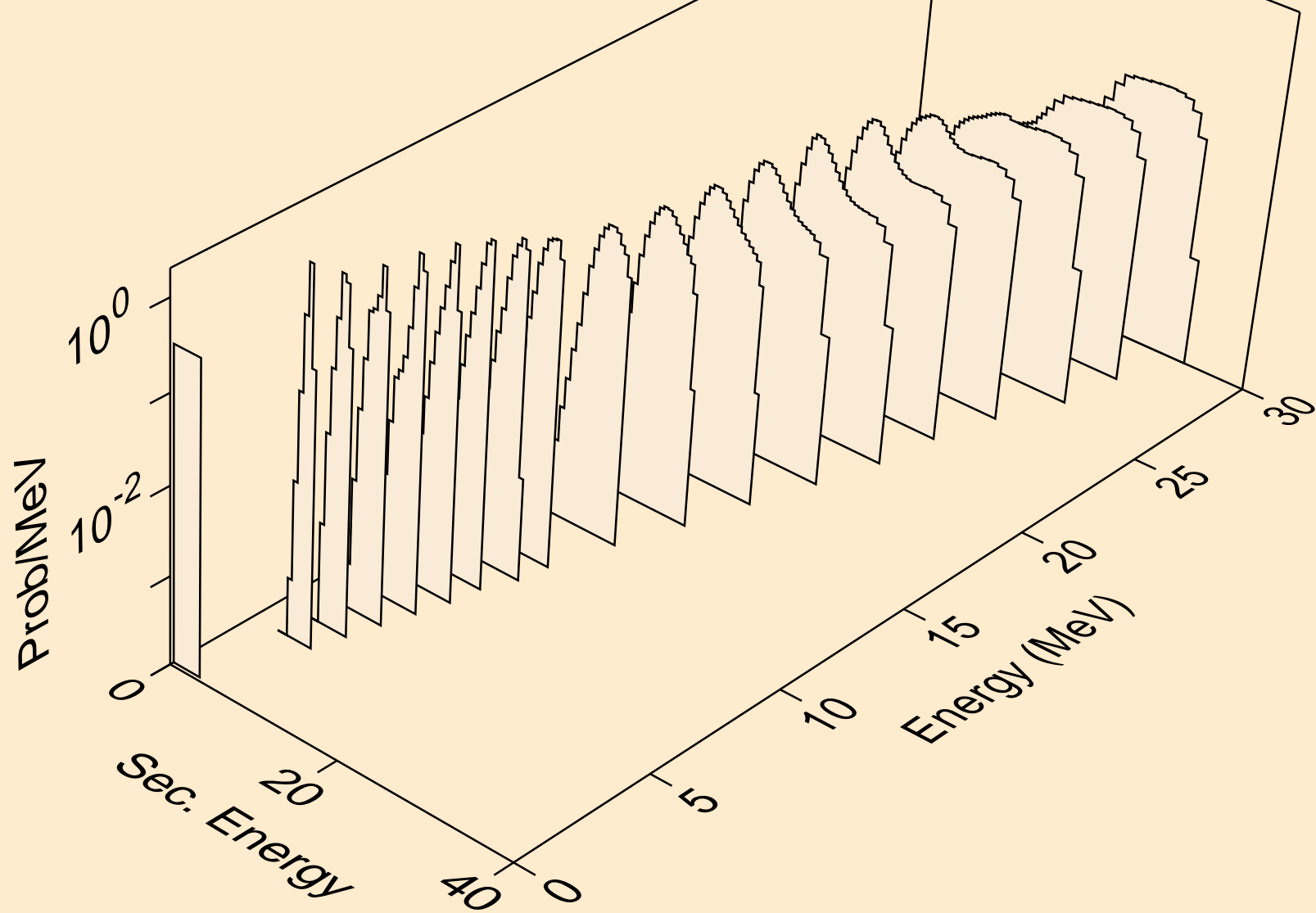

SN117M TRITON ACER TENDL-2021 LIBRARY; T=0.K  
alphas from (t,2n)a

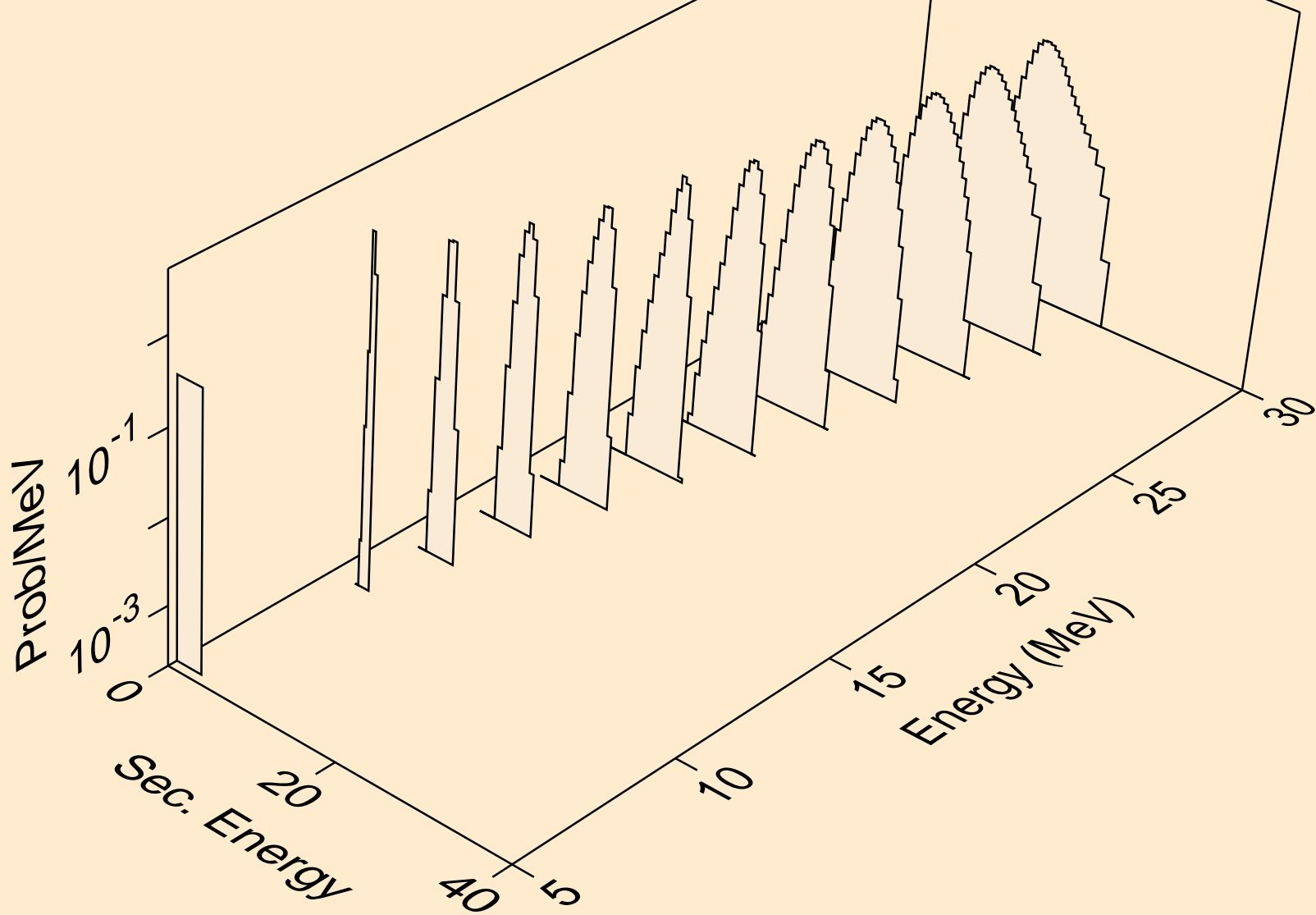

SN117M TRITON ACER TENDL-2021 LIBRARY; T=0.K  
alphas from (t,3n)a

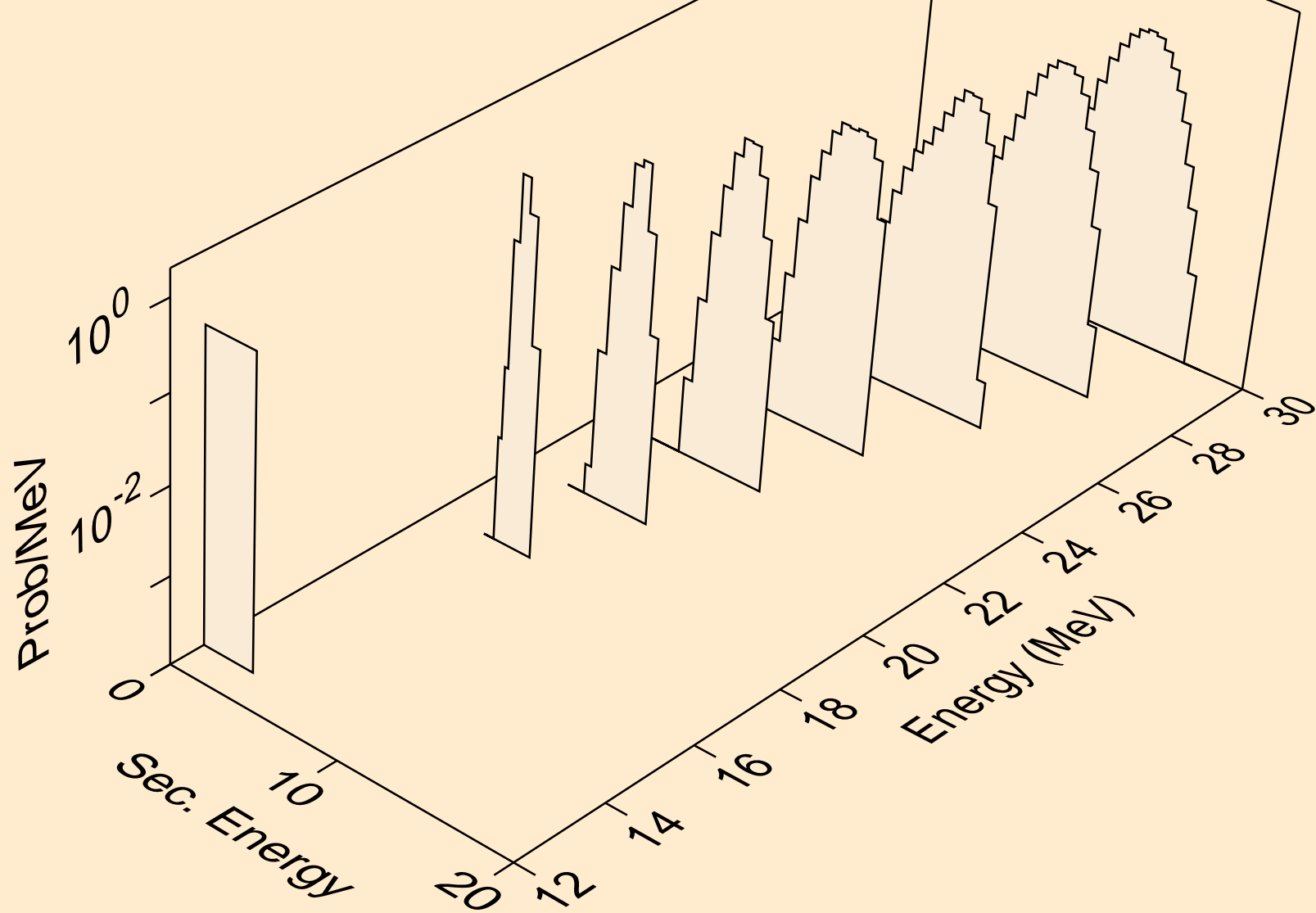



SN117M TRITON ACER TENDL-2021 LIBRARY; T=0.K  
alphas from (t,n\*)2a

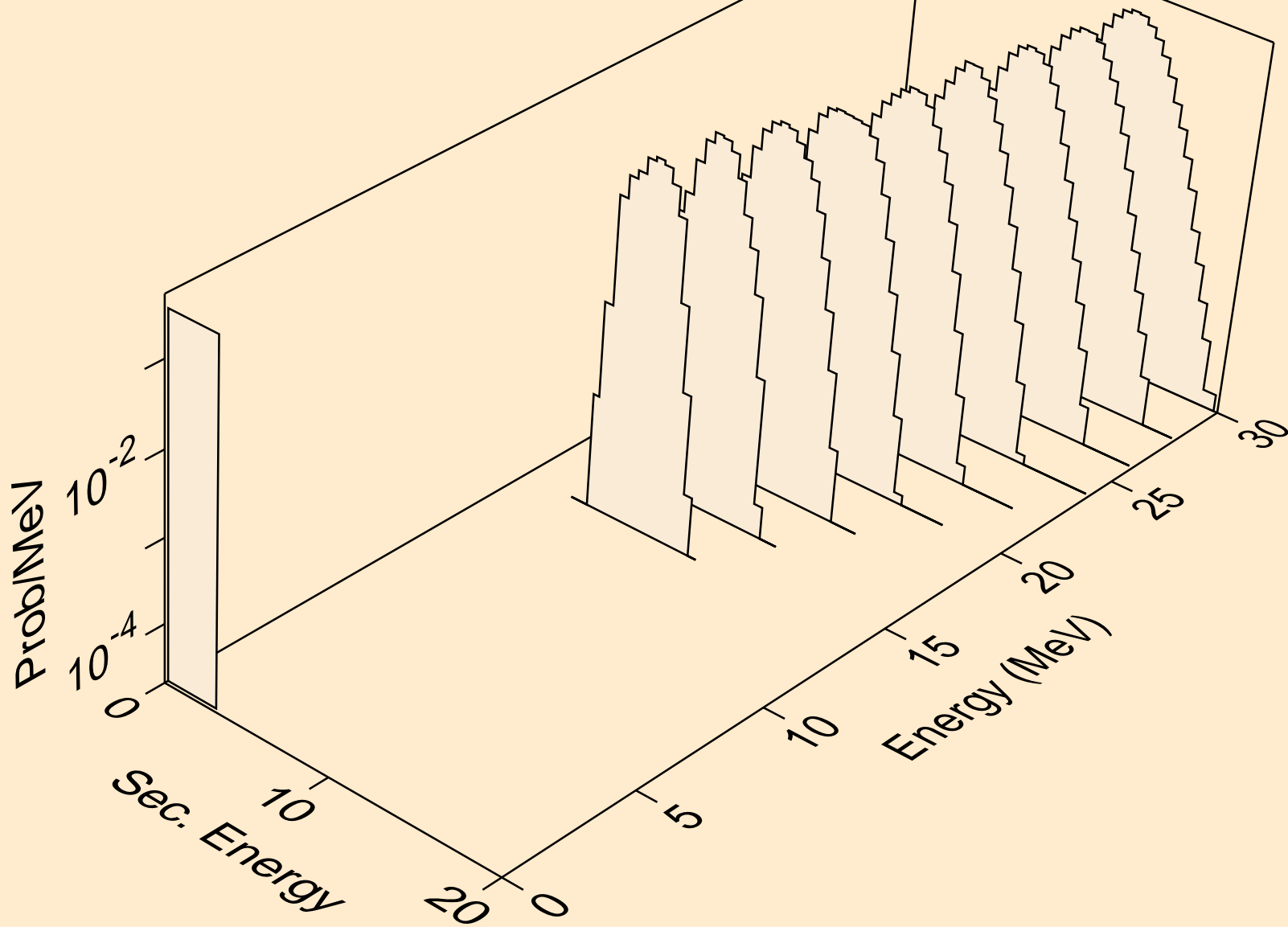

SN117M TRITON ACER TENDL-2021 LIBRARY; T=0.K  
alphas from (t,npa)

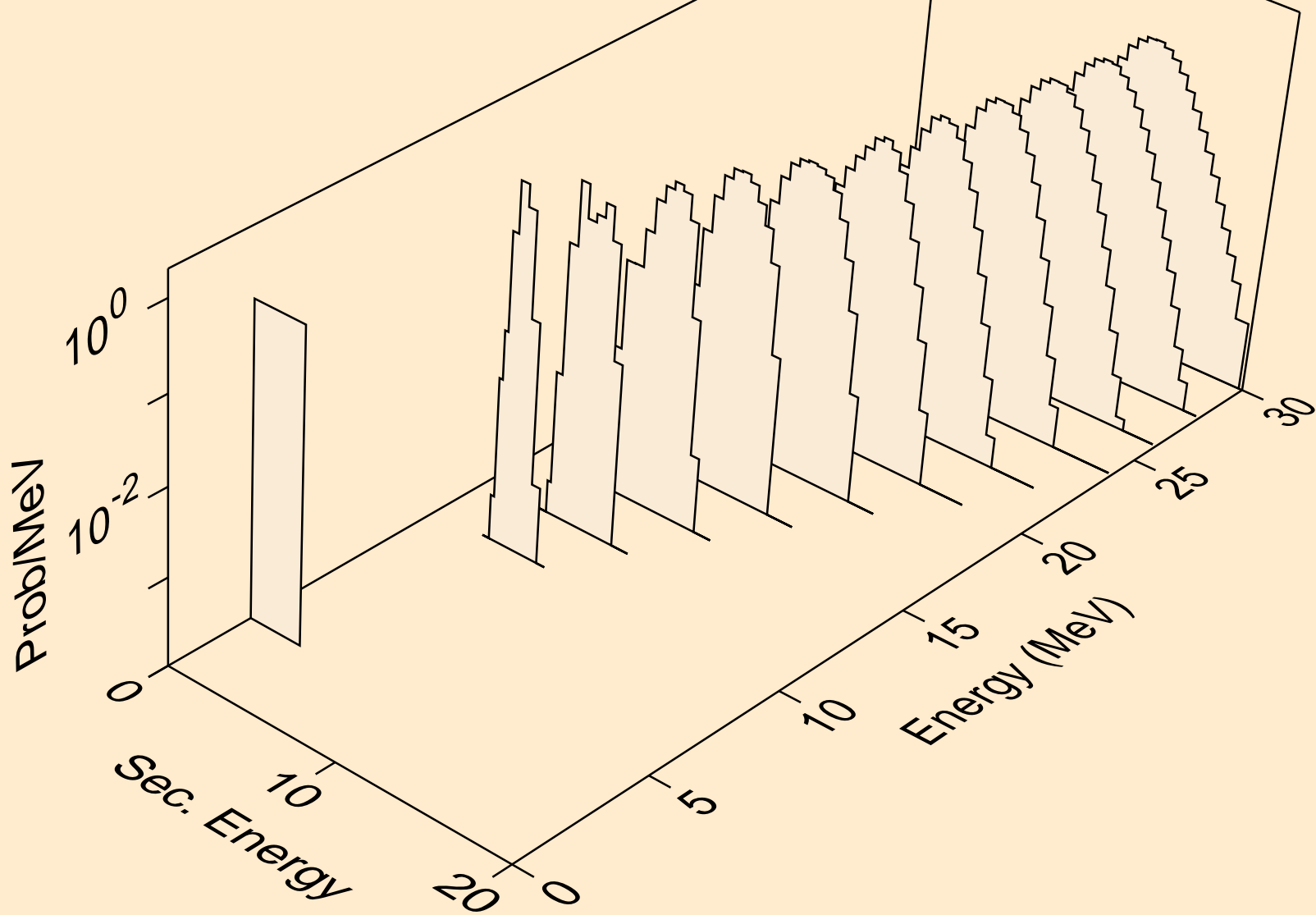

SN117M TRITON ACER TENDL-2021 LIBRARY; T=0.K  
alphas from (t,a)

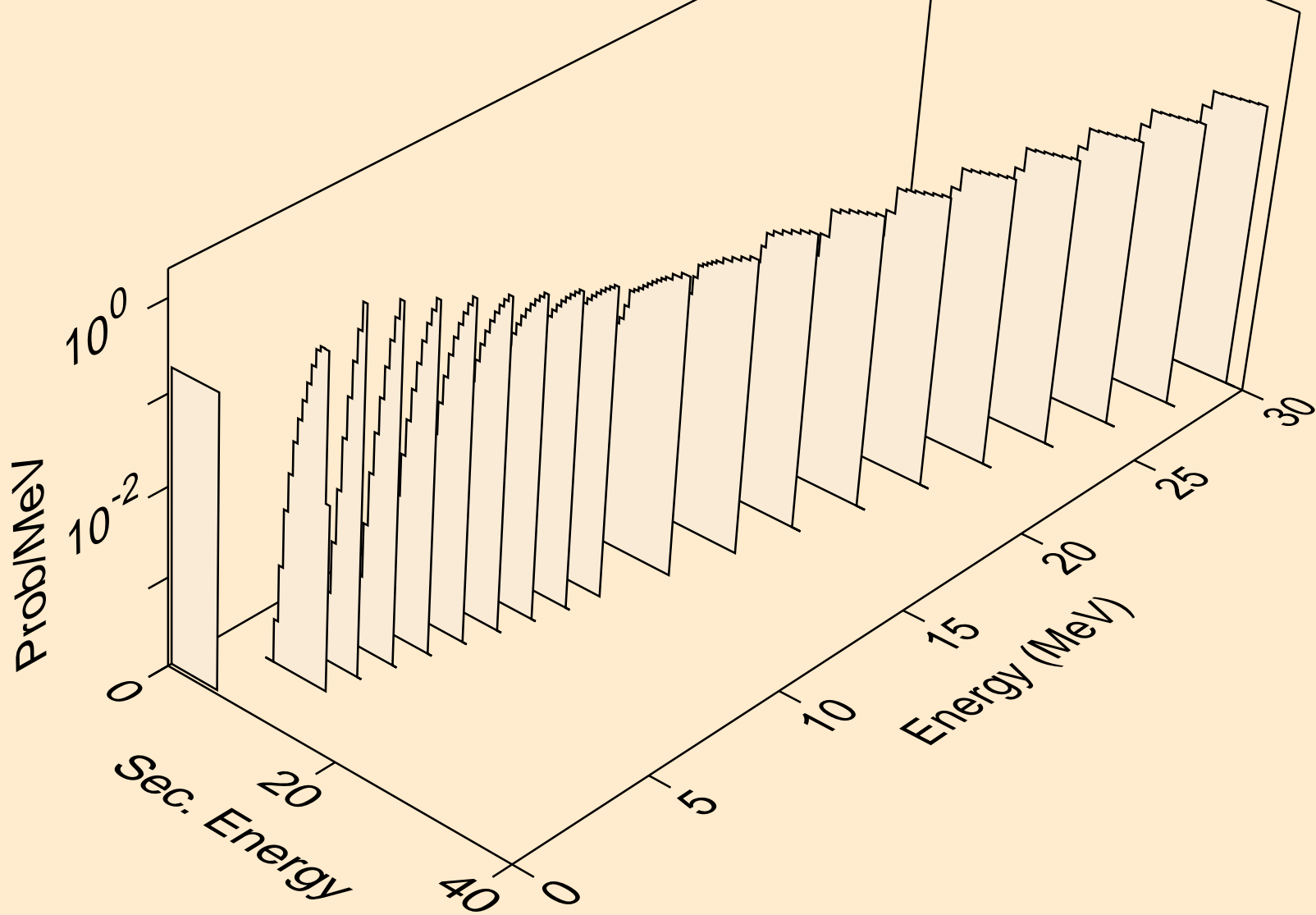

SN117M TRITON ACER TENDL-2021 LIBRARY; T=0.K  
alphas from (t,2a)

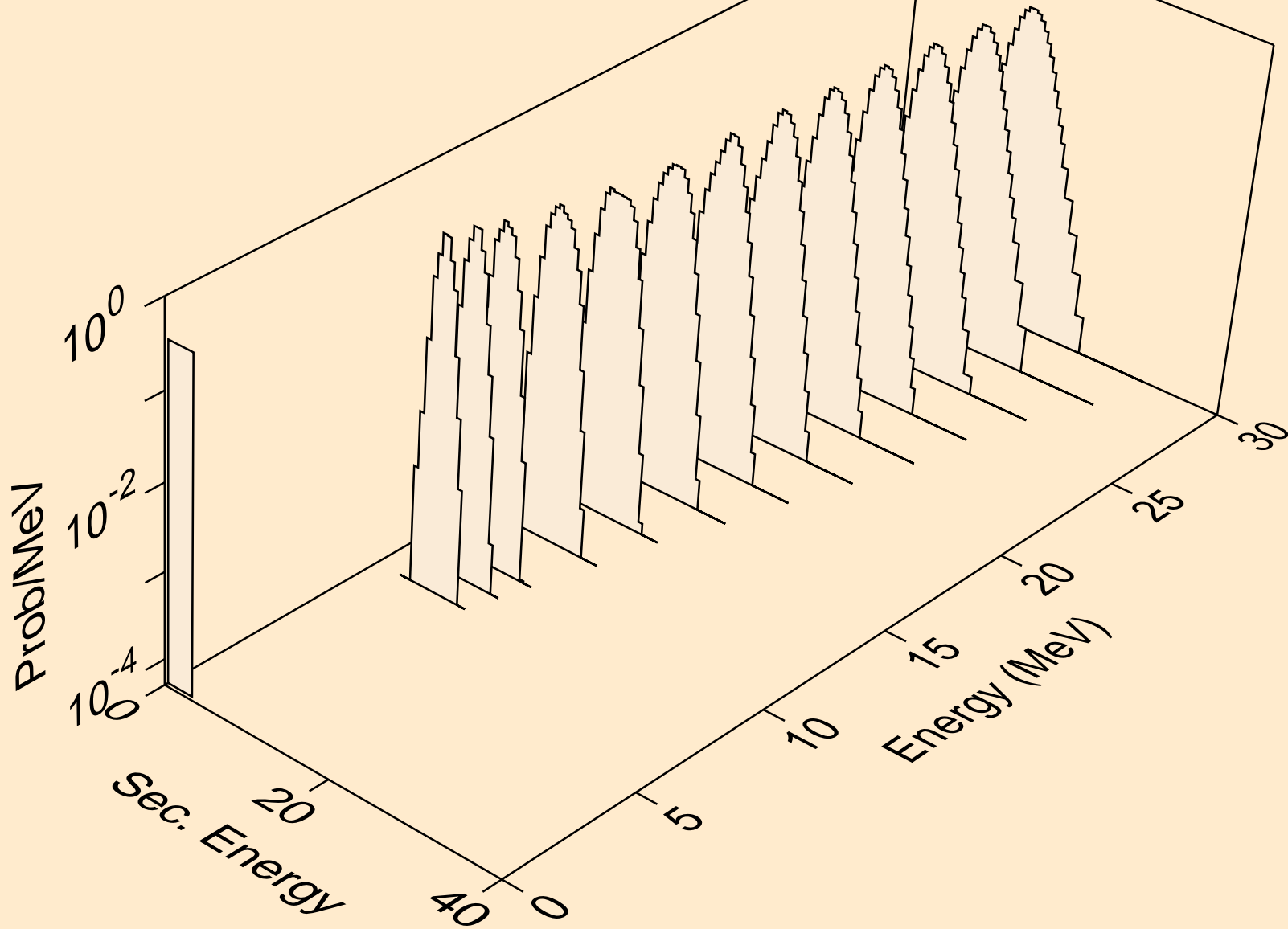

SN117M TRITON ACER TENDL-2021 LIBRARY; T=0.K  
alphas from (t,pa)

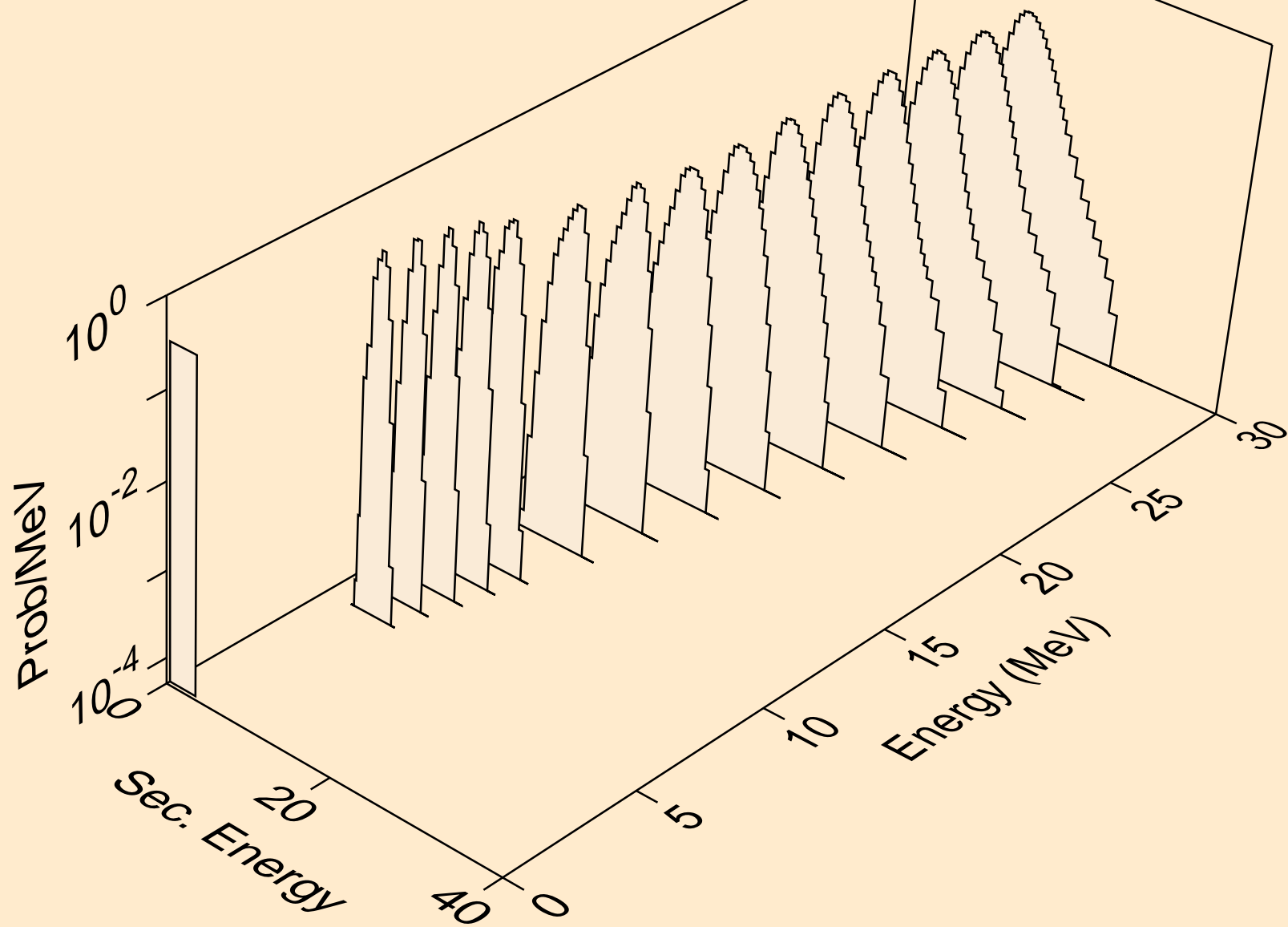

SN117M TRITON ACER TENDL-2021 LIBRARY; T=0.K  
alphas from (t,da)

