

TA164 TRITON ACER TENDL-2021 LIBRARY; T=0.K  
Principal cross sections

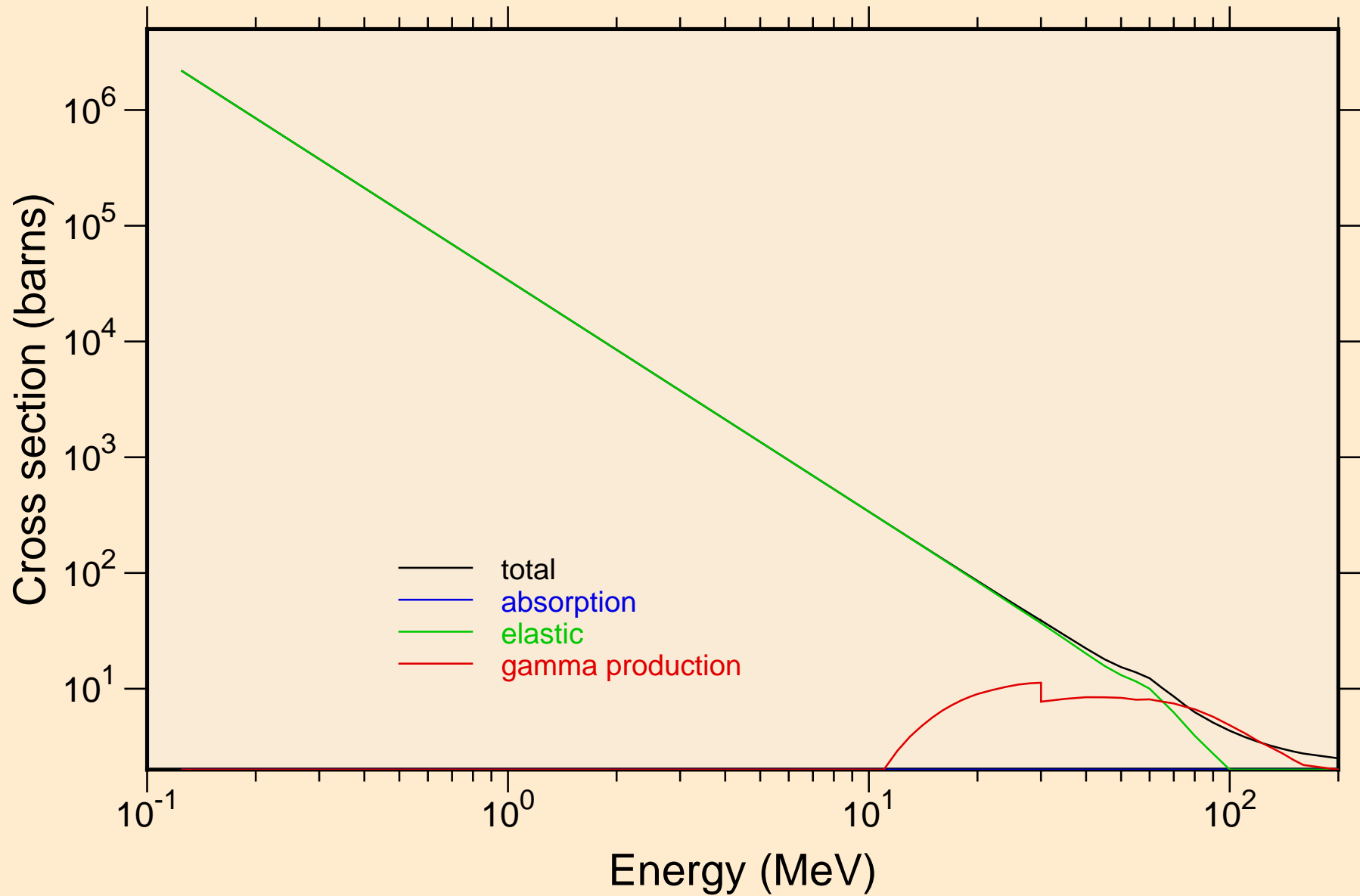

TA164 TRITON ACER TENDL-2021 LIBRARY; T=0.K  
Heating

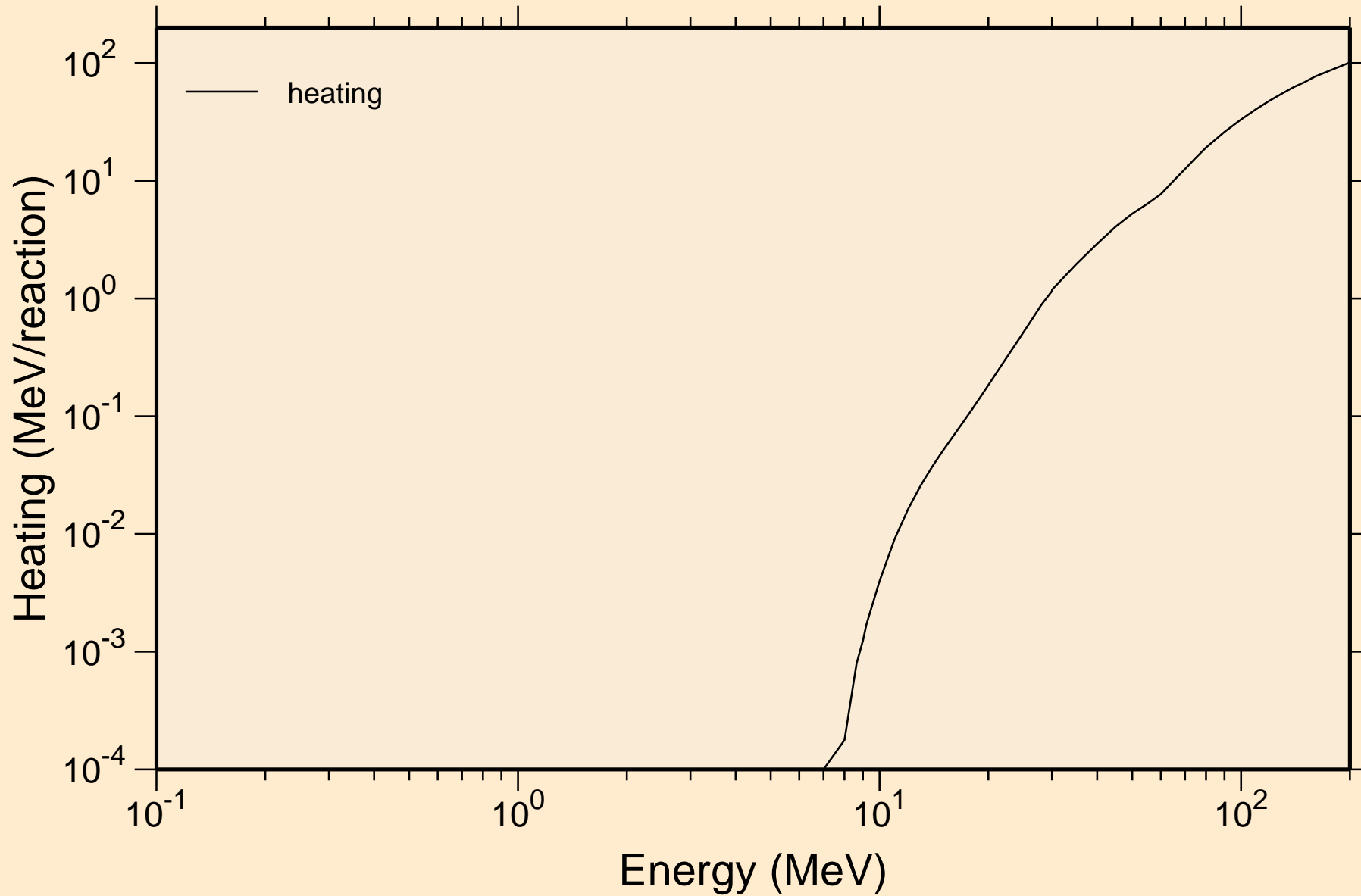

# TA164 TRITON ACER TENDL-2021 LIBRARY; T=0.K

## Principal cross sections

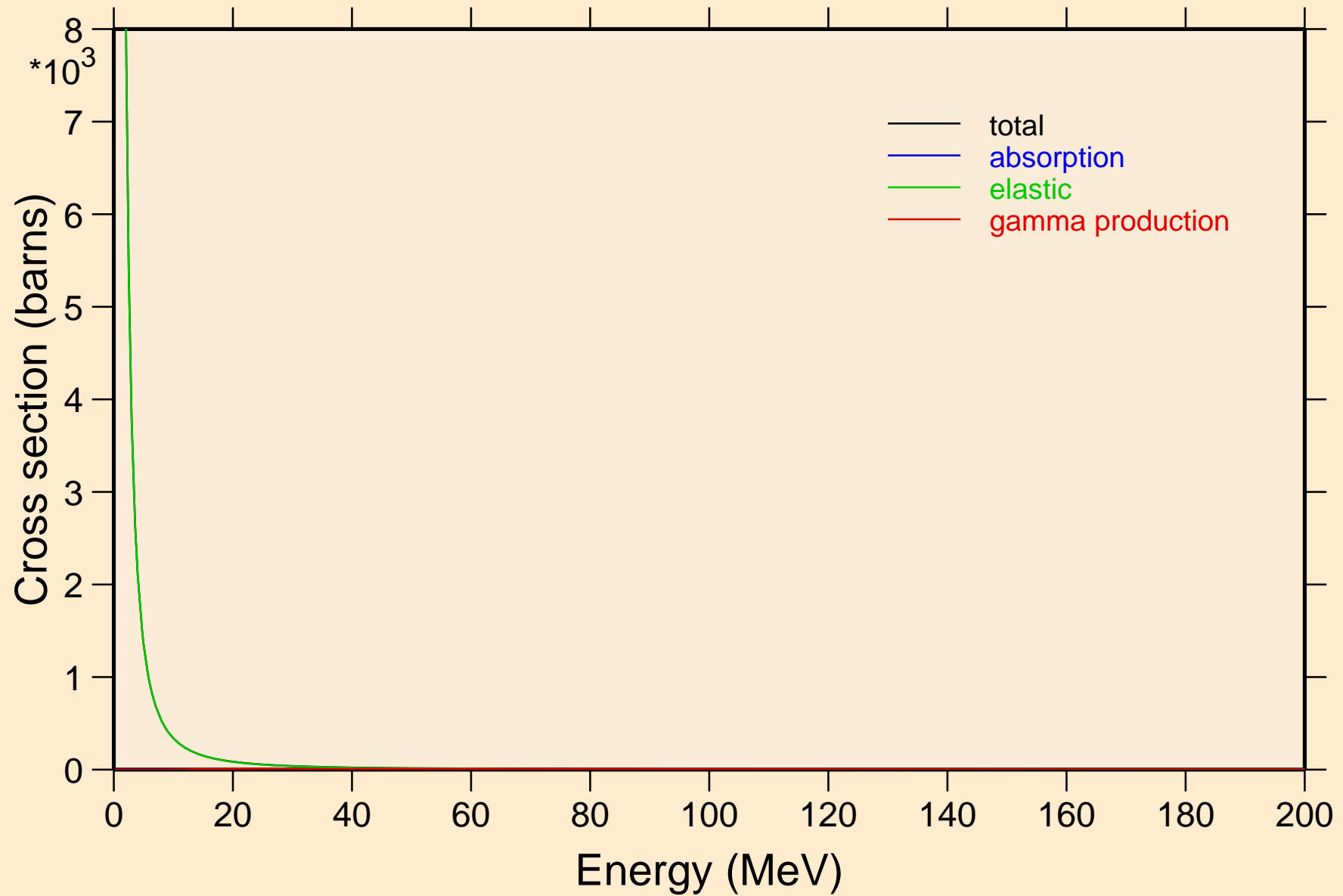

TA164 TRITON ACER TENDL-2021 LIBRARY; T=0.K

Heating

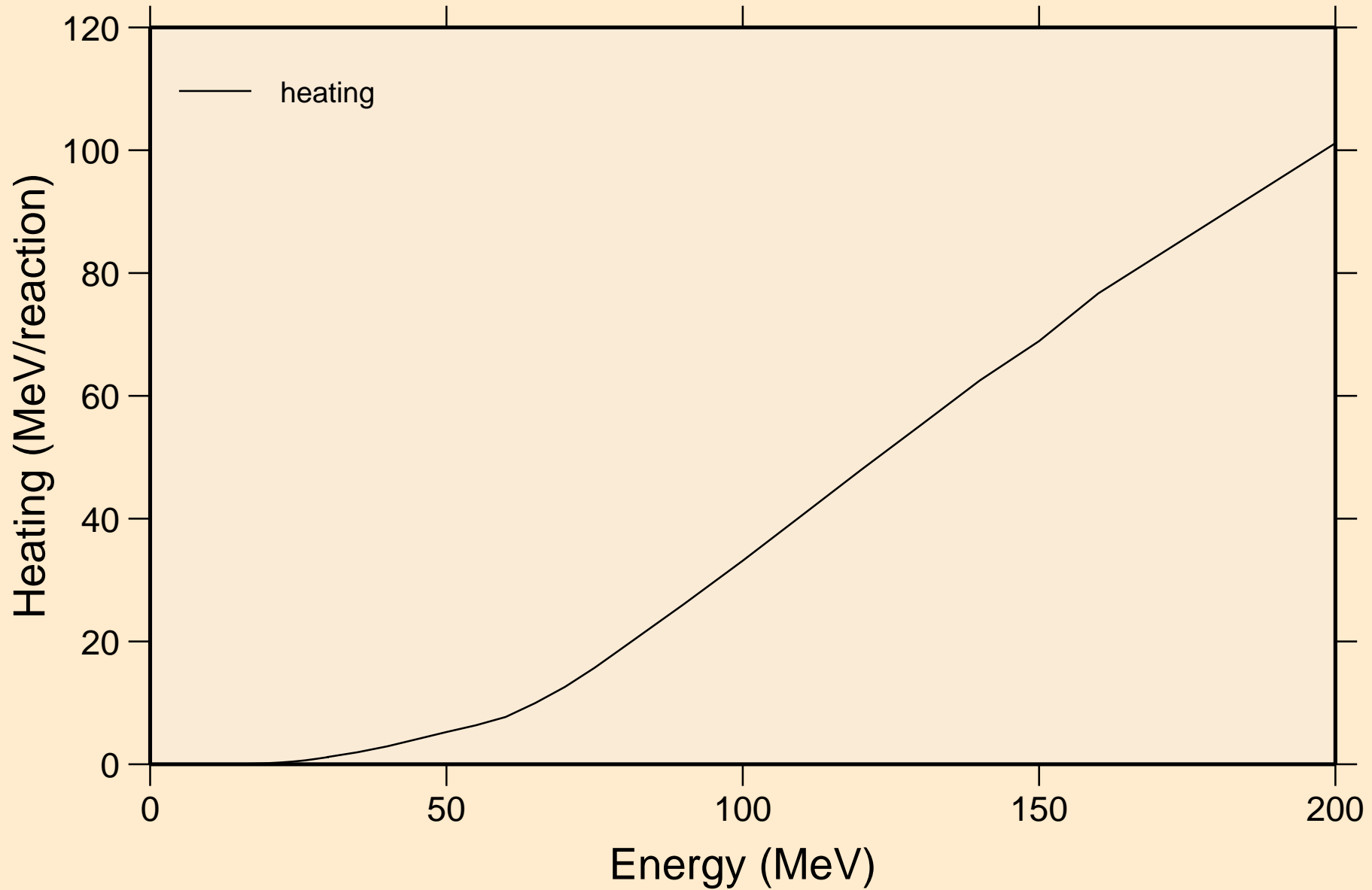

TA164 TRITON ACER TENDL-2021 LIBRARY; T=0.K  
Threshold reactions

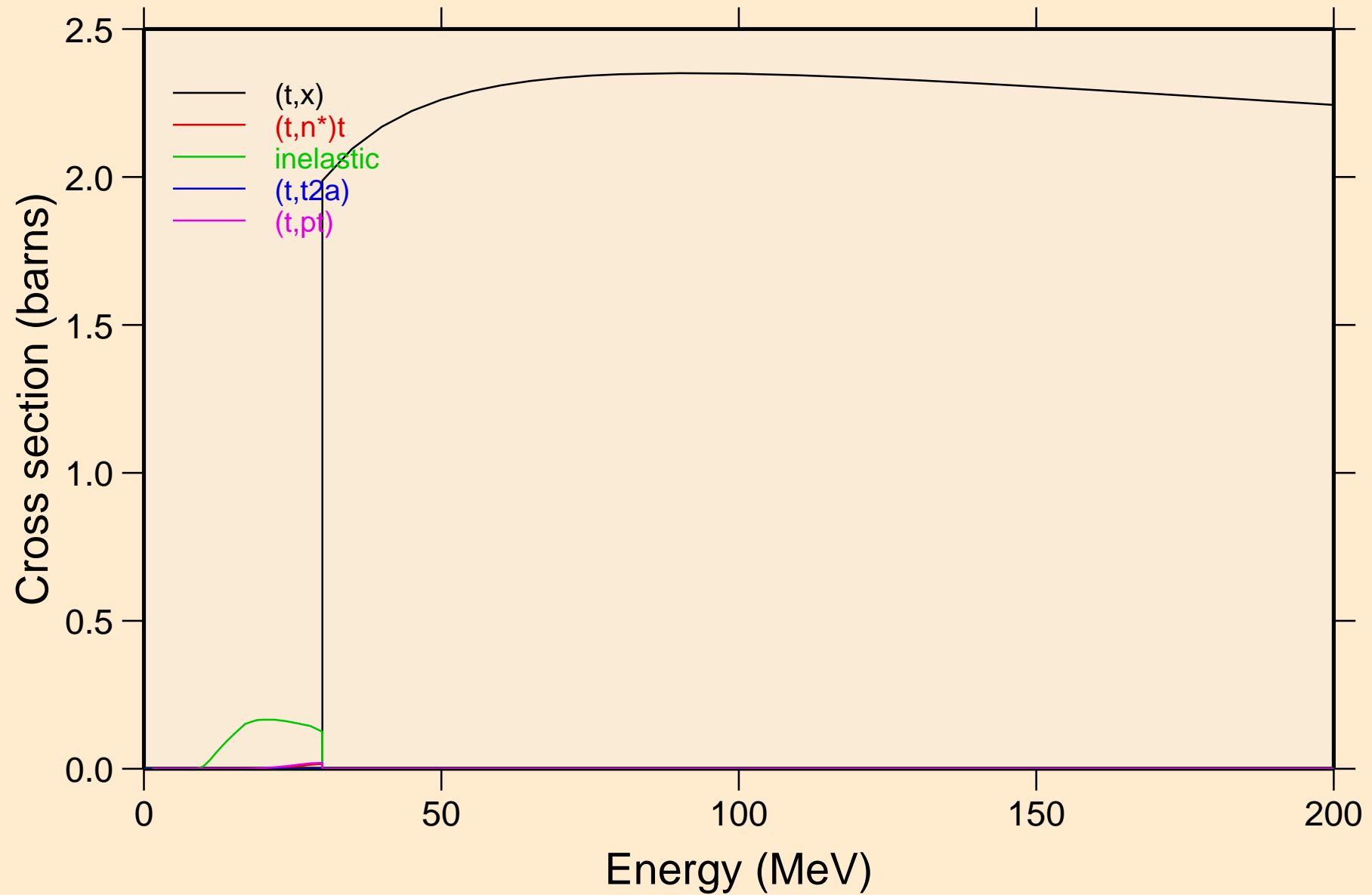

TA164 TRITON ACER TENDL-2021 LIBRARY; T=0.K  
Threshold reactions

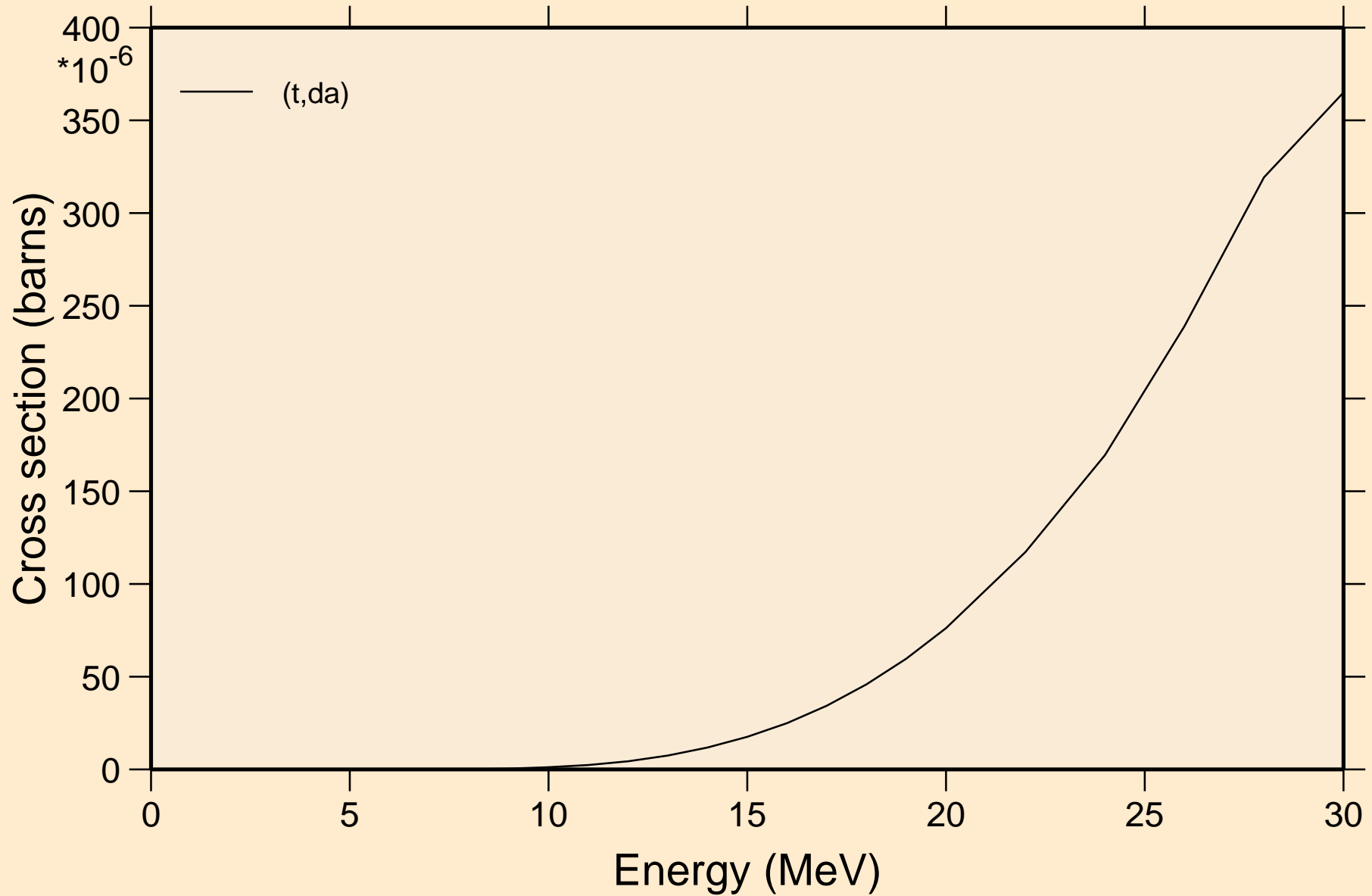

TA164 TRITON ACER TENDL-2021 LIBRARY; T=0.K  
angular distribution for elastic

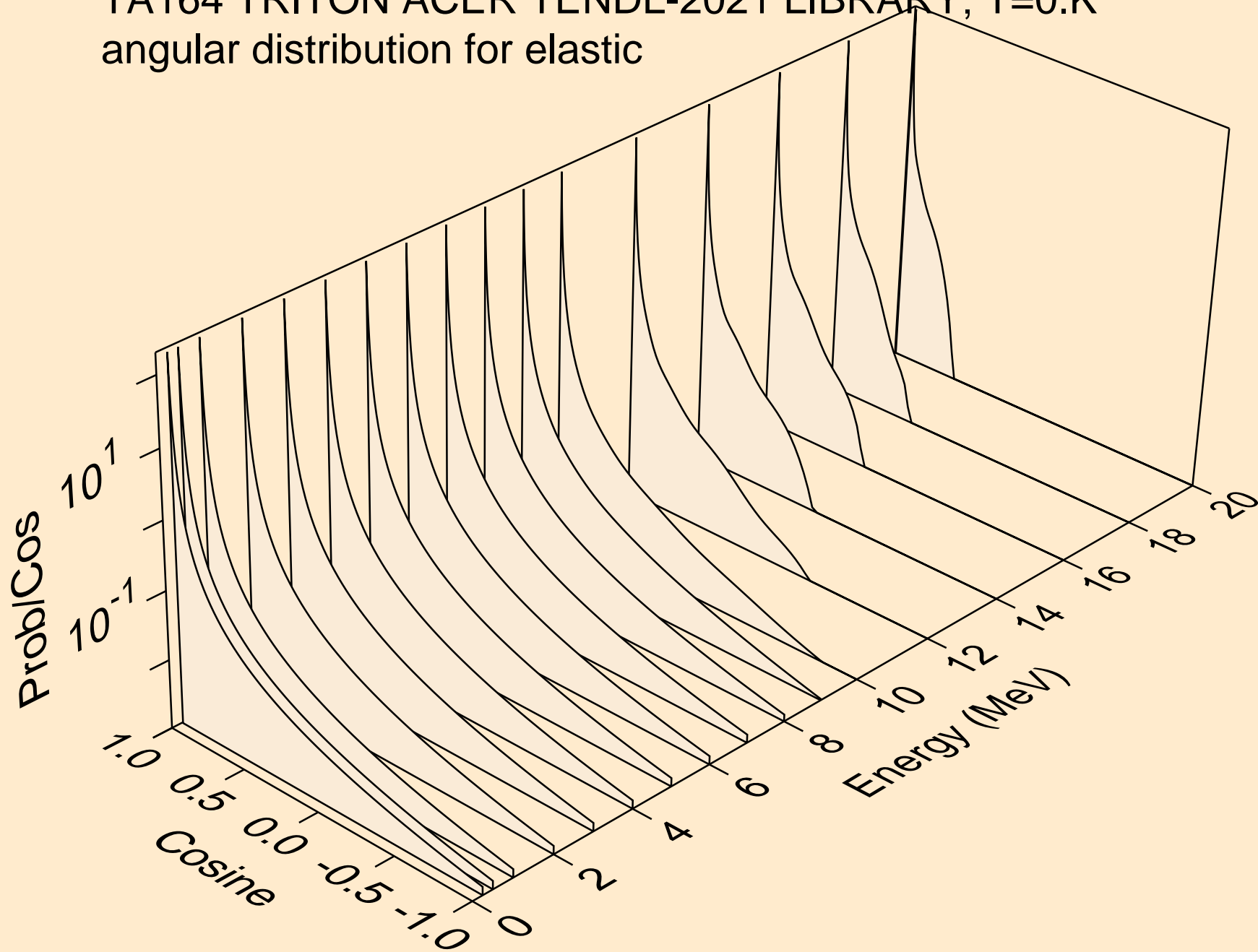

TA164 TRITON ACER TENDL-2021 LIBRARY; T=0.K  
angular distribution for elastic

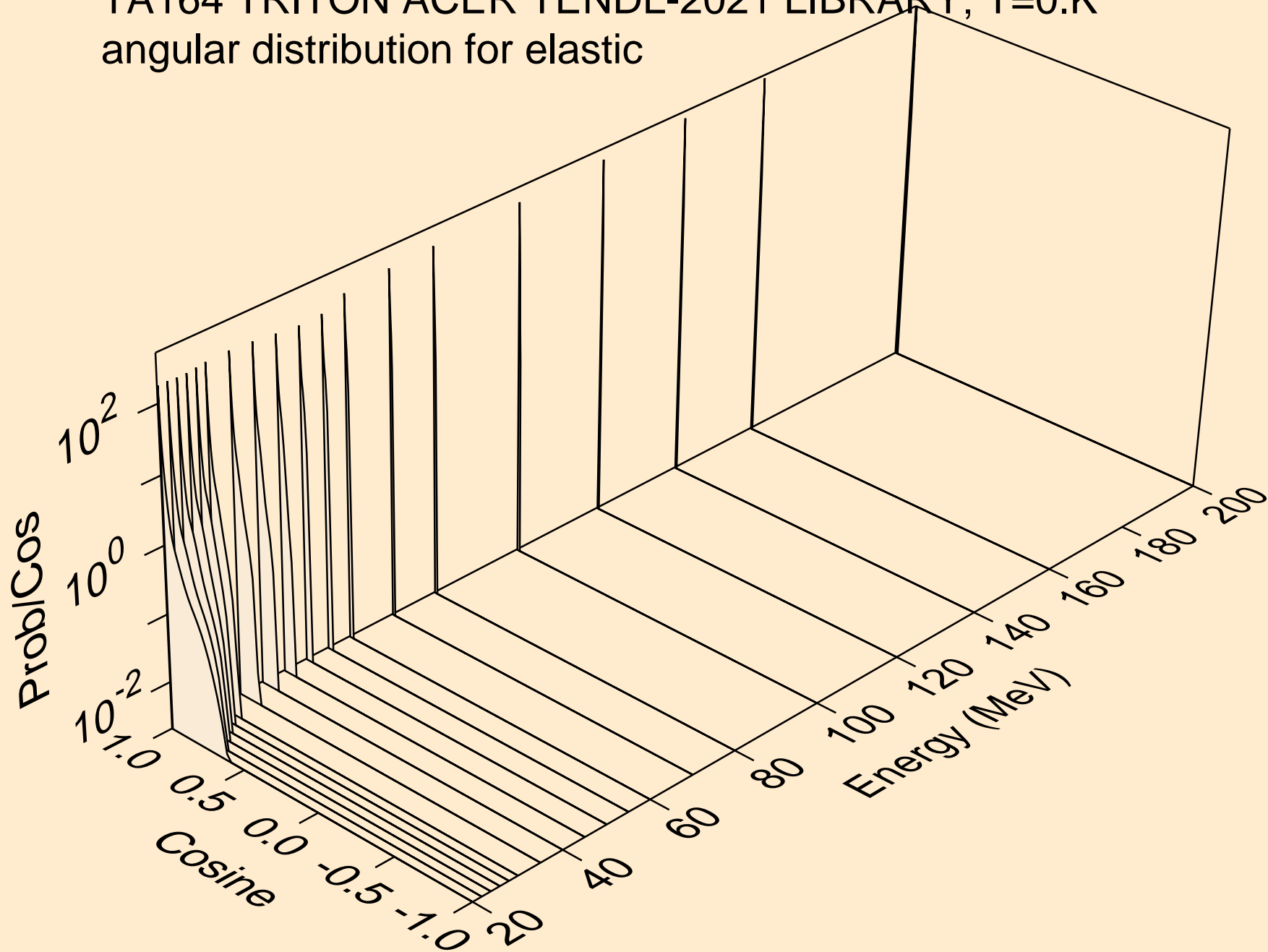



TA164 TRITON ACER TENDL-2021 LIBRARY; T=0.K  
Triton emission for (t,x)

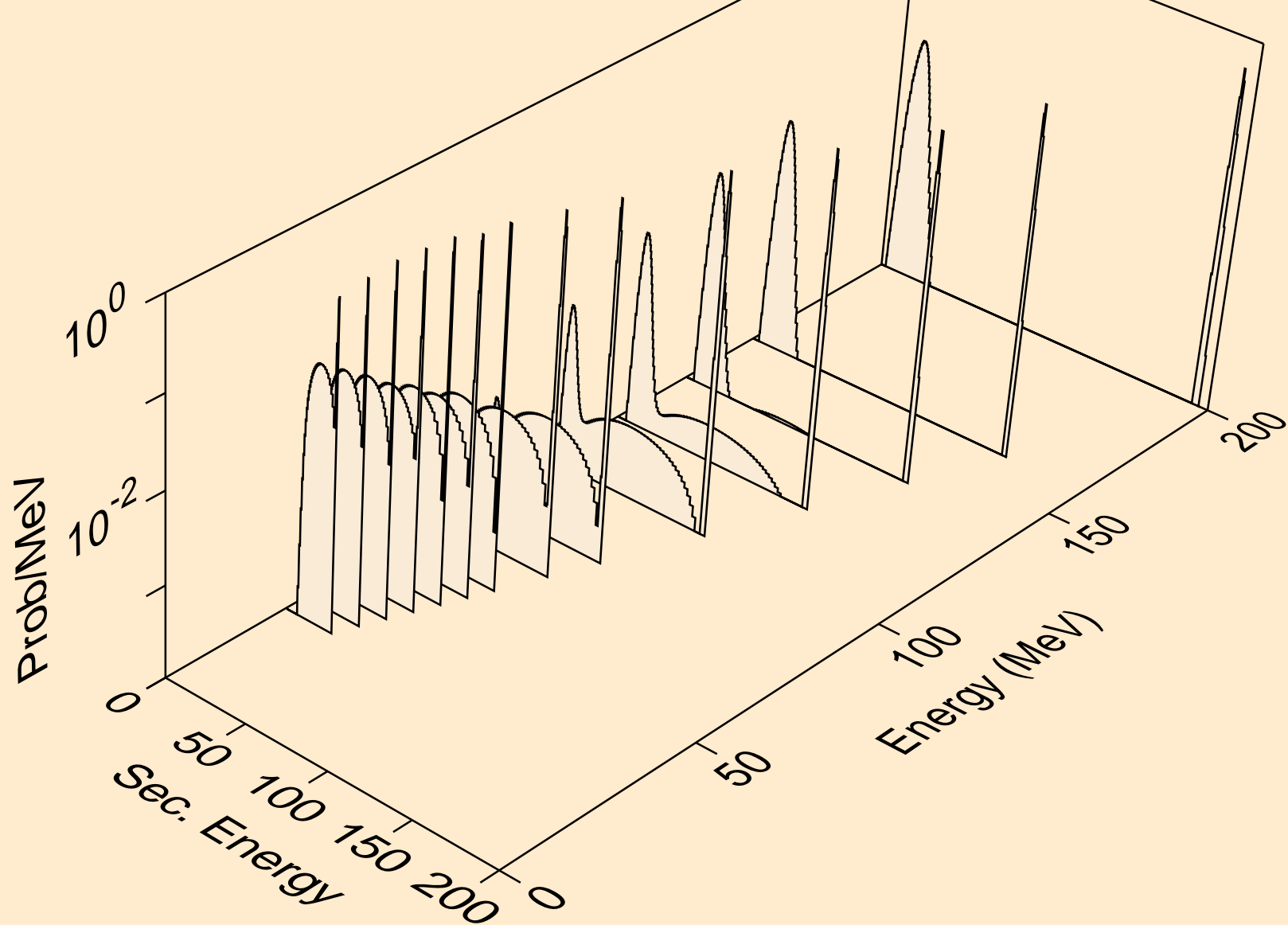

TA164 TRITON ACER TENDL-2021 LIBRARY; T=0.K  
Triton emission for (t,n\*)t

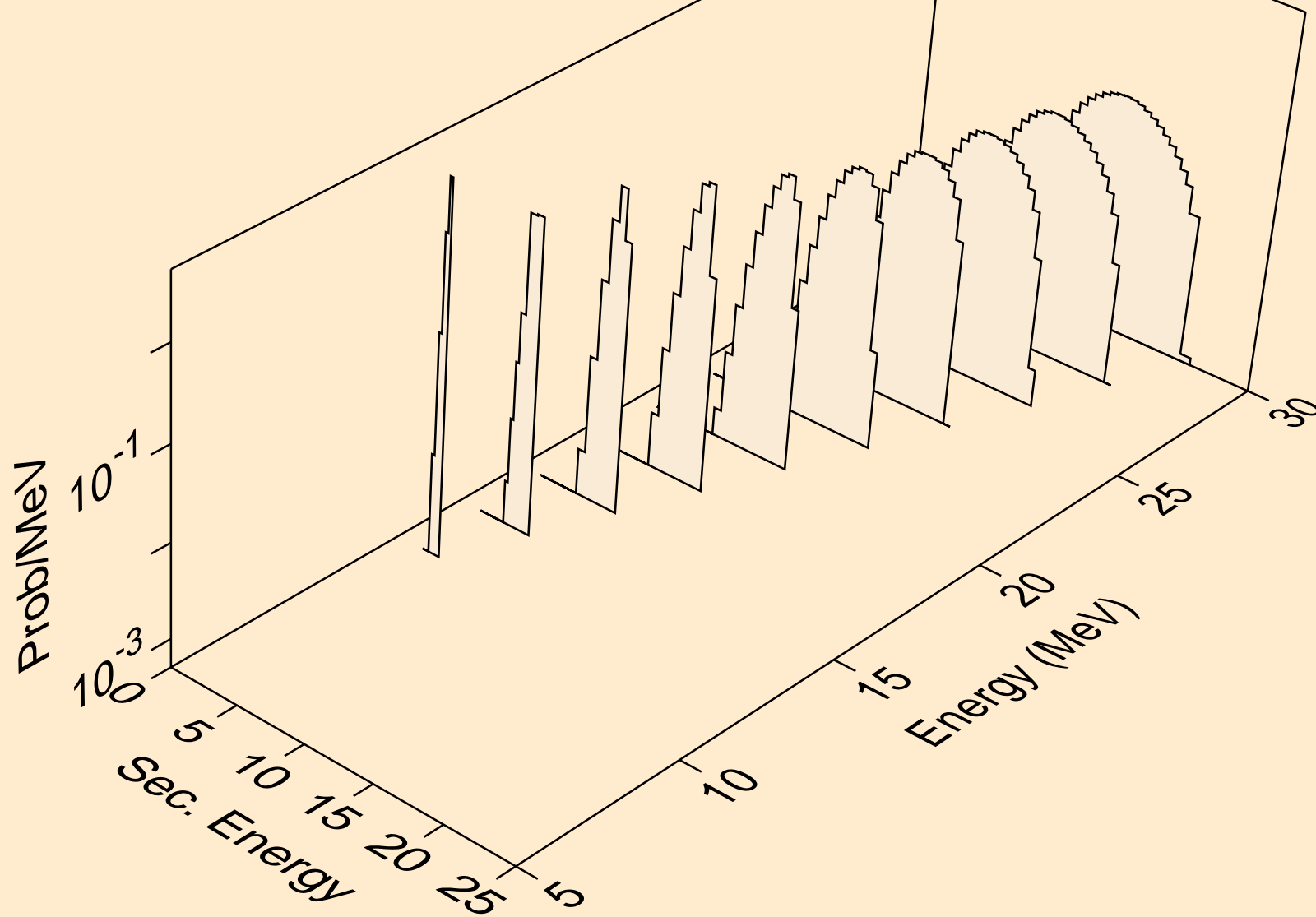

TA164 TRITON ACER TENDL-2021 LIBRARY; T=0.K  
Triton emission for inelastic

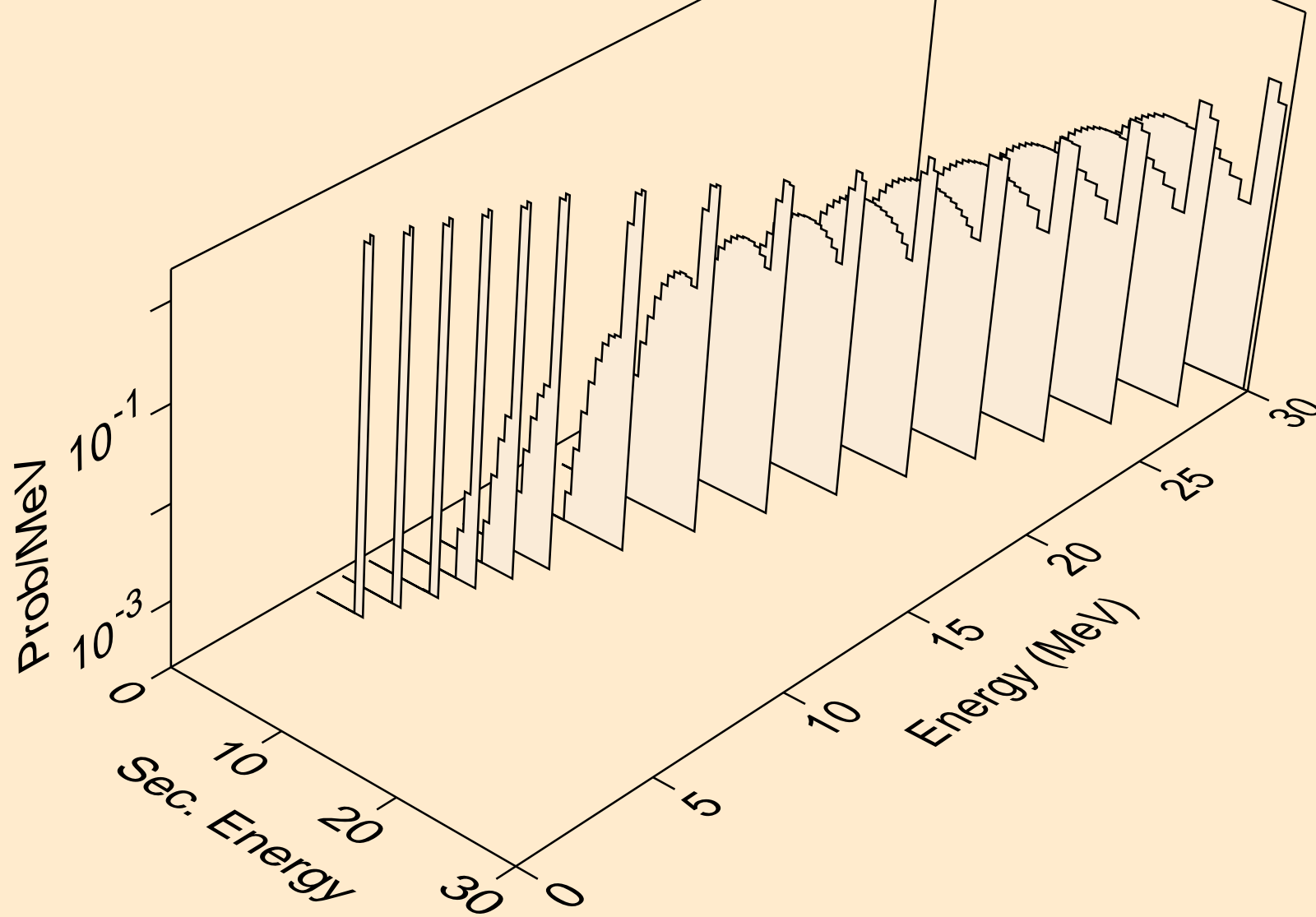

TA164 TRITON ACER TENDL-2021 LIBRARY; T=0.K  
Triton emission for (t,t2a)

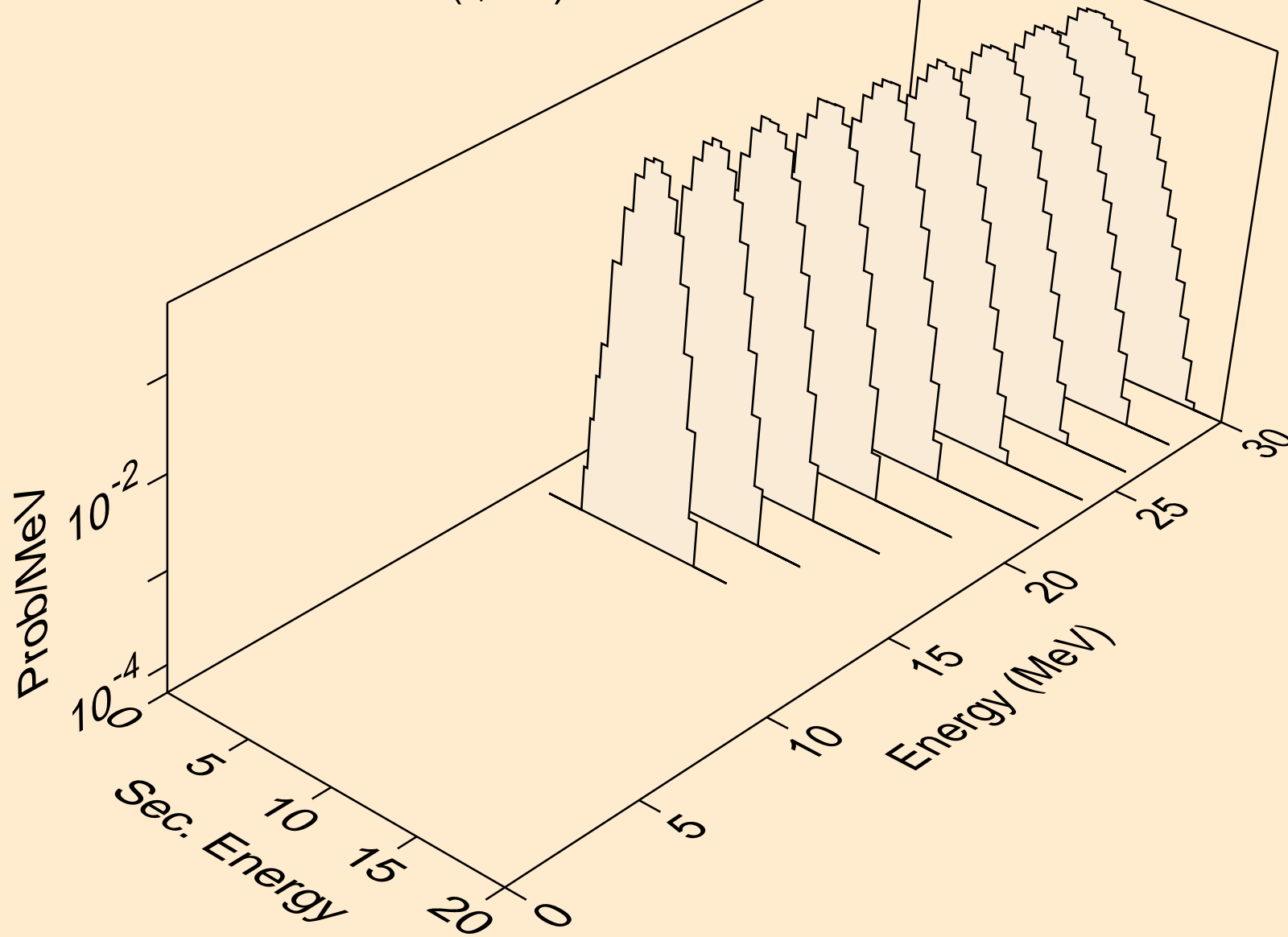

TA164 TRITON ACER TENDL-2021 LIBRARY; T=0.K  
Triton emission for (t,pt)

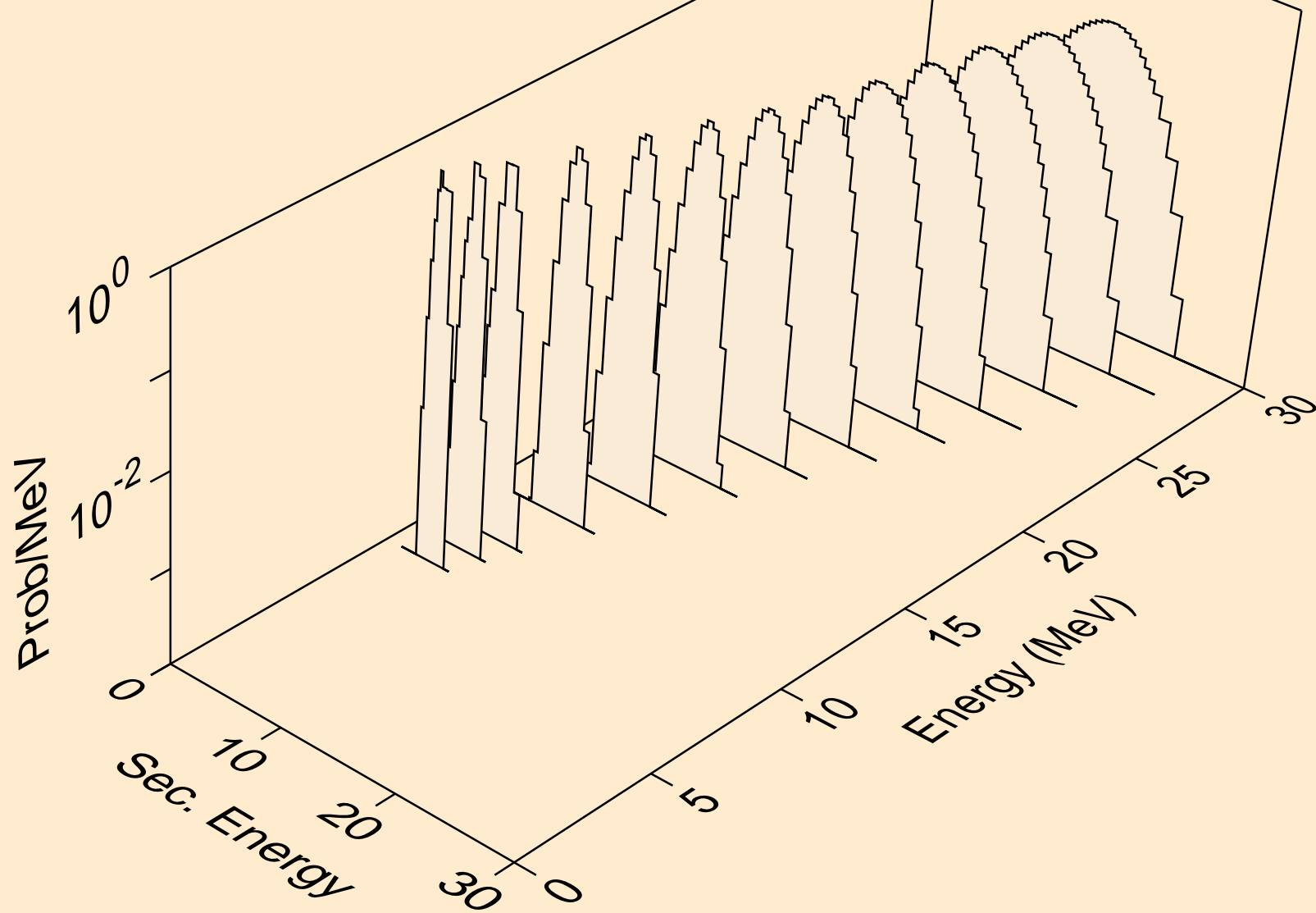

TA164 TRITON ACER TENDL-2021 LIBRARY; T=0.K  
Photon emission for (z,n)

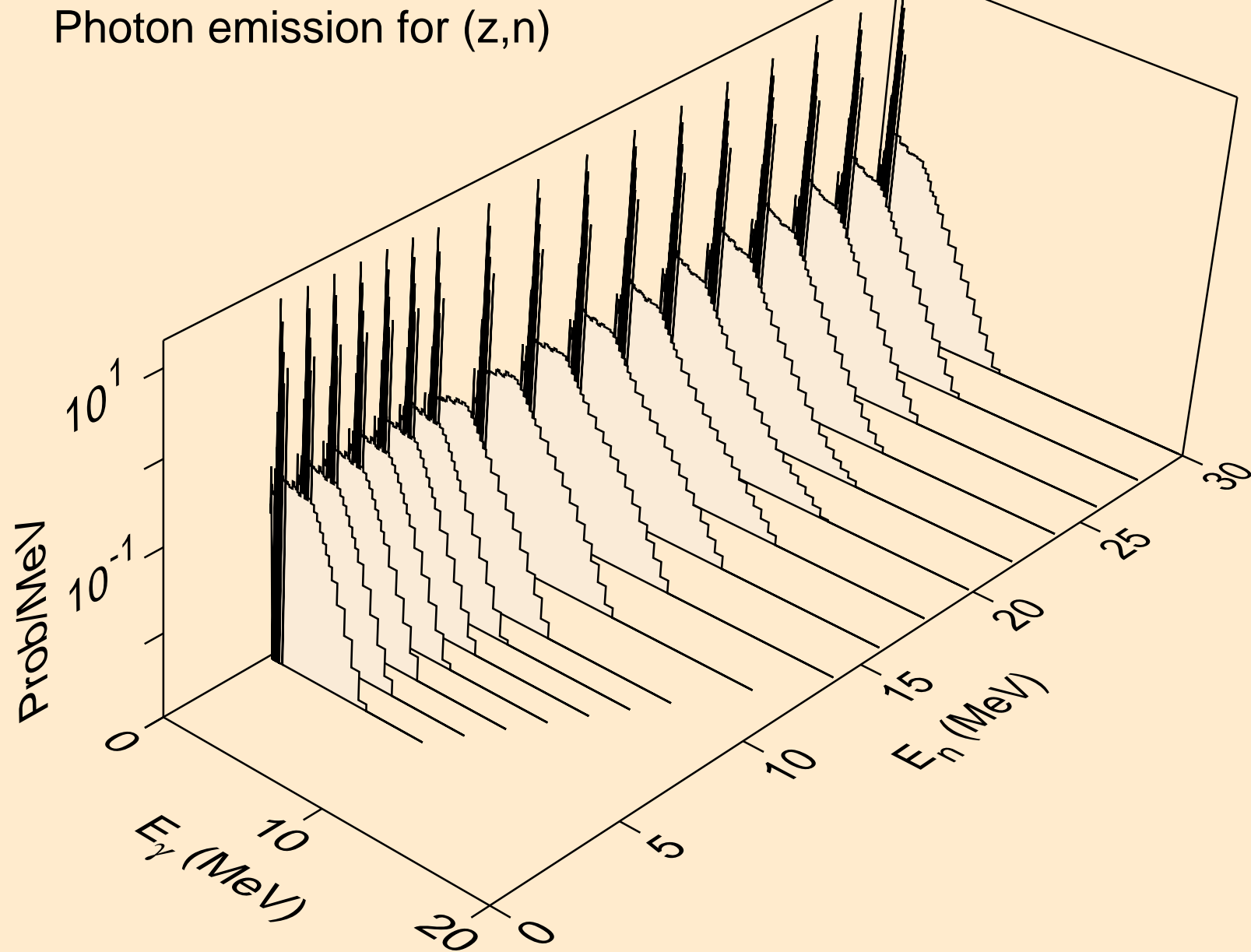

TA164 TRITON ACER TENDL-2021 LIBRARY; T=0.K  
Photon emission for (n,x)

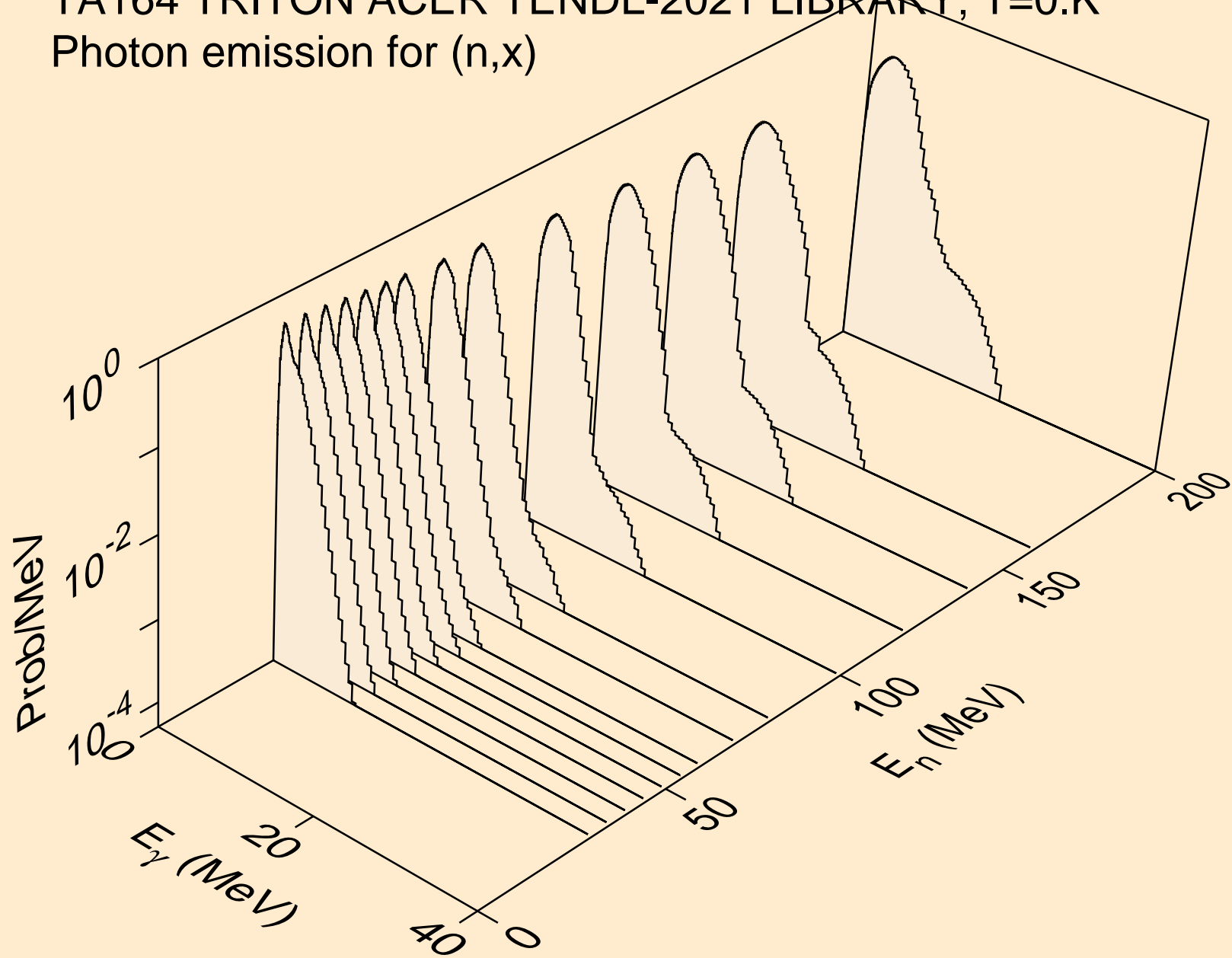

TA164 TRITON ACER TENDL-2021 LIBRARY; T=0.K  
Photon emission for (n,2nd)

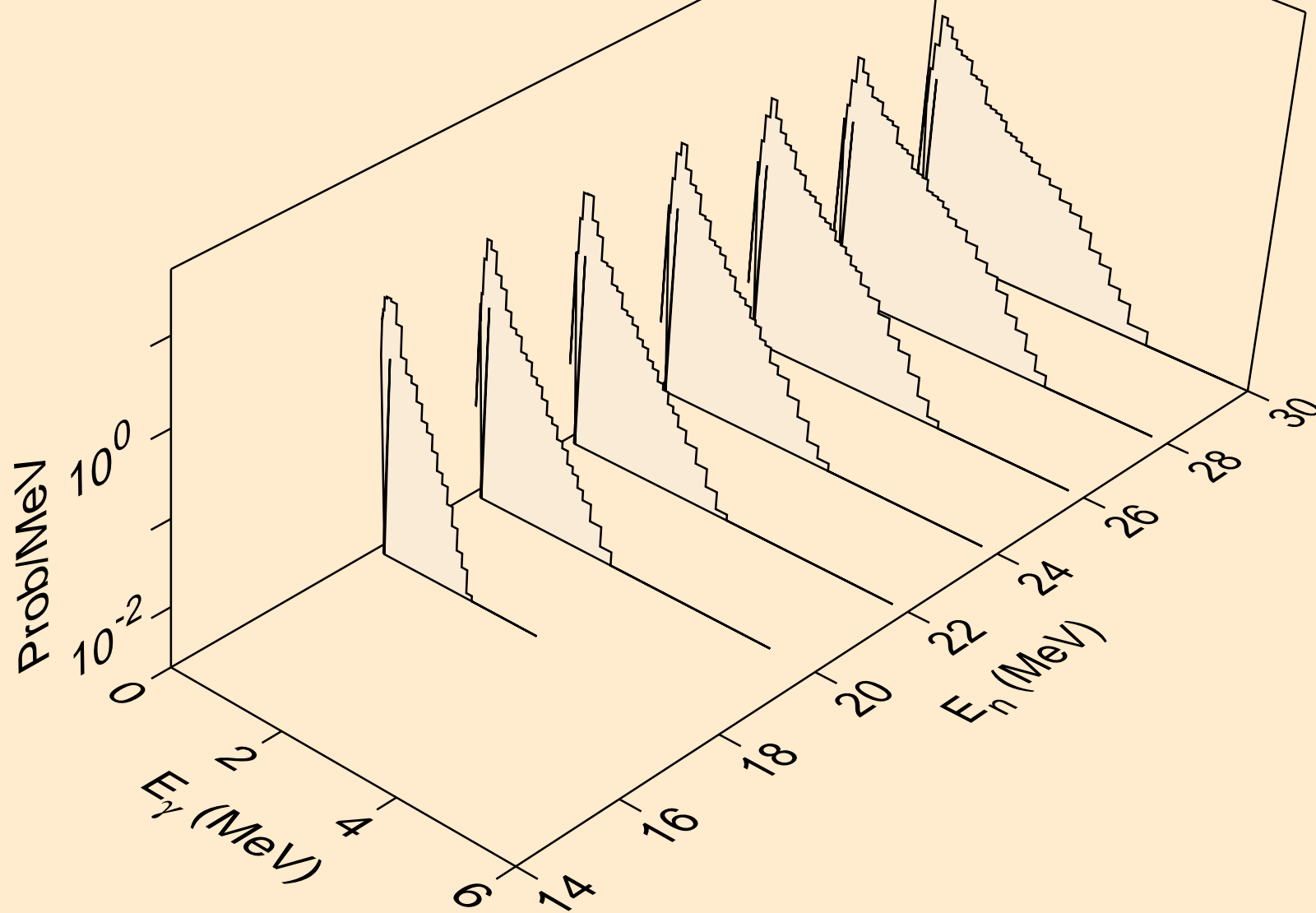



TA164 TRITON ACER TENDL-2021 LIBRARY; T=0.K  
Photon emission for (n,2n)

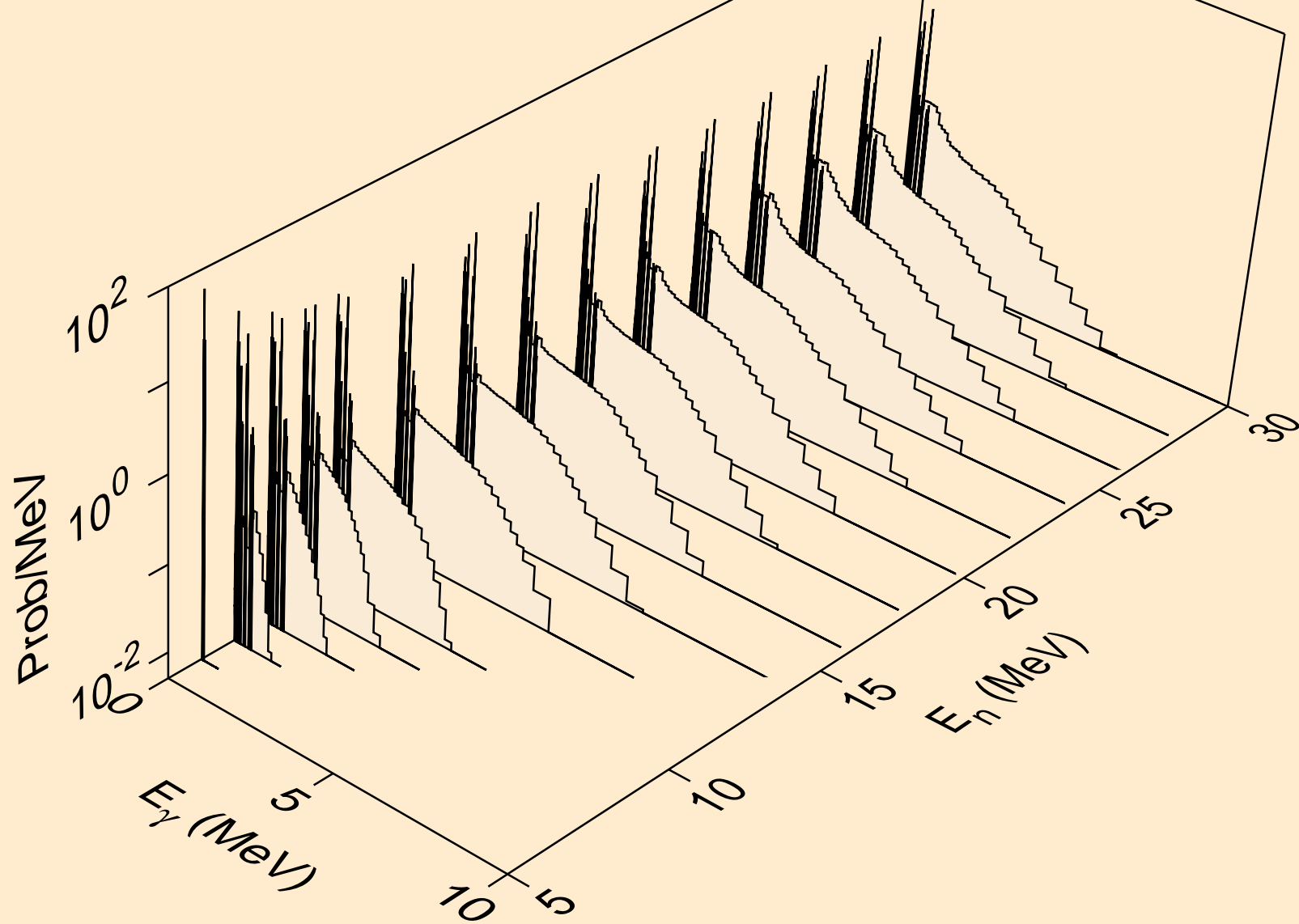

TA164 TRITON ACER TENDL-2021 LIBRARY; T=0.K  
Photon emission for (n,3n)

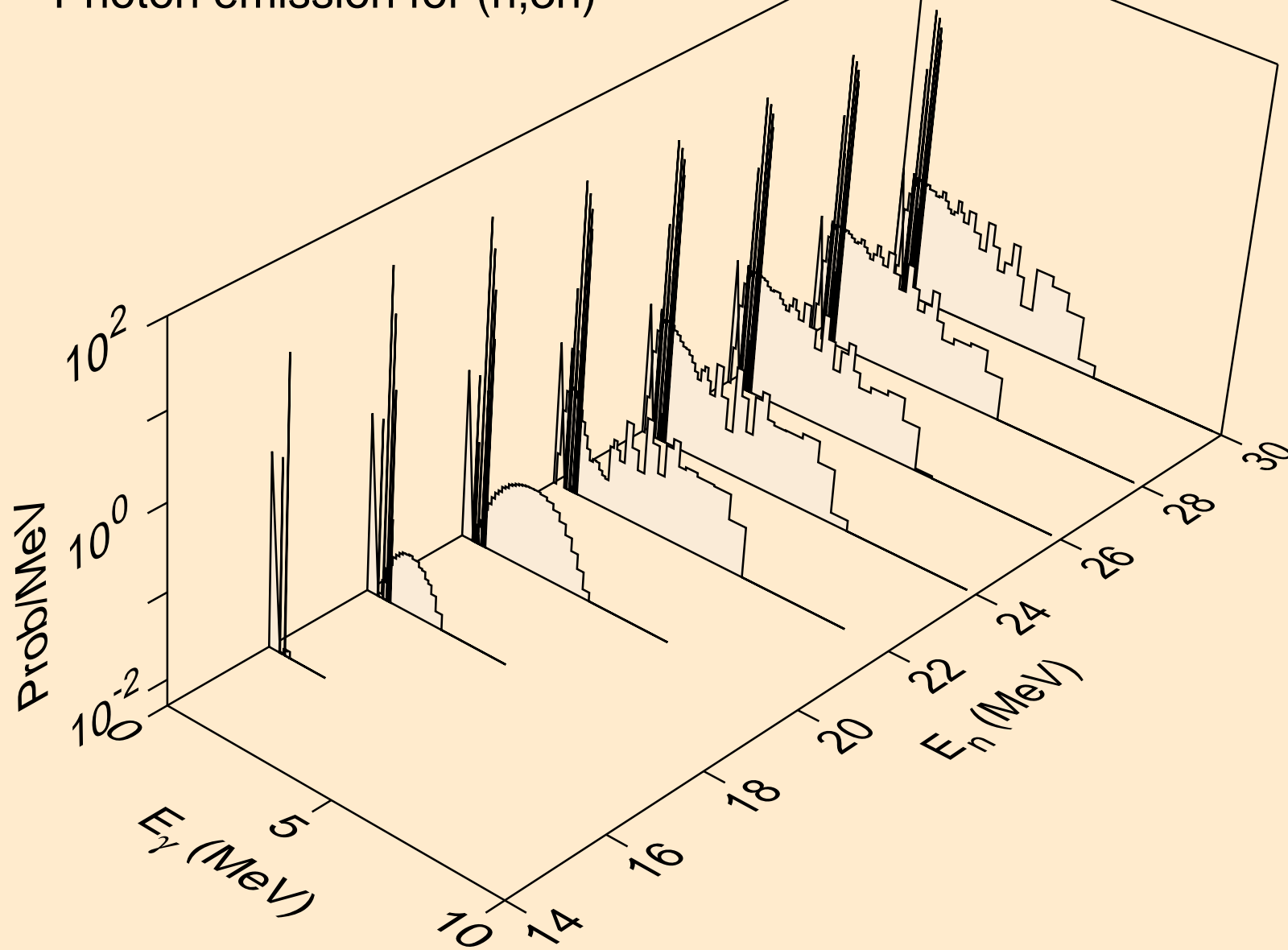

TA164 TRITON ACER TENDL-2021 LIBRARY; T=0.K  
Photon emission for (n,n\*)a

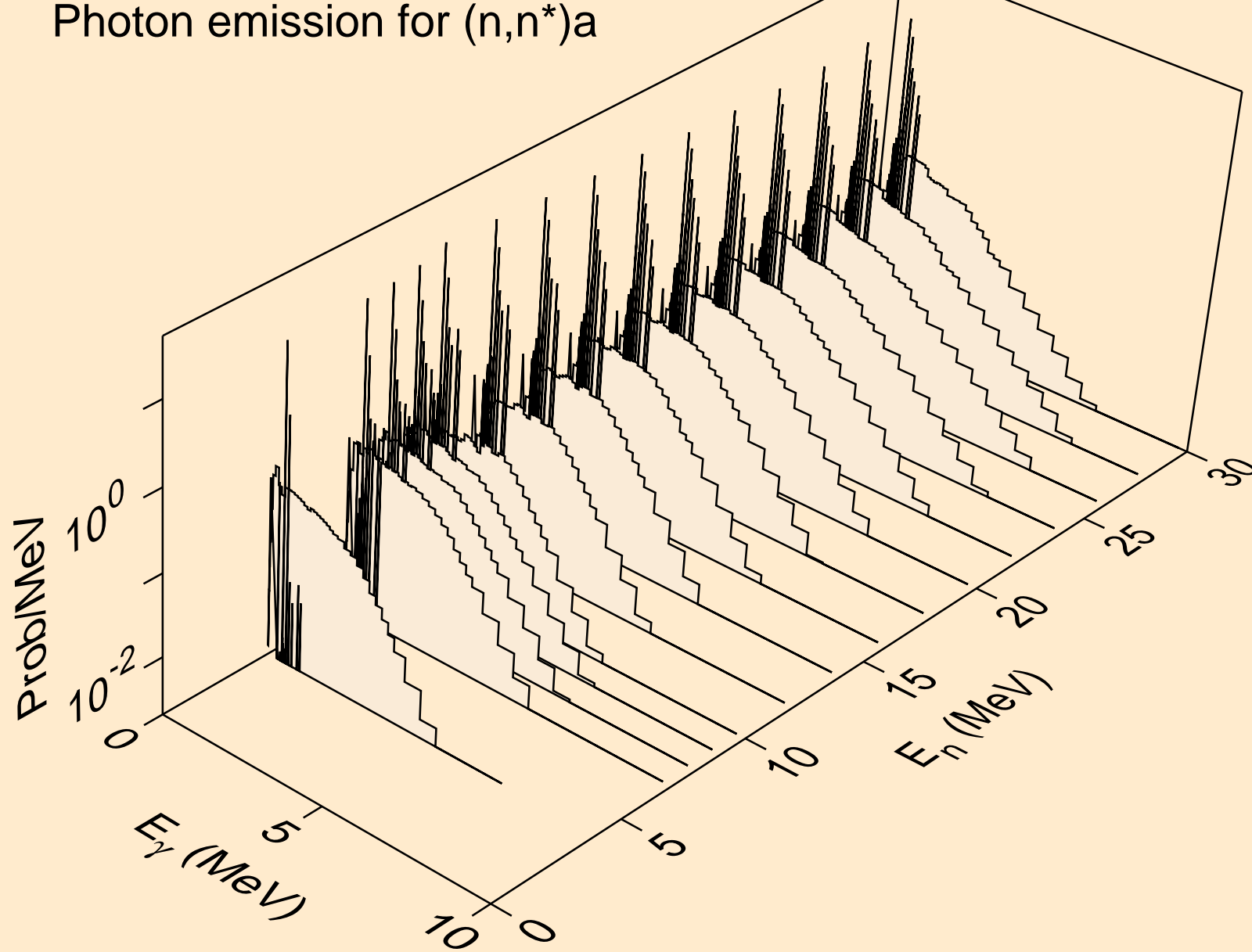

TA164 TRITON ACER TENDL-2021 LIBRARY; T=0.K  
Photon emission for (n,n\*)3a

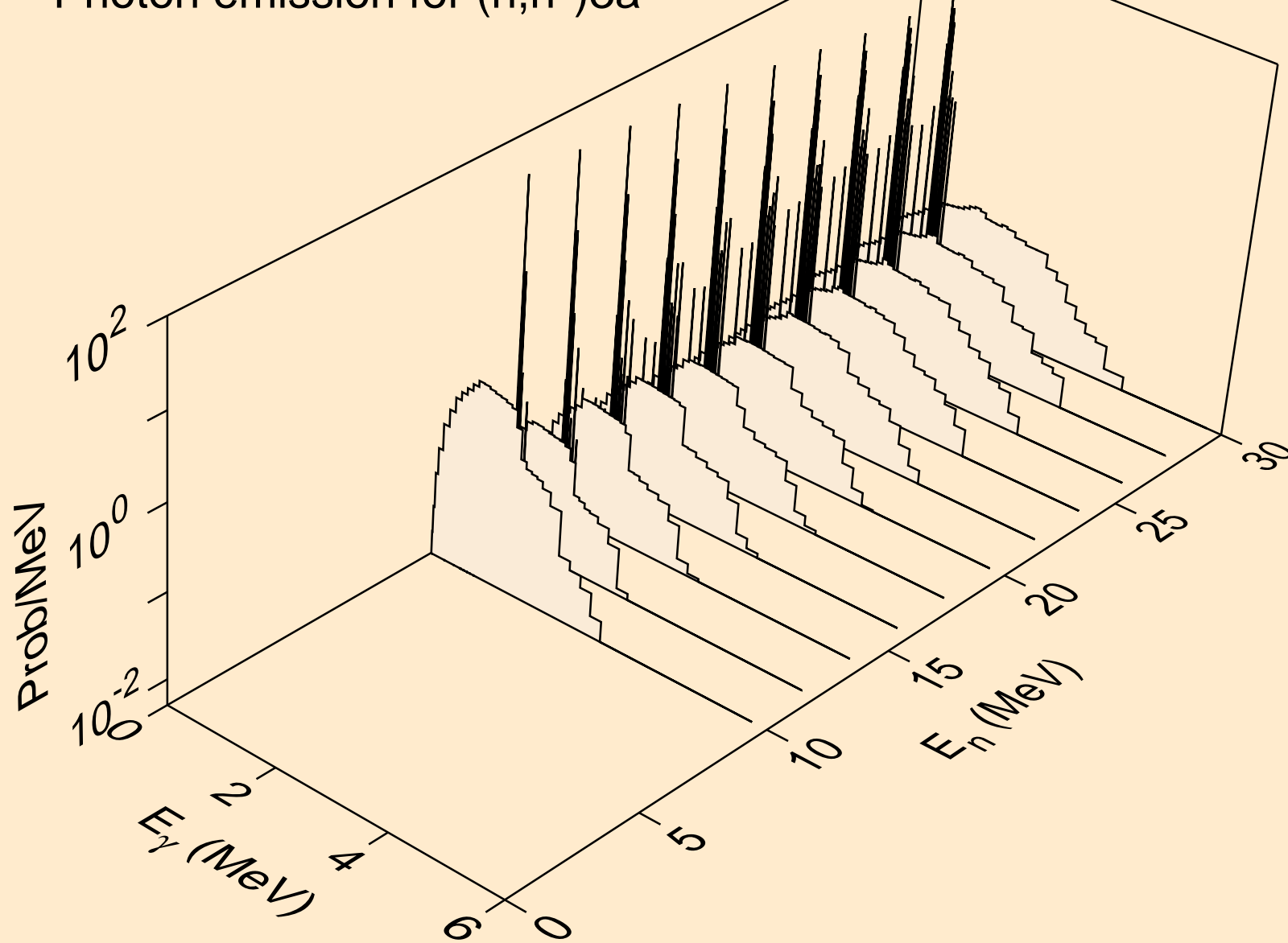

TA164 TRITON ACER TENDL-2021 LIBRARY; T=0.K  
Photon emission for (n,2n)a

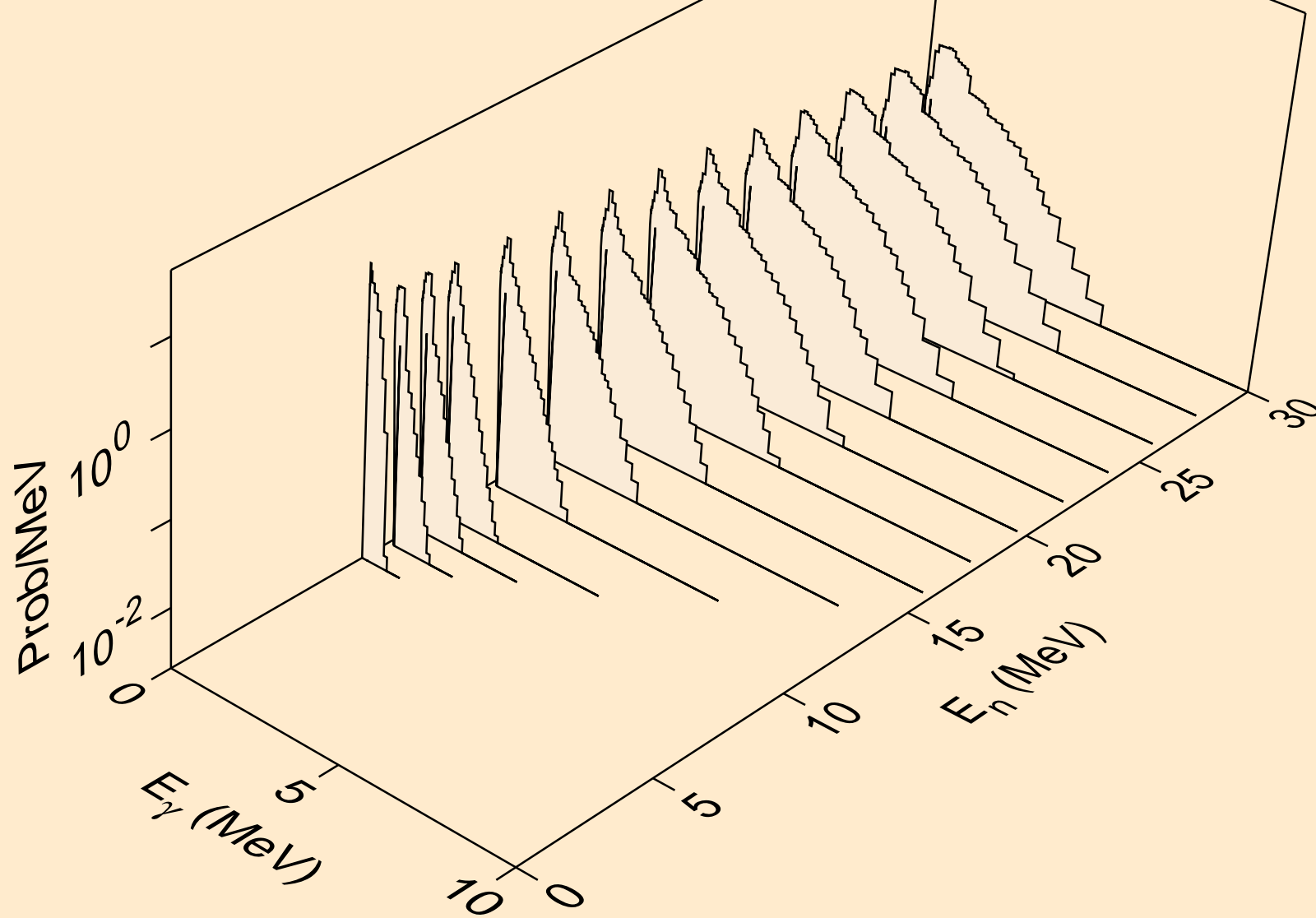

TA164 TRITON ACER TENDL-2021 LIBRARY; T=0.K  
Photon emission for (n,3n)a

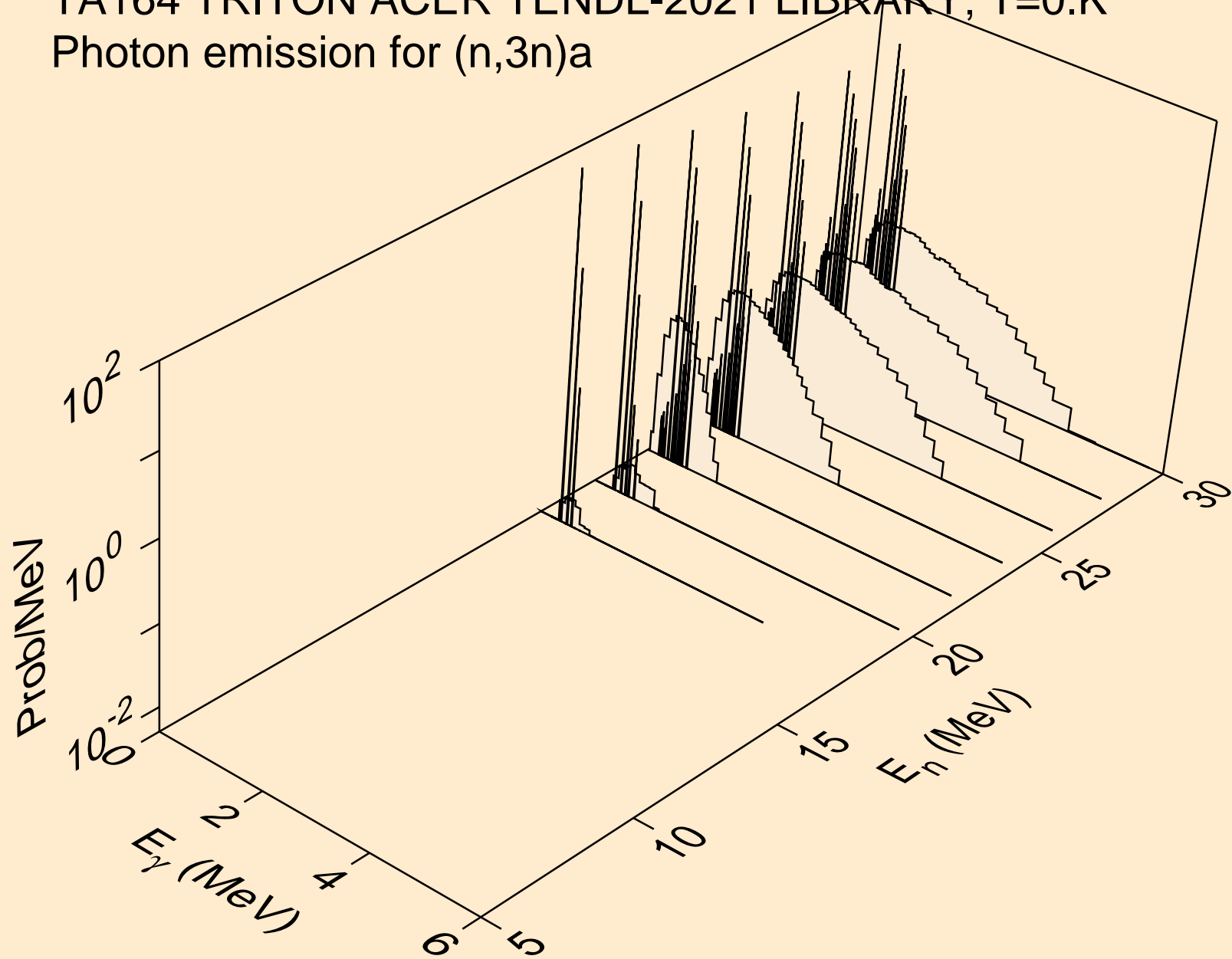

TA164 TRITON ACER TENDL-2021 LIBRARY; T=0.K  
Photon emission for (n,n\*)p

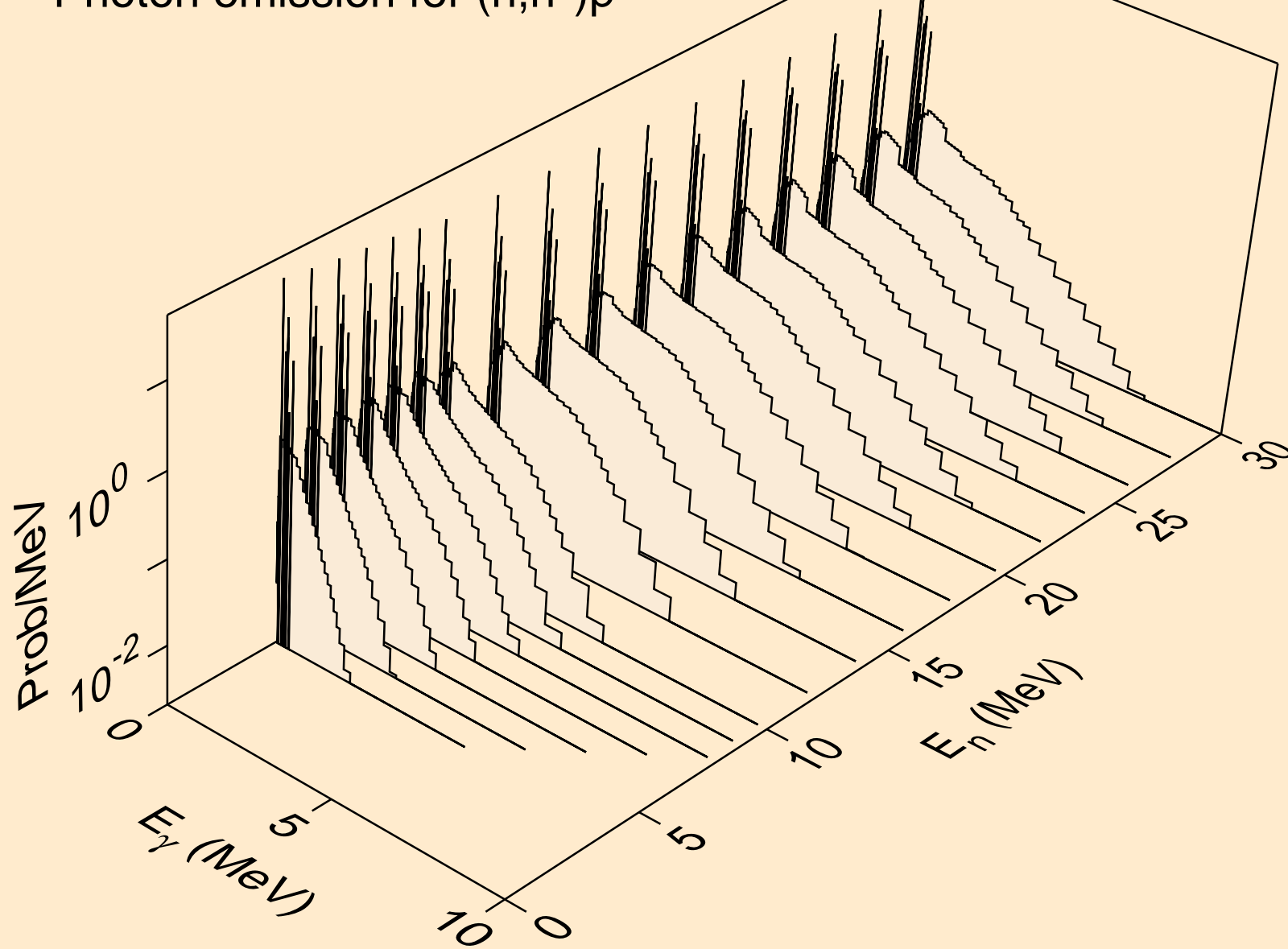

TA164 TRITON ACER TENDL-2021 LIBRARY; T=0.K  
Photon emission for (n,n\*)2a

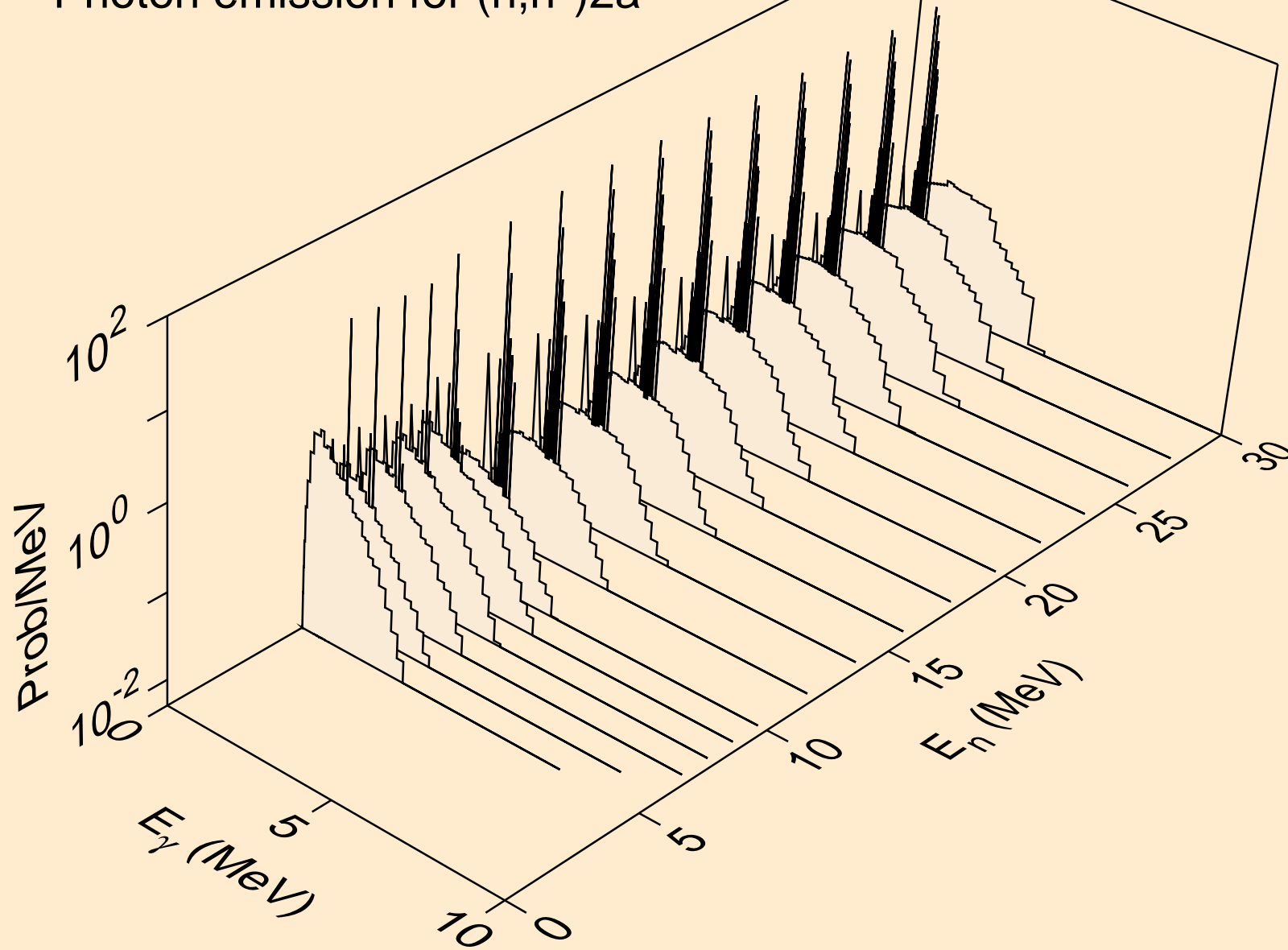



TA164 TRITON ACER TENDL-2021 LIBRARY; T=0.K  
Photon emission for (n,2n)2a

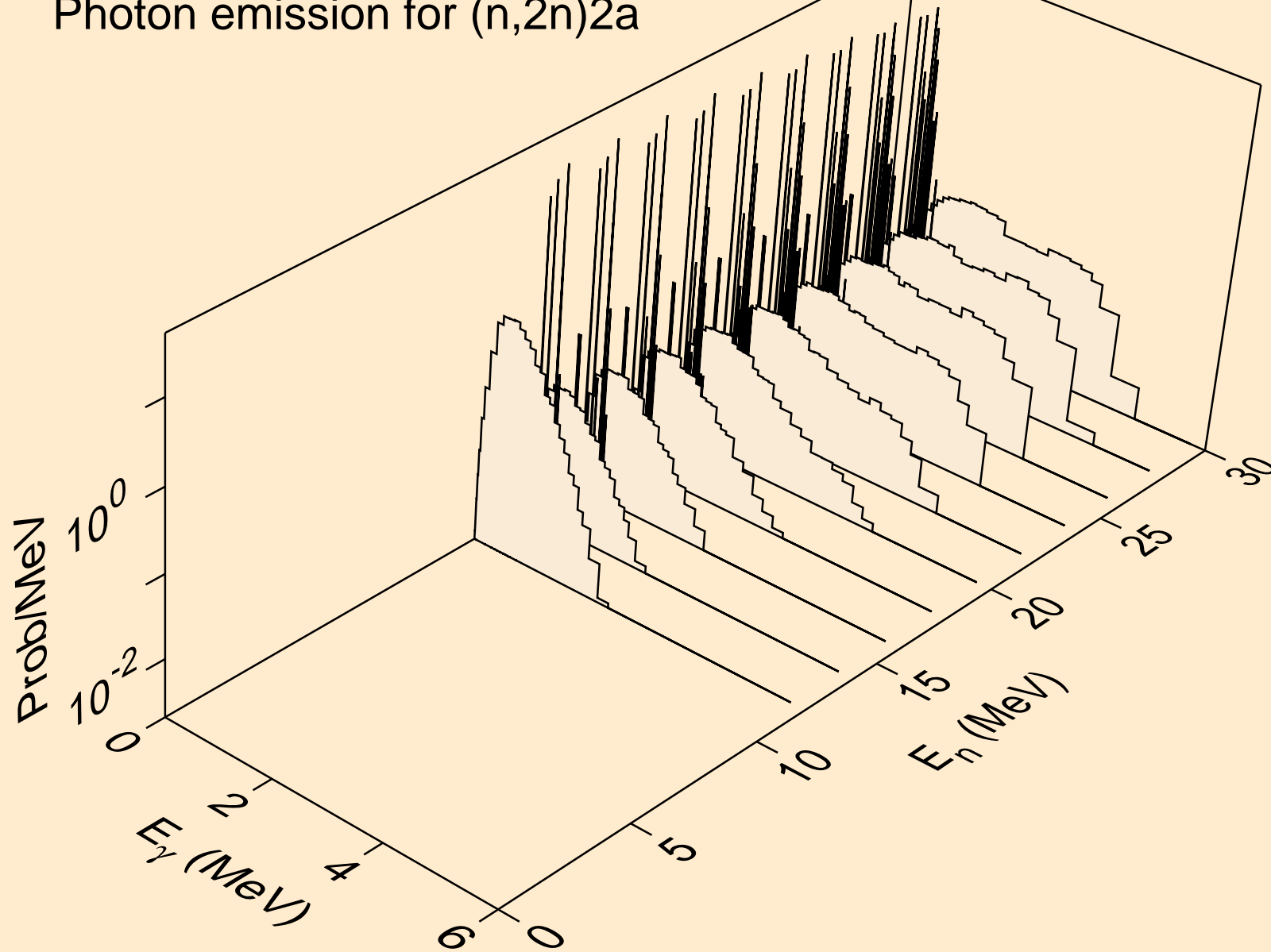

TA164 TRITON ACER TENDL-2021 LIBRARY; T=0.K  
Photon emission for (n,n\*)d

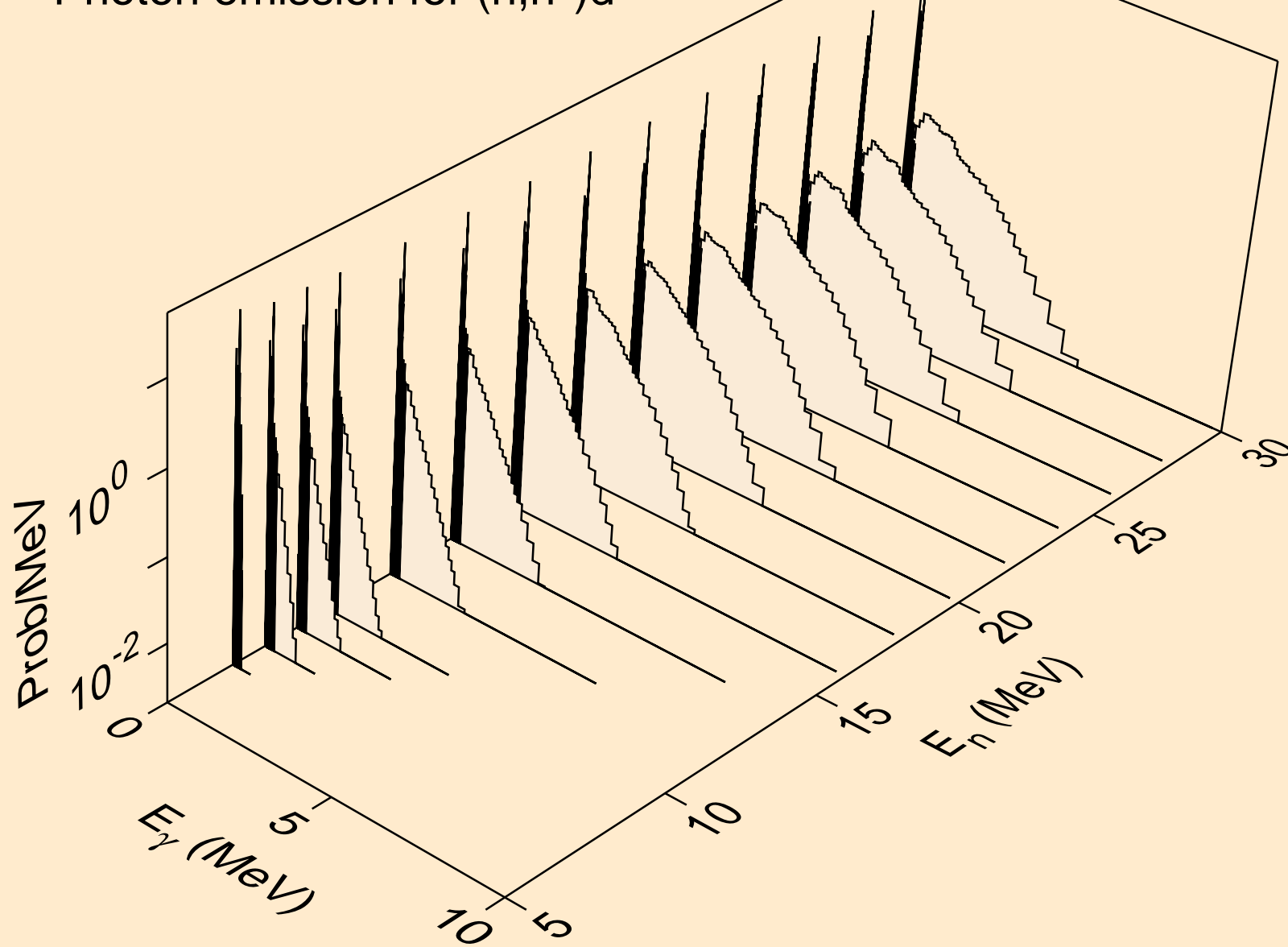

TA164 TRITON ACER TENDL-2021 LIBRARY; T=0.K  
Photon emission for (n,n\*)t

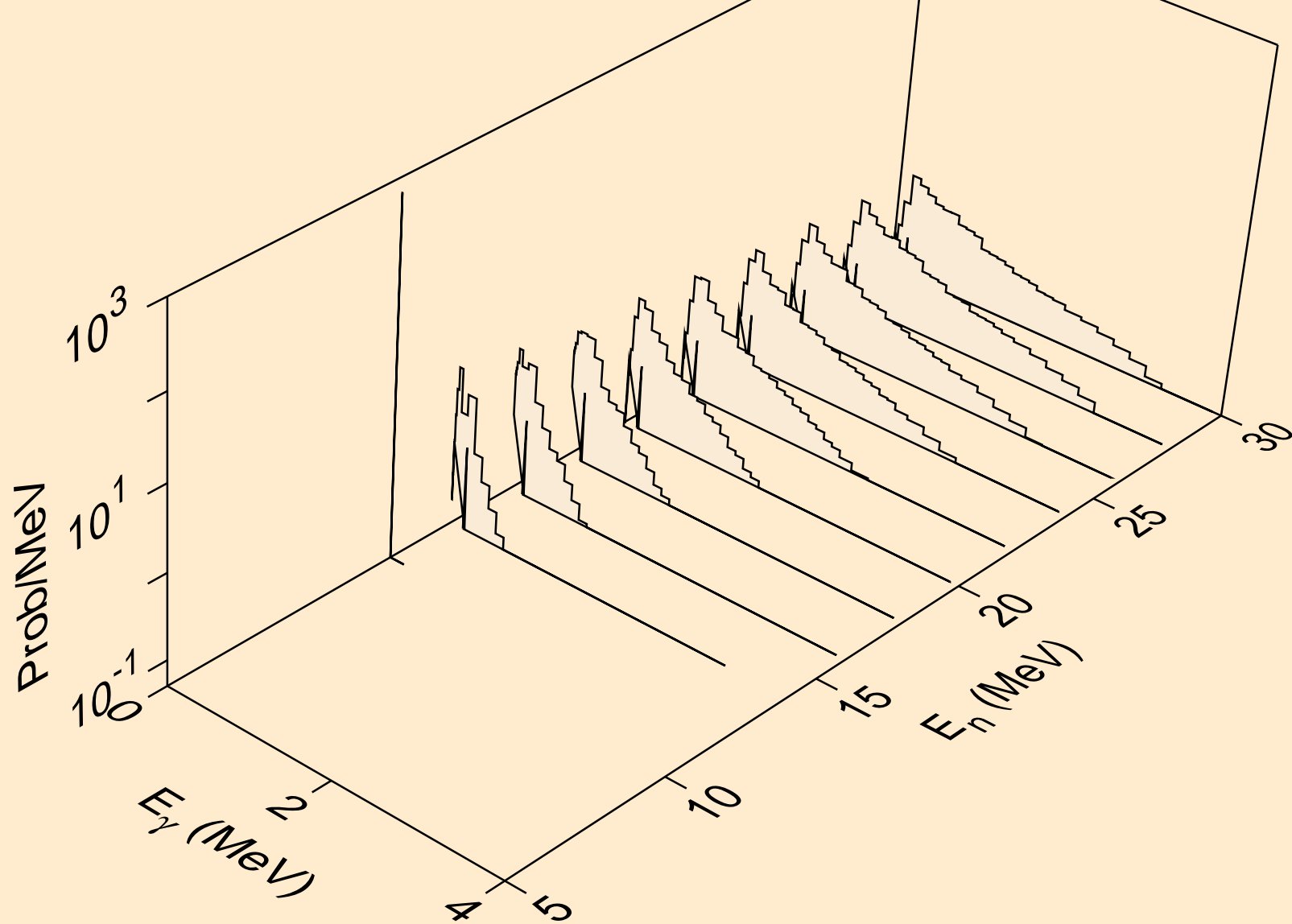

TA164 TRITON ACER TENDL-2021 LIBRARY; T=0.K  
Photon emission for (n,n\*)he3

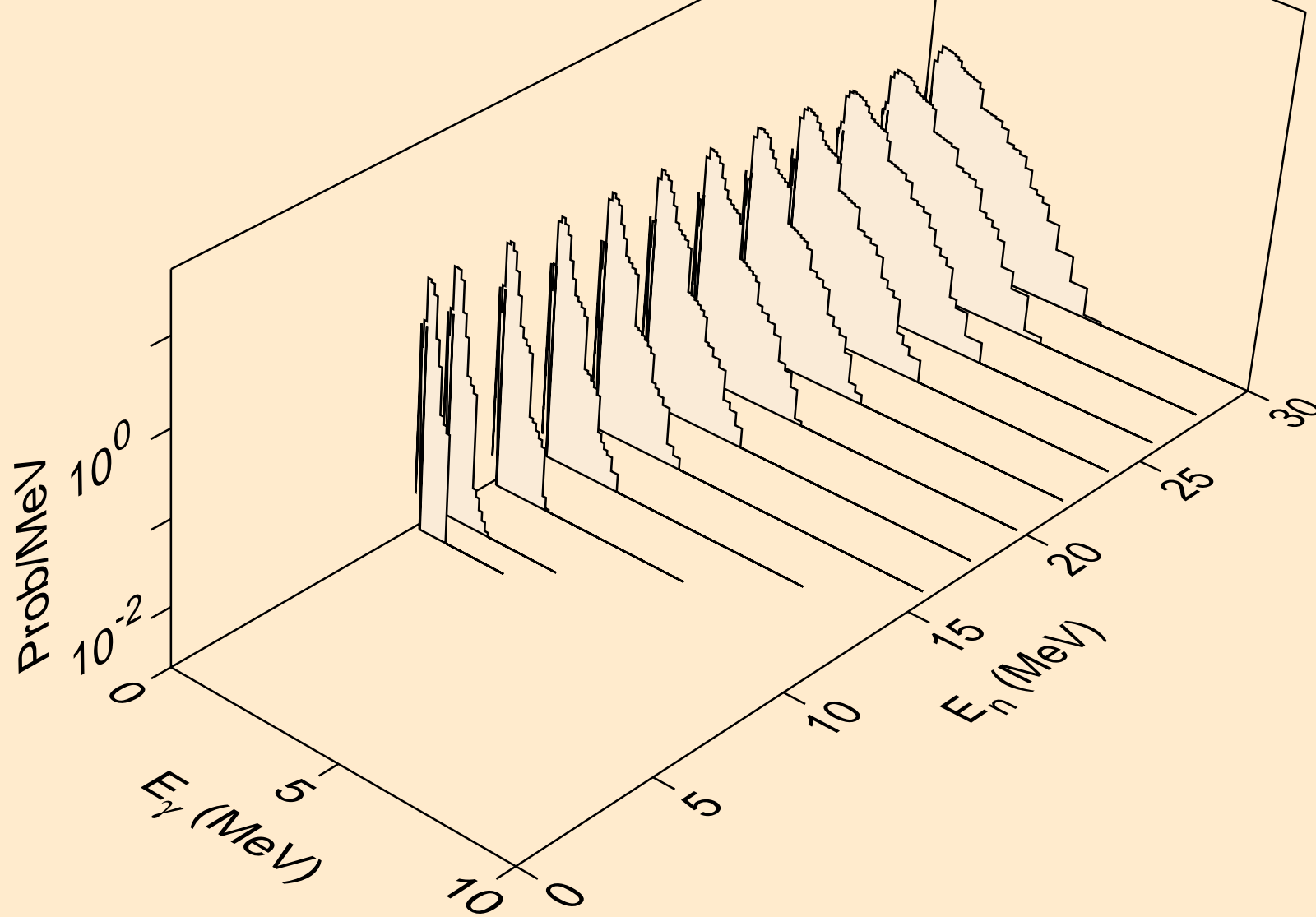

TA164 TRITON ACER TENDL-2021 LIBRARY; T=0.K  
Photon emission for (n,4n)

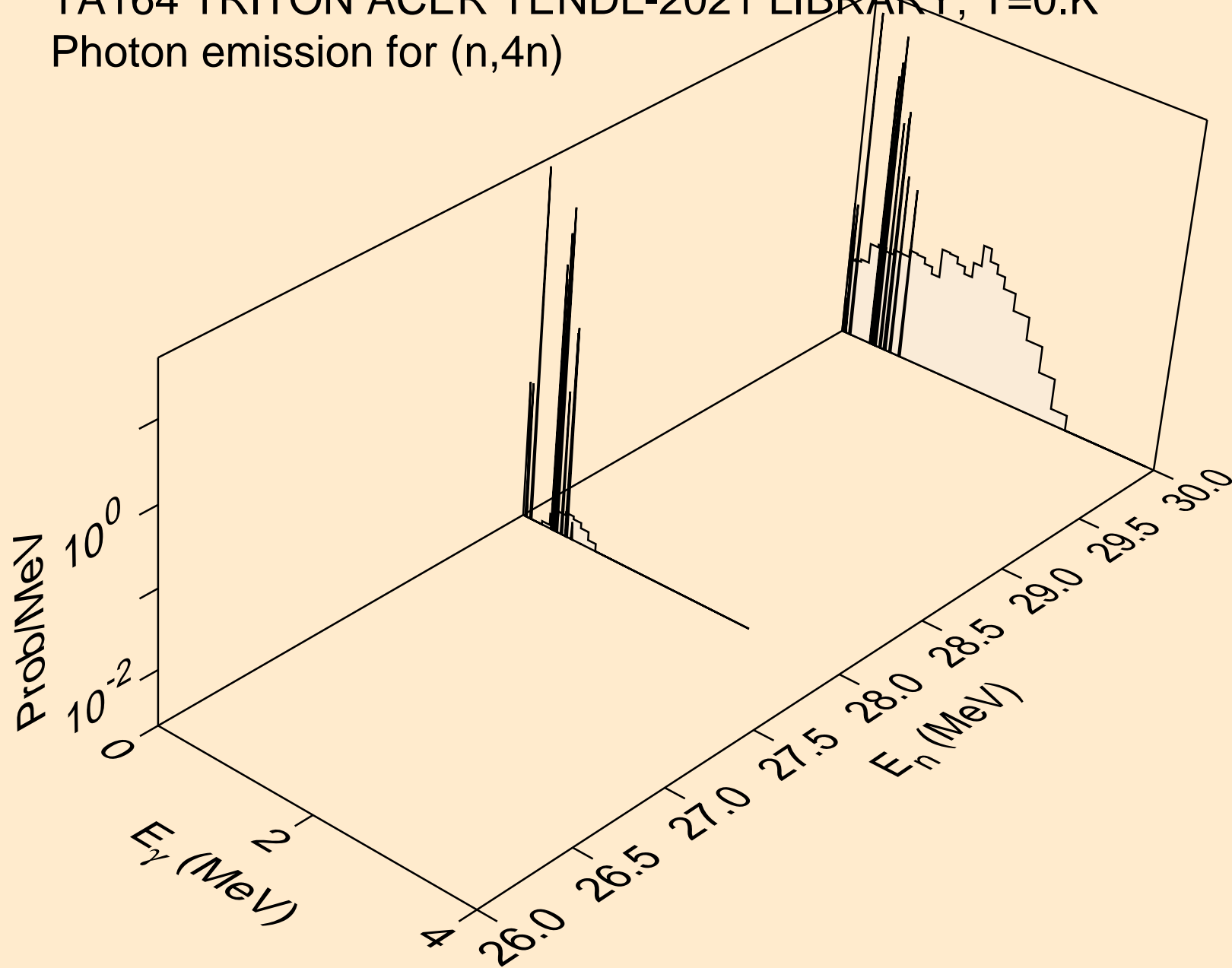

TA164 TRITON ACER TENDL-2021 LIBRARY; T=0.K  
Photon emission for (n,2np)

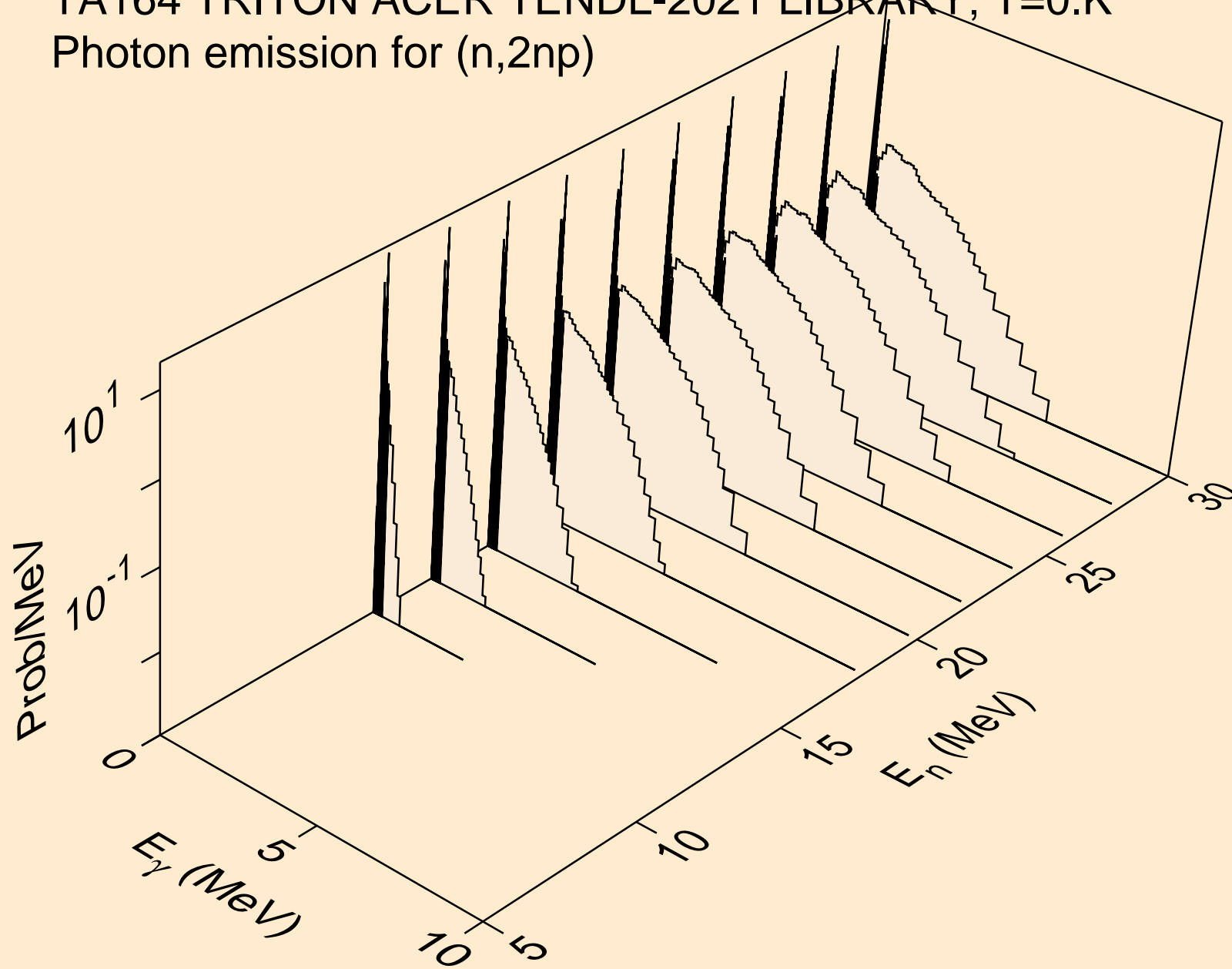

TA164 TRITON ACER TENDL-2021 LIBRARY; T=0.K  
Photon emission for (n,3np)

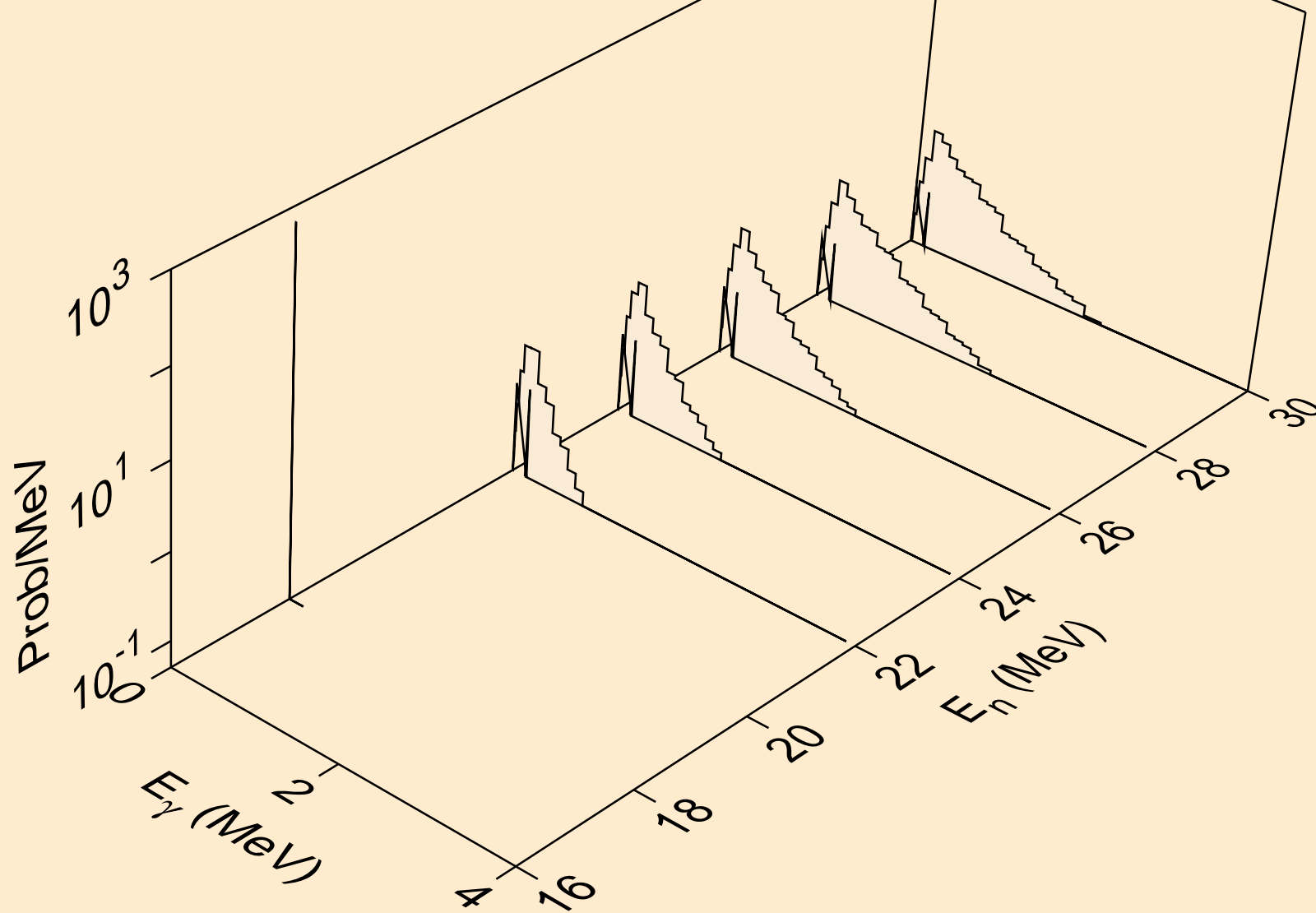

TA164 TRITON ACER TENDL-2021 LIBRARY; T=0.K  
Photon emission for (n,2np)

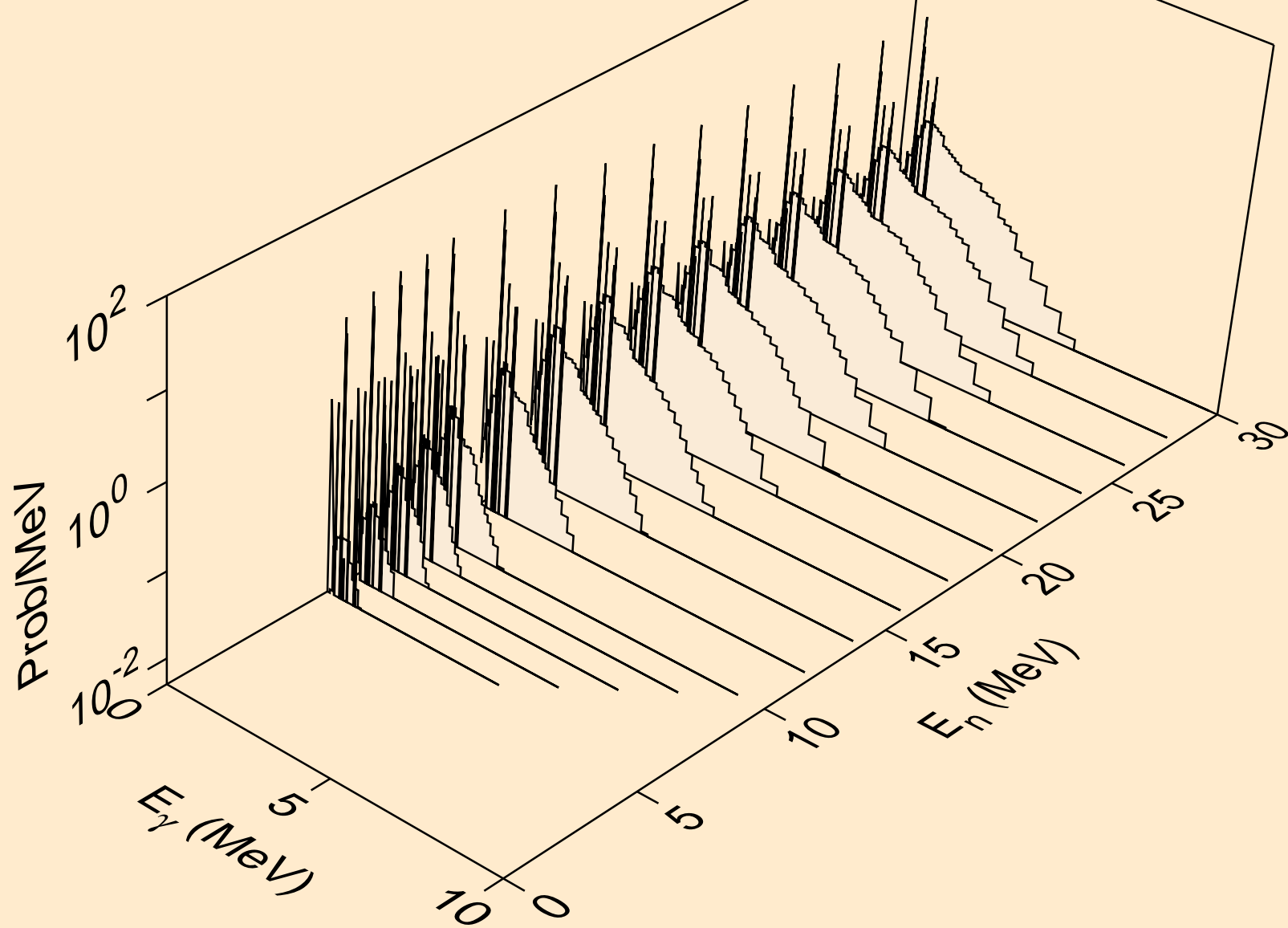



TA164 TRITON ACER TENDL-2021 LIBRARY; T=0.K  
Photon emission for (n,npa)

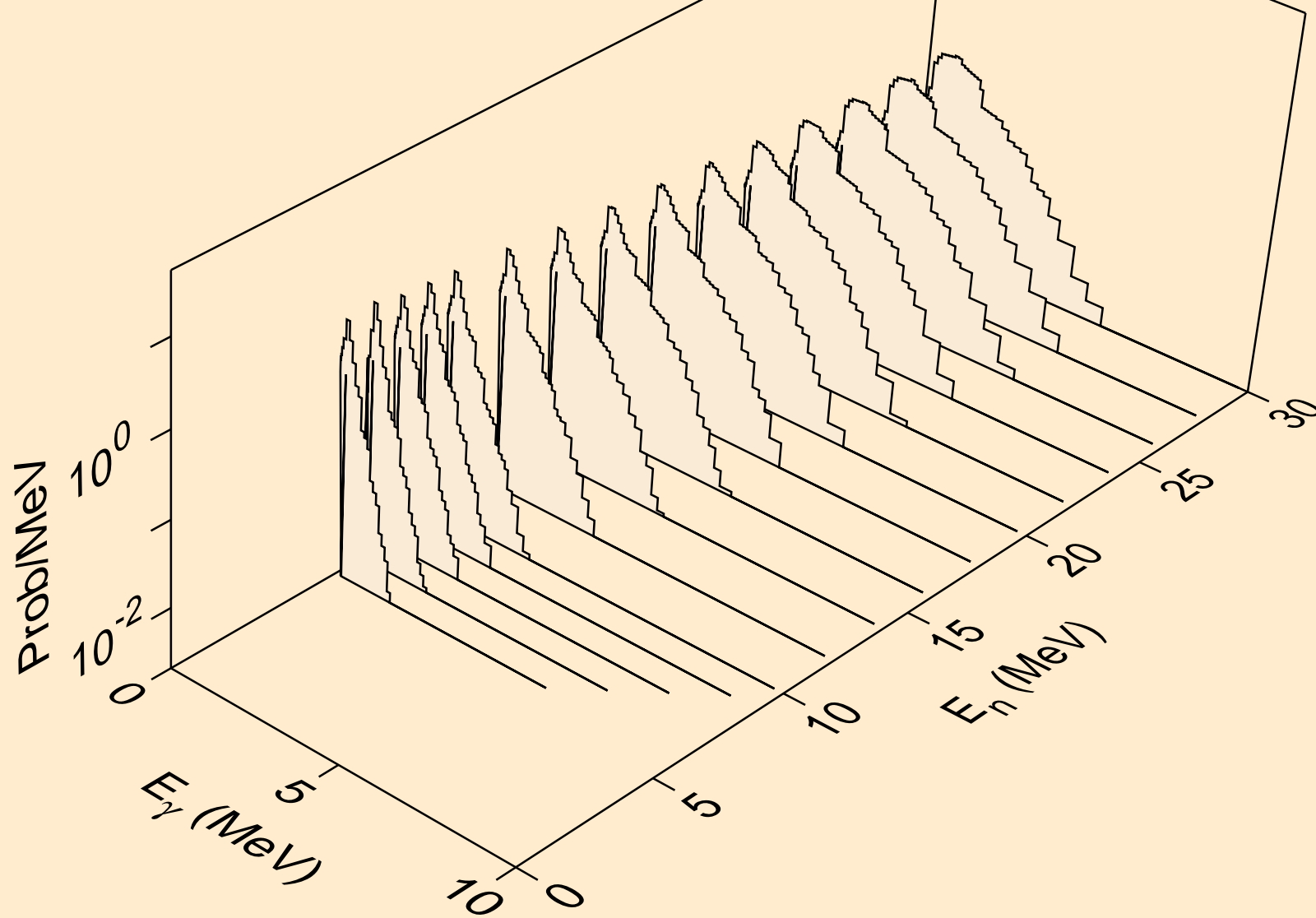

TA164 TRITON ACER TENDL-2021 LIBRARY; T=0.K  
Photon emission for (n,gma)

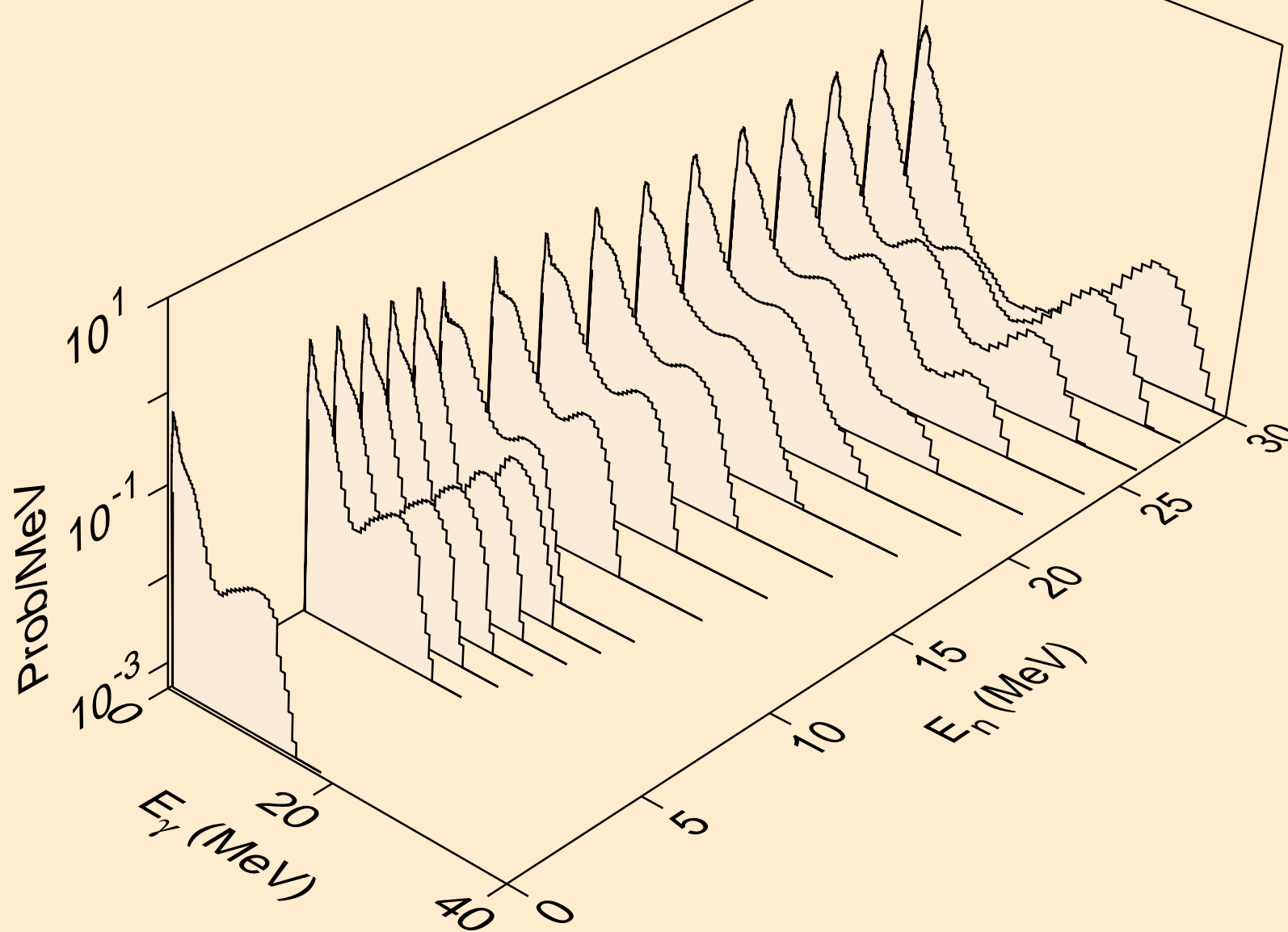

TA164 TRITON ACER TENDL-2021 LIBRARY; T=0.K  
Photon emission for (n,p)

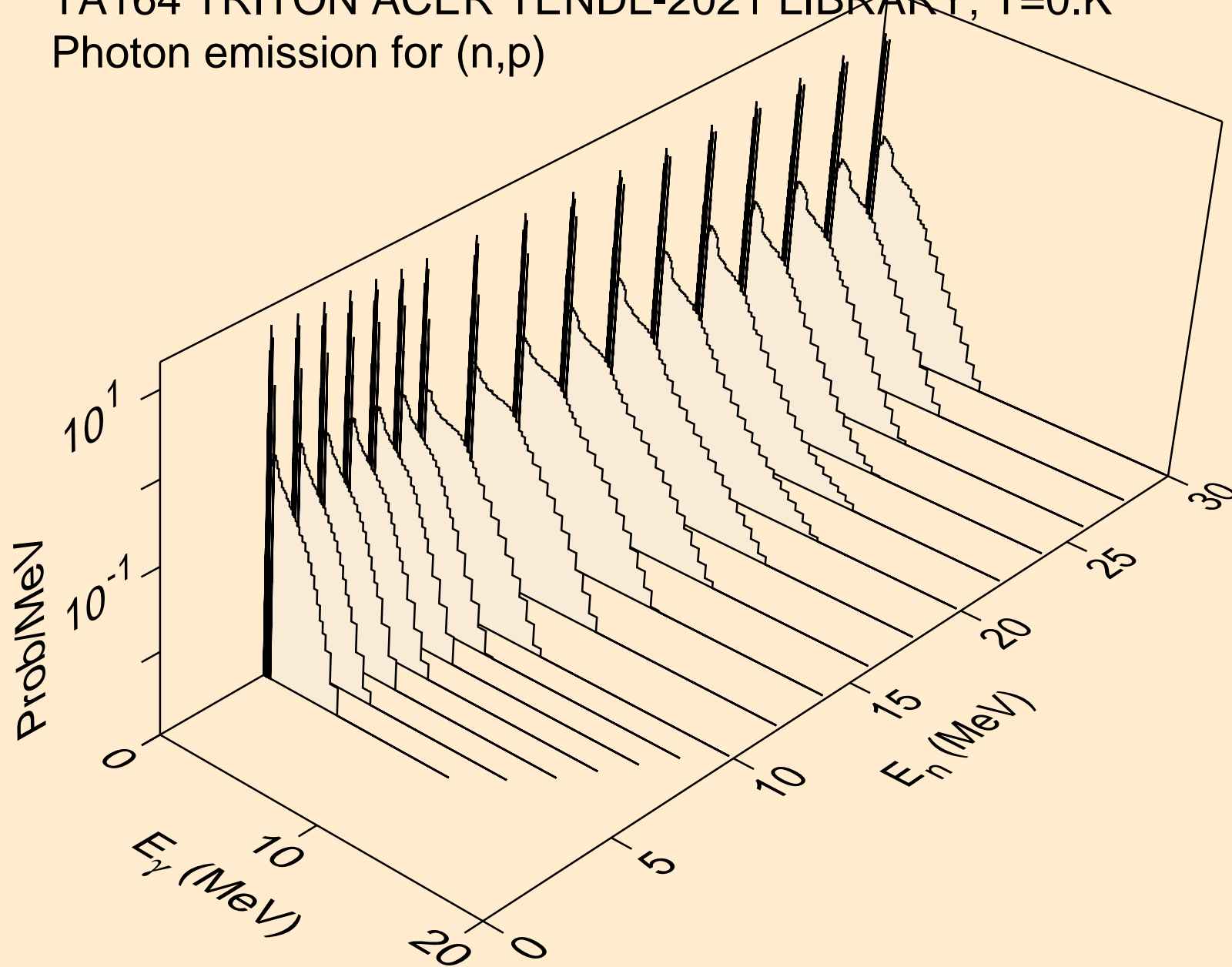

TA164 TRITON ACER TENDL-2021 LIBRARY; T=0.K  
Photon emission for (n,d)

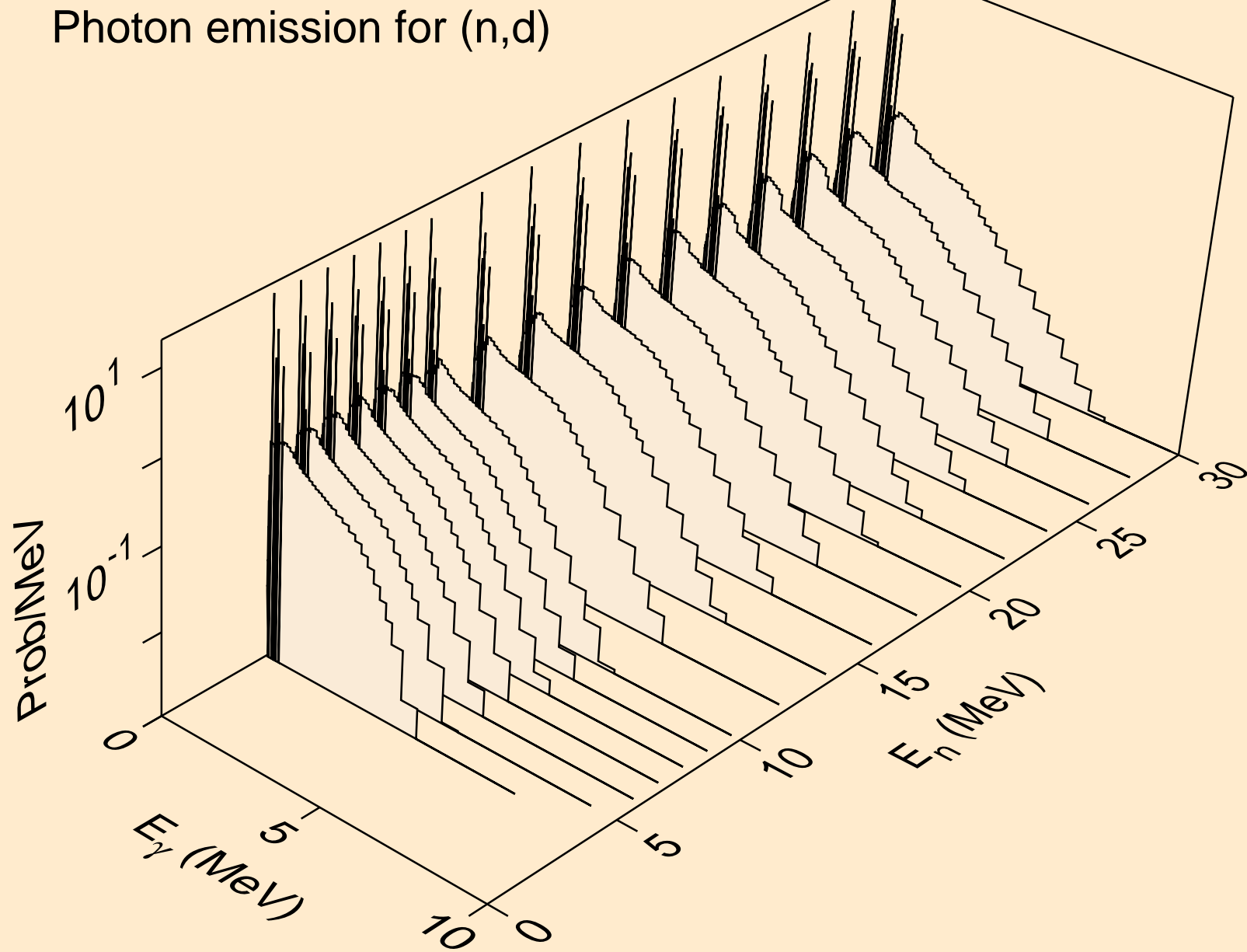

TA164 TRITON ACER TENDL-2021 LIBRARY; T=0.K  
Photon emission for inelastic

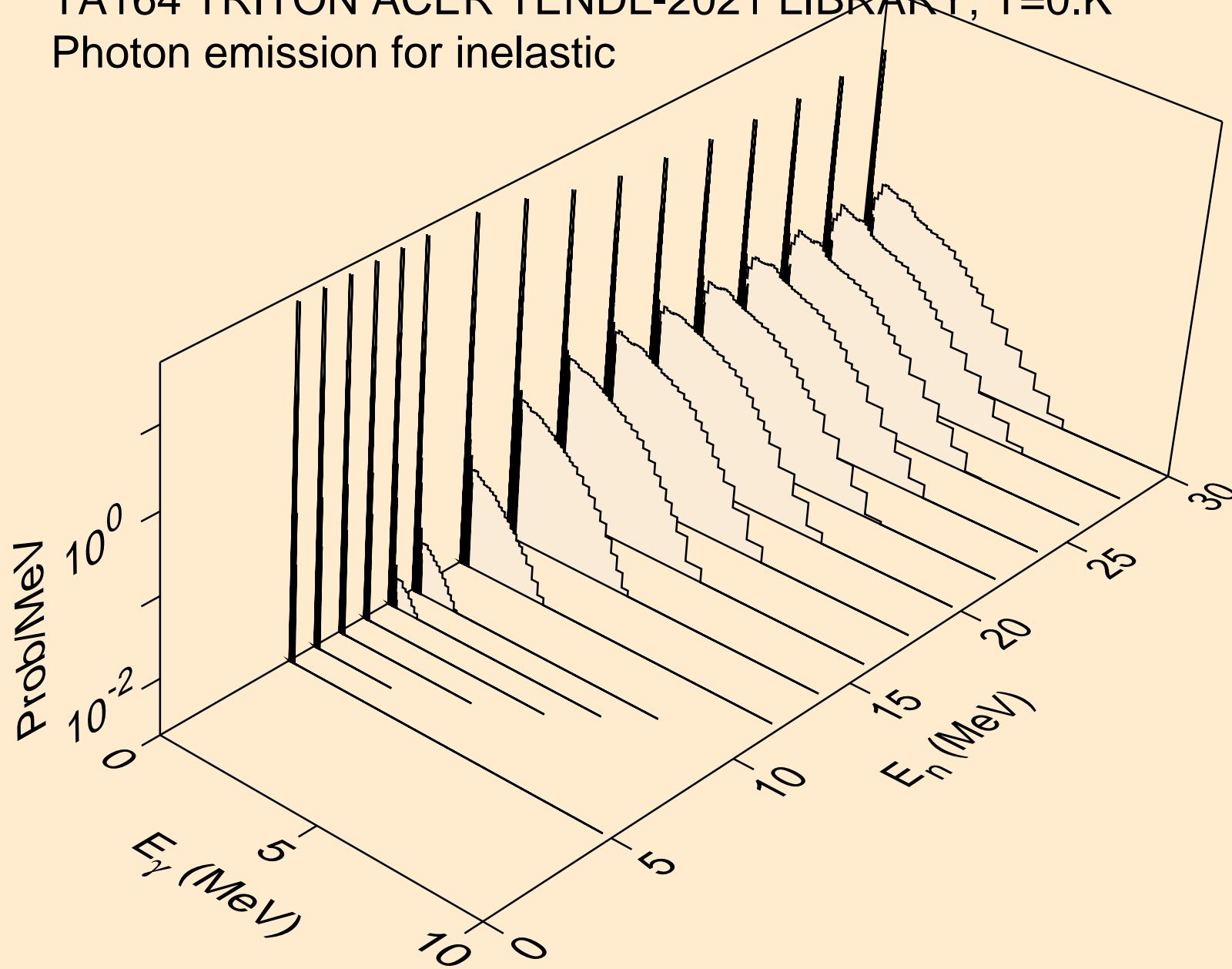

TA164 TRITON ACER TENDL-2021 LIBRARY; T=0.K  
Photon emission for (n,he3)

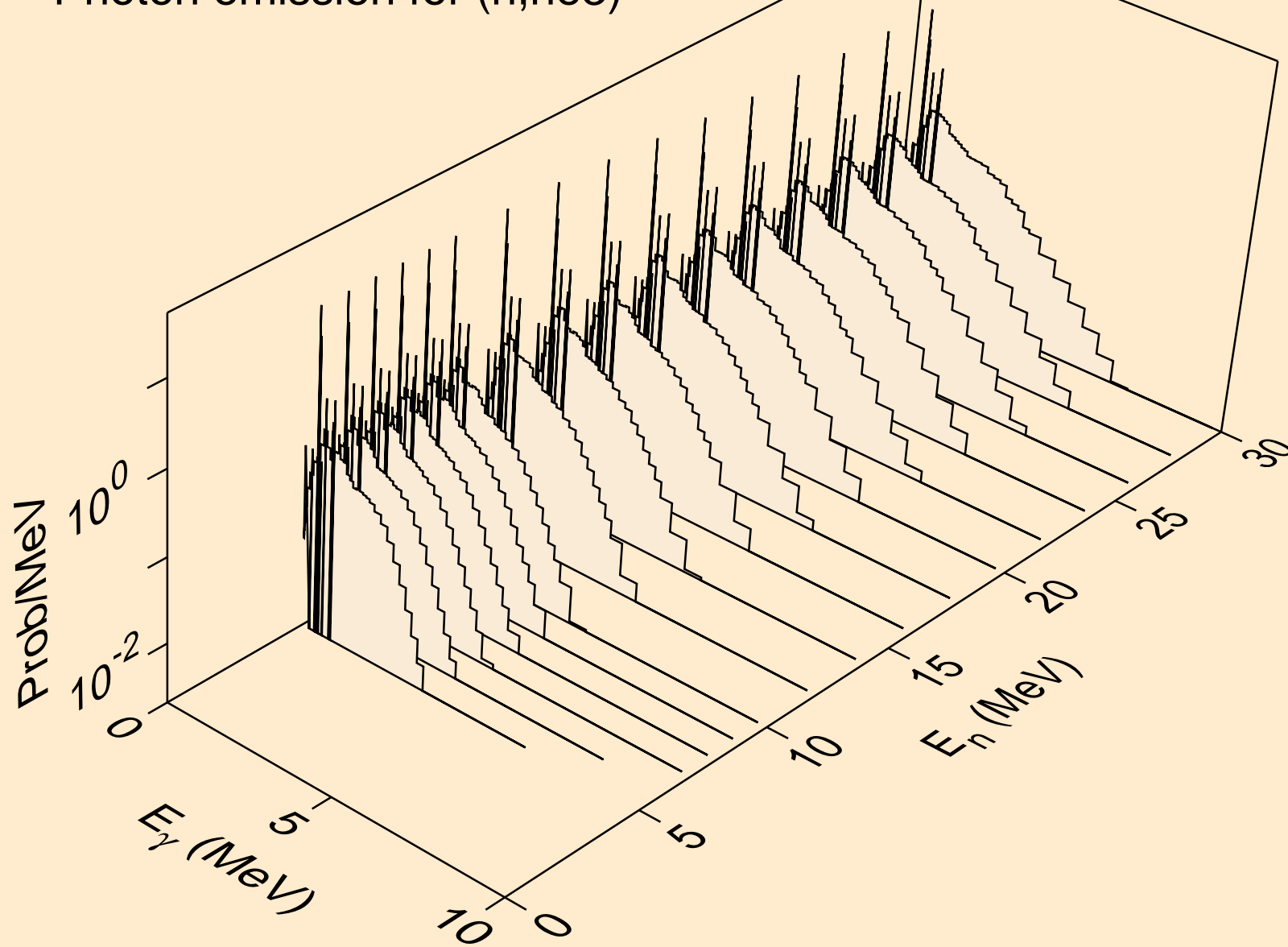

TA164 TRITON ACER TENDL-2021 LIBRARY; T=0.K  
Photon emission for (n,a)

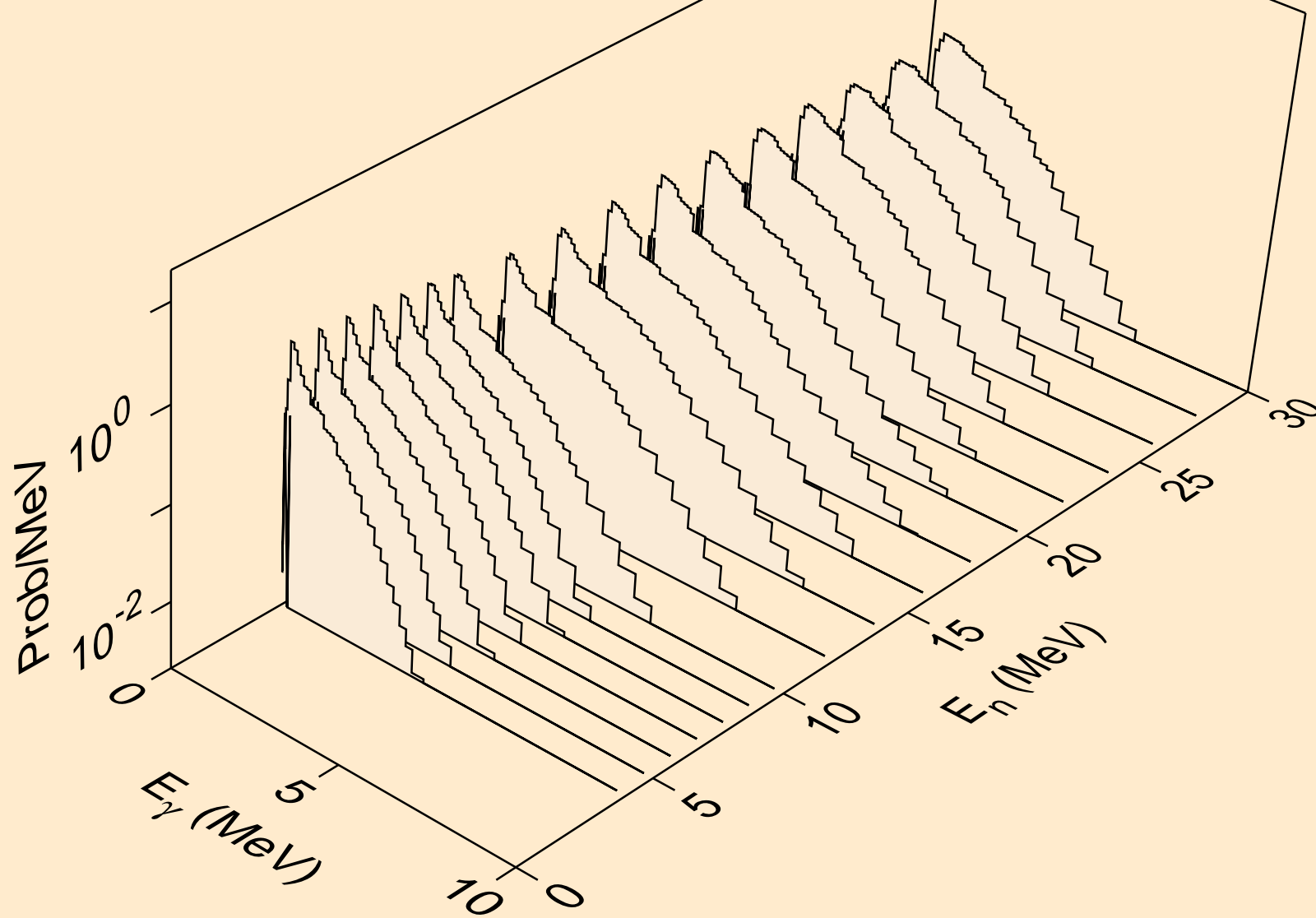

TA164 TRITON ACER TENDL-2021 LIBRARY; T=0.K  
Photon emission for (n,2a)

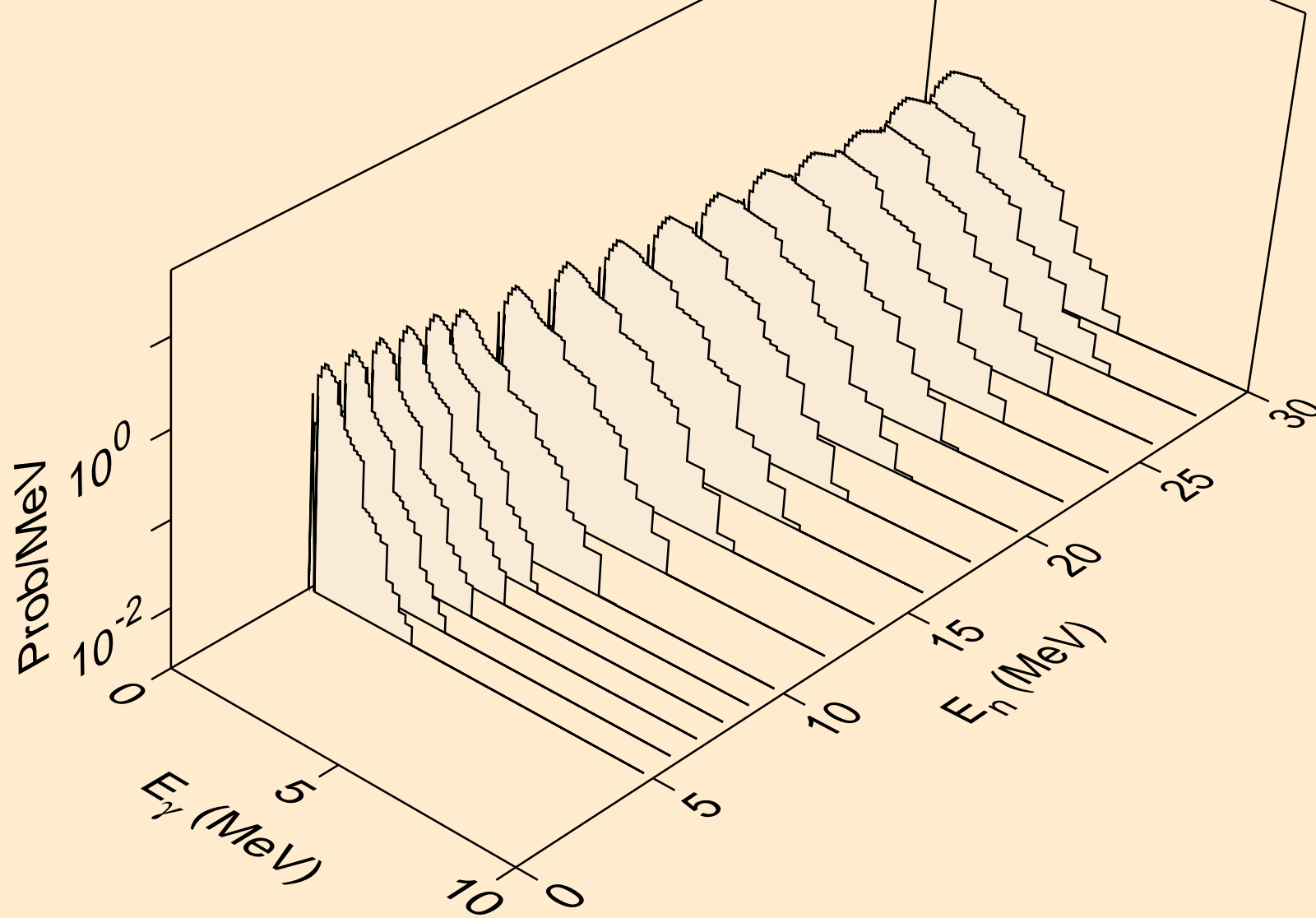



TA164 TRITON ACER TENDL-2021 LIBRARY; T=0.K  
Photon emission for (n,3a)

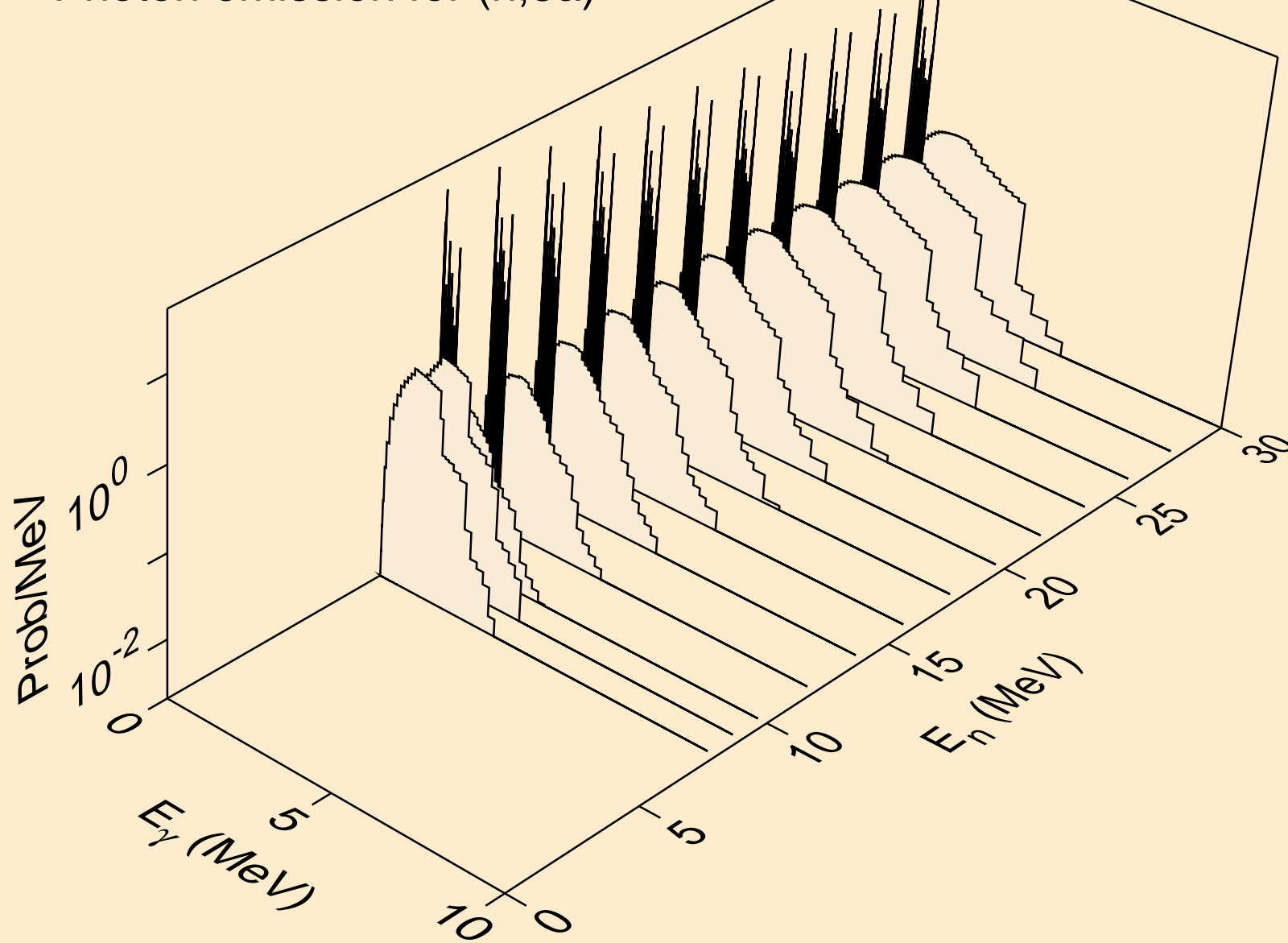

TA164 TRITON ACER TENDL-2021 LIBRARY; T=0.K  
Photon emission for (n,2p)

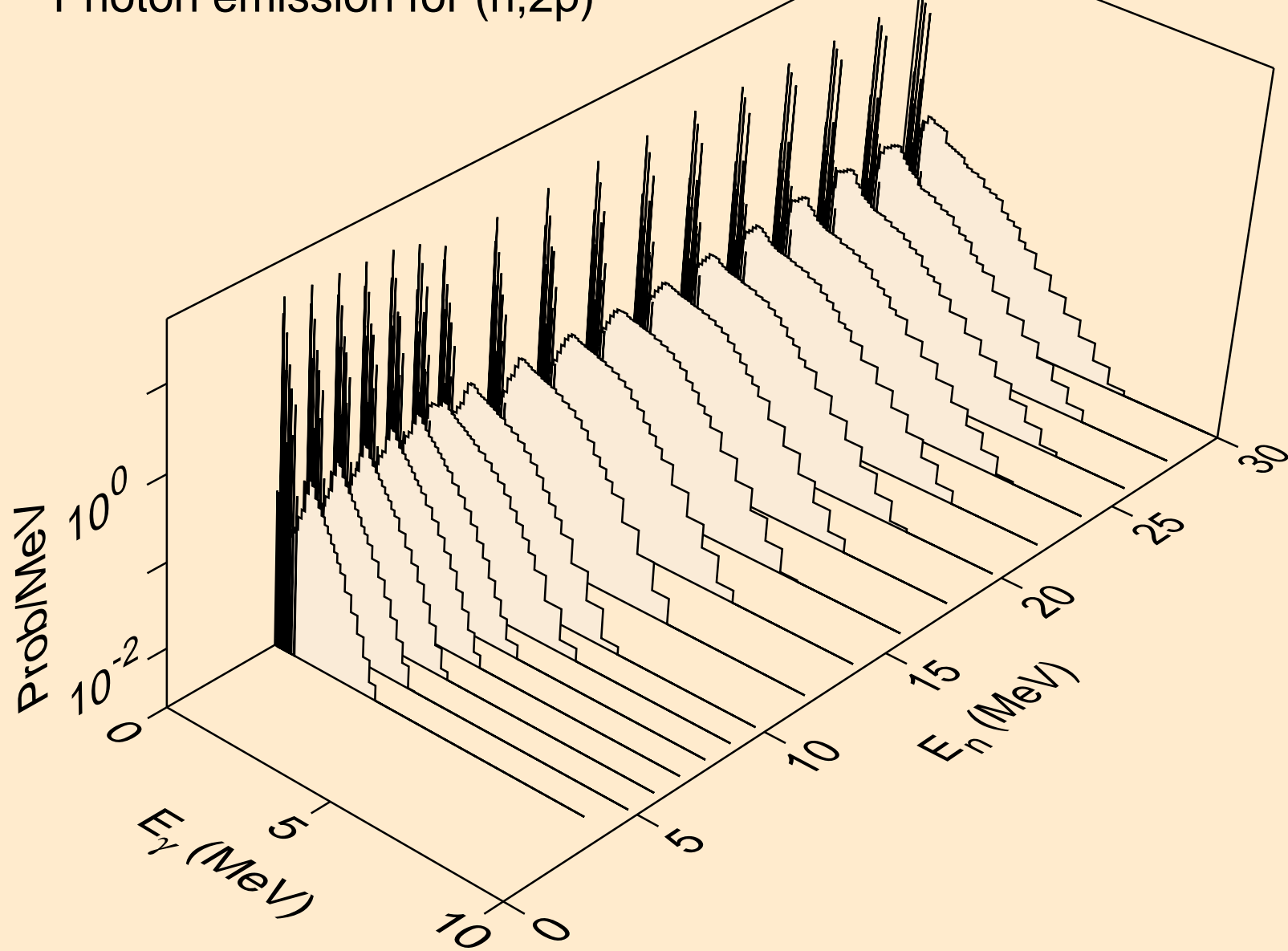

TA164 TRITON ACER TENDL-2021 LIBRARY; T=0.K  
Photon emission for (n,pa)

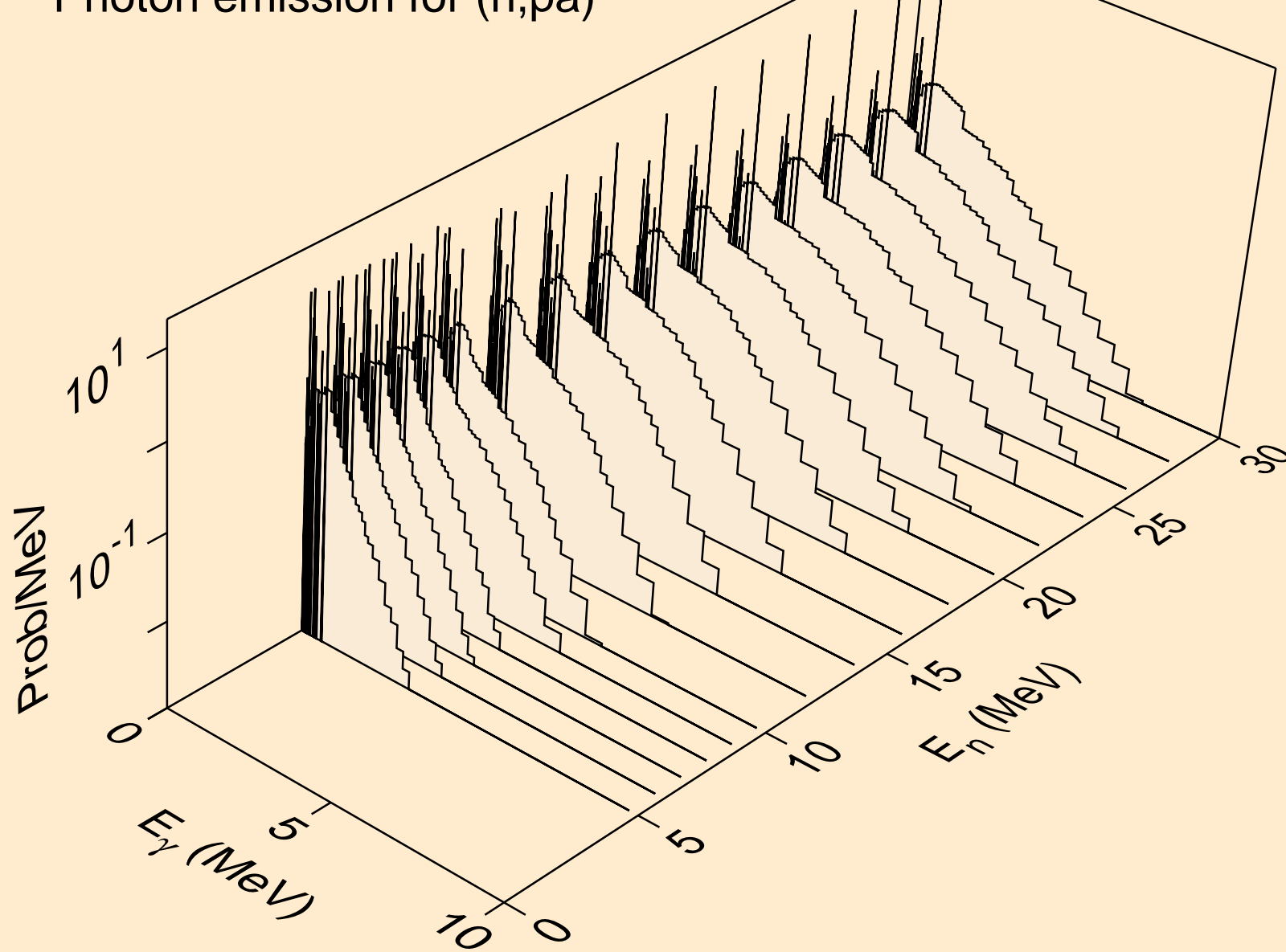

TA164 TRITON ACER TENDL-2021 LIBRARY; T=0.K  
Photon emission for (n,t2a)

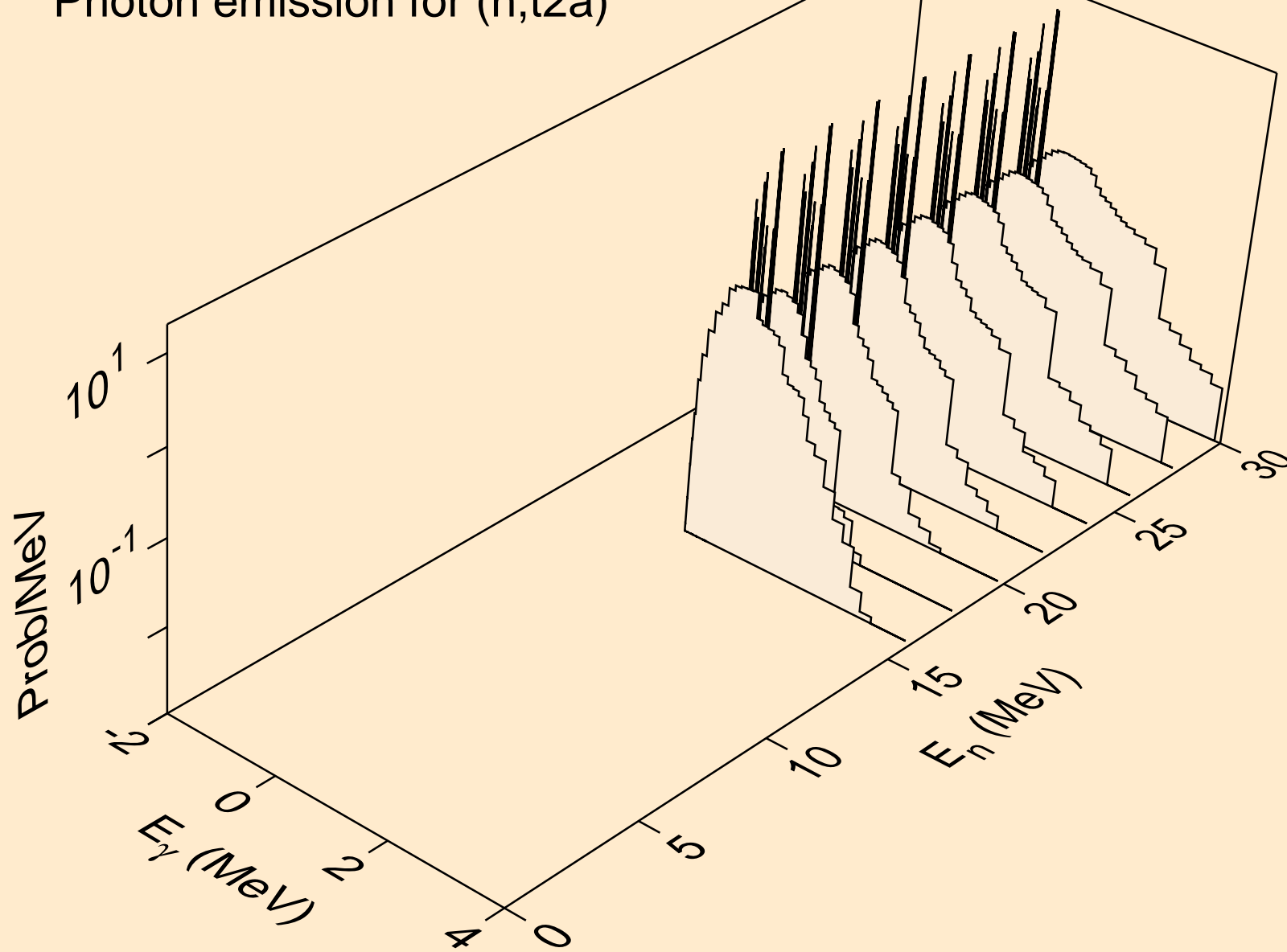

TA164 TRITON ACER TENDL-2021 LIBRARY; T=0.K  
Photon emission for (n,d2a)

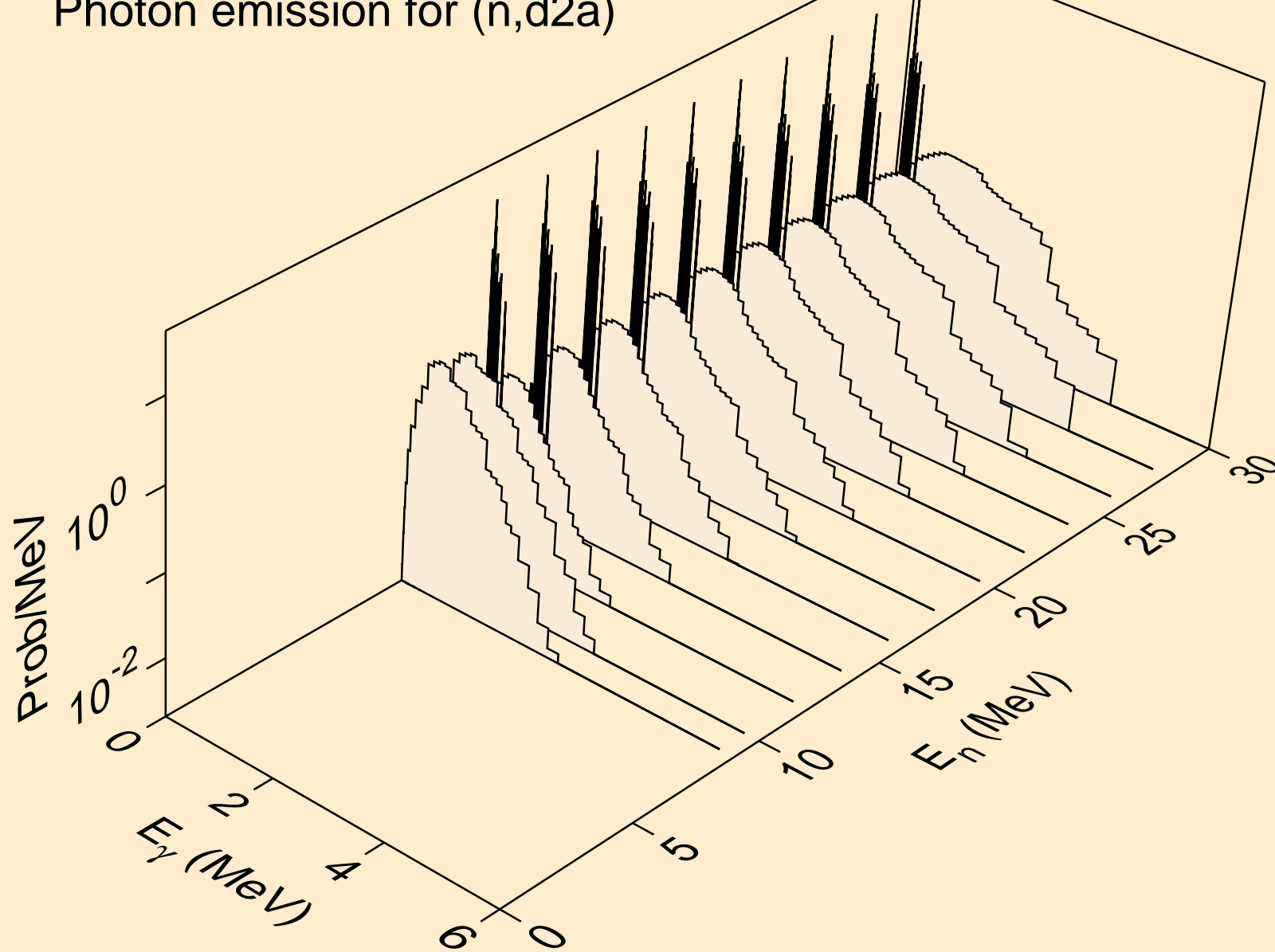

TA164 TRITON ACER TENDL-2021 LIBRARY; T=0.K  
Photon emission for (n,pd)

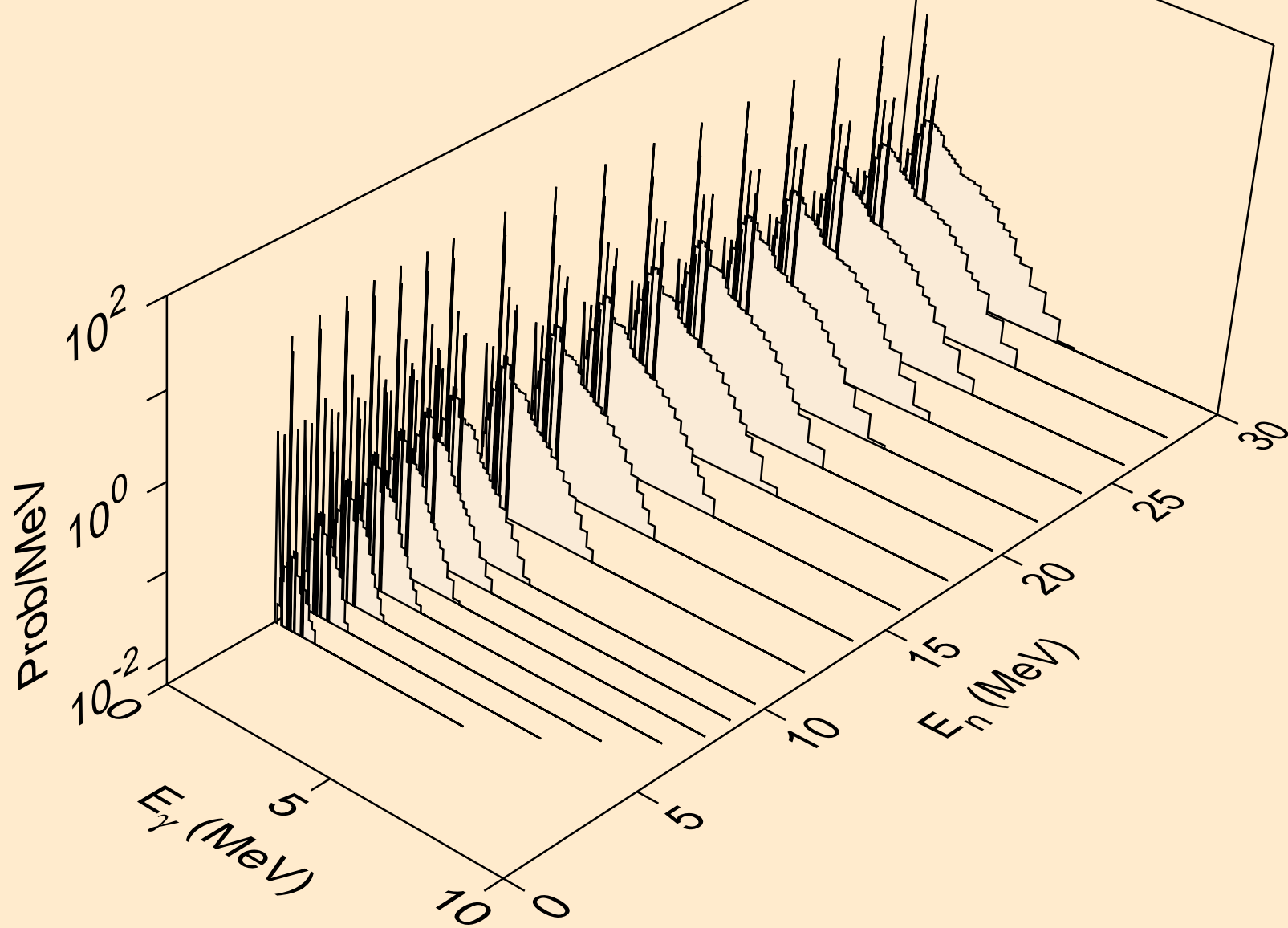

TA164 TRITON ACER TENDL-2021 LIBRARY; T=0.K  
Photon emission for (n,pt)

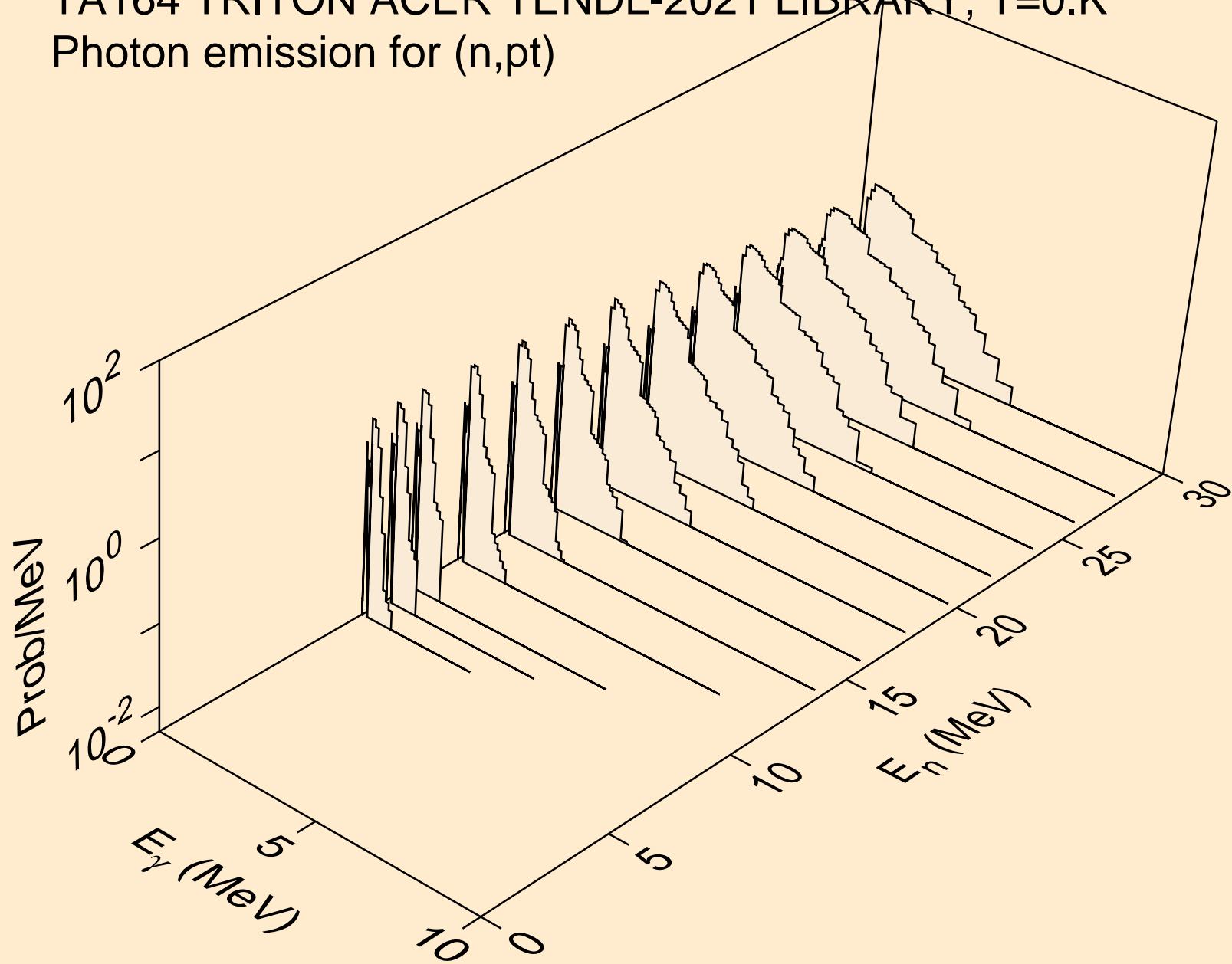

TA164 TRITON ACER TENDL-2021 LIBRARY; T=0.K  
Photon emission for (n,da)

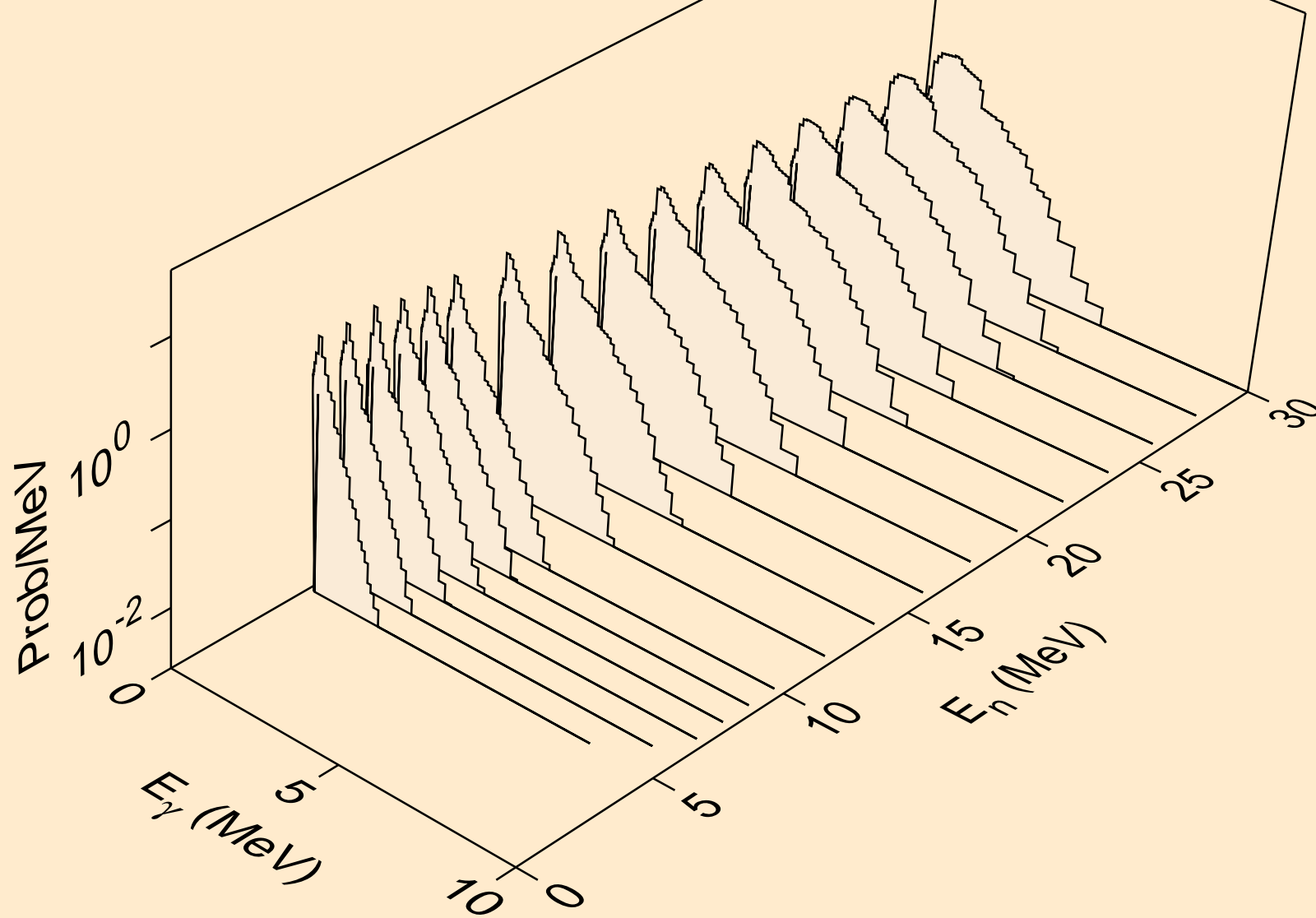



TA164 TRITON ACER TENDL-2021 LIBRARY; T=0.K  
Particle heating contributions

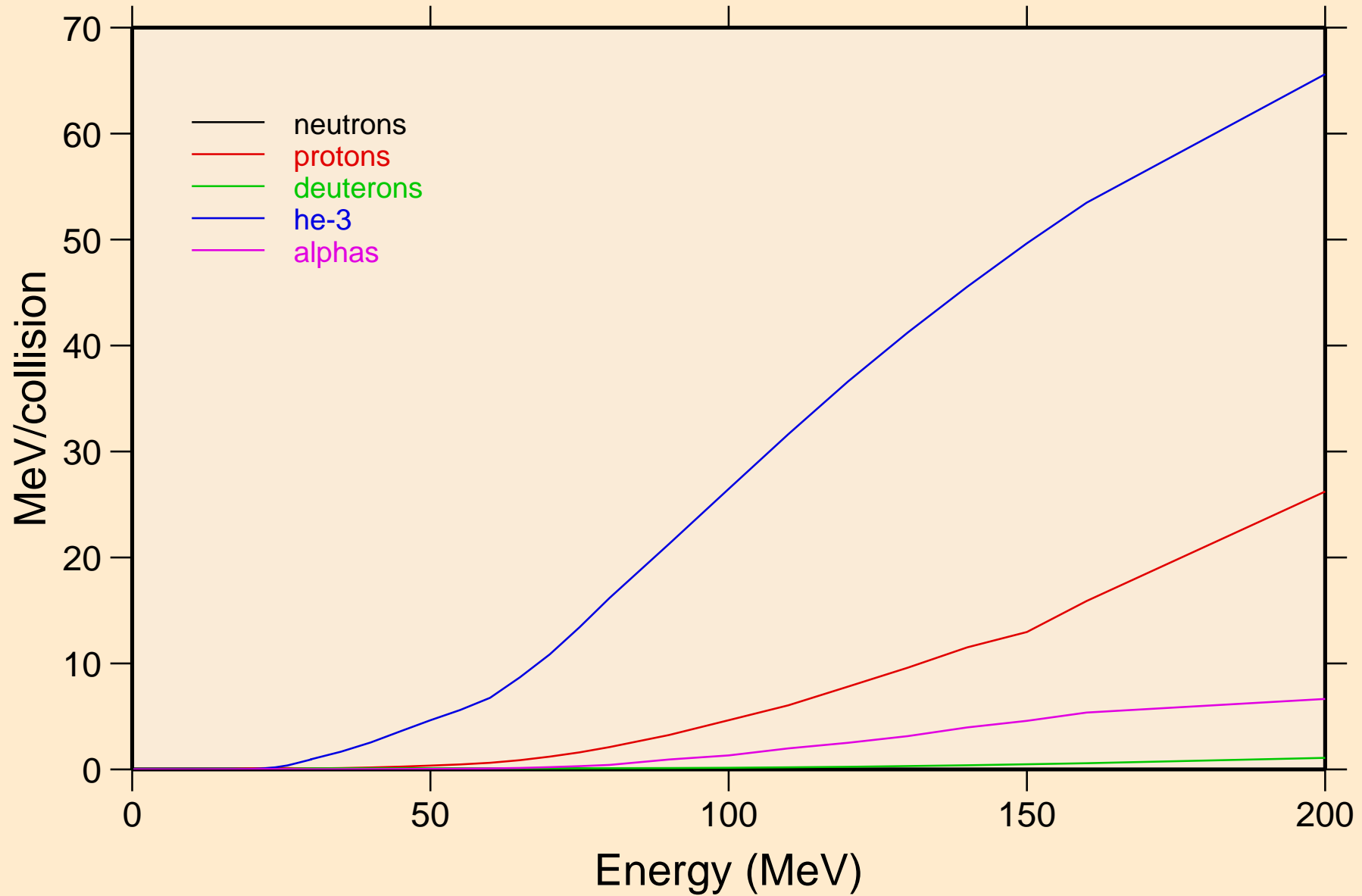

TA164 TRITON ACER TENDL-2021 LIBRARY; T=0.K  
Recoil Heating

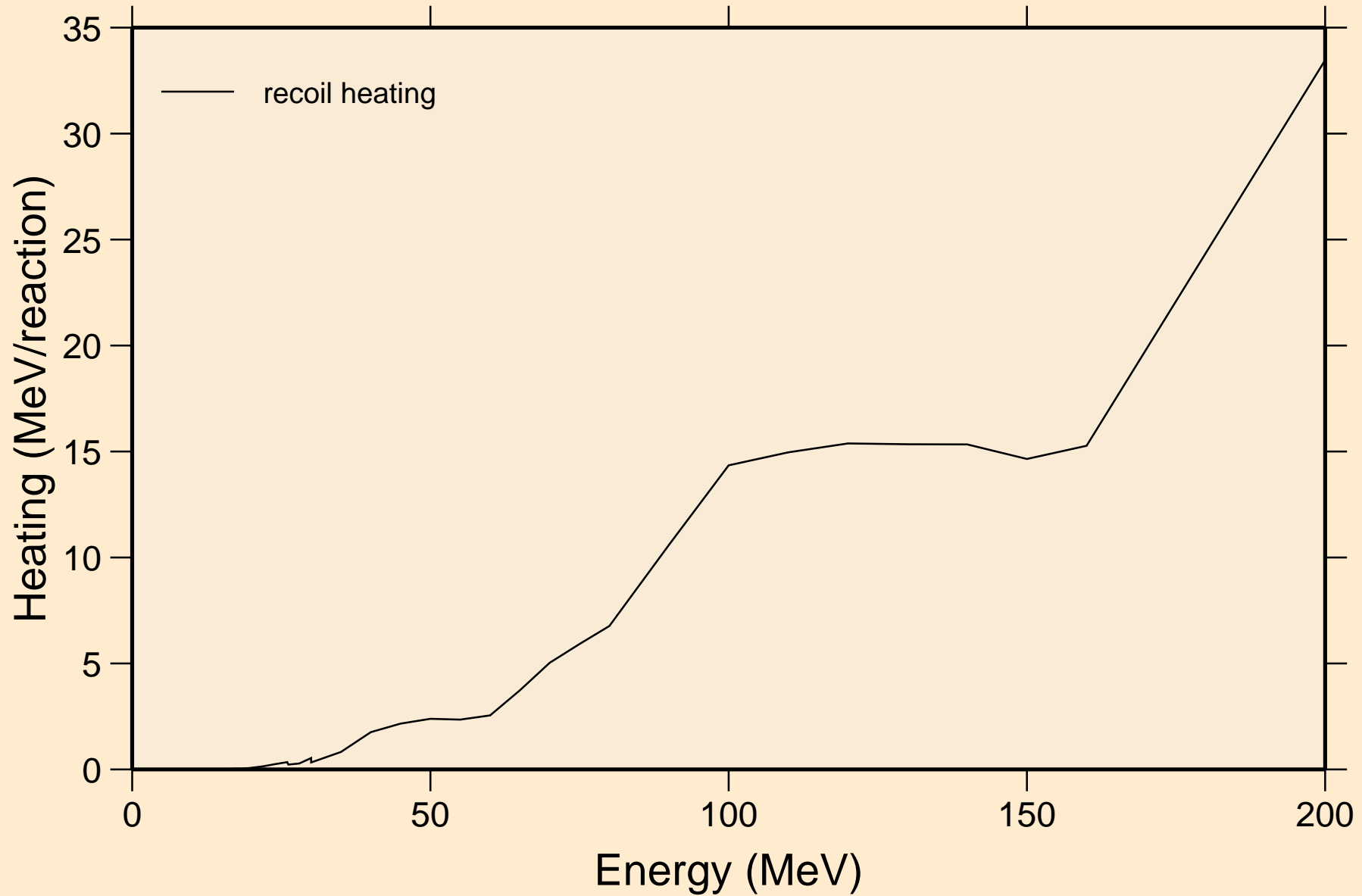

TA164 TRITON ACER TENDL-2021 LIBRARY; T=0.K  
Particle production cross sections

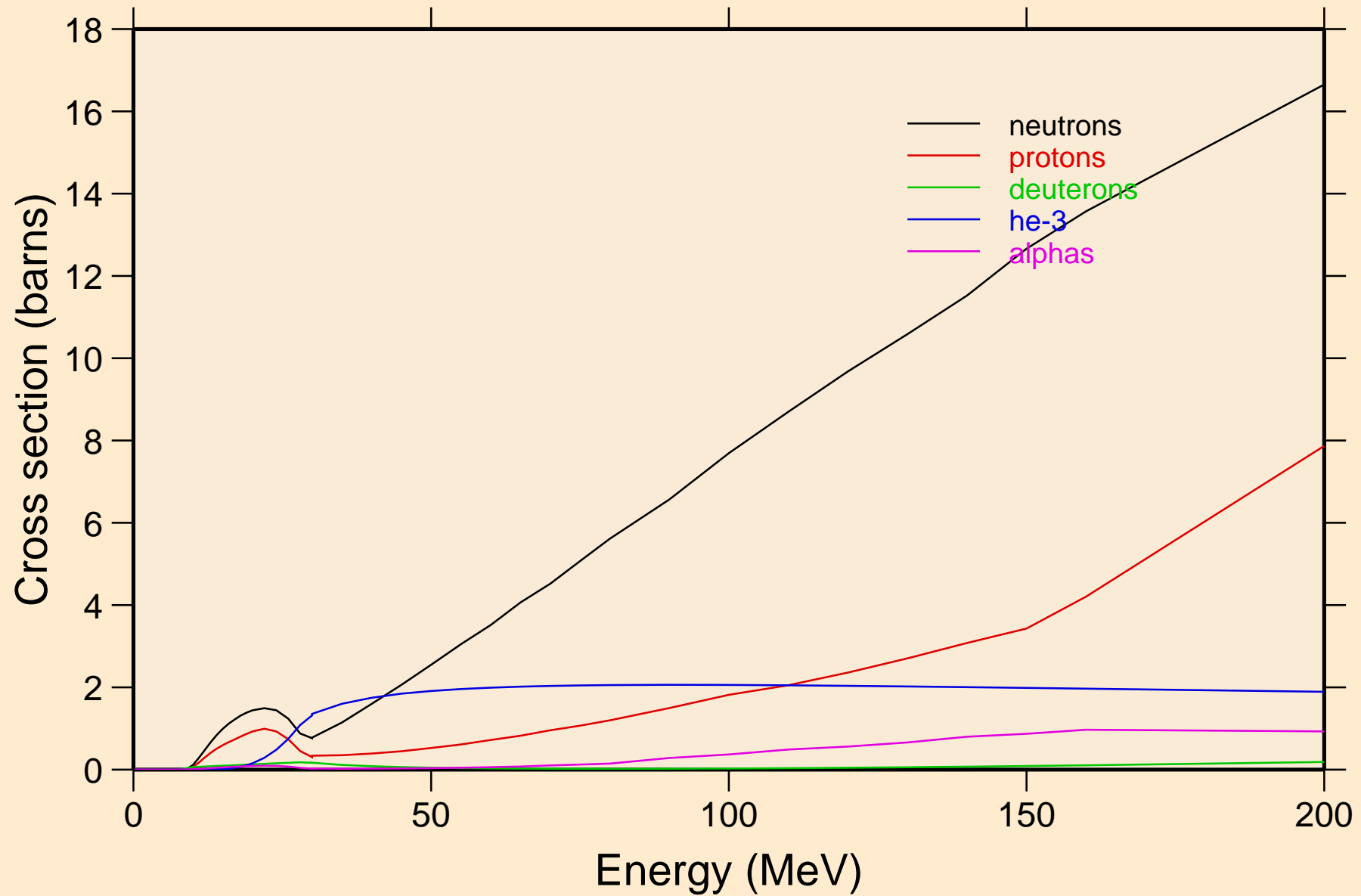

TA164 TRITON ACER TENDL-2021 LIBRARY; T=0.K  
neutrons from (t,n)

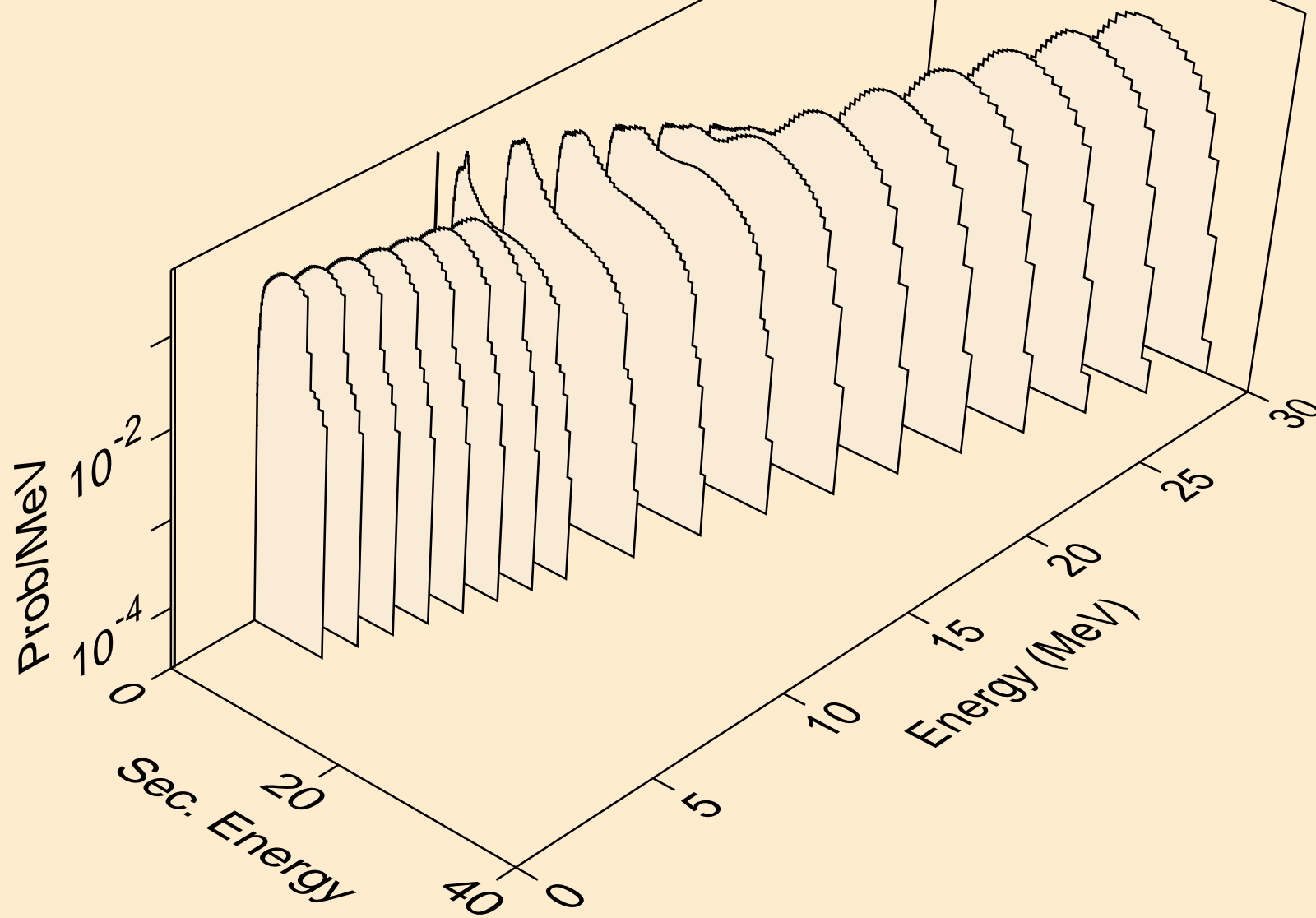

TA164 TRITON ACER TENDL-2021 LIBRARY; T=0.K  
neutrons from (t,x)

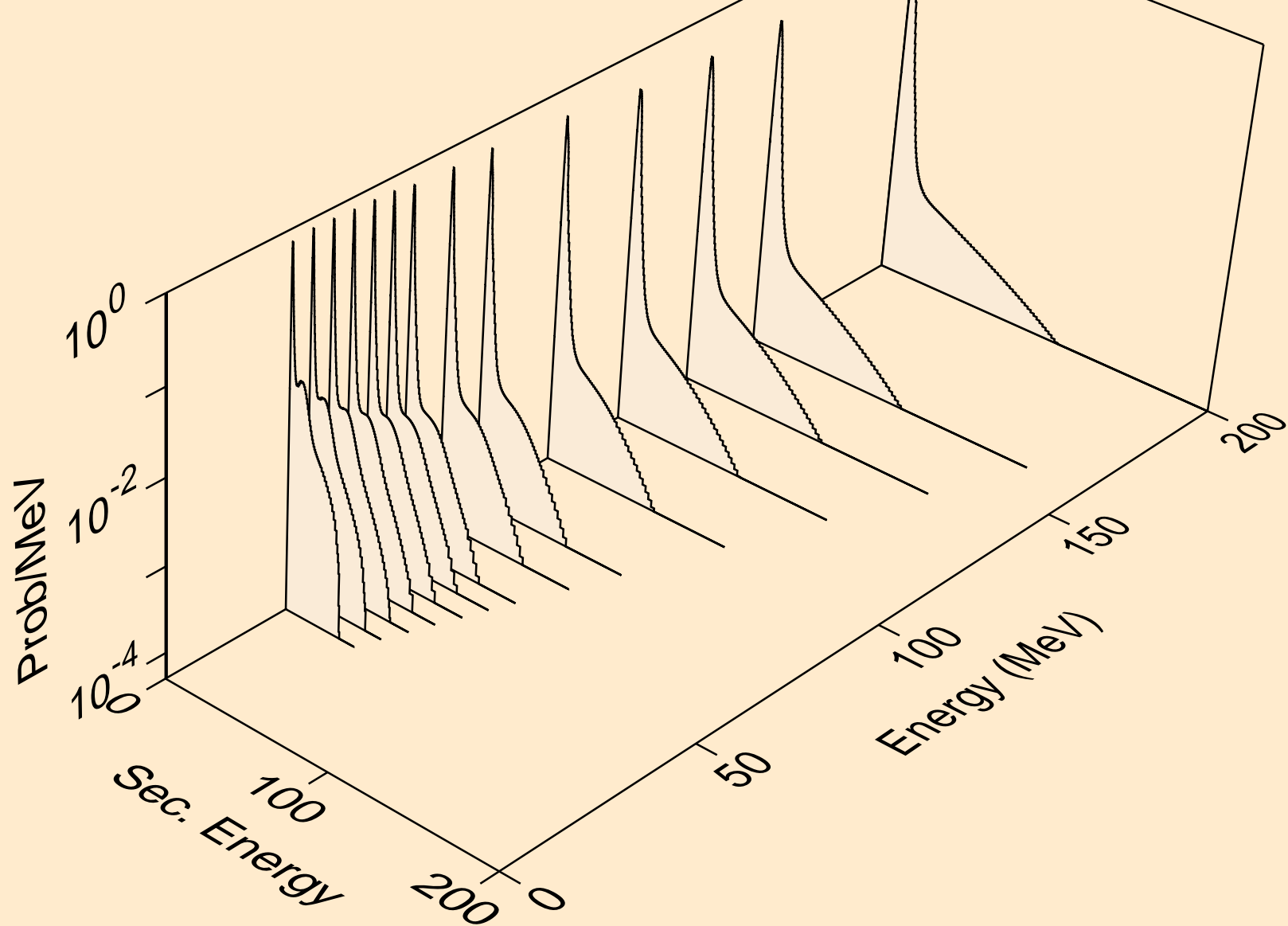

TA164 TRITON ACER TENDL-2021 LIBRARY; T=0.K  
neutrons from (t,2nd)

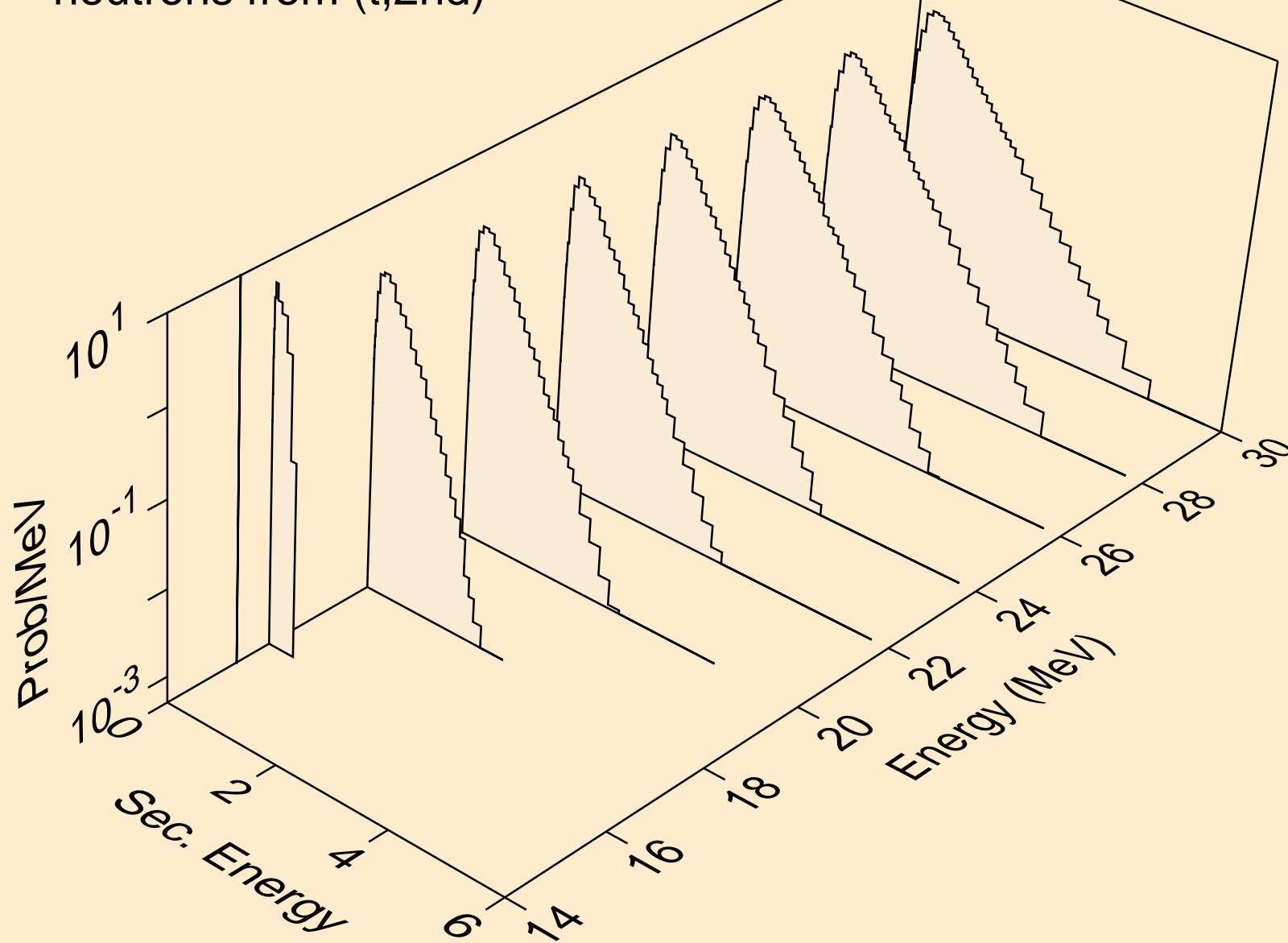

TA164 TRITON ACER TENDL-2021 LIBRARY; T=0.K  
neutrons from (t,2n)

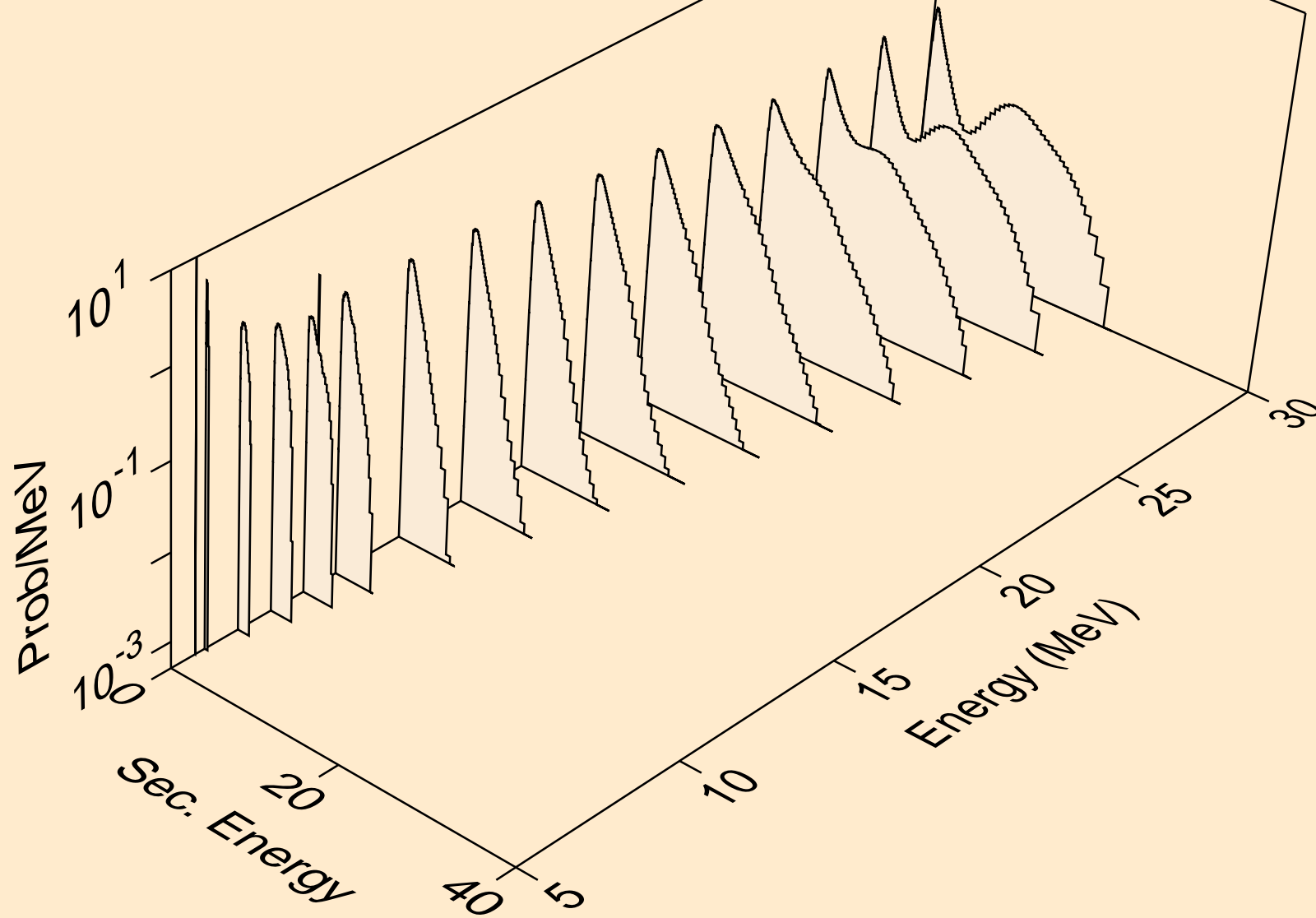

TA164 TRITON ACER TENDL-2021 LIBRARY; T=0.K  
neutrons from (t,3n)

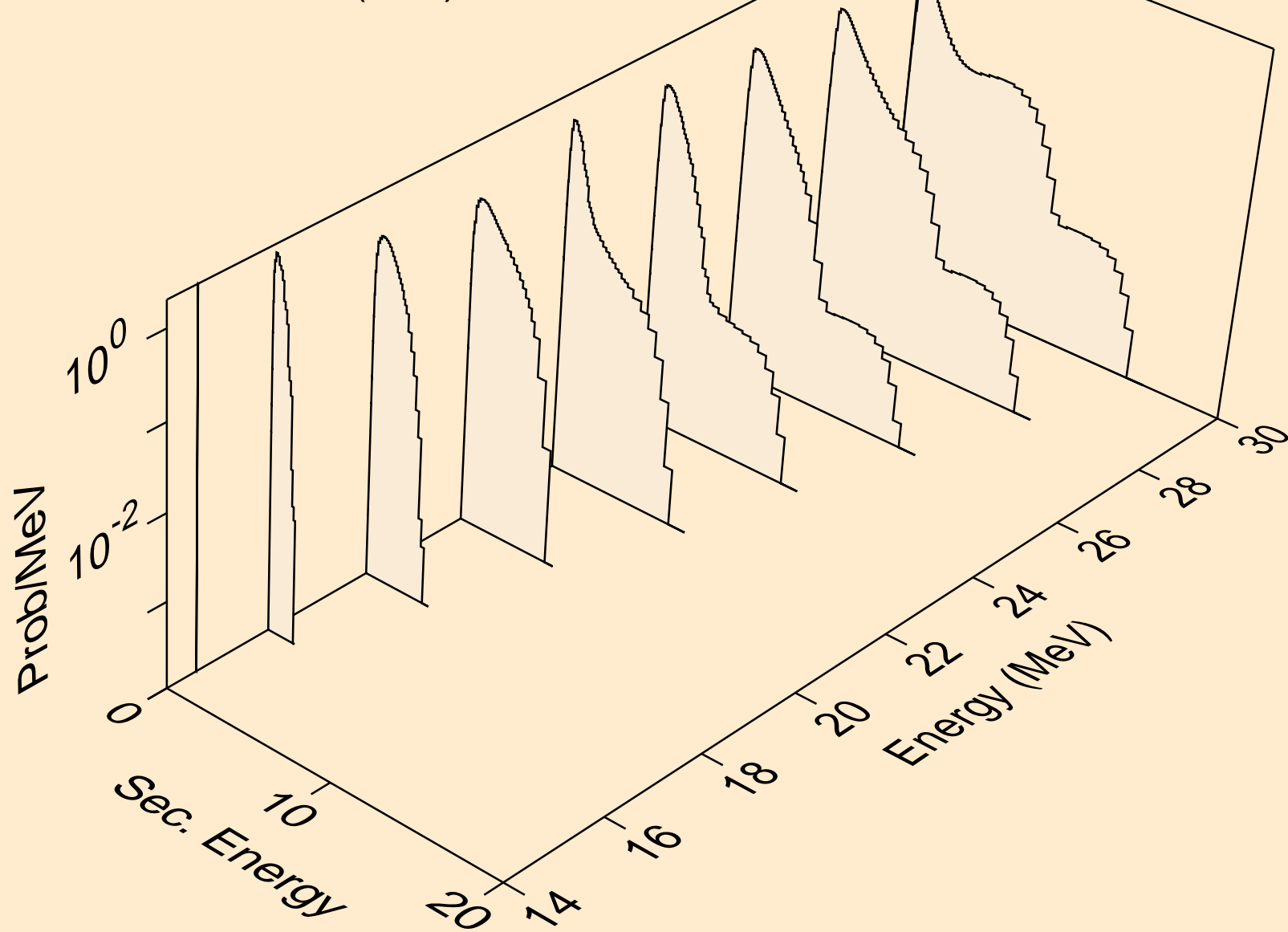



TA164 TRITON ACER TENDL-2021 LIBRARY; T=0.K  
neutrons from (t,n\*)a

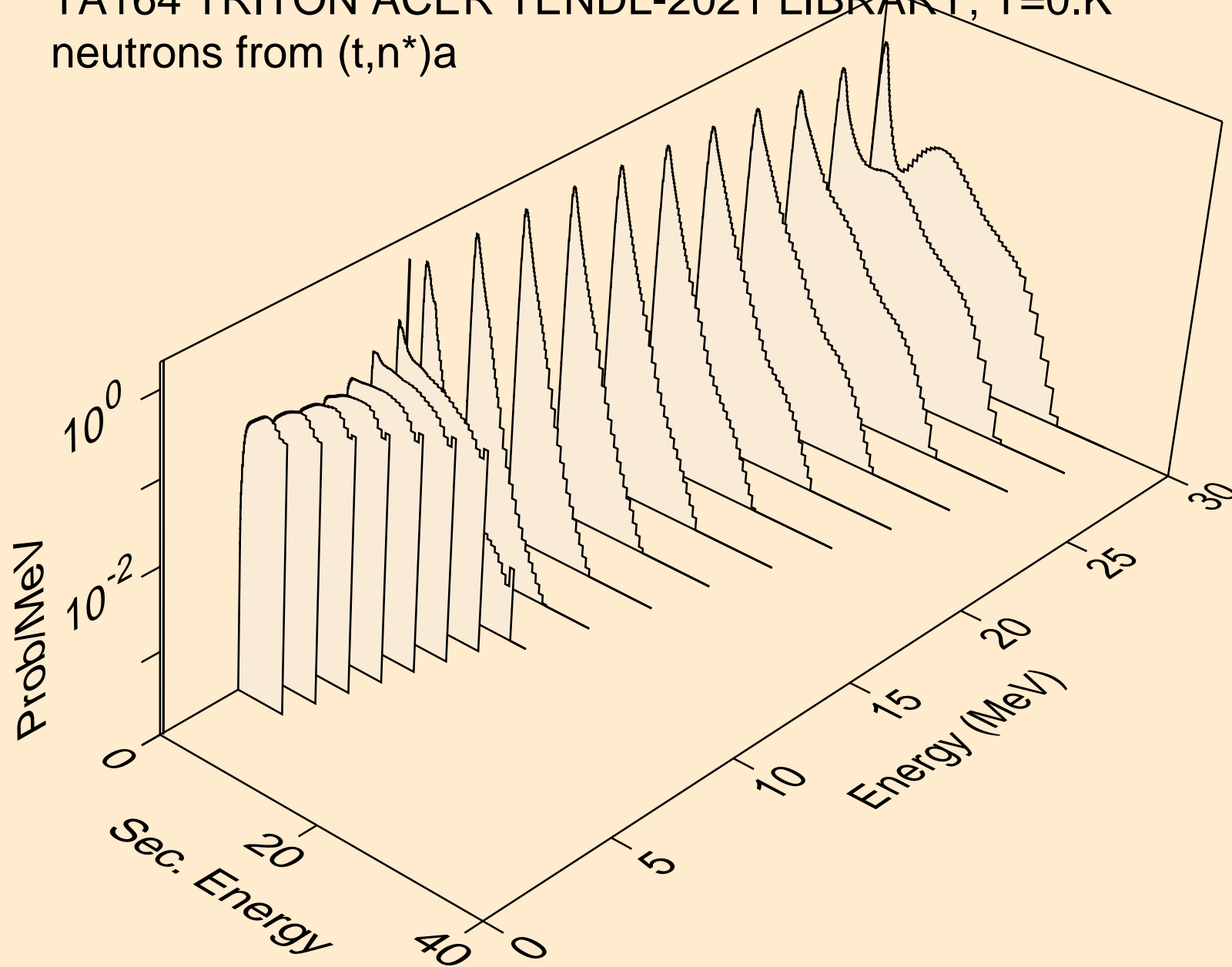

TA164 TRITON ACER TENDL-2021 LIBRARY; T=0.K  
neutrons from (t,n\*)3a

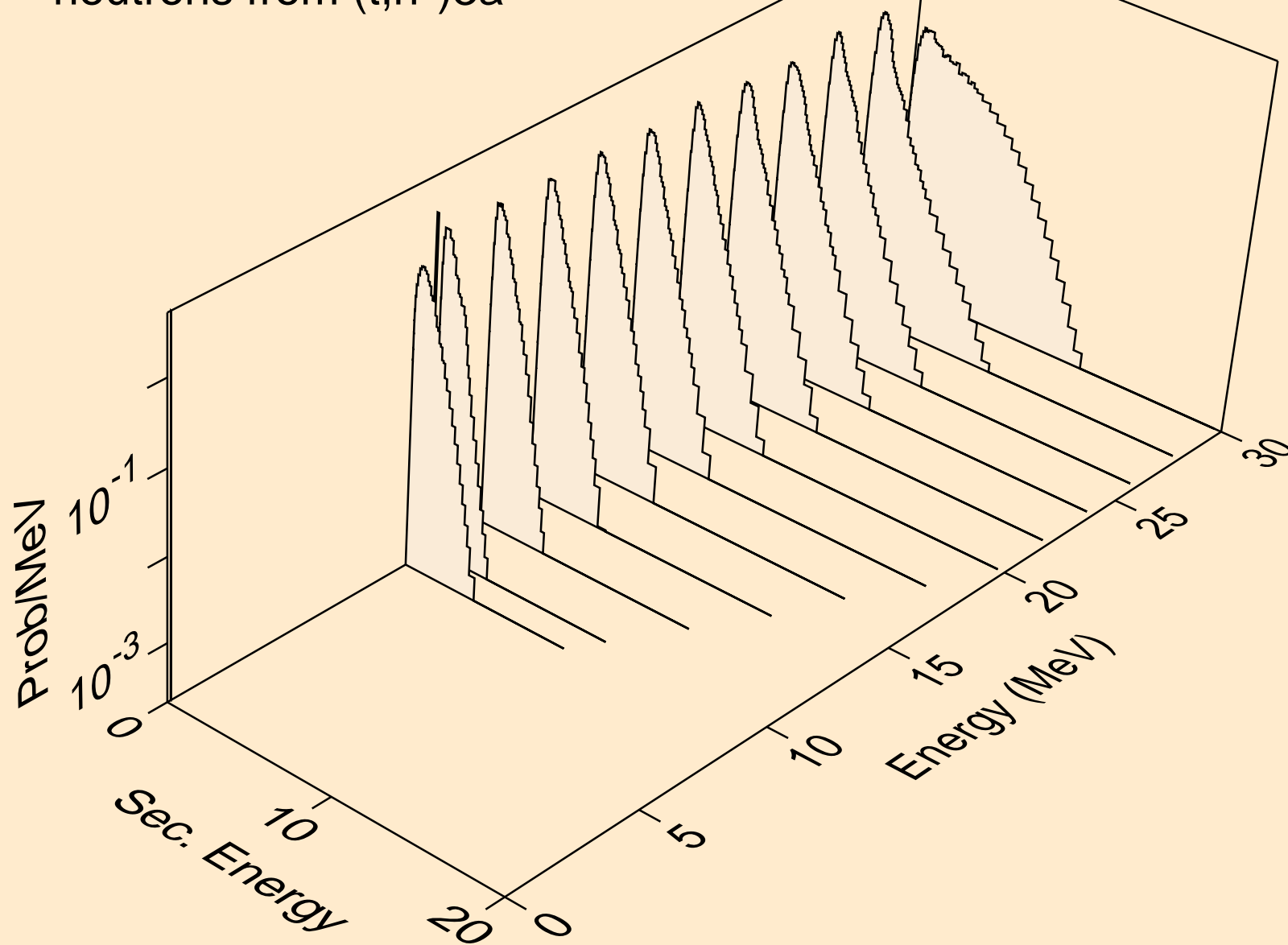

TA164 TRITON ACER TENDL-2021 LIBRARY; T=0.K  
neutrons from (t,2n)a

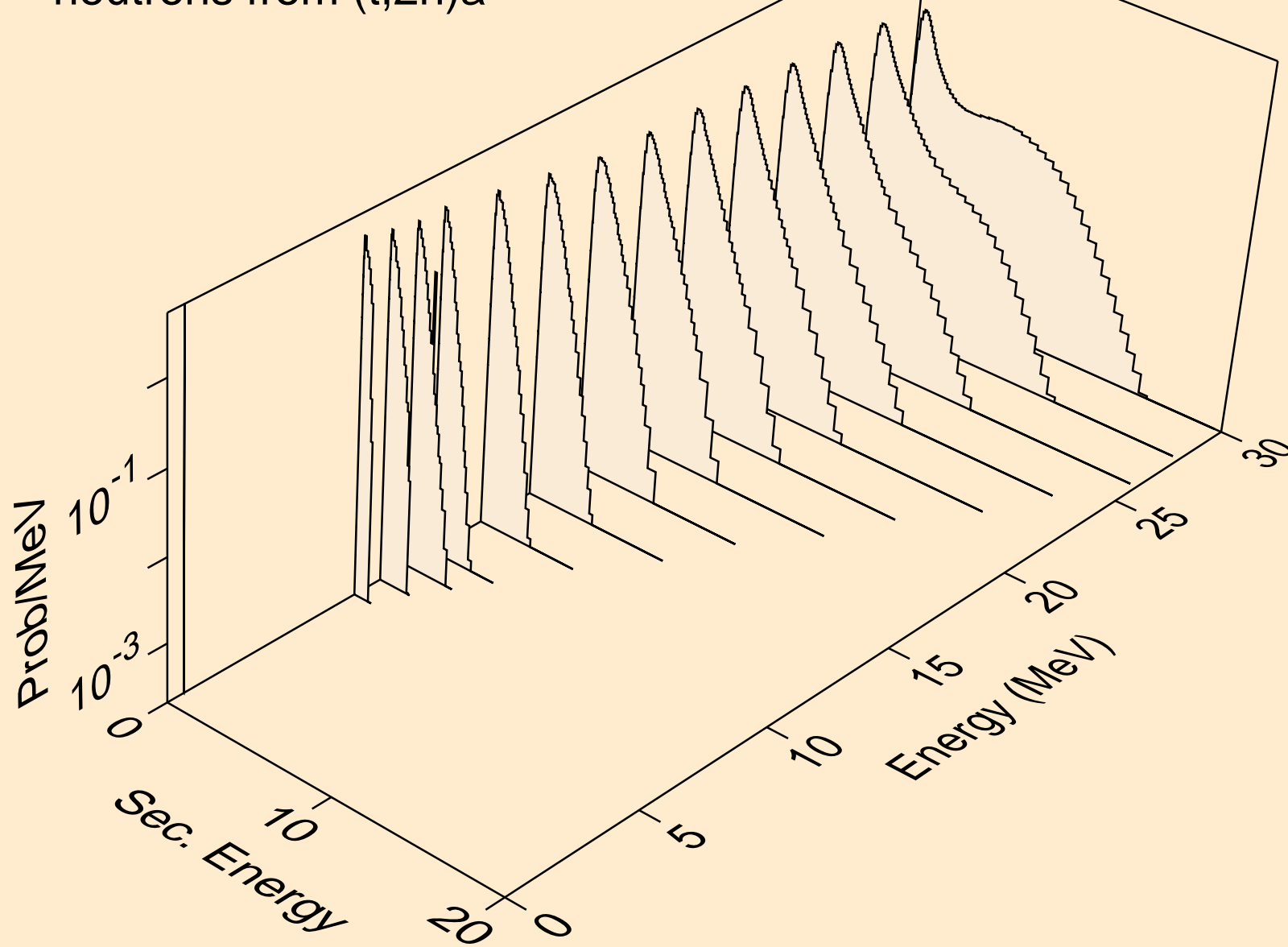

TA164 TRITON ACER TENDL-2021 LIBRARY; T=0.K  
neutrons from (t,3n)a

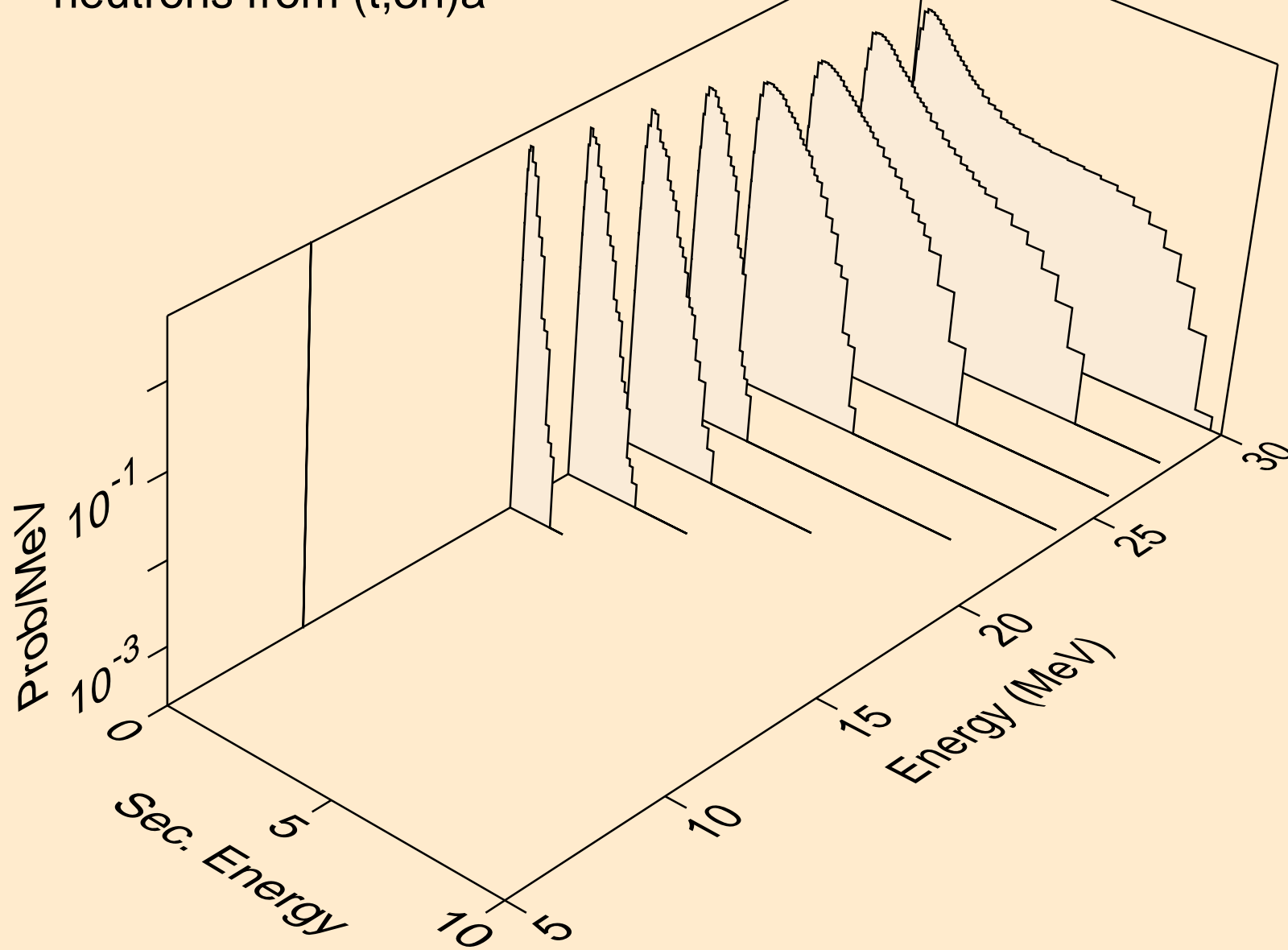

TA164 TRITON ACER TENDL-2021 LIBRARY; T=0.K  
neutrons from (t,n\*)p

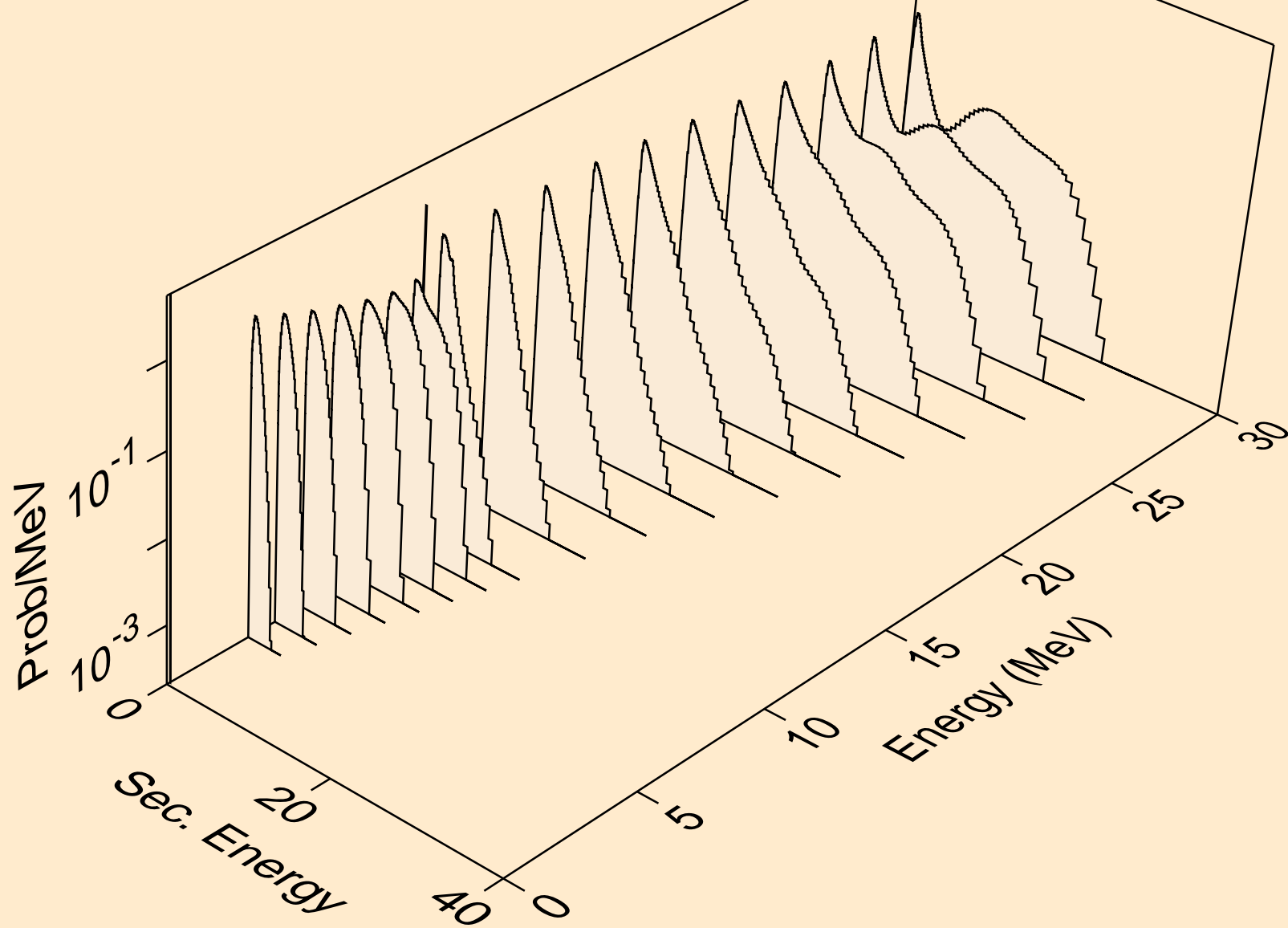

TA164 TRITON ACER TENDL-2021 LIBRARY; T=0.K  
neutrons from (t,n\*)2a

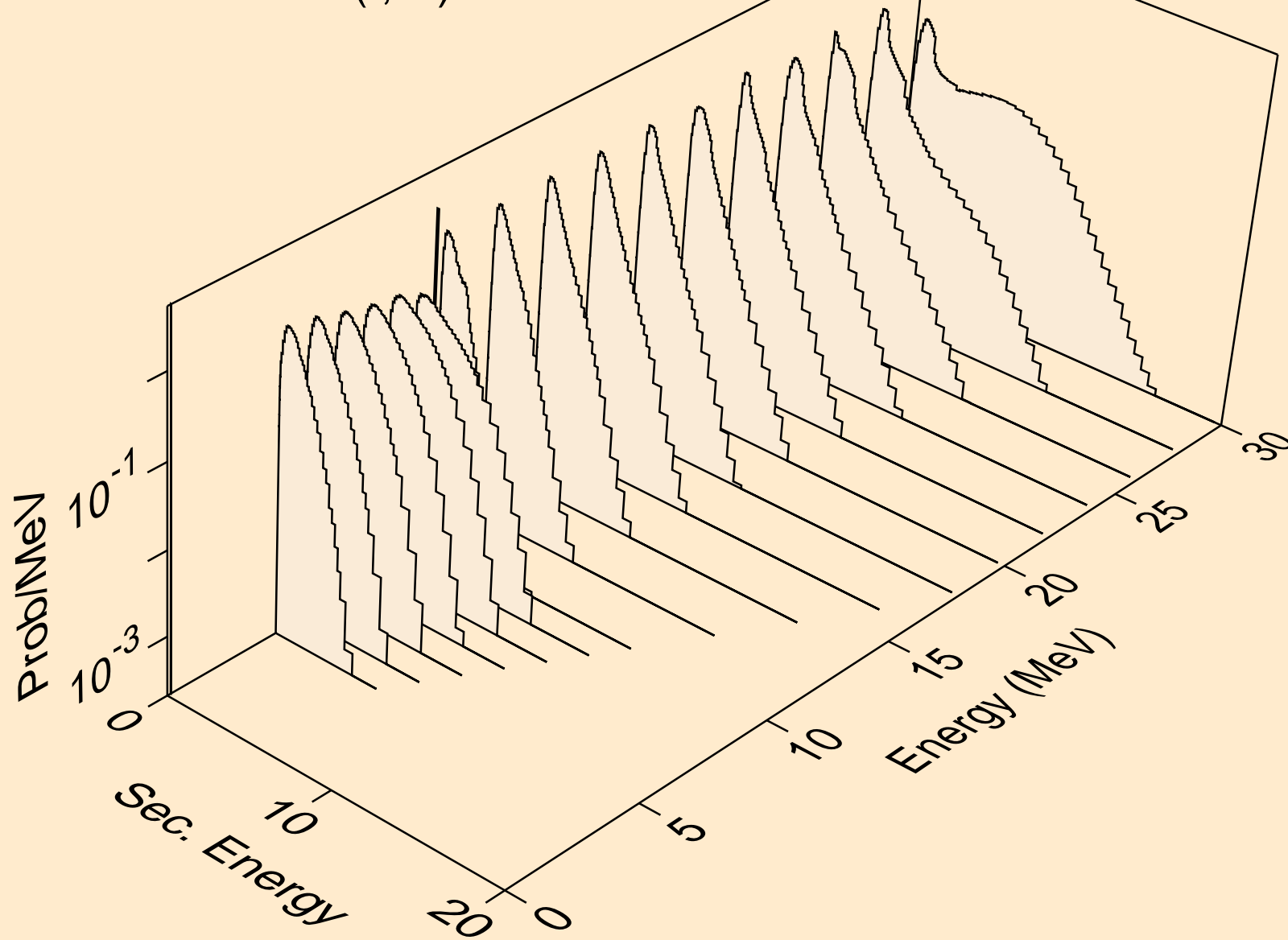

TA164 TRITON ACER TENDL-2021 LIBRARY; T=0.K  
neutrons from (t,2n)2a

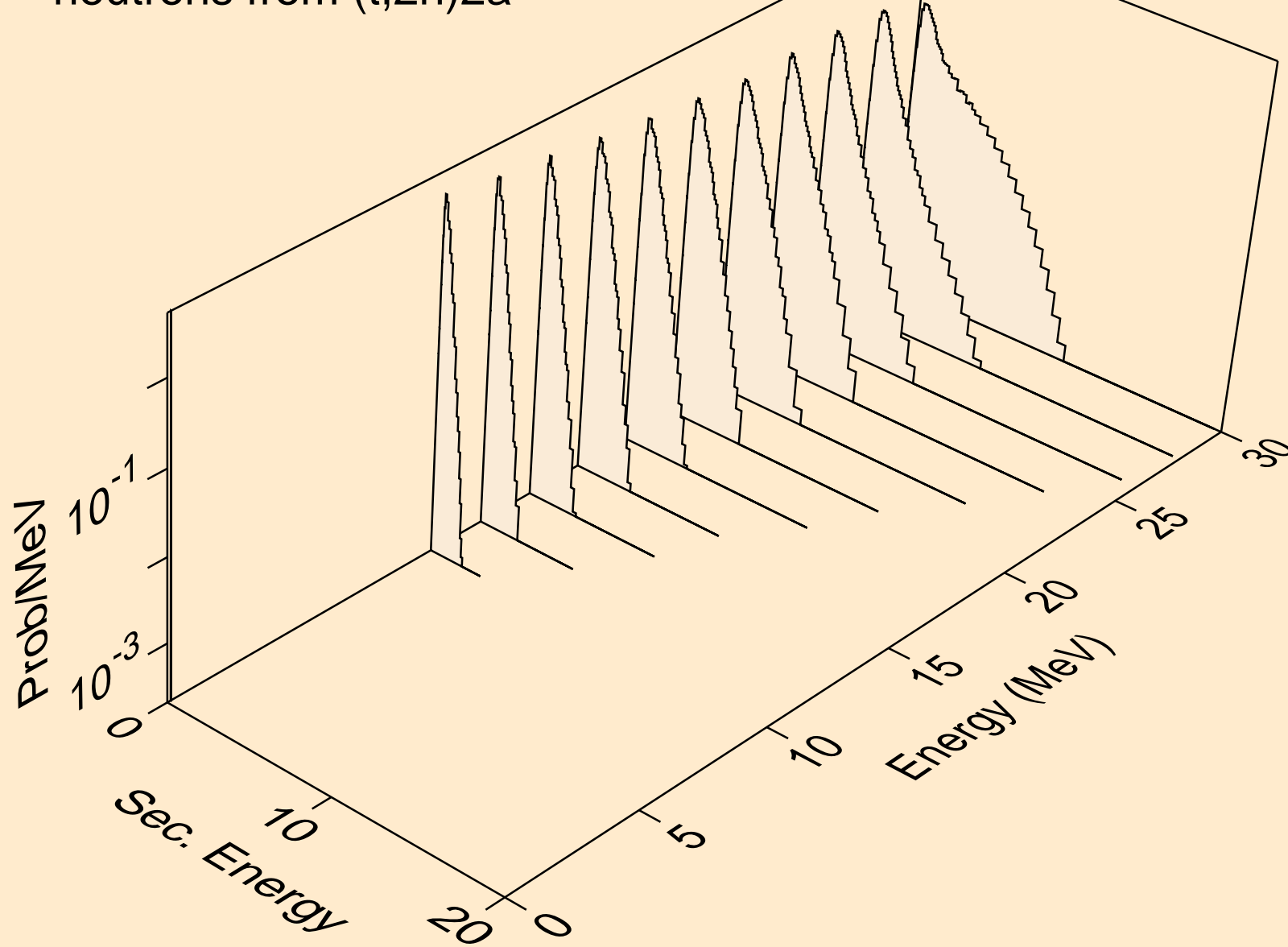

TA164 TRITON ACER TENDL-2021 LIBRARY; T=0.K  
neutrons from (t,n\*)d

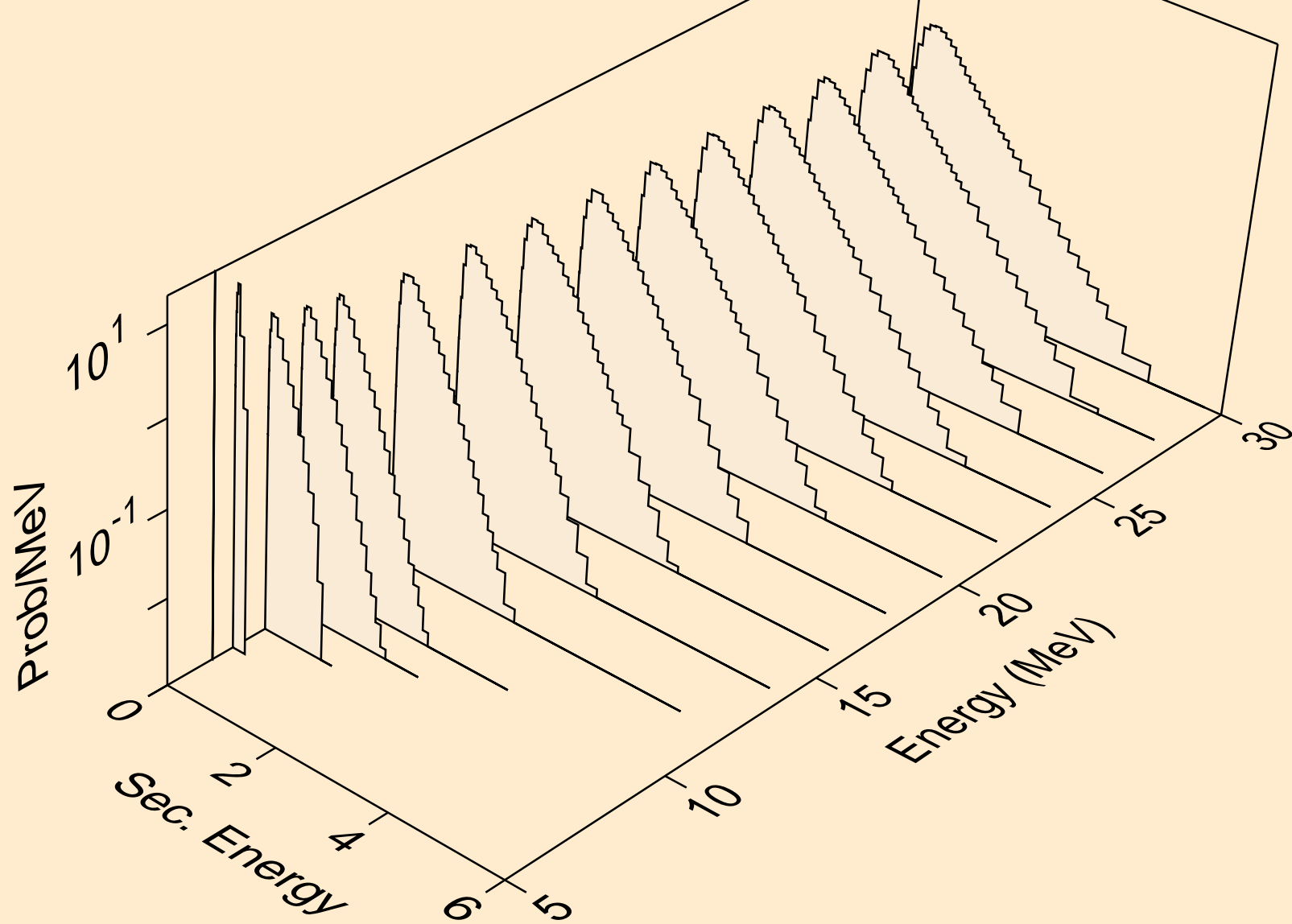



TA164 TRITON ACER TENDL-2021 LIBRARY; T=0.K  
neutrons from (t,n\*)t

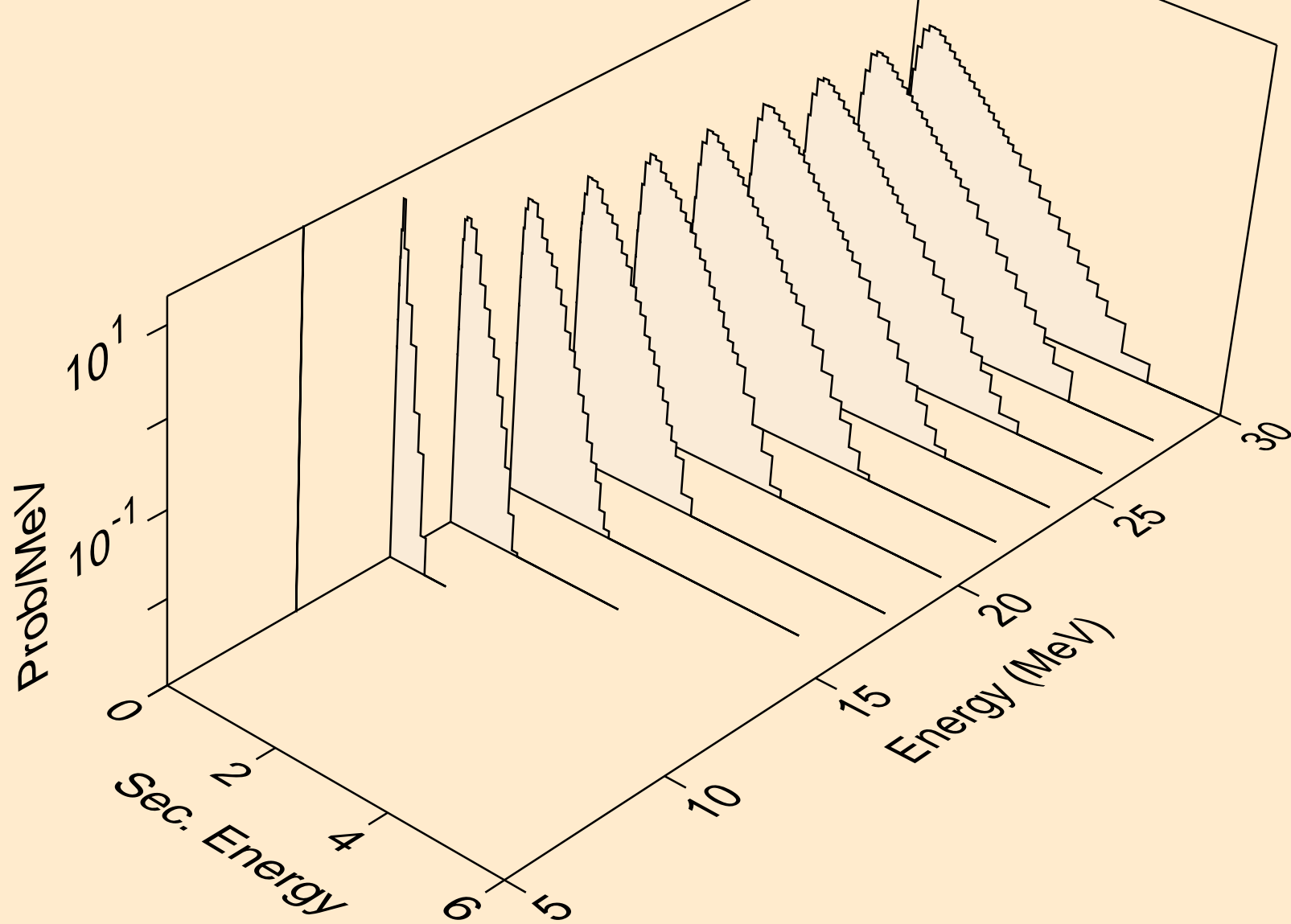

TA164 TRITON ACER TENDL-2021 LIBRARY; T=0.K  
neutrons from (t,n\*)he3

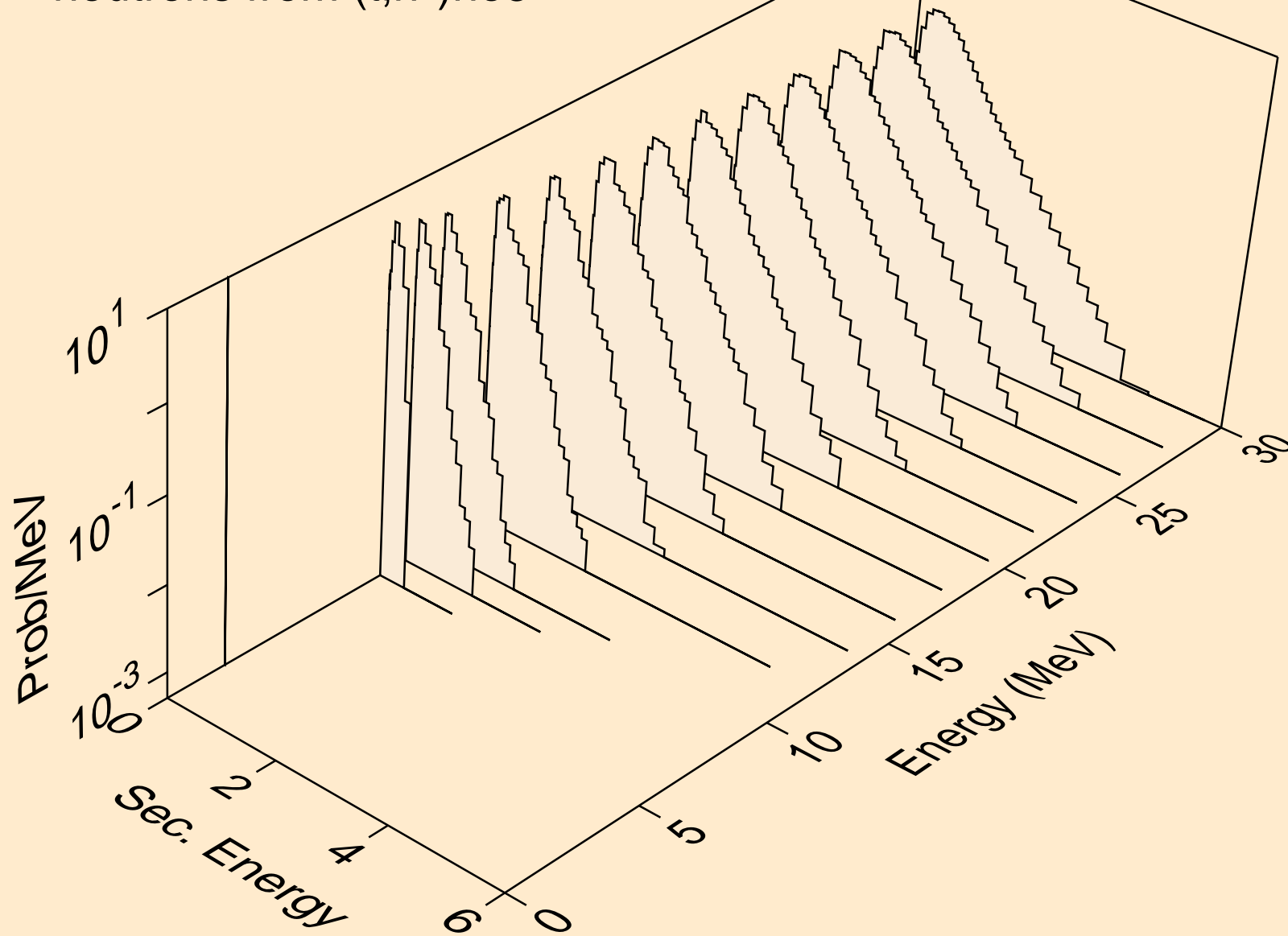

TA164 TRITON ACER TENDL-2021 LIBRARY; T=0.K  
neutrons from (t,4n)

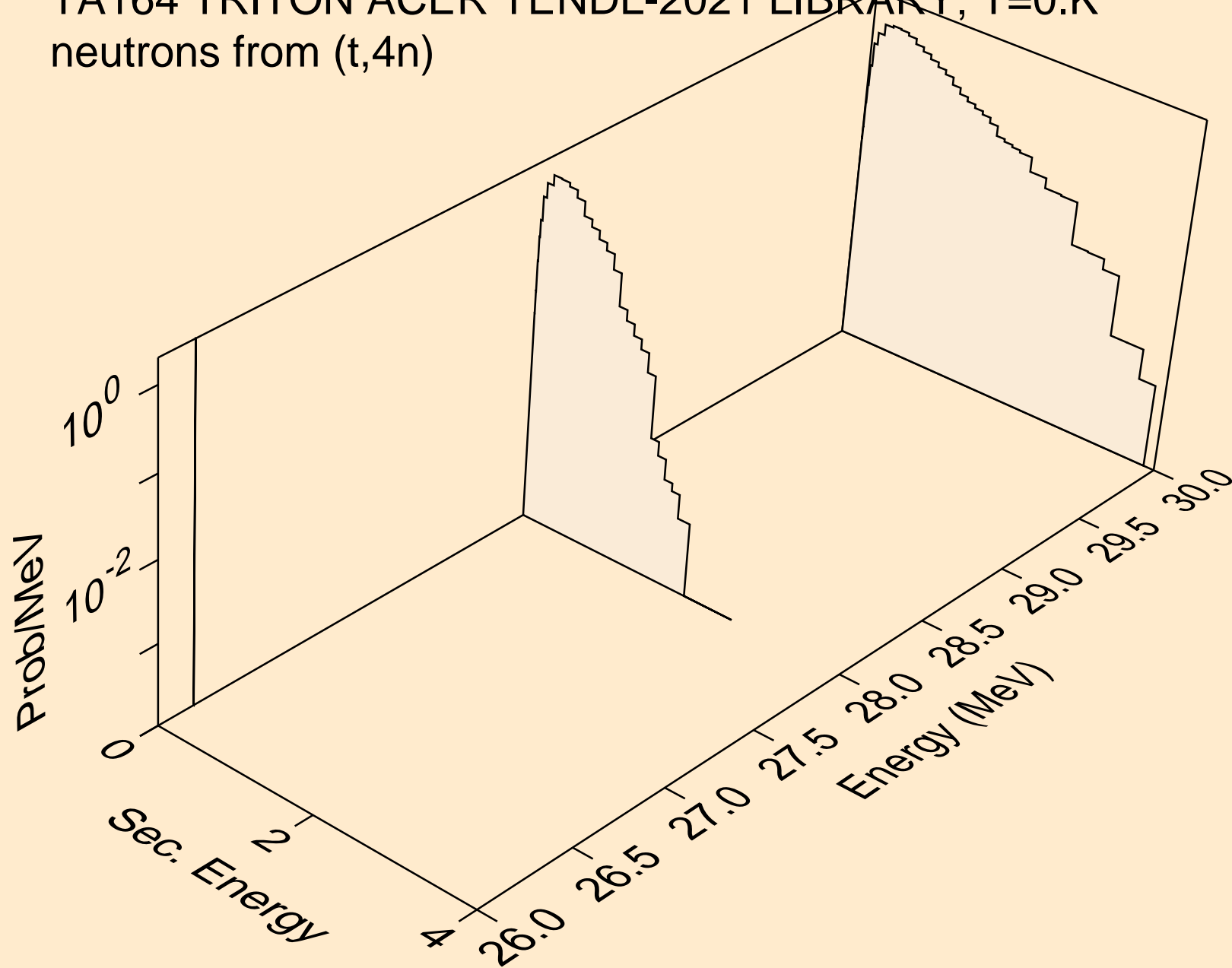

TA164 TRITON ACER TENDL-2021 LIBRARY; T=0.K  
neutrons from (t,2np)

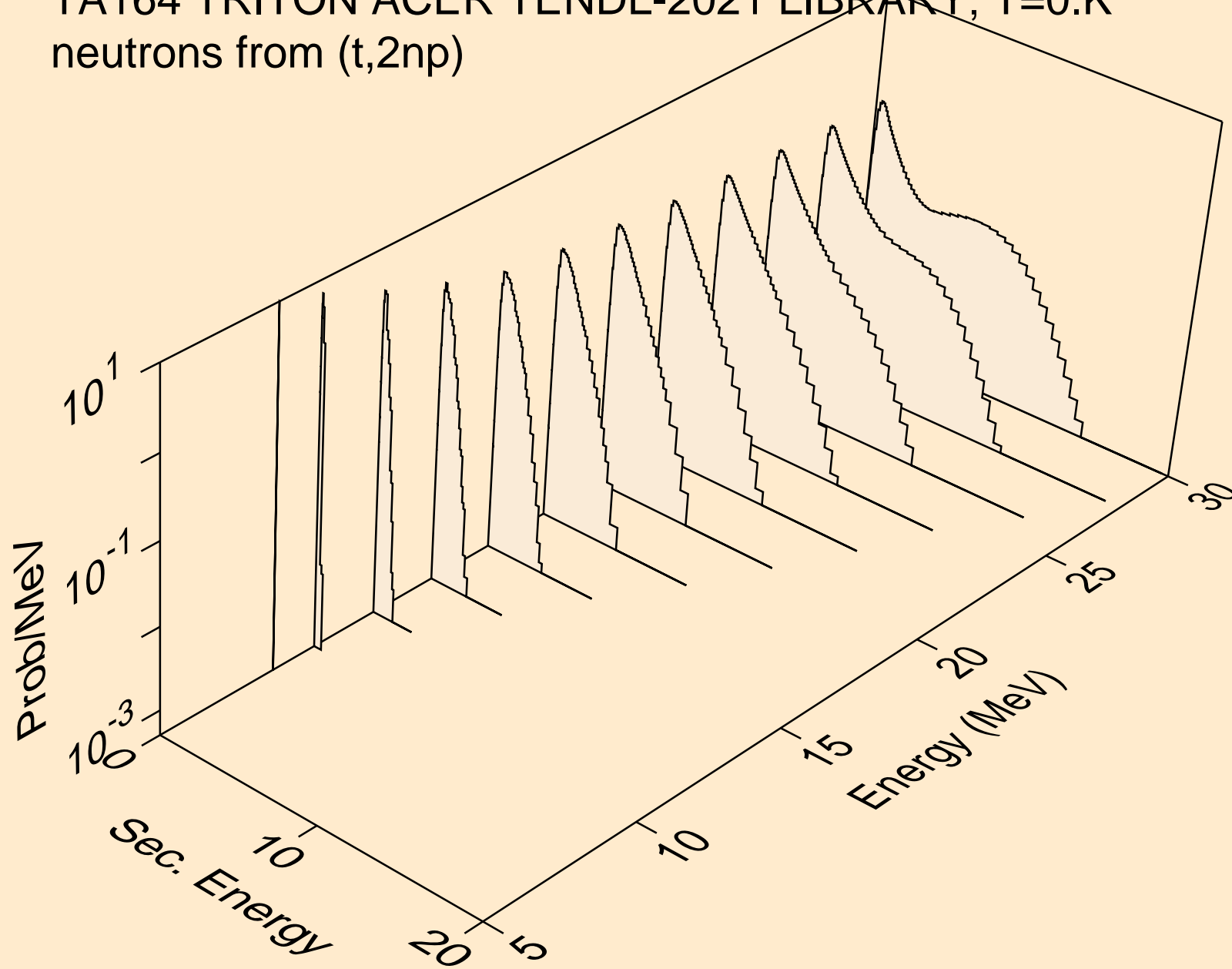

TA164 TRITON ACER TENDL-2021 LIBRARY; T=0.K  
neutrons from (t,3np)

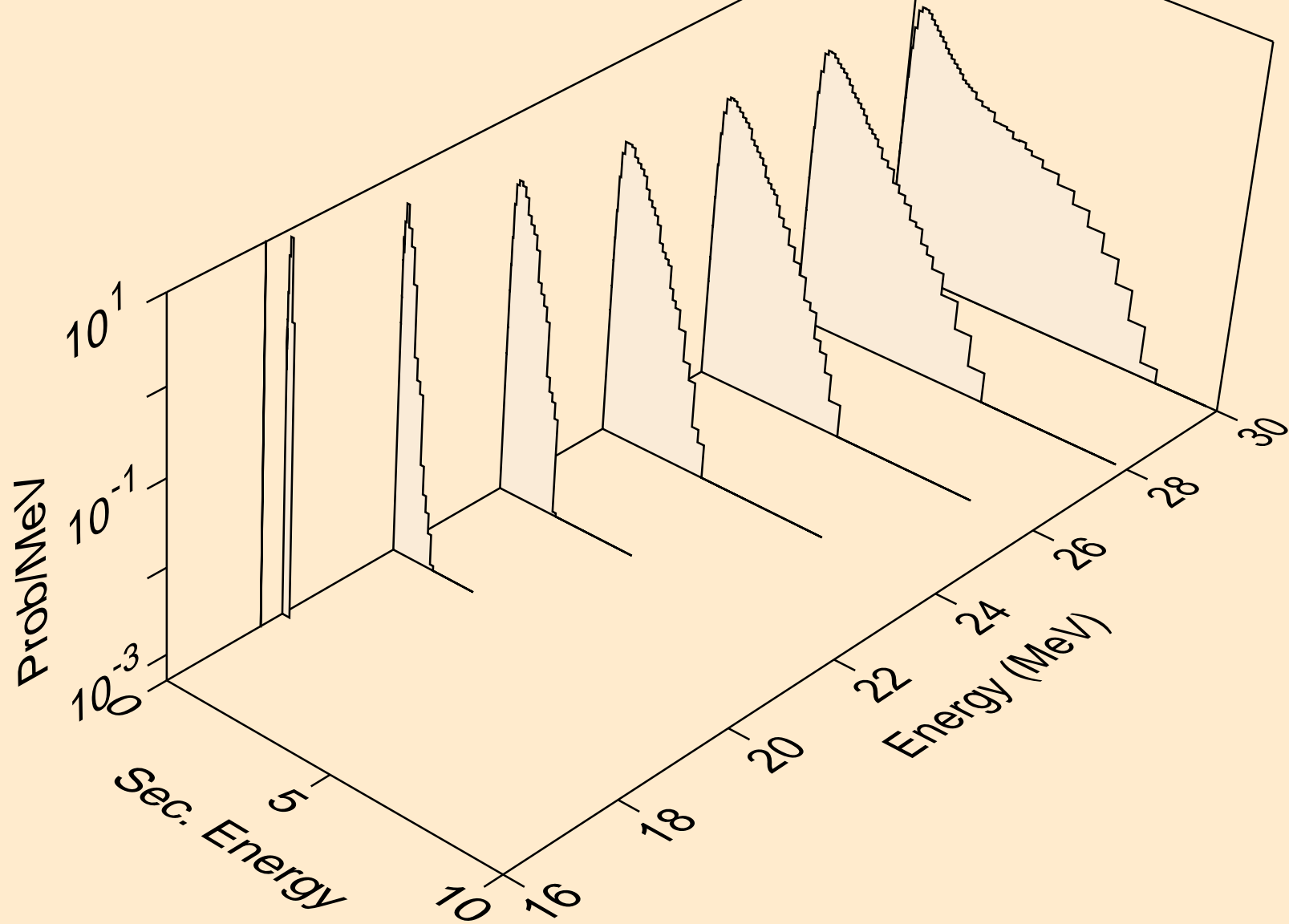

TA164 TRITON ACER TENDL-2021 LIBRARY; T=0.K  
neutrons from (t,2np)

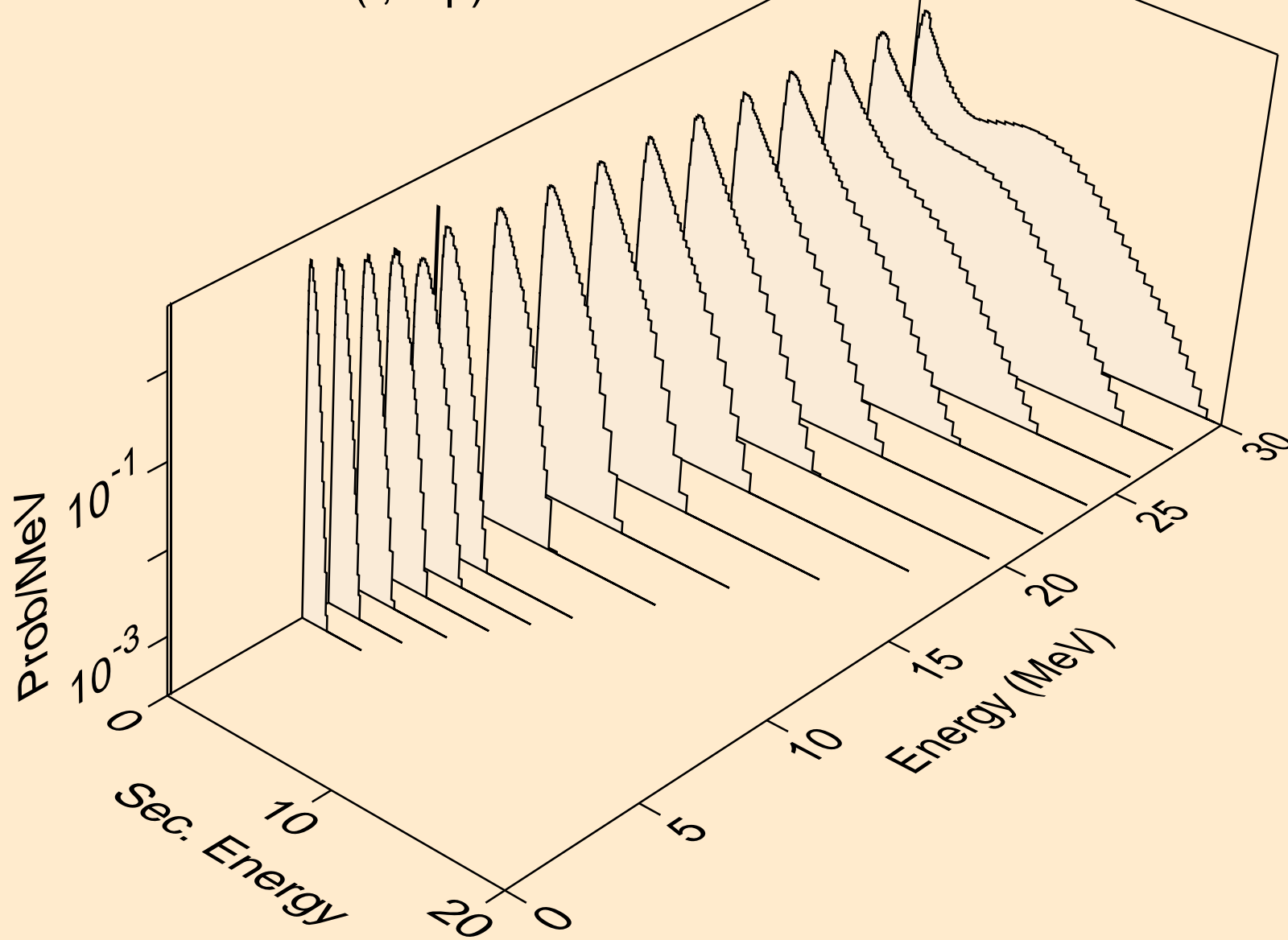

TA164 TRITON ACER TENDL-2021 LIBRARY; T=0.K  
neutrons from (t,npa)

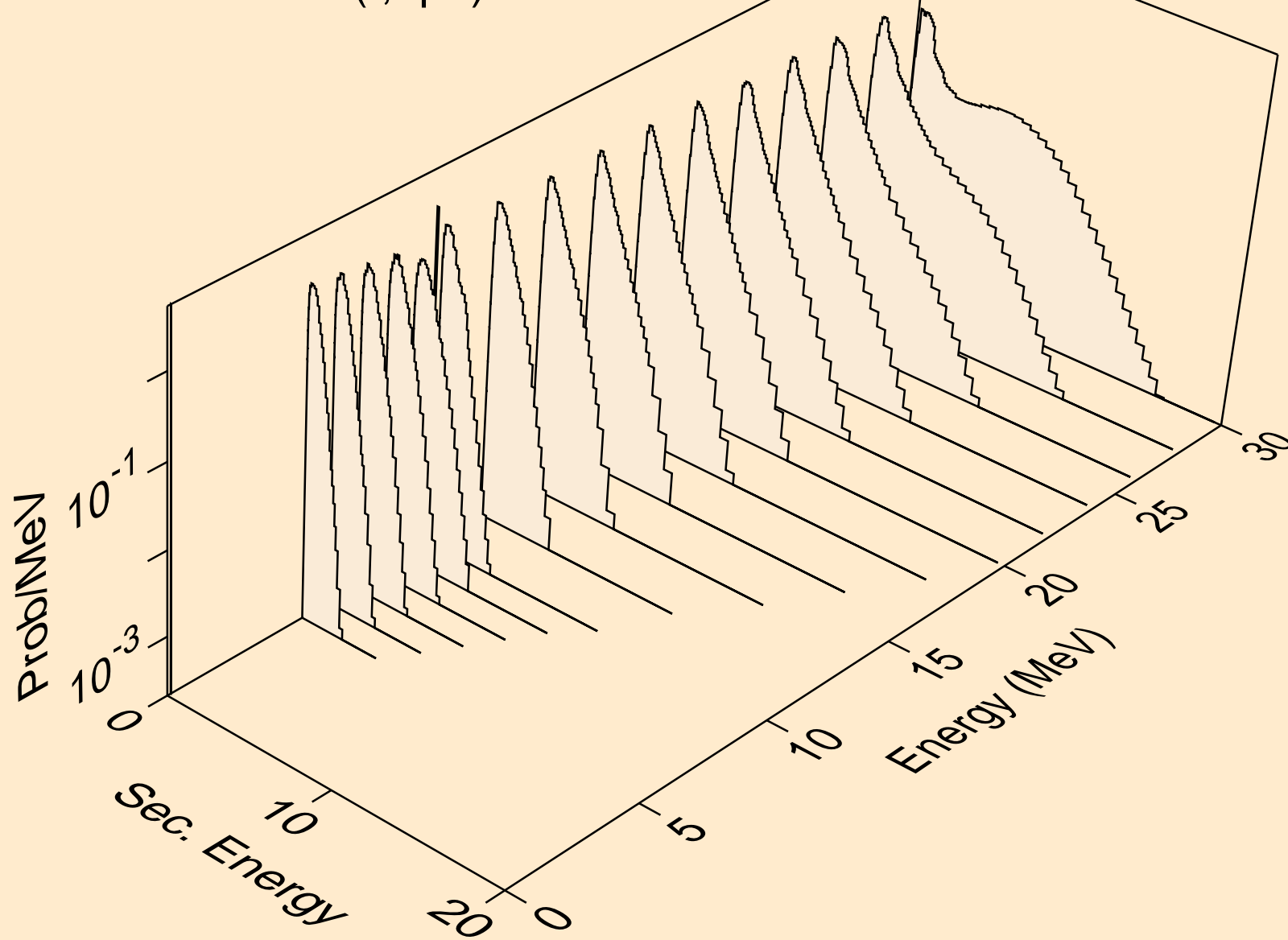

TA164 TRITON ACER TENDL-2021 LIBRARY; T=0.K  
protons from (t,x)

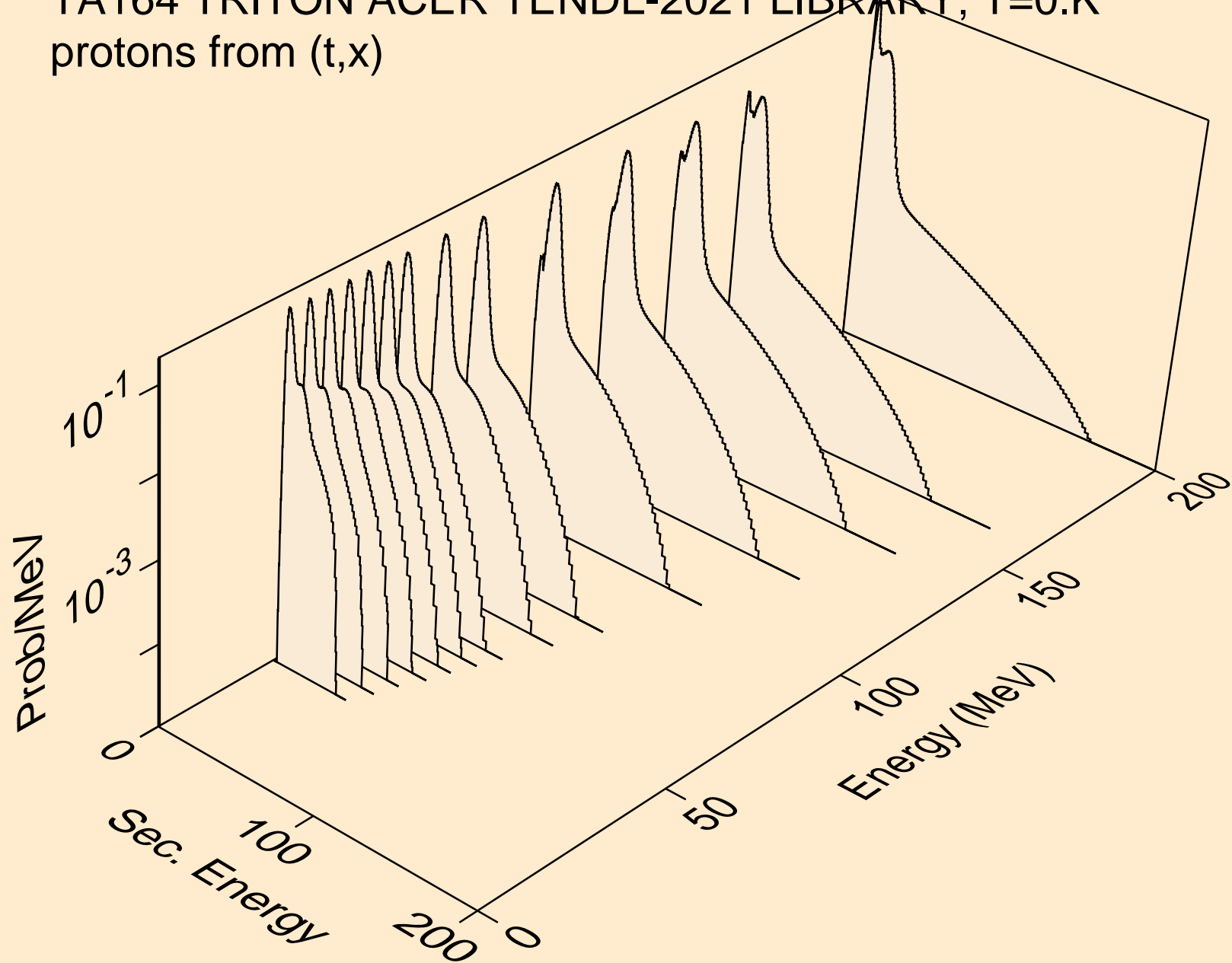



TA164 TRITON ACER TENDL-2021 LIBRARY; T=0.K  
protons from (t,n\*)p

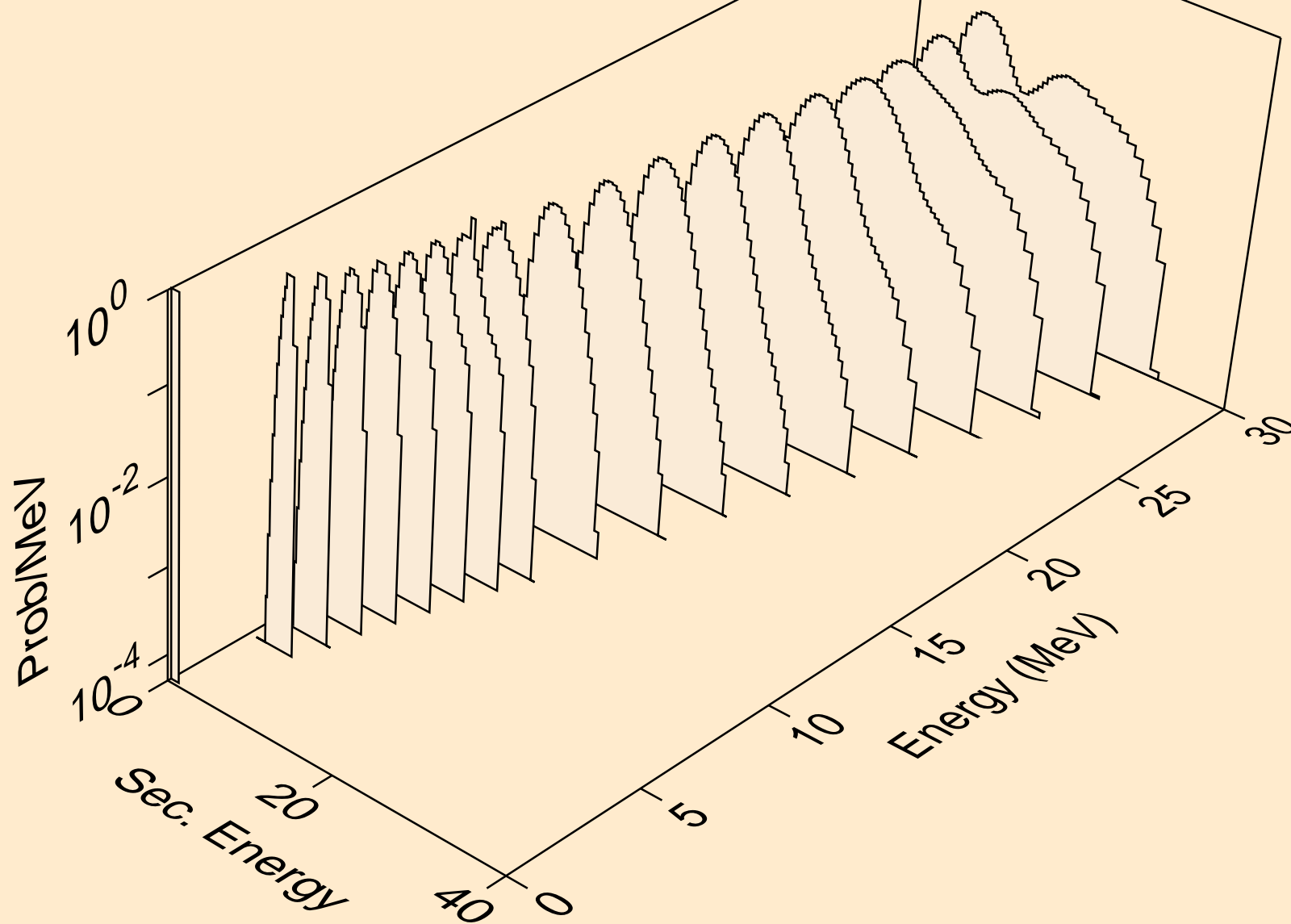

TA164 TRITON ACER TENDL-2021 LIBRARY; T=0.K  
protons from (t,2np)

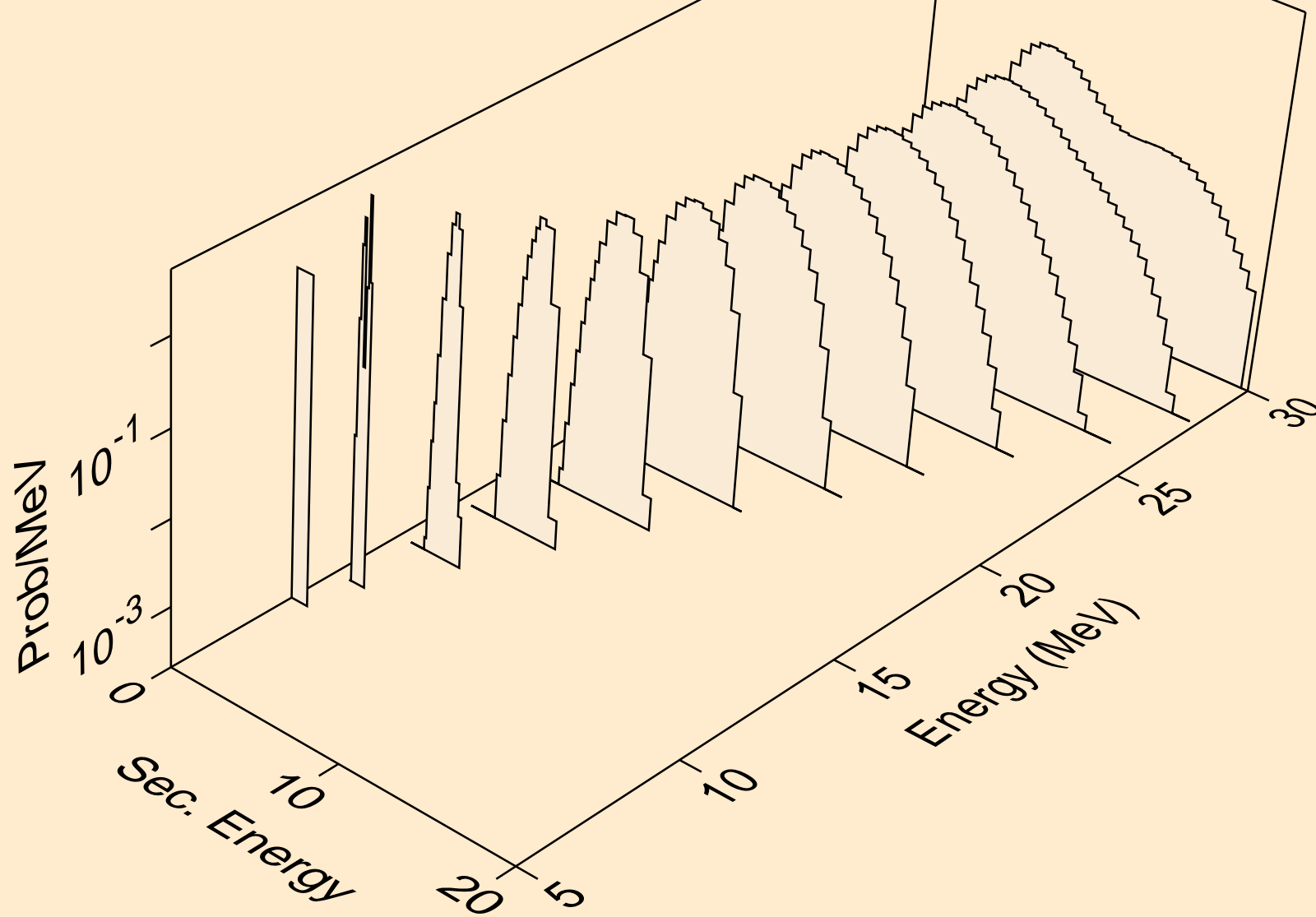

TA164 TRITON ACER TENDL-2021 LIBRARY; T=0.K  
protons from (t,3np)

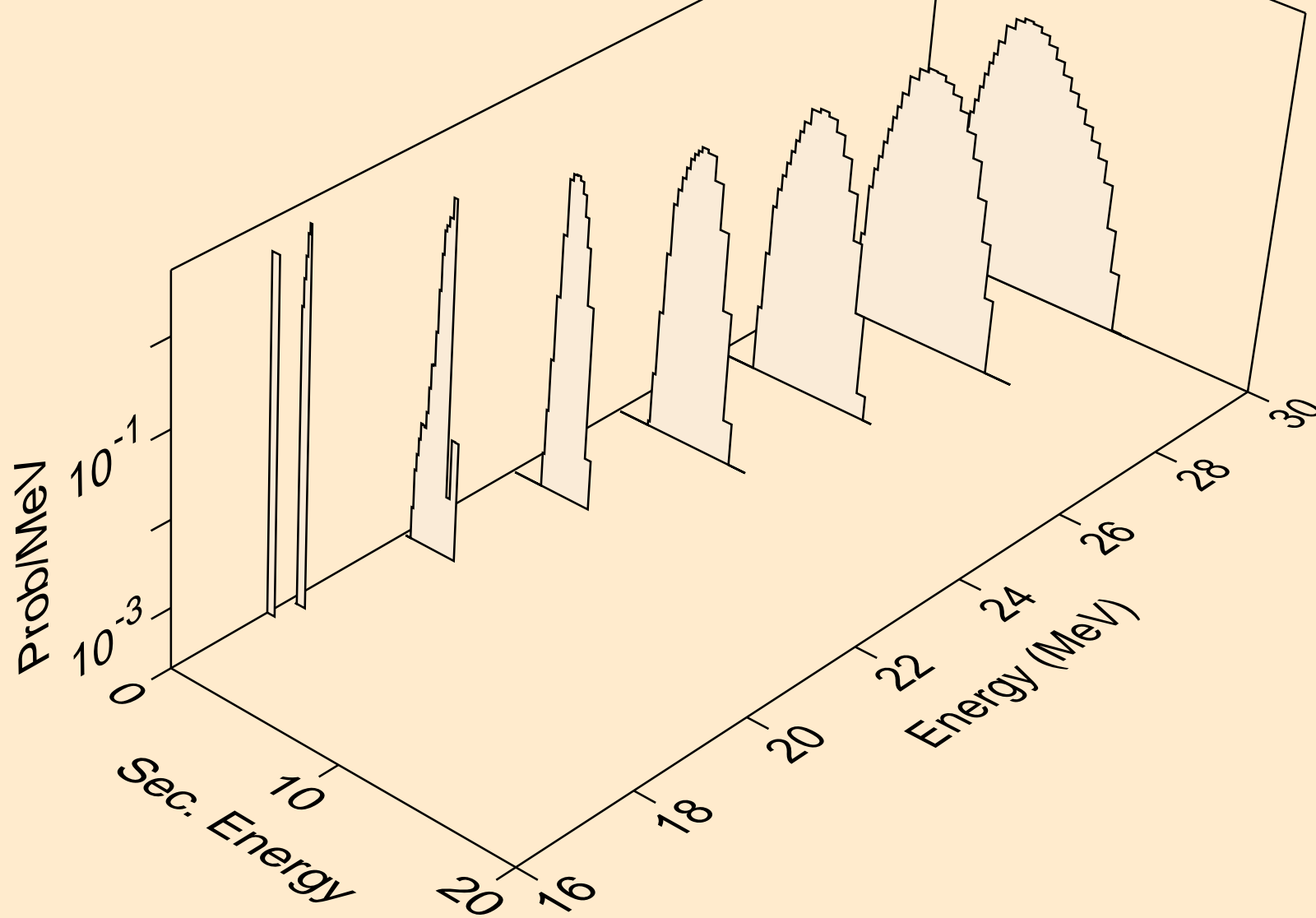

TA164 TRITON ACER TENDL-2021 LIBRARY; T=0.K  
protons from (t,2np)

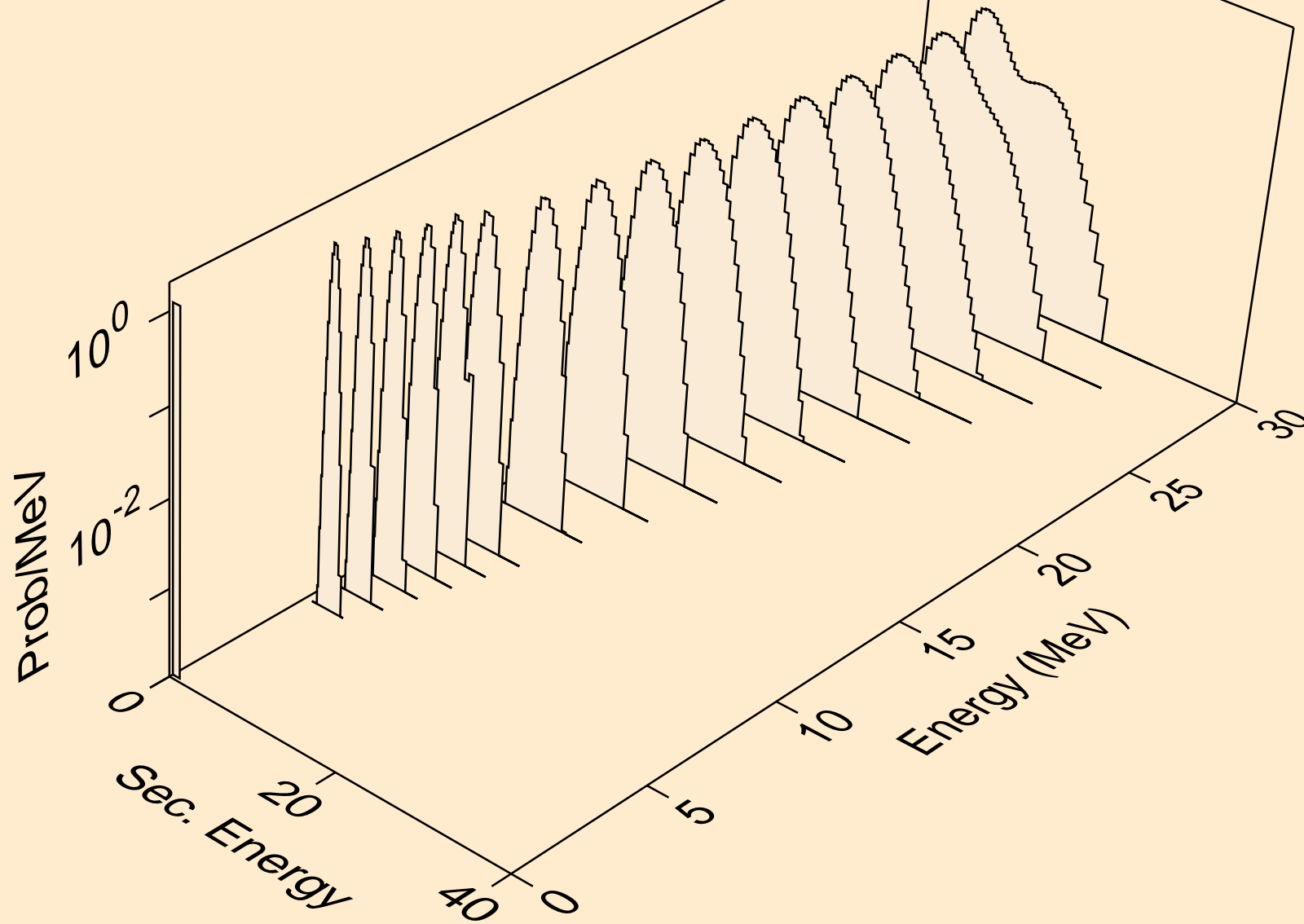

TA164 TRITON ACER TENDL-2021 LIBRARY; T=0.K  
protons from (t,npa)

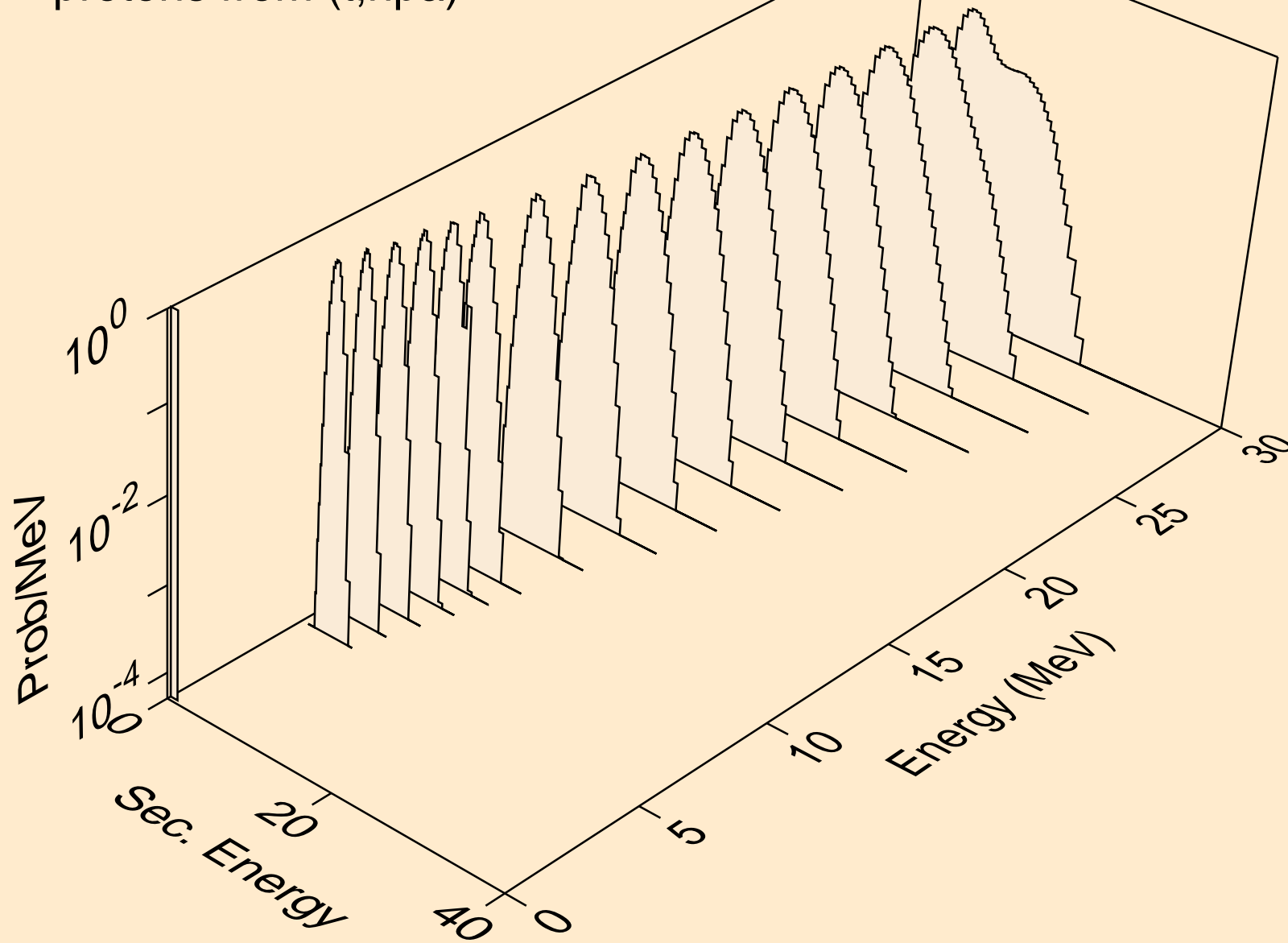

TA164 TRITON ACER TENDL-2021 LIBRARY; T=0.K  
protons from (t,p)

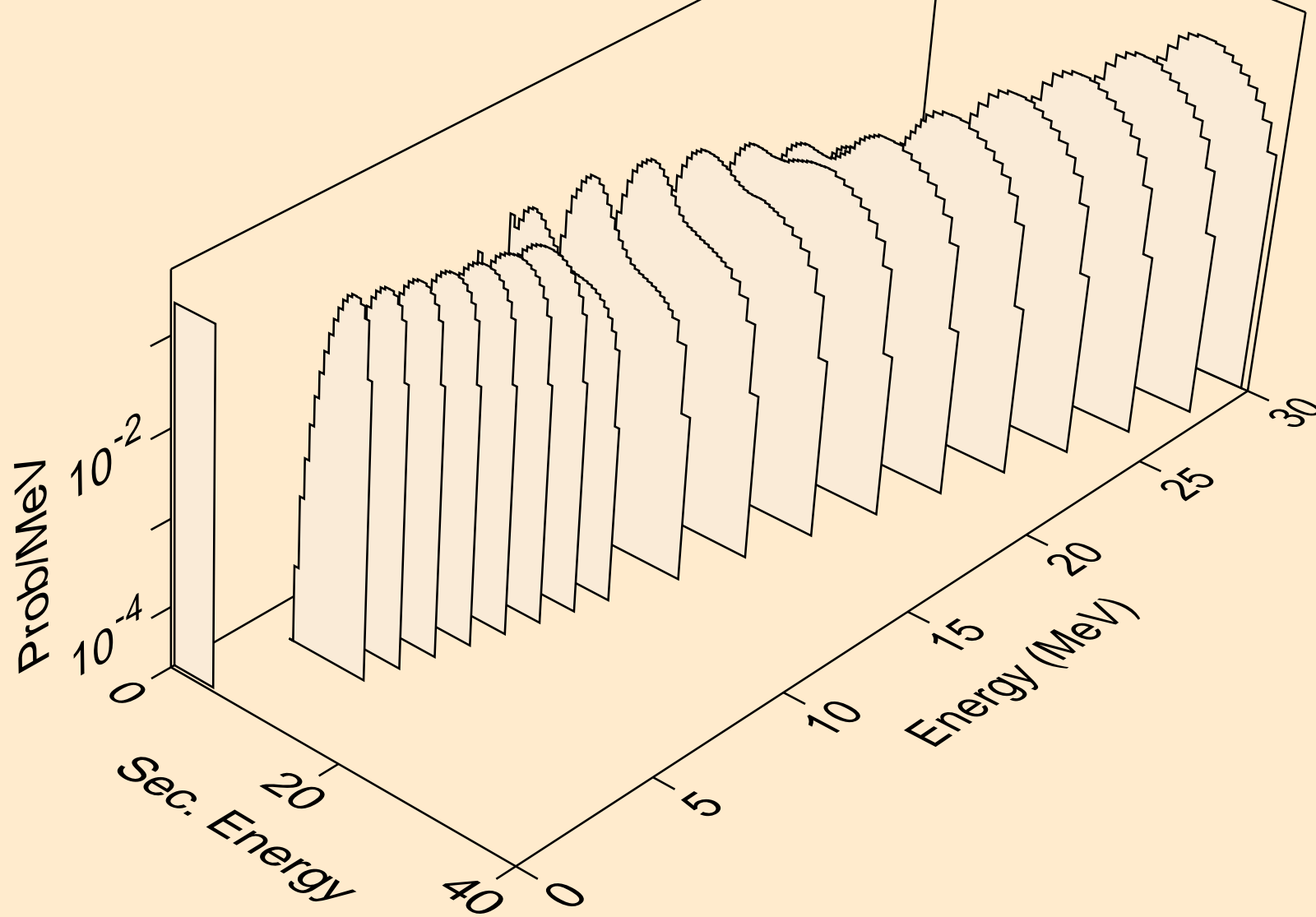

TA164 TRITON ACER TENDL-2021 LIBRARY; T=0.K  
protons from (t,2p)

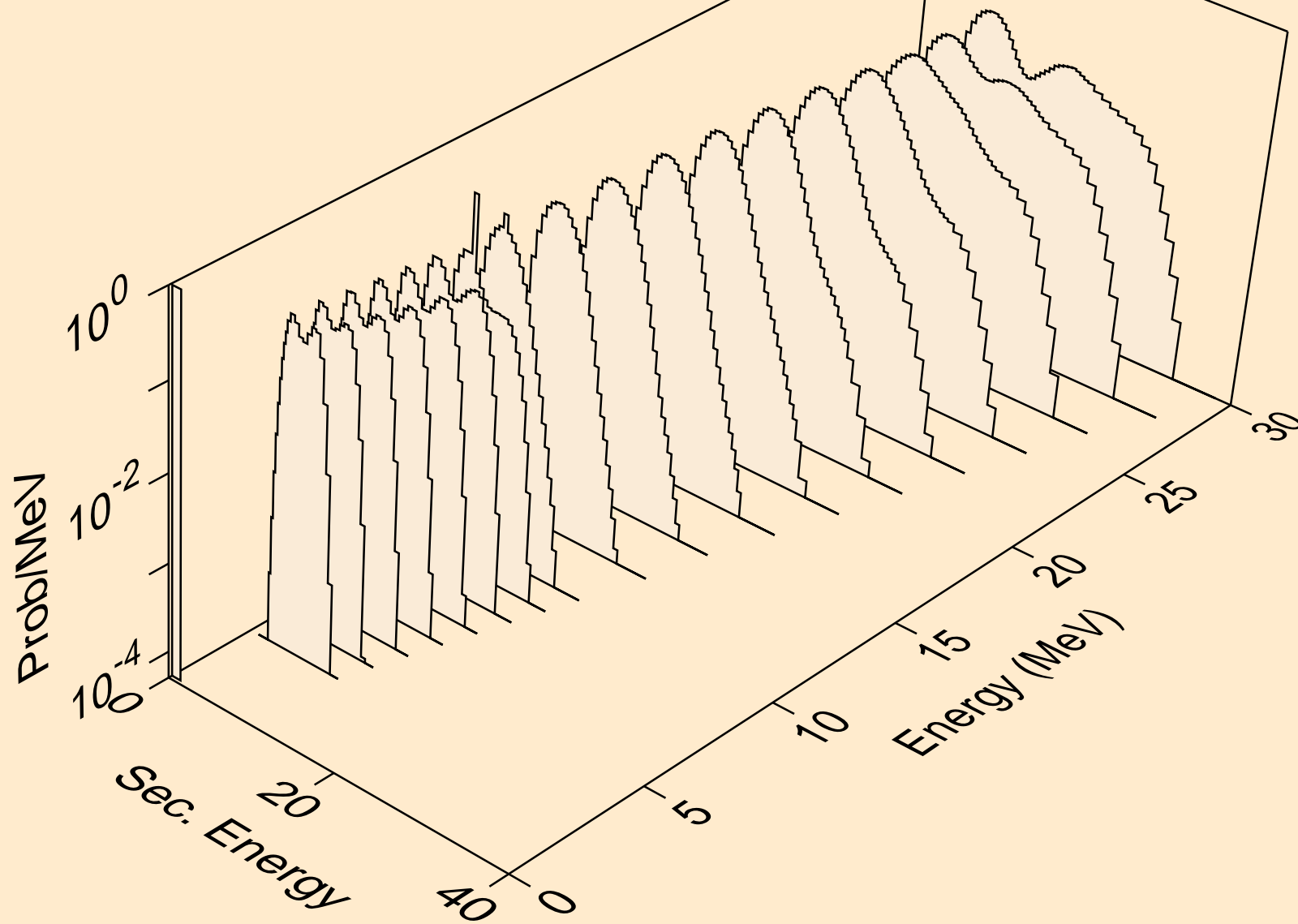

TA164 TRITON ACER TENDL-2021 LIBRARY; T=0.K  
protons from (t,pa)

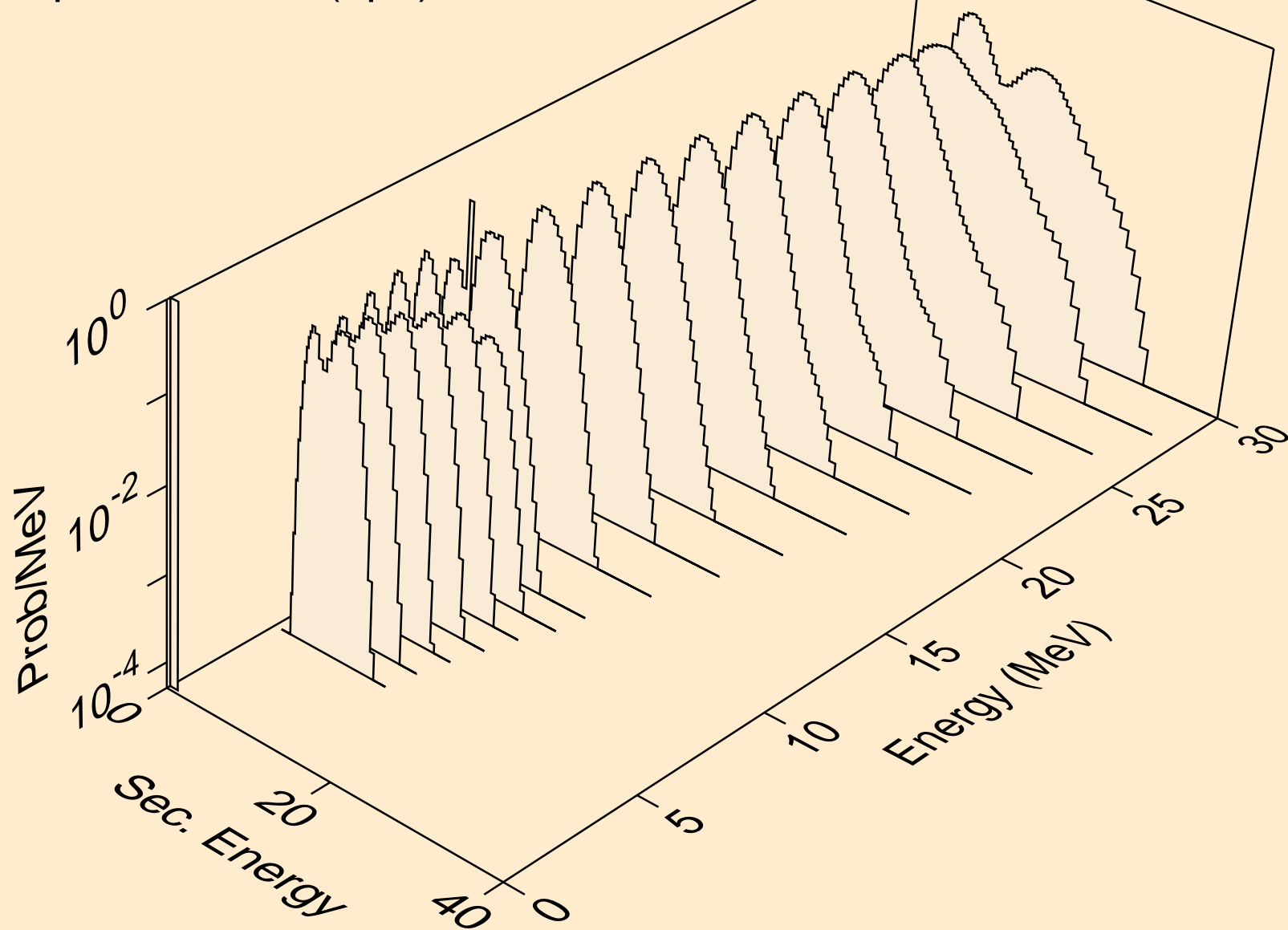



TA164 TRITON ACER TENDL-2021 LIBRARY; T=0.K  
protons from (t,pd)

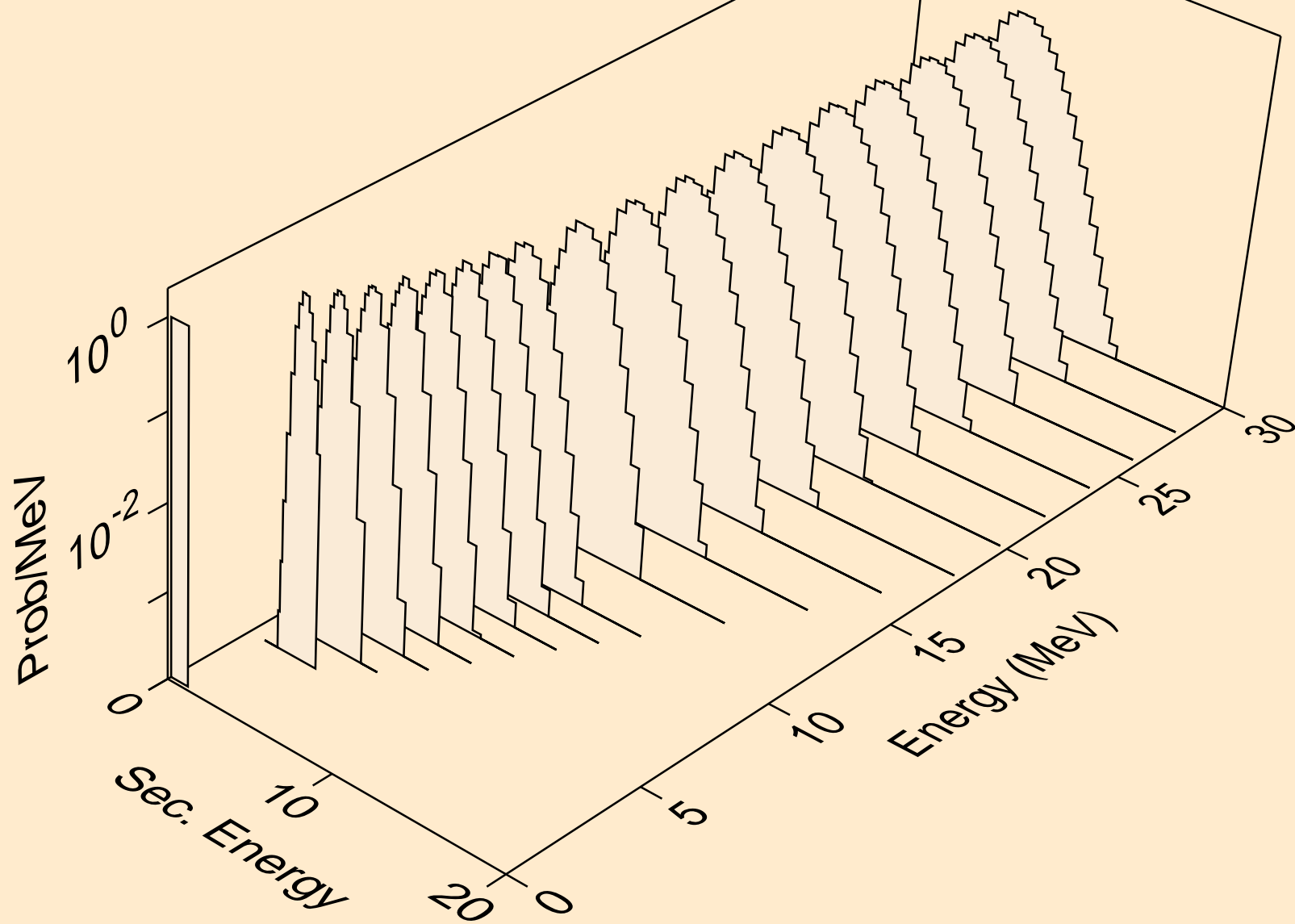

TA164 TRITON ACER TENDL-2021 LIBRARY; T=0.K  
protons from (t,pt)

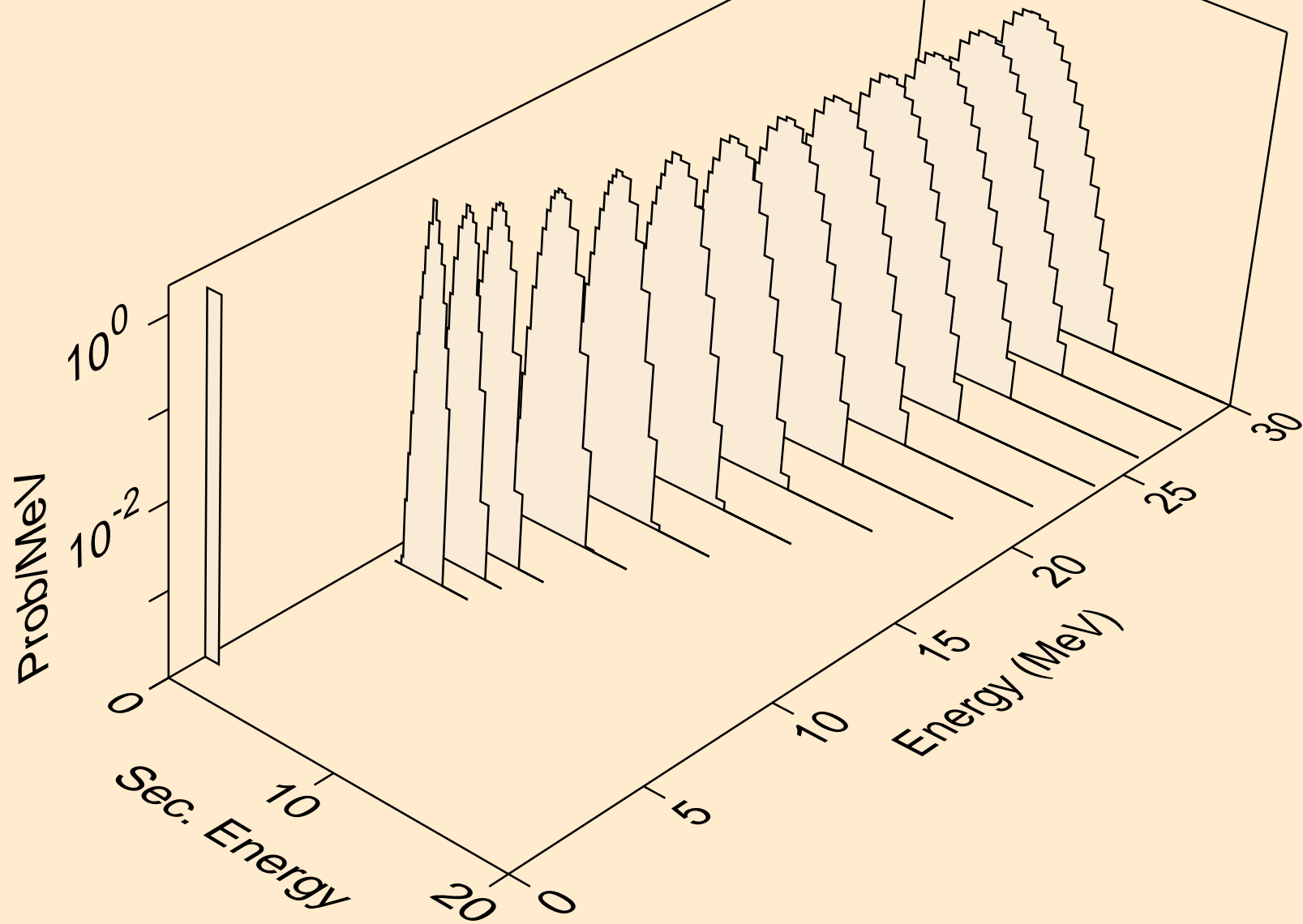

TA164 TRITON ACER TENDL-2021 LIBRARY; T=0.K  
deuterons from (t,x)

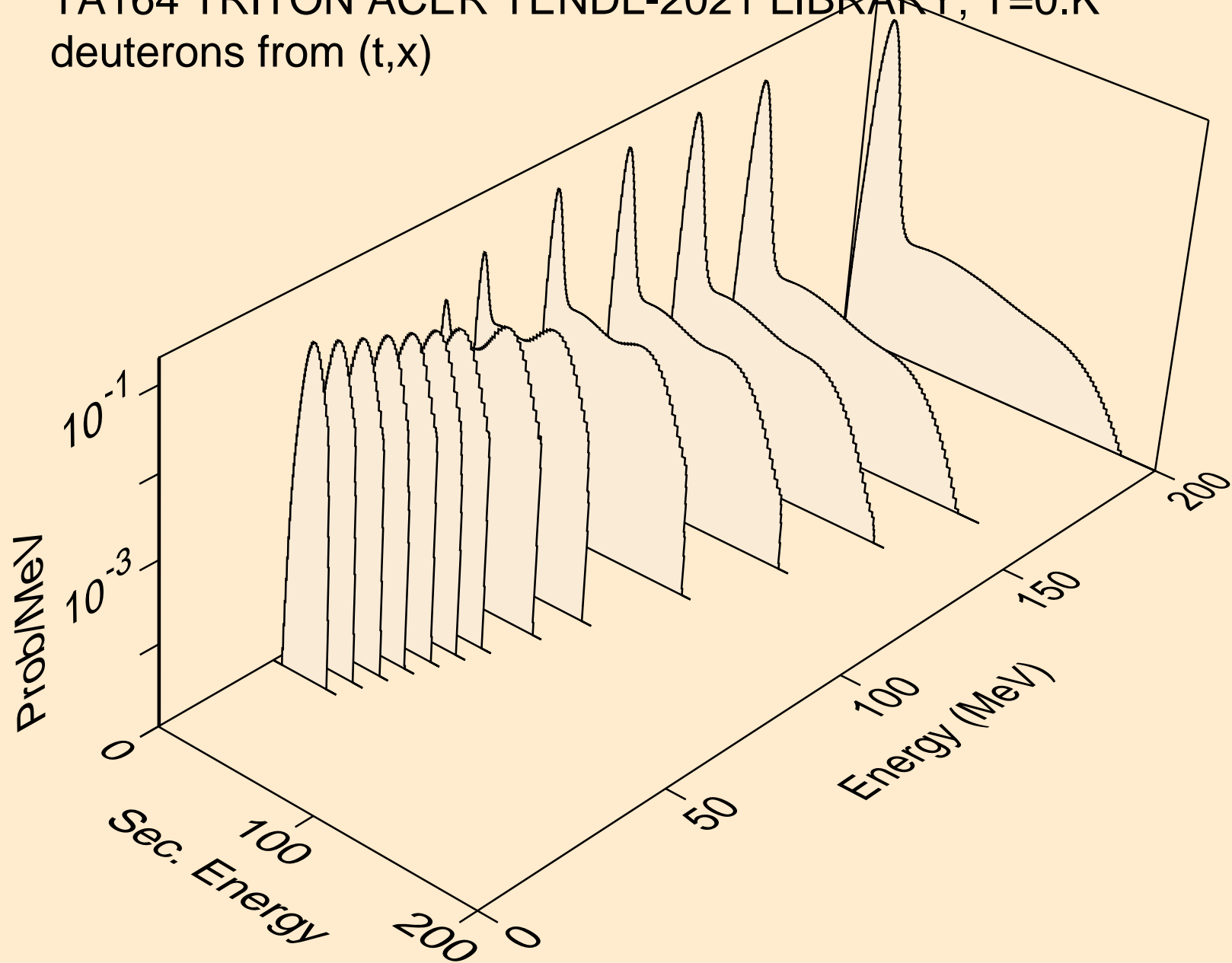

TA164 TRITON ACER TENDL-2021 LIBRARY; T=0.K  
deuterons from (t,2nd)

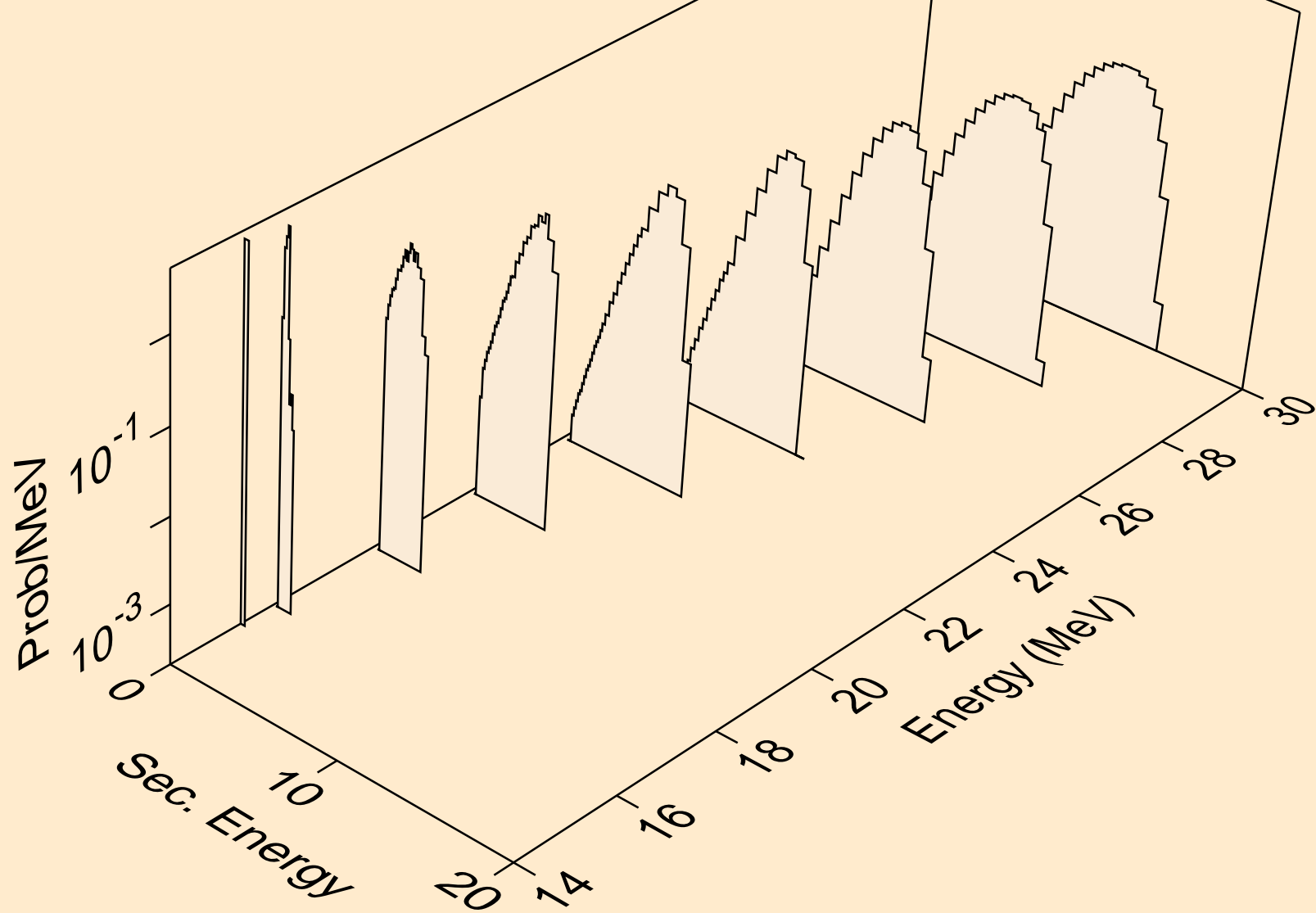

TA164 TRITON ACER TENDL-2021 LIBRARY; T=0.K  
deuterons from (t,n\*)d

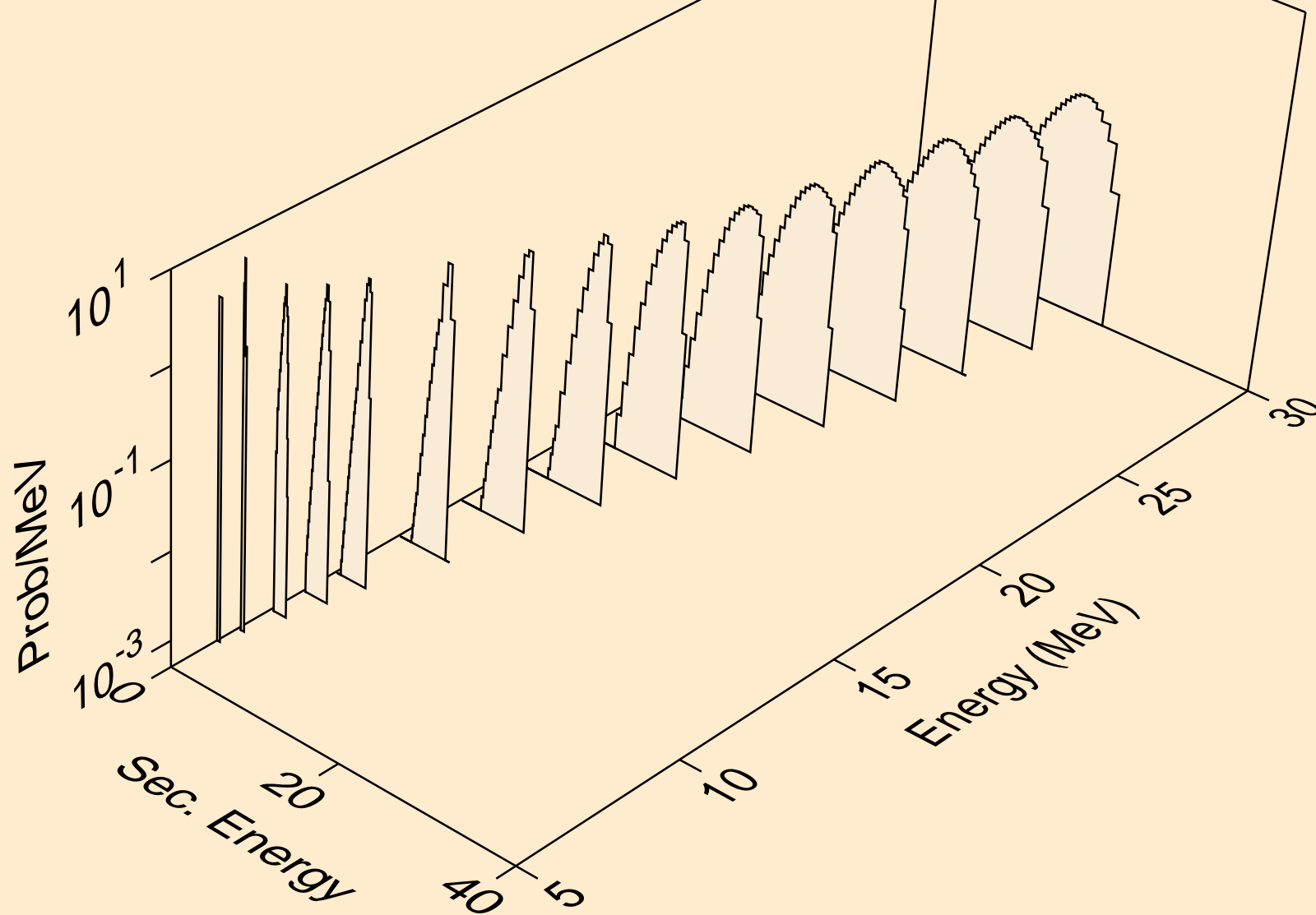

TA164 TRITON ACER TENDL-2021 LIBRARY; T=0.K  
deuterons from (t,d)

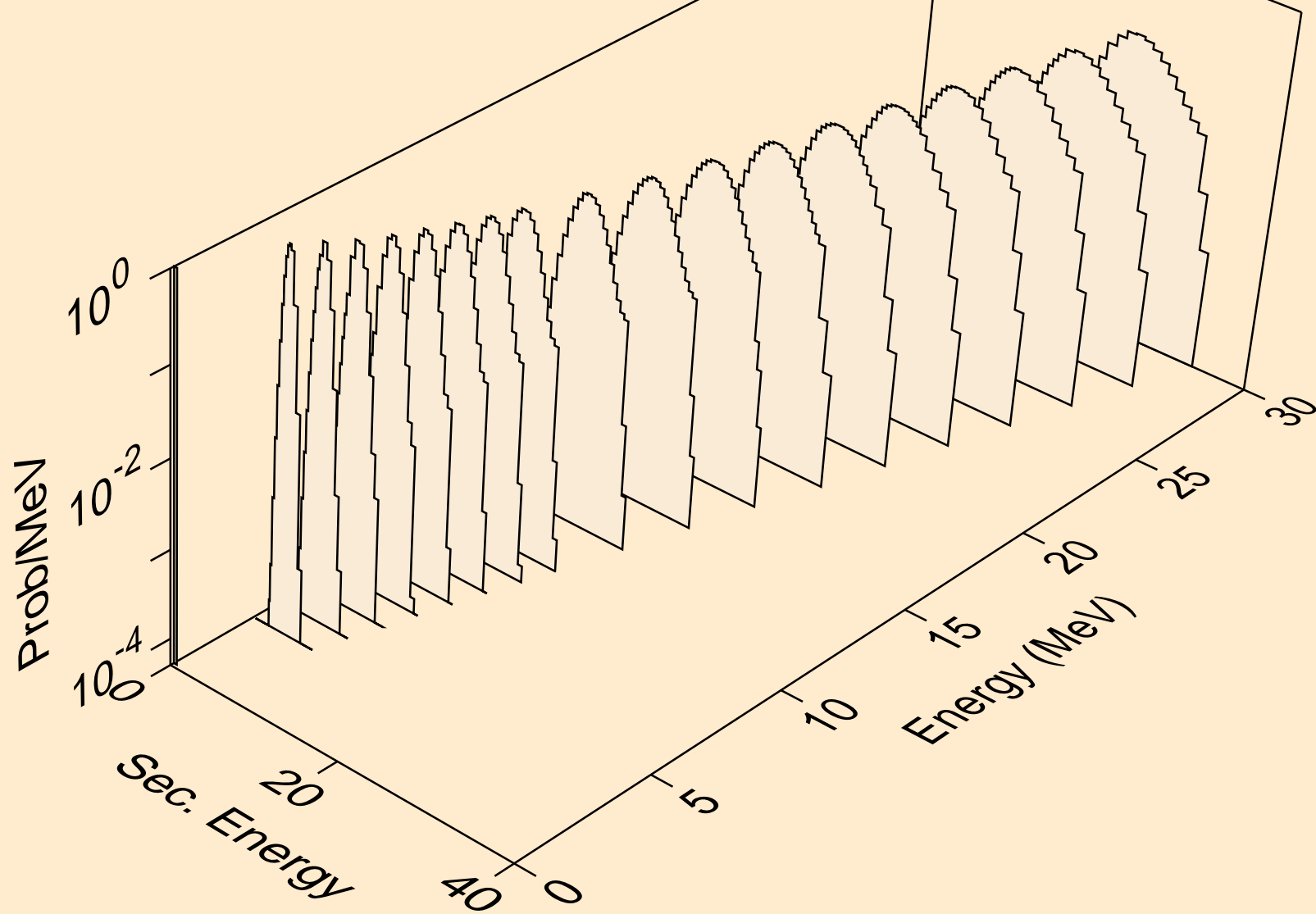

TA164 TRITON ACER TENDL-2021 LIBRARY; T=0.K  
deuterons from (t,d2a)

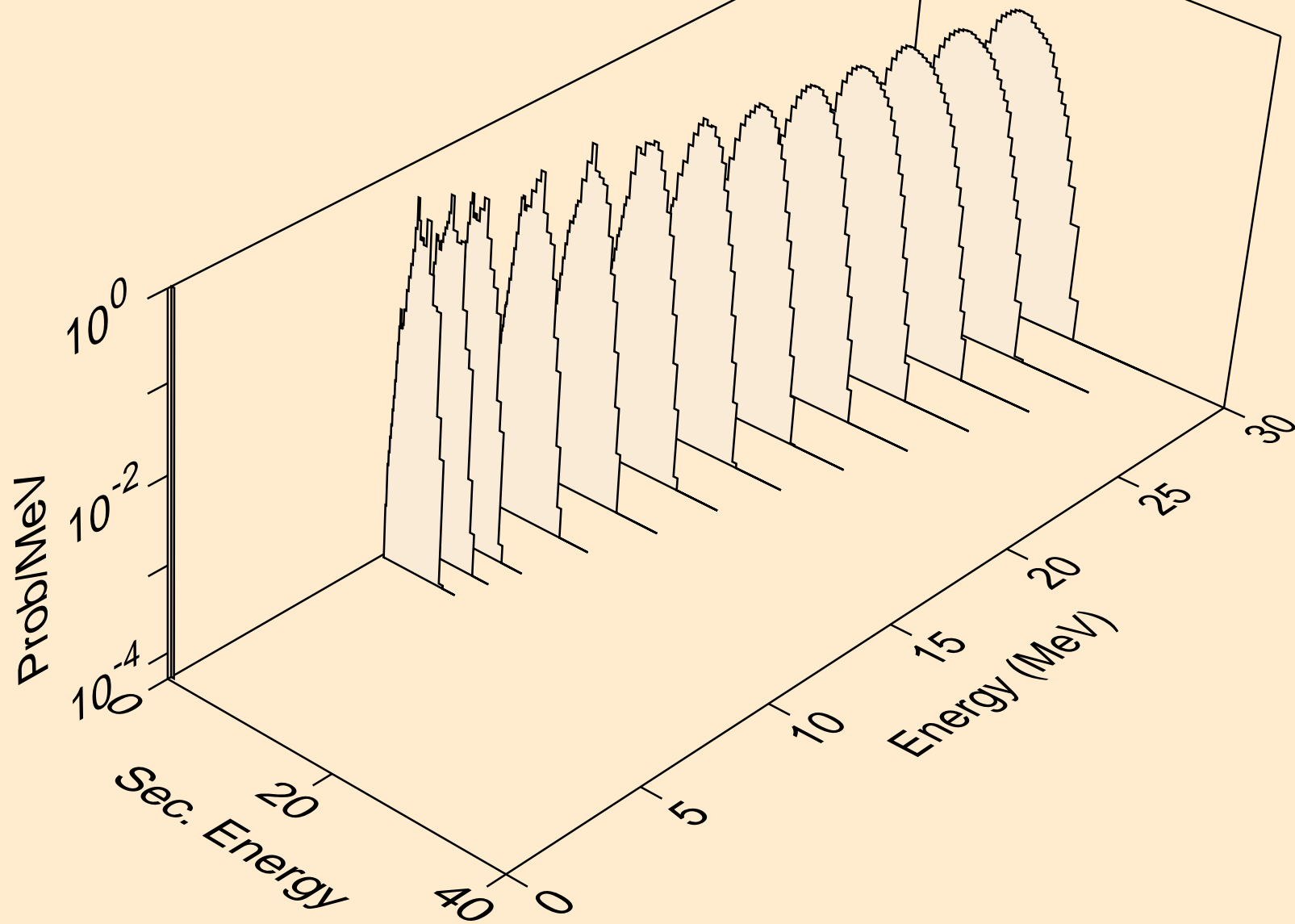

TA164 TRITON ACER TENDL-2021 LIBRARY; T=0.K  
deuterons from (t,pd)

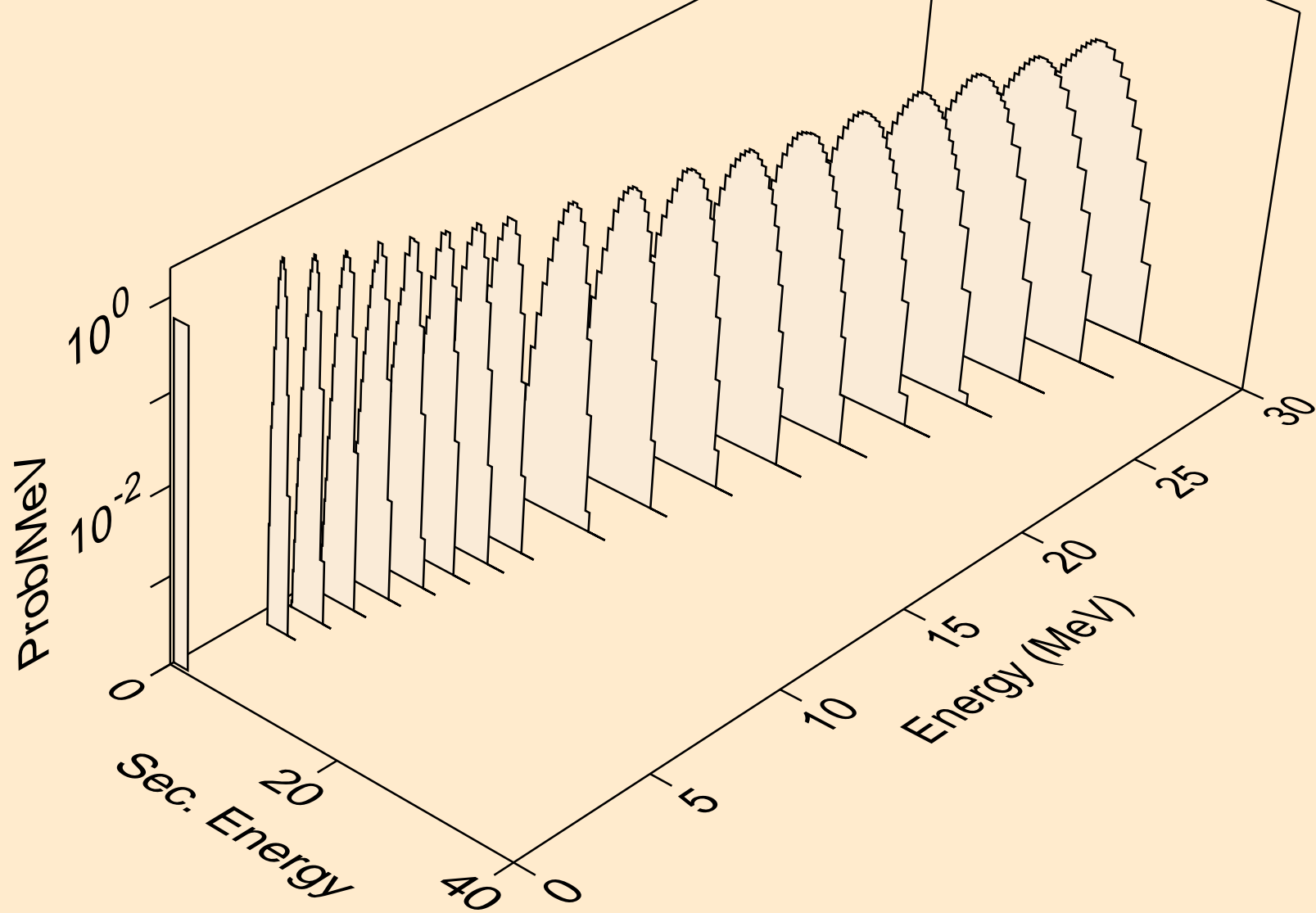



TA164 TRITON ACER TENDL-2021 LIBRARY; T=0.K  
deuterons from (t,da)

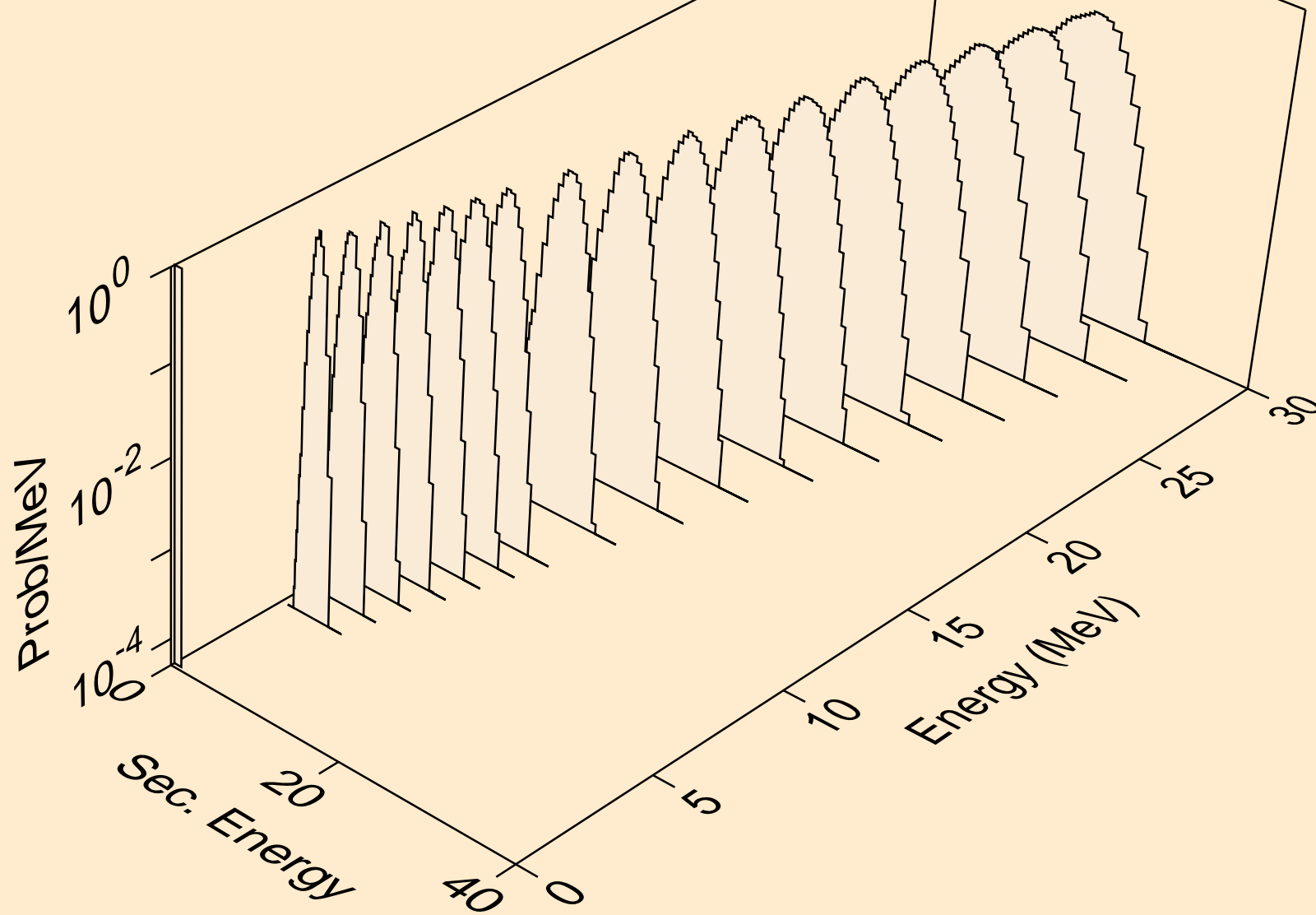

TA164 TRITON ACER TENDL-2021 LIBRARY; T=0.K  
he3s from (t,x)

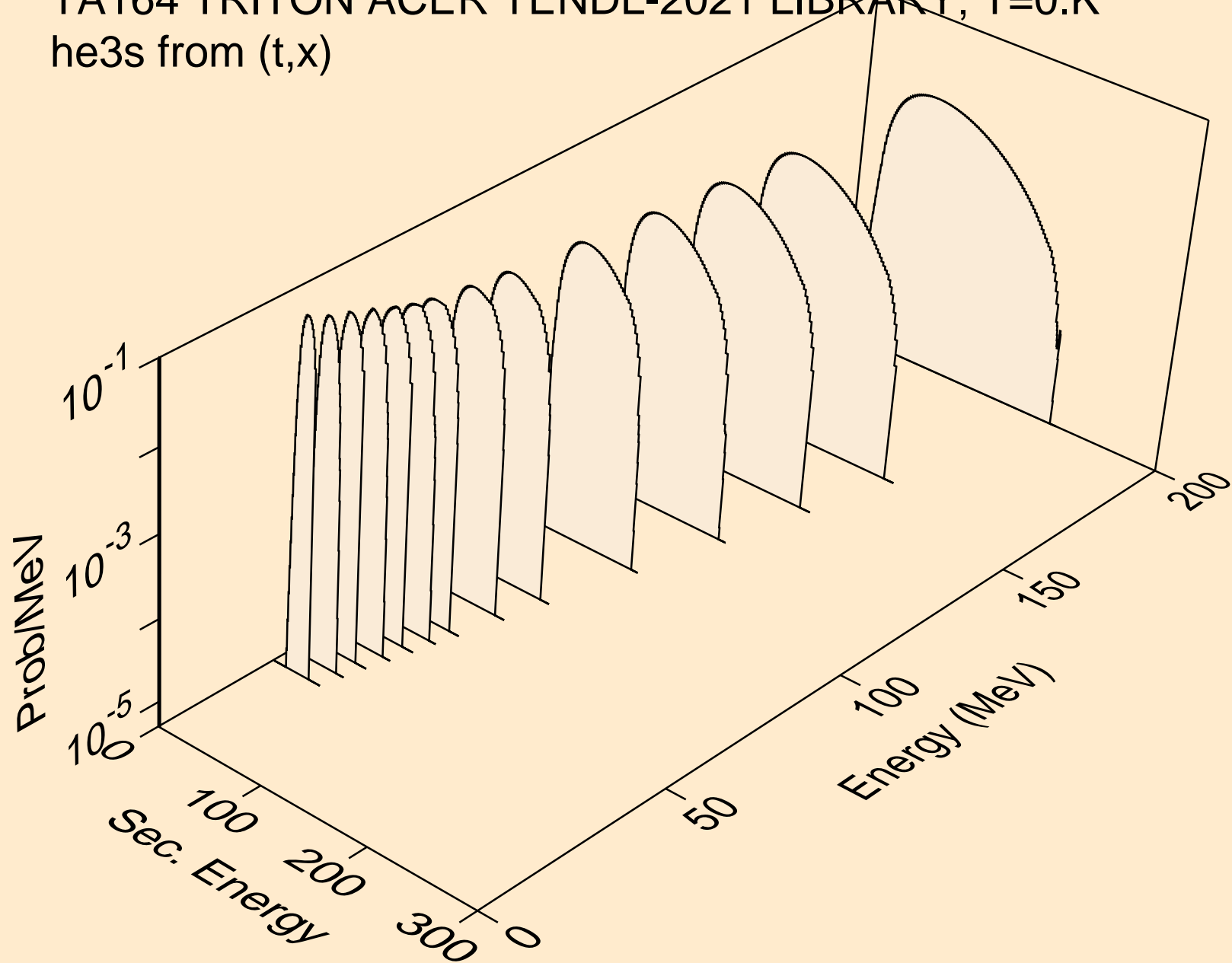

TA164 TRITON ACER TENDL-2021 LIBRARY; T=0.K  
he3s from (t,n\*)he3

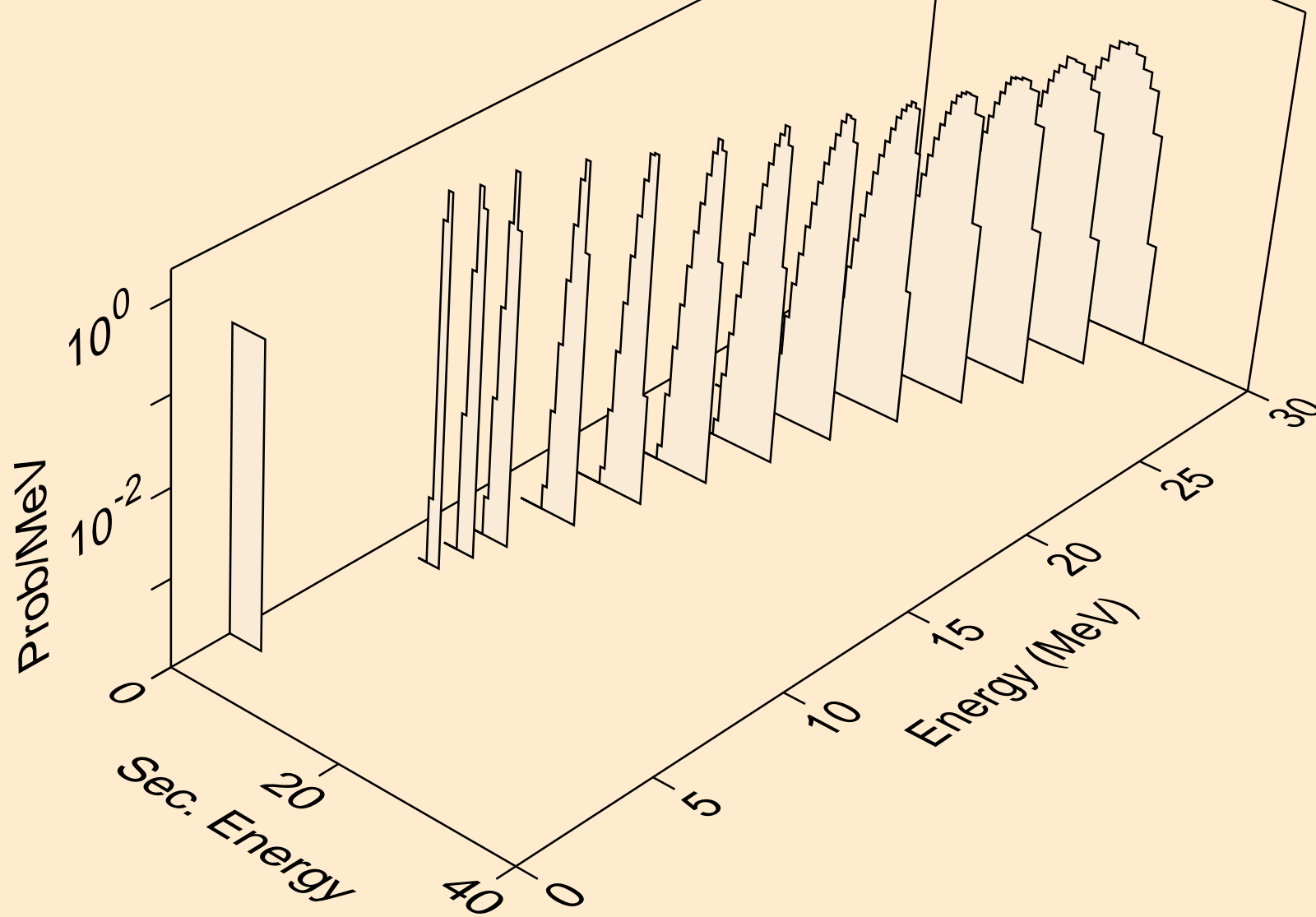

TA164 TRITON ACER TENDL-2021 LIBRARY; T=0.K  
he3s from (t,he3)

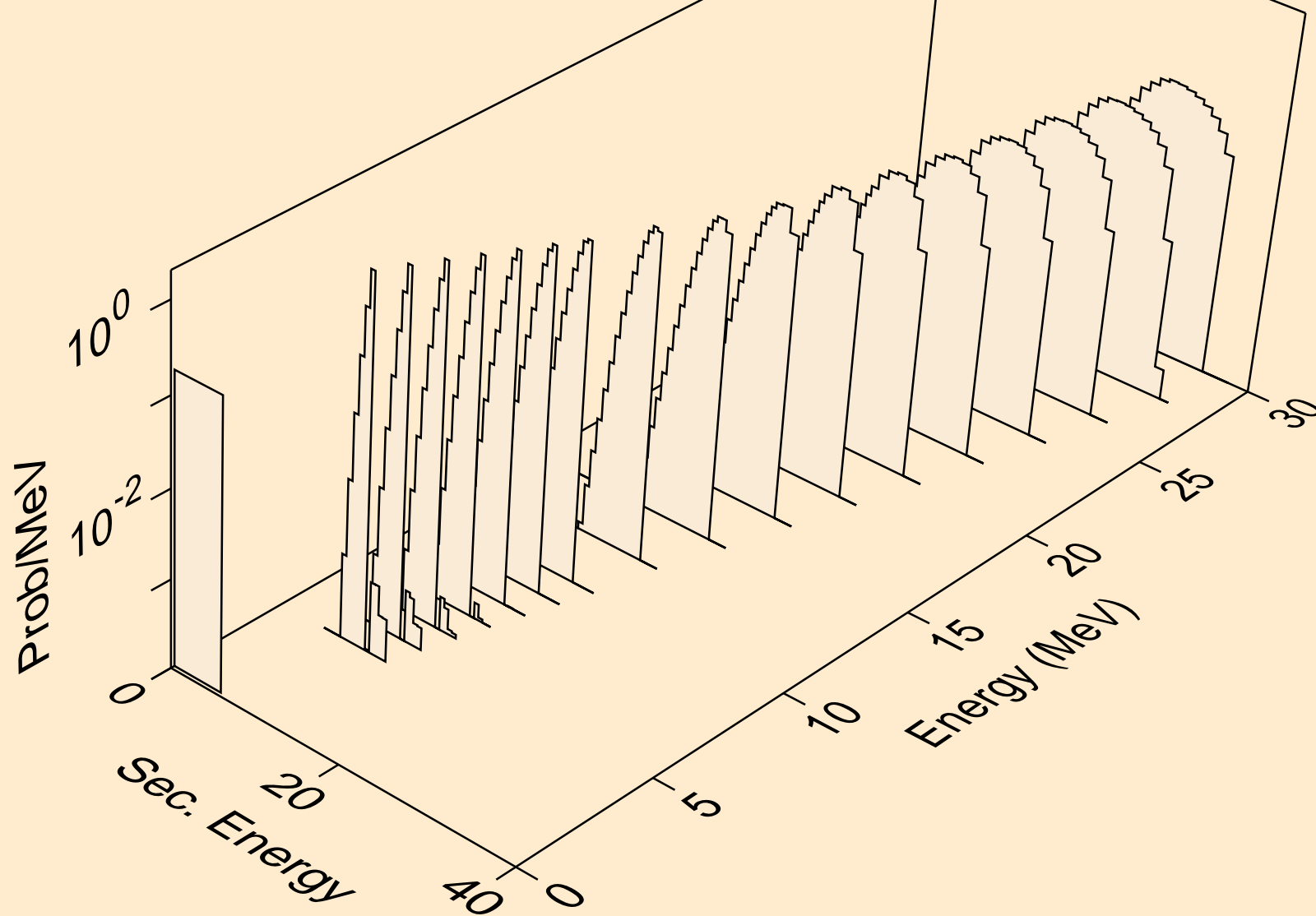

TA164 TRITON ACER TENDL-2021 LIBRARY; T=0.K  
alphas from (t,x)

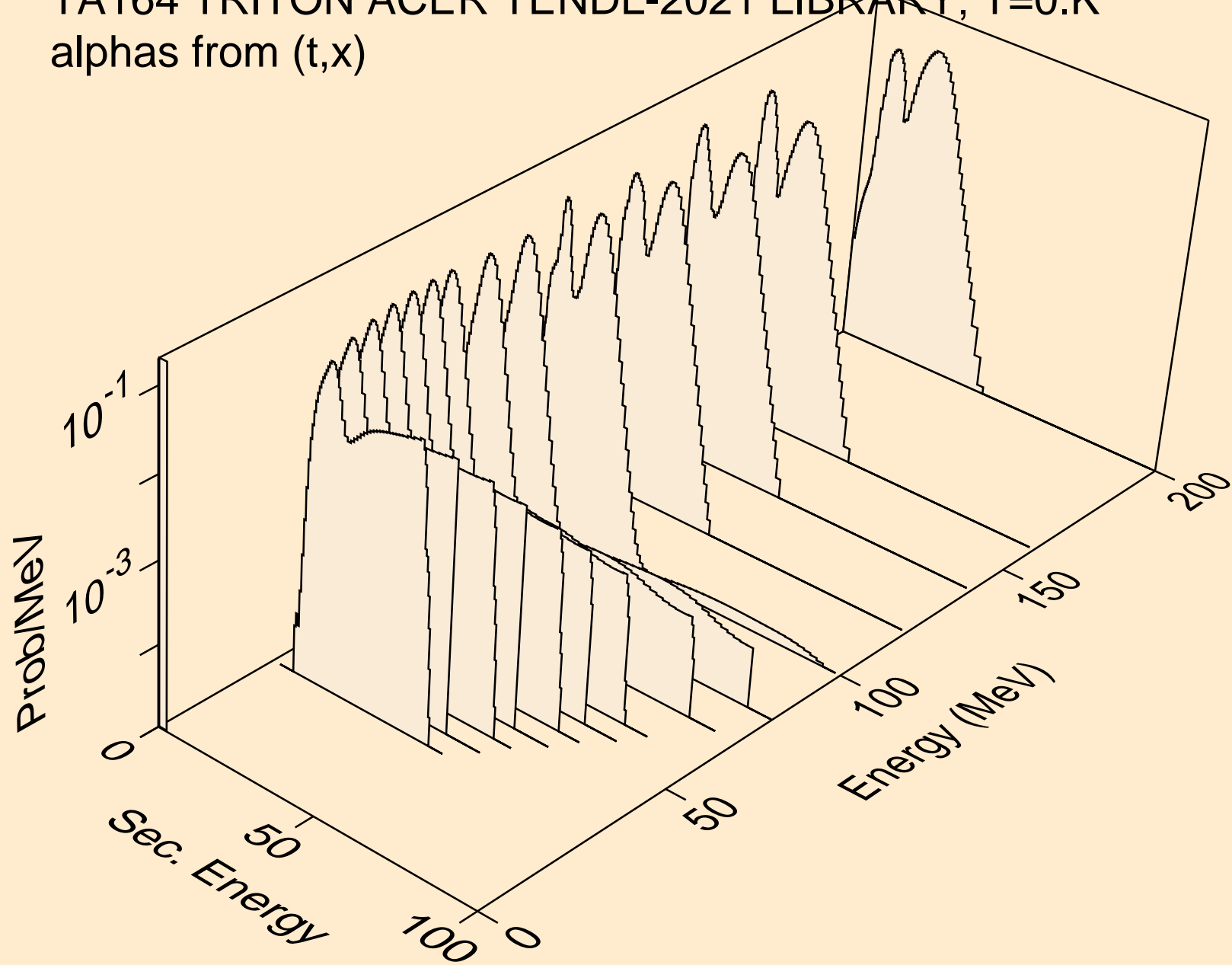

TA164 TRITON ACER TENDL-2021 LIBRARY; T=0.K  
alphas from (t,n\*)a

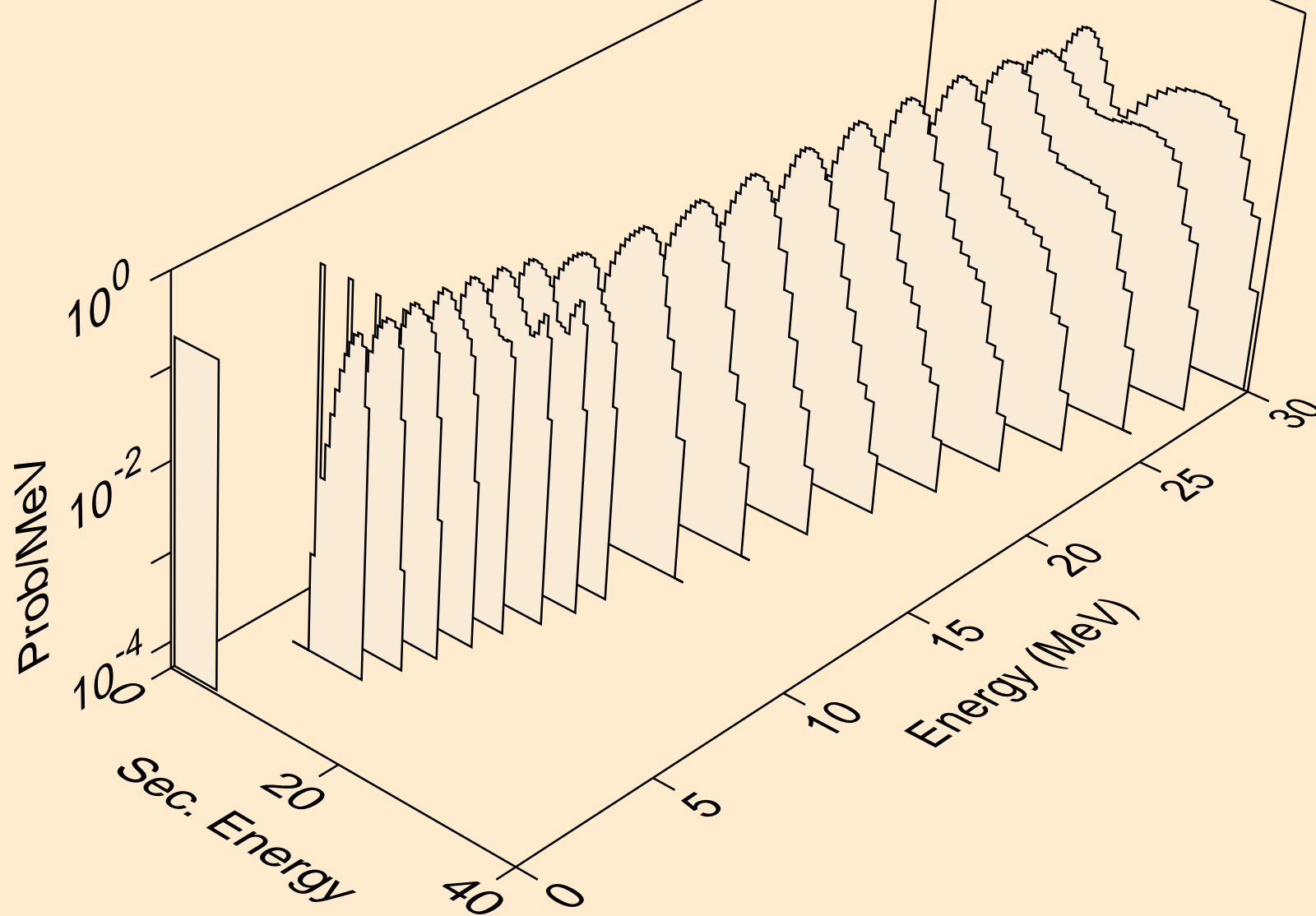

TA164 TRITON ACER TENDL-2021 LIBRARY; T=0.K  
alphas from (t,n\*)3a

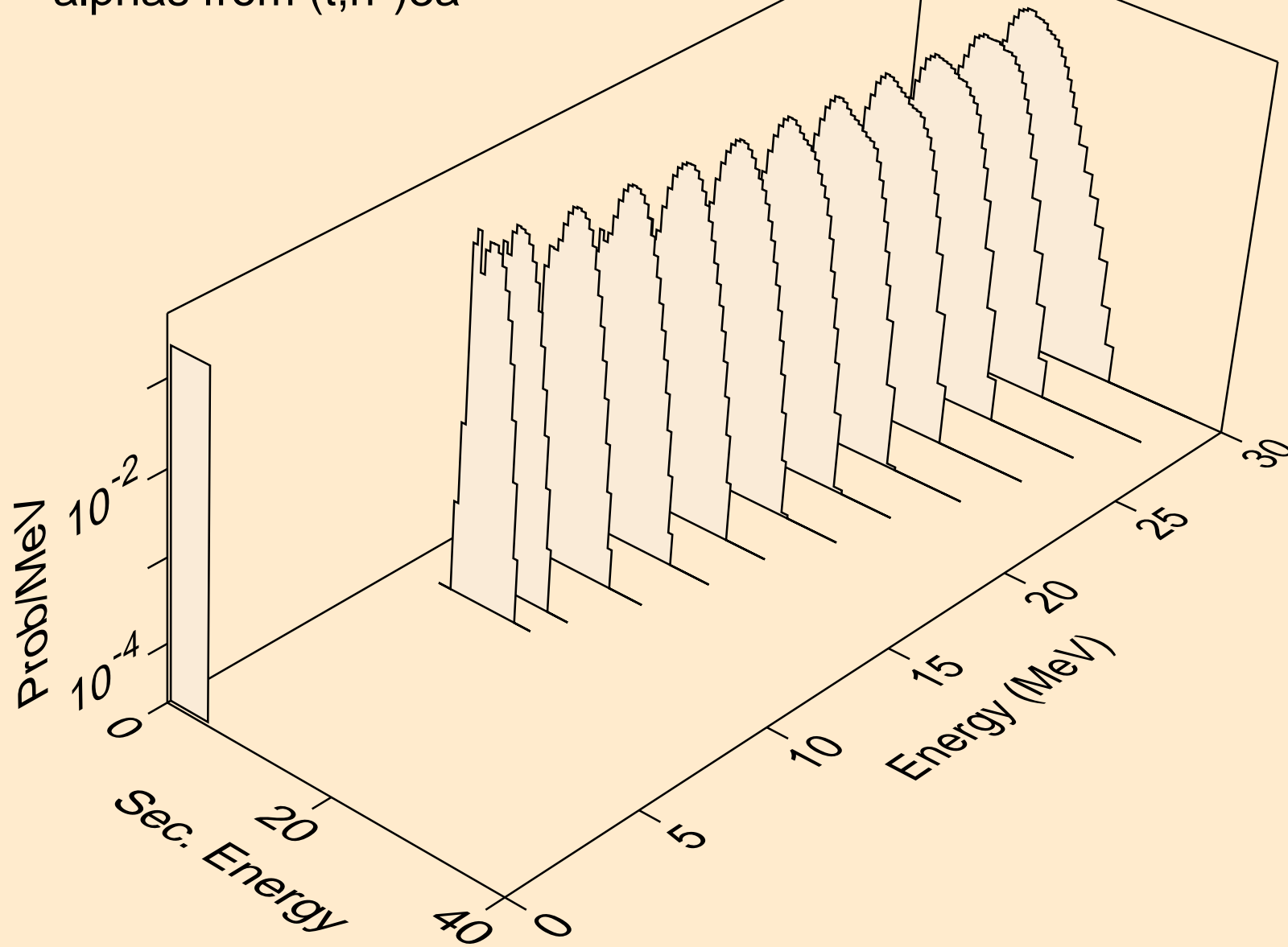

TA164 TRITON ACER TENDL-2021 LIBRARY; T=0.K  
alphas from (t,2n)a

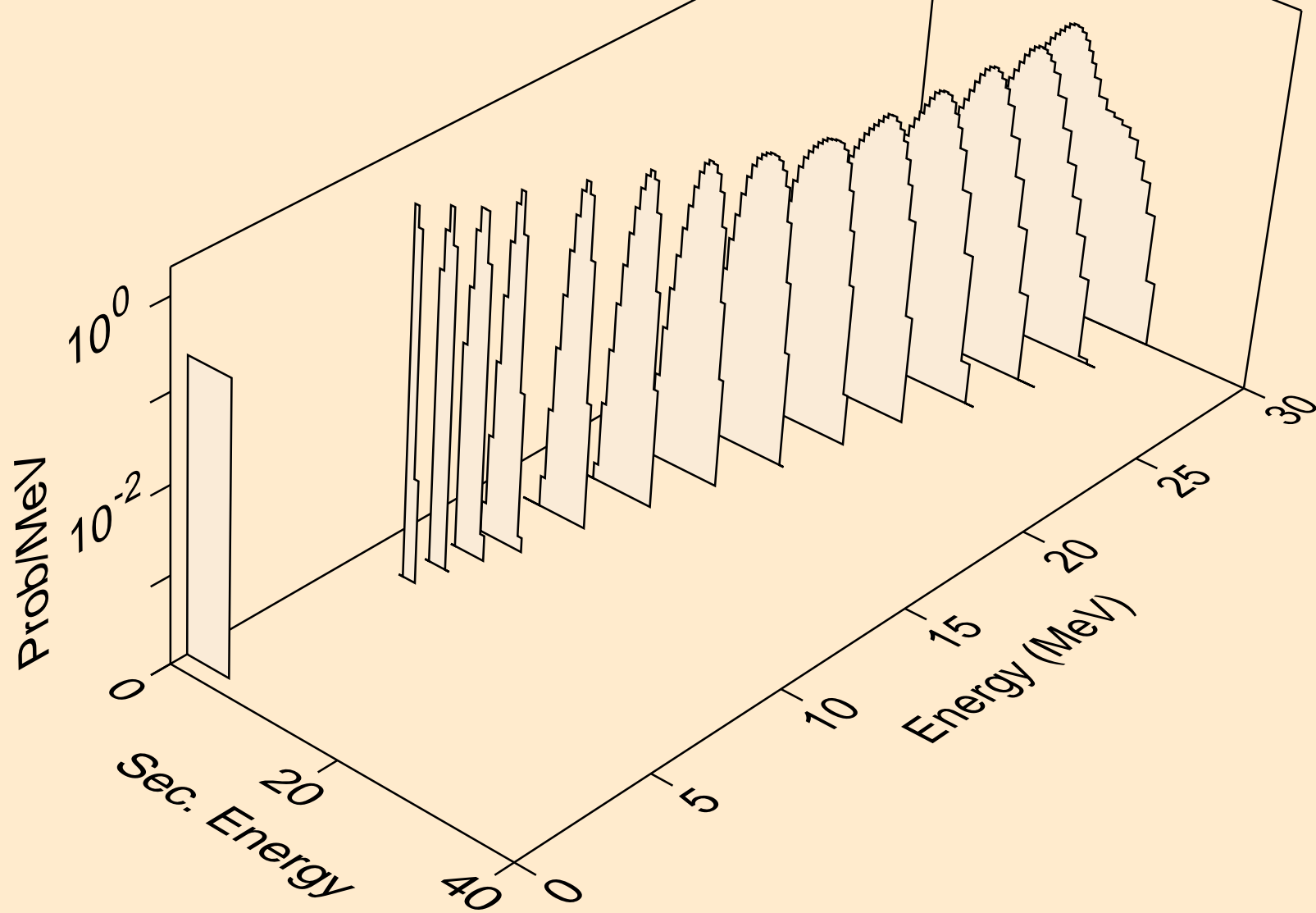



TA164 TRITON ACER TENDL-2021 LIBRARY; T=0.K  
alphas from (t,3n)a

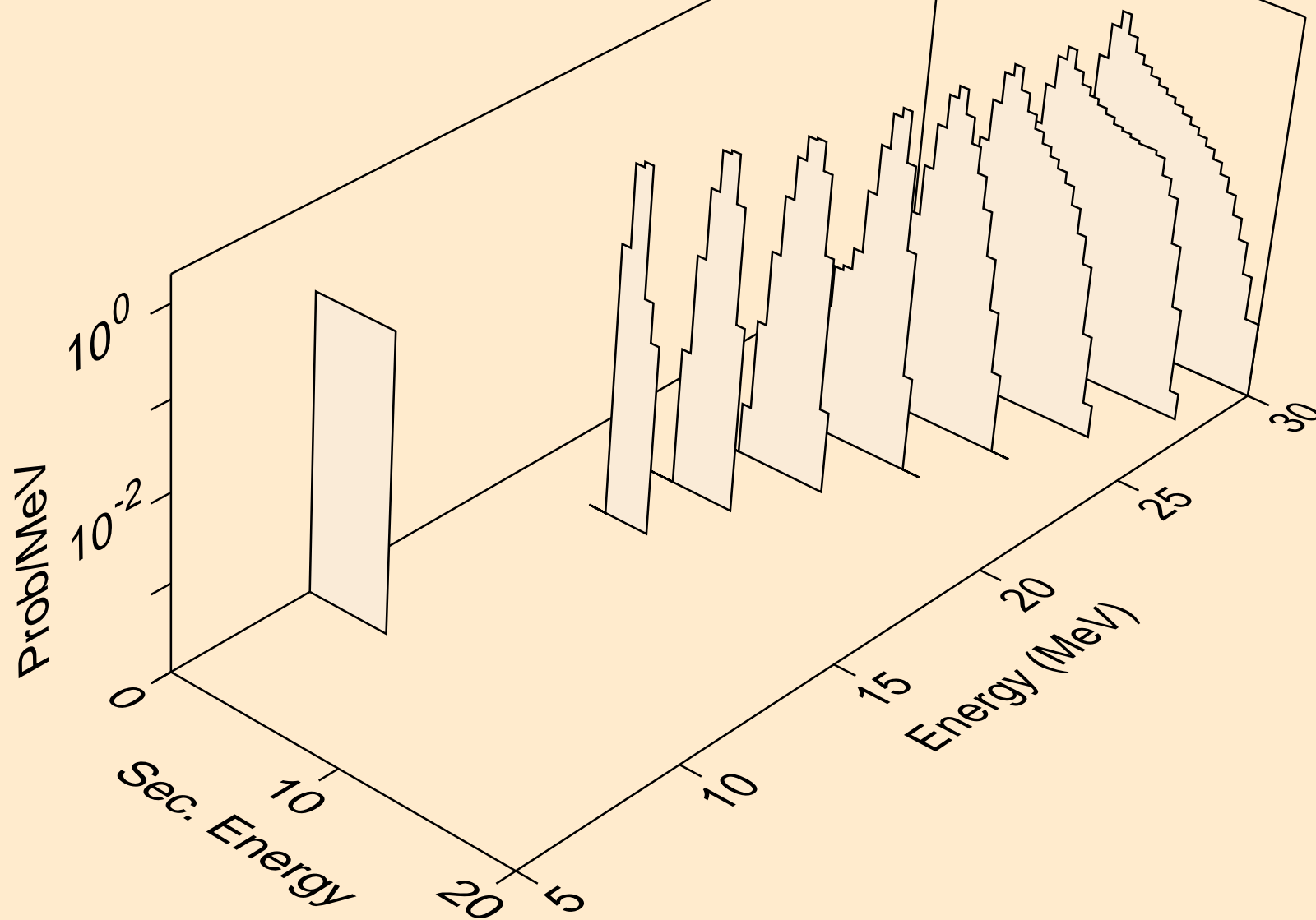

TA164 TRITON ACER TENDL-2021 LIBRARY; T=0.K  
alphas from (t,n\*)2a

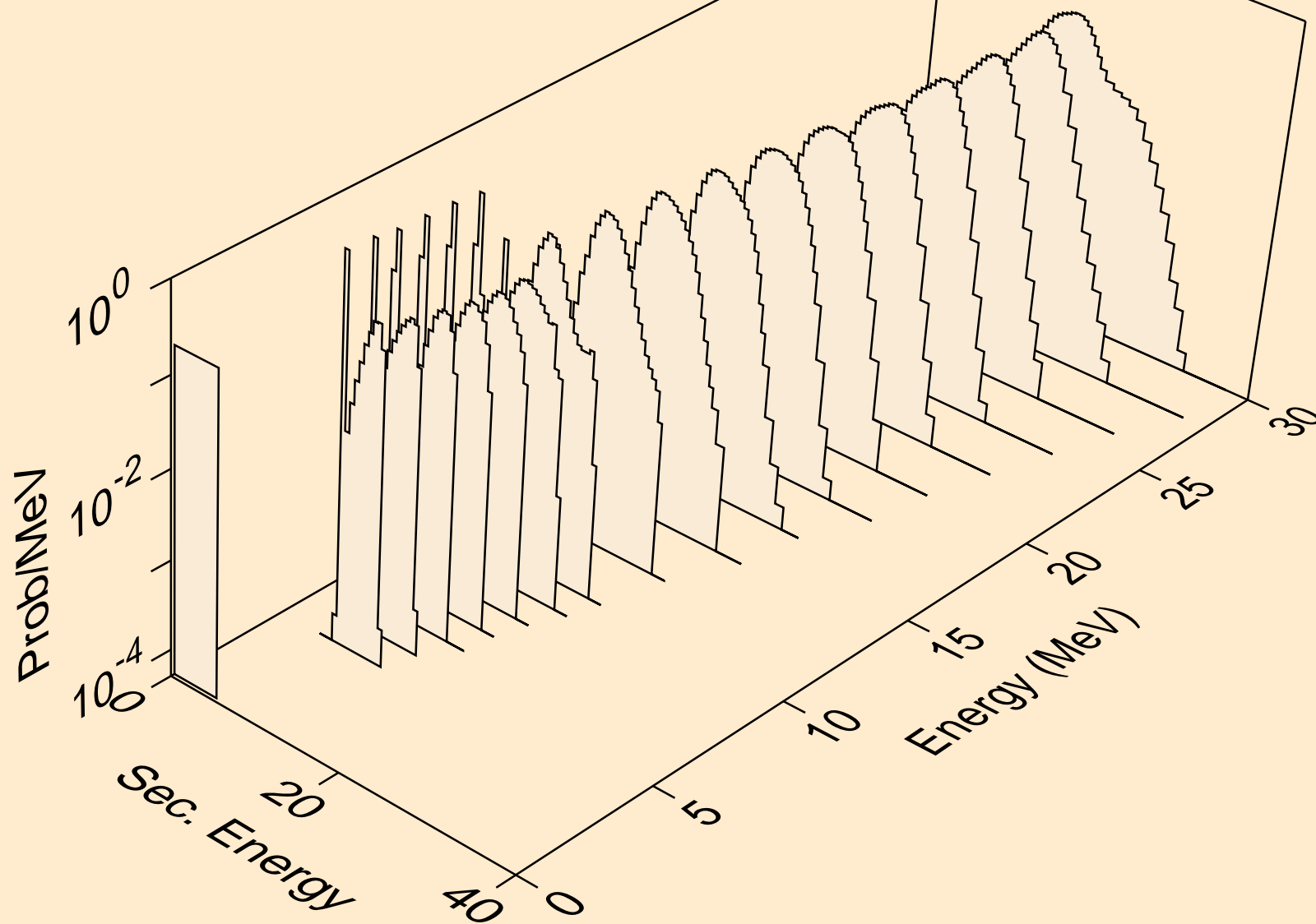

TA164 TRITON ACER TENDL-2021 LIBRARY; T=0.K  
alphas from (t,2n)2a

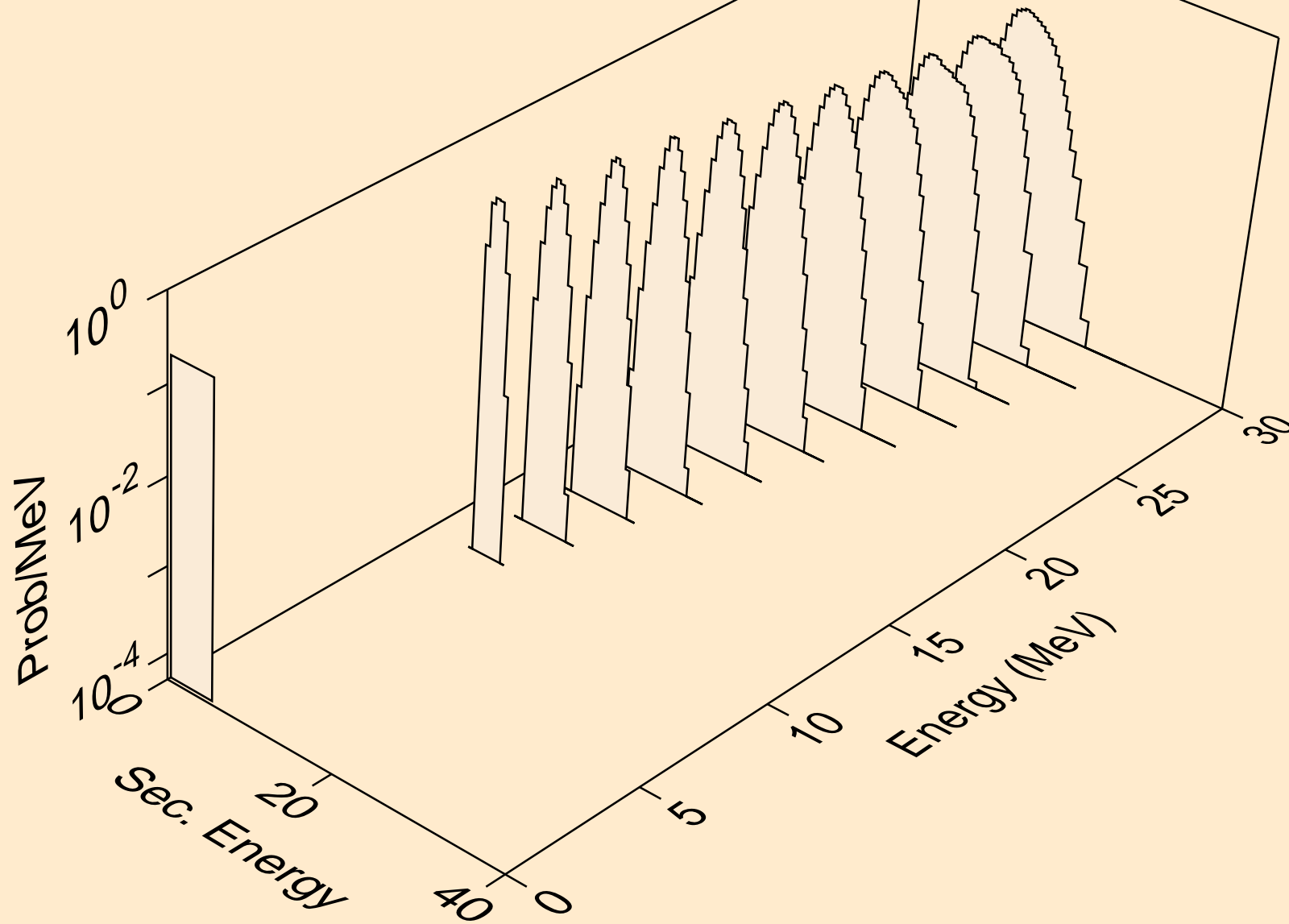

TA164 TRITON ACER TENDL-2021 LIBRARY; T=0.K  
alphas from (t,npa)

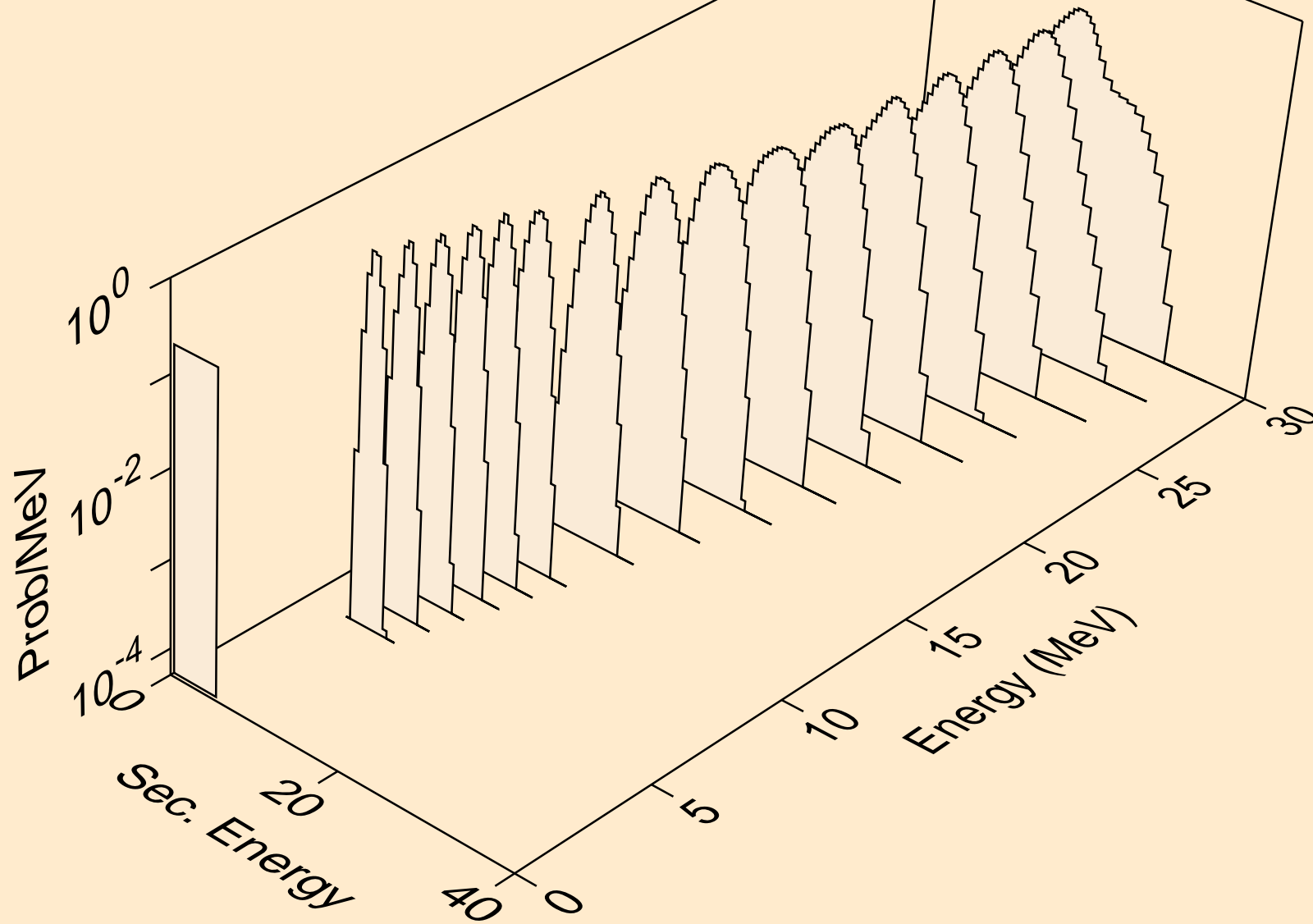

TA164 TRITON ACER TENDL-2021 LIBRARY; T=0.K  
alphas from (t,a)

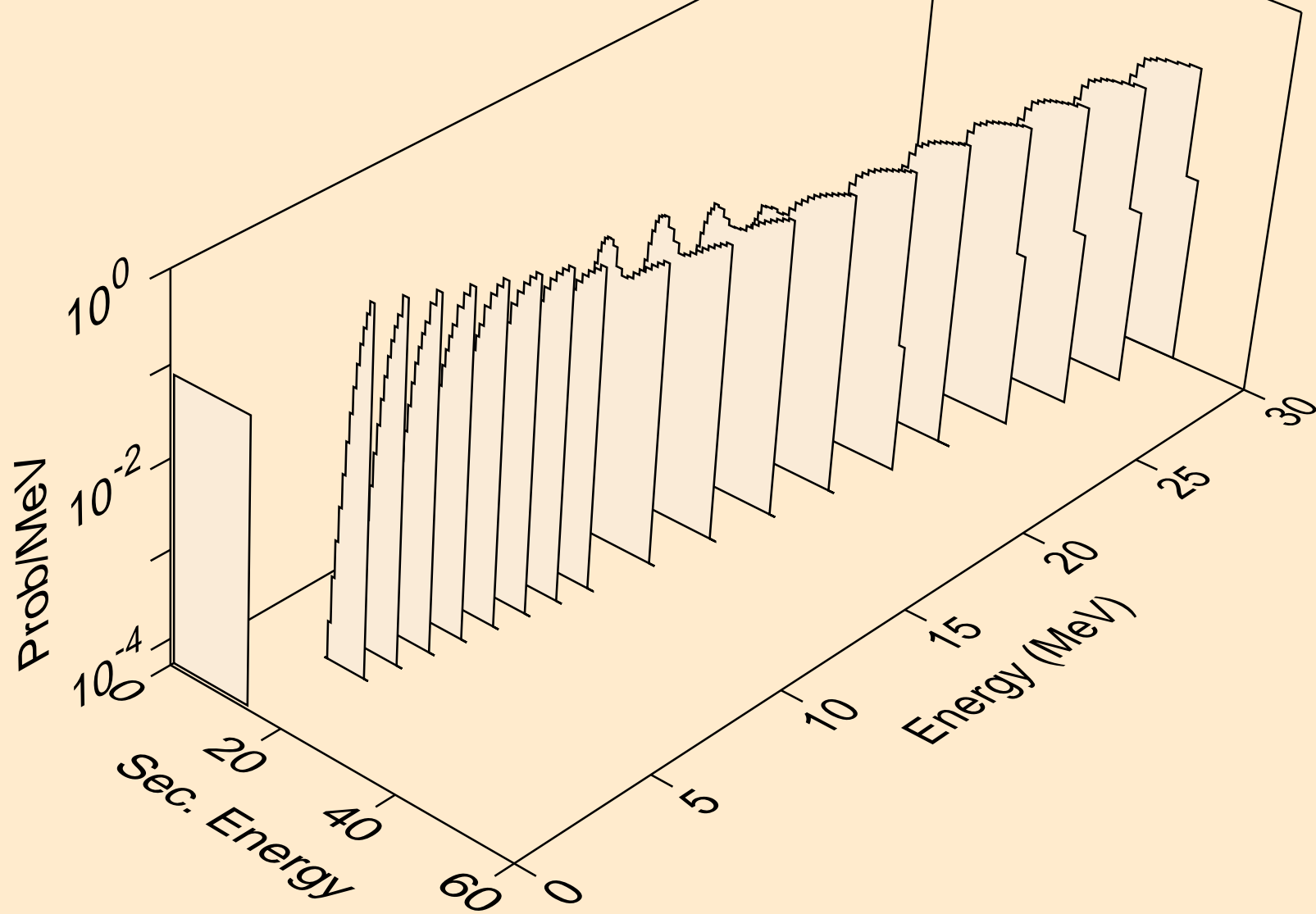

TA164 TRITON ACER TENDL-2021 LIBRARY; T=0.K  
alphas from (t,2a)

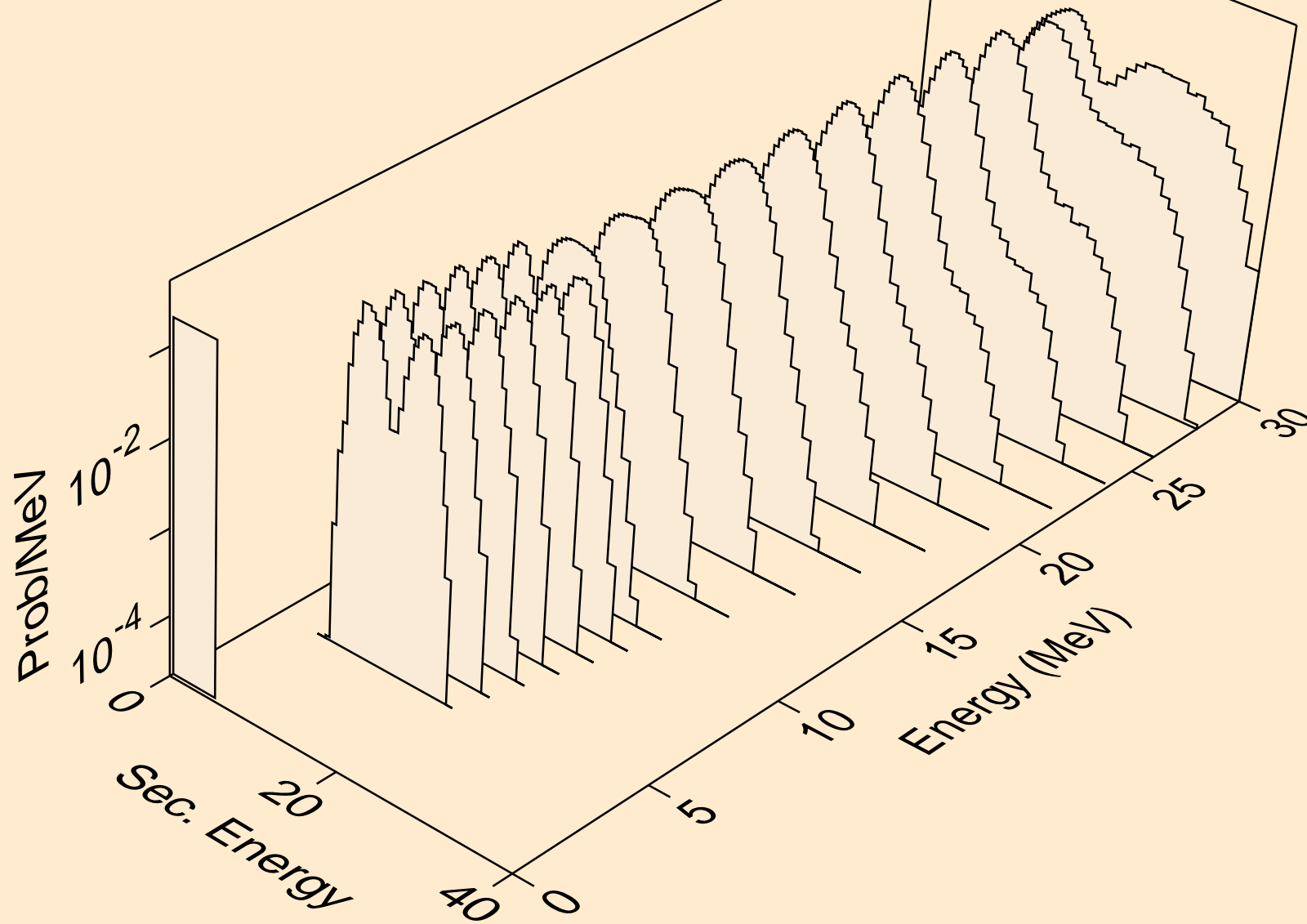

TA164 TRITON ACER TENDL-2021 LIBRARY; T=0.K  
alphas from (t,3a)

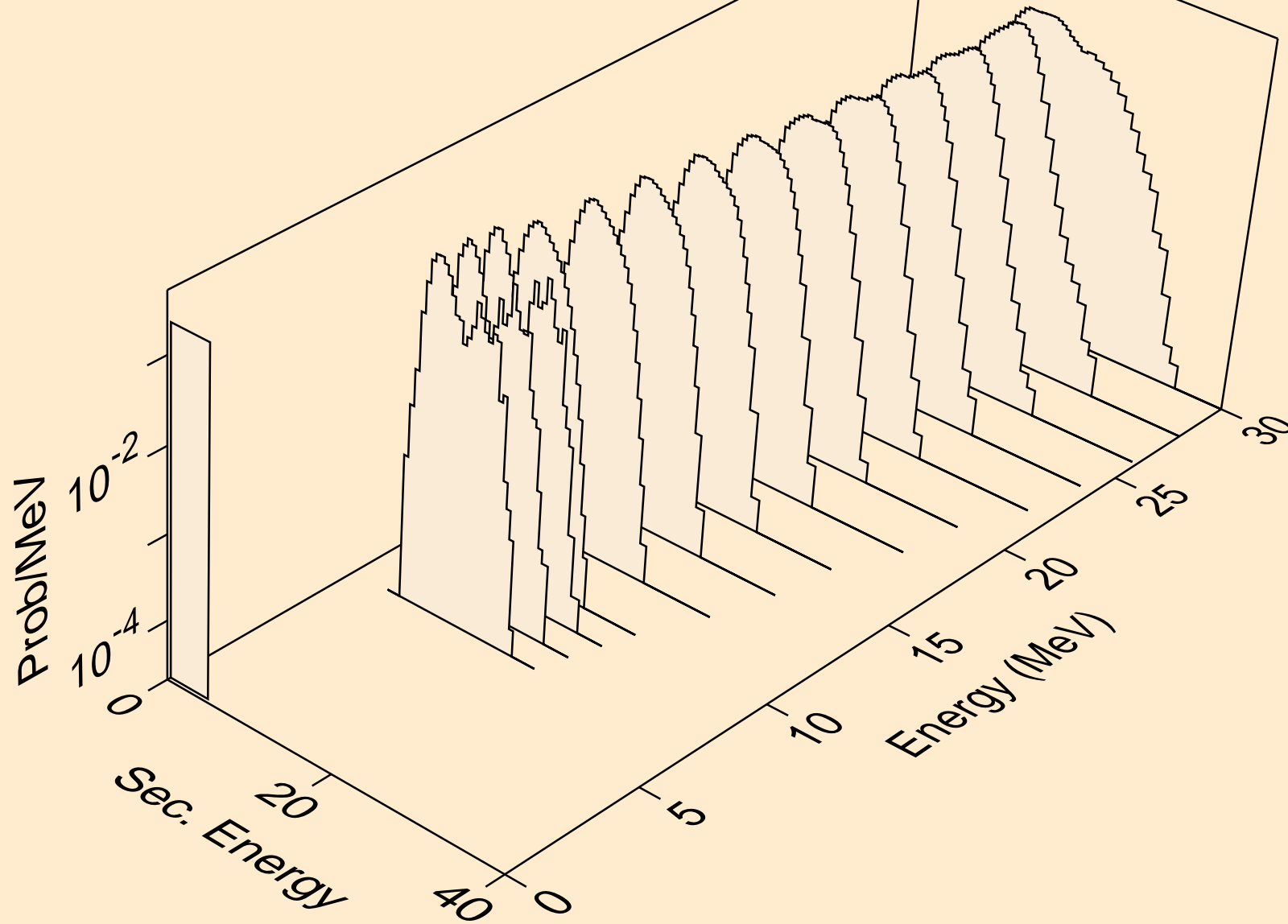

TA164 TRITON ACER TENDL-2021 LIBRARY; T=0.K  
alphas from (t,pa)

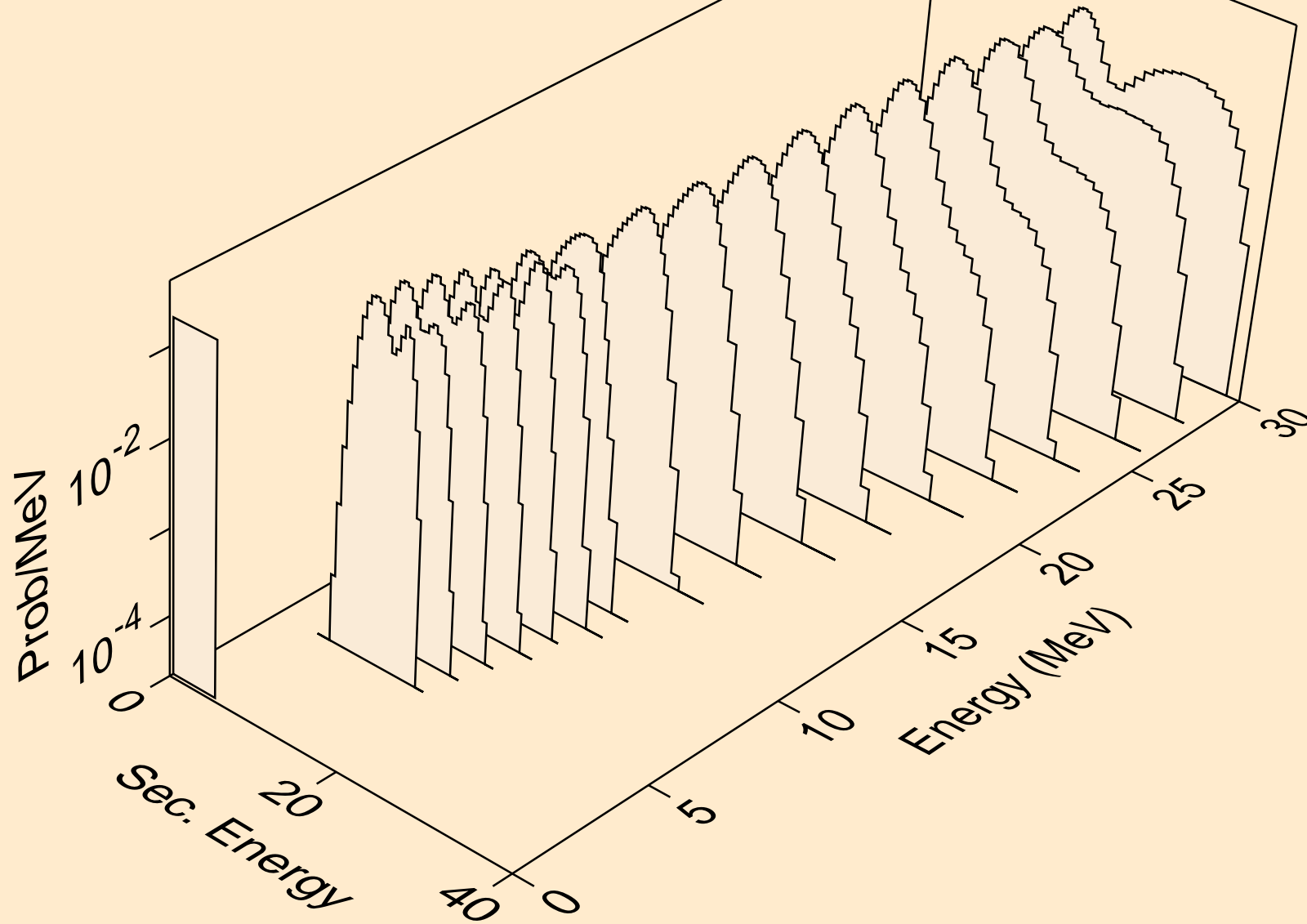



TA164 TRITON ACER TENDL-2021 LIBRARY; T=0.K  
alphas from (t,t2a)

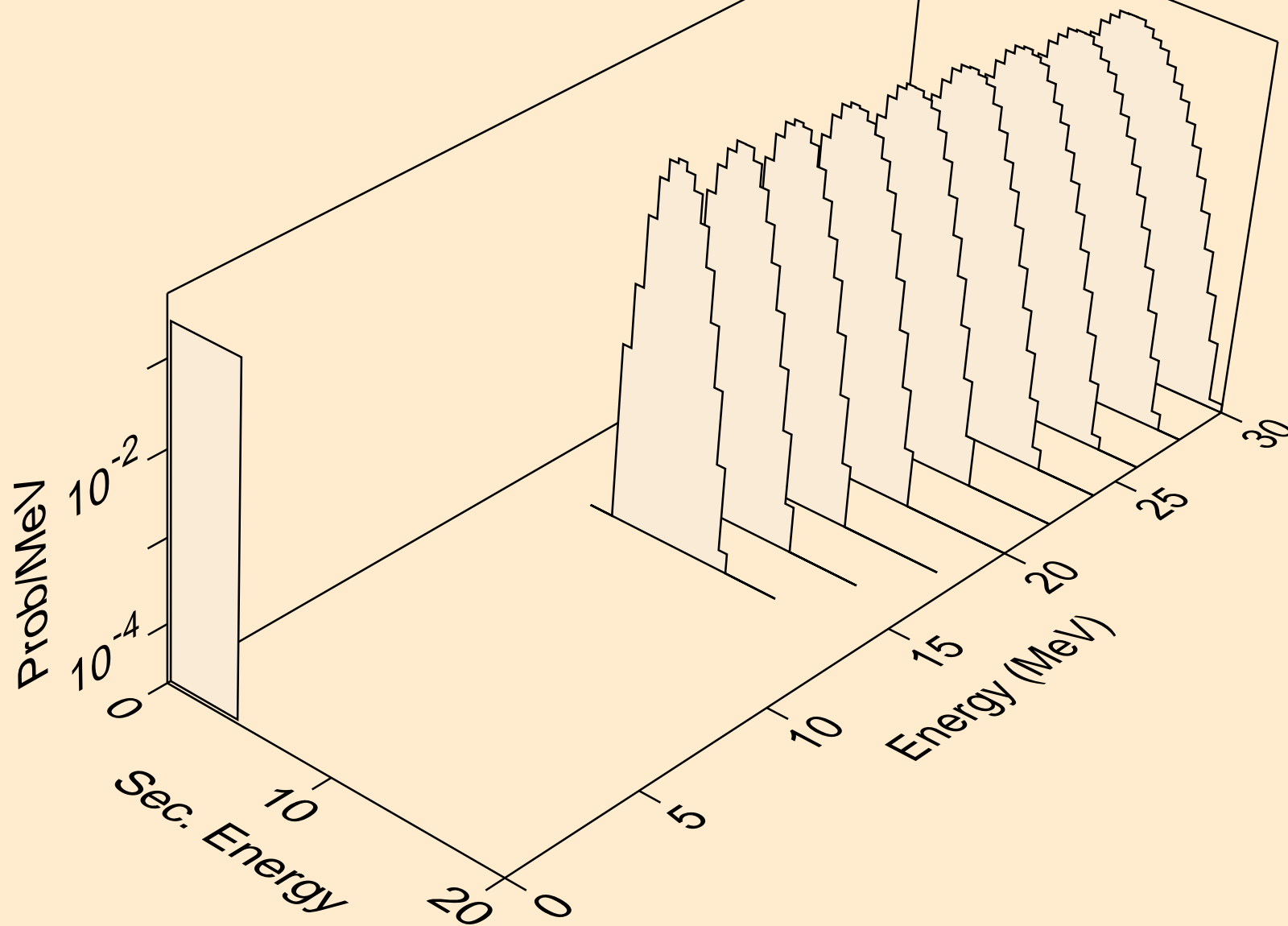

TA164 TRITON ACER TENDL-2021 LIBRARY; T=0.K  
alphas from (t,d2a)

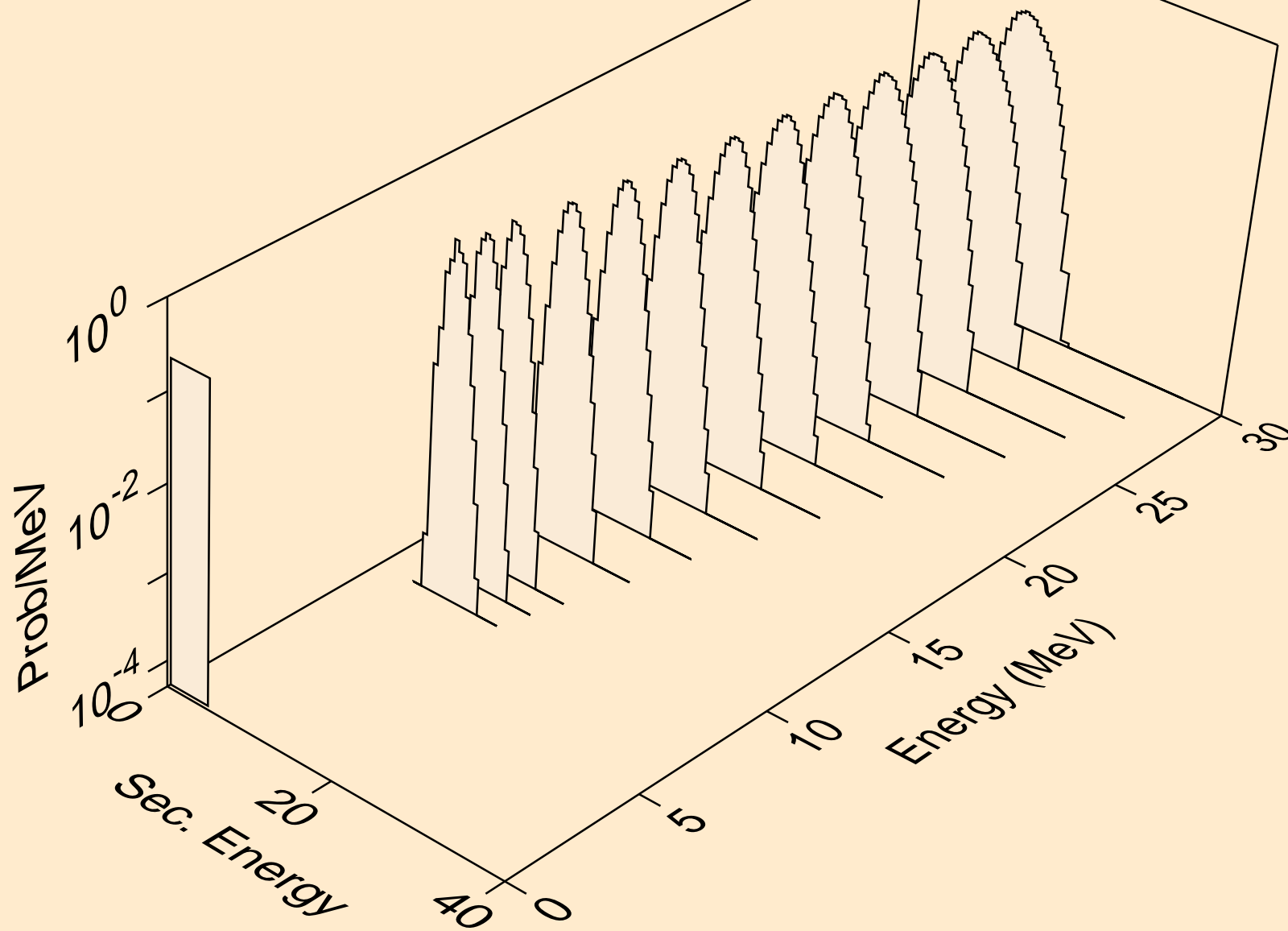

TA164 TRITON ACER TENDL-2021 LIBRARY; T=0.K  
alphas from (t,da)

