

TL213 TRITON ACER TENDL-2021 LIBRARY; T=0.K
Principal cross sections

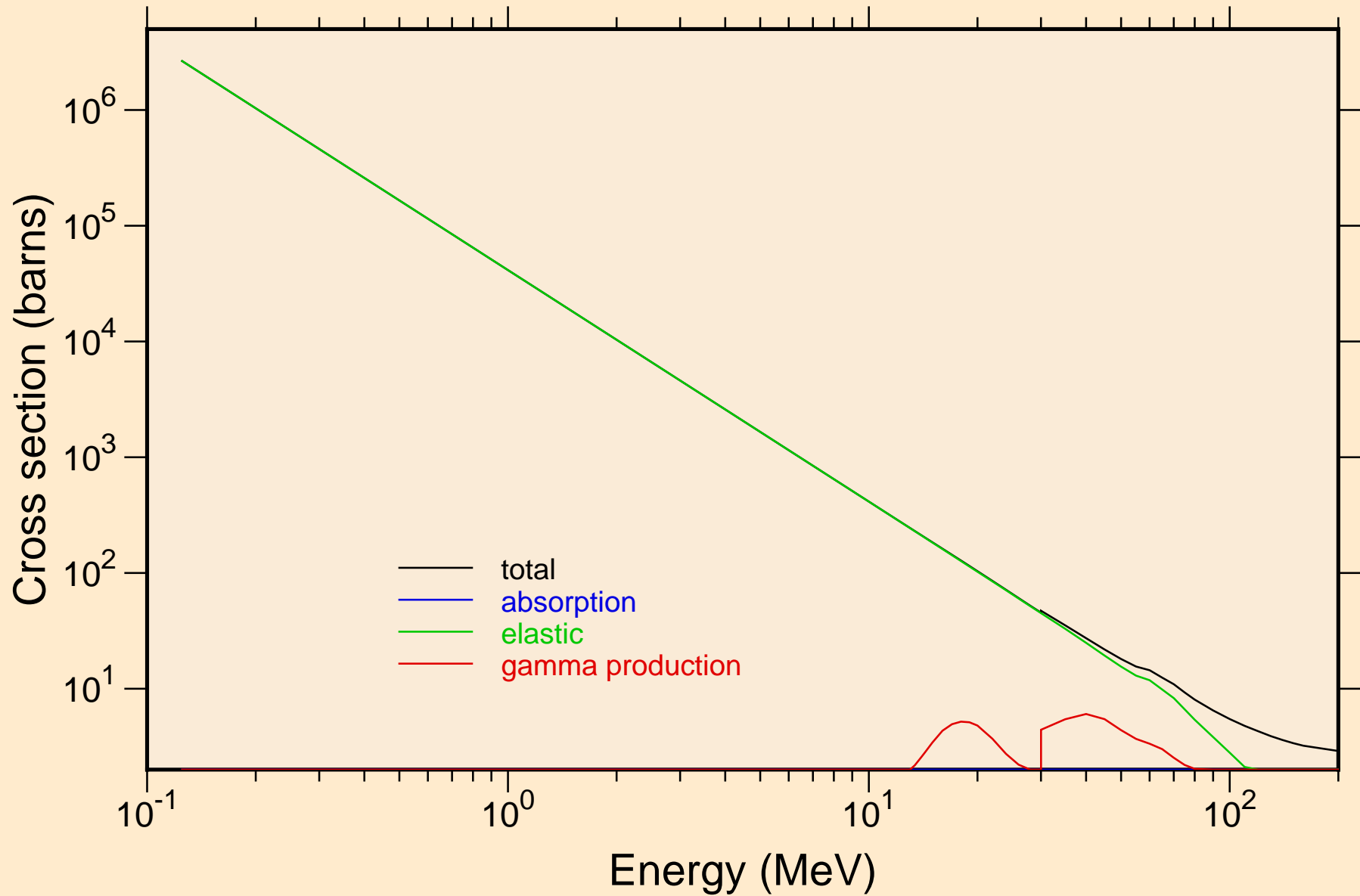

TL213 TRITON ACER TENDL-2021 LIBRARY; T=0.K

Heating

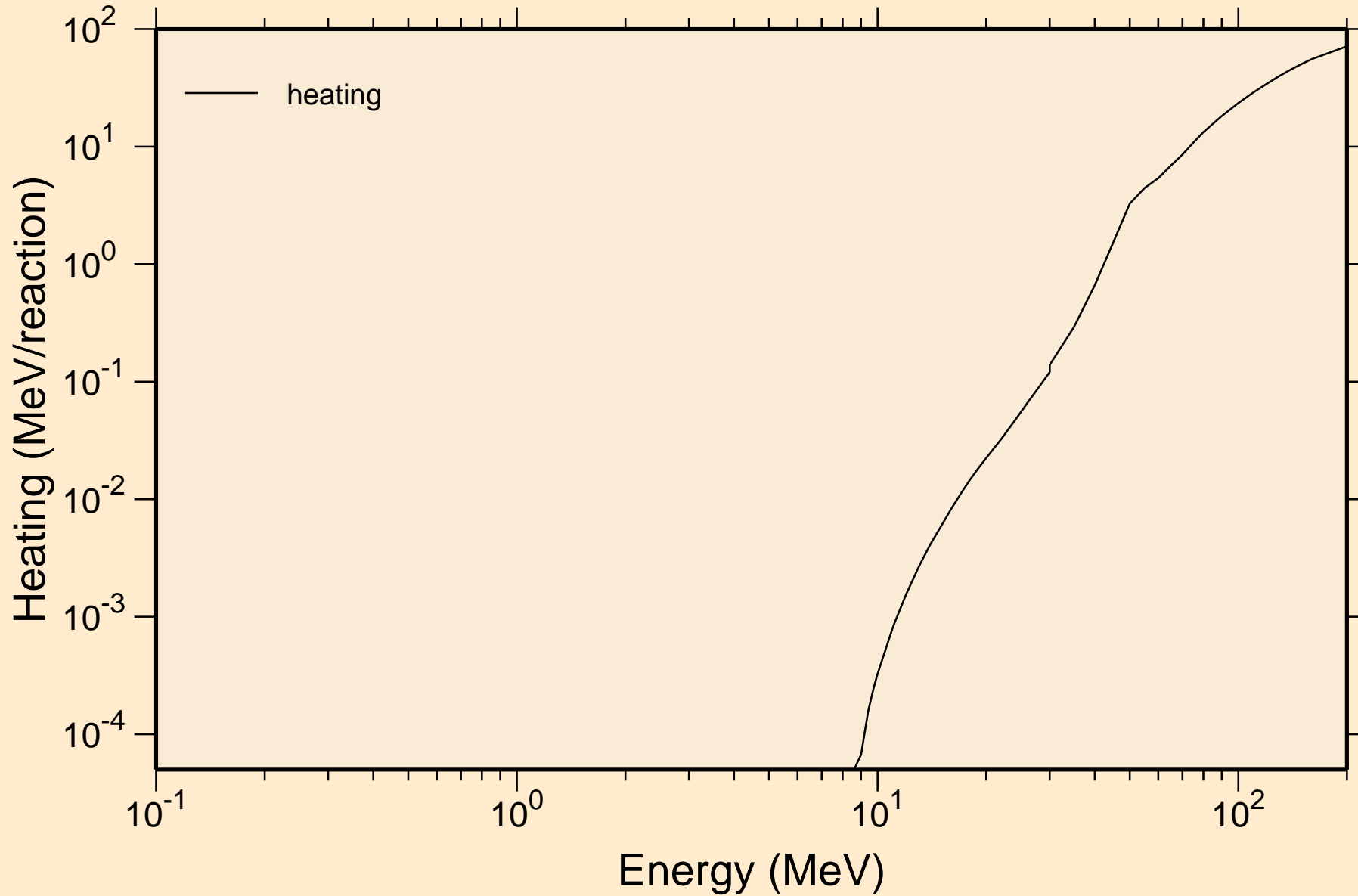

TL213 TRITON ACER TENDL-2021 LIBRARY; T=0.K

Principal cross sections

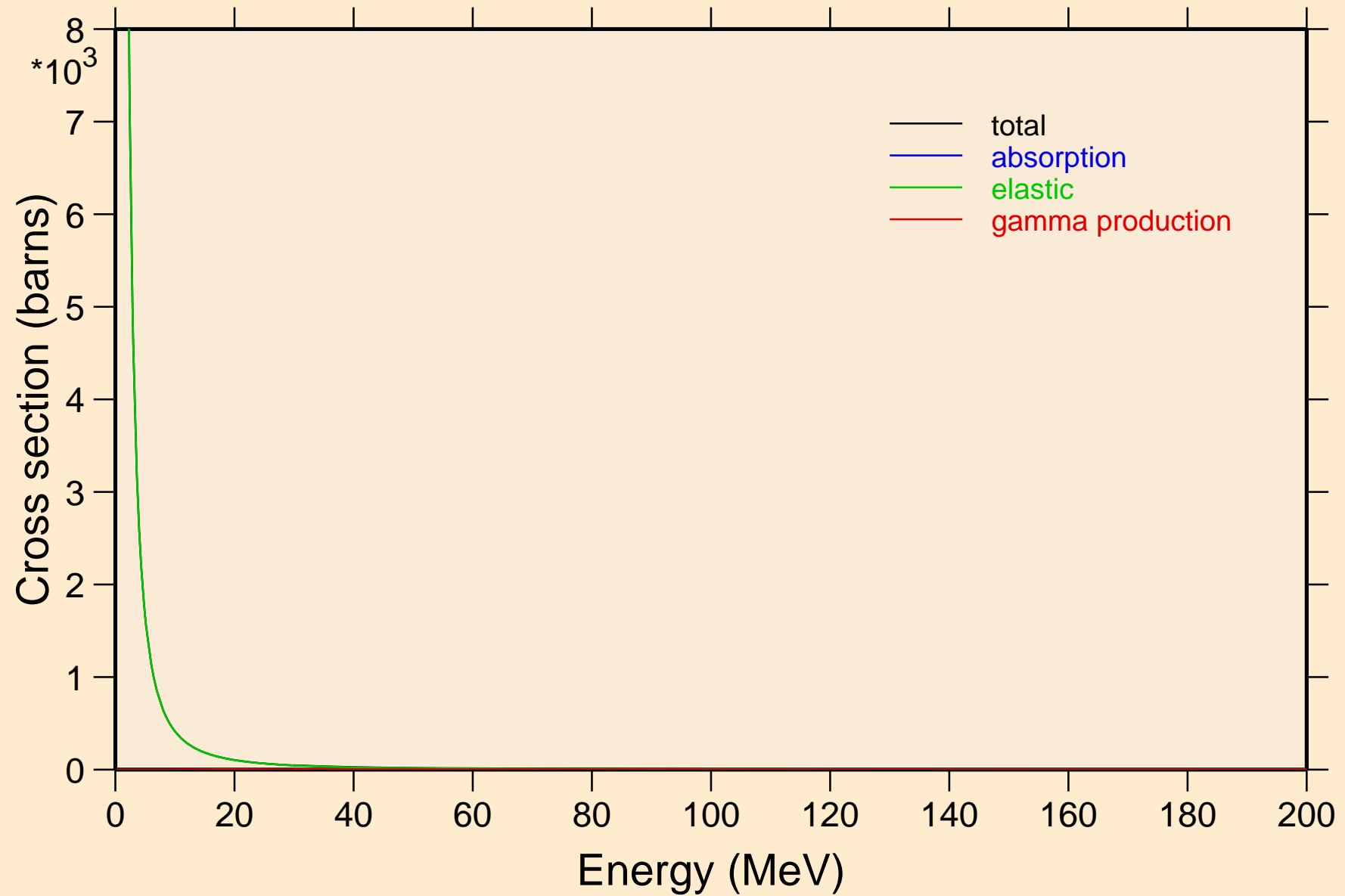

TL213 TRITON ACER TENDL-2021 LIBRARY; T=0.K

Heating

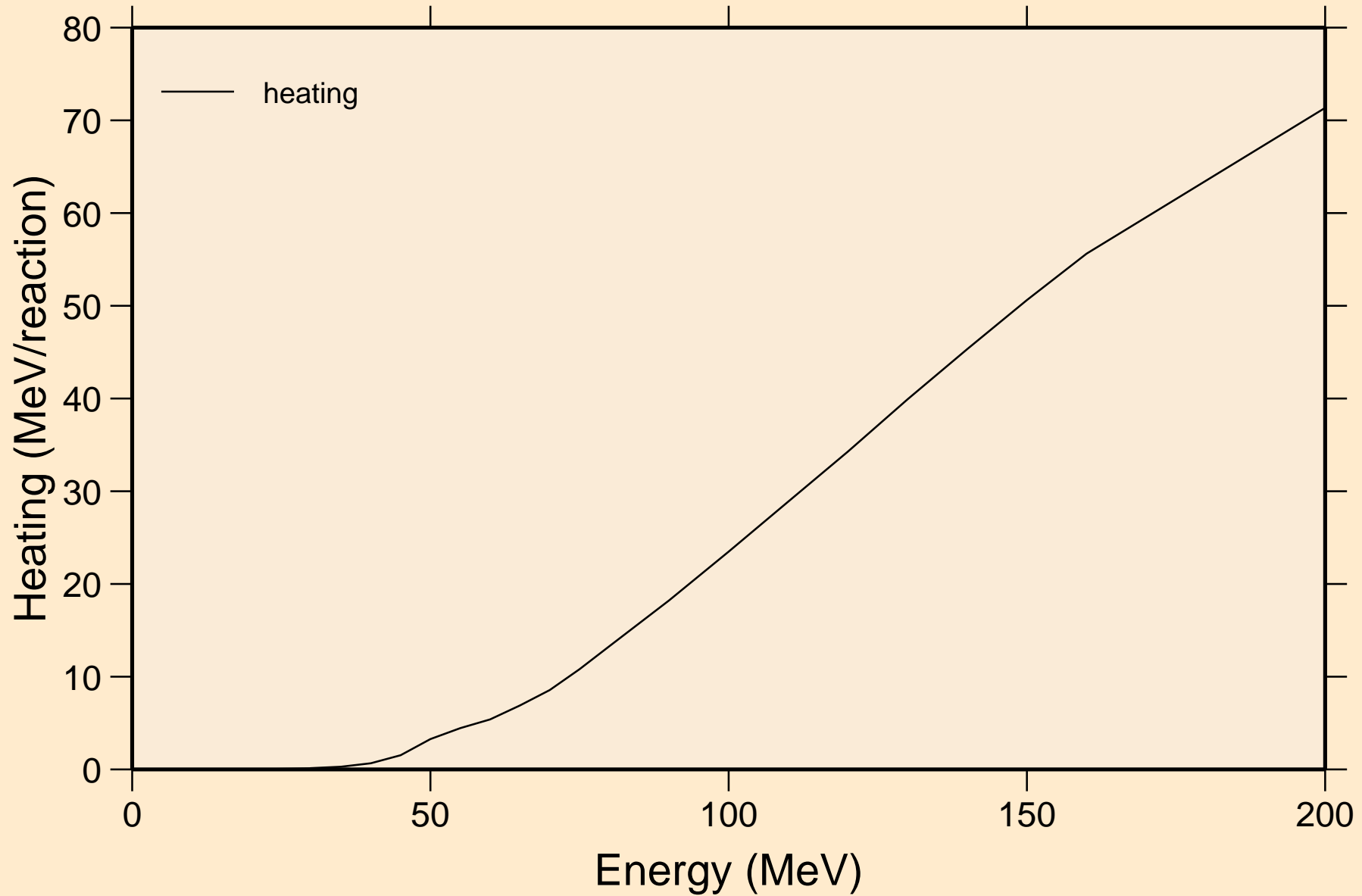

TL213 TRITON ACER TENDL-2021 LIBRARY; T=0.K
Threshold reactions

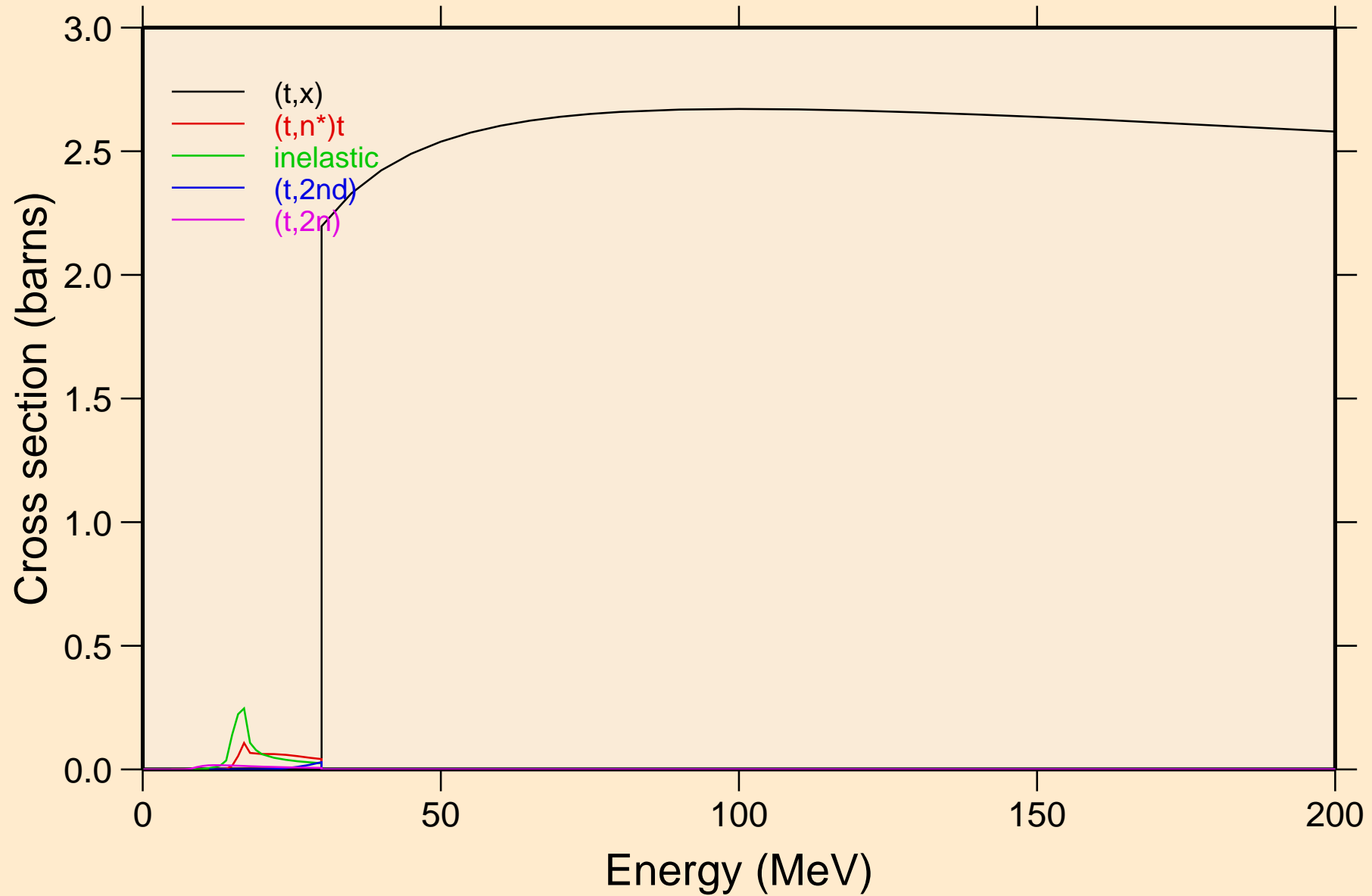

TL213 TRITON ACER TENDL-2021 LIBRARY; T=0.K
Threshold reactions

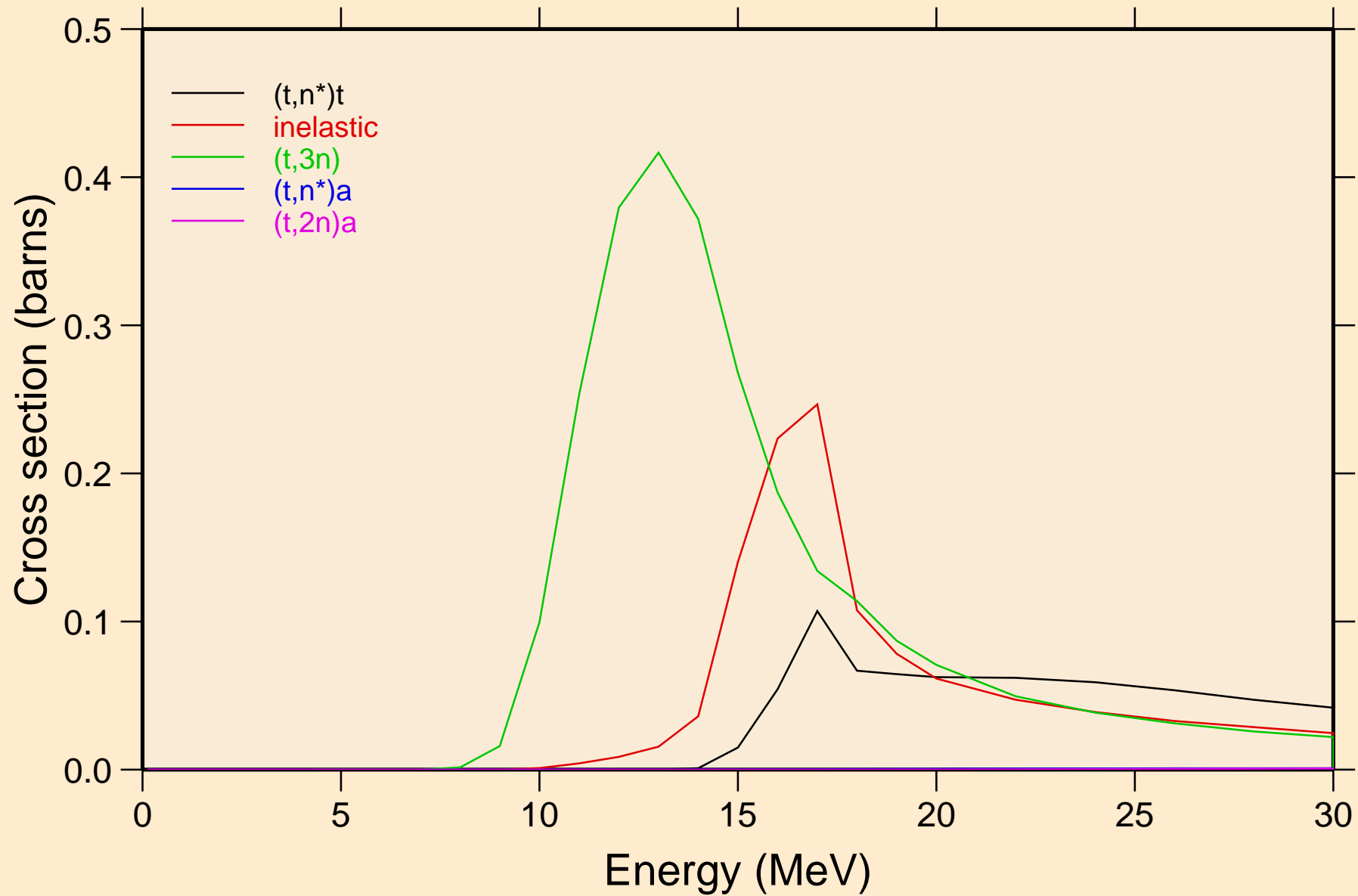

TL213 TRITON ACER TENDL-2021 LIBRARY; T=0.K
Threshold reactions

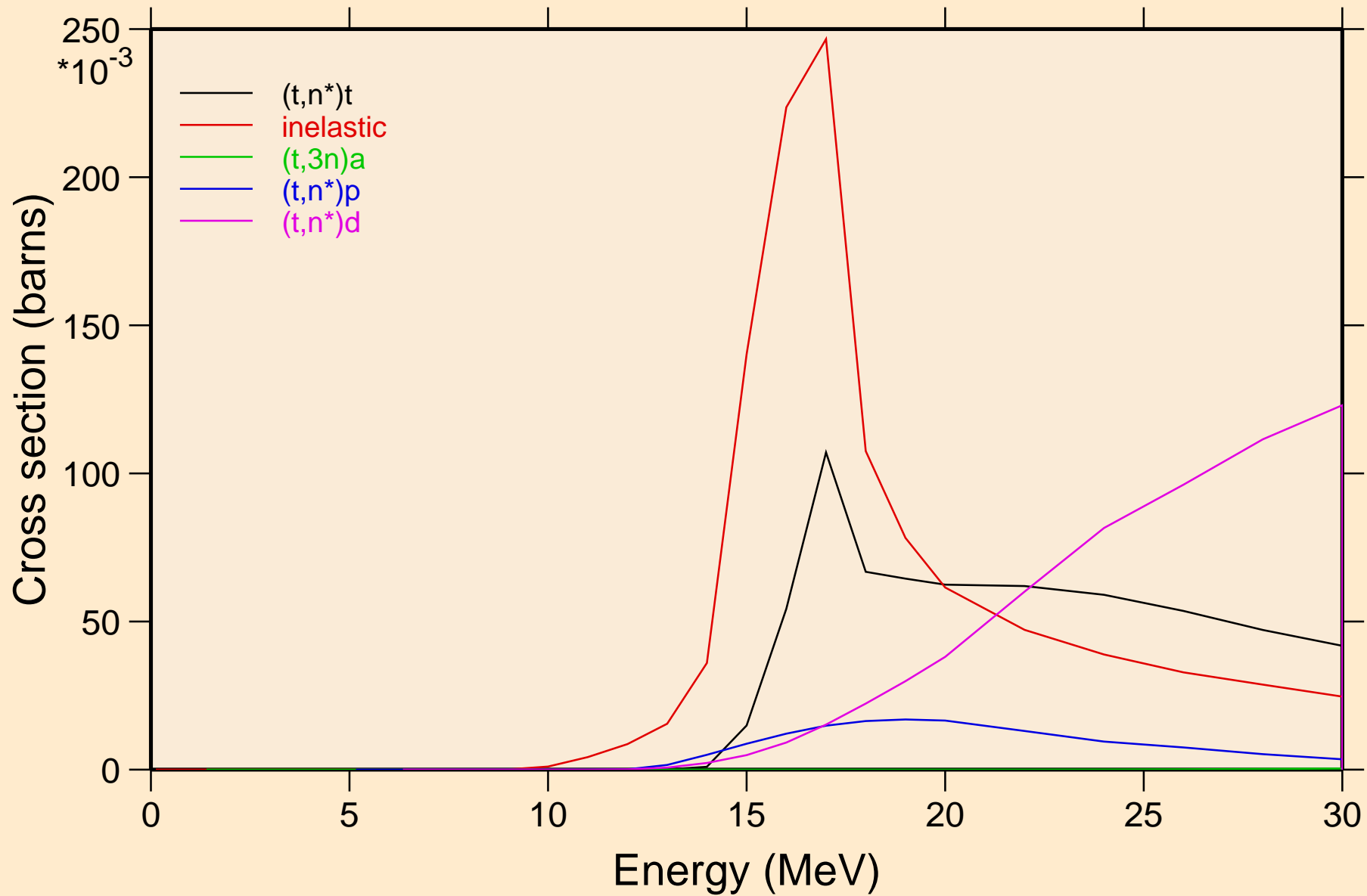

TL213 TRITON ACER TENDL-2021 LIBRARY; T=0.K
Threshold reactions

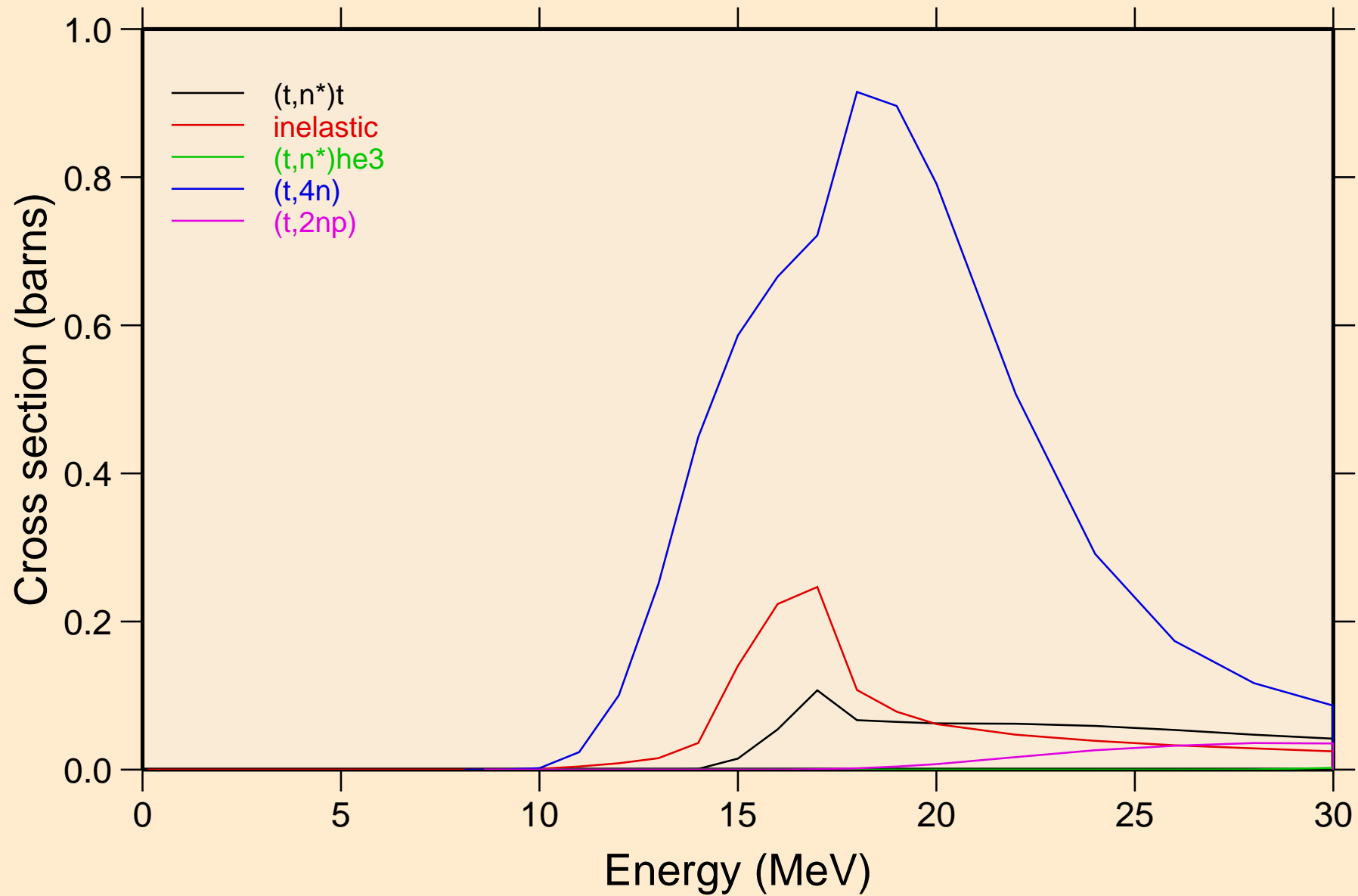

TL213 TRITON ACER TENDL-2021 LIBRARY; T=0.K
Threshold reactions

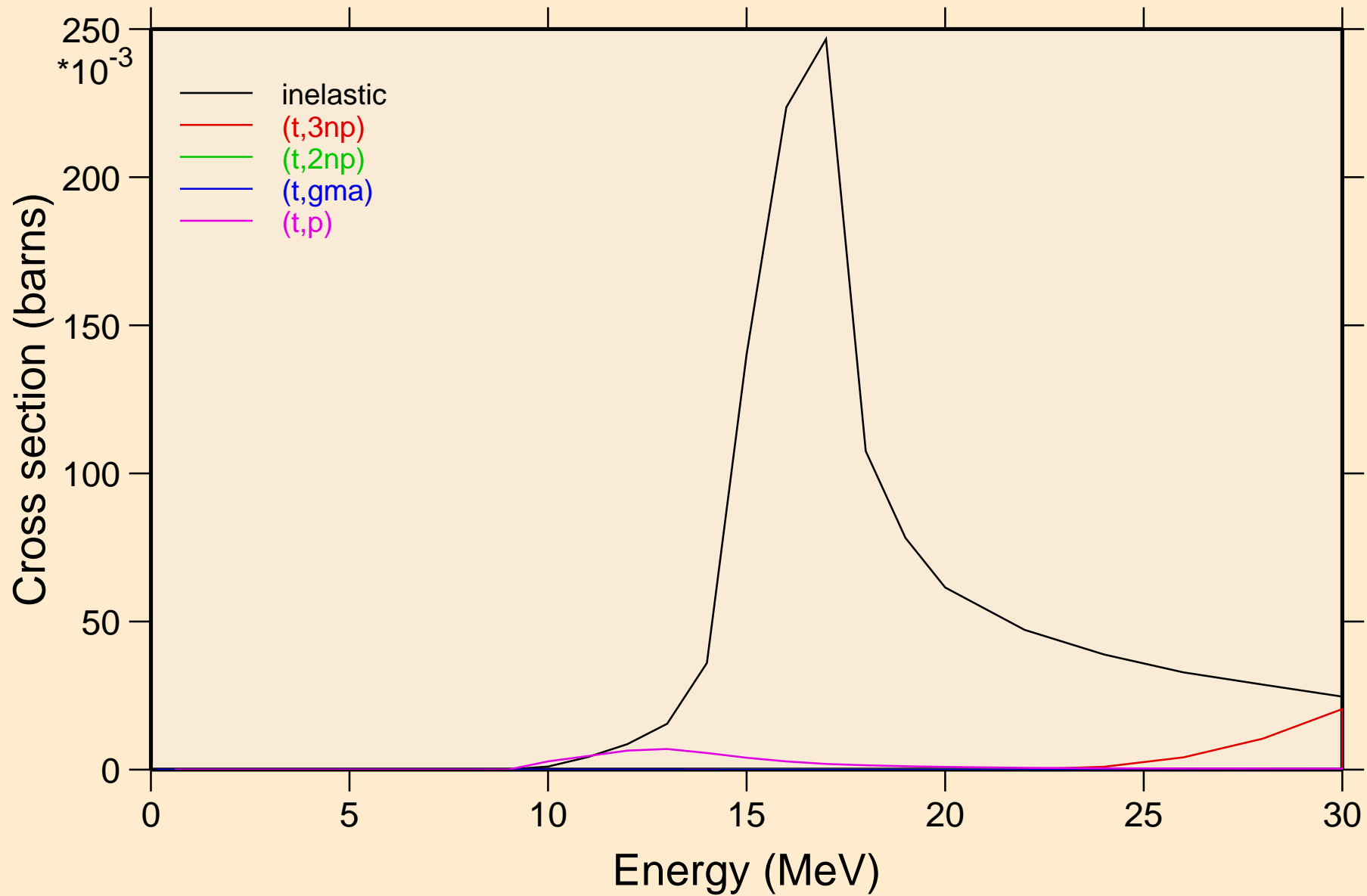

TL213 TRITON ACER TENDL-2021 LIBRARY; T=0.K
Threshold reactions

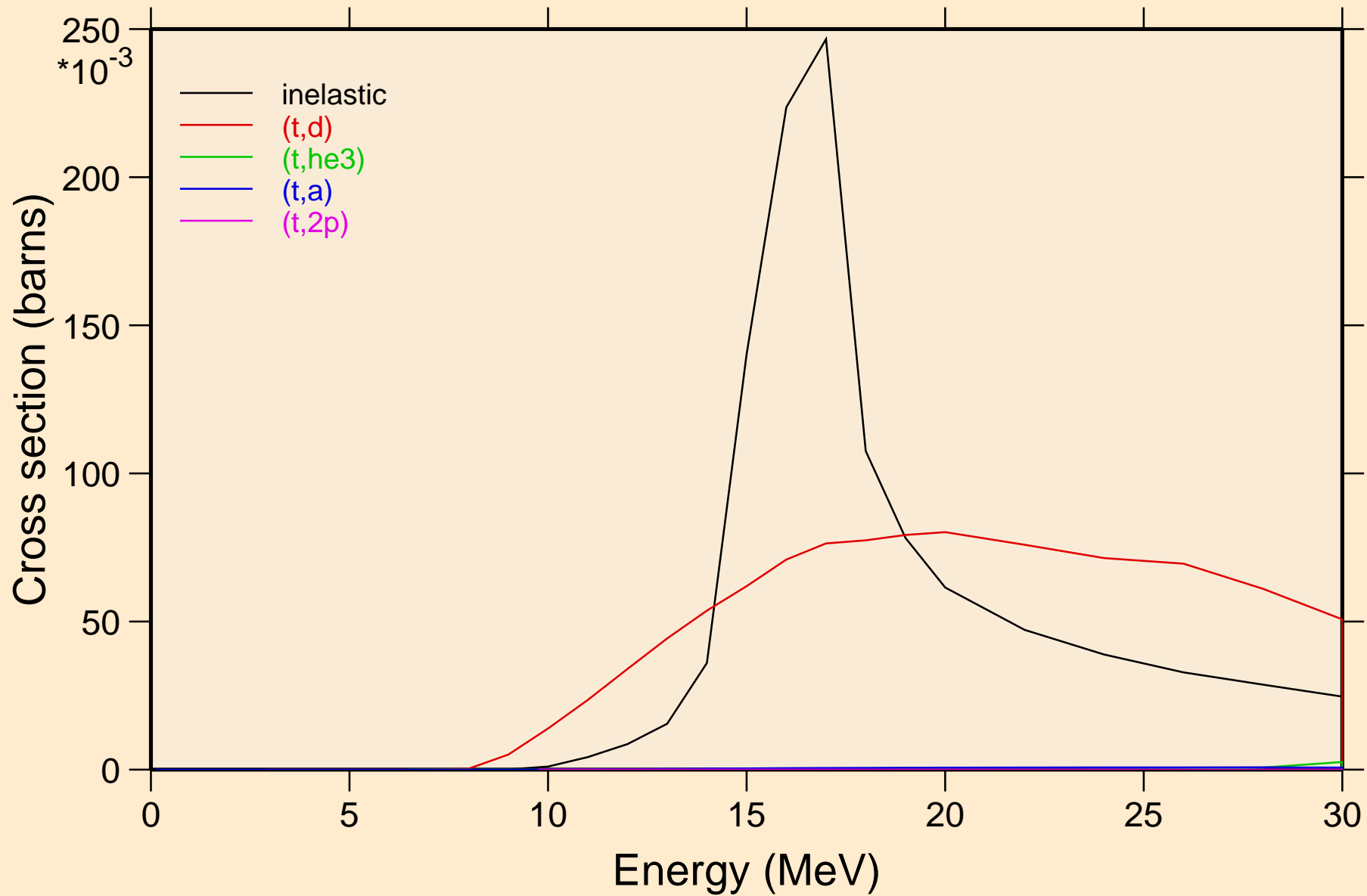

TL213 TRITON ACER TENDL-2021 LIBRARY; T=0.K
angular distribution for elastic

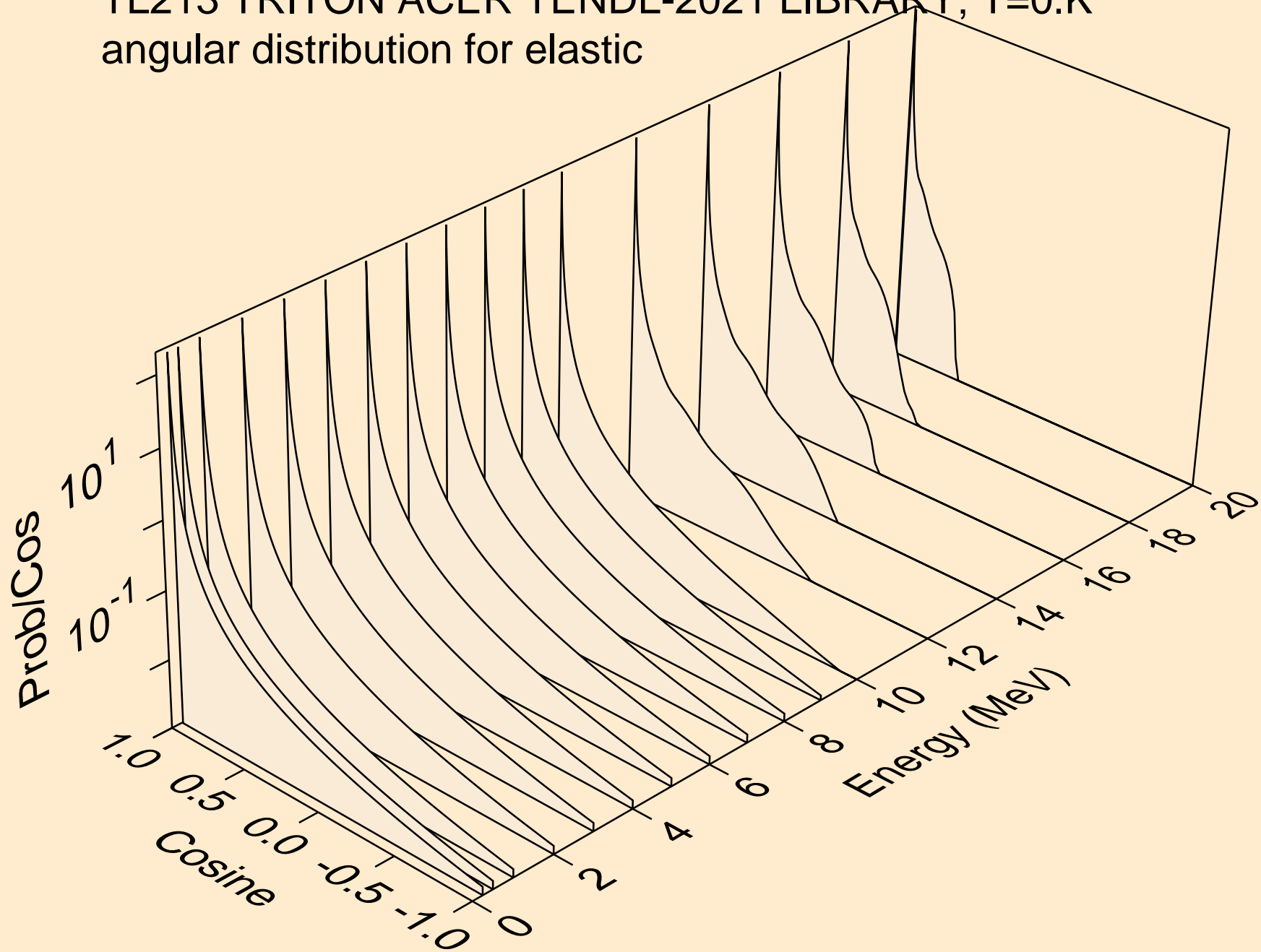

TL213 TRITON ACER TENDL-2021 LIBRARY; T=0.K
angular distribution for elastic

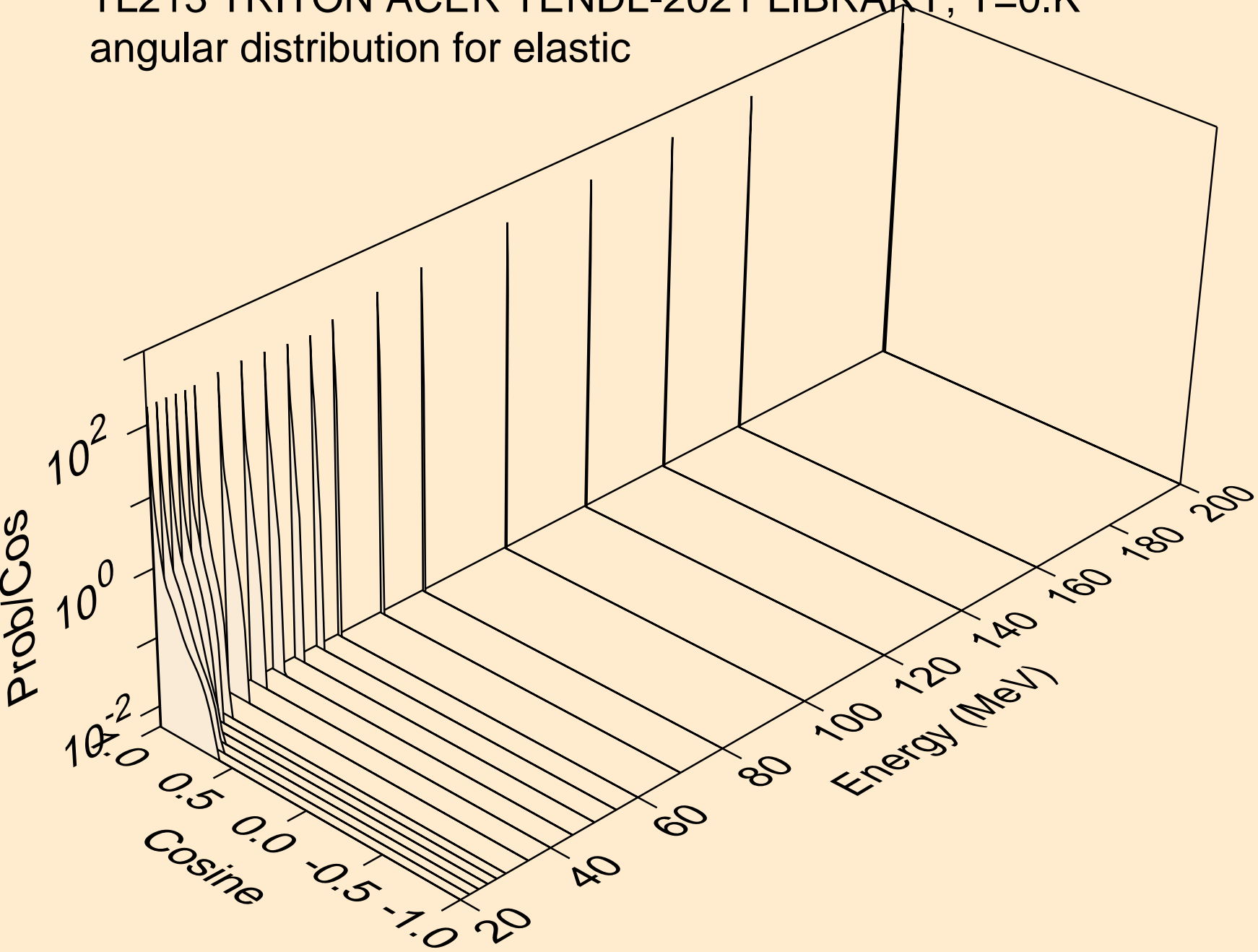

TL213 TRITON ACER TENDL-2021 LIBRARY; T=0.K
Triton emission for (t,x)

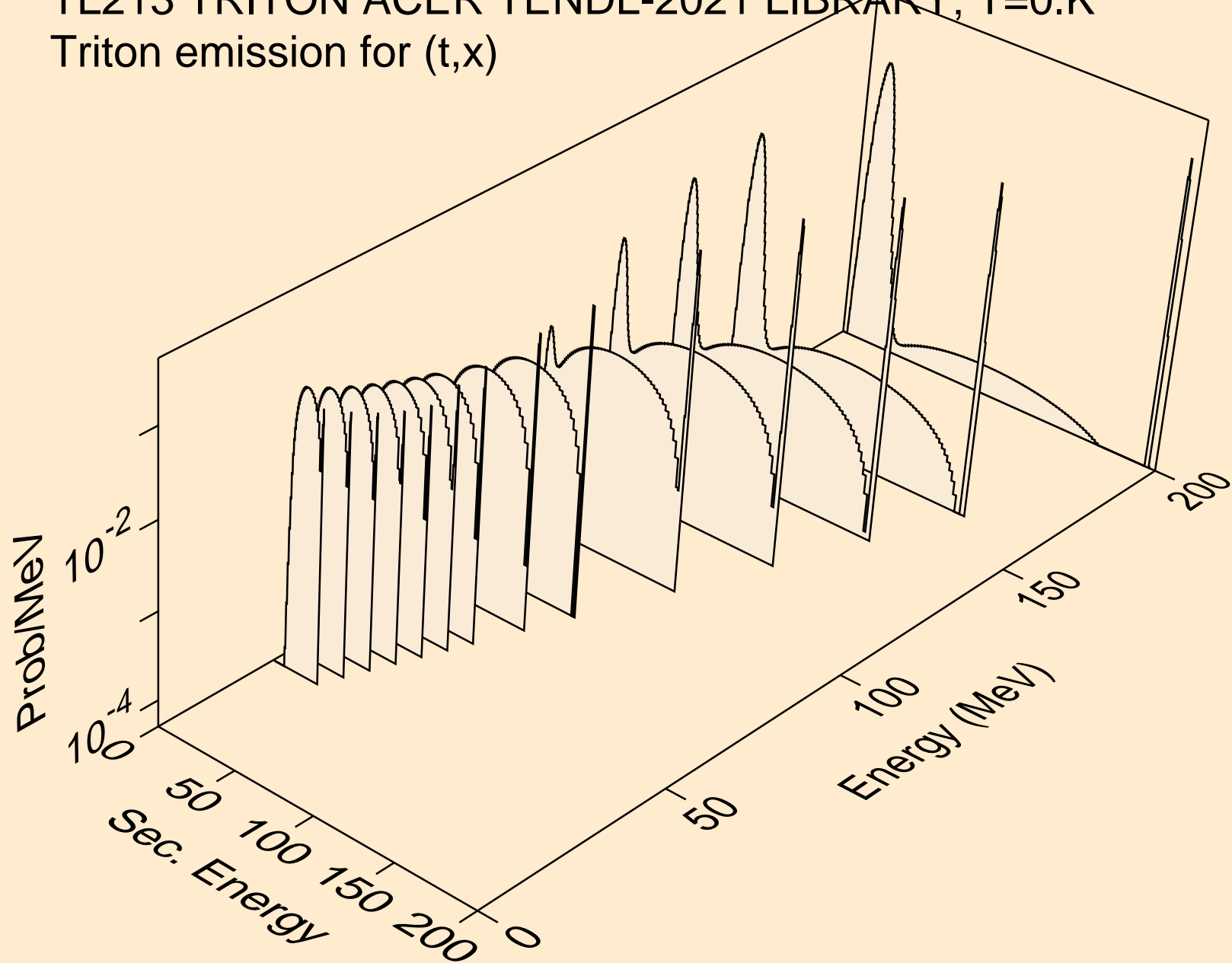

TL213 TRITON ACER TENDL-2021 LIBRARY; T=0.K
Triton emission for (t,n*)t

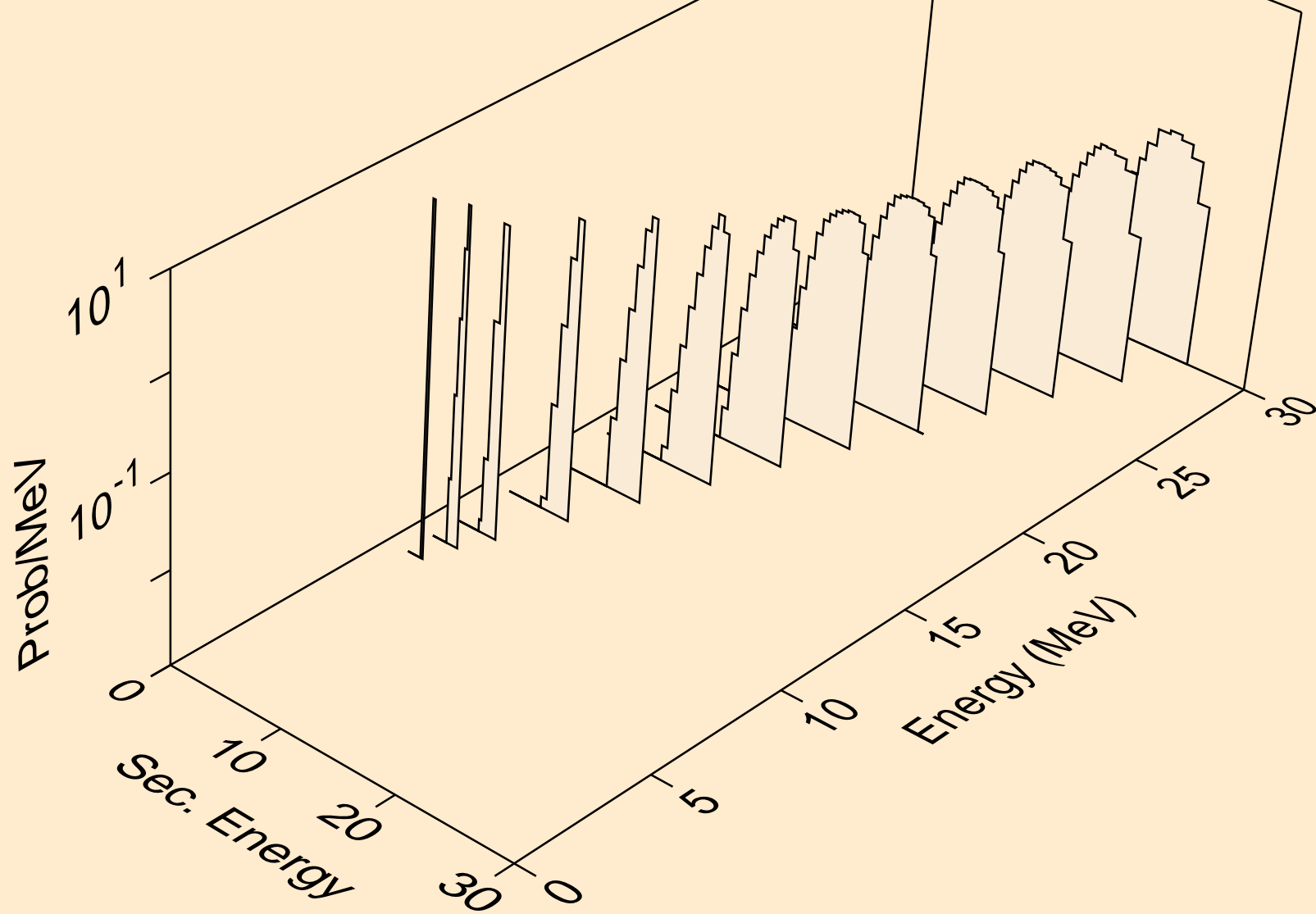

TL213 TRITON ACER TENDL-2021 LIBRARY; T=0.K
Triton emission for inelastic

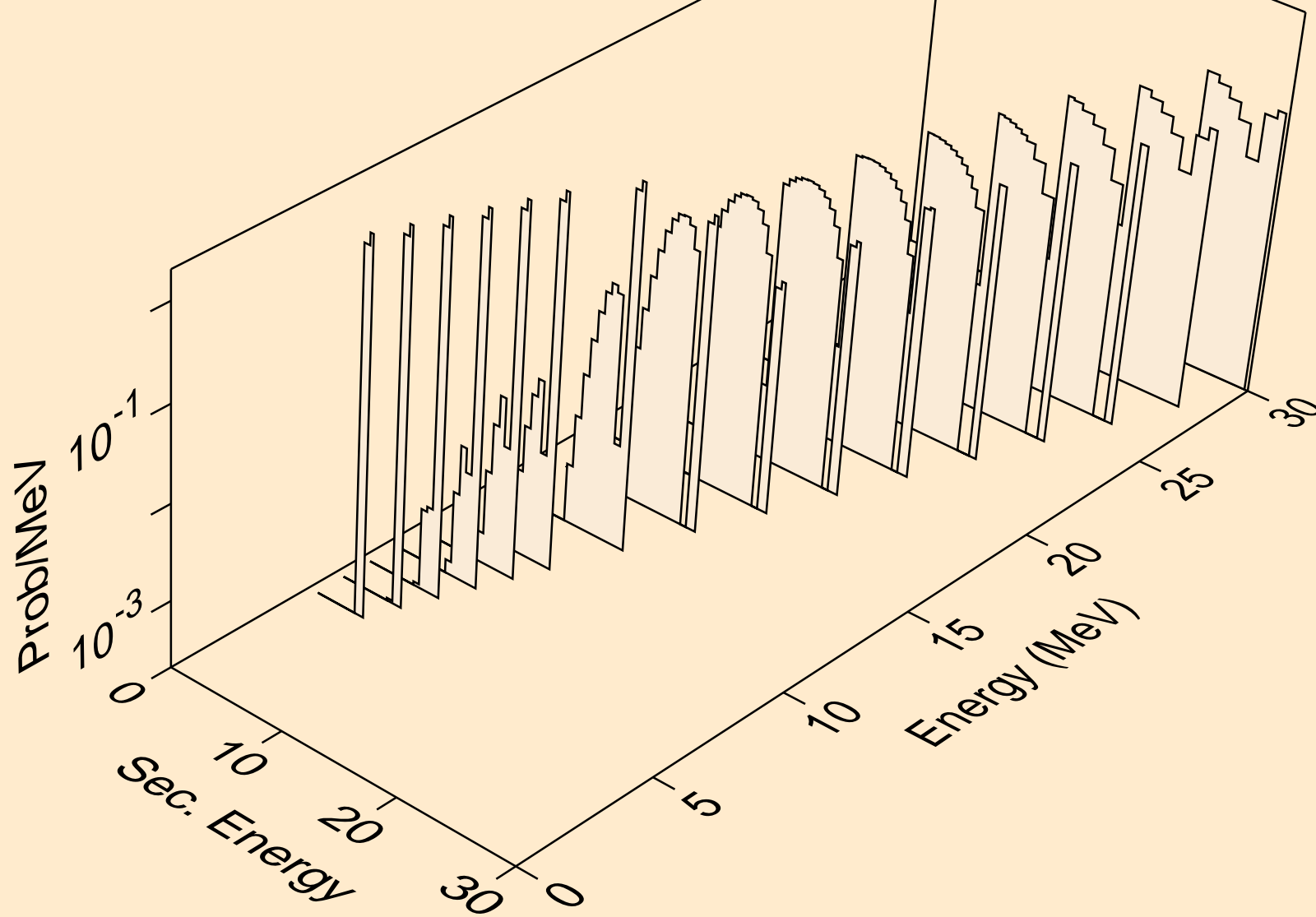

TL213 TRITON ACER TENDL-2021 LIBRARY; T=0.K
Photon emission for (z,n)

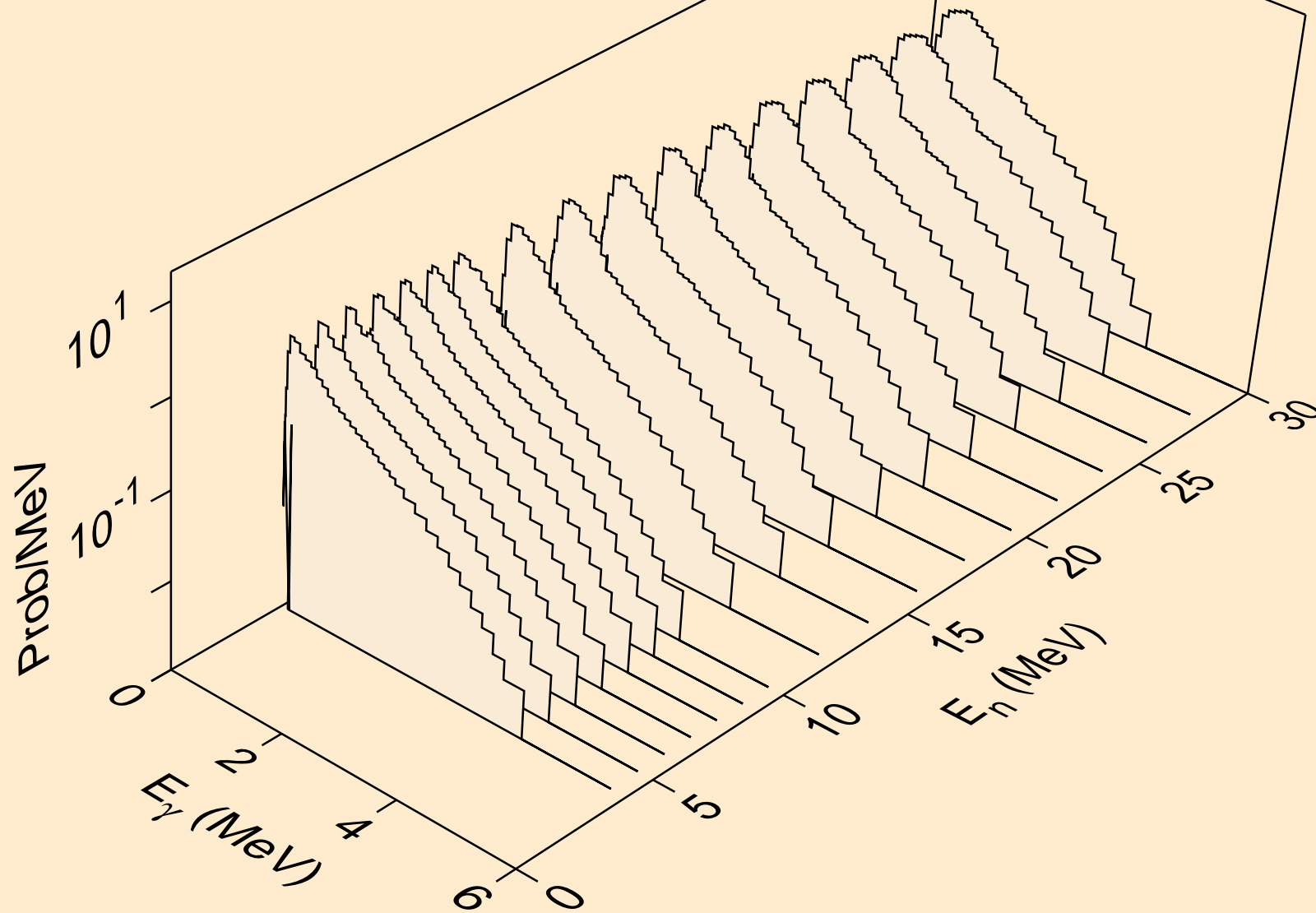

TL213 TRITON ACER TENDL-2021 LIBRARY; T=0.K
Photon emission for (n,x)

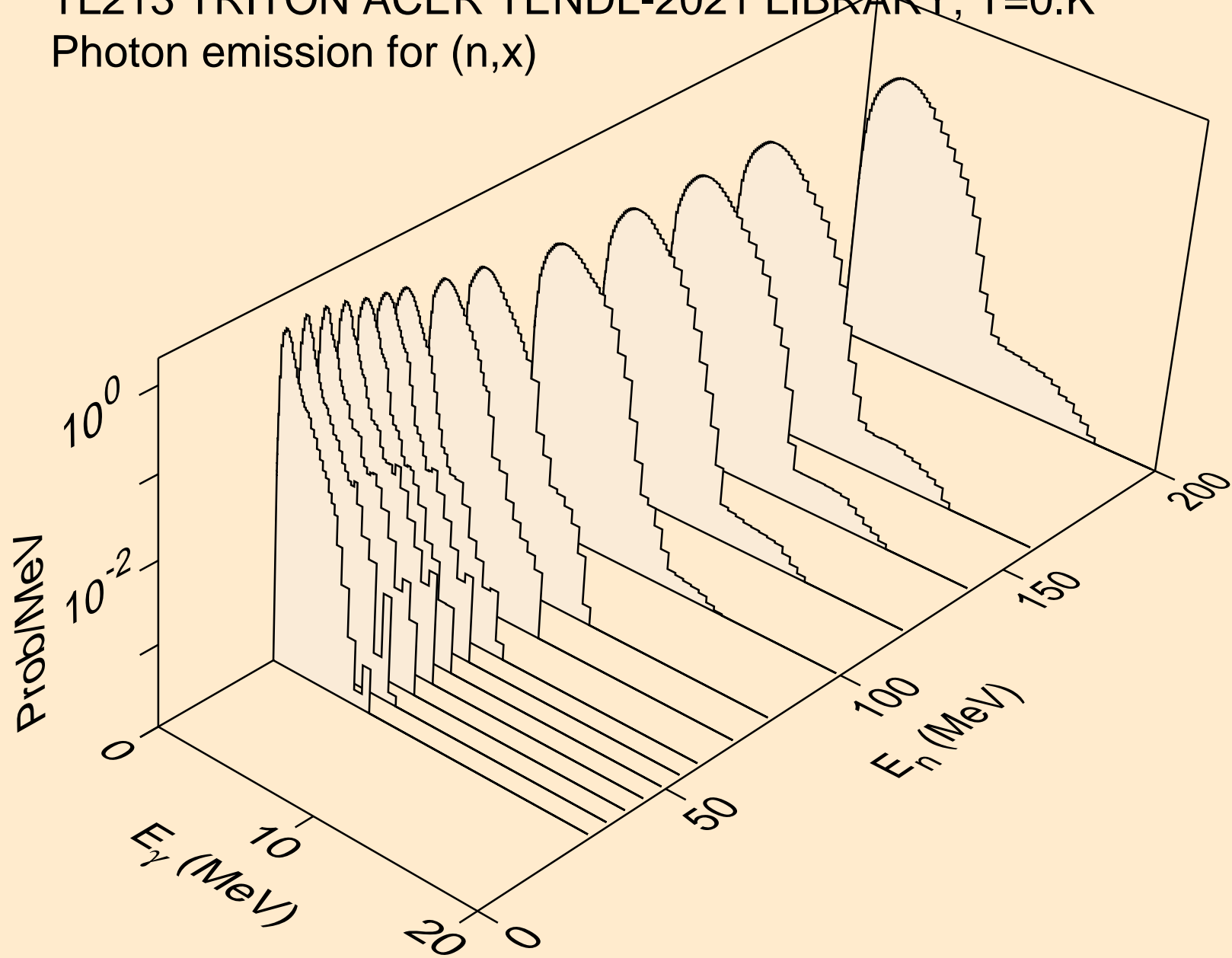

TL213 TRITON ACER TENDL-2021 LIBRARY; T=0.K
Photon emission for (n,2nd)

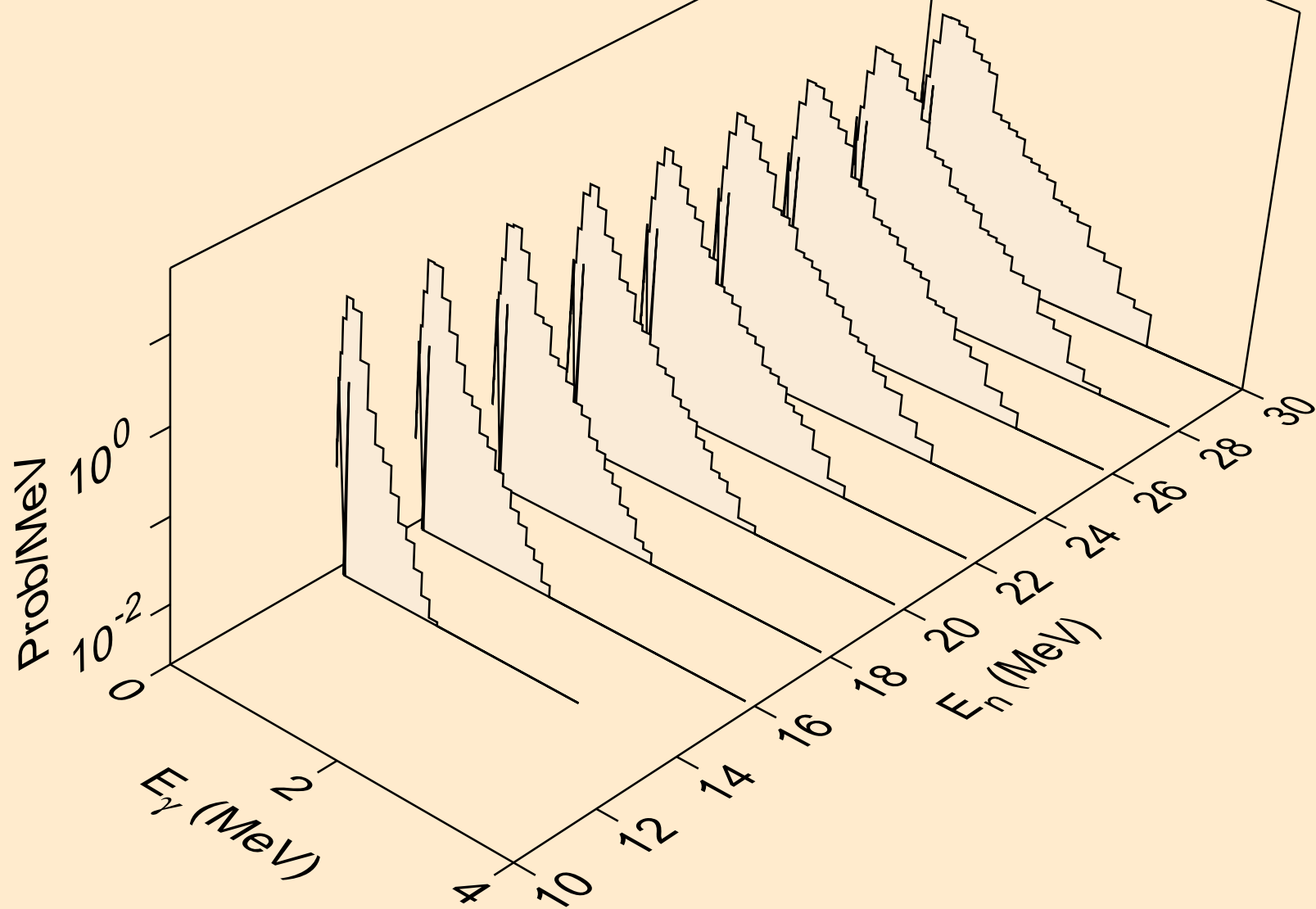

TL213 TRITON ACER TENDL-2021 LIBRARY; T=0.K
Photon emission for (n,2n)

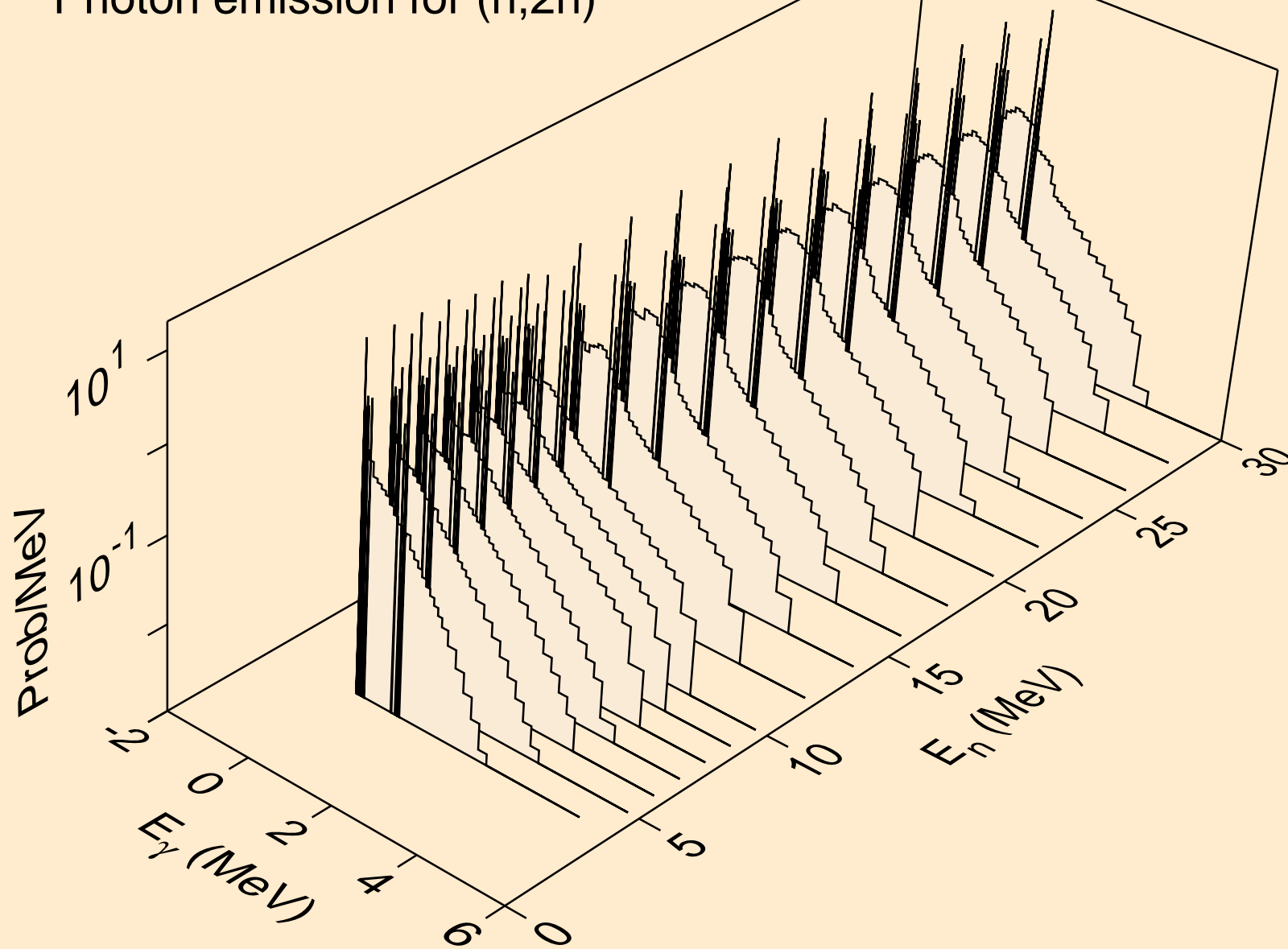

TL213 TRITON ACER TENDL-2021 LIBRARY; T=0.K
Photon emission for (n,3n)

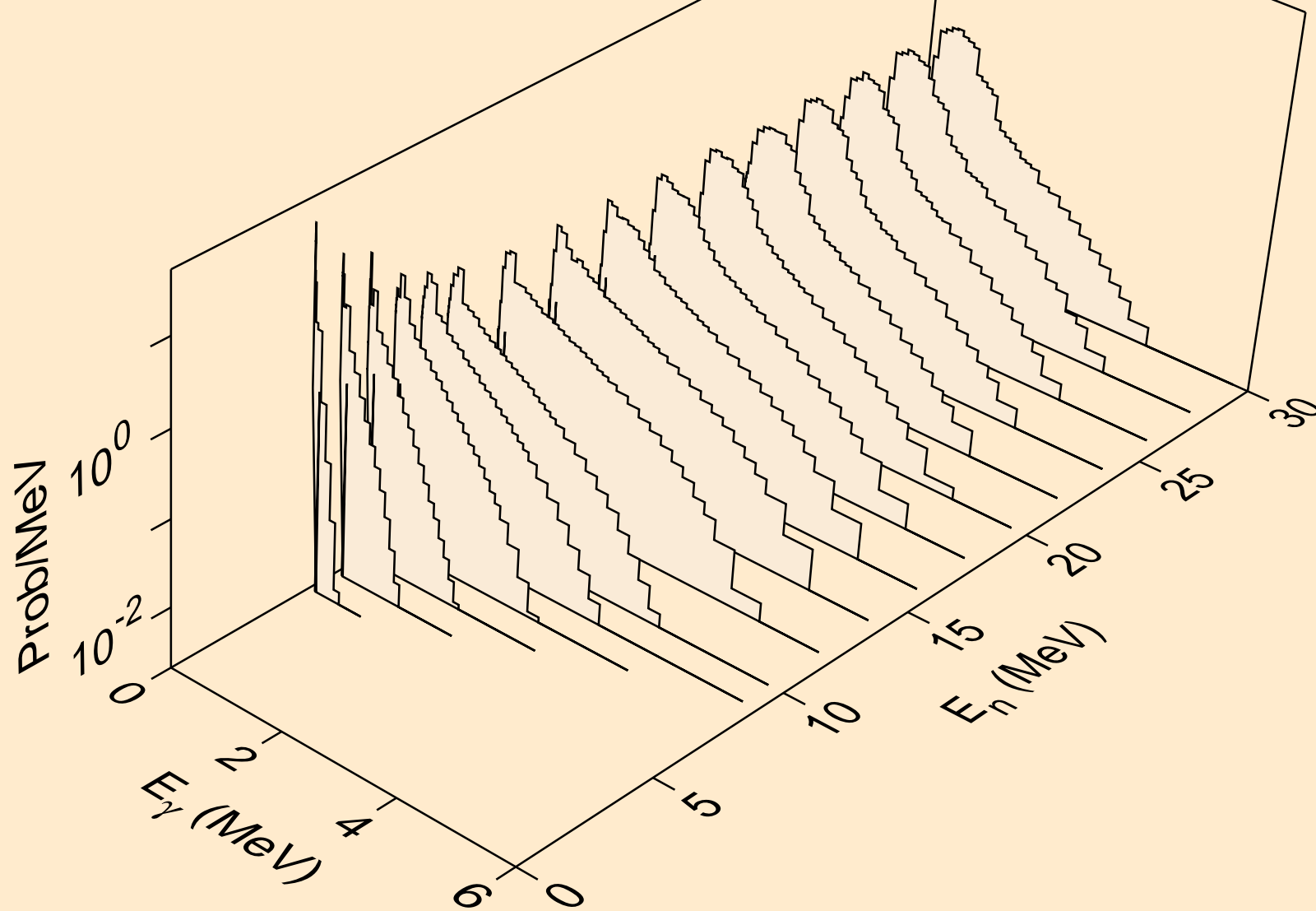

TL213 TRITON ACER TENDL-2021 LIBRARY; T=0.K
Photon emission for (n,n*)a

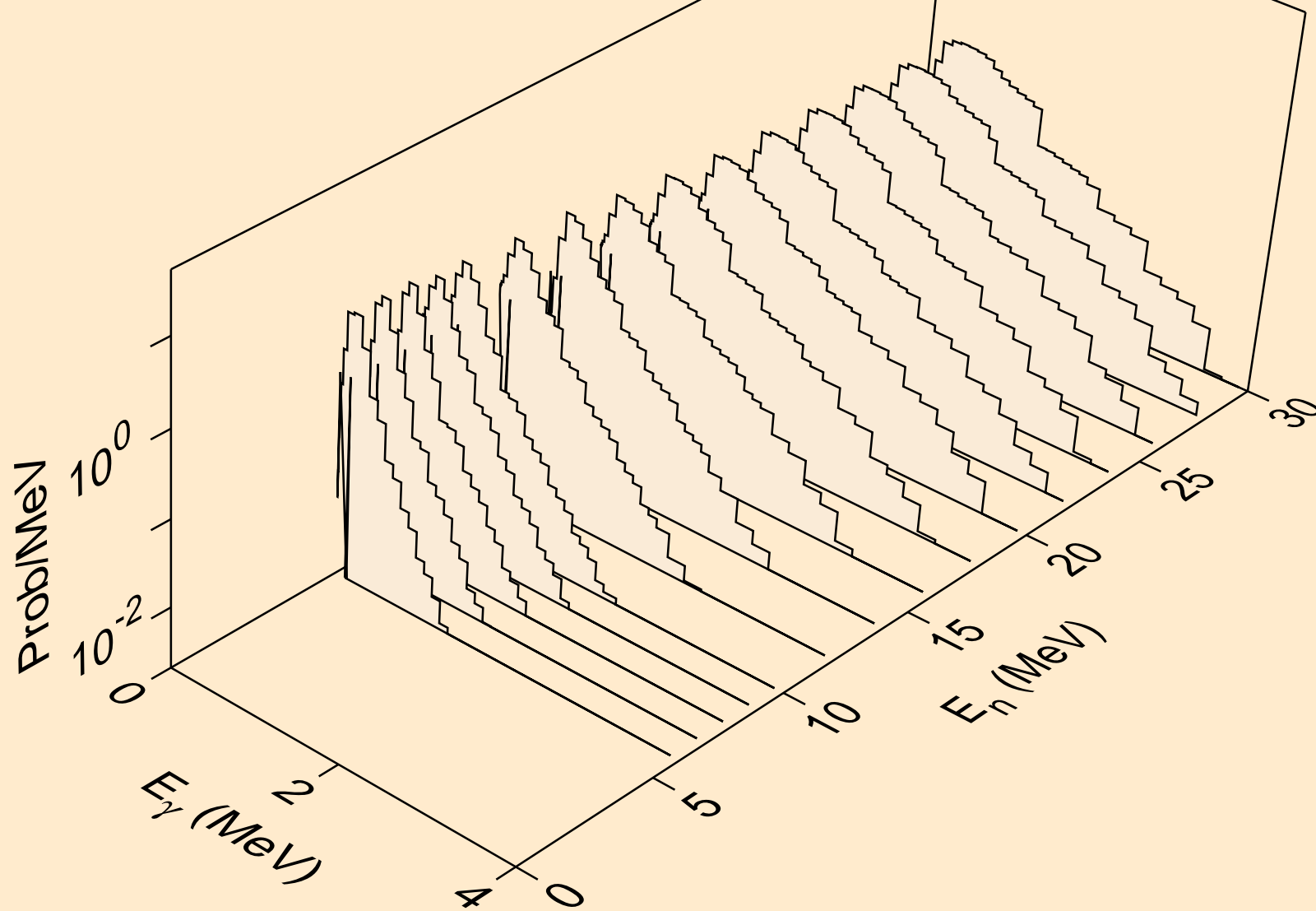

TL213 TRITON ACER TENDL-2021 LIBRARY; T=0.K
Photon emission for (n,2n)a

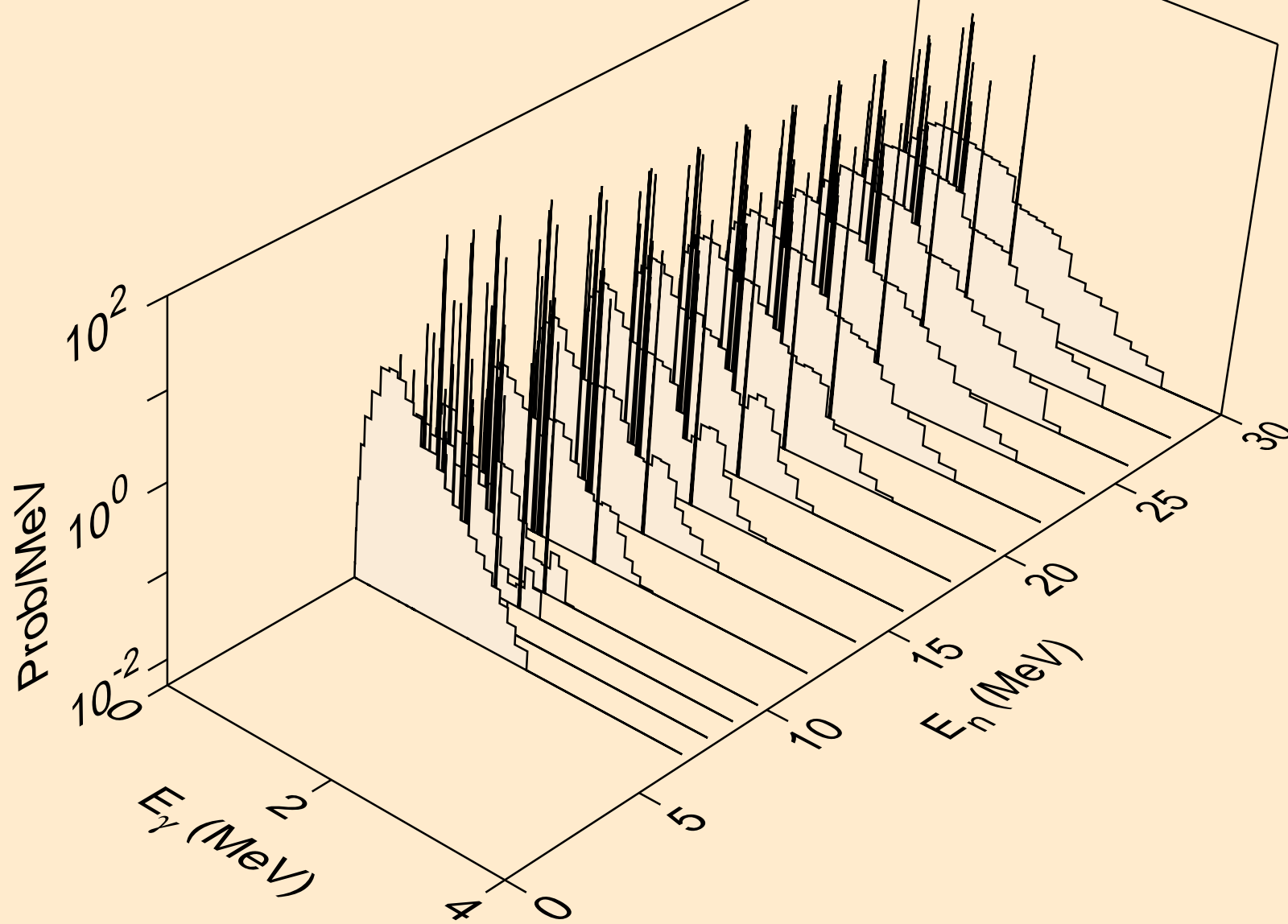

TL213 TRITON ACER TENDL-2021 LIBRARY; T=0.K
Photon emission for (n,3n)a

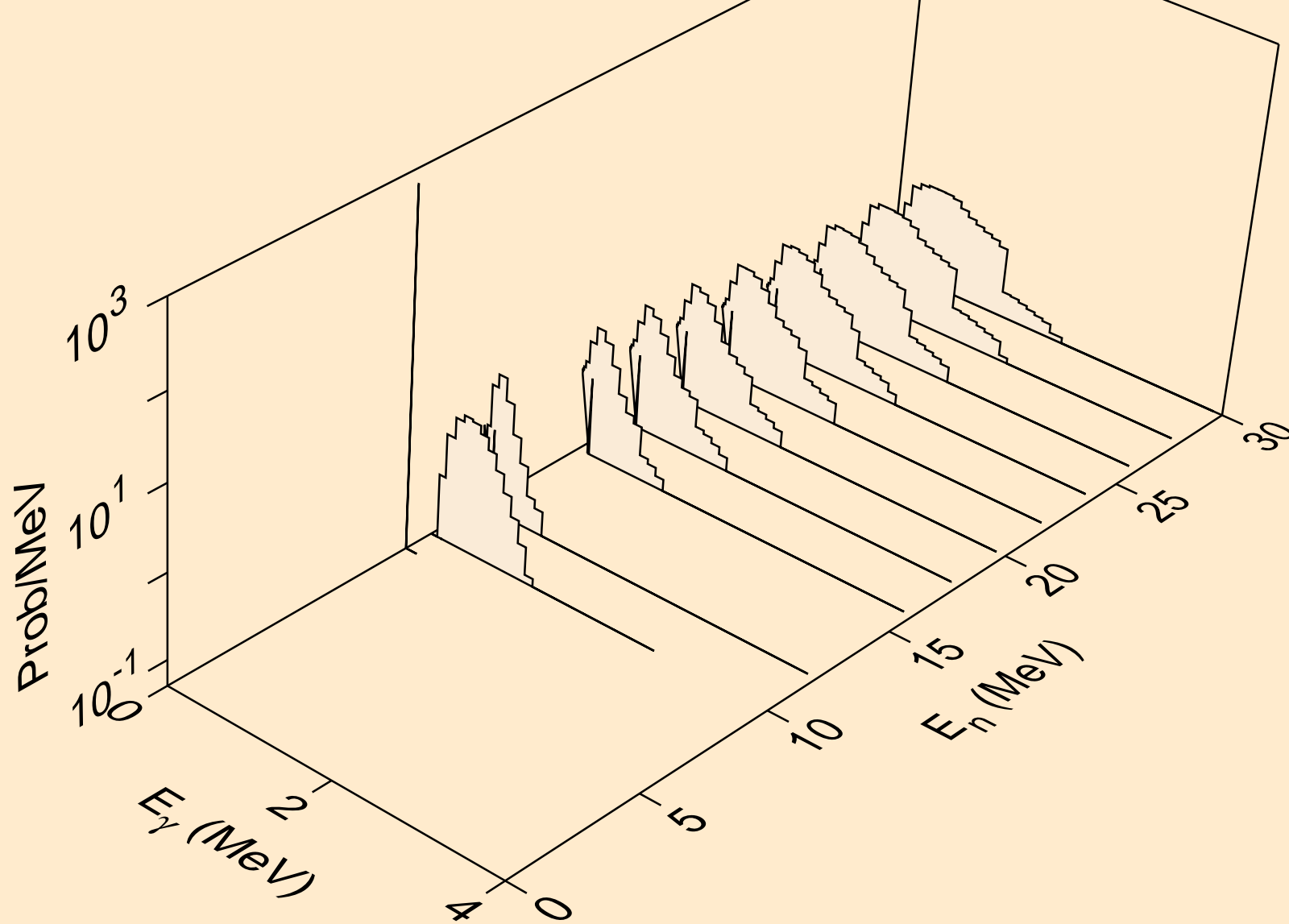

TL213 TRITON ACER TENDL-2021 LIBRARY; T=0.K
Photon emission for (n,n*)p

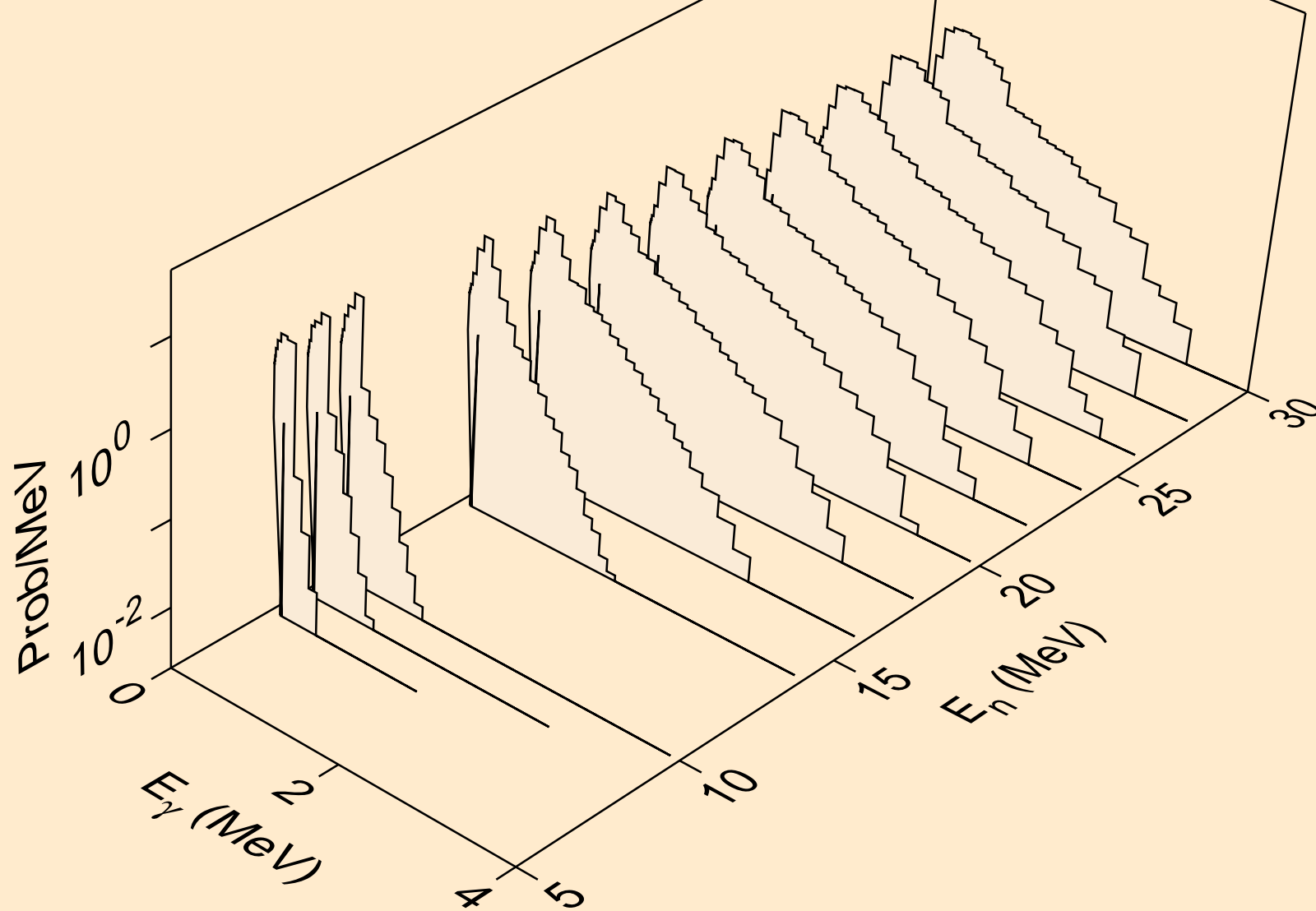

TL213 TRITON ACER TENDL-2021 LIBRARY; T=0.K
Photon emission for (n,n*)d

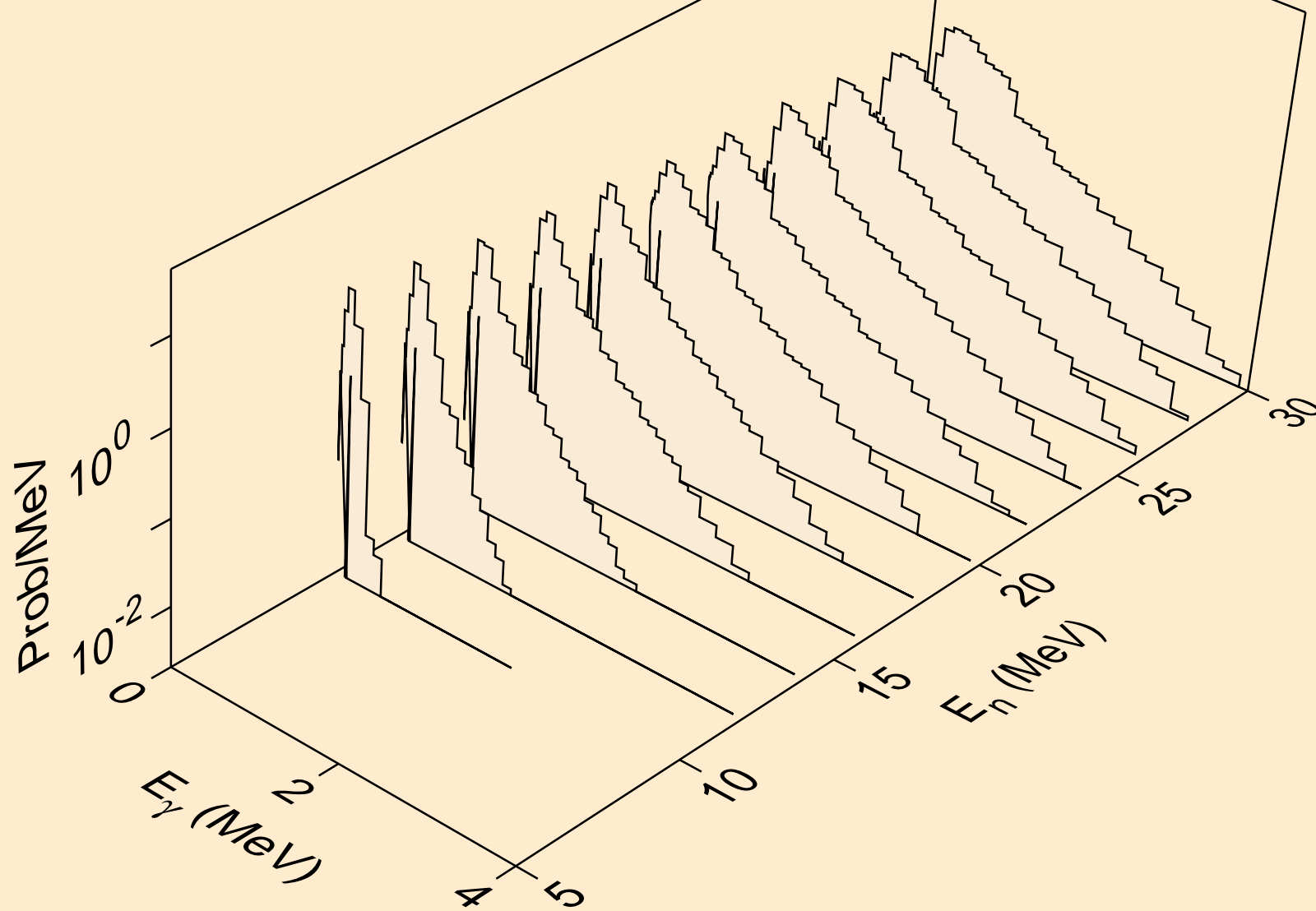

TL213 TRITON ACER TENDL-2021 LIBRARY; T=0.K
Photon emission for (n,n*)t

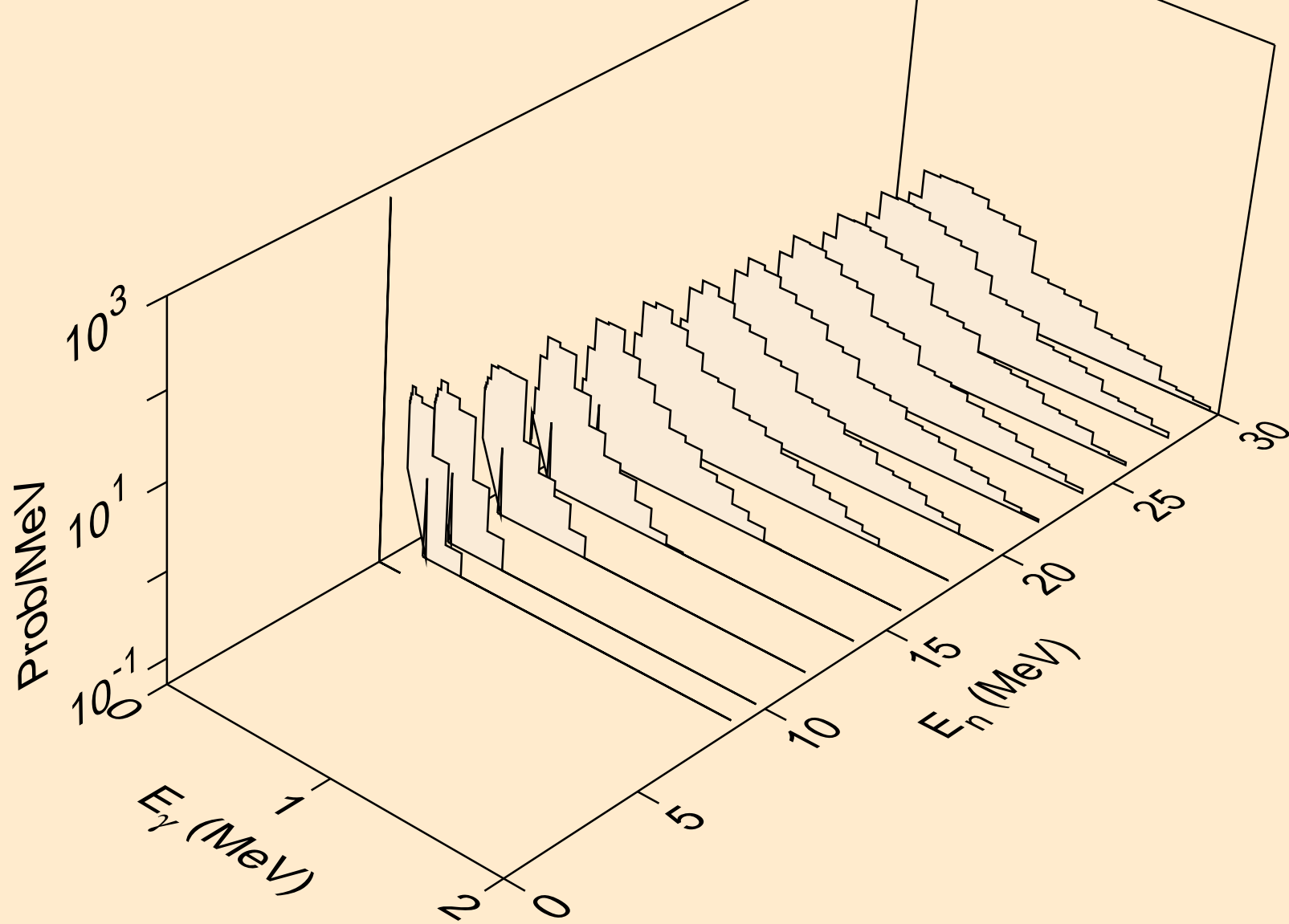

TL213 TRITON ACER TENDL-2021 LIBRARY; T=0.K
Photon emission for (n,n*)he3

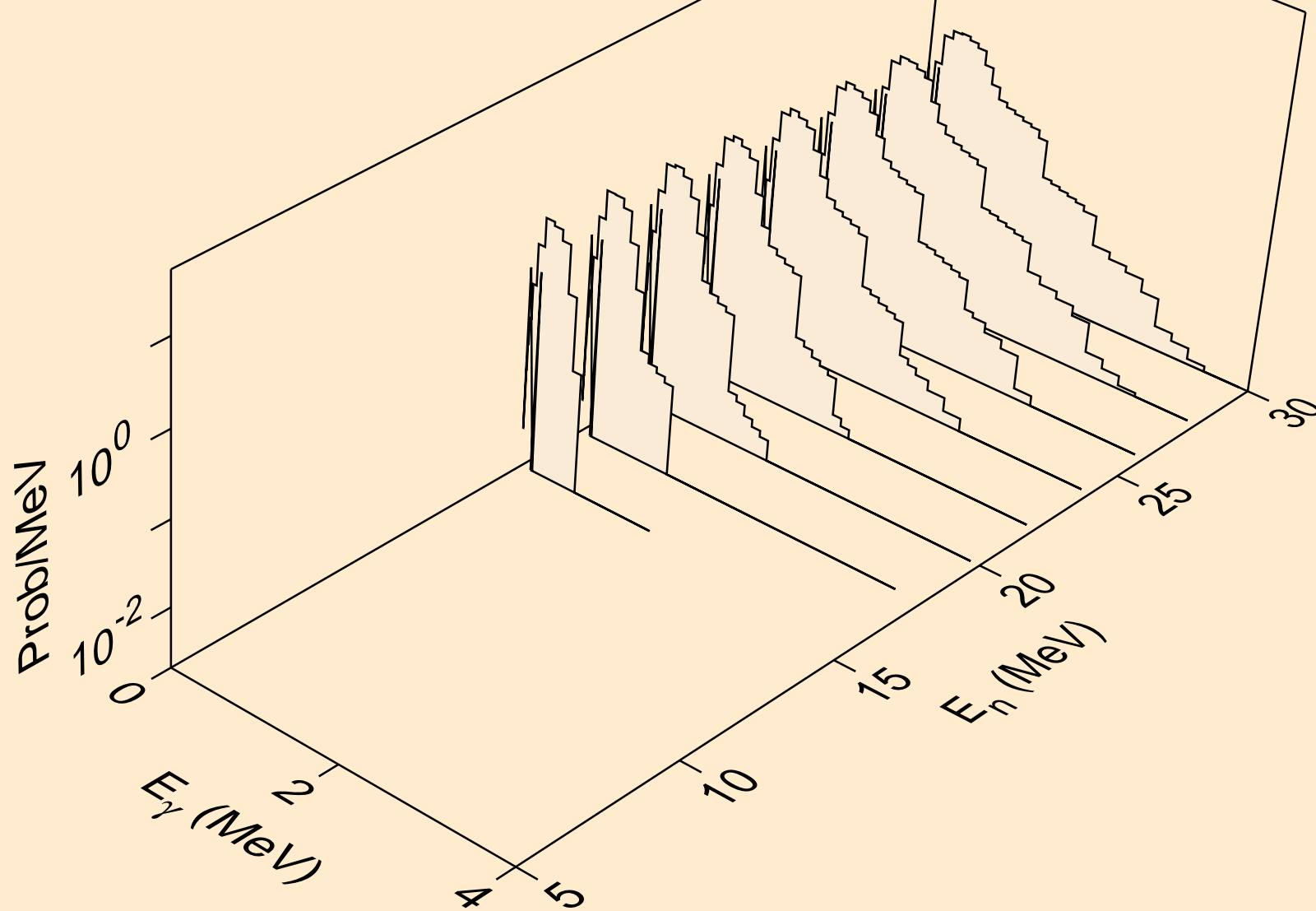

TL213 TRITON ACER TENDL-2021 LIBRARY; T=0.K
Photon emission for (n,4n)

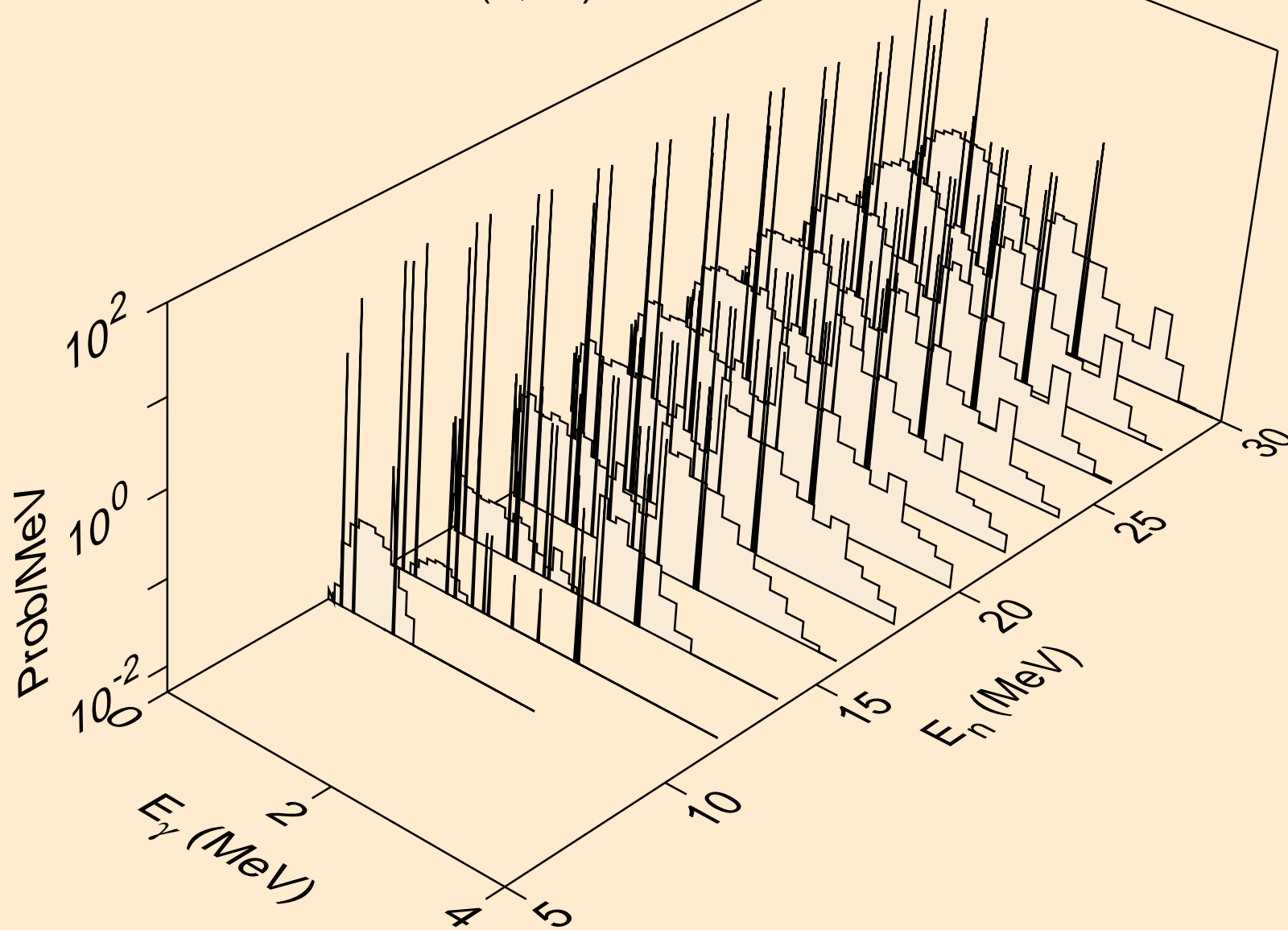

TL213 TRITON ACER TENDL-2021 LIBRARY; T=0.K
Photon emission for (n,2np)

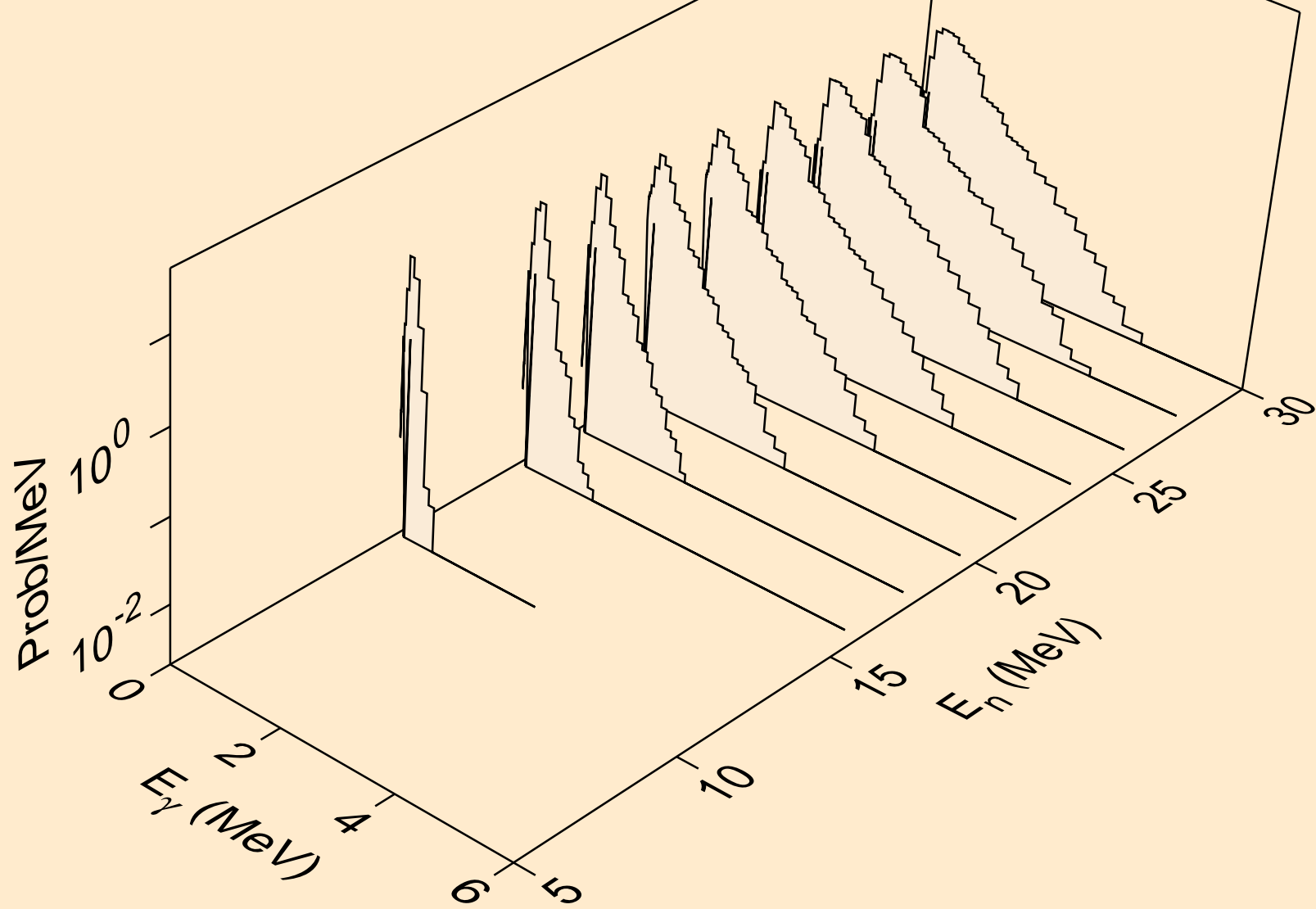

TL213 TRITON ACER TENDL-2021 LIBRARY; T=0.K
Photon emission for (n,3np)

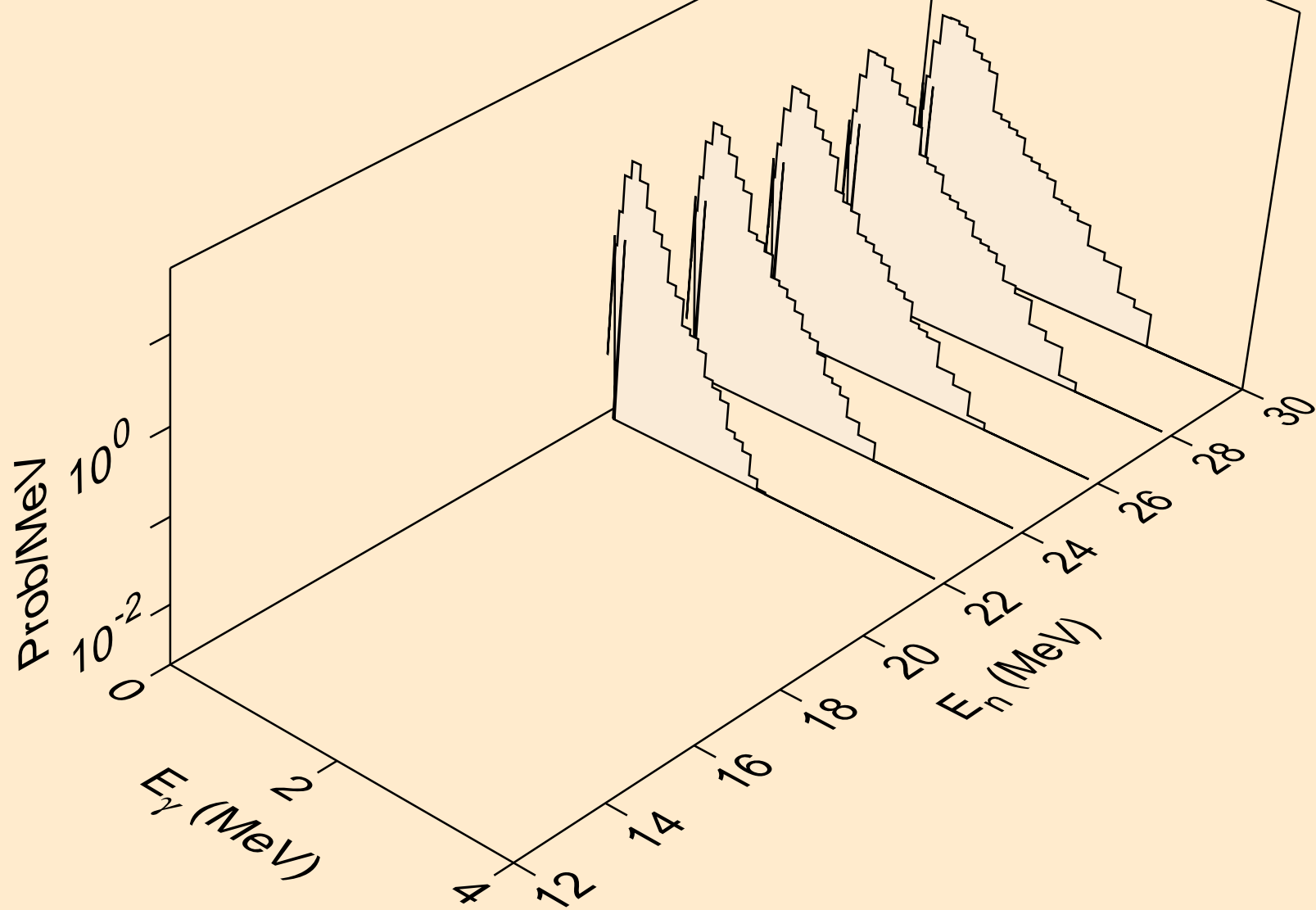

TL213 TRITON ACER TENDL-2021 LIBRARY; T=0.K
Photon emission for (n,2np)

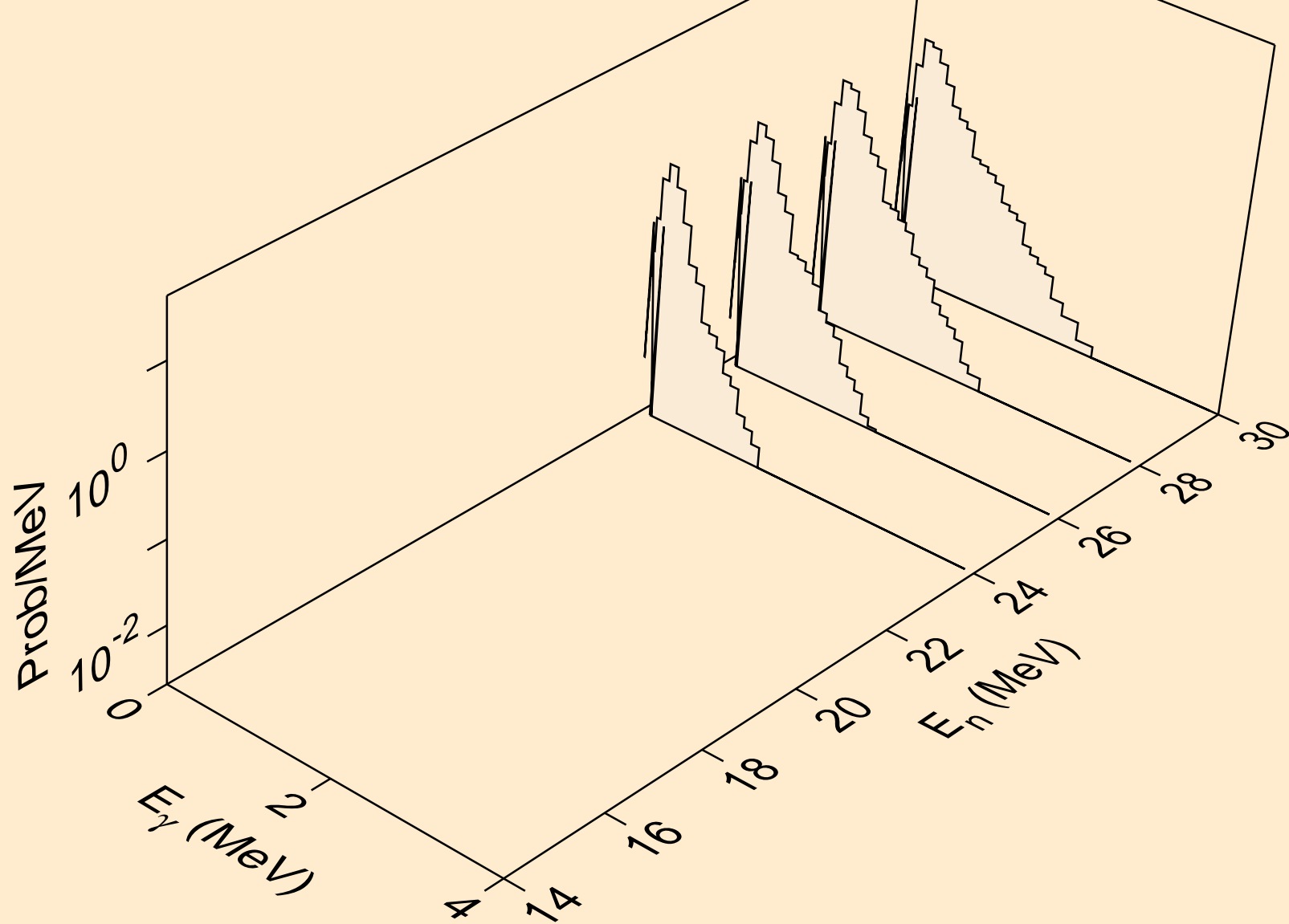

TL213 TRITON ACER TENDL-2021 LIBRARY; T=0.K
Photon emission for (n,gma)

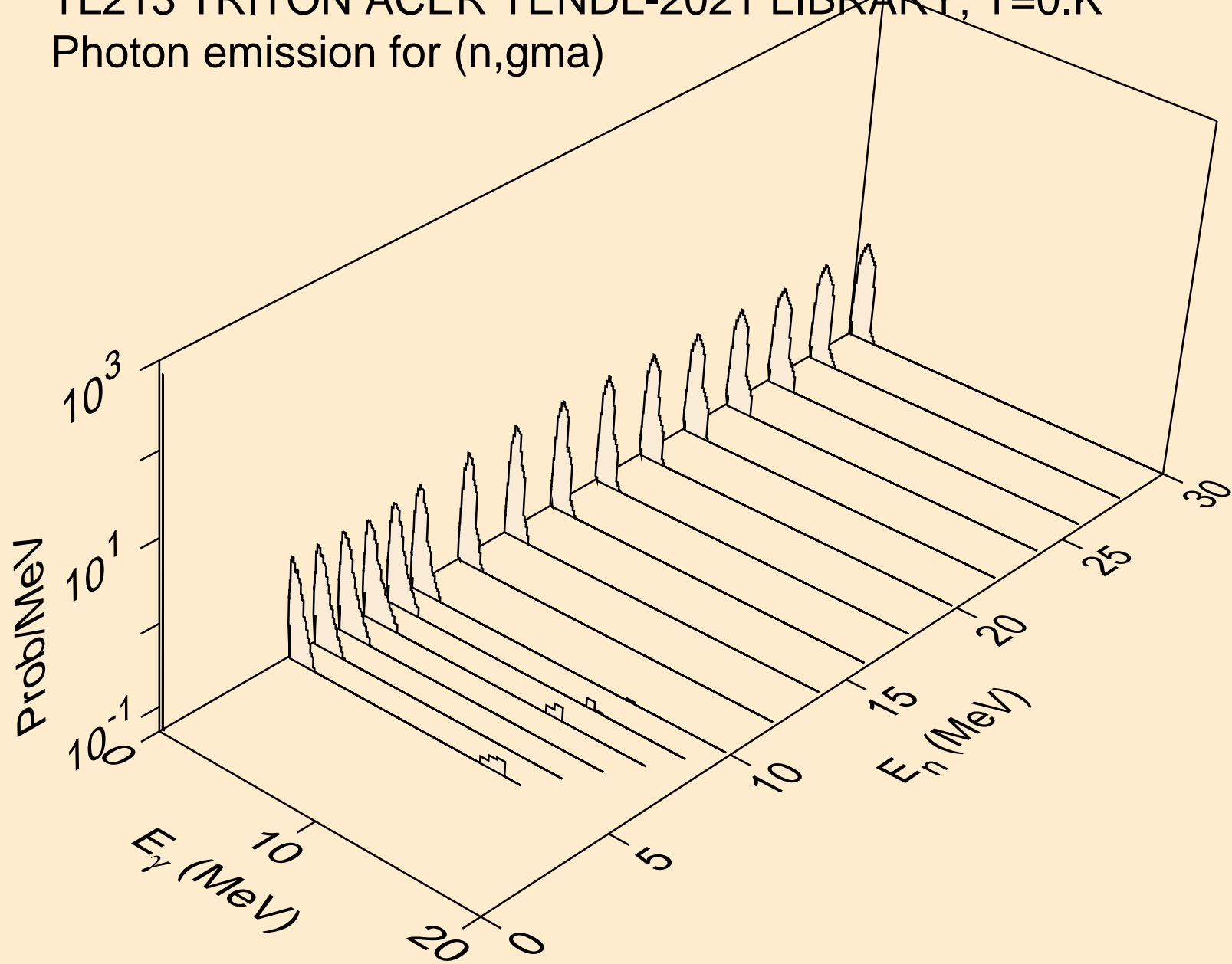

TL213 TRITON ACER TENDL-2021 LIBRARY; T=0.K
Photon emission for (n,p)

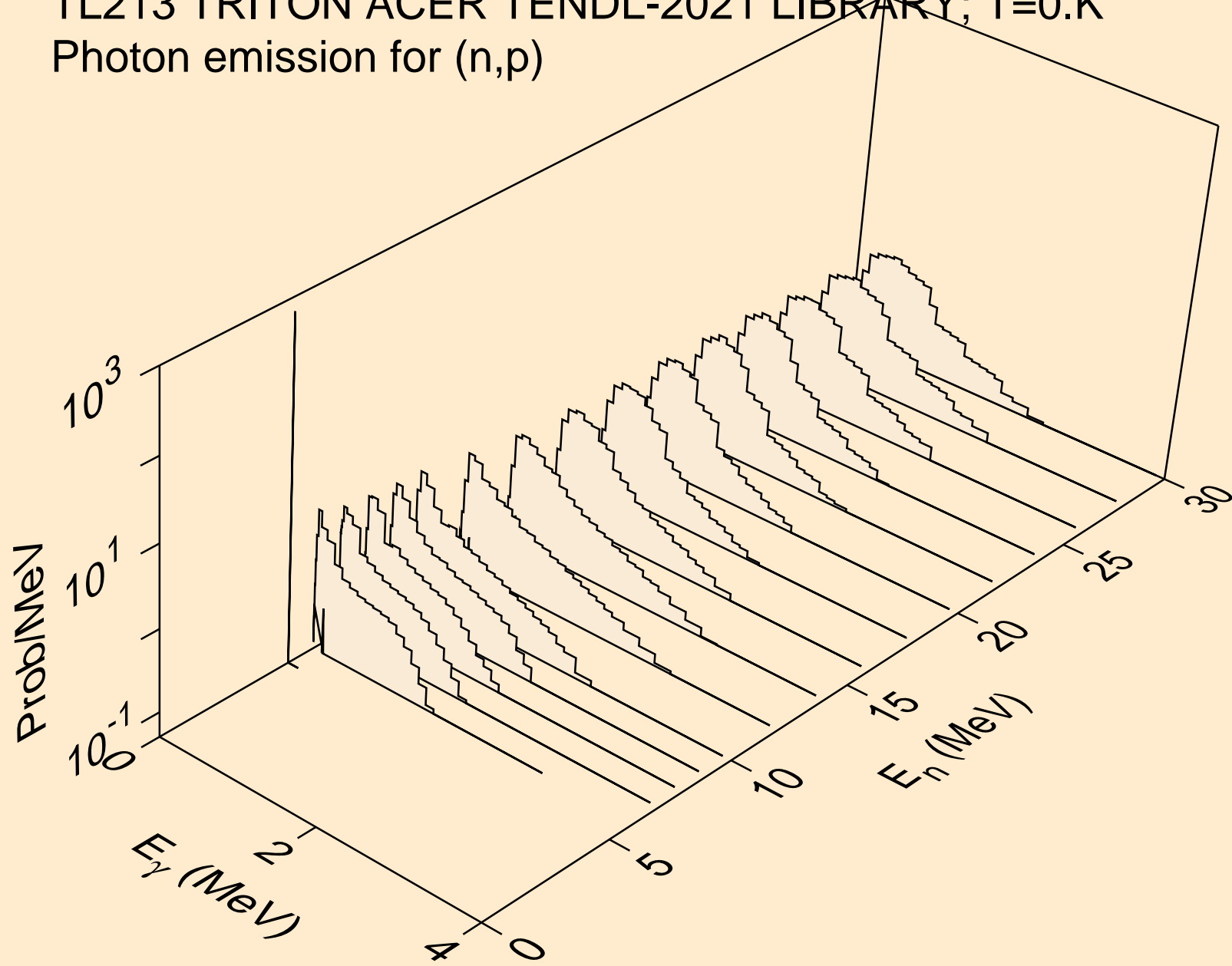

TL213 TRITON ACER TENDL-2021 LIBRARY; T=0.K
Photon emission for (n,d)

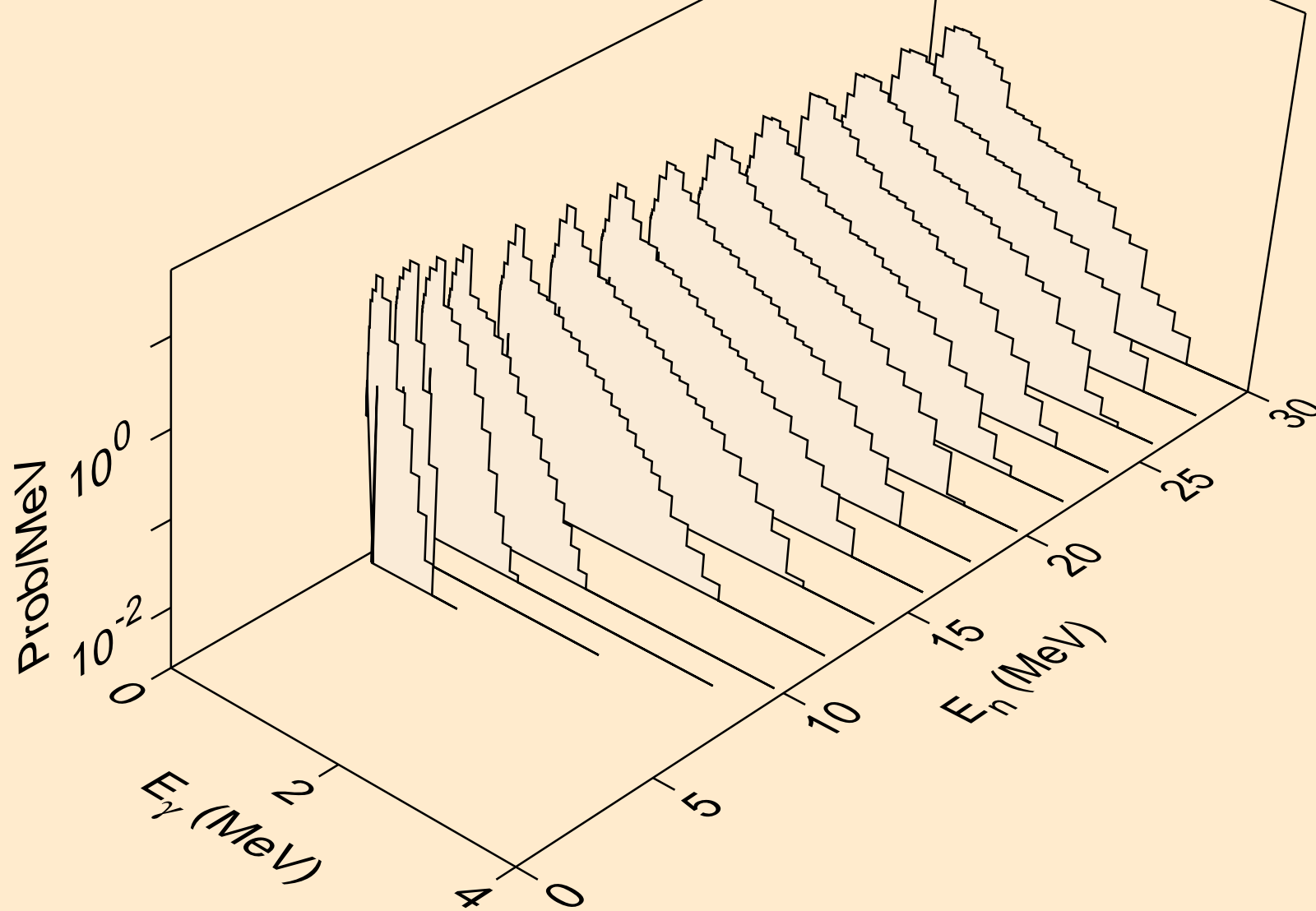

TL213 TRITON ACER TENDL-2021 LIBRARY; T=0.K
Photon emission for inelastic

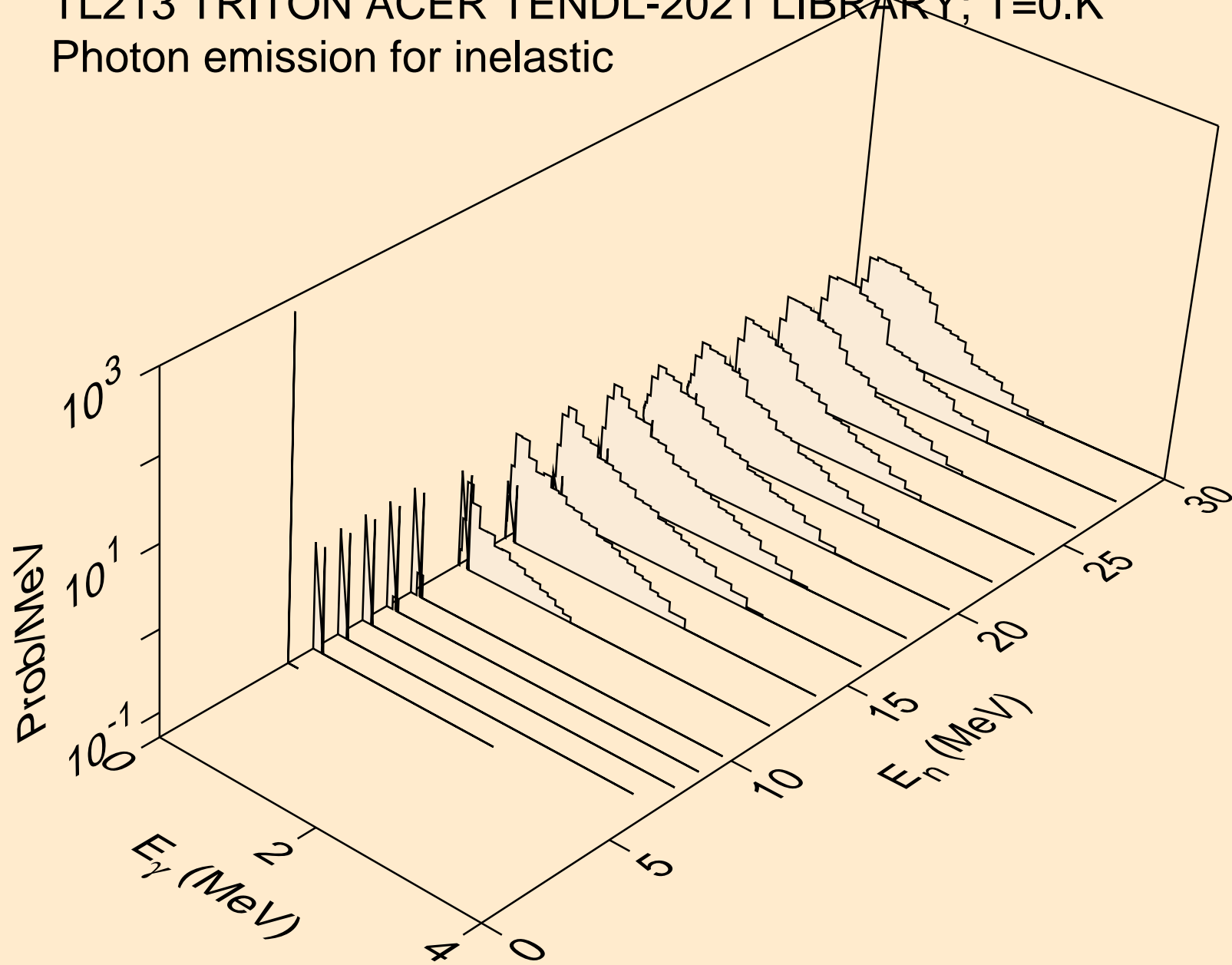

TL213 TRITON ACER TENDL-2021 LIBRARY; T=0.K
Photon emission for (n,he3)

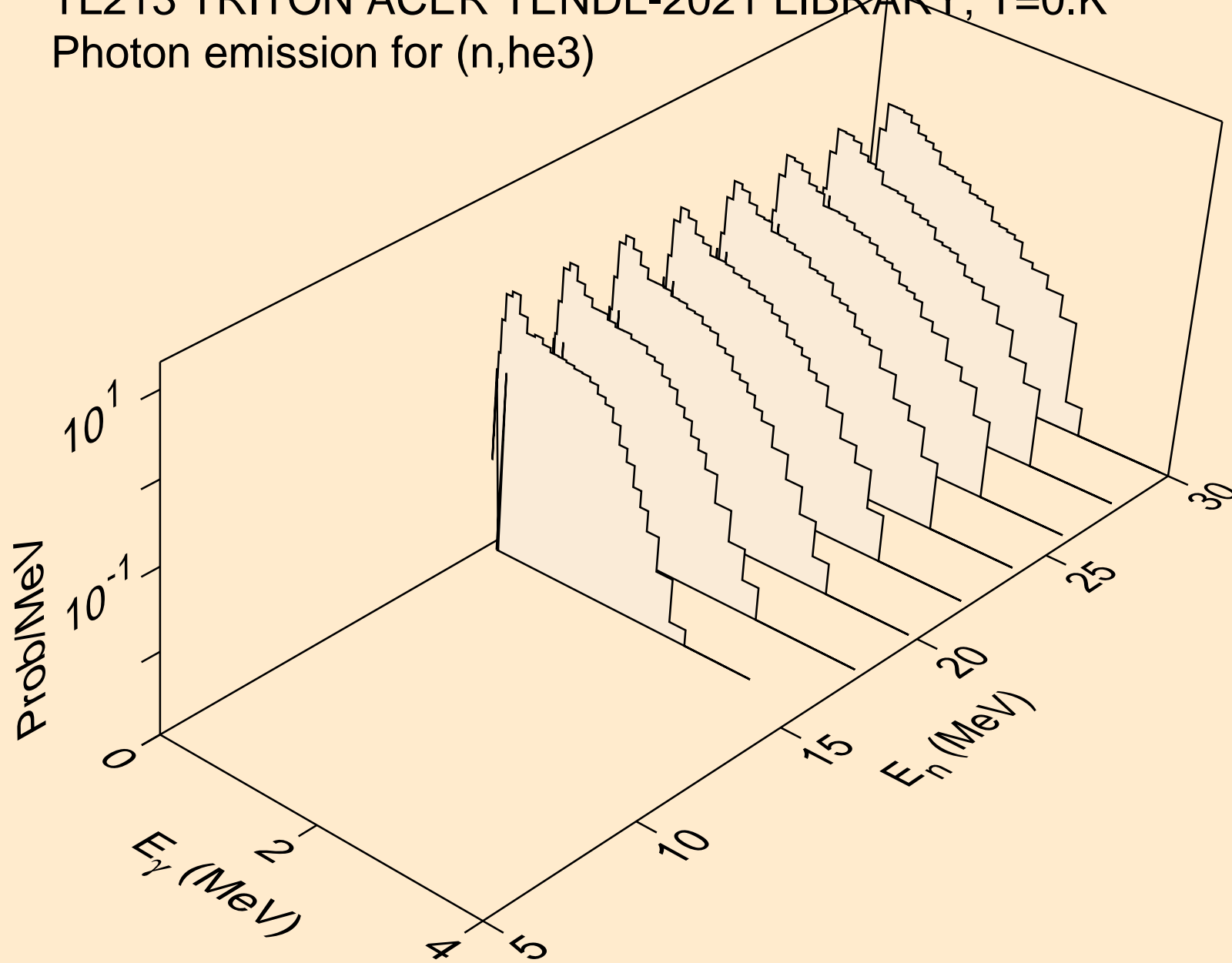

TL213 TRITON ACER TENDL-2021 LIBRARY; T=0.K
Photon emission for (n,a)

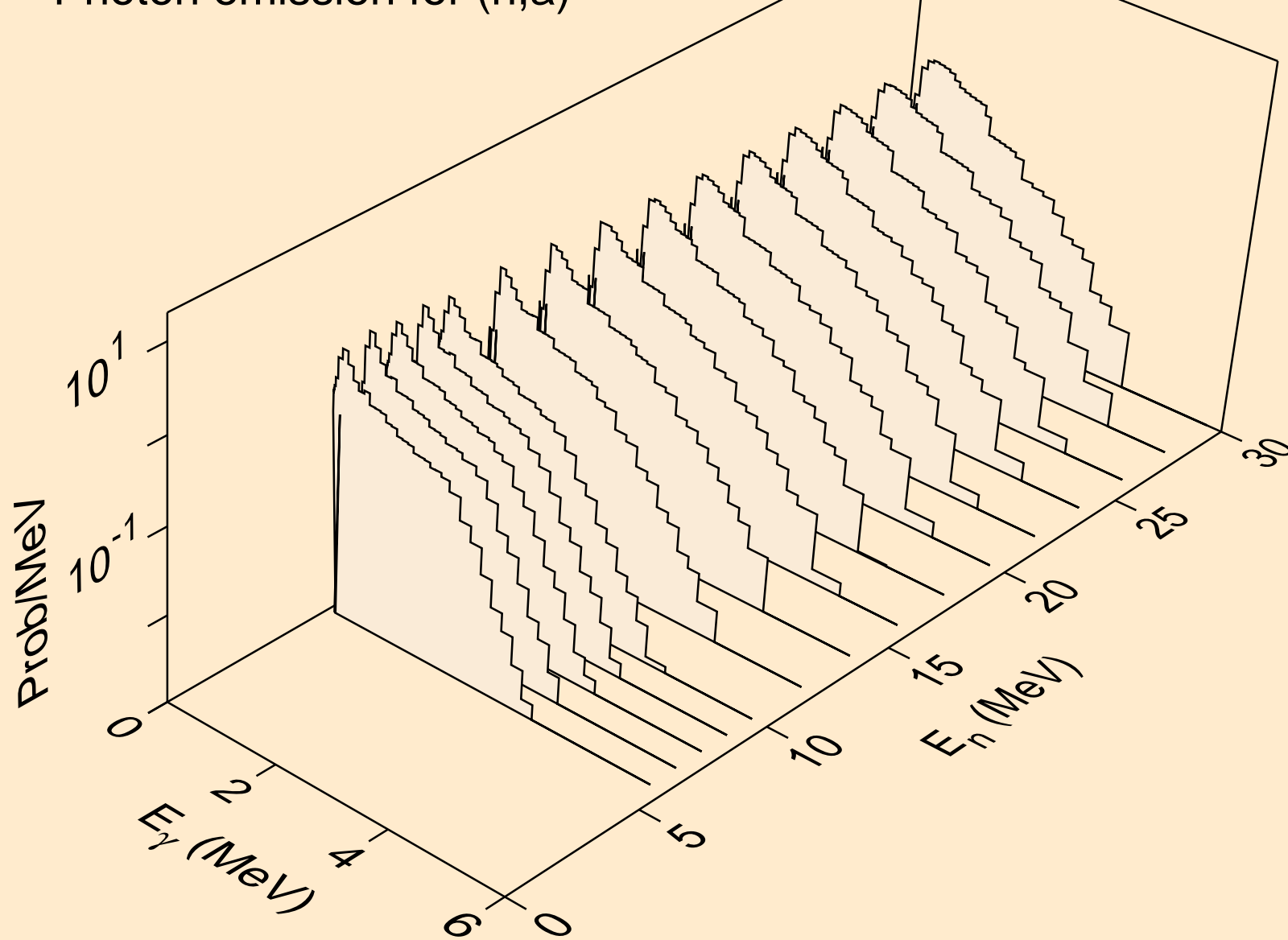

TL213 TRITON ACER TENDL-2021 LIBRARY; T=0.K
Photon emission for (n,2p)

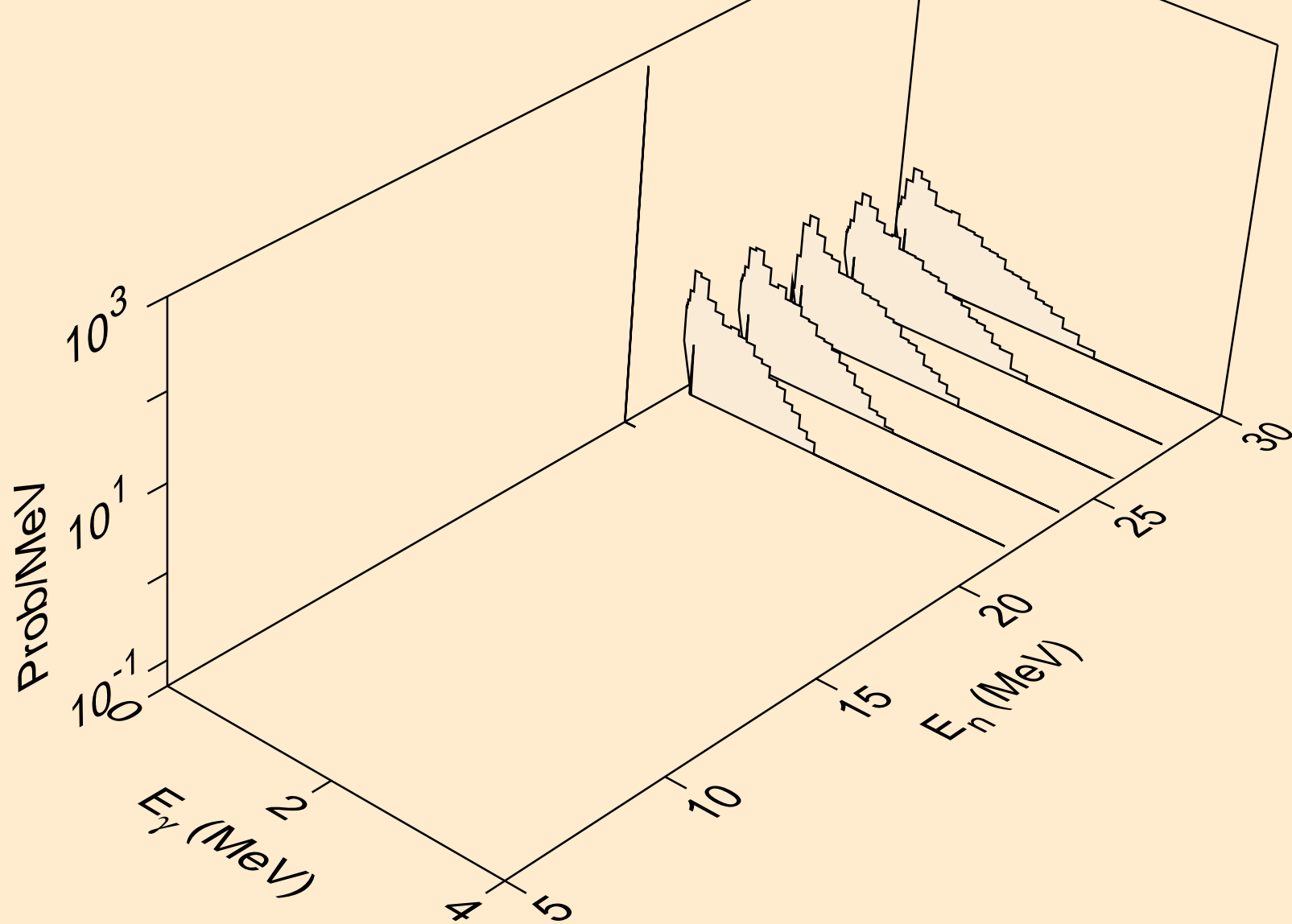

TL213 TRITON ACER TENDL-2021 LIBRARY; T=0.K
Particle heating contributions

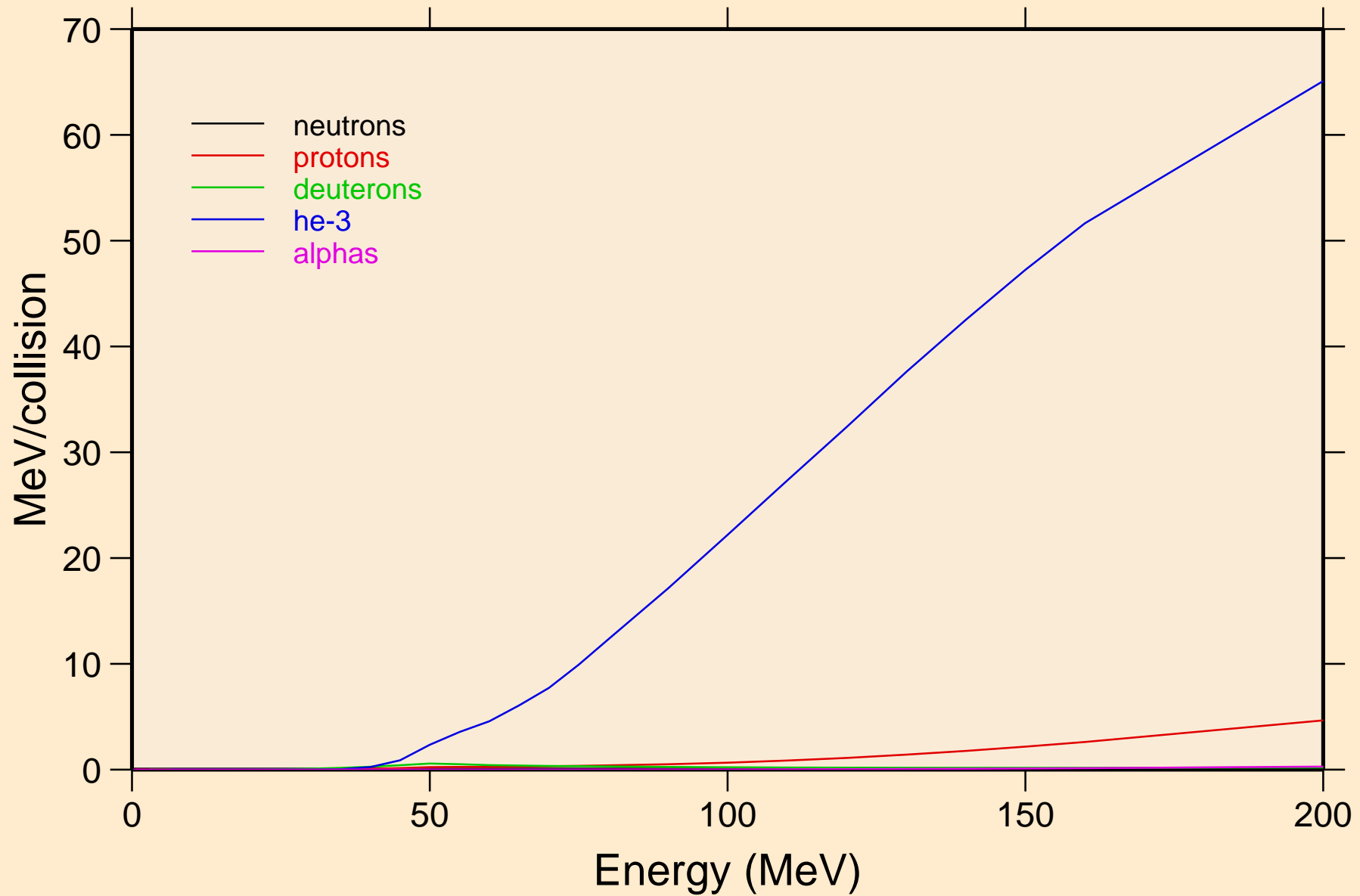

TL213 TRITON ACER TENDL-2021 LIBRARY; T=0.K
Recoil Heating

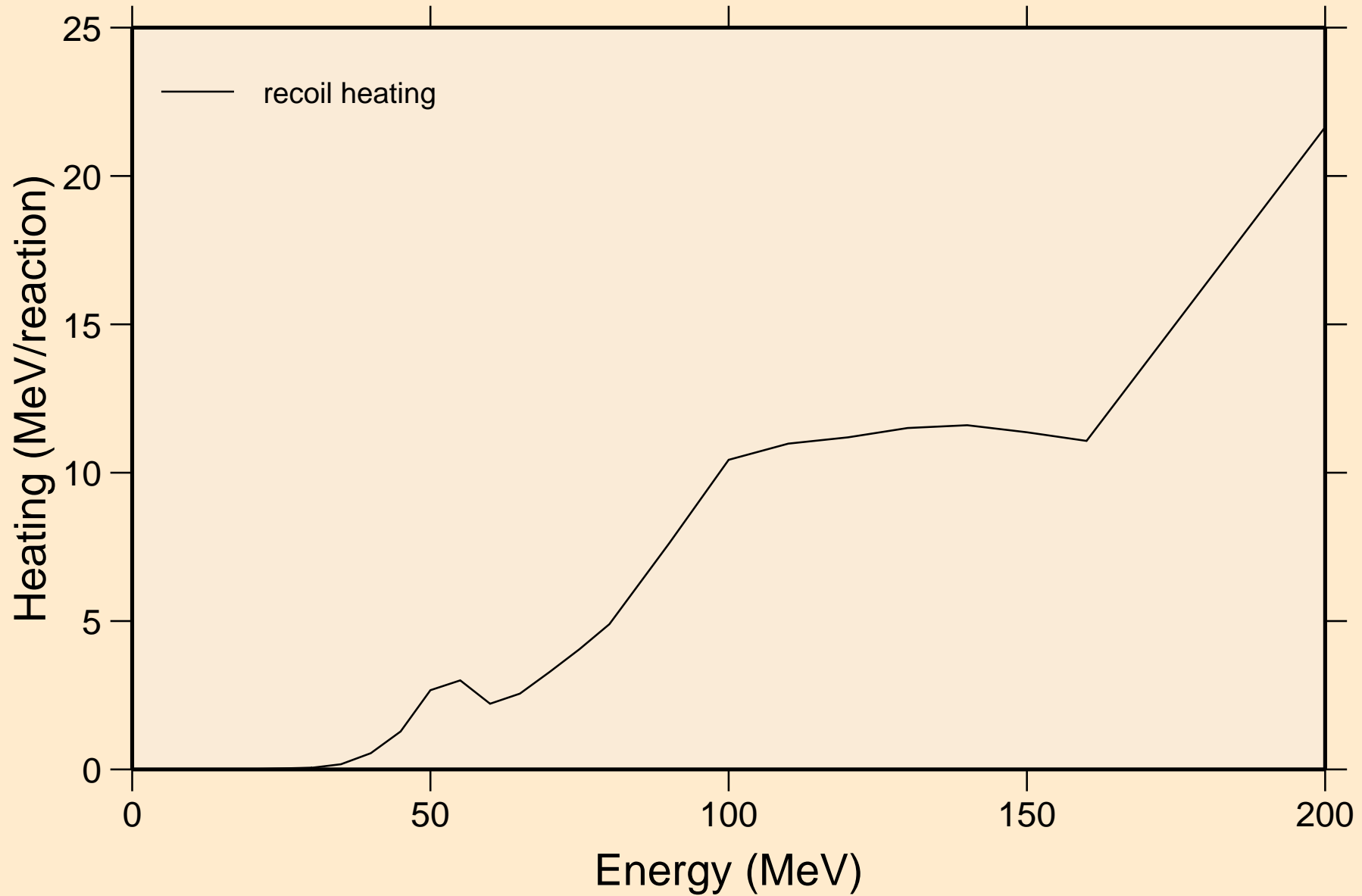

TL213 TRITON ACER TENDL-2021 LIBRARY; T=0.K
Particle production cross sections

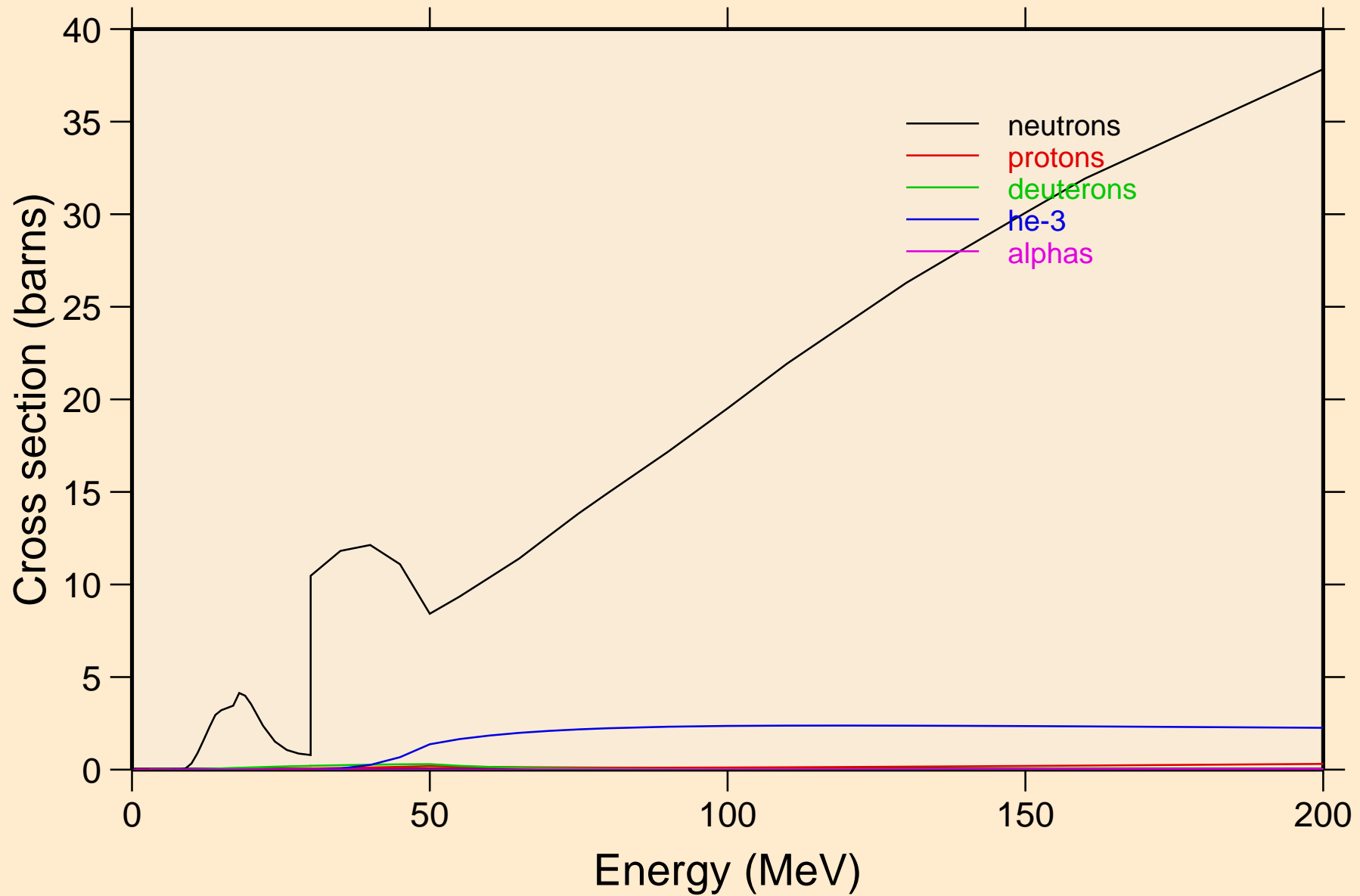

TL213 TRITON ACER TENDL-2021 LIBRARY; T=0.K
neutrons from (t,n)

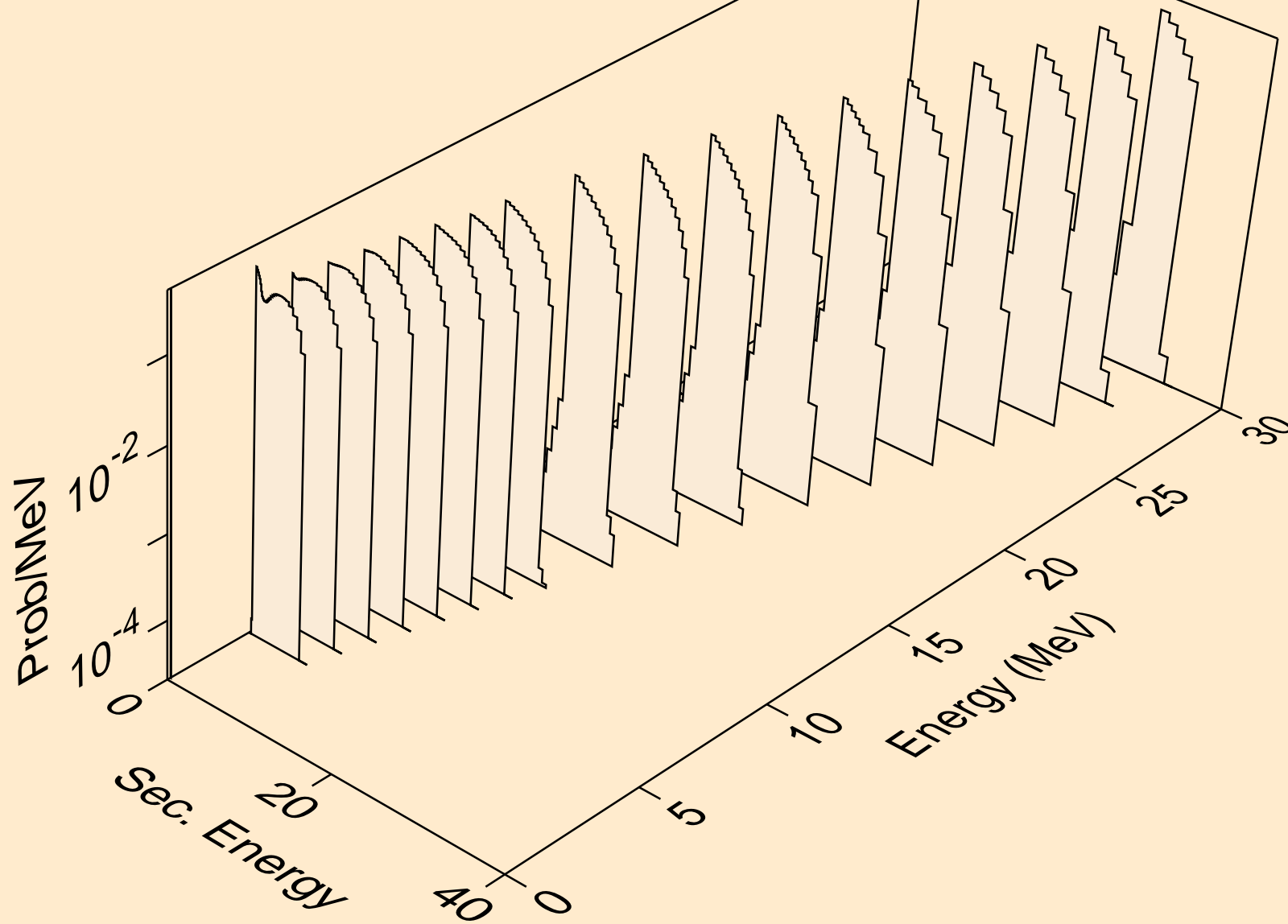

TL213 TRITON ACER TENDL-2021 LIBRARY; T=0.K
neutrons from (t,x)

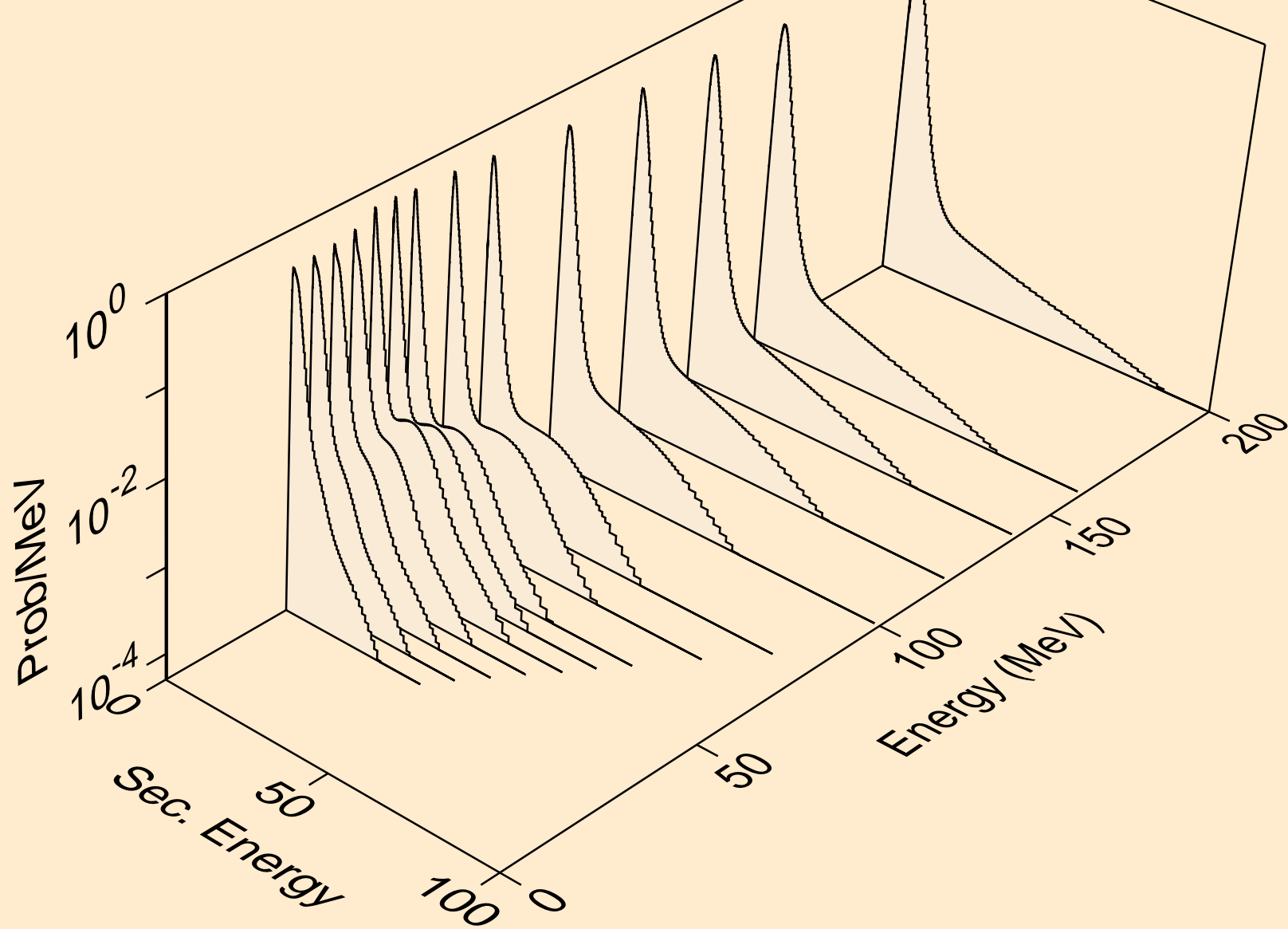

TL213 TRITON ACER TENDL-2021 LIBRARY; T=0.K
neutrons from (t,2nd)

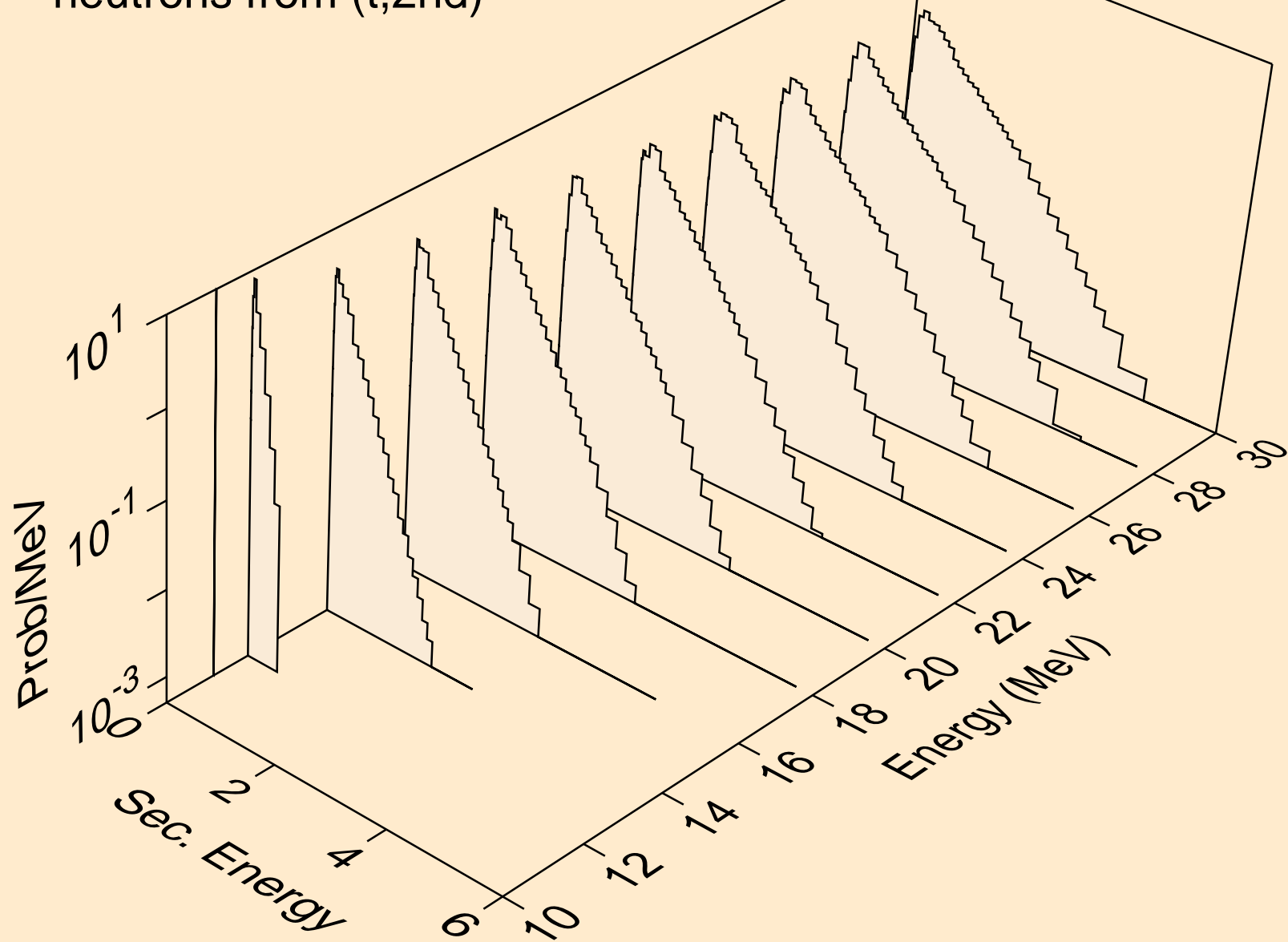

TL213 TRITON ACER TENDL-2021 LIBRARY; T=0.K
neutrons from (t,2n)

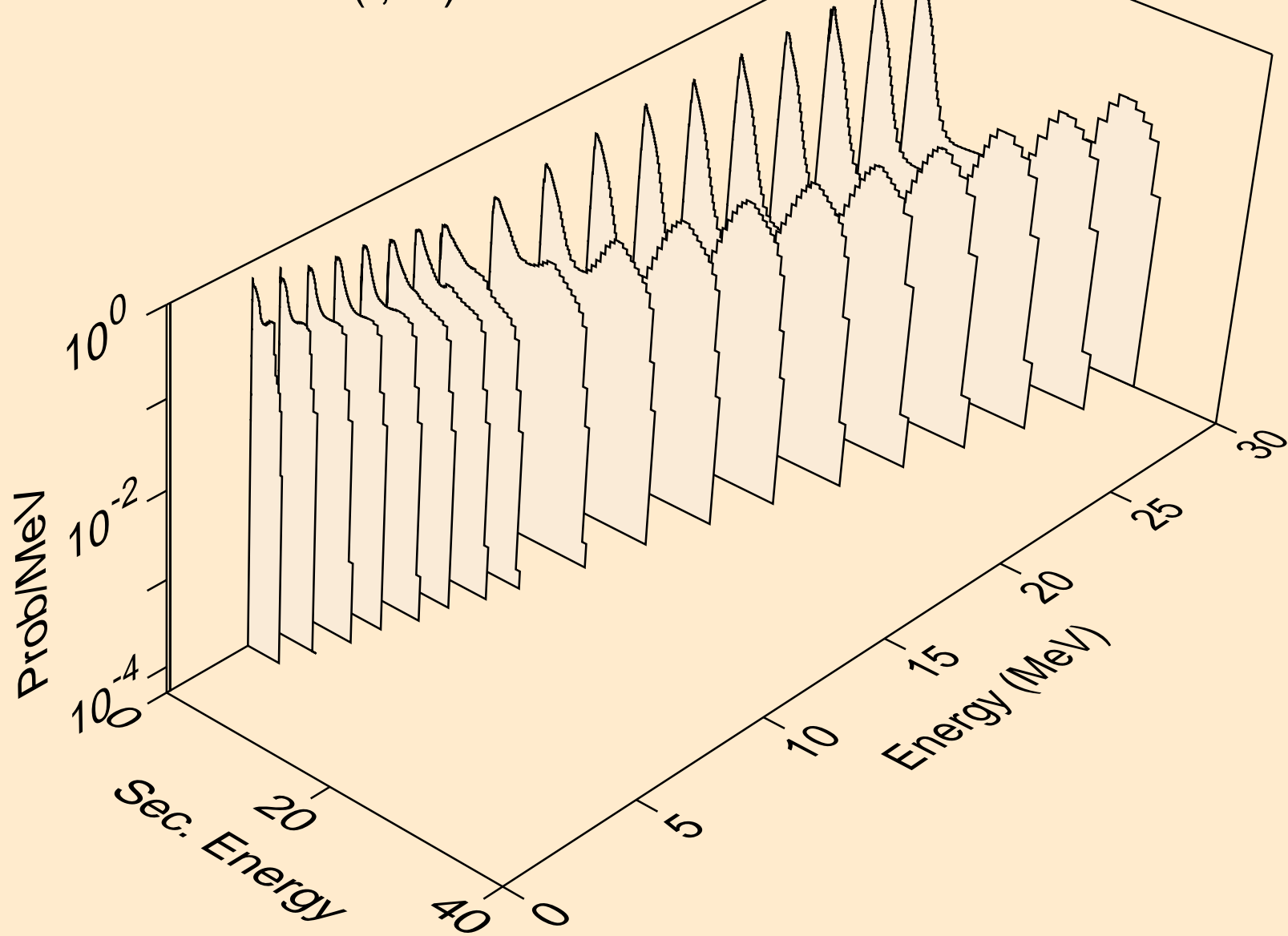

TL213 TRITON ACER TENDL-2021 LIBRARY; T=0.K
neutrons from (t,3n)

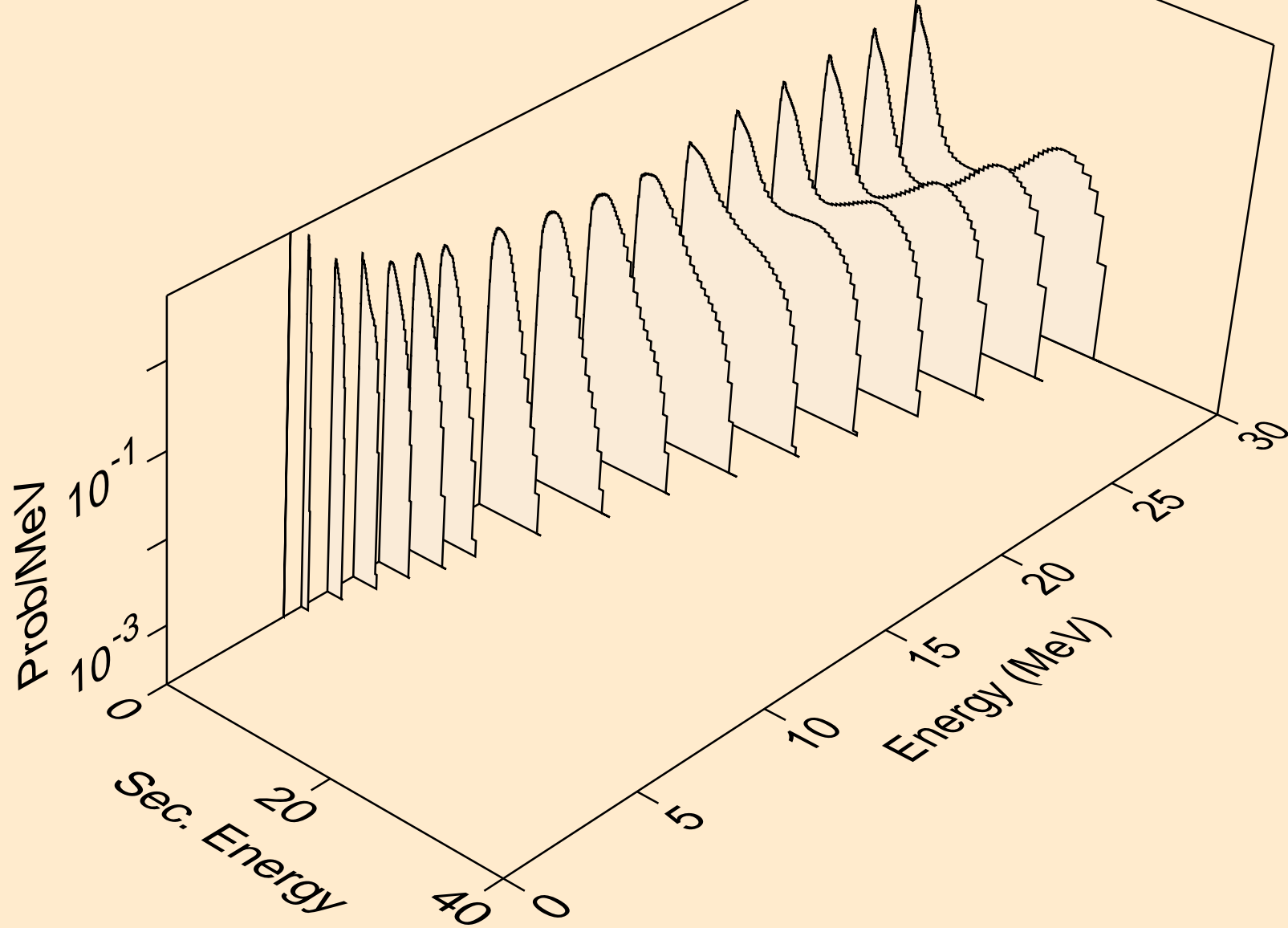

TL213 TRITON ACER TENDL-2021 LIBRARY; T=0.K
neutrons from (t,n*)a

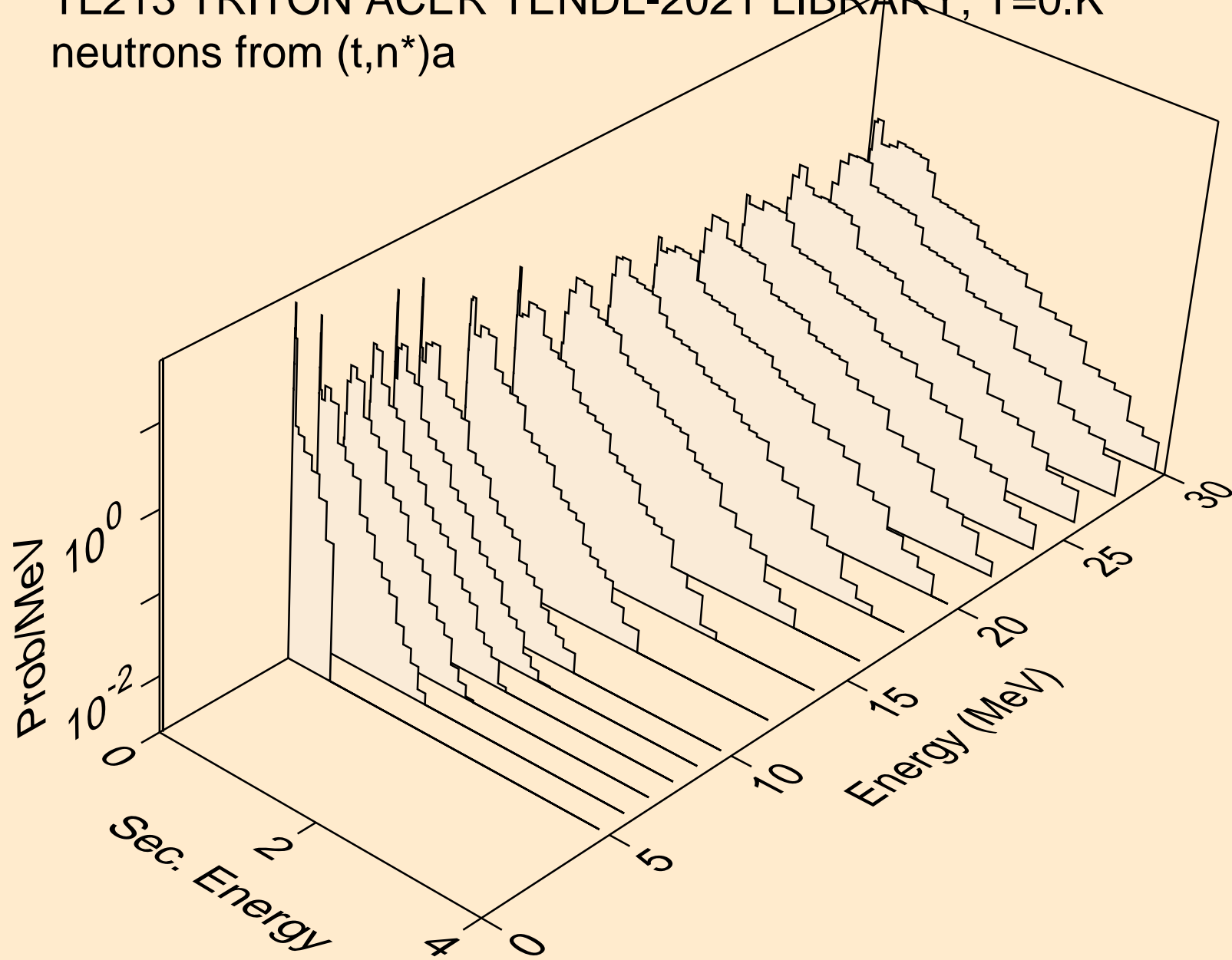

TL213 TRITON ACER TENDL-2021 LIBRARY; T=0.K
neutrons from (t,2n)a

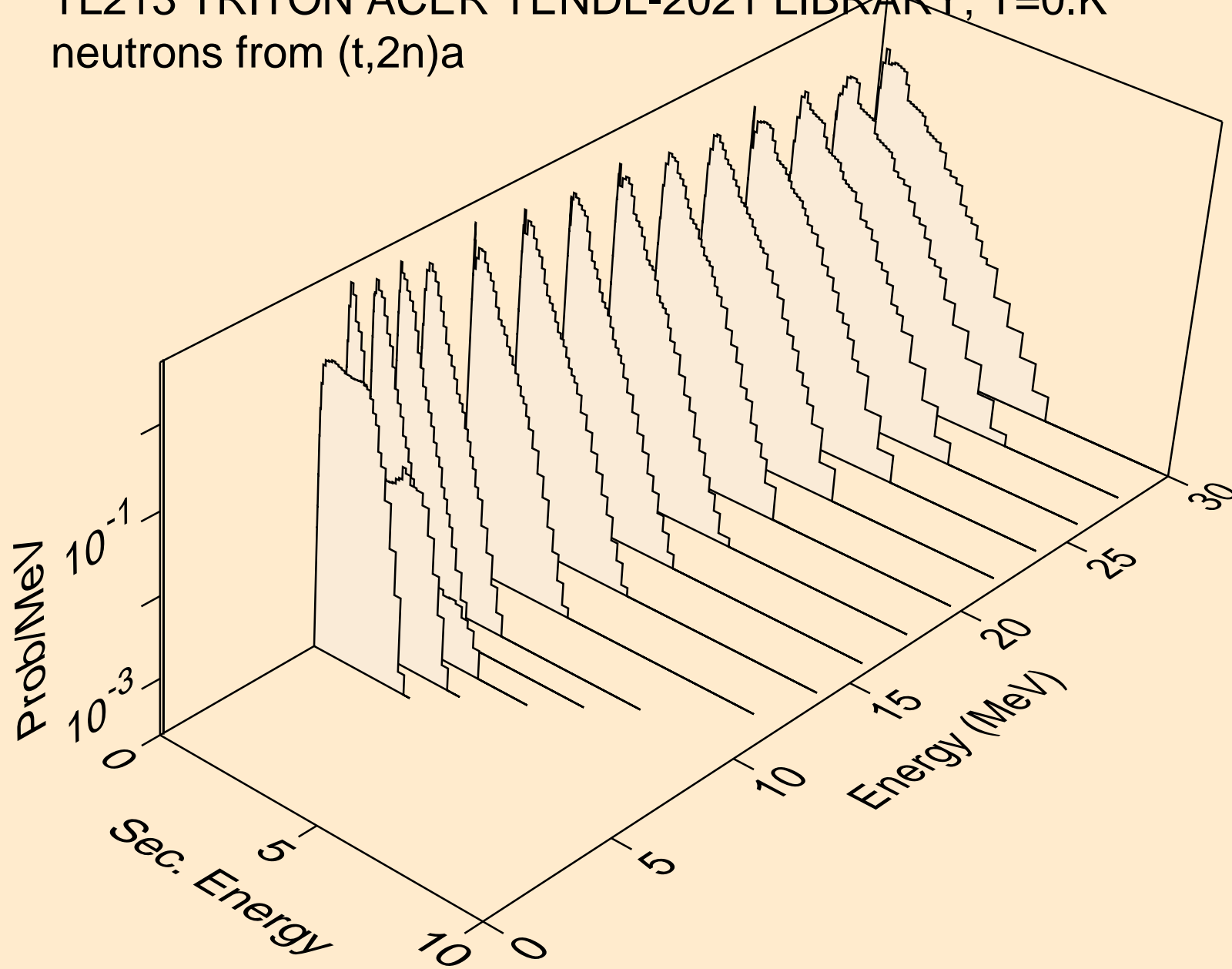

TL213 TRITON ACER TENDL-2021 LIBRARY; T=0.K
neutrons from (t,3n)a

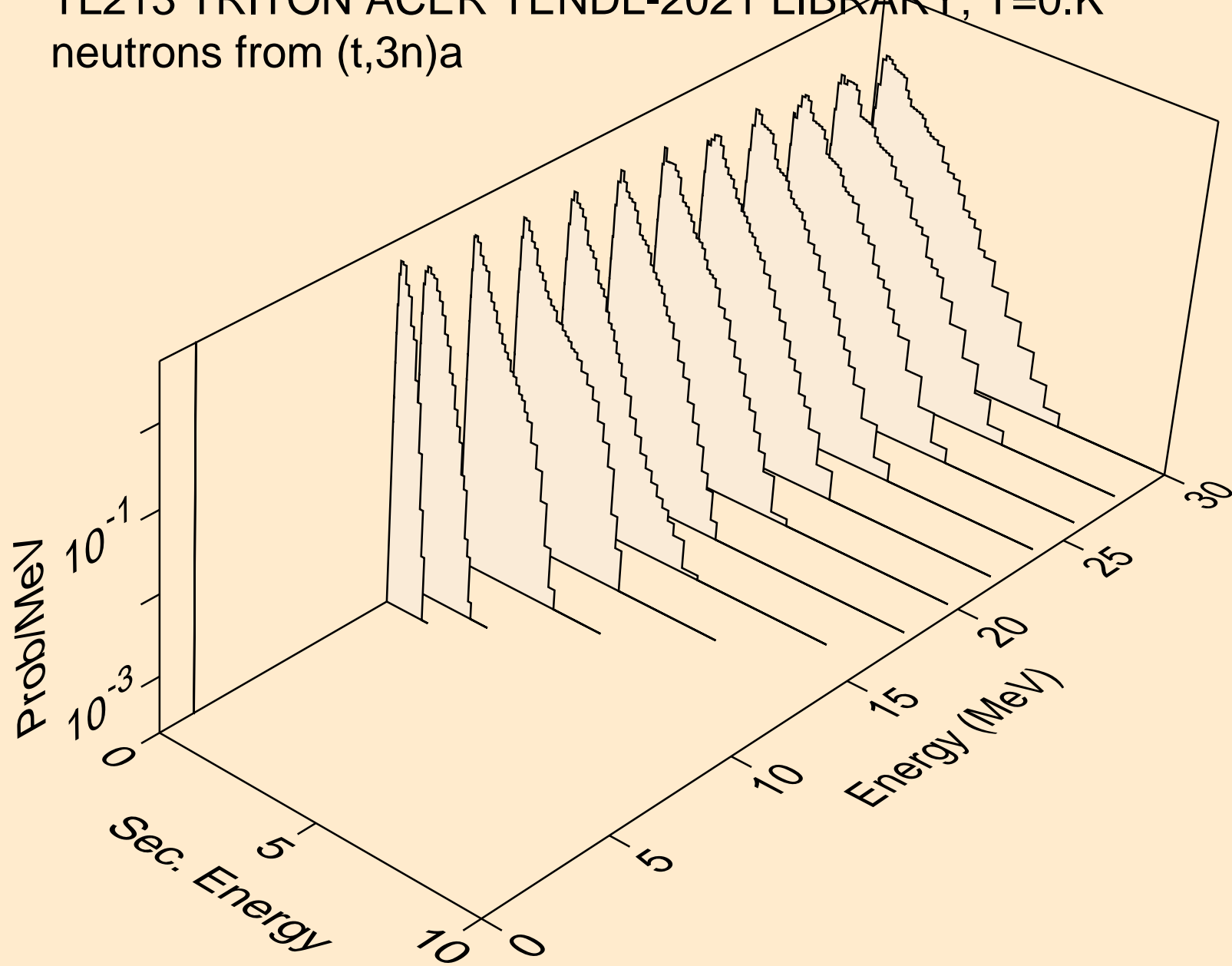

TL213 TRITON ACER TENDL-2021 LIBRARY; T=0.K
neutrons from (t,n*)p

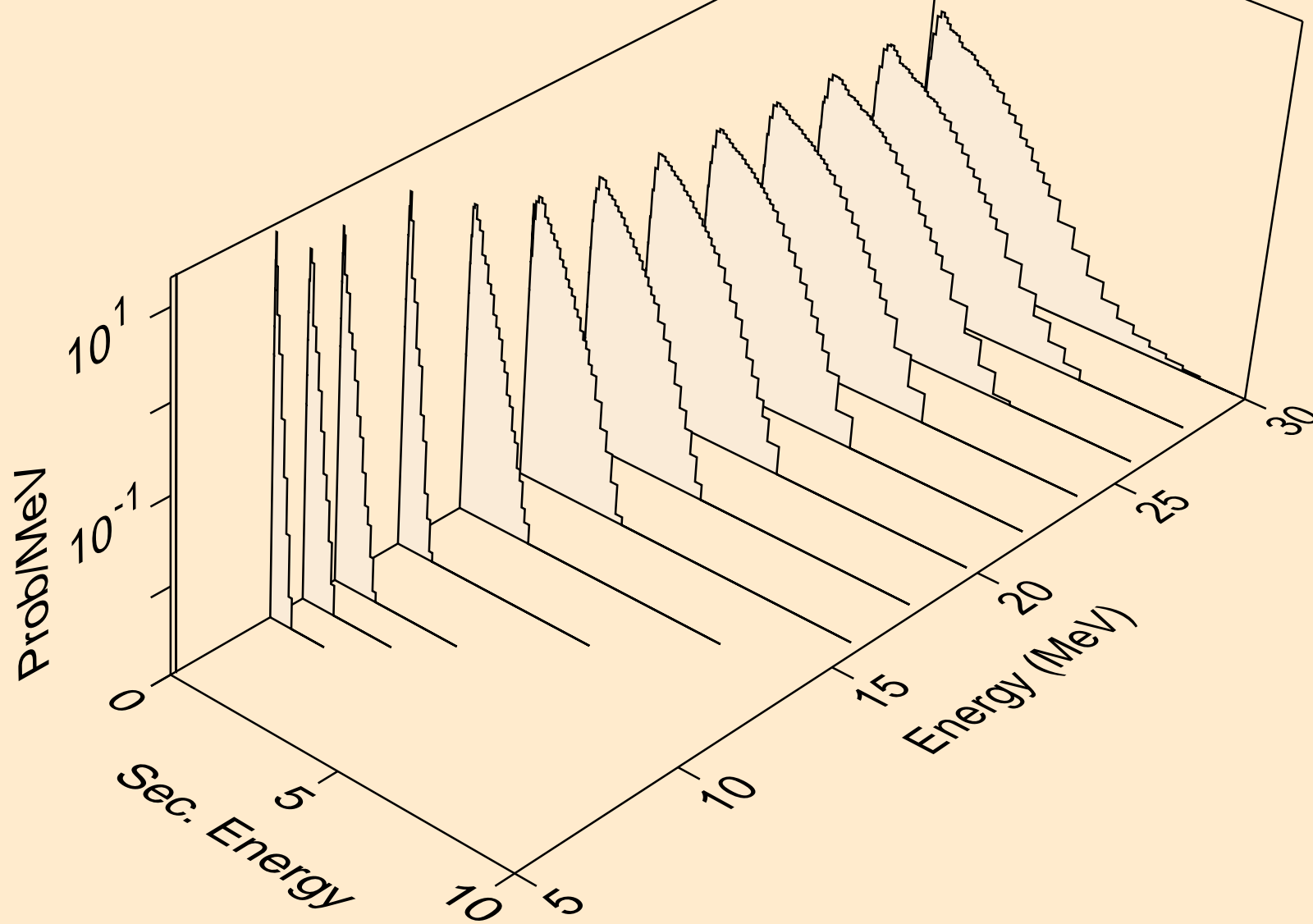

TL213 TRITON ACER TENDL-2021 LIBRARY; T=0.K
neutrons from (t,n*)d

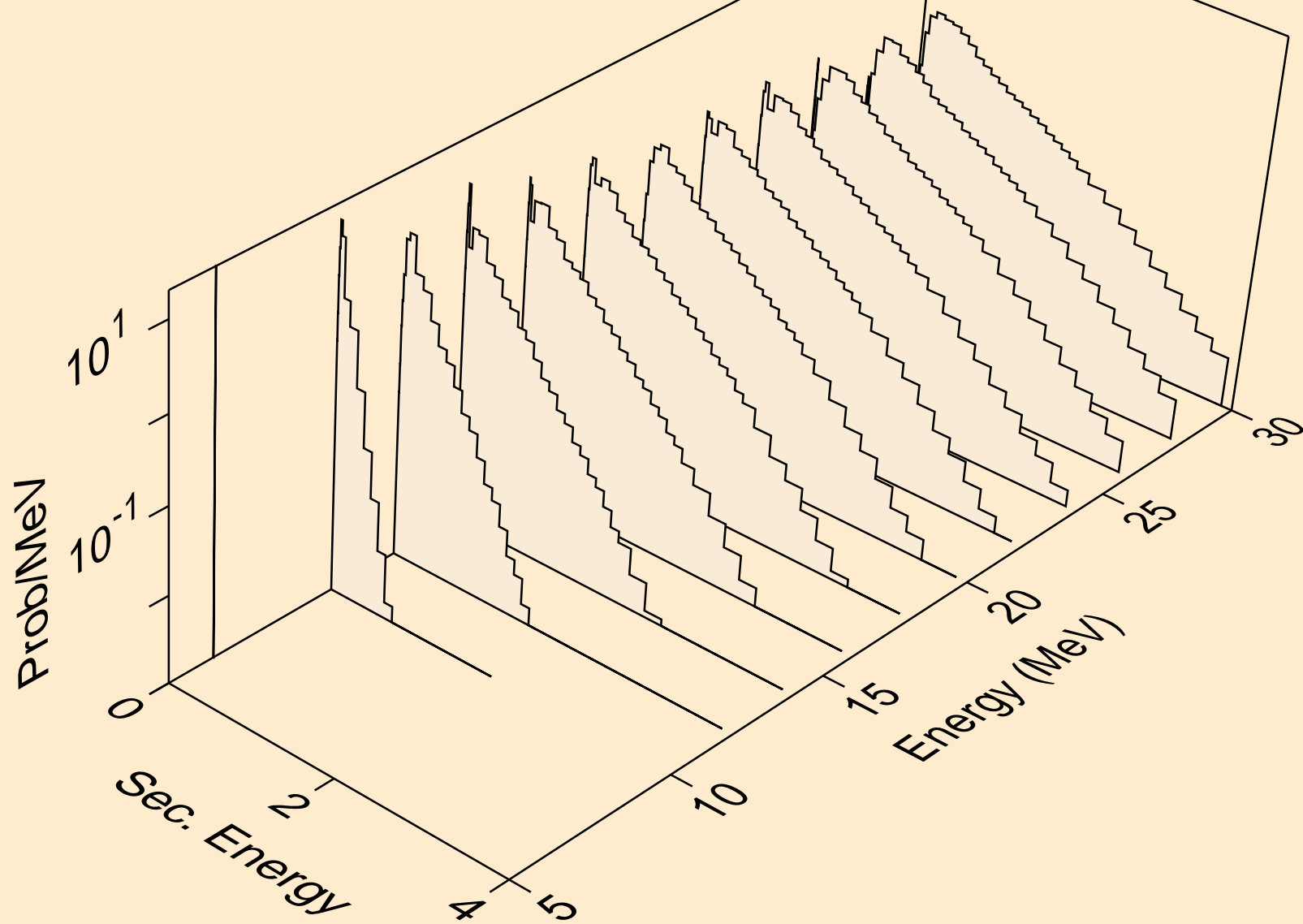

TL213 TRITON ACER TENDL-2021 LIBRARY; T=0.K
neutrons from (t,n*)t

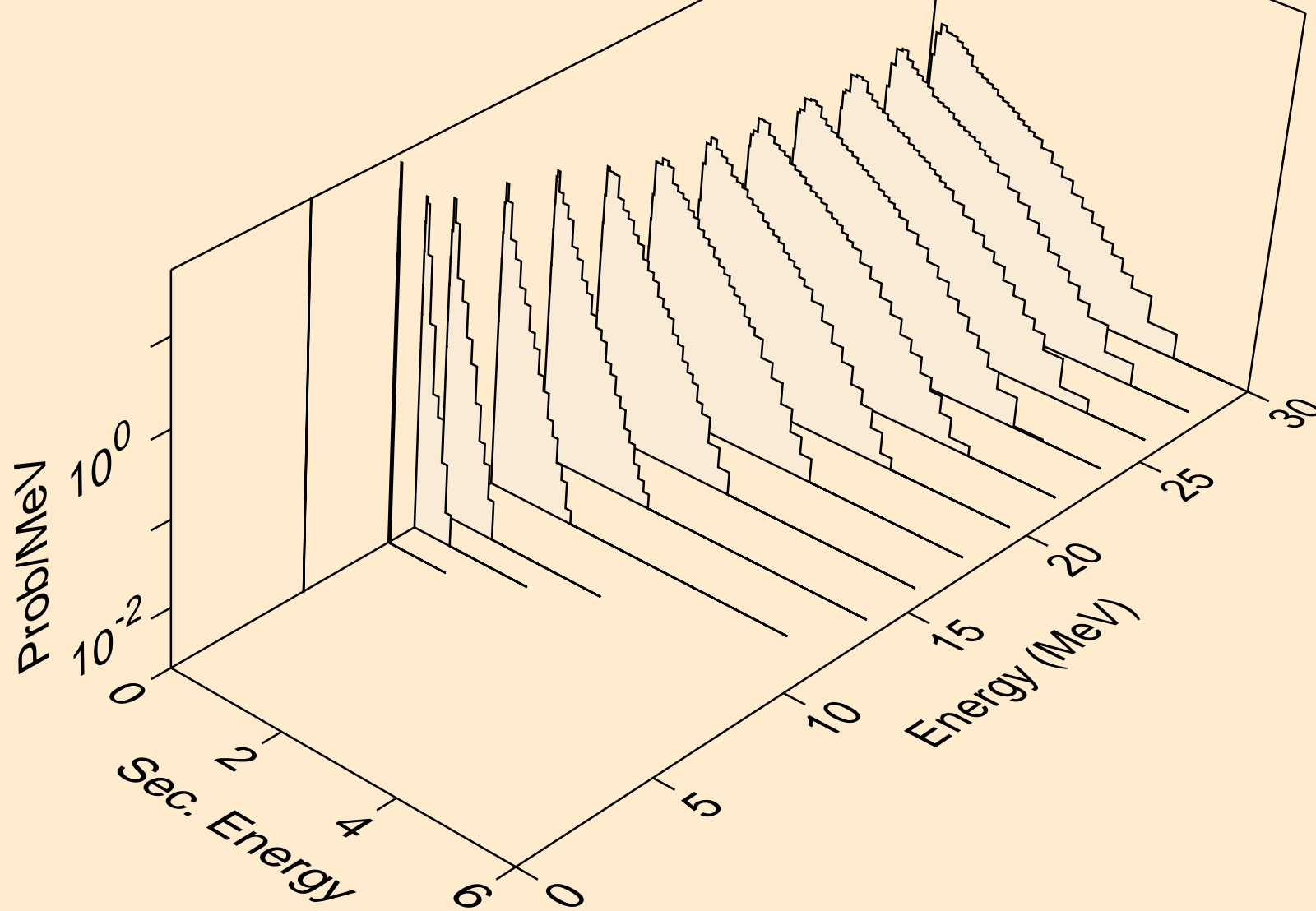

TL213 TRITON ACER TENDL-2021 LIBRARY; T=0.K
neutrons from (t,n*)he3

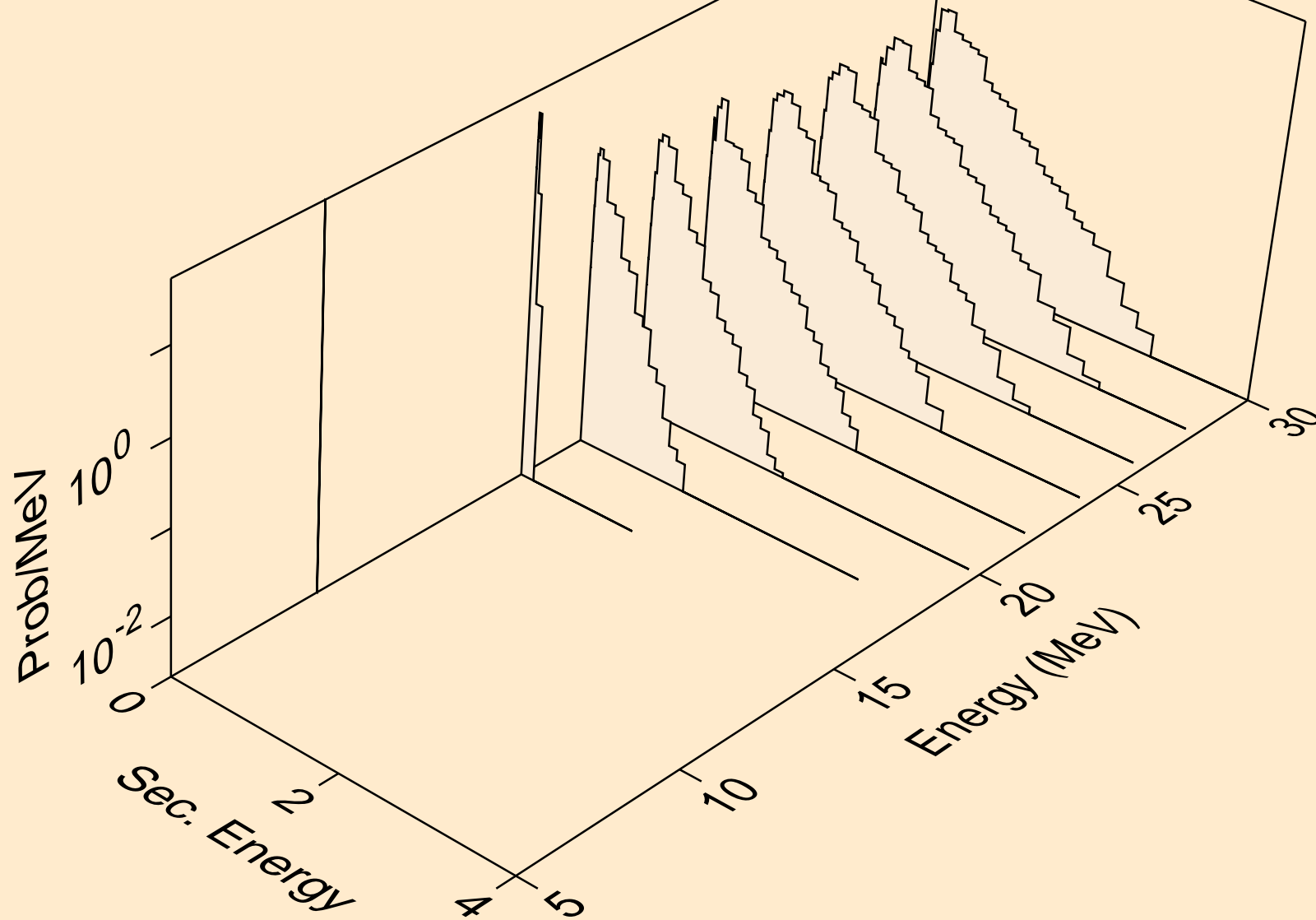

TL213 TRITON ACER TENDL-2021 LIBRARY; T=0.K
neutrons from (t,4n)

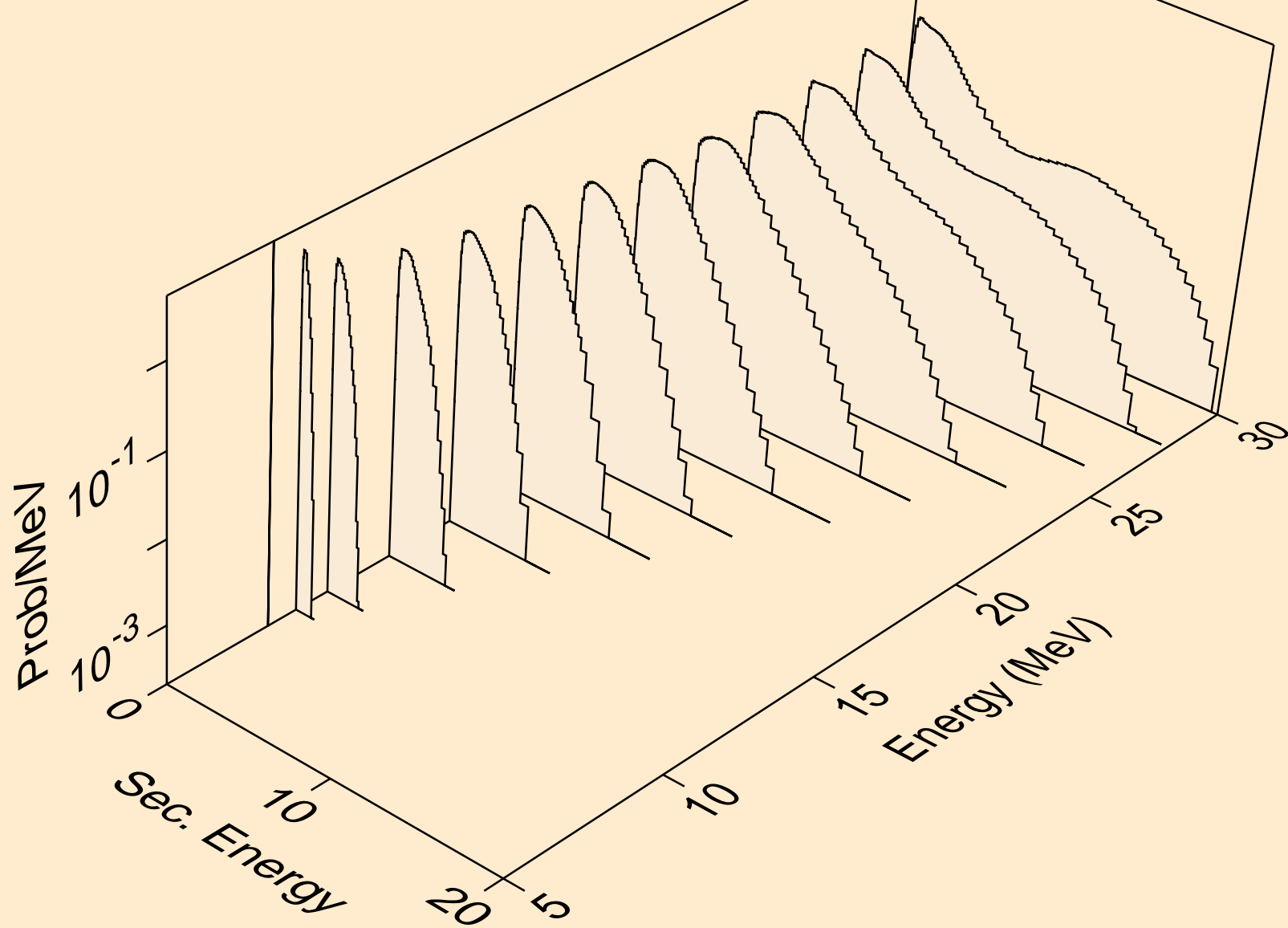

TL213 TRITON ACER TENDL-2021 LIBRARY; T=0.K
neutrons from (t,2np)

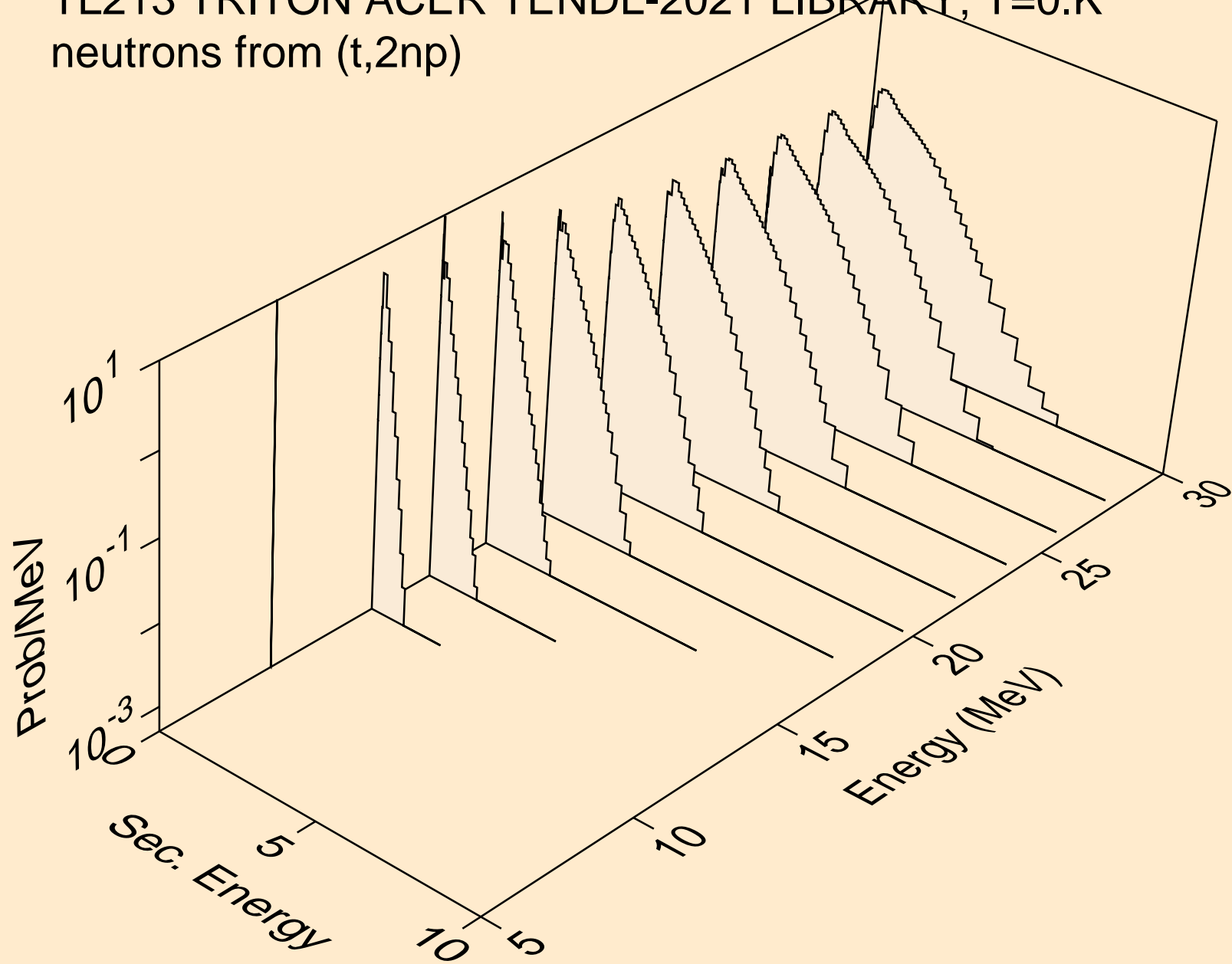

TL213 TRITON ACER TENDL-2021 LIBRARY; T=0.K
neutrons from (t,3np)

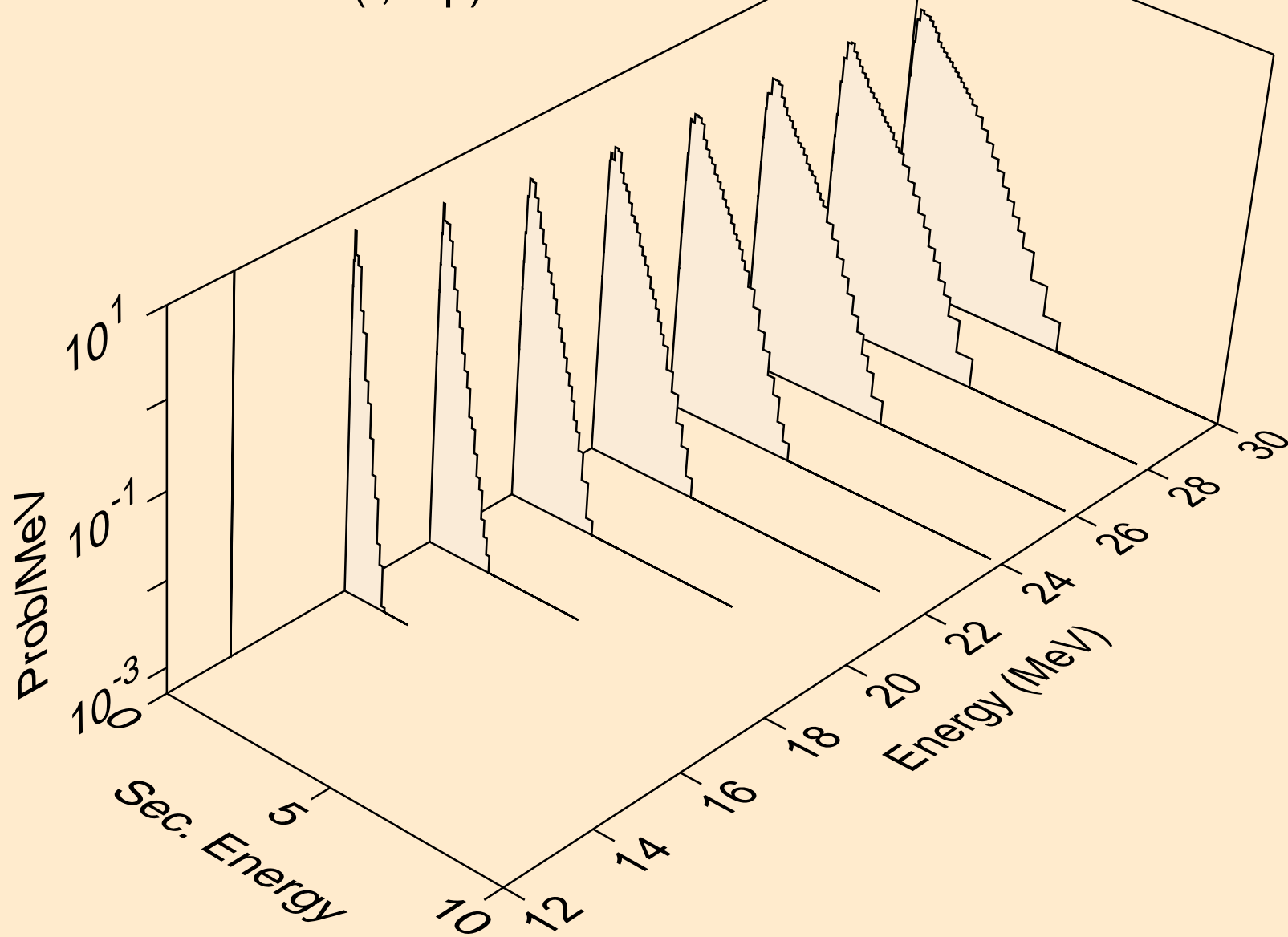

TL213 TRITON ACER TENDL-2021 LIBRARY; T=0.K
neutrons from (t,2np)

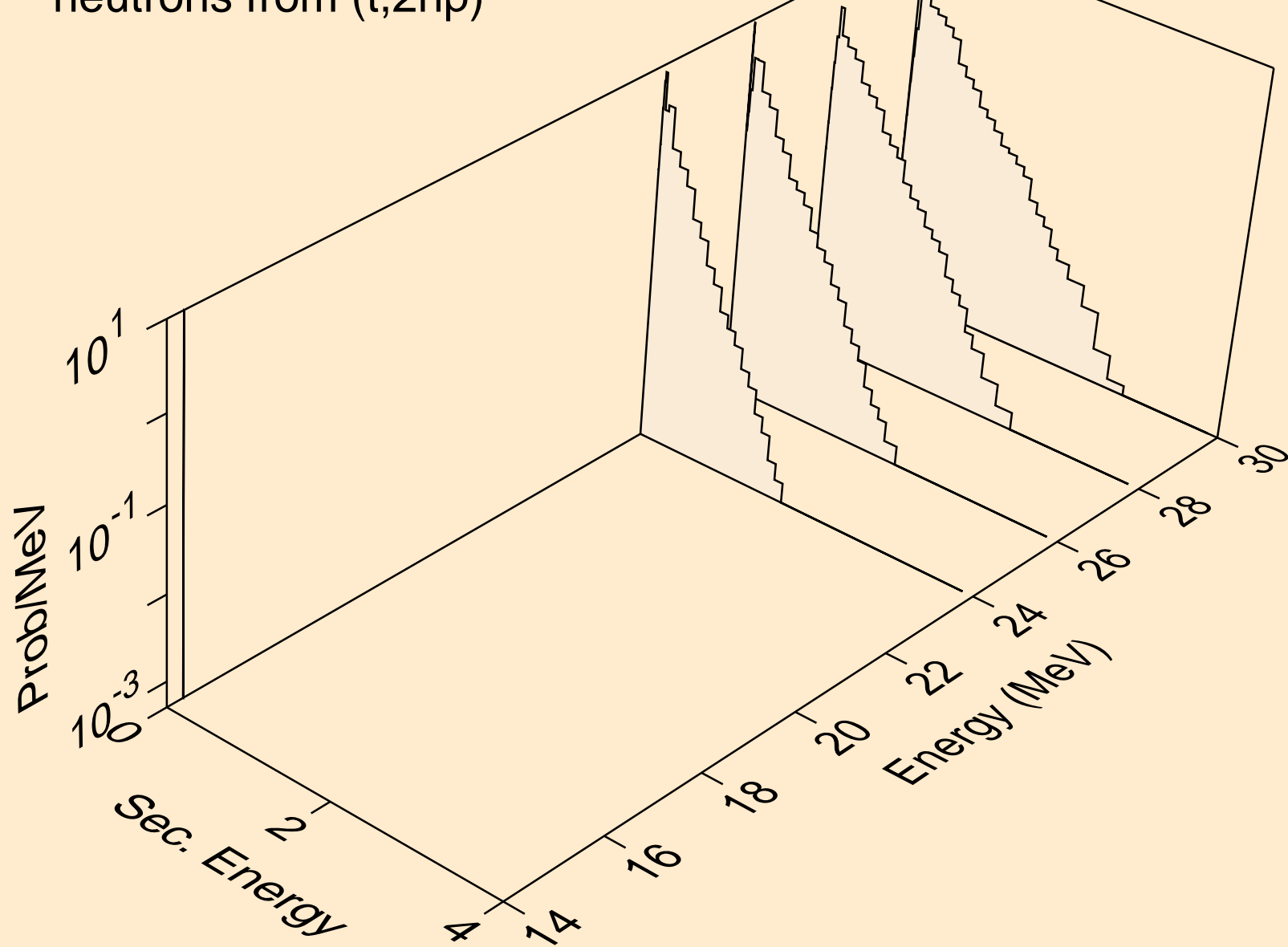

TL213 TRITON ACER TENDL-2021 LIBRARY; T=0.K
protons from (t,x)

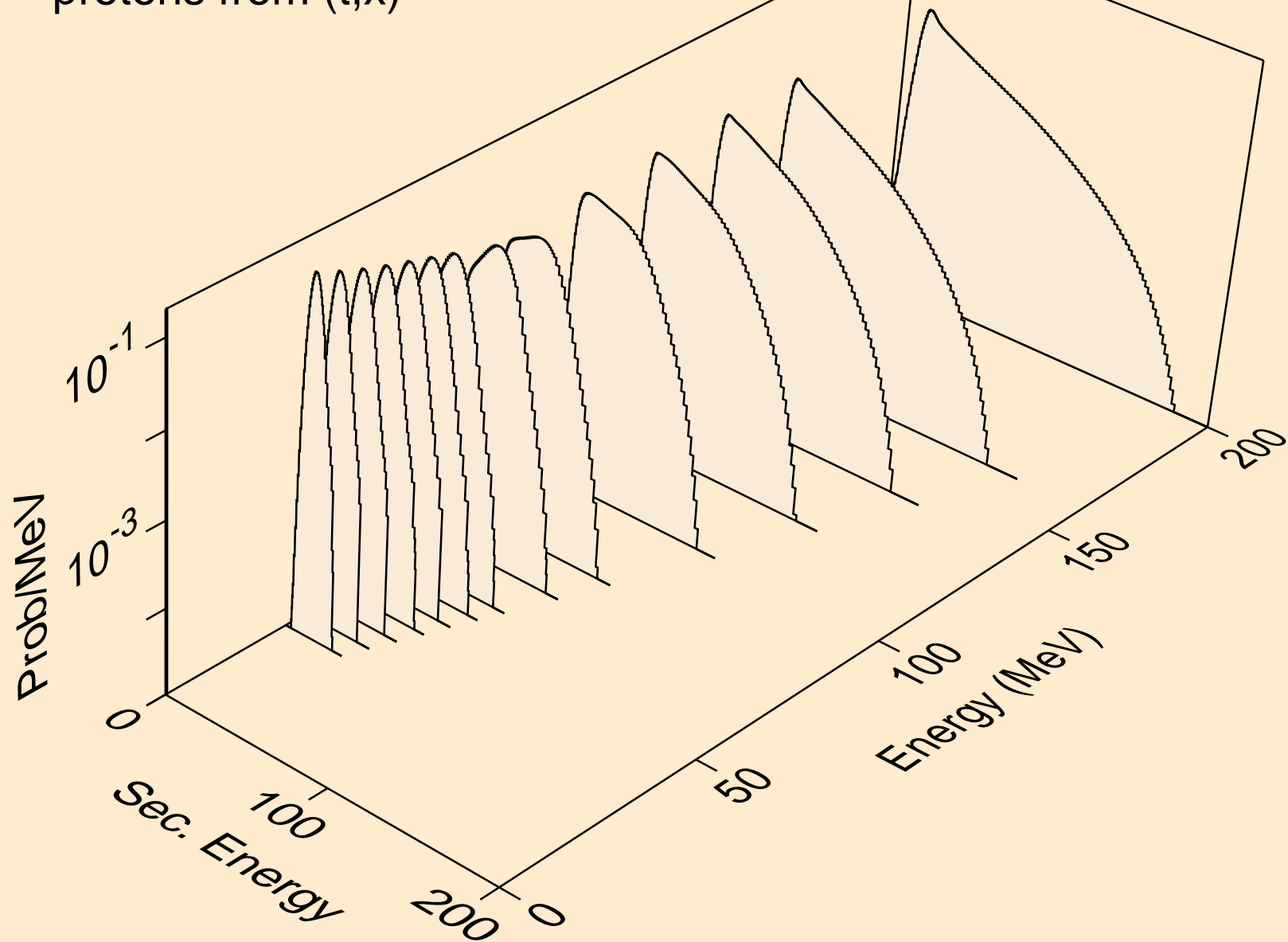

TL213 TRITON ACER TENDL-2021 LIBRARY; T=0.K
protons from (t,n*)p

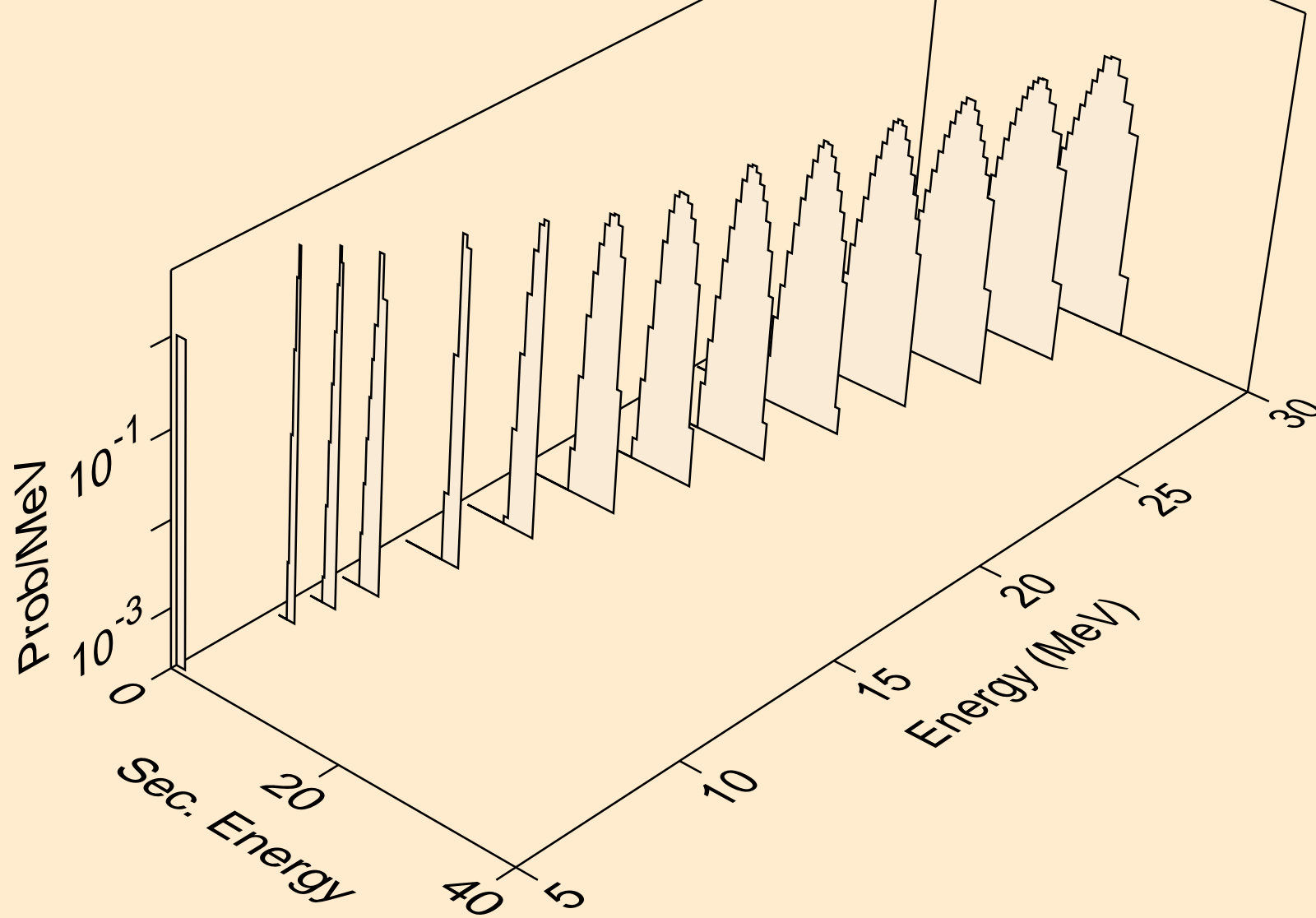

TL213 TRITON ACER TENDL-2021 LIBRARY; T=0.K
protons from (t,2np)

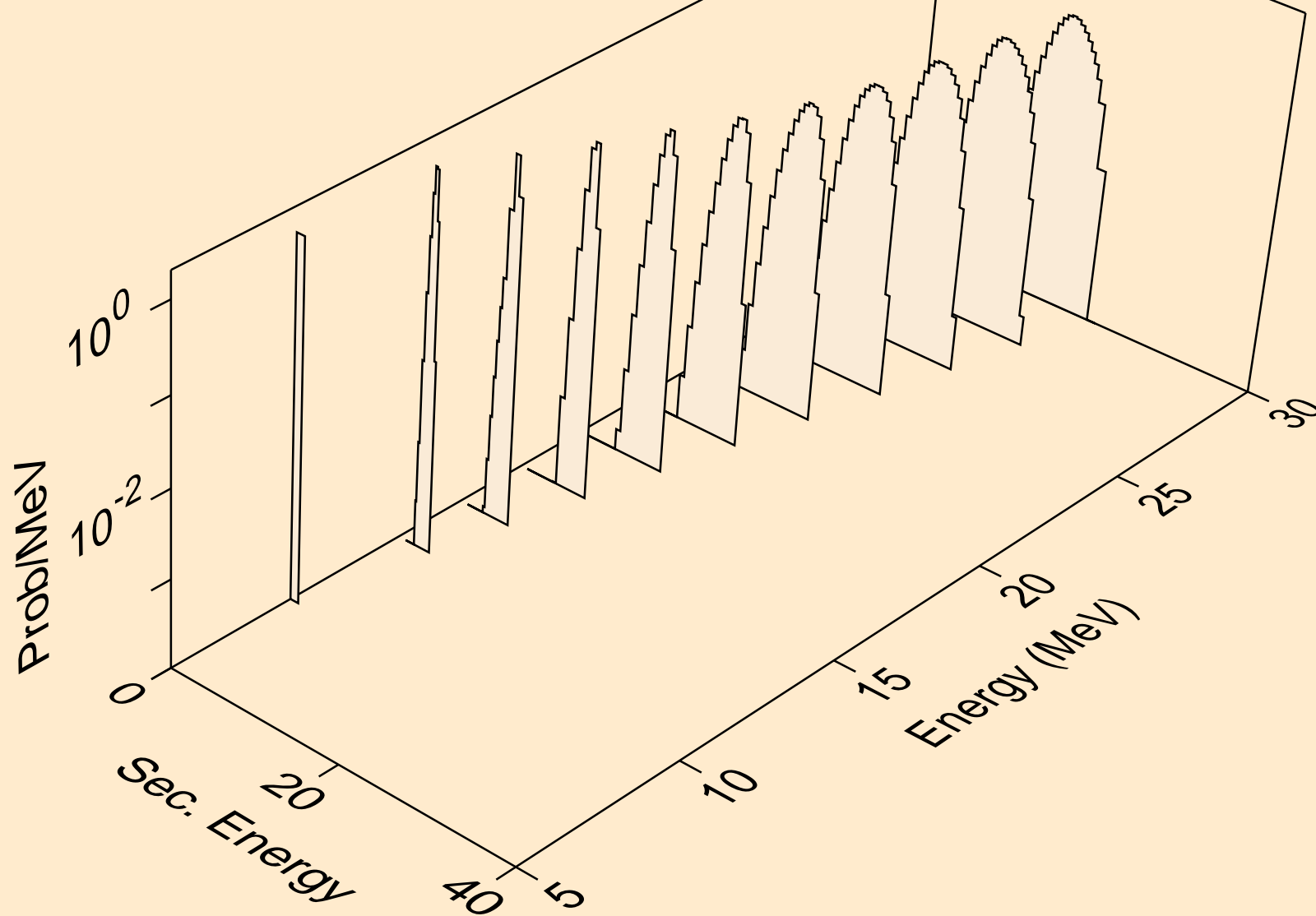

TL213 TRITON ACER TENDL-2021 LIBRARY; T=0.K
protons from (t,3np)

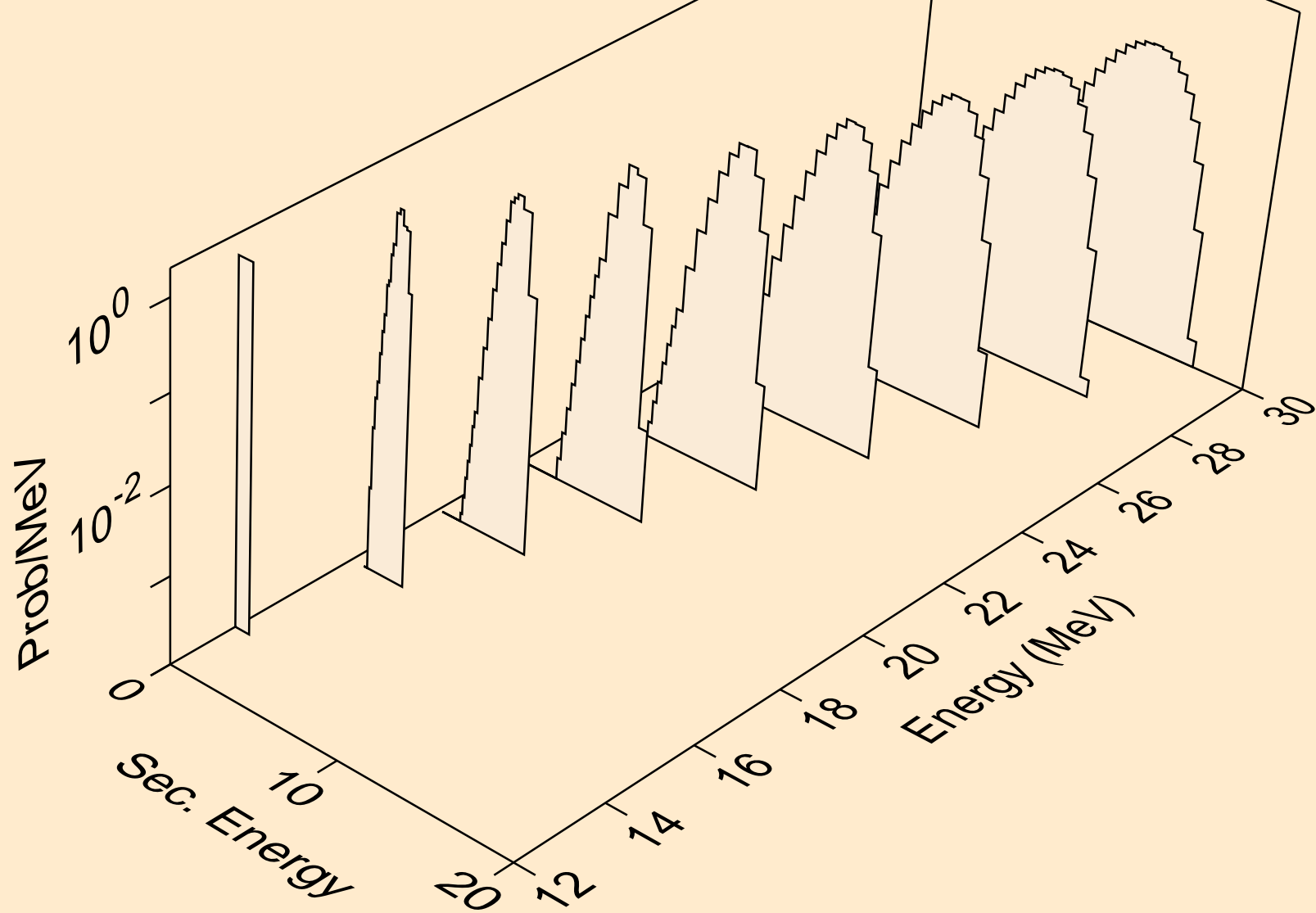

TL213 TRITON ACER TENDL-2021 LIBRARY; T=0.K
protons from (t,2np)

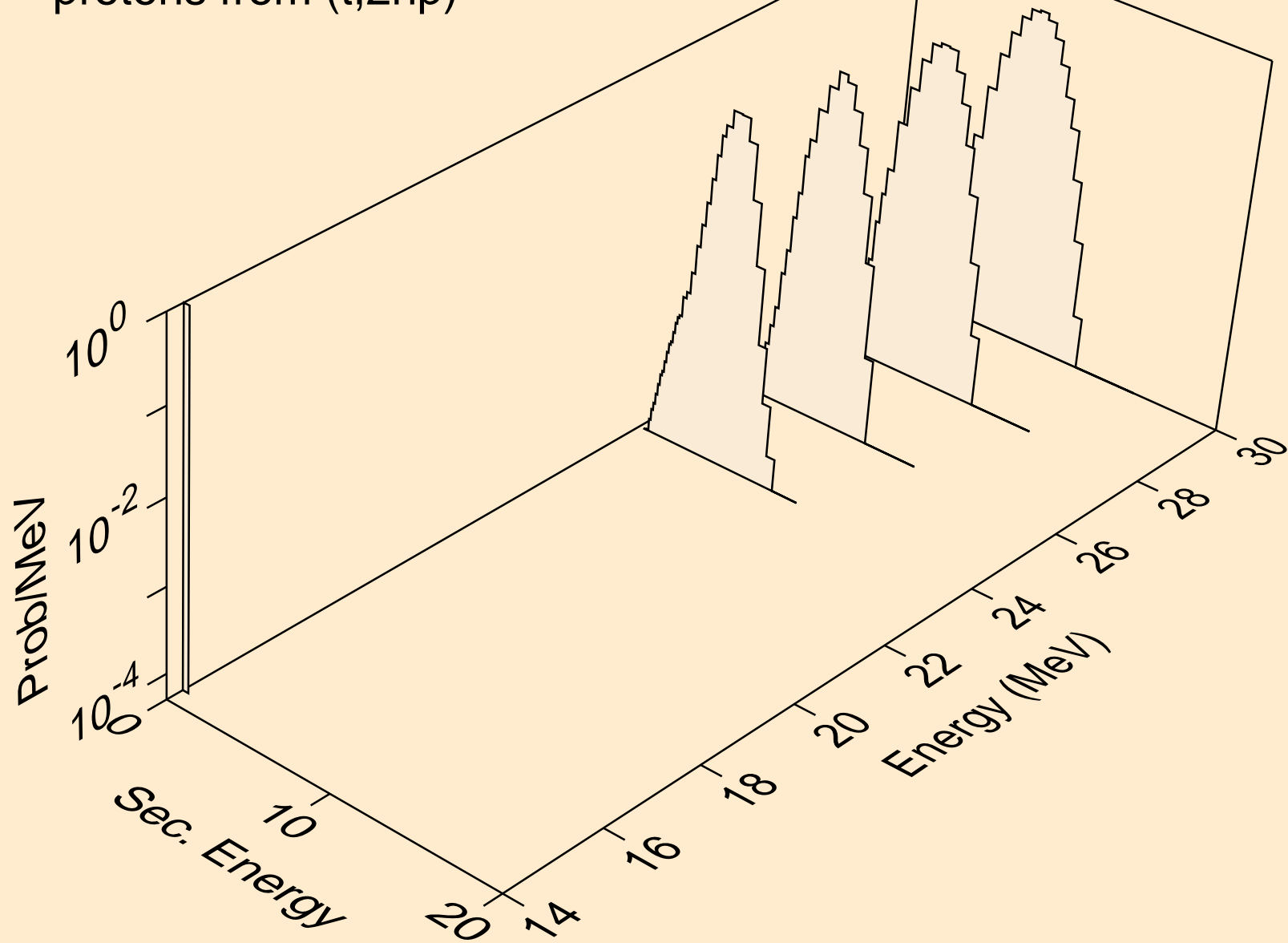

TL213 TRITON ACER TENDL-2021 LIBRARY; T=0.K
protons from (t,p)

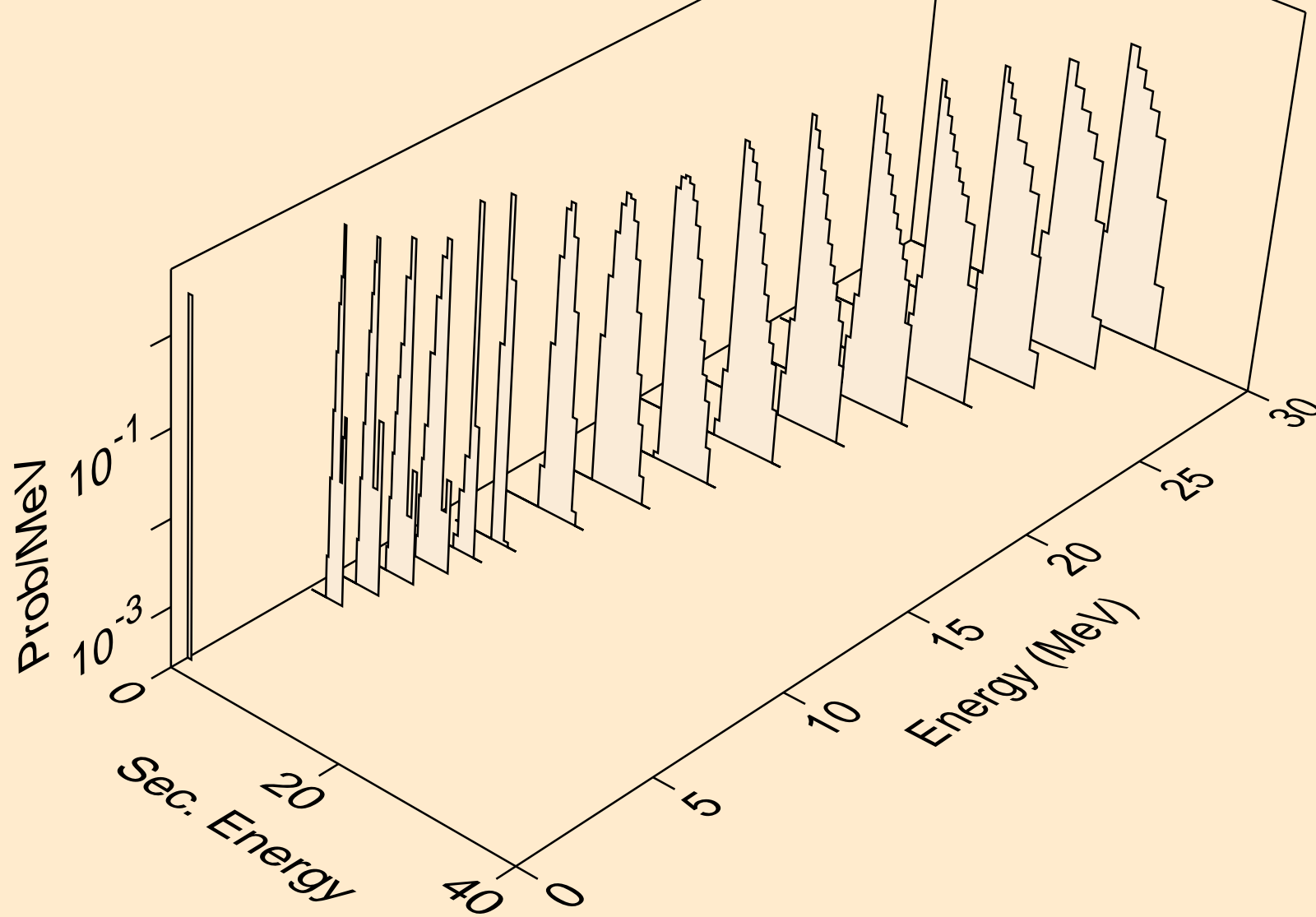

TL213 TRITON ACER TENDL-2021 LIBRARY; T=0.K
protons from (t,2p)

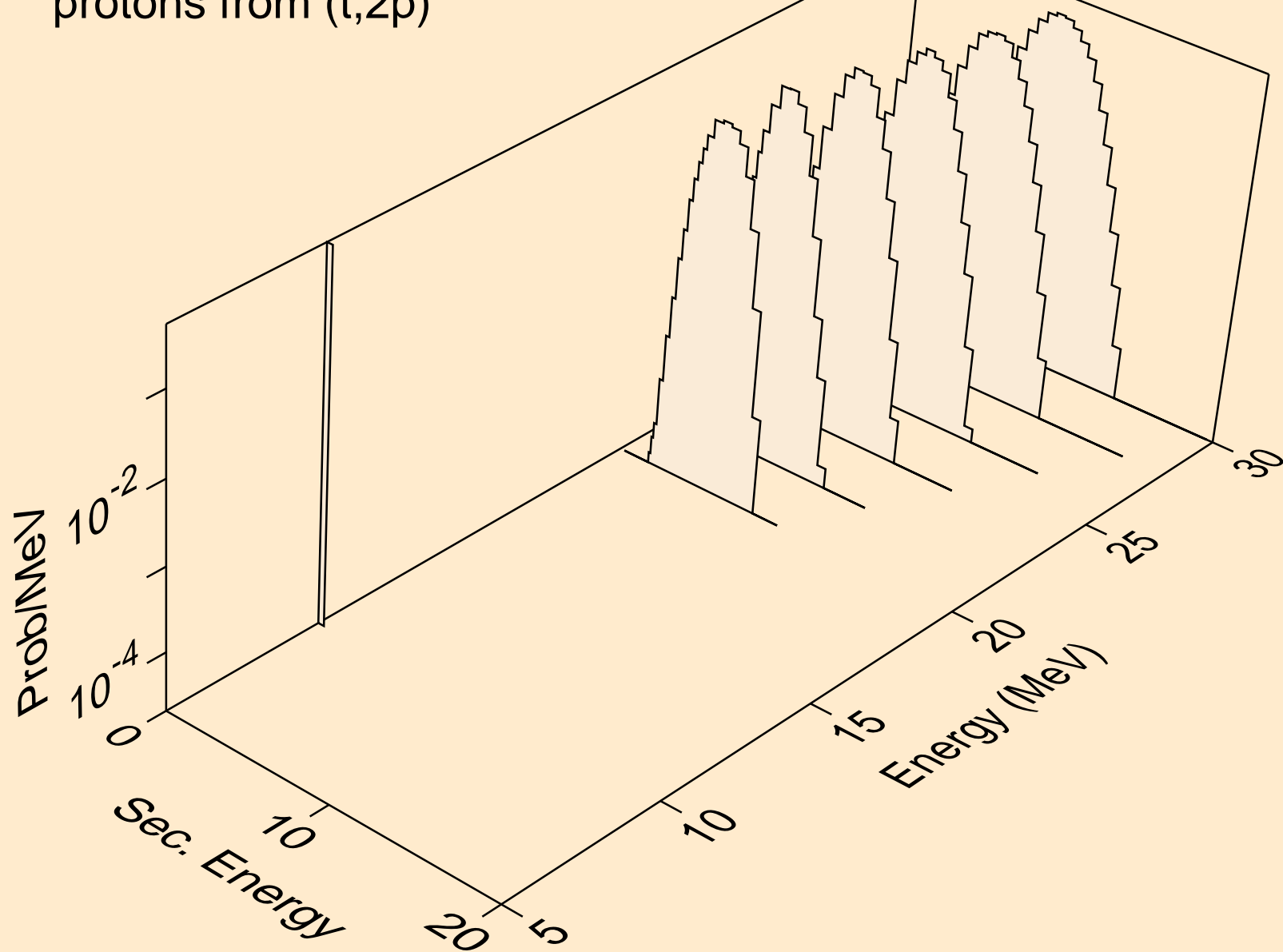

TL213 TRITON ACER TENDL-2021 LIBRARY; T=0.K
deuterons from (t,x)

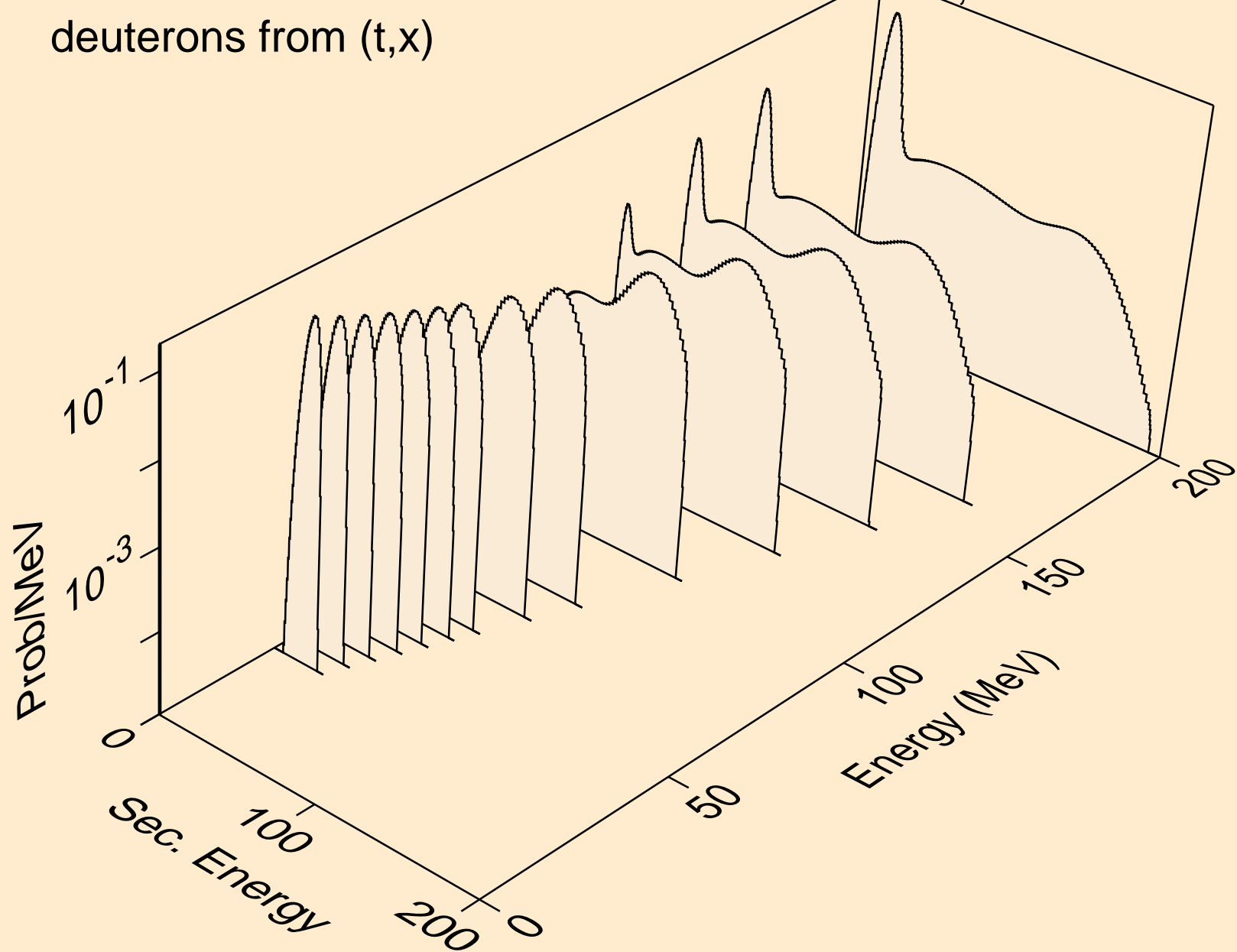

TL213 TRITON ACER TENDL-2021 LIBRARY; T=0.K
deuterons from (t,2nd)

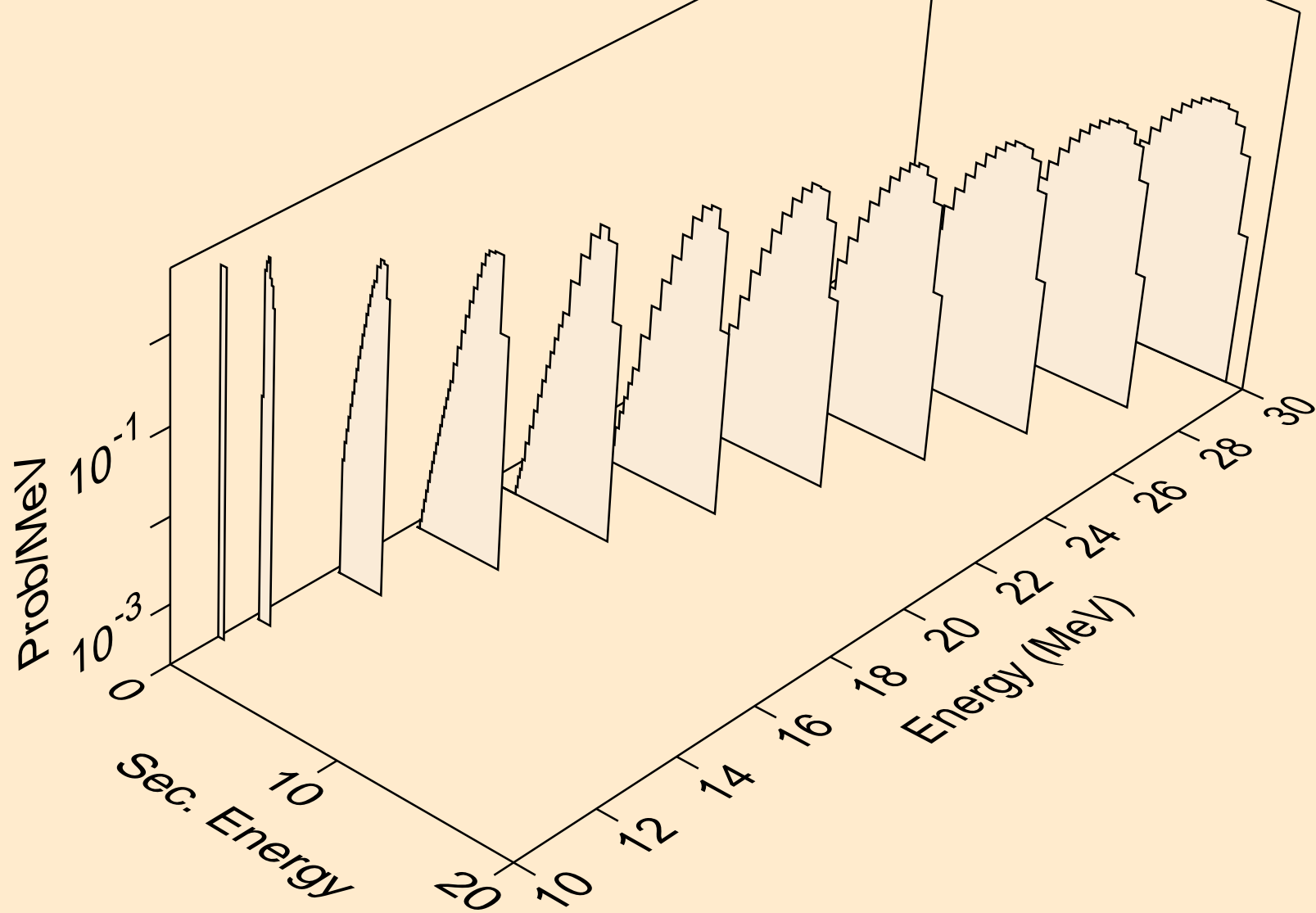

TL213 TRITON ACER TENDL-2021 LIBRARY; T=0.K
deuterons from (t,n*)d

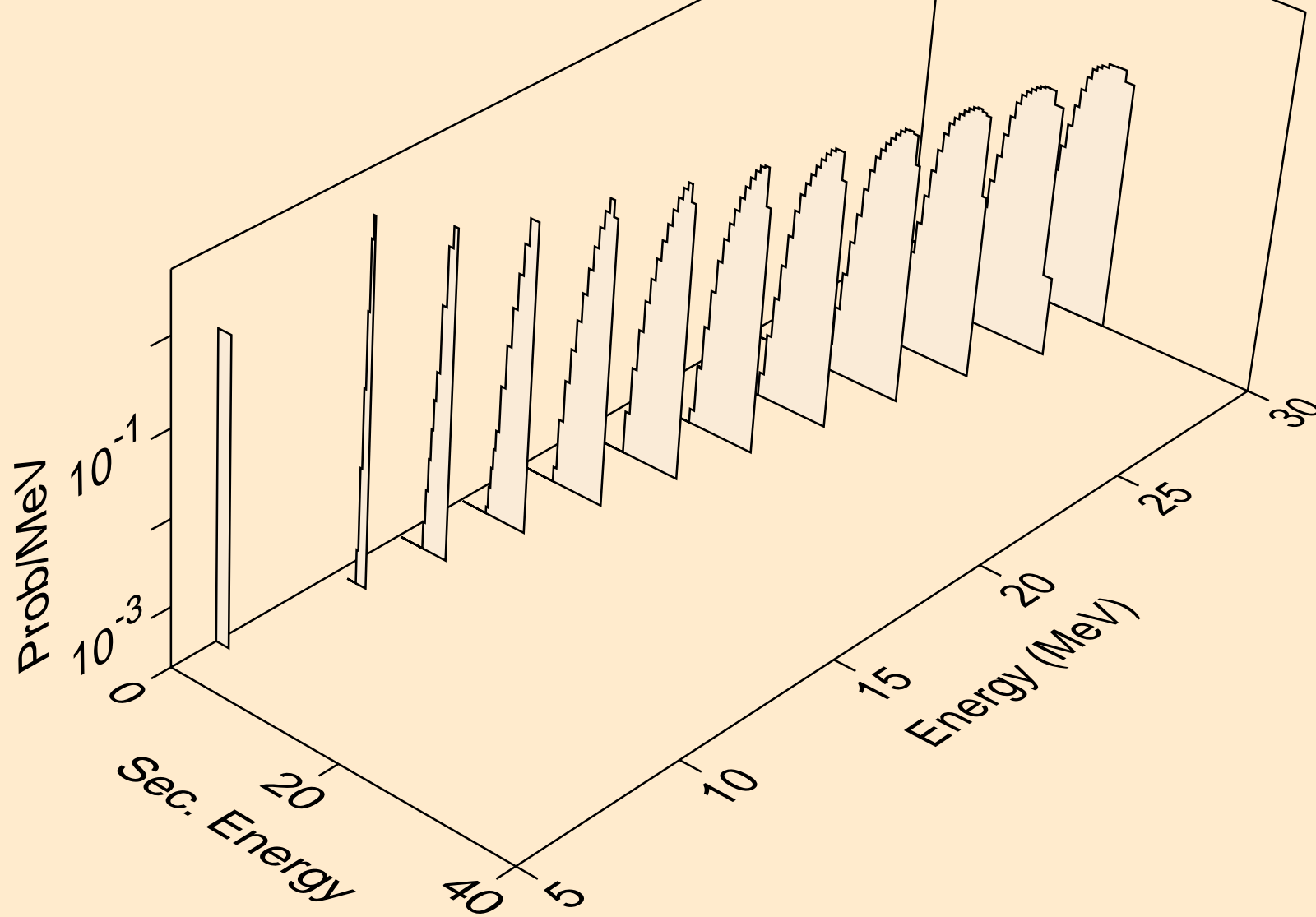

TL213 TRITON ACER TENDL-2021 LIBRARY; T=0.K
deuterons from (t,d)

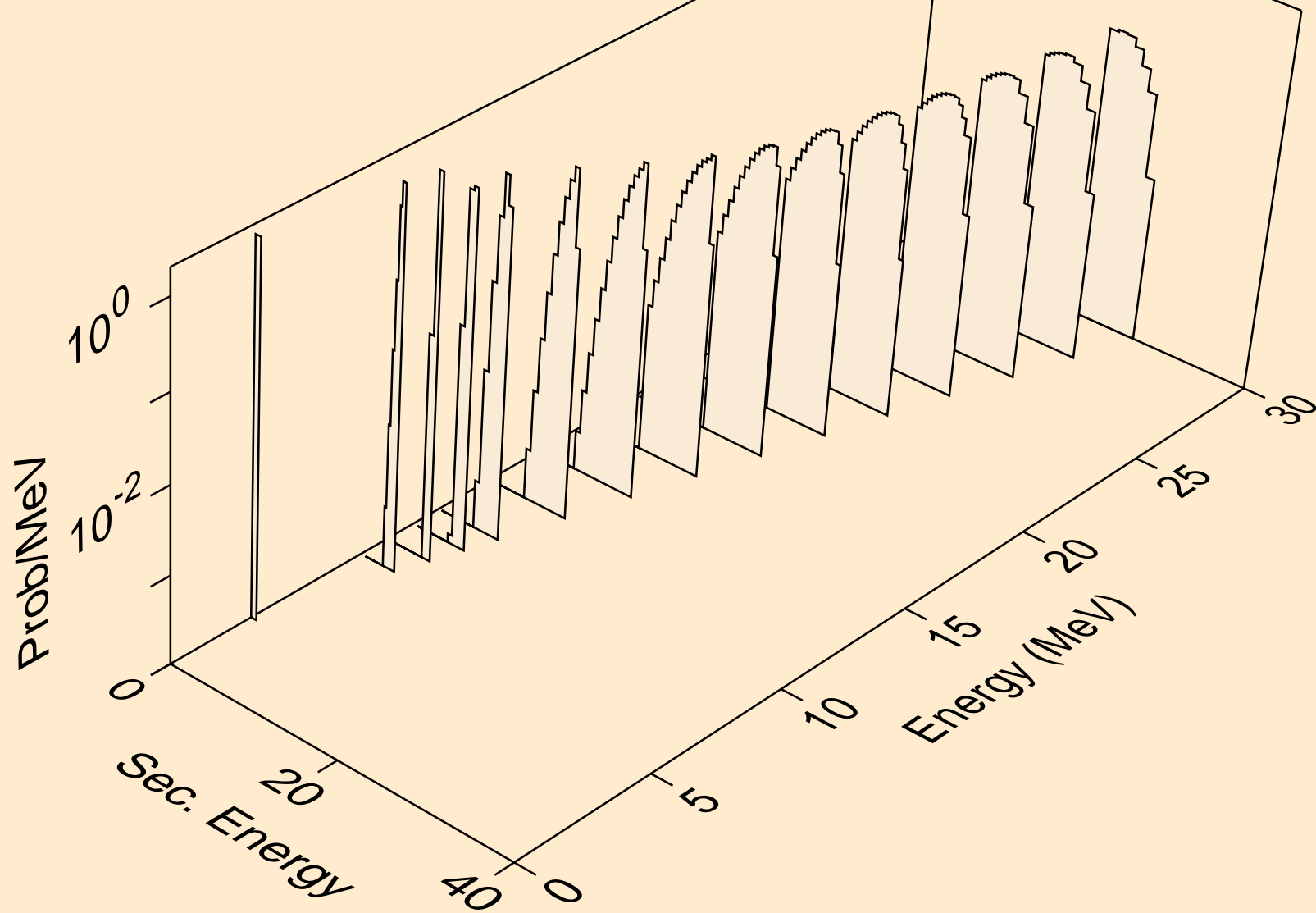

TL213 TRITON ACER TENDL-2021 LIBRARY; T=0.K
he3s from (t,x)

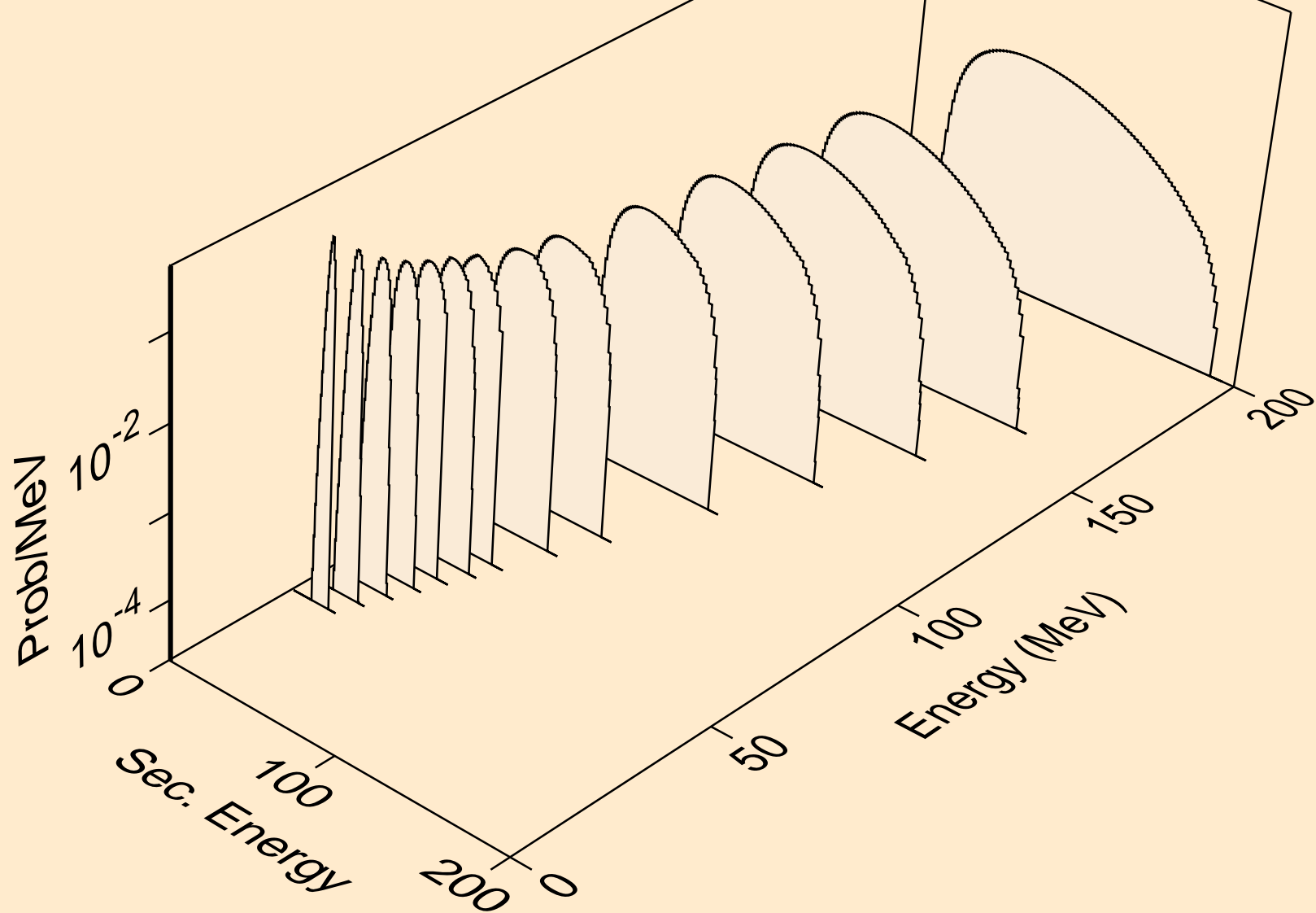

TL213 TRITON ACER TENDL-2021 LIBRARY; T=0.K
he3s from (t,n*)he3

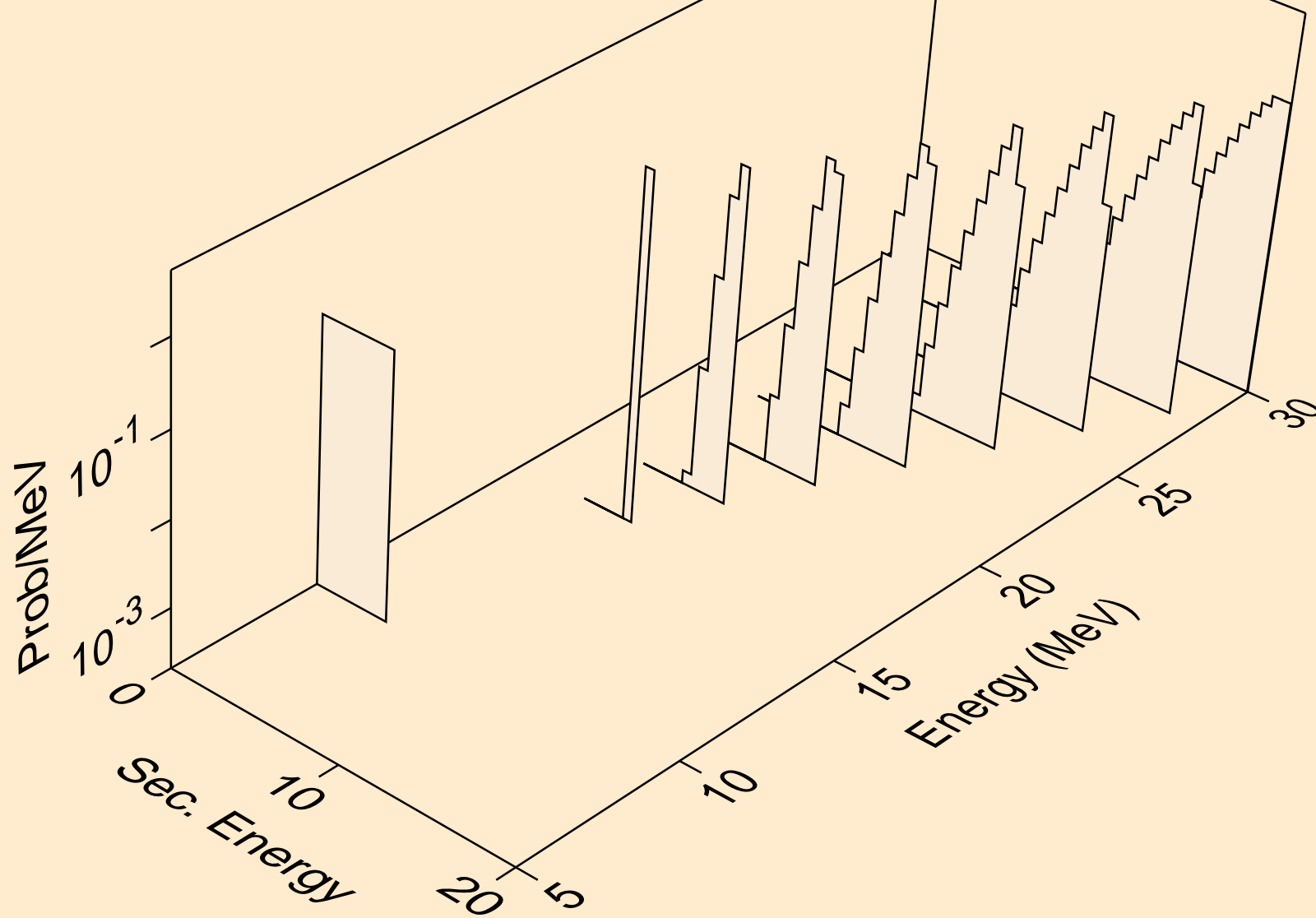

TL213 TRITON ACER TENDL-2021 LIBRARY; T=0.K
he3s from (t,he3)

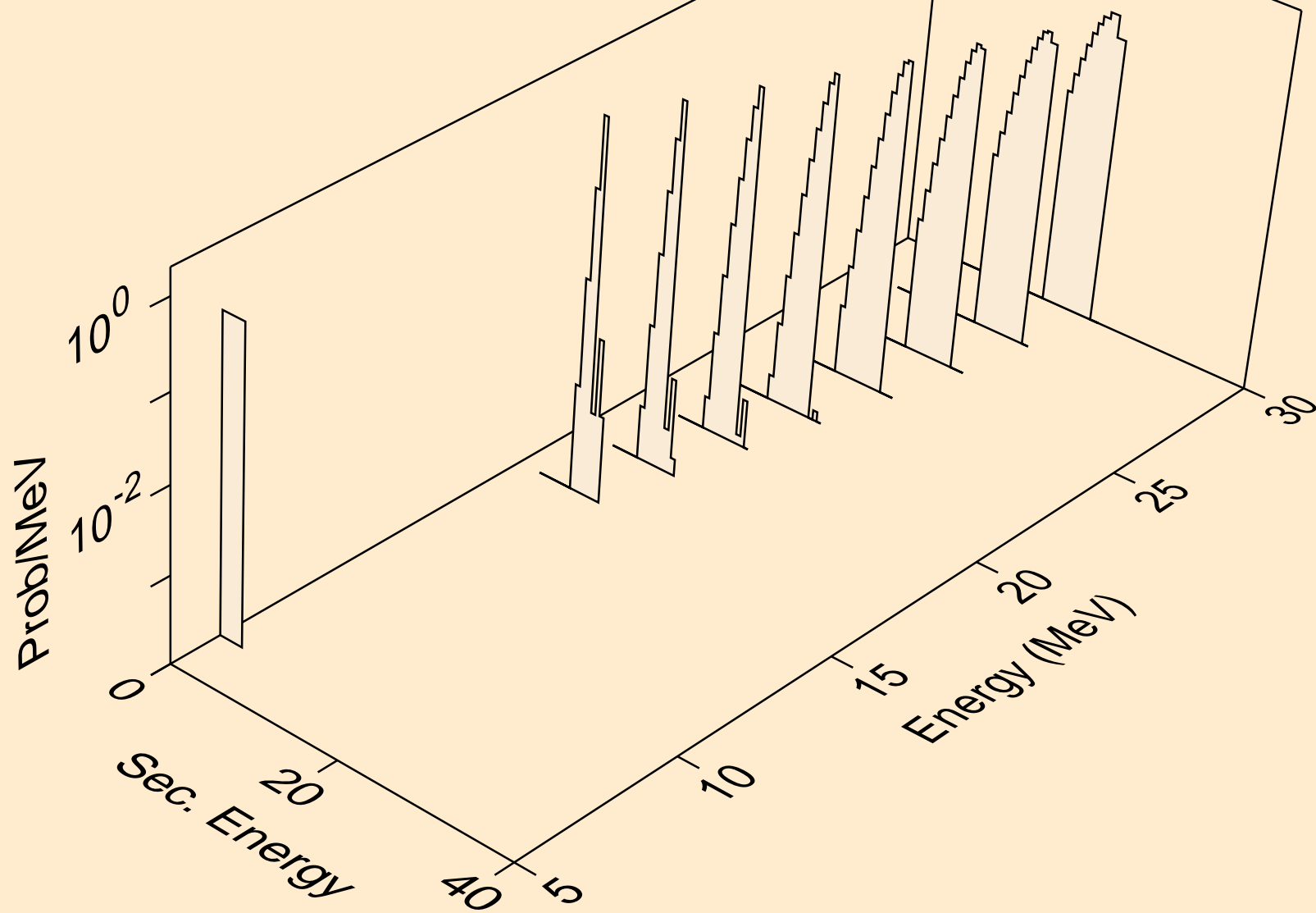

TL213 TRITON ACER TENDL-2021 LIBRARY; T=0.K
alphas from (t,x)

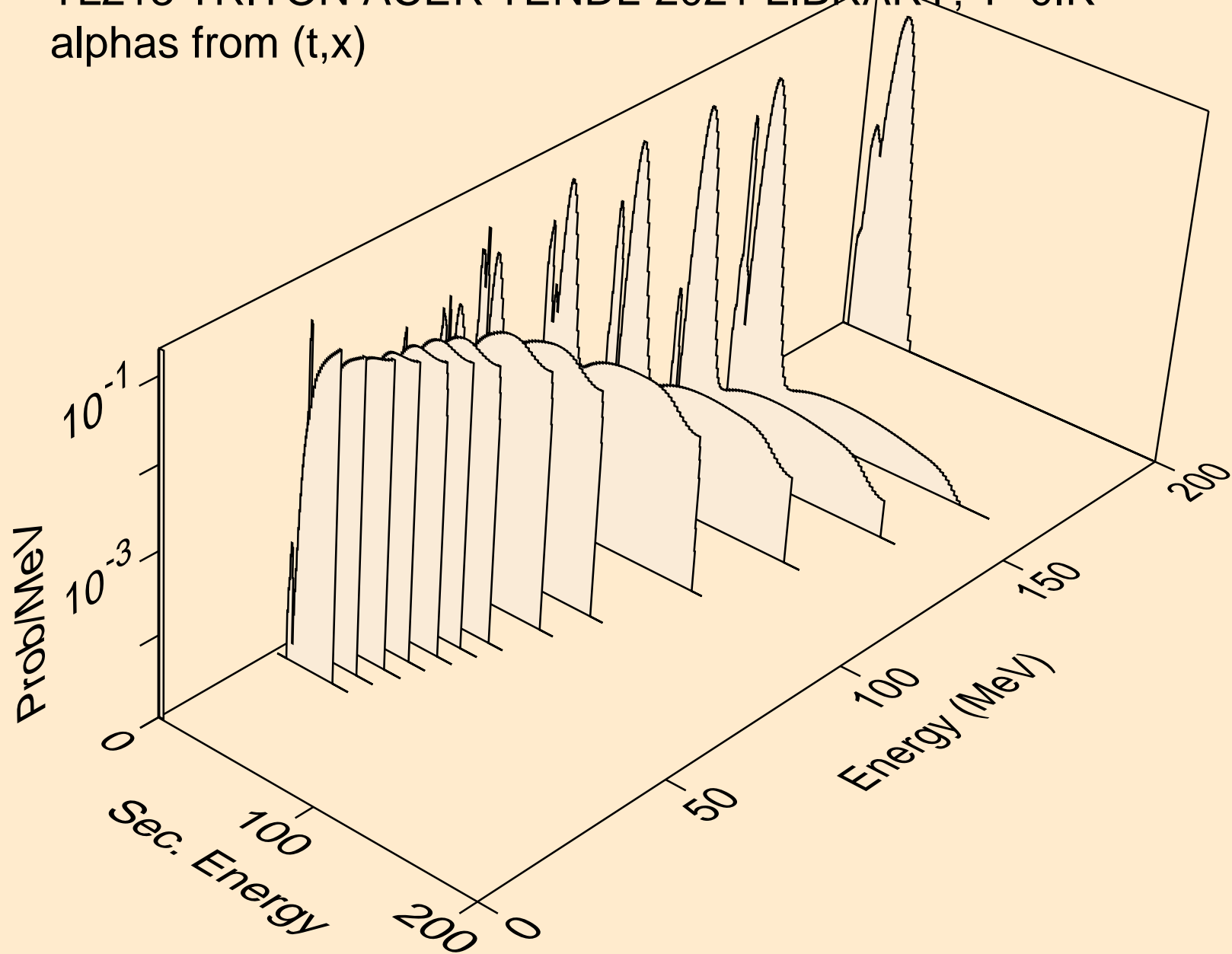

TL213 TRITON ACER TENDL-2021 LIBRARY; T=0.K
alphas from (t,n*)a

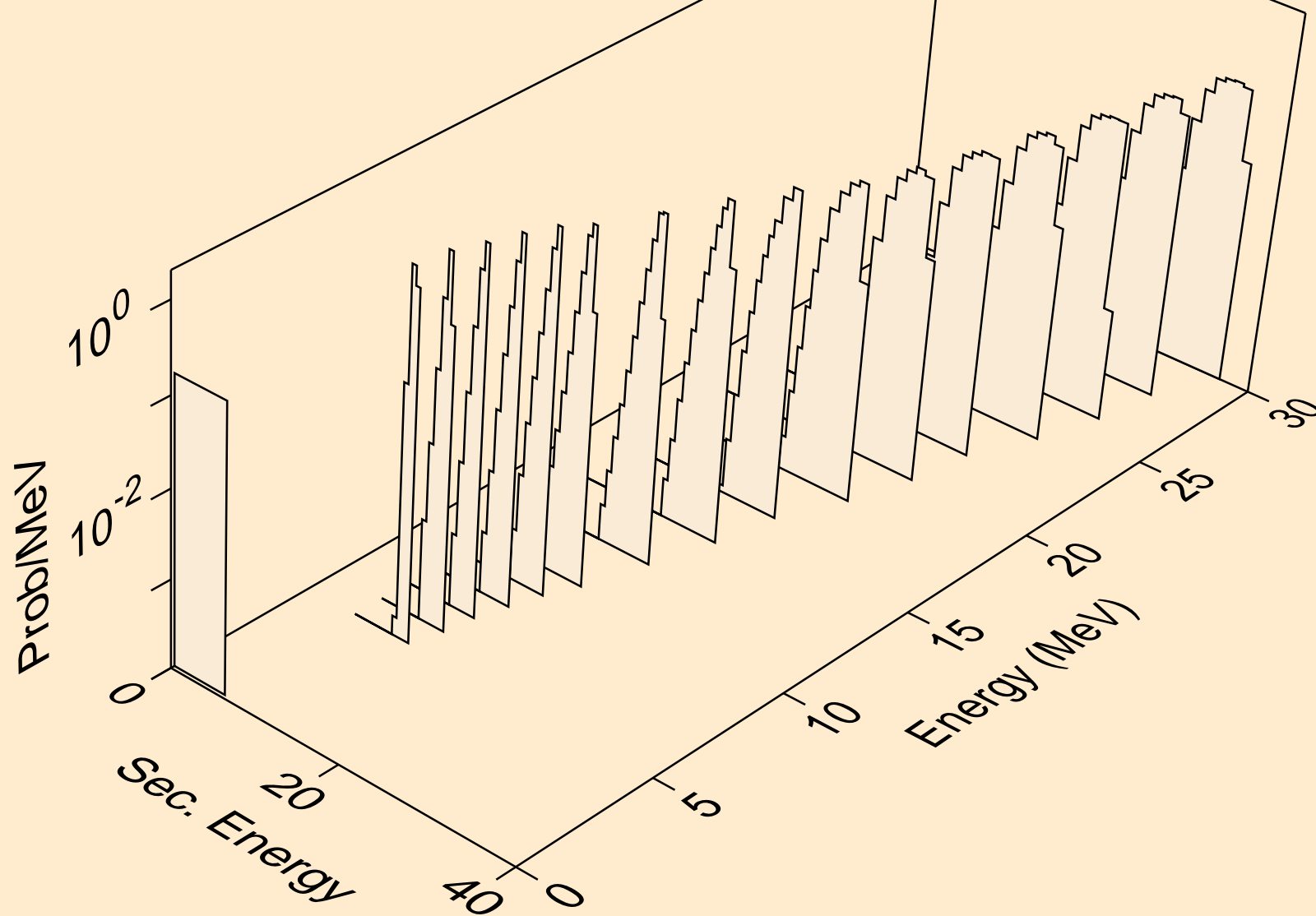

TL213 TRITON ACER TENDL-2021 LIBRARY; T=0.K
alphas from (t,2n)a

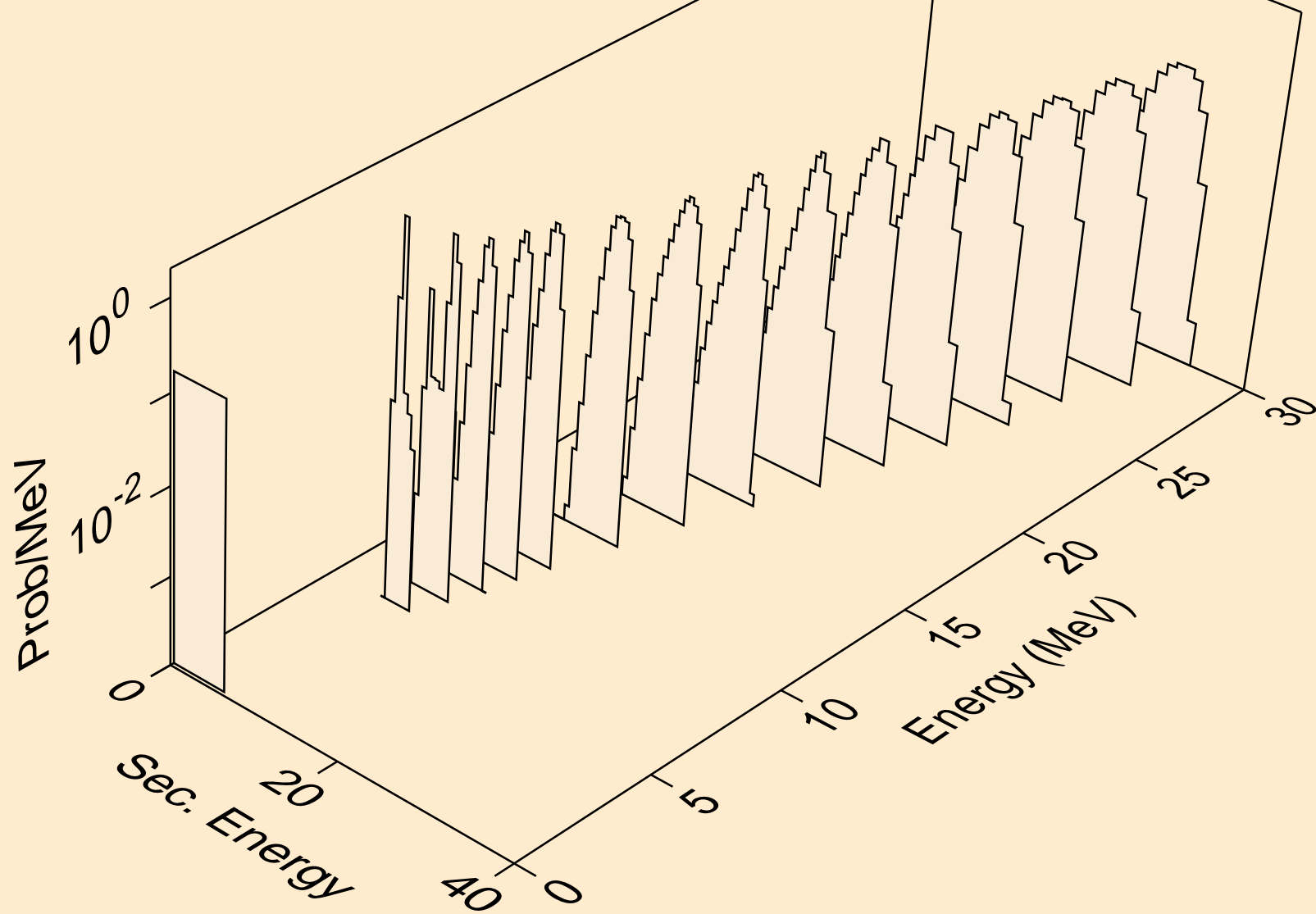

TL213 TRITON ACER TENDL-2021 LIBRARY; T=0.K
alphas from (t,3n)a

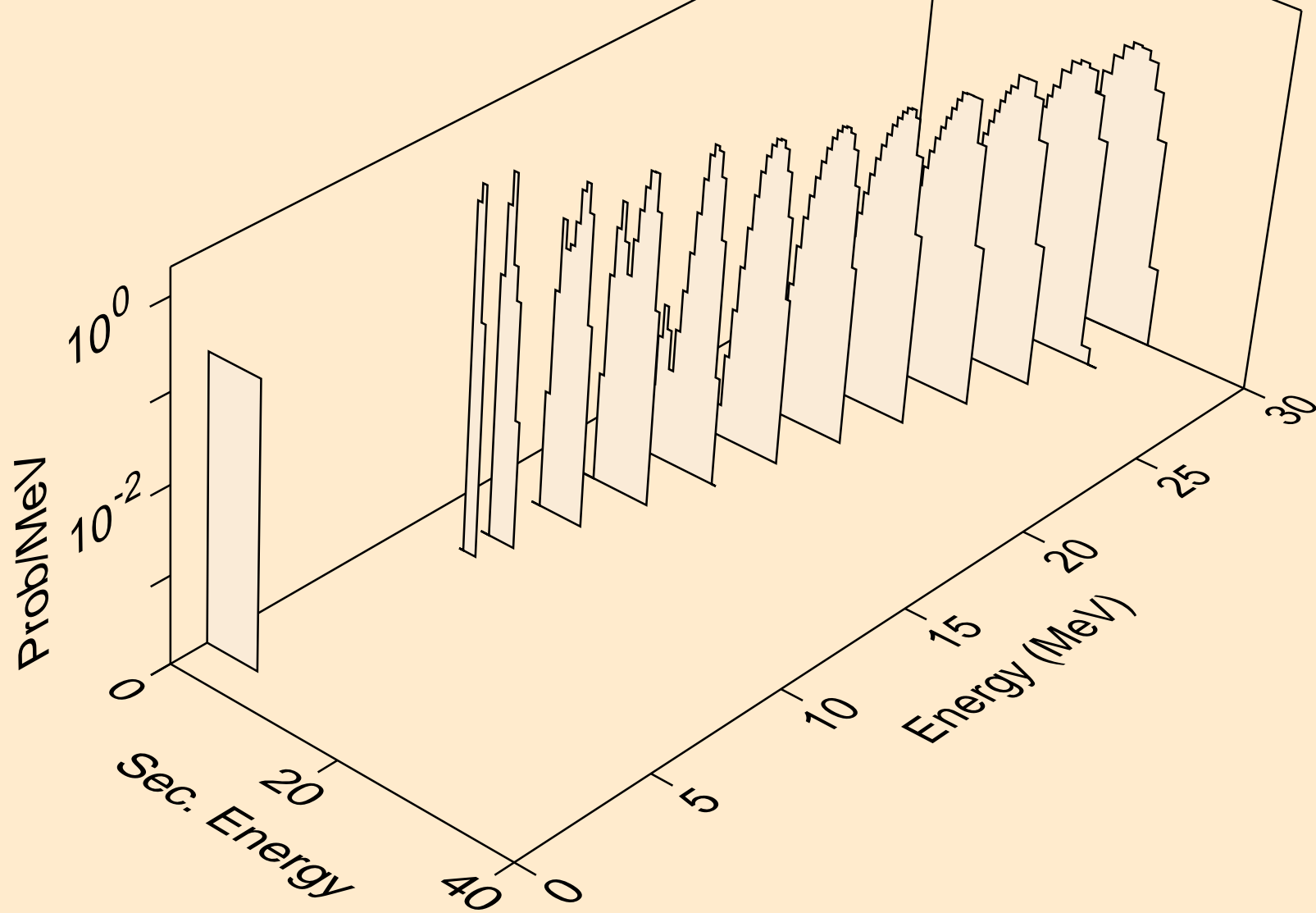

TL213 TRITON ACER TENDL-2021 LIBRARY; T=0.K
alphas from (t,a)

