

W172 TRITON ACER TENDL-2021 LIBRARY; T=0.K  
Principal cross sections

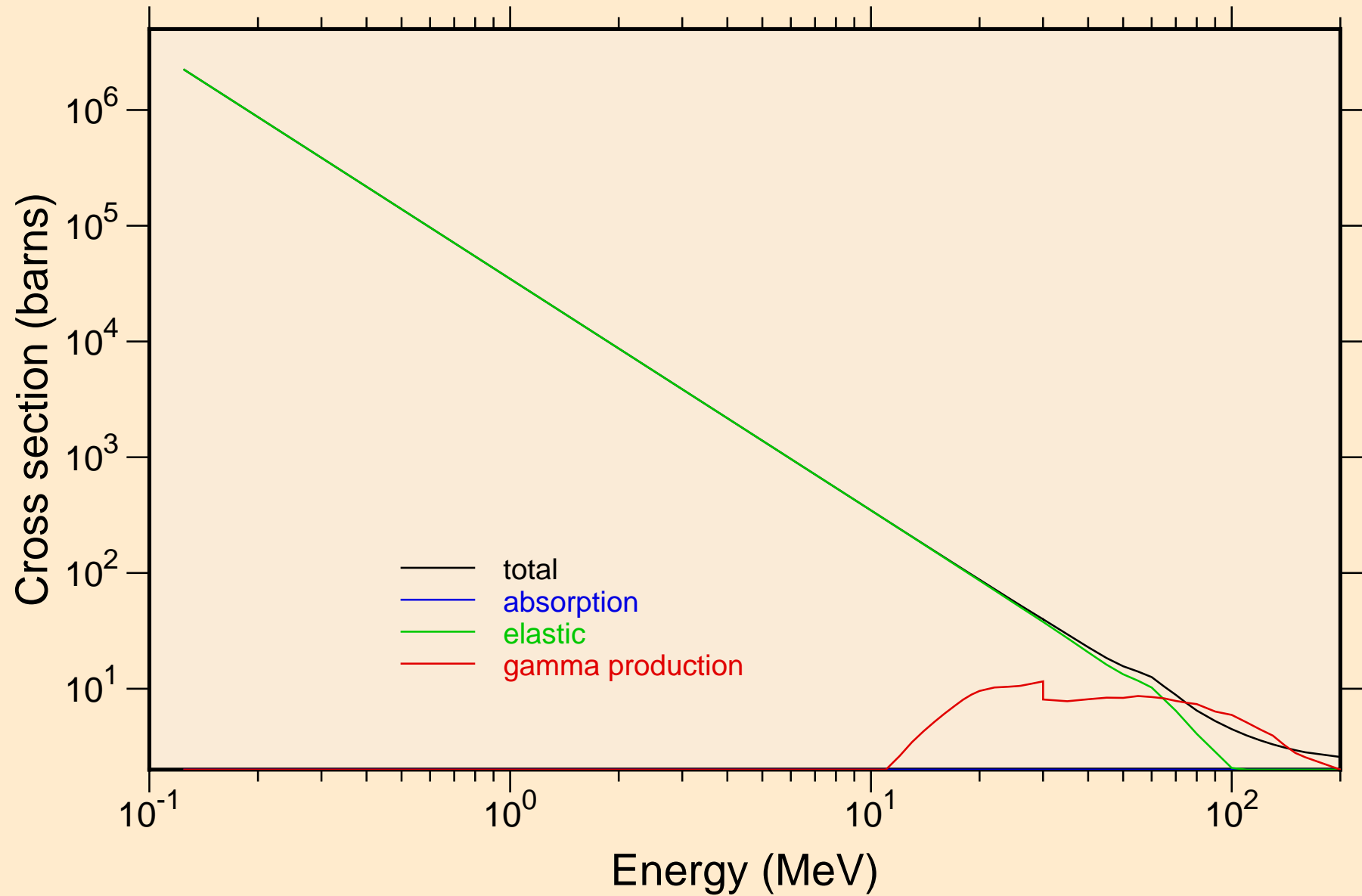

W172 TRITON ACER TENDL-2021 LIBRARY; T=0.K

Heating

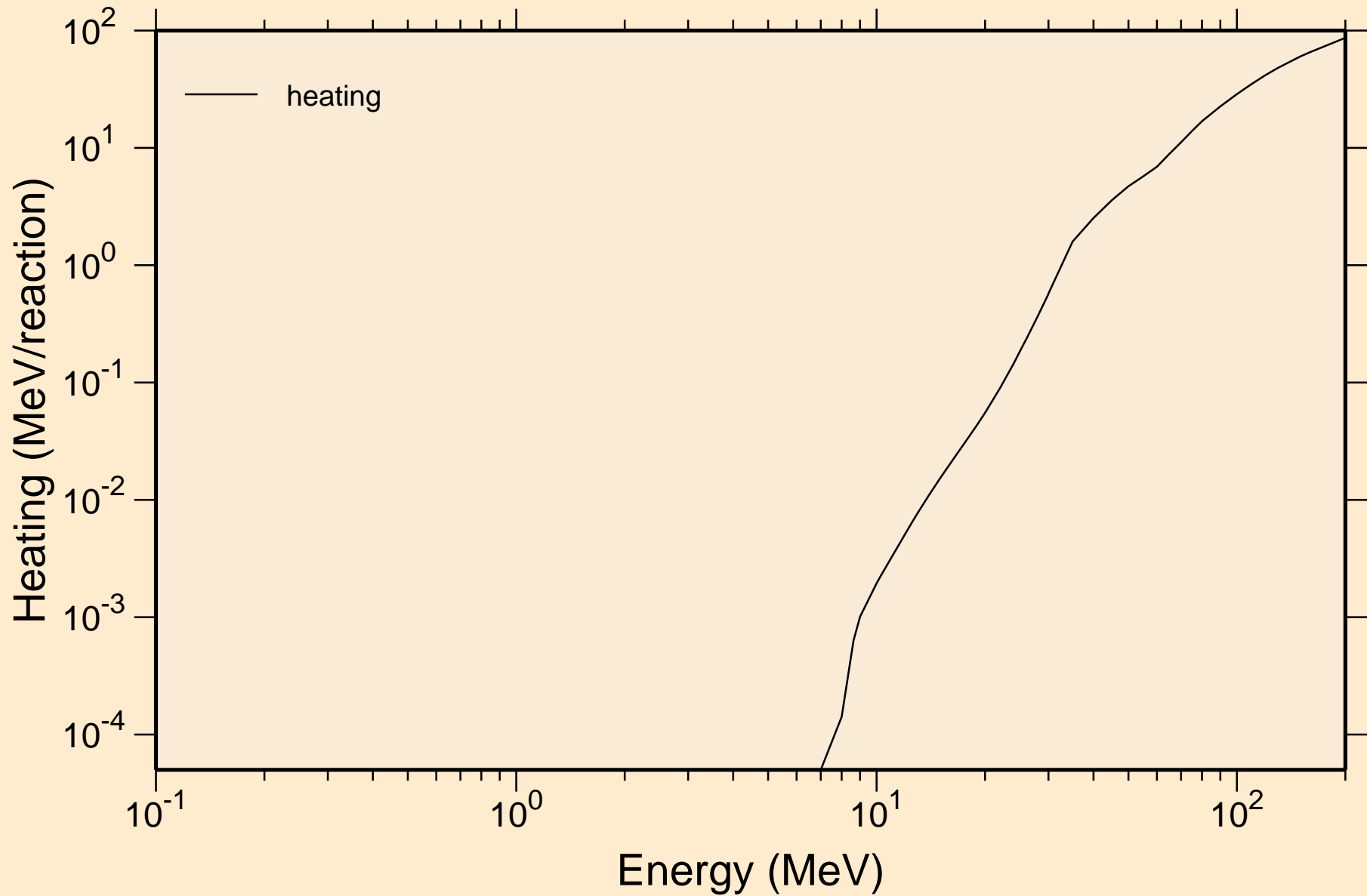

# W172 TRITON ACER TENDL-2021 LIBRARY; T=0.K

## Principal cross sections

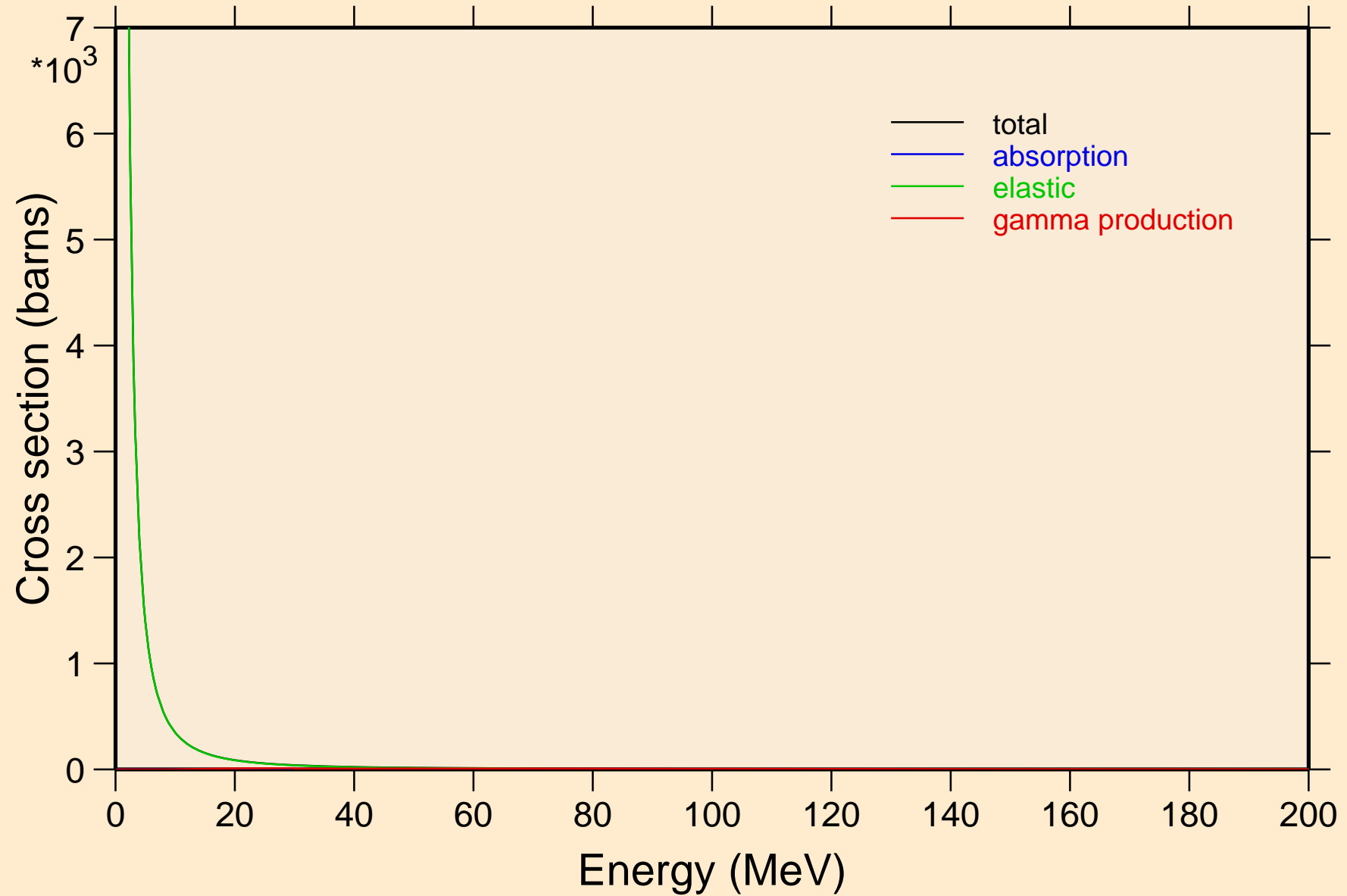

W172 TRITON ACER TENDL-2021 LIBRARY; T=0.K

Heating

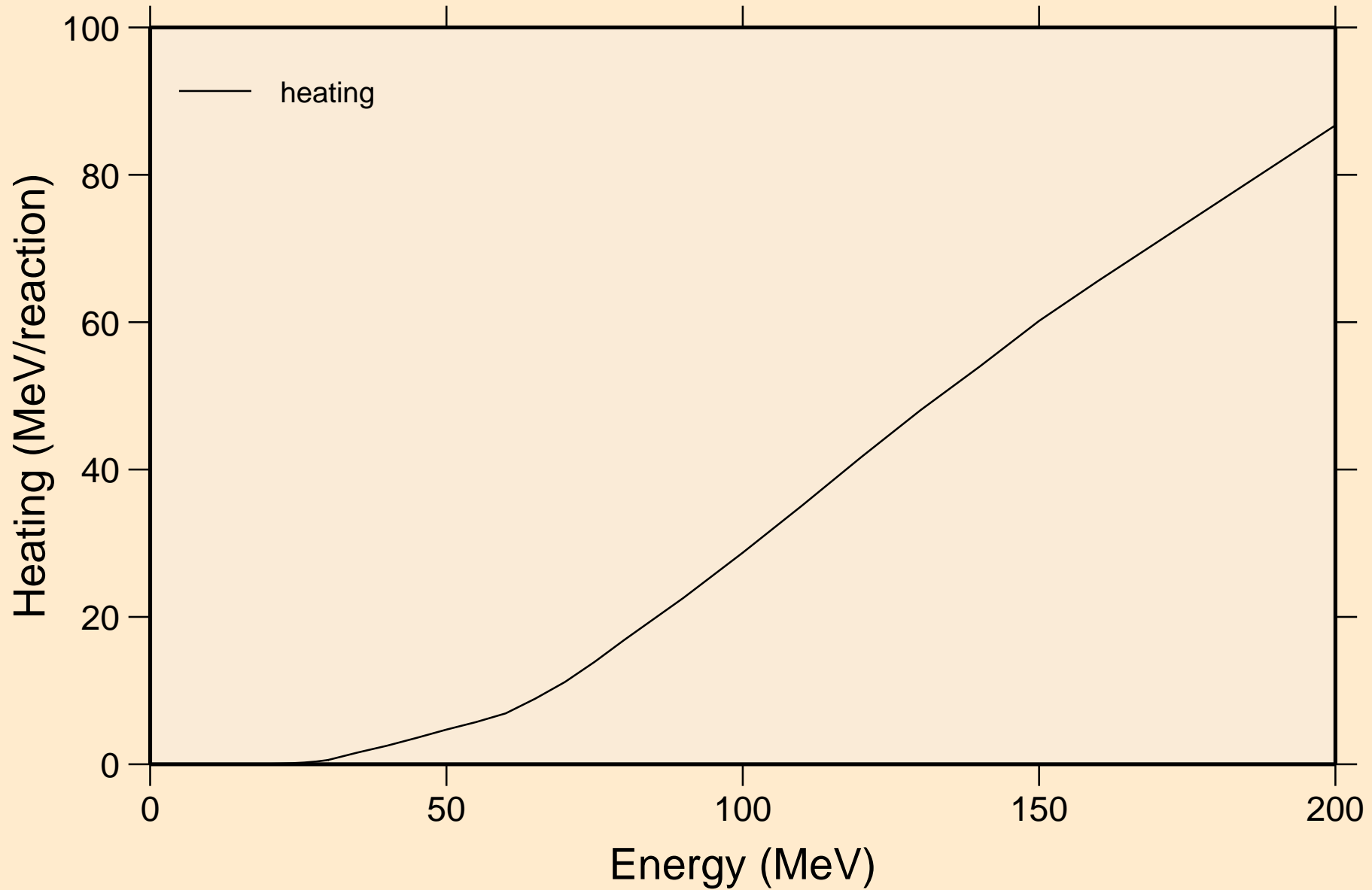

W172 TRITON ACER TENDL-2021 LIBRARY; T=0.K  
Threshold reactions

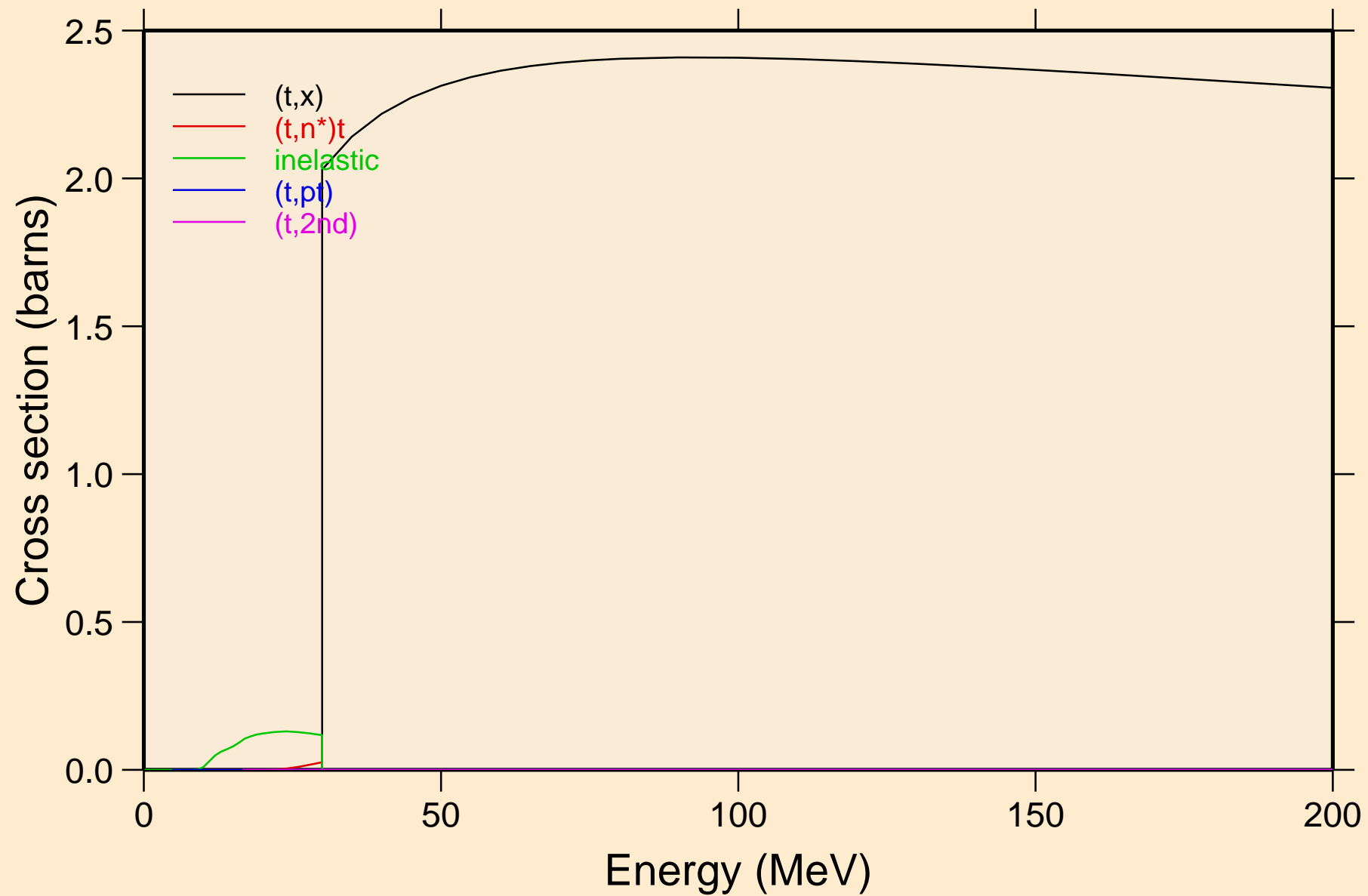

W172 TRITON ACER TENDL-2021 LIBRARY; T=0.K  
Threshold reactions

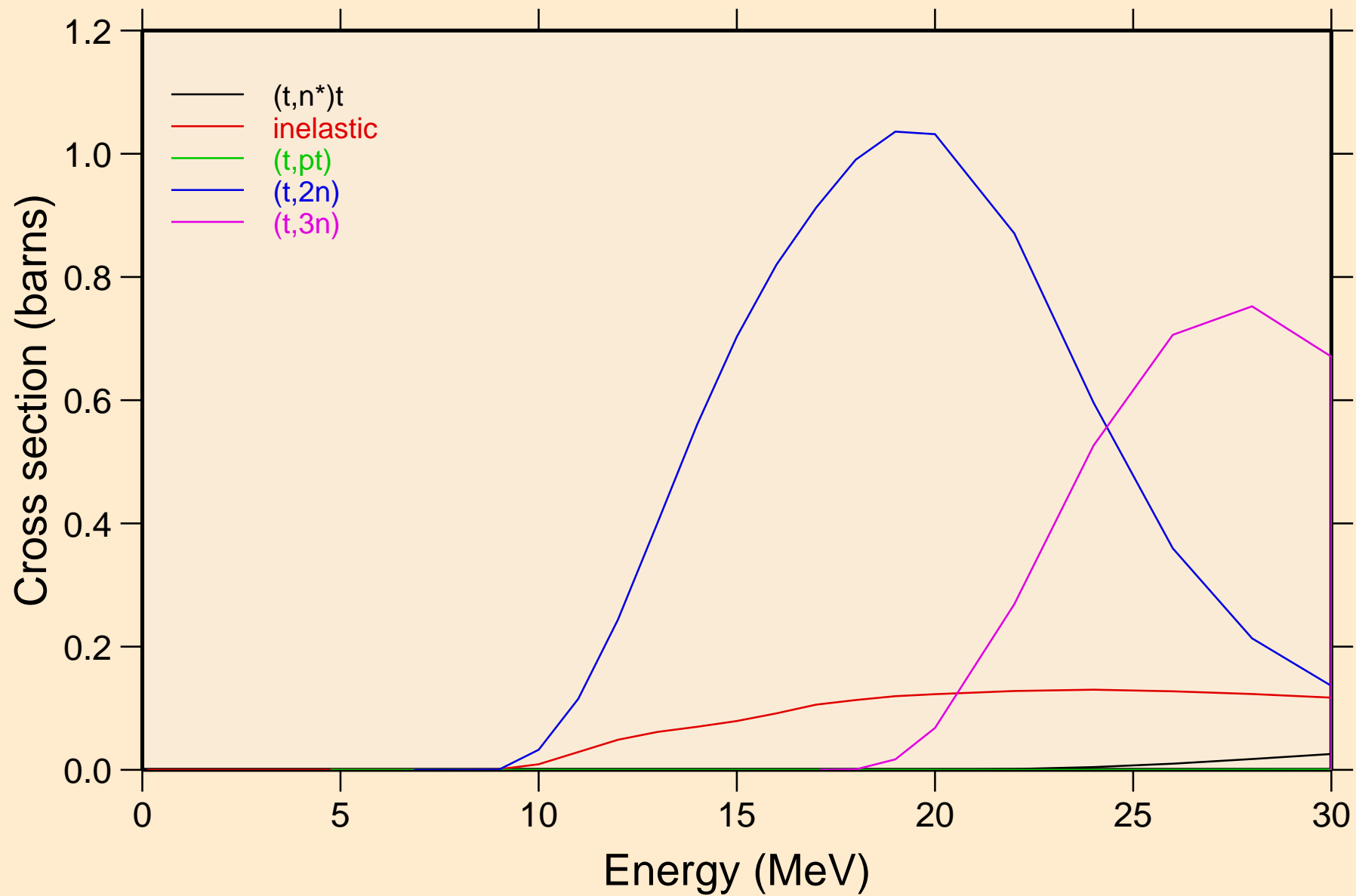

W172 TRITON ACER TENDL-2021 LIBRARY; T=0.K  
Threshold reactions

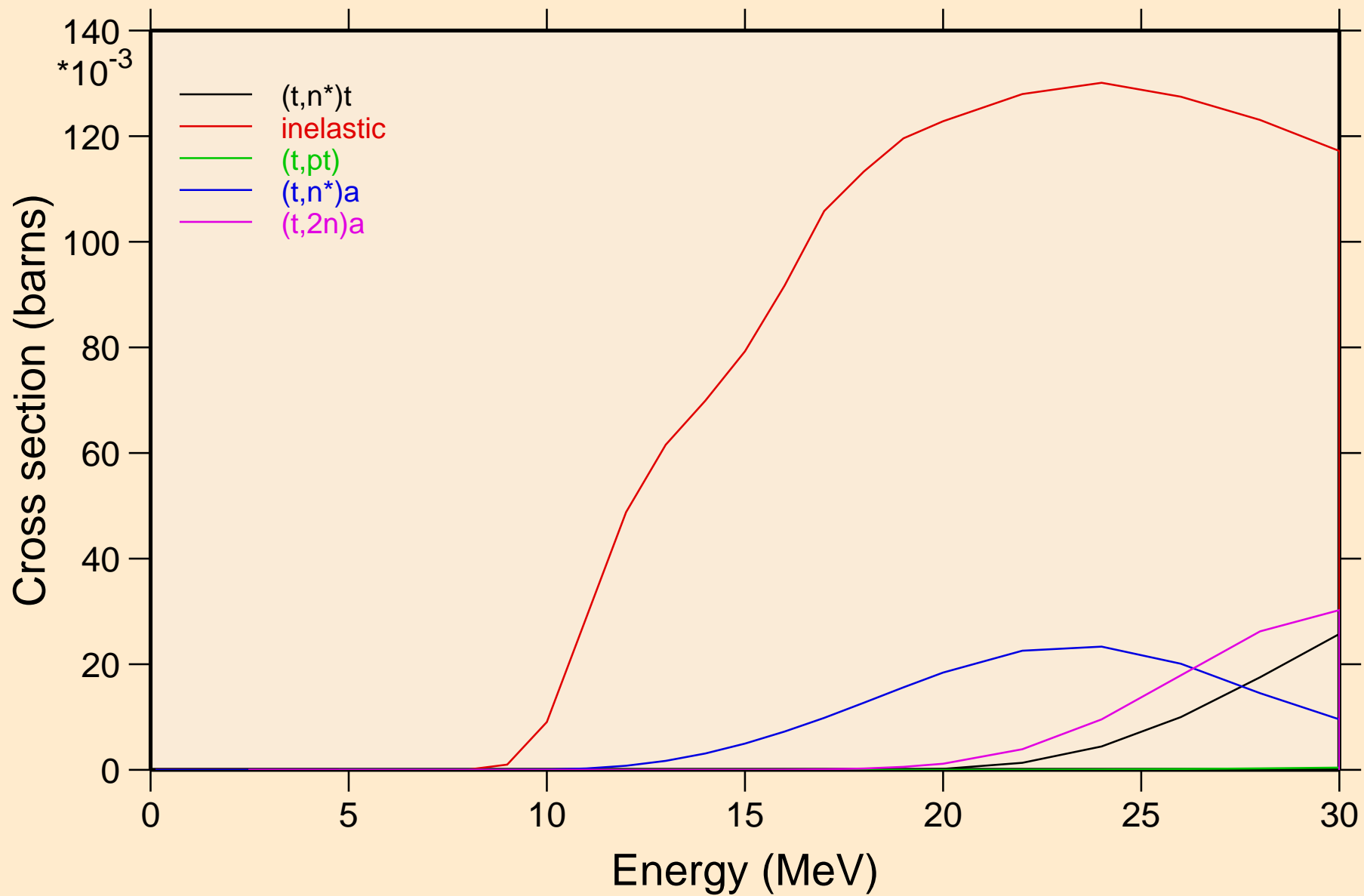

W172 TRITON ACER TENDL-2021 LIBRARY; T=0.K  
Threshold reactions

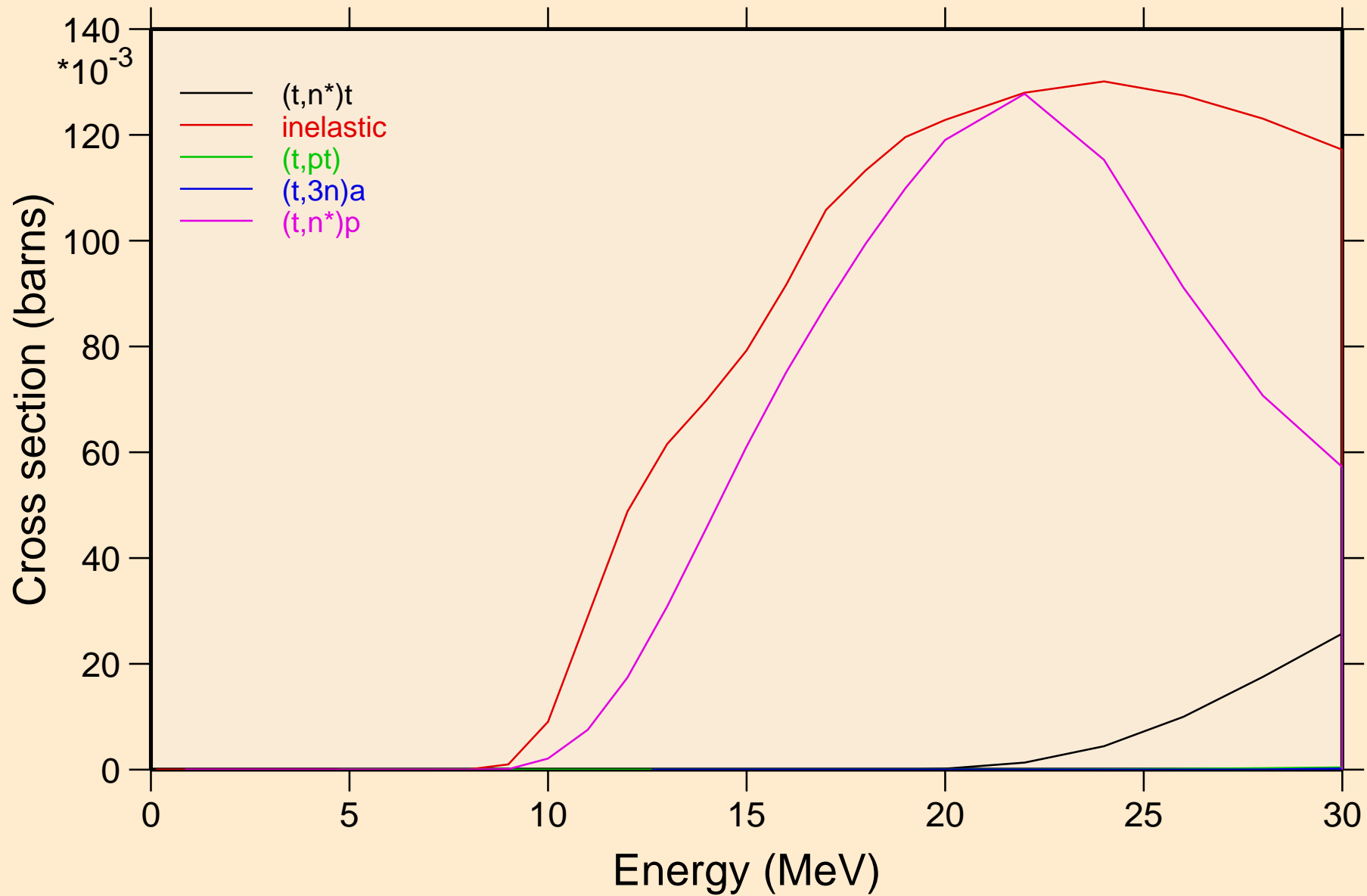



W172 TRITON ACER TENDL-2021 LIBRARY; T=0.K  
Threshold reactions

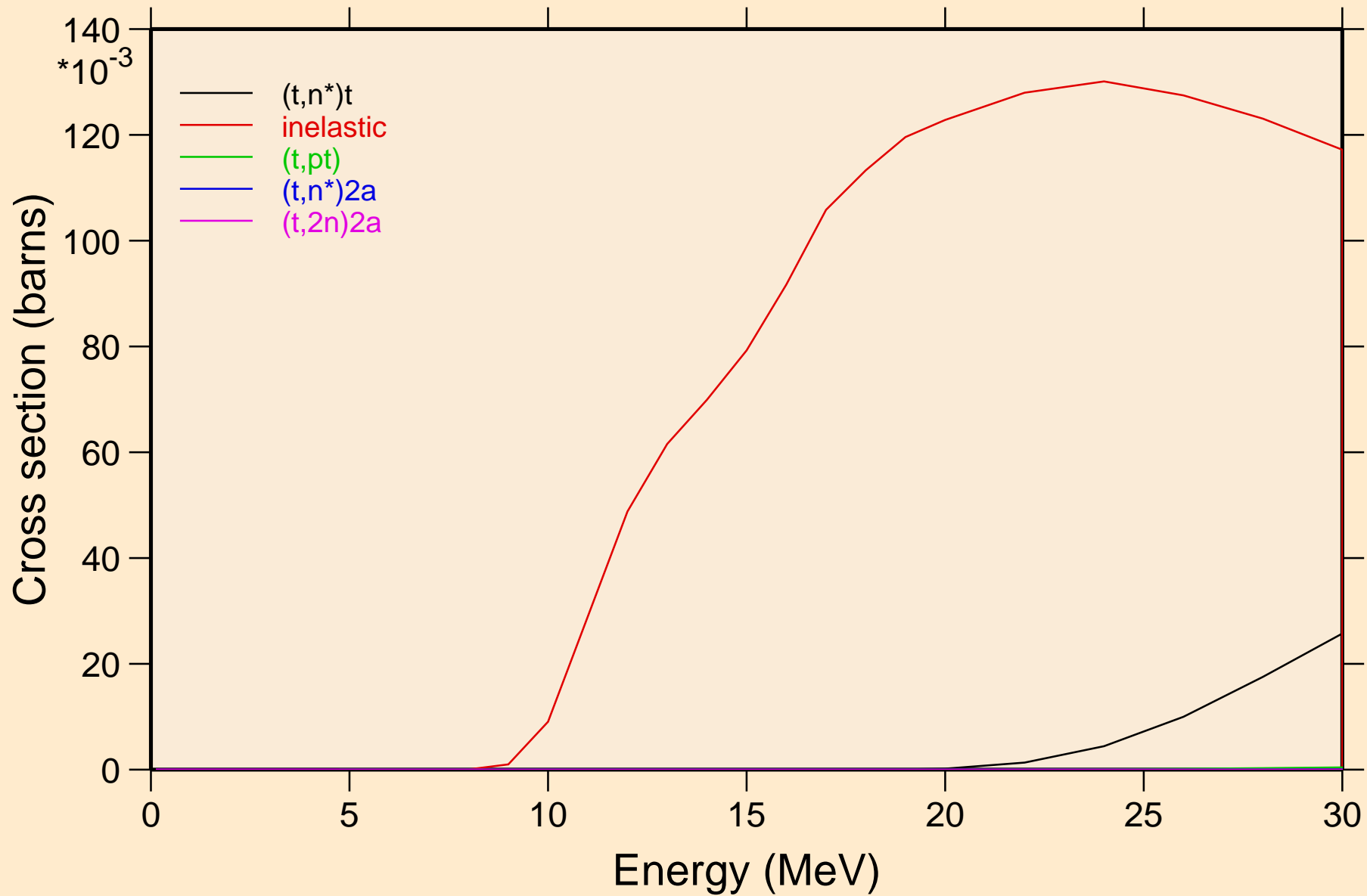

W172 TRITON ACER TENDL-2021 LIBRARY; T=0.K  
Threshold reactions

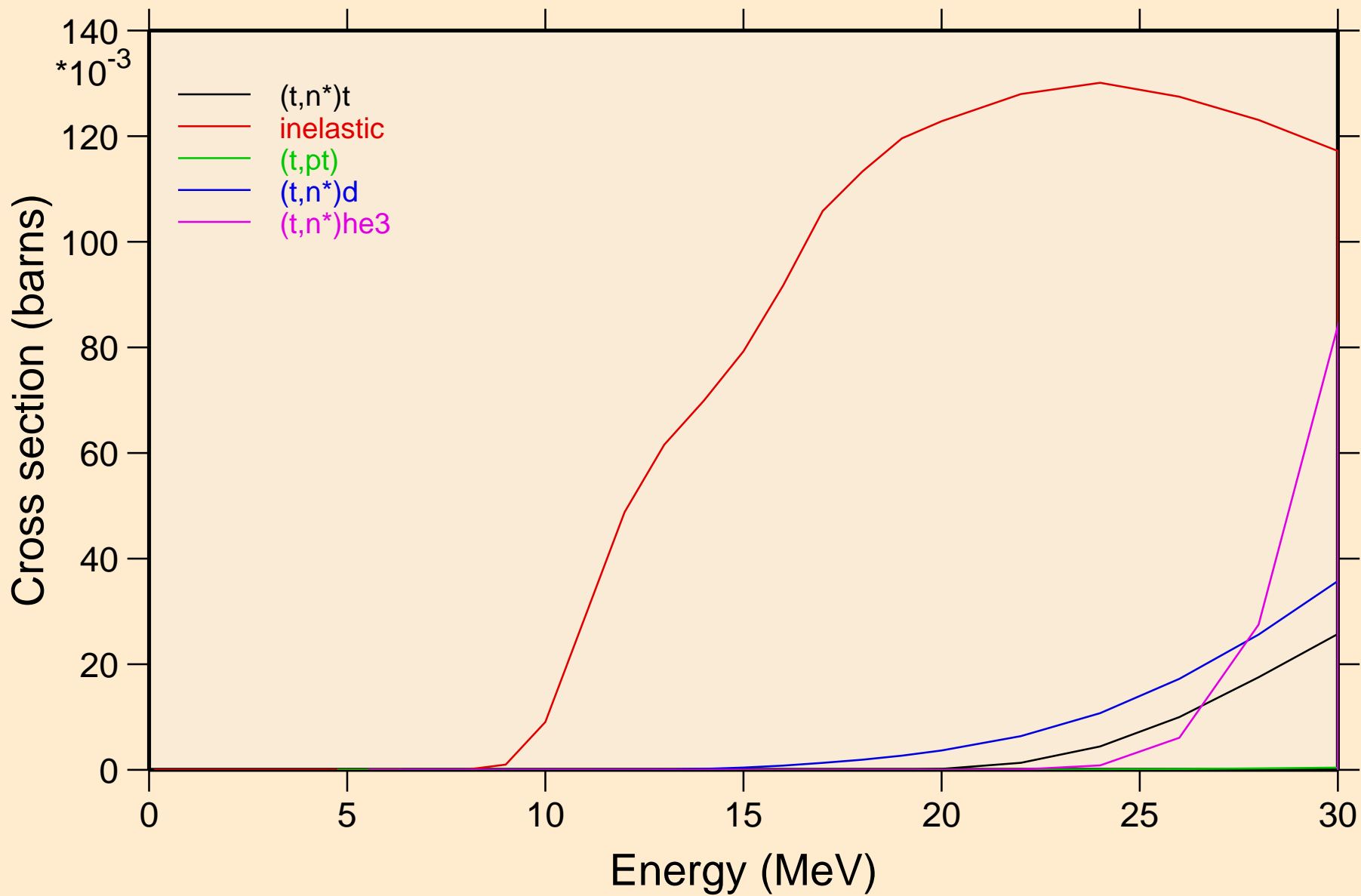

W172 TRITON ACER TENDL-2021 LIBRARY; T=0.K  
Threshold reactions

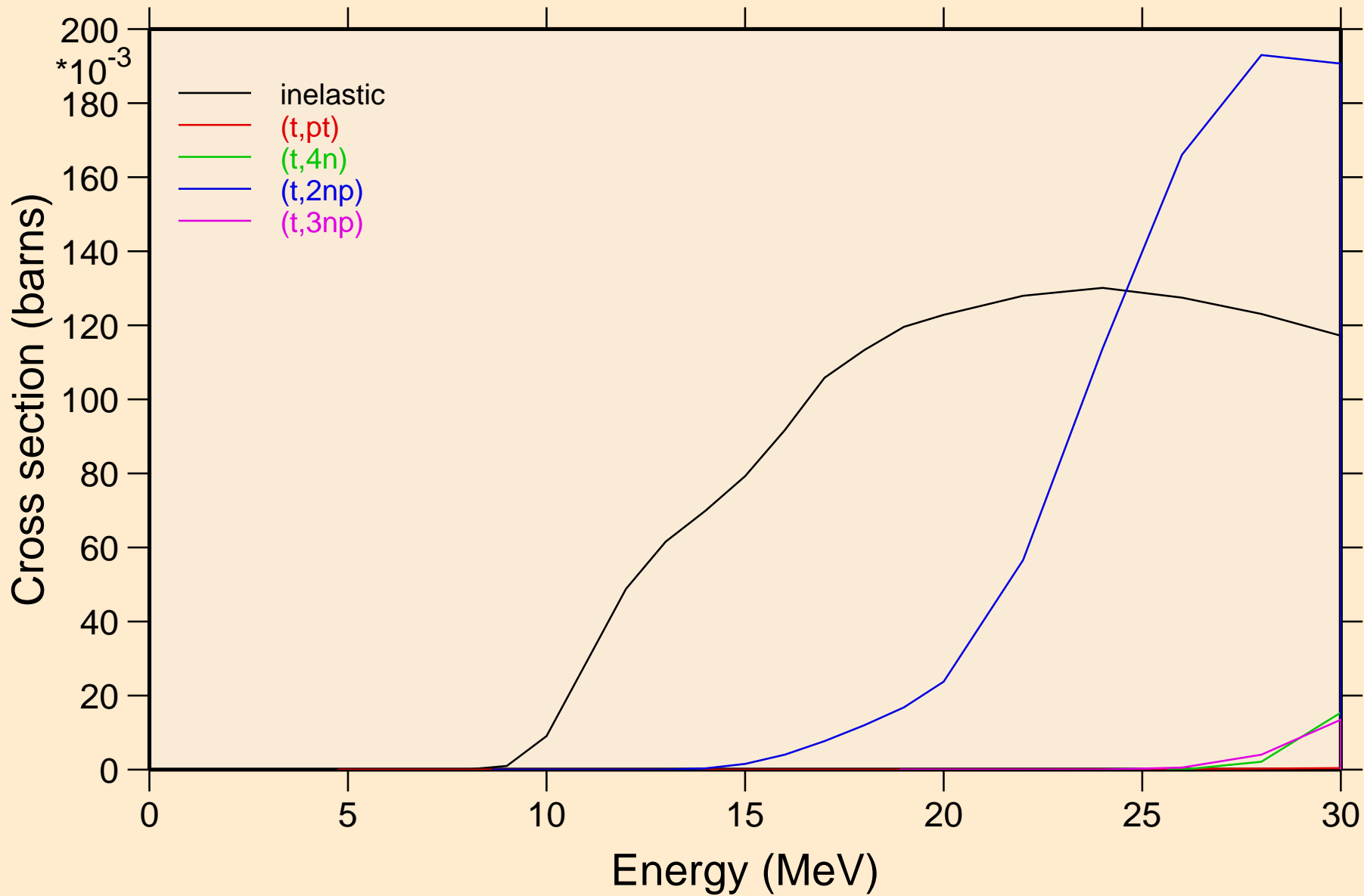

W172 TRITON ACER TENDL-2021 LIBRARY; T=0.K  
Threshold reactions

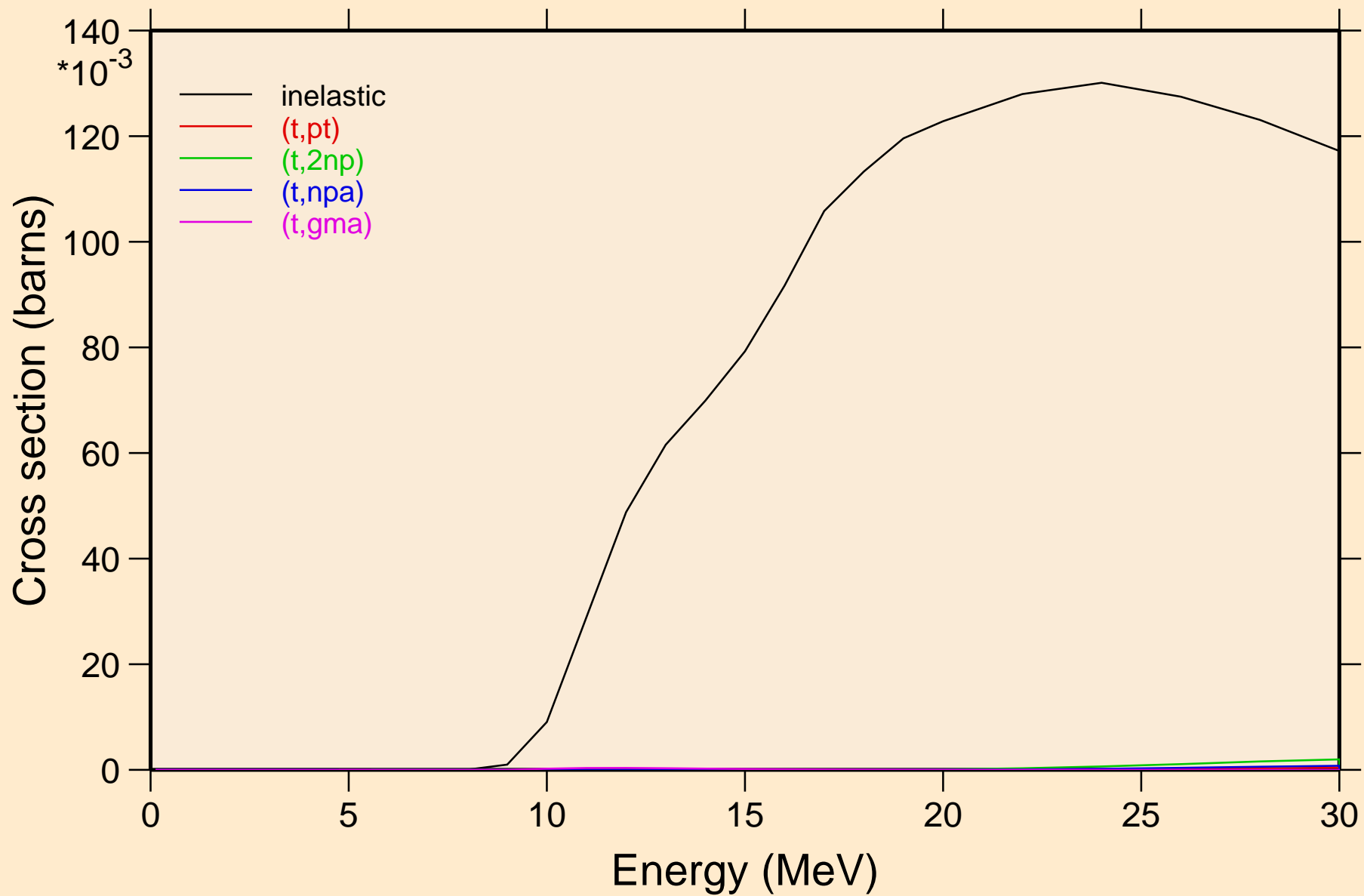

W172 TRITON ACER TENDL-2021 LIBRARY; T=0.K  
Threshold reactions

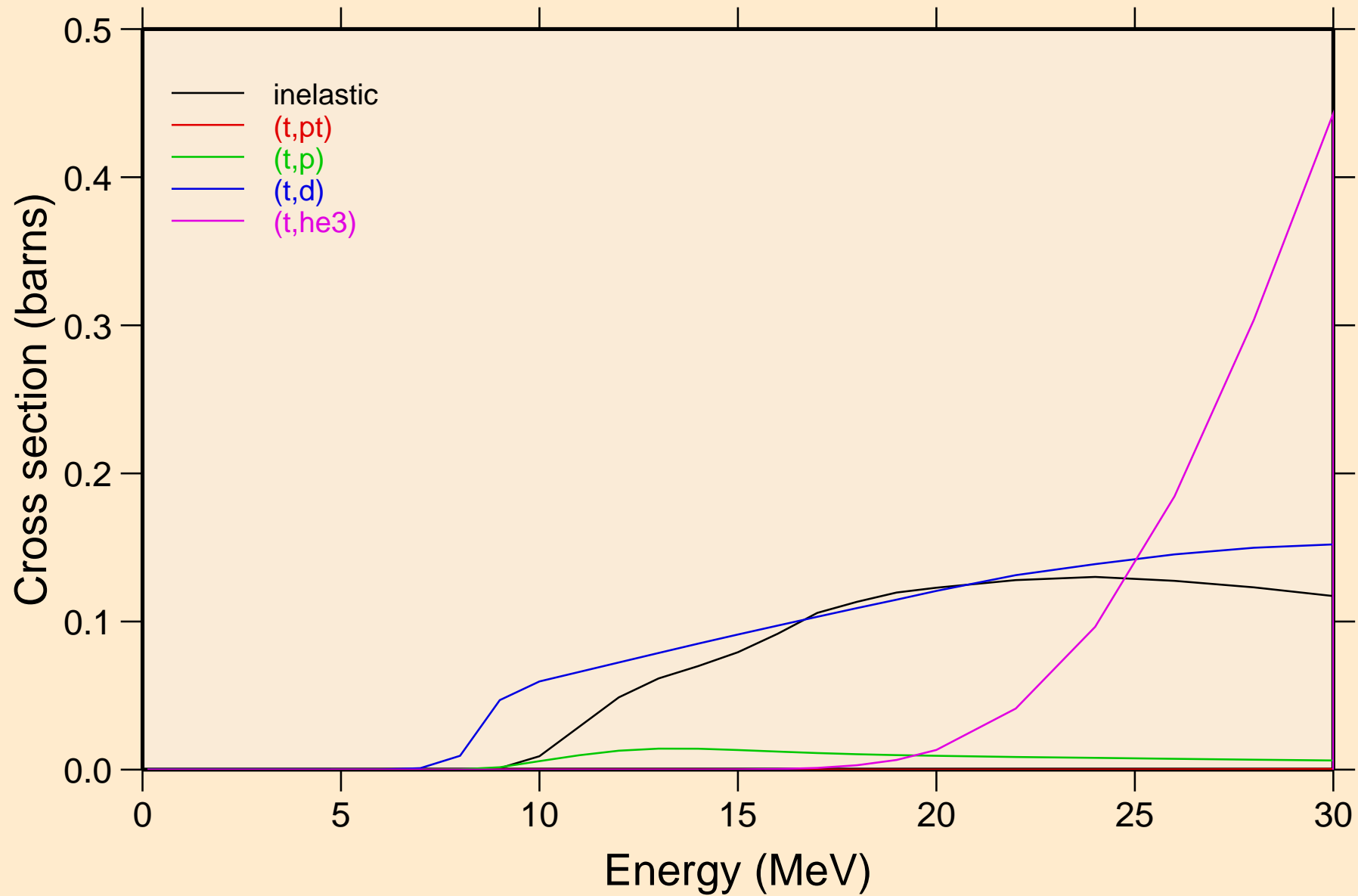

W172 TRITON ACER TENDL-2021 LIBRARY; T=0.K  
Threshold reactions

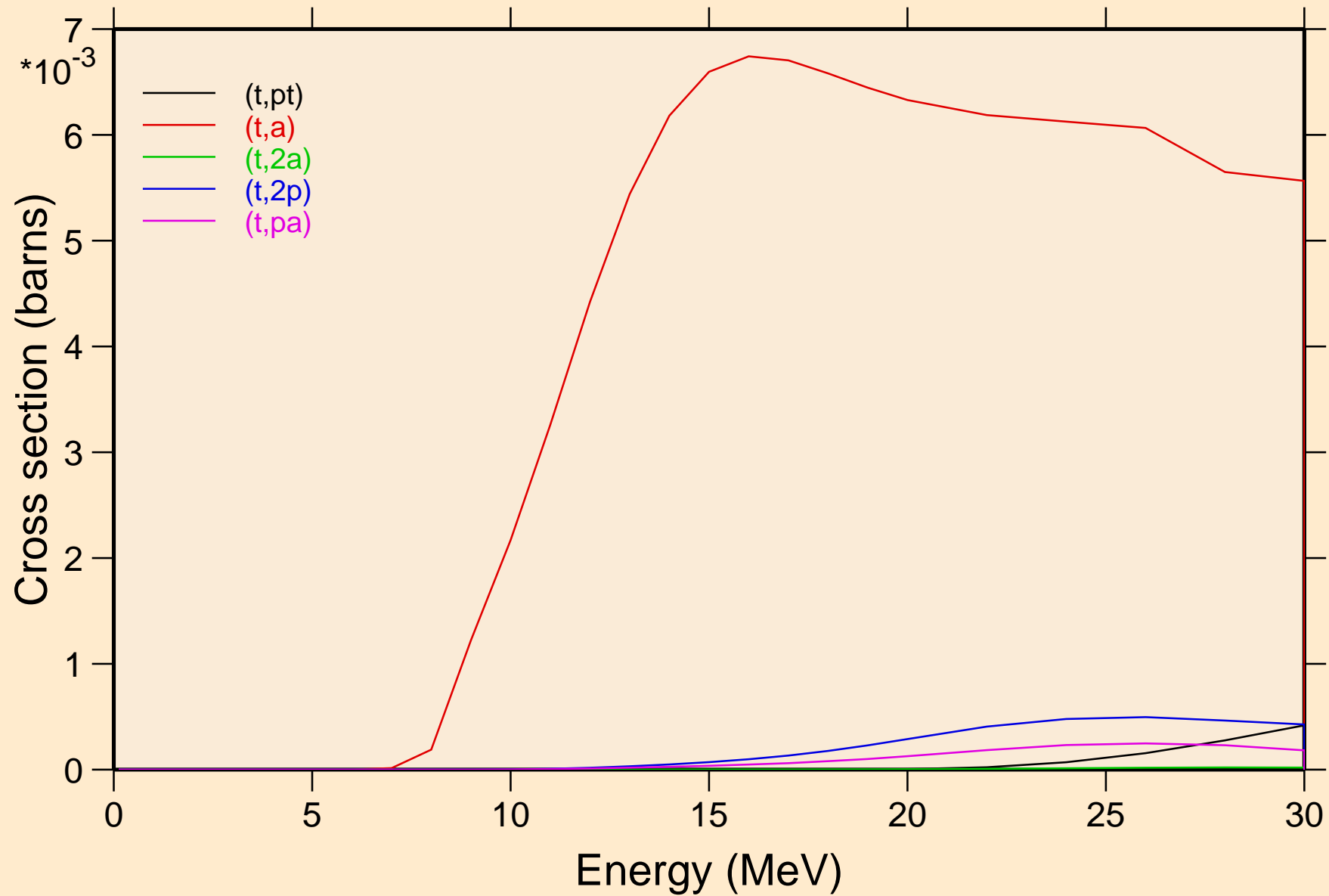

W172 TRITON ACER TENDL-2021 LIBRARY; T=0.K  
Threshold reactions

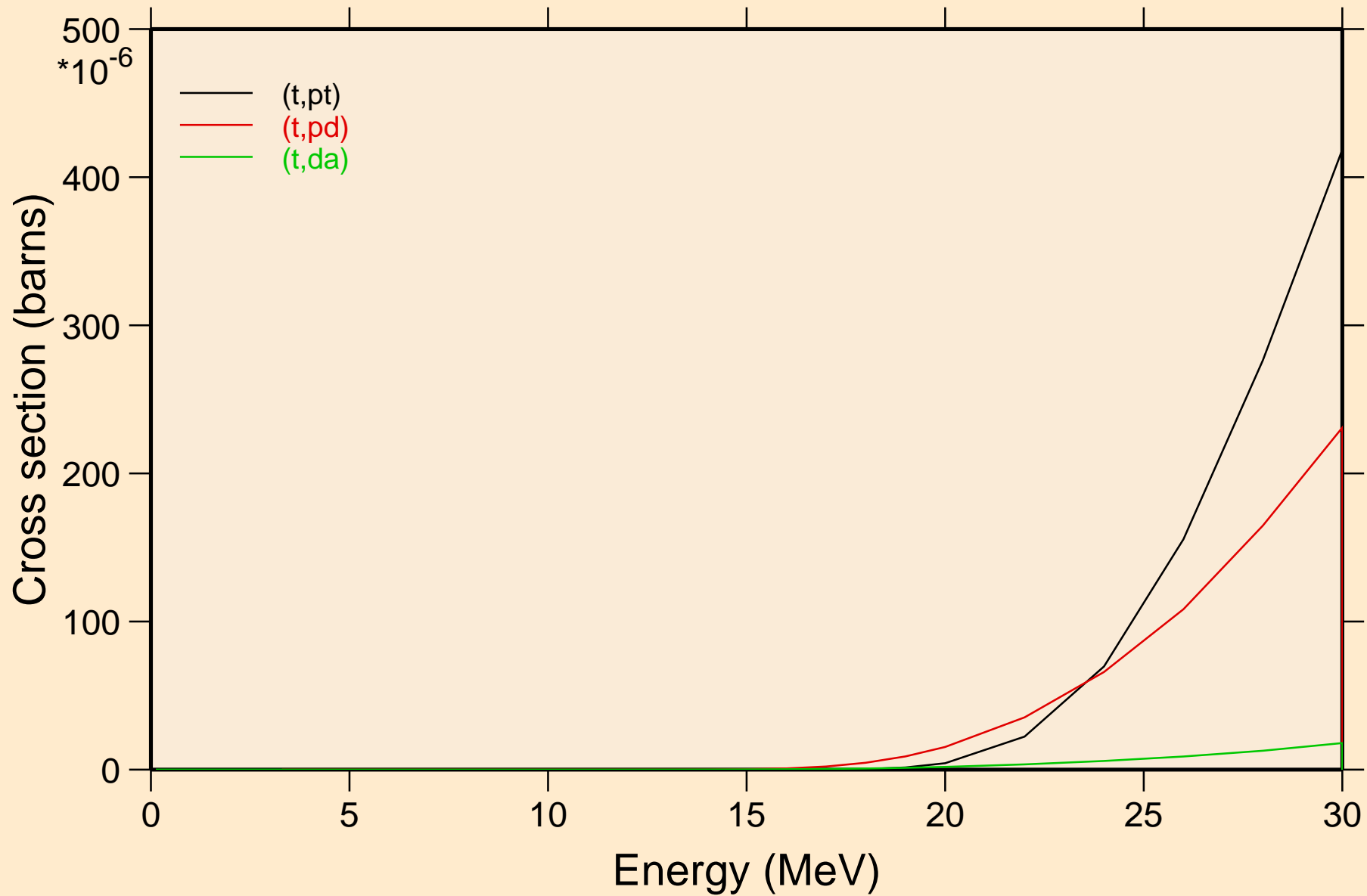

W172 TRITON ACER TENDL-2021 LIBRARY; T=0.K  
angular distribution for elastic

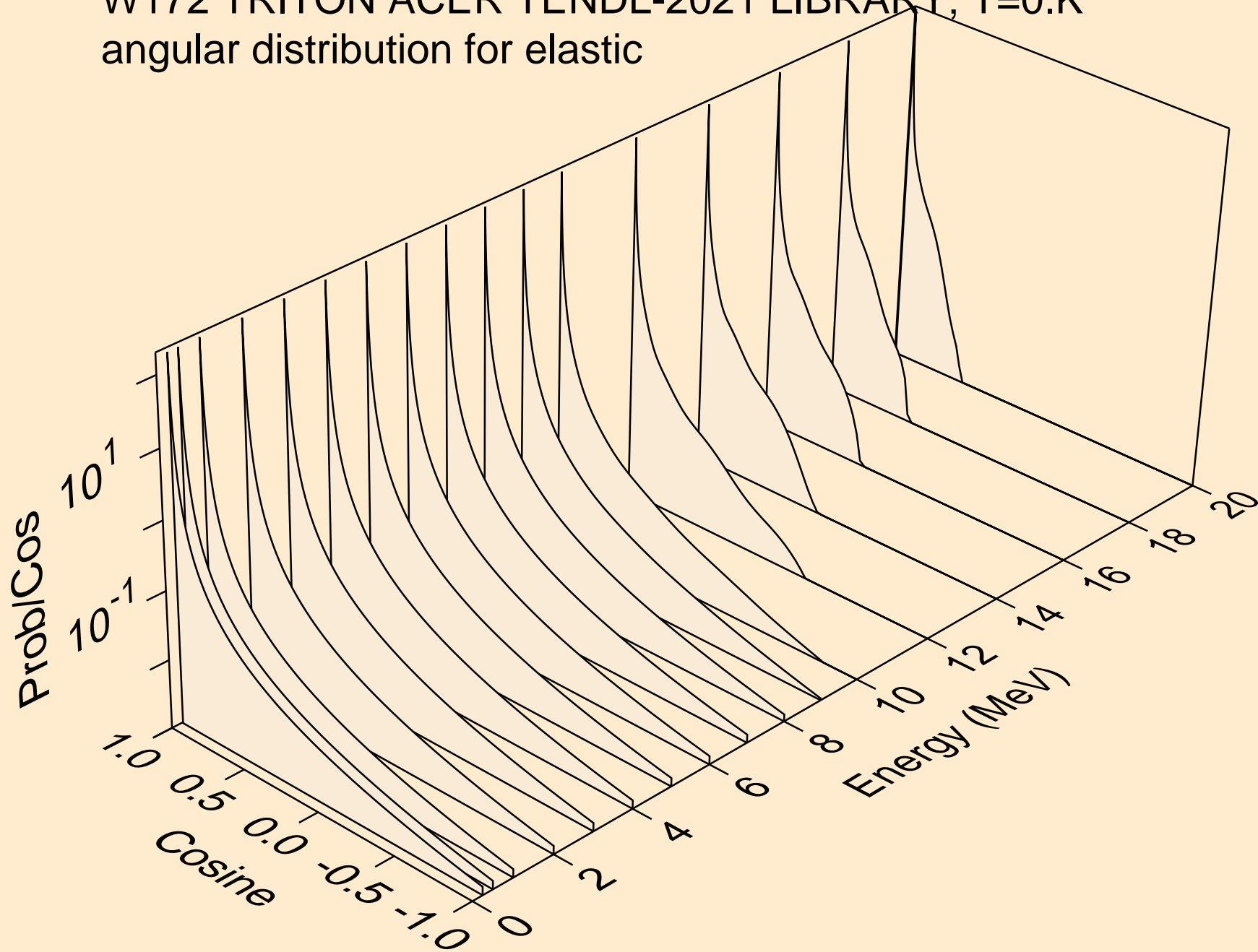



W172 TRITON ACER TENDL-2021 LIBRARY; T=0.K  
angular distribution for elastic

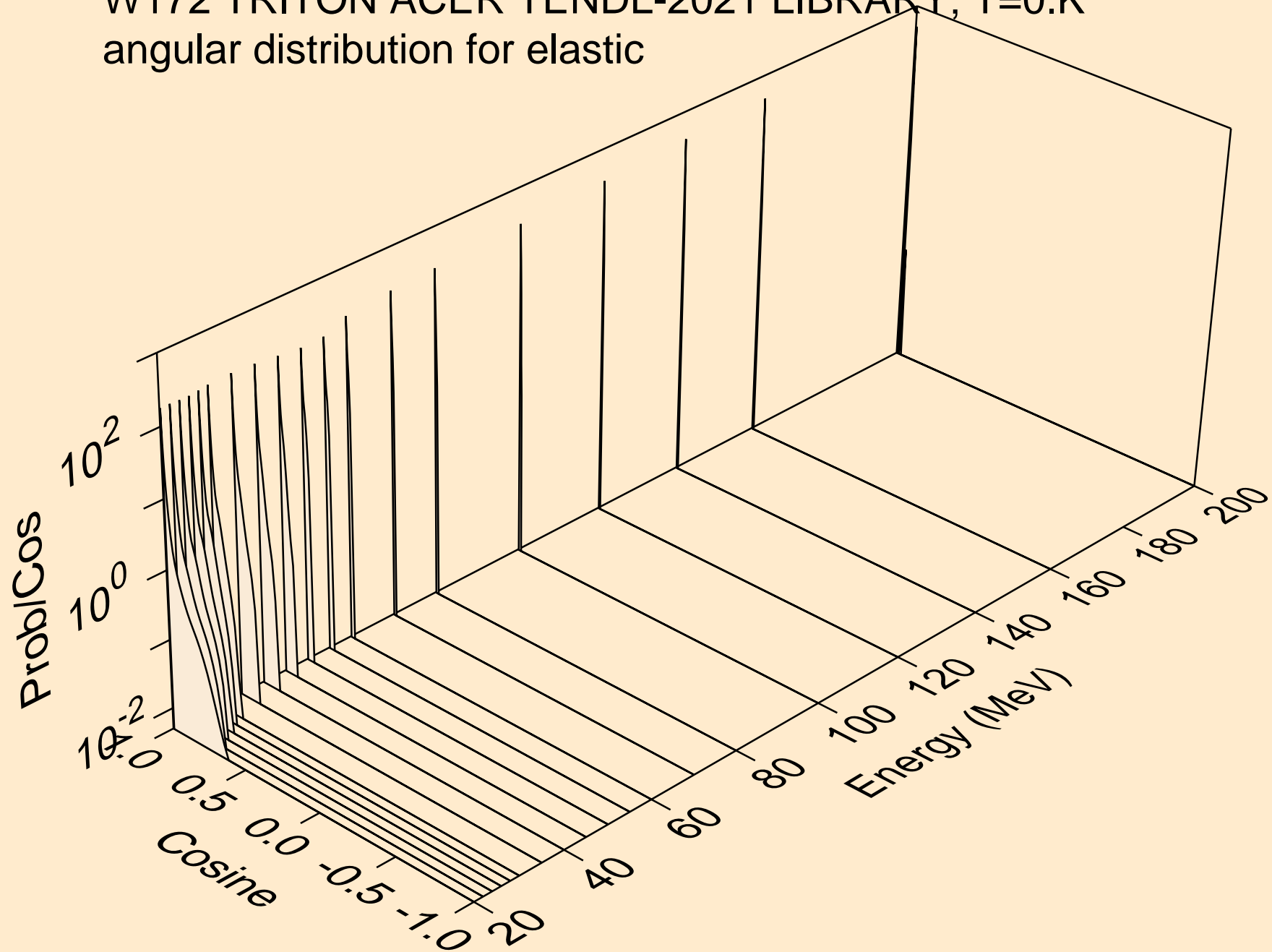

W172 TRITON ACER TENDL-2021 LIBRARY; T=0.K  
Triton emission for (t,x)

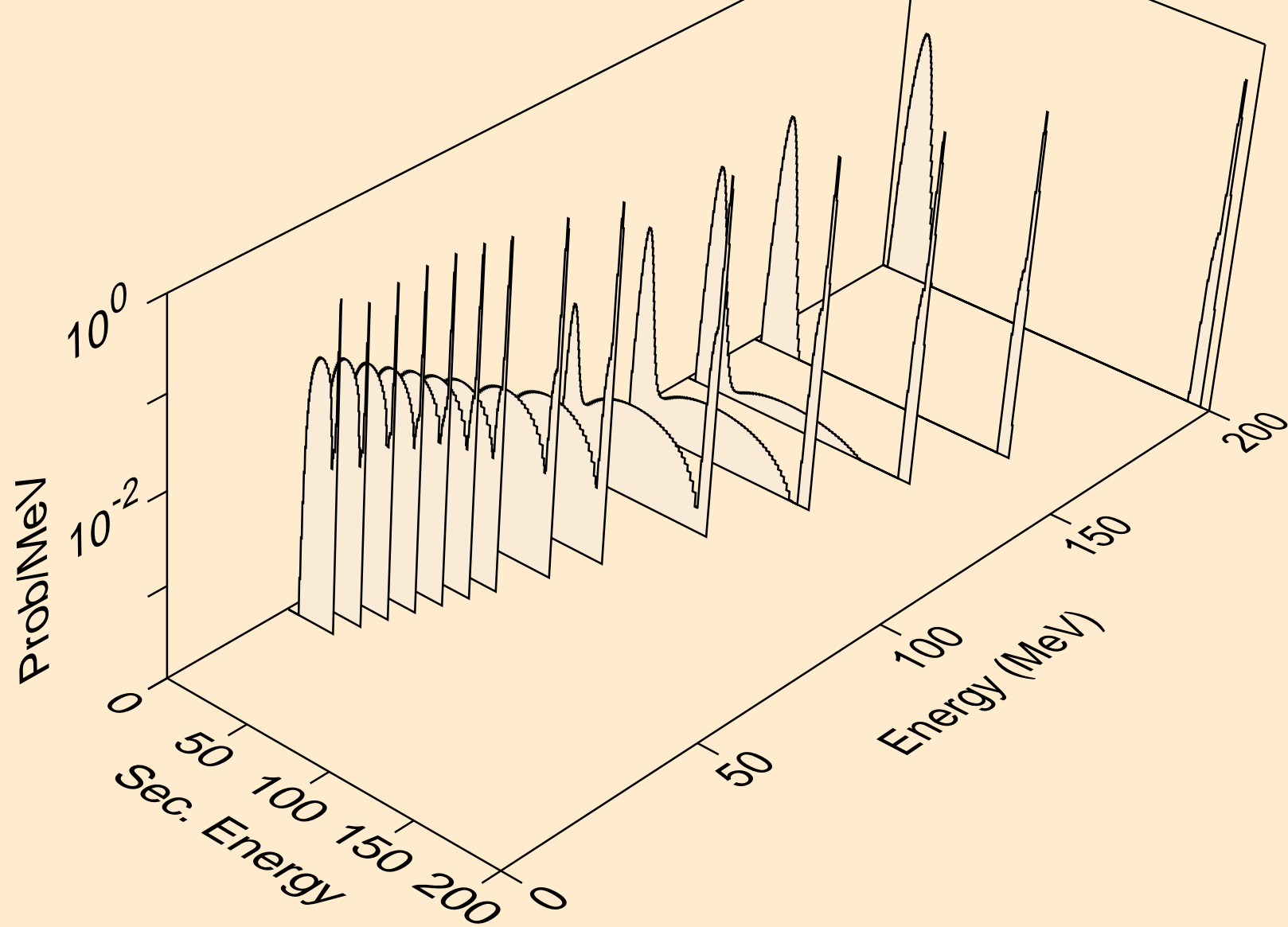

W172 TRITON ACER TENDL-2021 LIBRARY; T=0.K  
Triton emission for (t,n\*)t

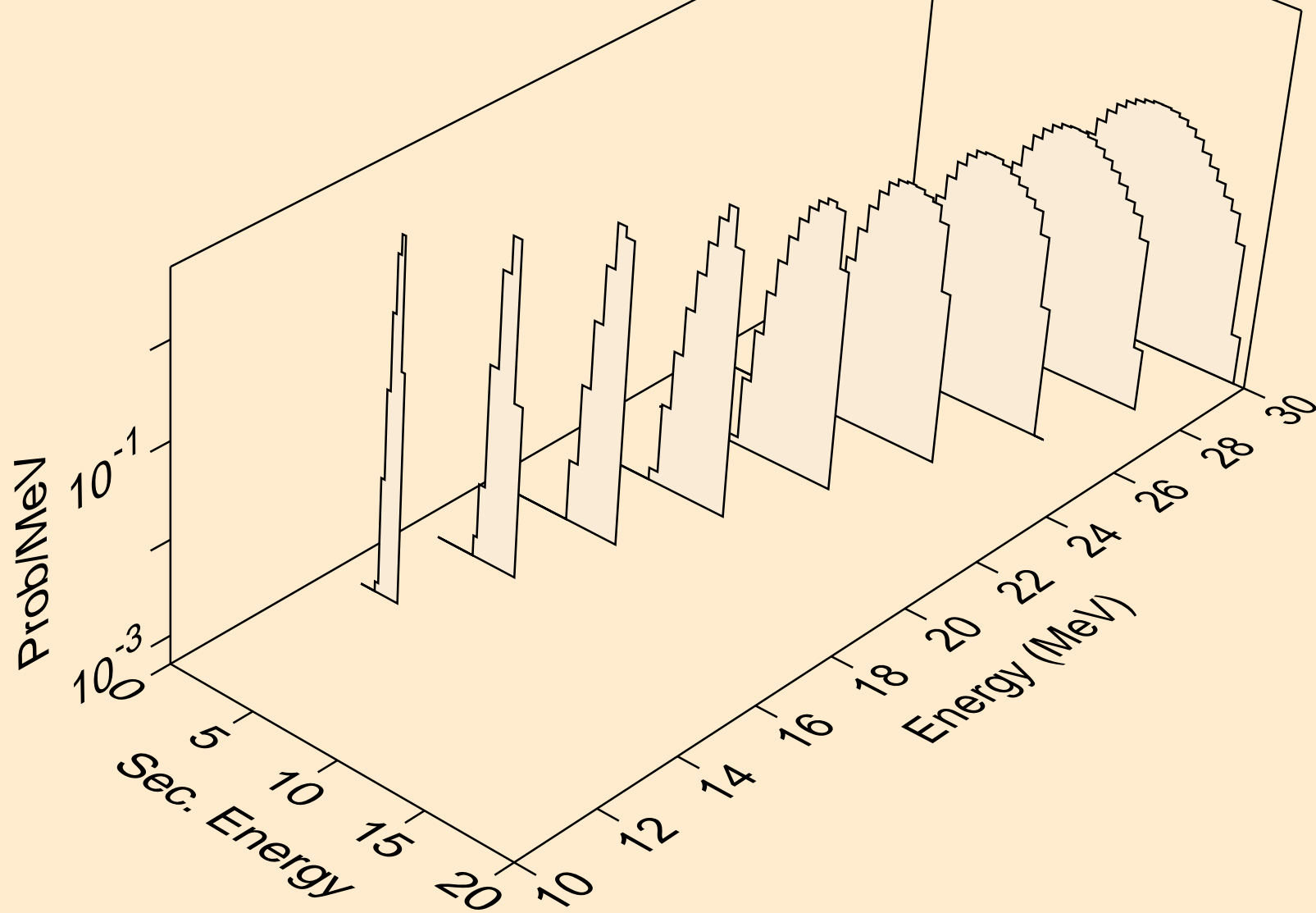

W172 TRITON ACER TENDL-2021 LIBRARY; T=0.K  
Triton emission for inelastic

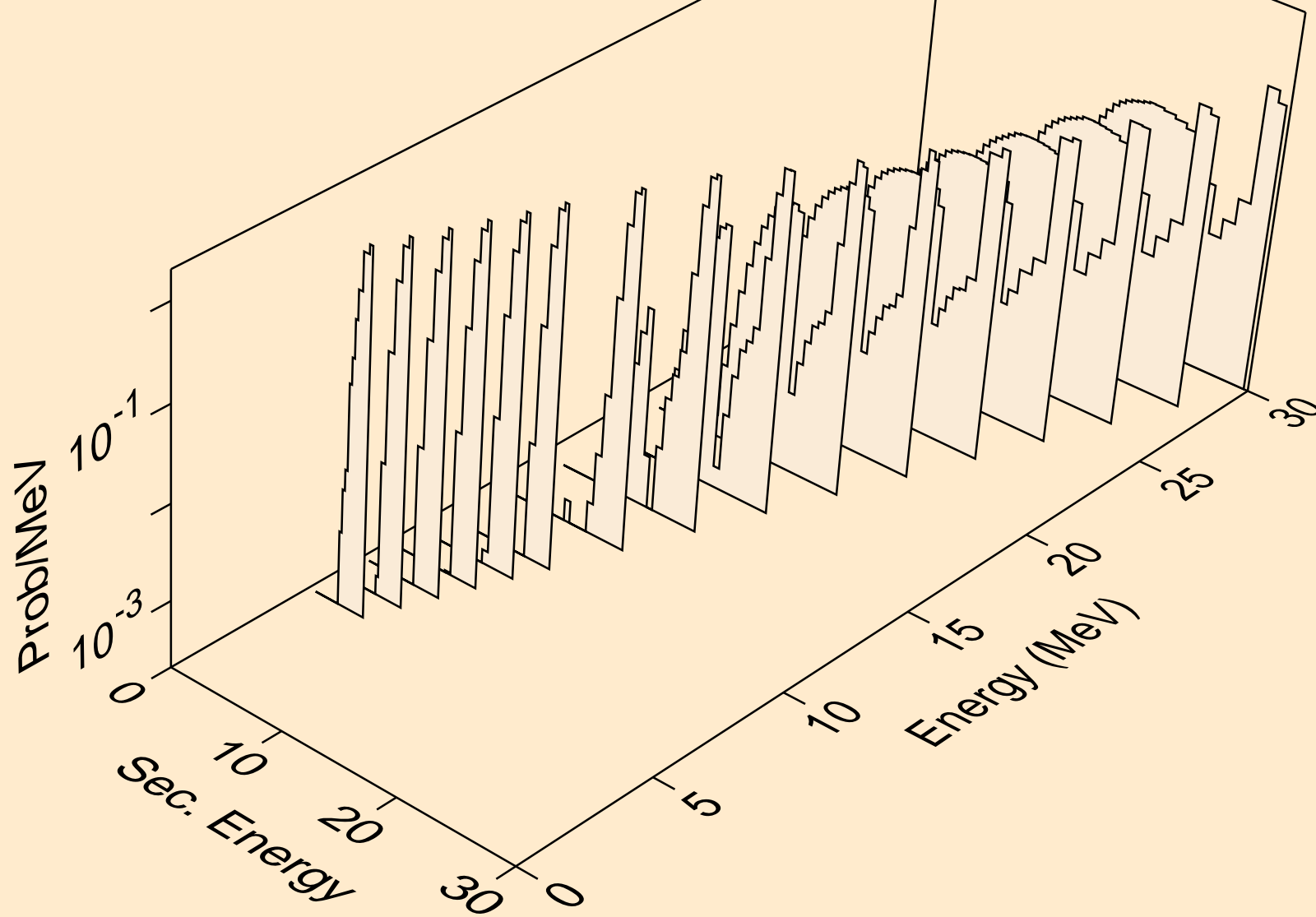

W172 TRITON ACER TENDL-2021 LIBRARY; T=0.K  
Triton emission for (t,pt)

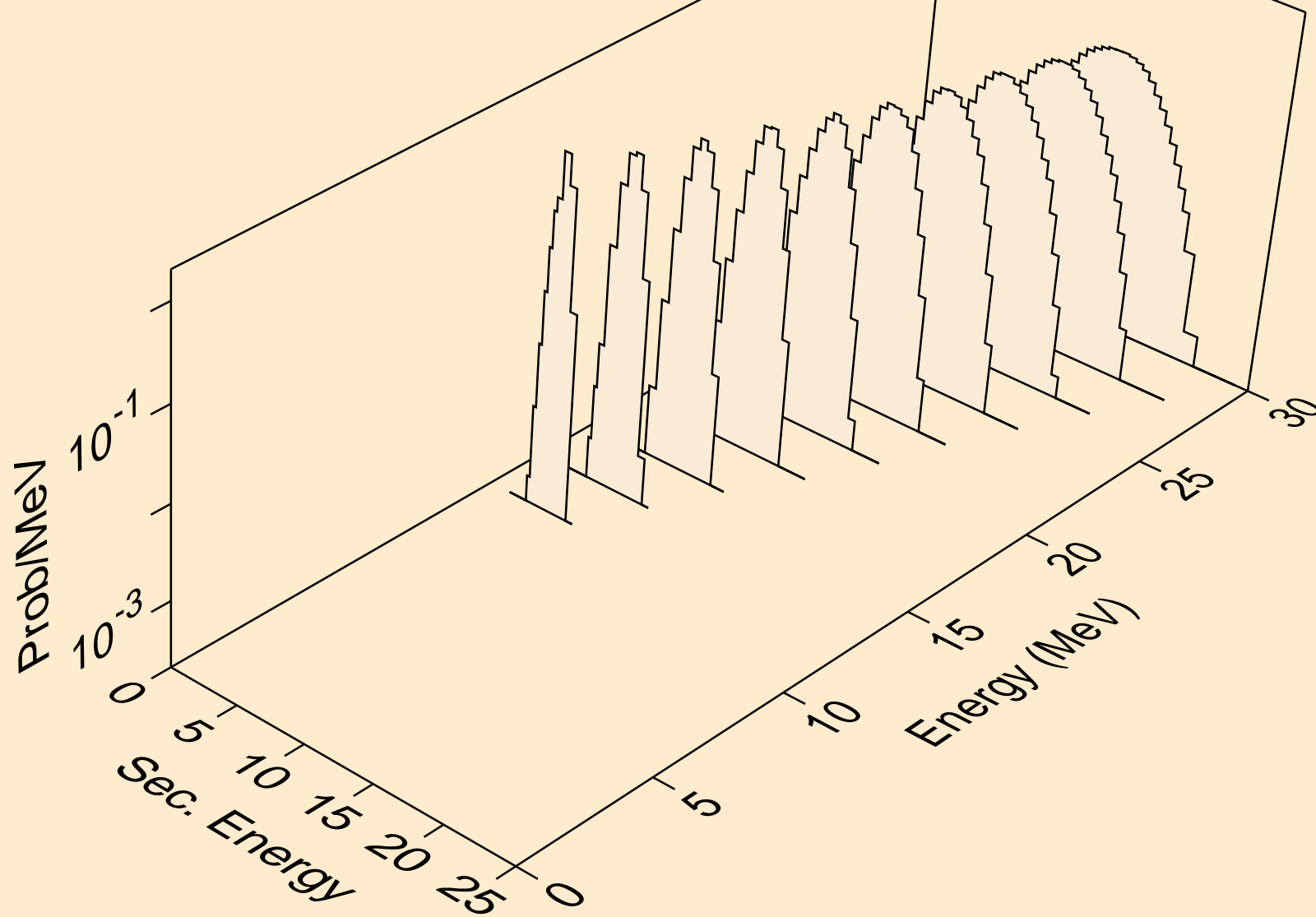

W172 TRITON ACER TENDL-2021 LIBRARY; T=0.K  
Photon emission for (z,n)

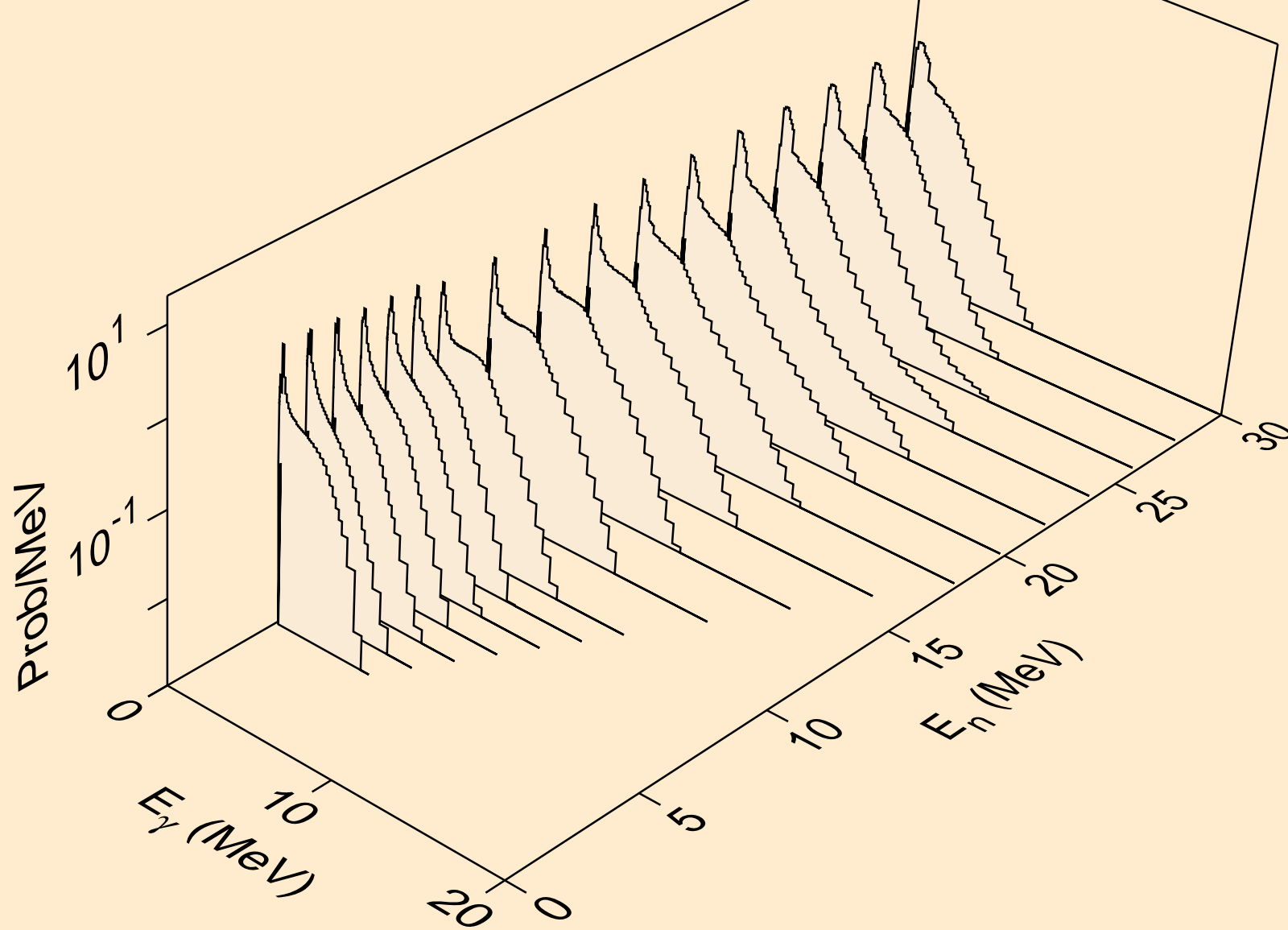

W172 TRITON ACER TENDL-2021 LIBRARY; T=0.K

Photon emission for (n,x)

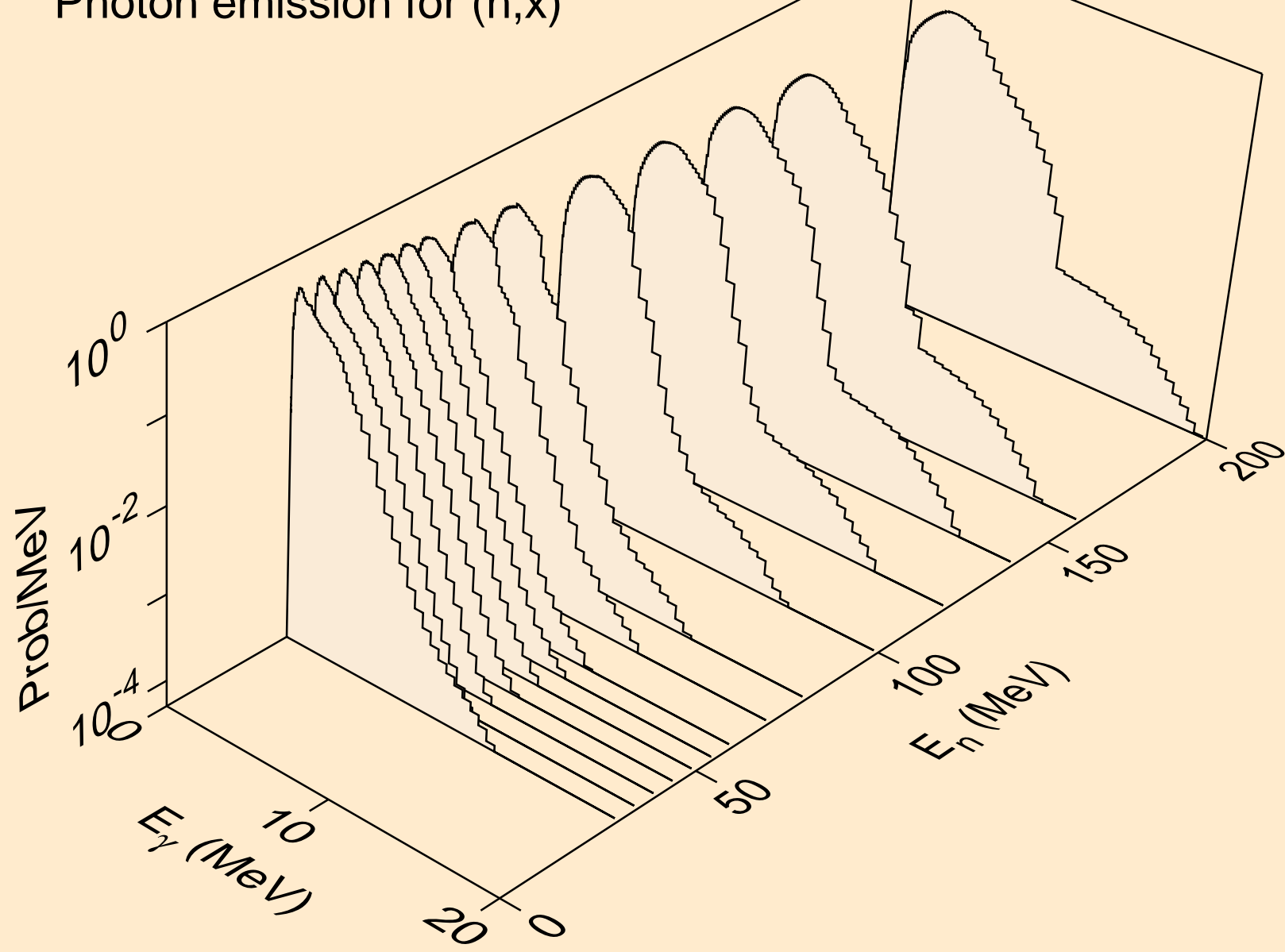

W172 TRITON ACER TENDL-2021 LIBRARY; T=0.K  
Photon emission for (n,2nd)

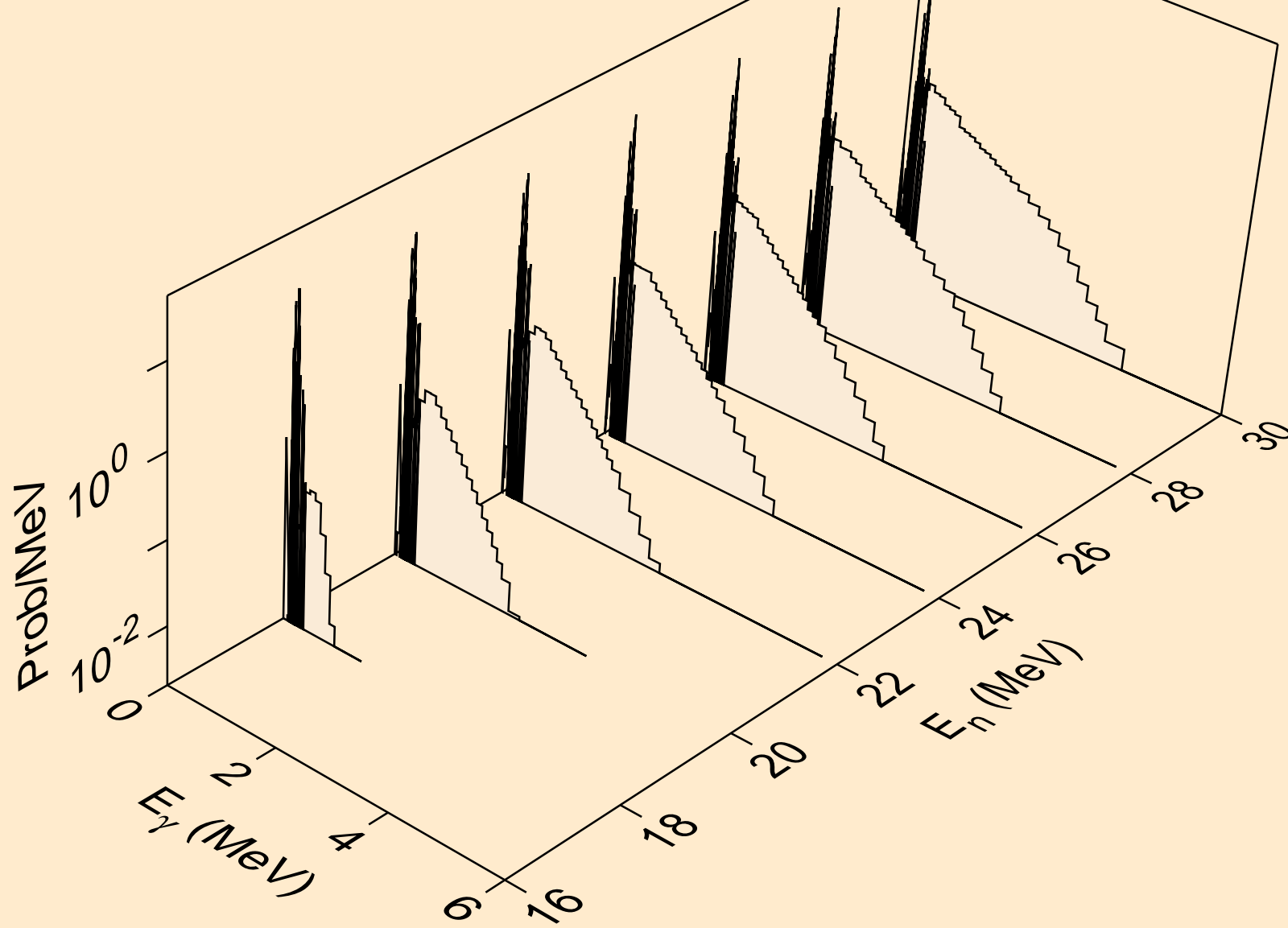



W172 TRITON ACER TENDL-2021 LIBRARY; T=0.K  
Photon emission for (n,2n)

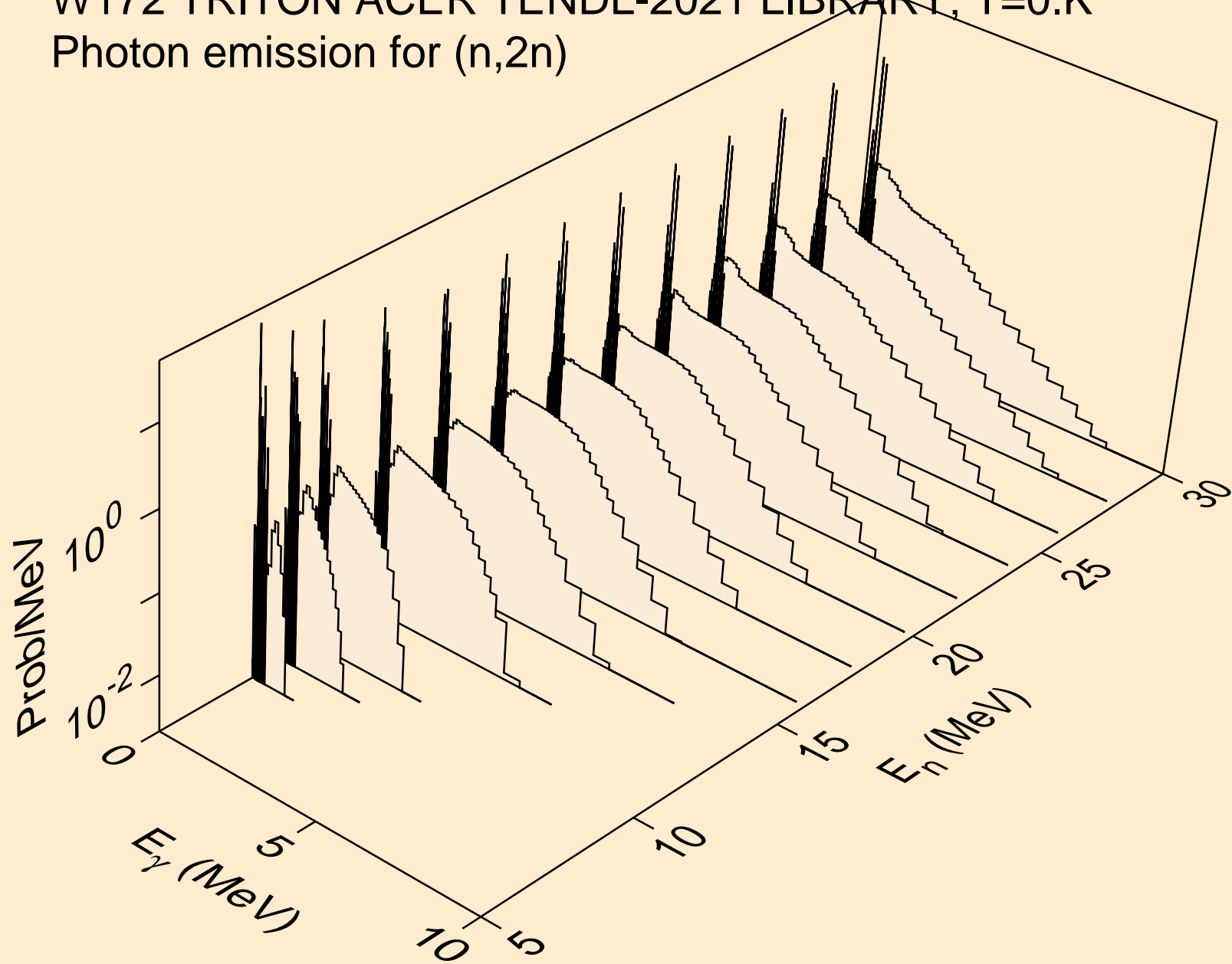

W172 TRITON ACER TENDL-2021 LIBRARY; T=0.K  
Photon emission for (n,3n)

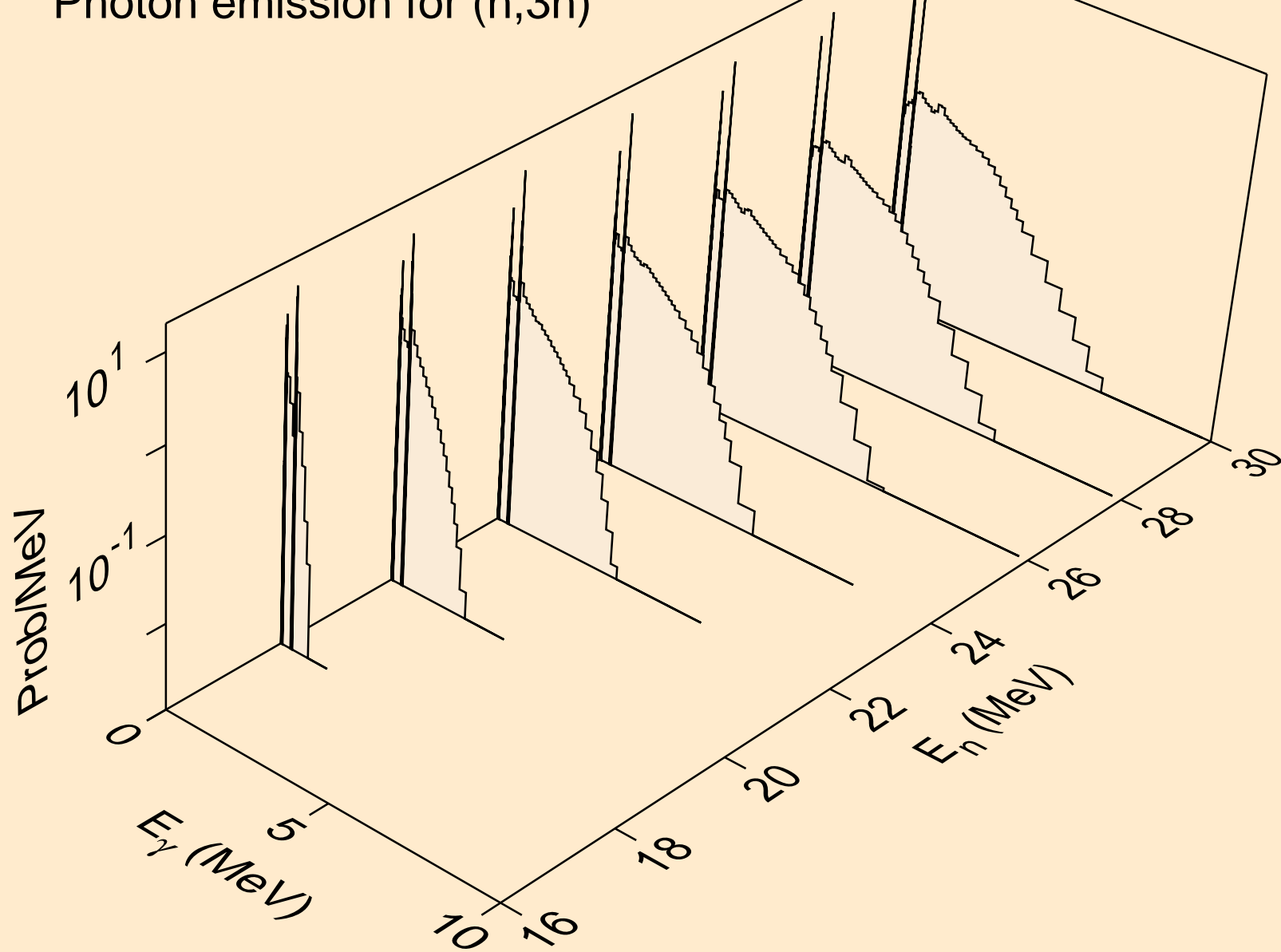

W172 TRITON ACER TENDL-2021 LIBRARY; T=0.K  
Photon emission for (n,n\*)a

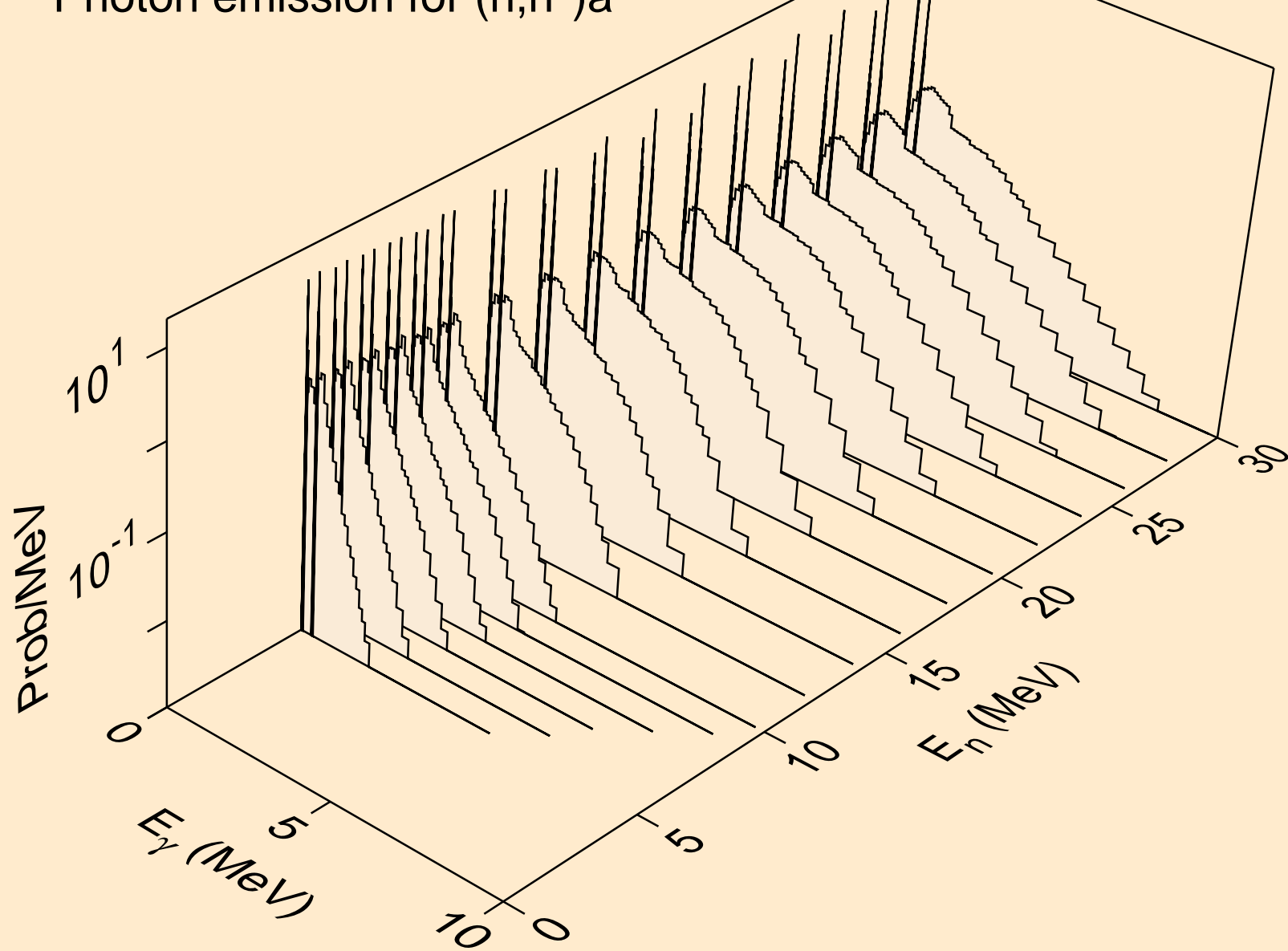

W172 TRITON ACER TENDL-2021 LIBRARY; T=0.K  
Photon emission for (n,2n)a

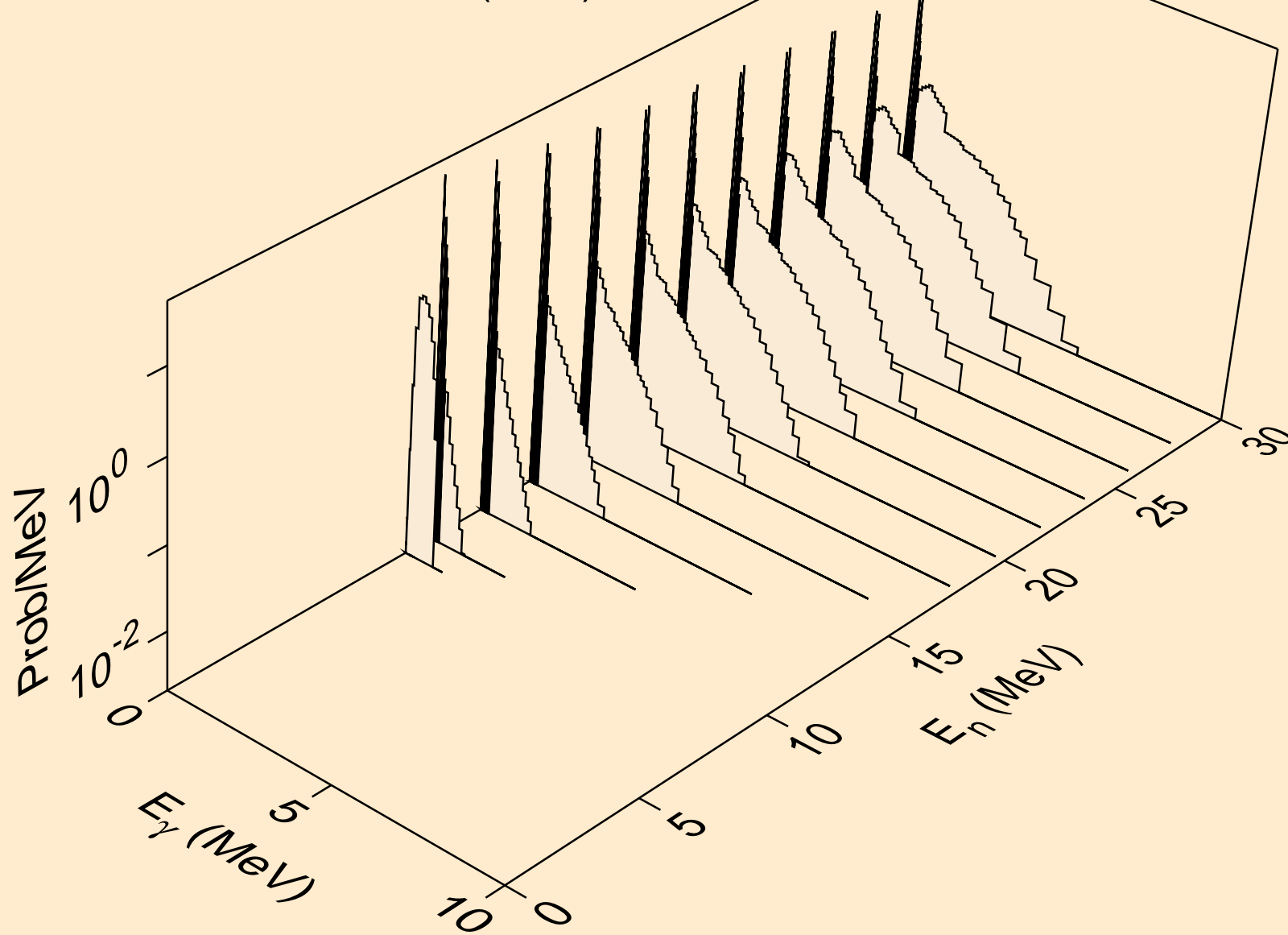

W172 TRITON ACER TENDL-2021 LIBRARY; T=0.K  
Photon emission for (n,3n)a

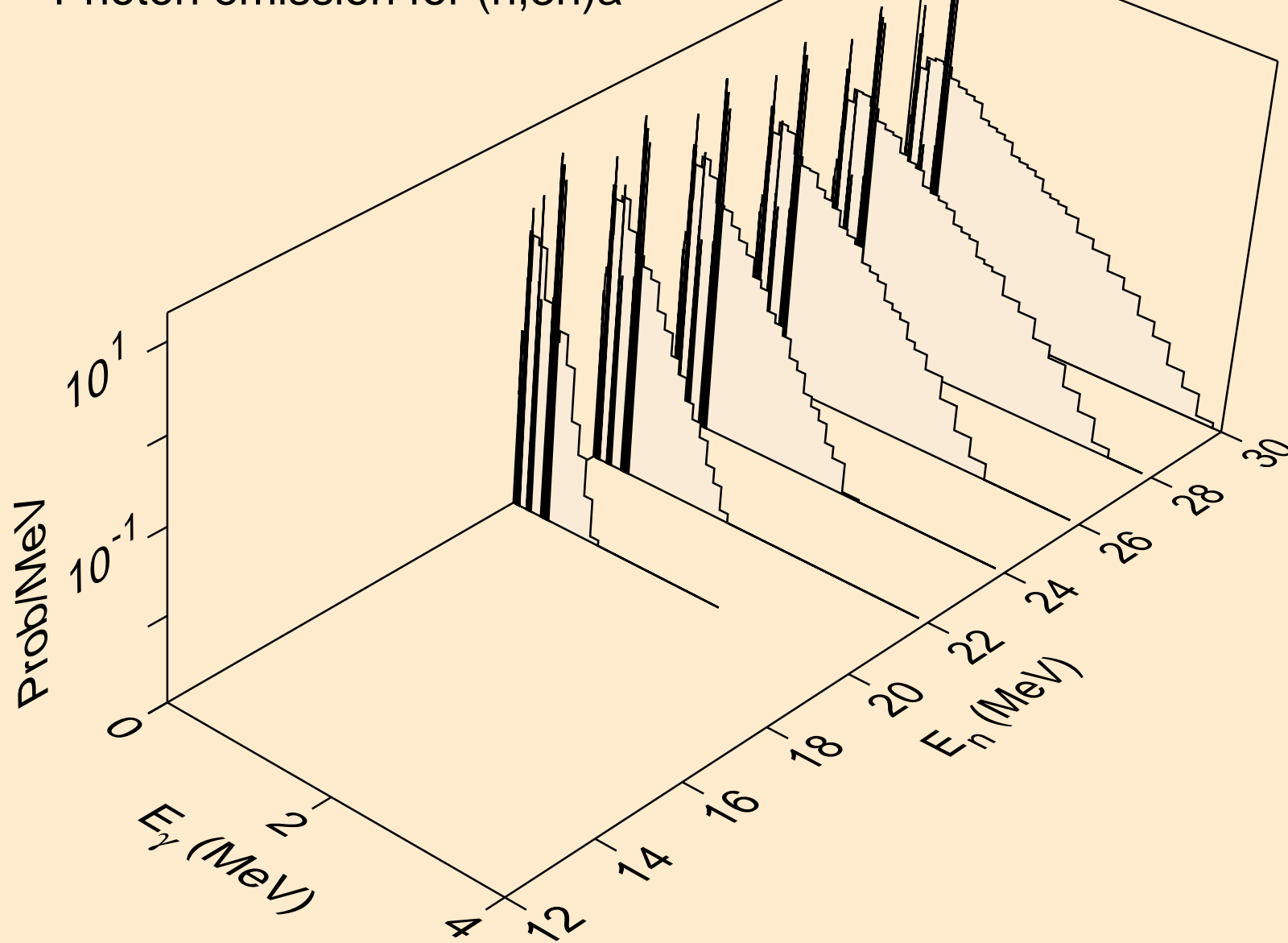

W172 TRITON ACER TENDL-2021 LIBRARY; T=0.K  
Photon emission for (n,n\*)p

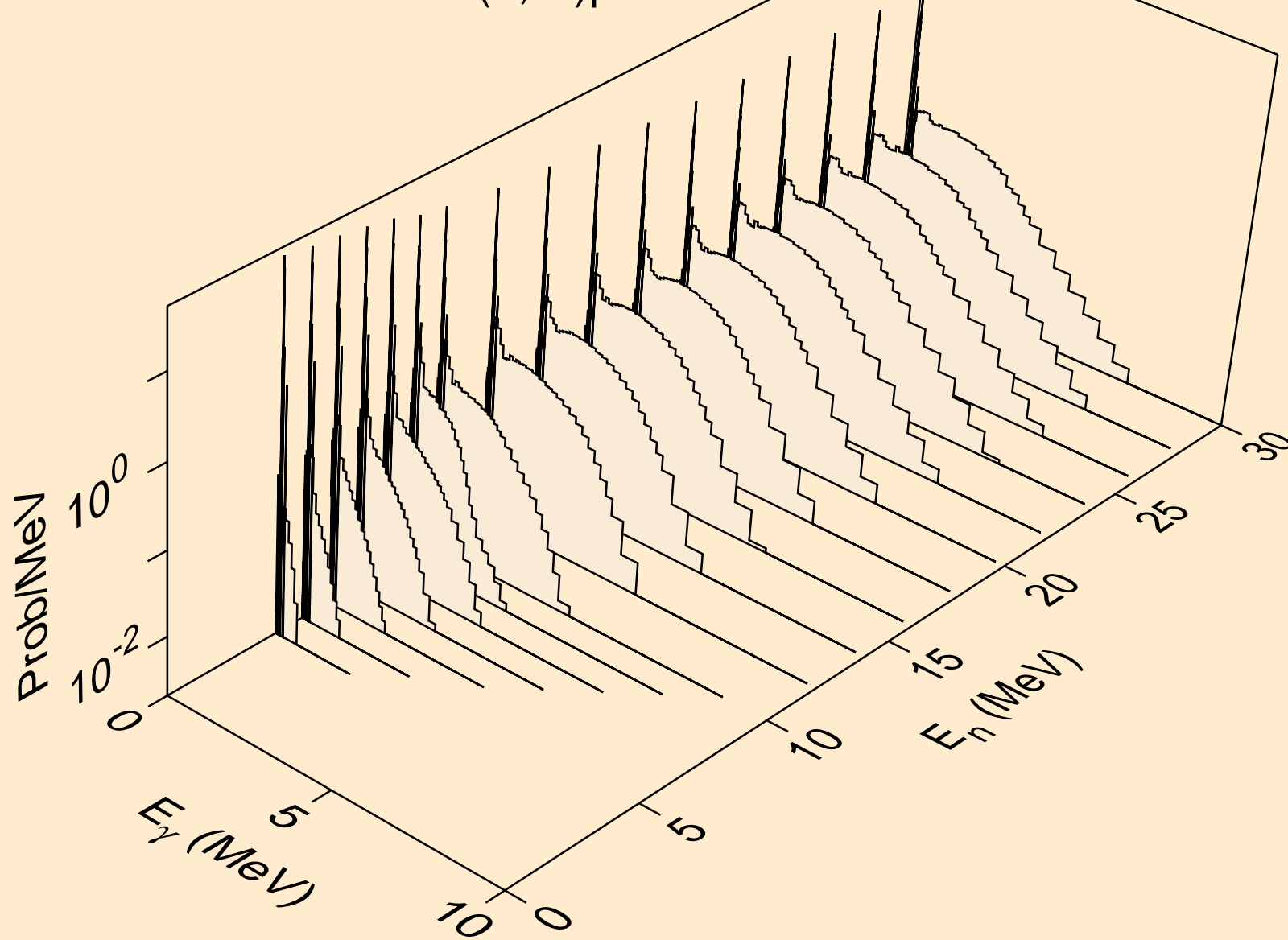

W172 TRITON ACER TENDL-2021 LIBRARY; T=0.K  
Photon emission for (n,n\*)2a

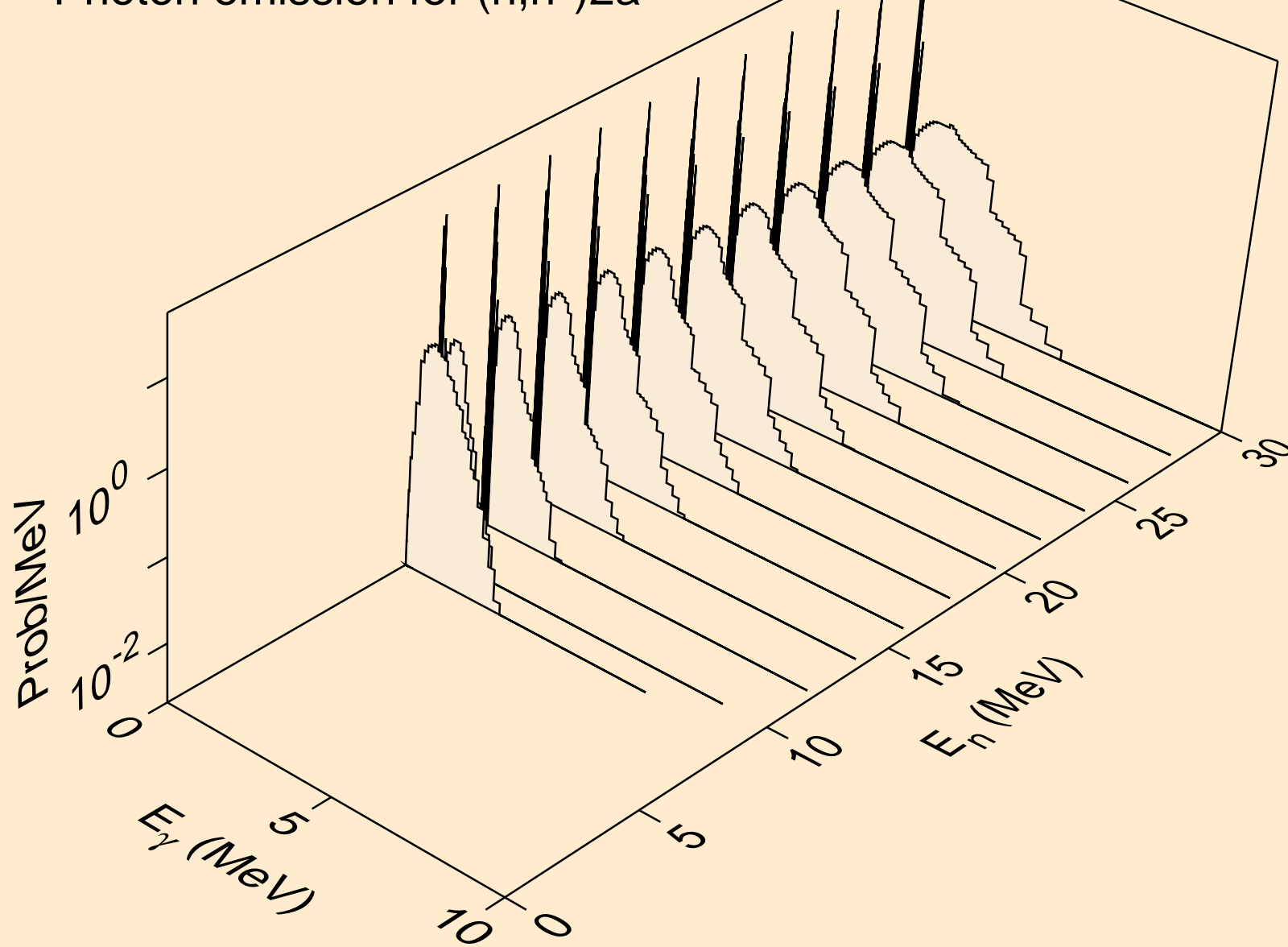

W172 TRITON ACER TENDL-2021 LIBRARY; T=0.K  
Photon emission for (n,2n)2a

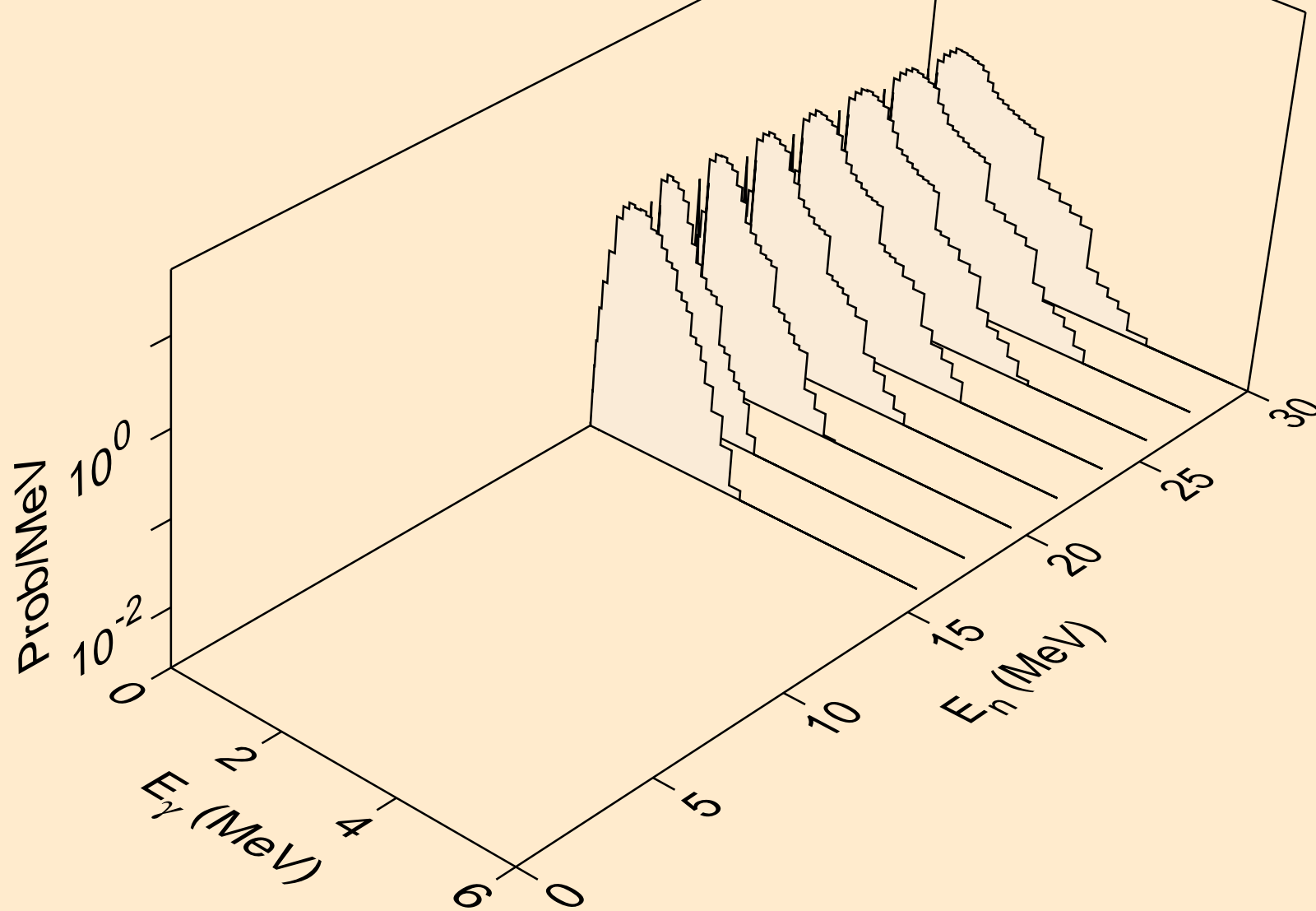



W172 TRITON ACER TENDL-2021 LIBRARY; T=0.K  
Photon emission for (n,n\*)d

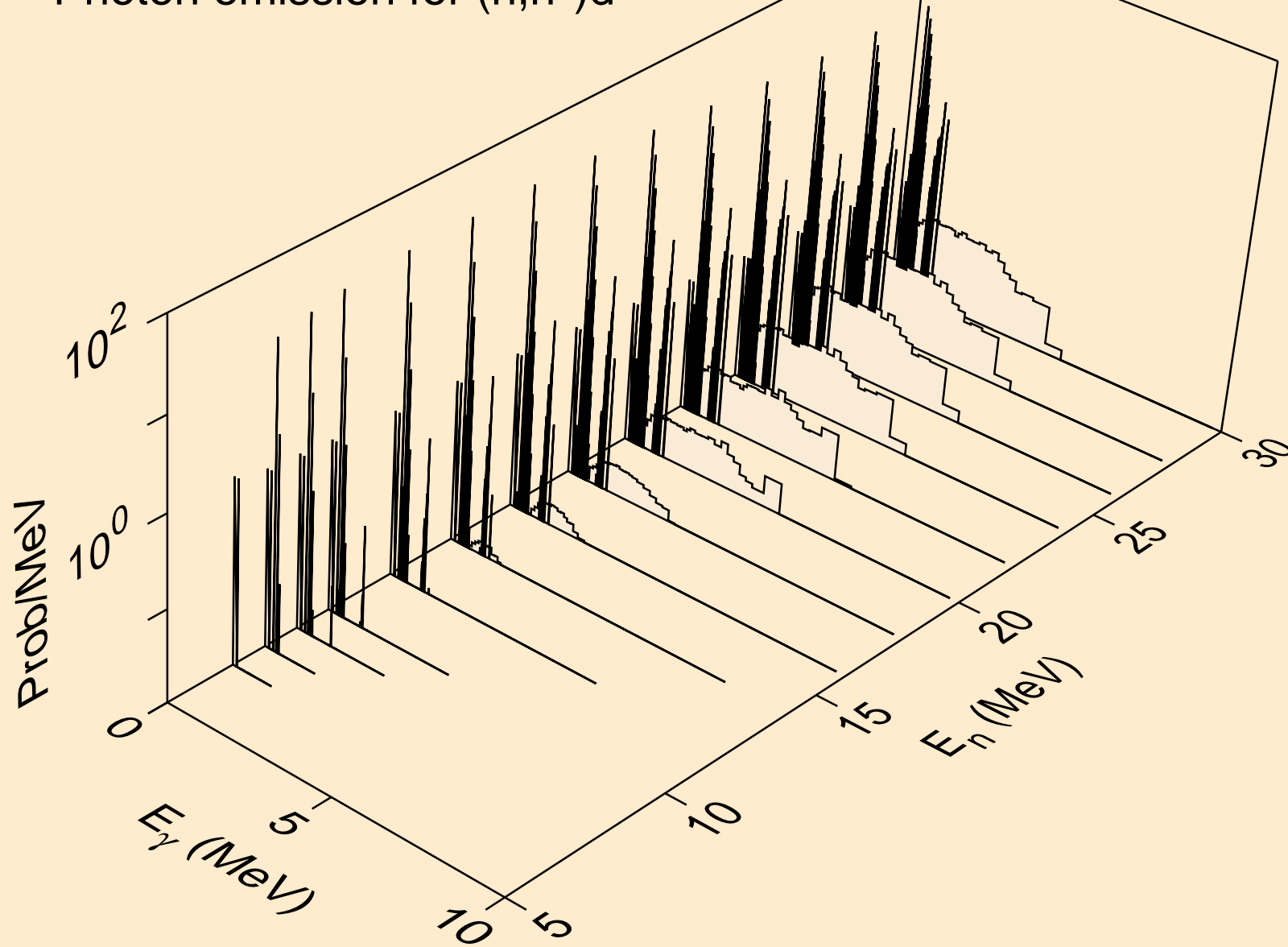

W172 TRITON ACER TENDL-2021 LIBRARY; T=0.K  
Photon emission for (n,n\*)t

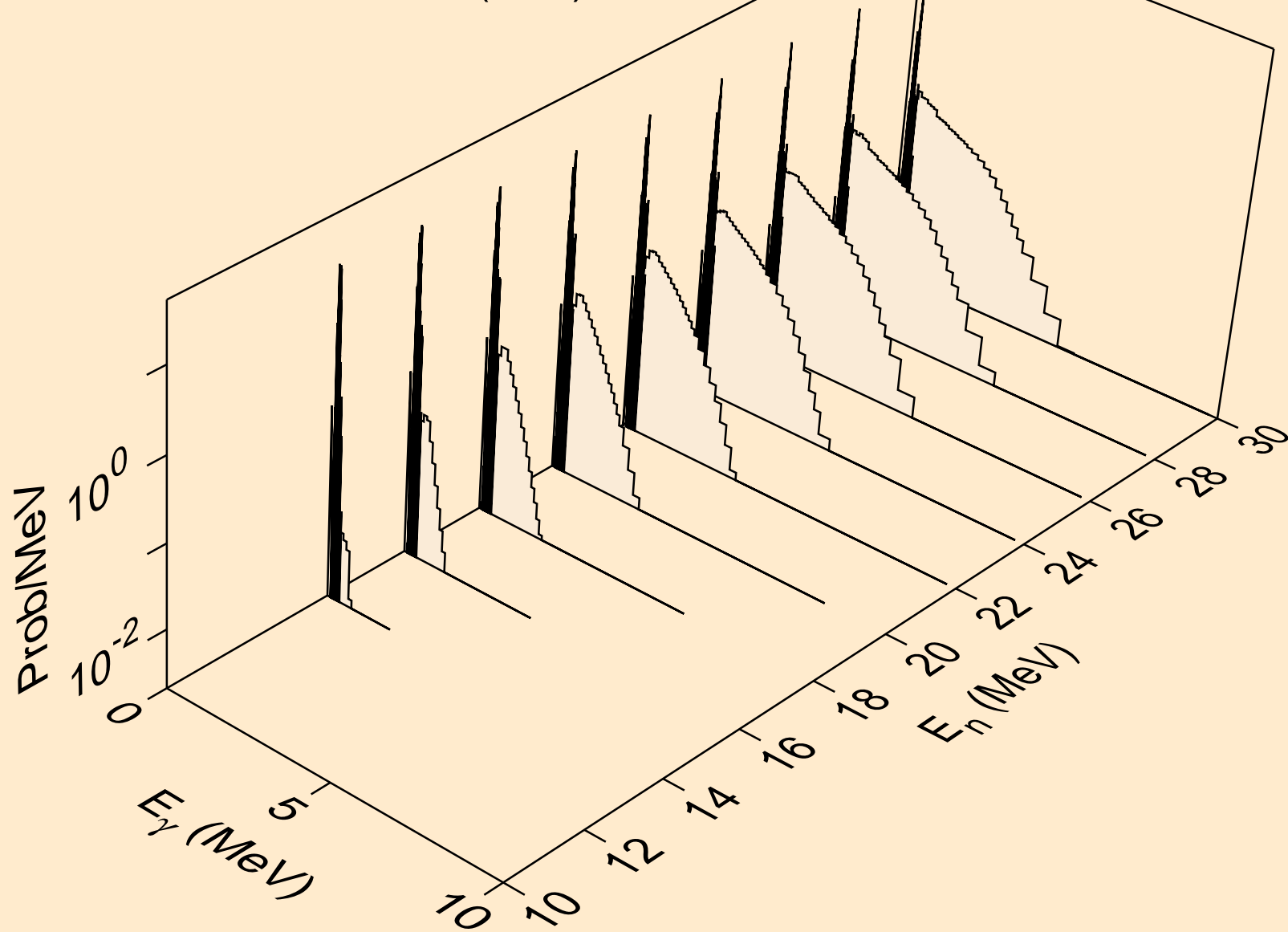

W172 TRITON ACER TENDL-2021 LIBRARY; T=0.K  
Photon emission for (n,n\*)he3

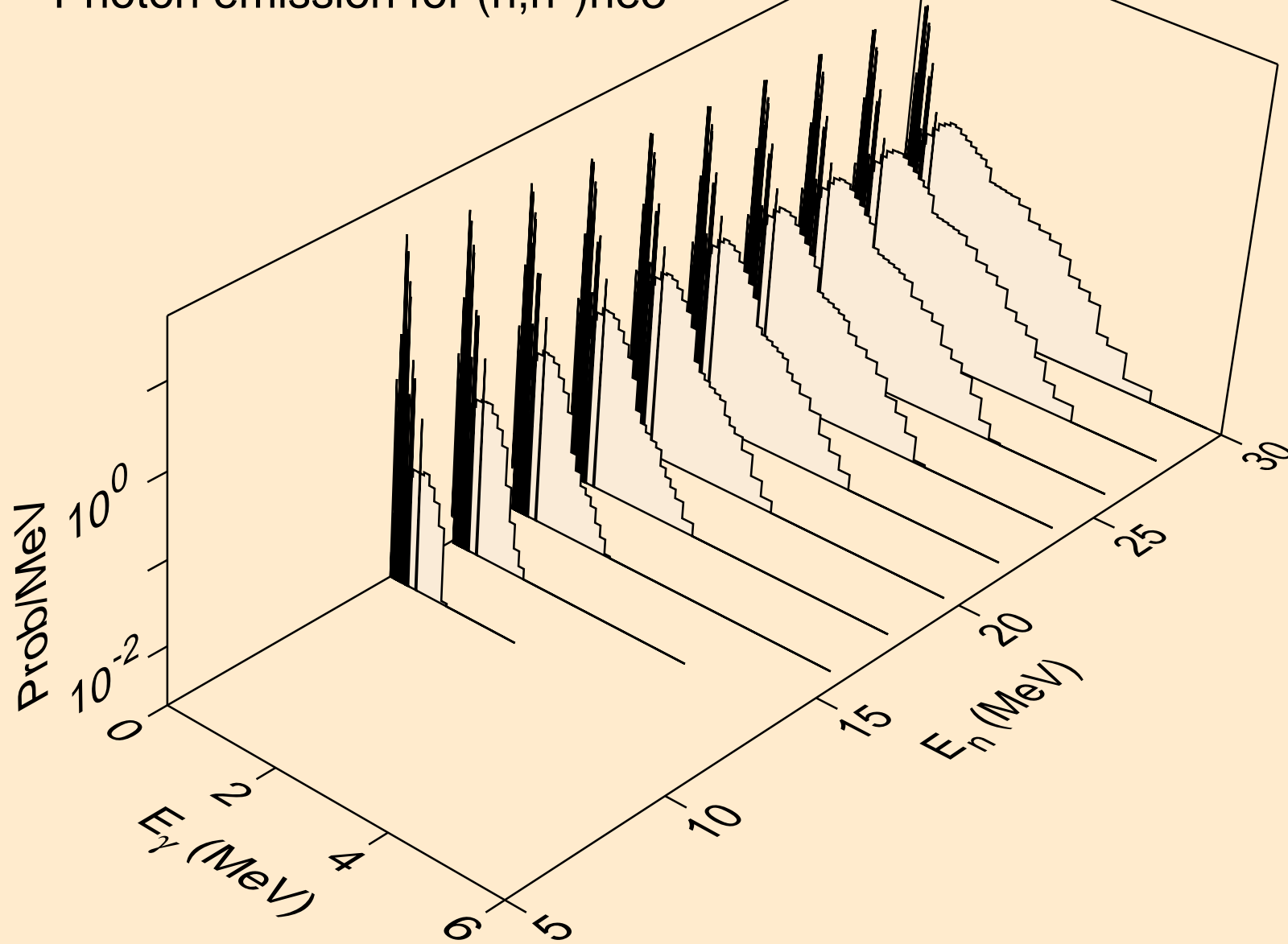

W172 TRITON ACER TENDL-2021 LIBRARY; T=0.K  
Photon emission for (n,4n)

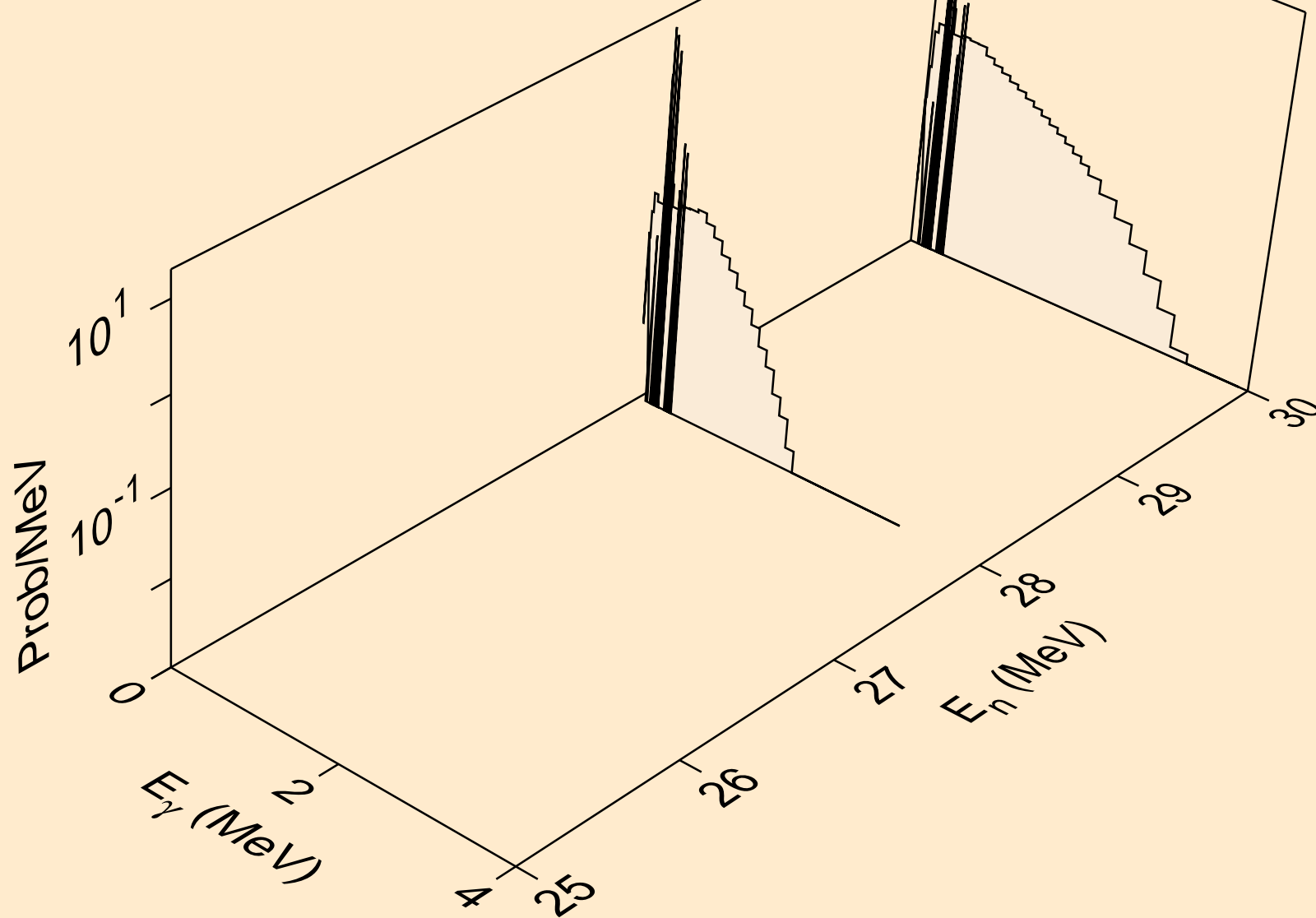

W172 TRITON ACER TENDL-2021 LIBRARY; T=0.K  
Photon emission for (n,2np)

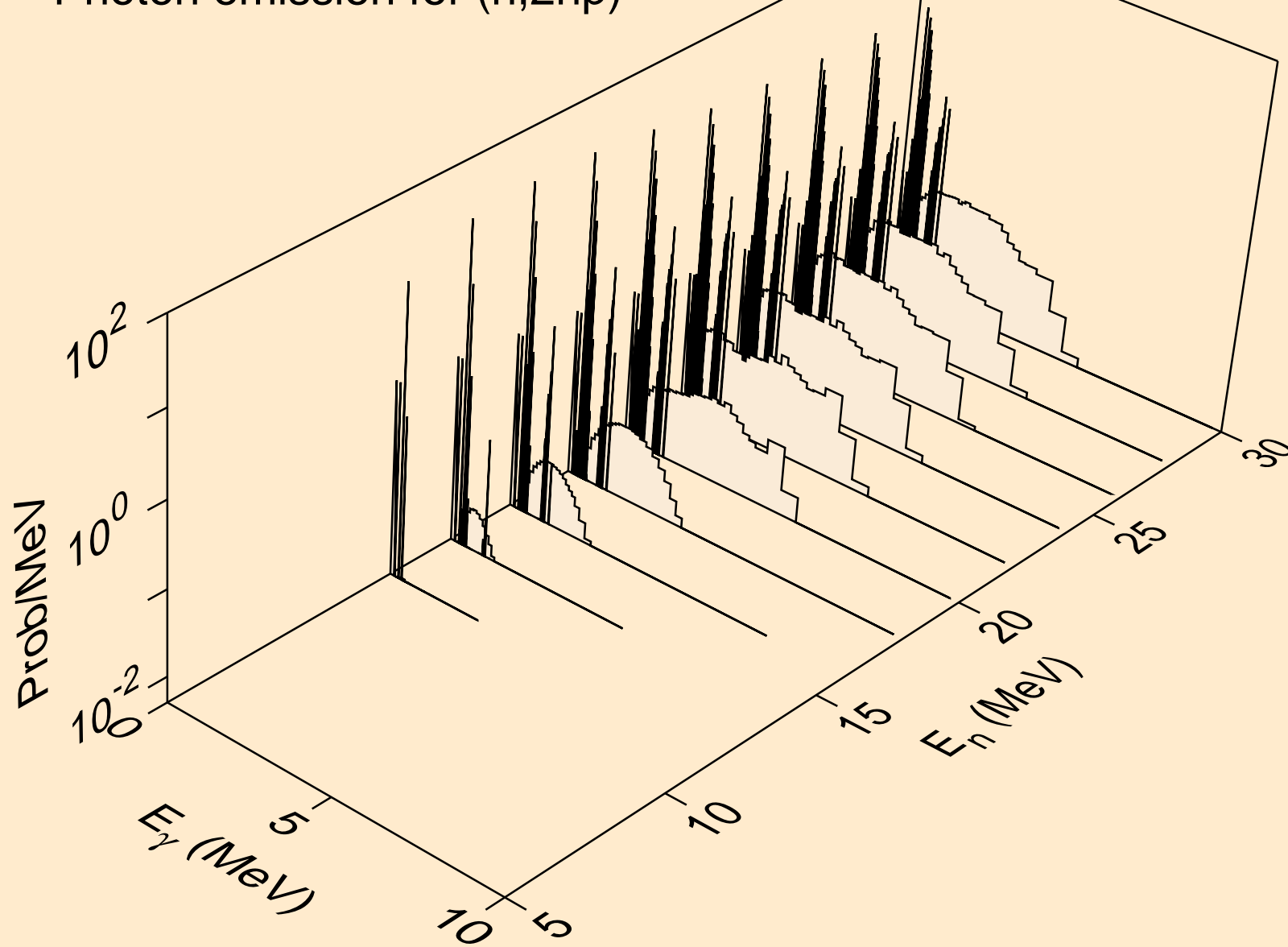

W172 TRITON ACER TENDL-2021 LIBRARY; T=0.K  
Photon emission for (n,3np)

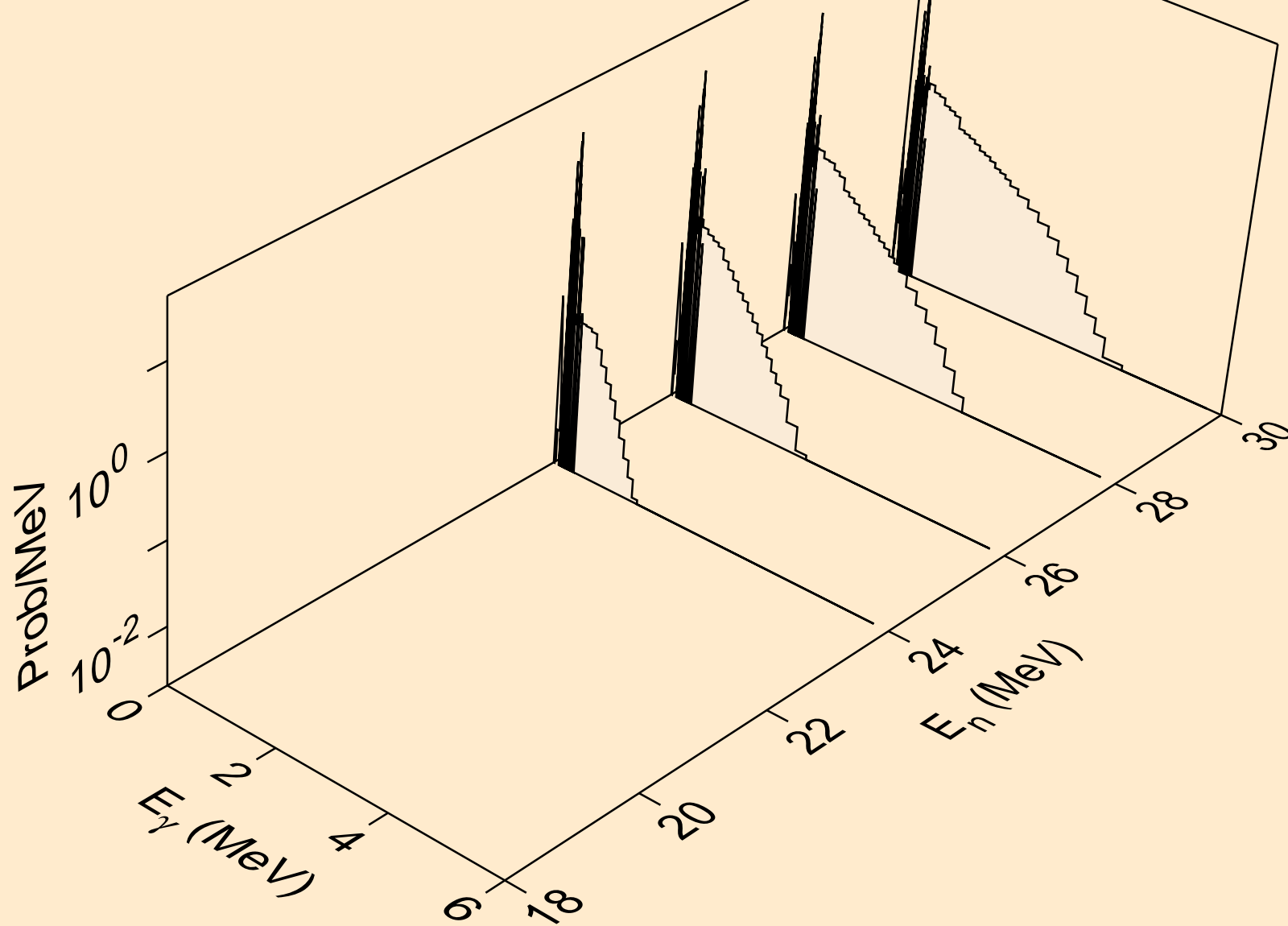

W172 TRITON ACER TENDL-2021 LIBRARY; T=0.K  
Photon emission for (n,2np)

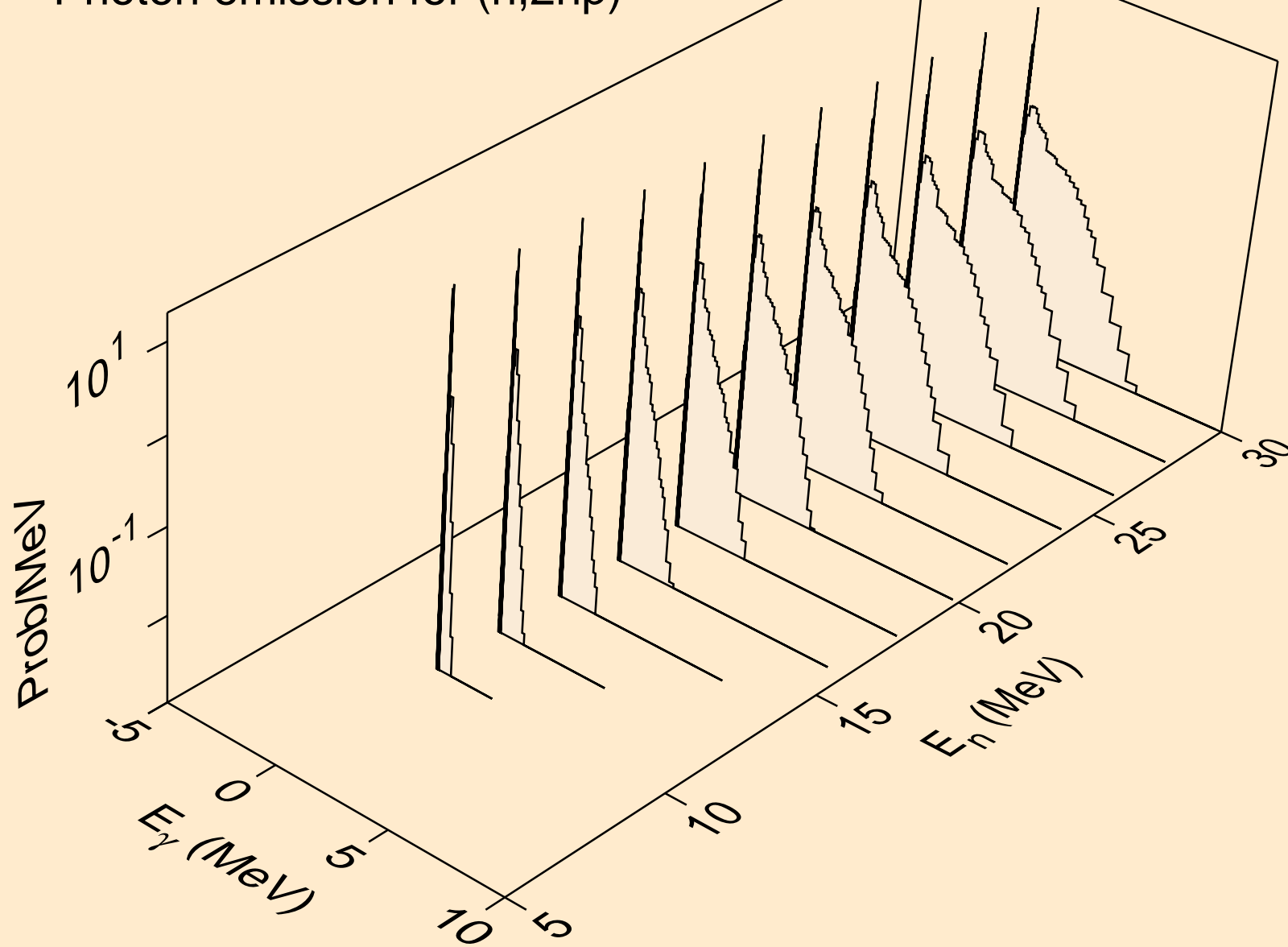

W172 TRITON ACER TENDL-2021 LIBRARY; T=0.K  
Photon emission for (n,npa)

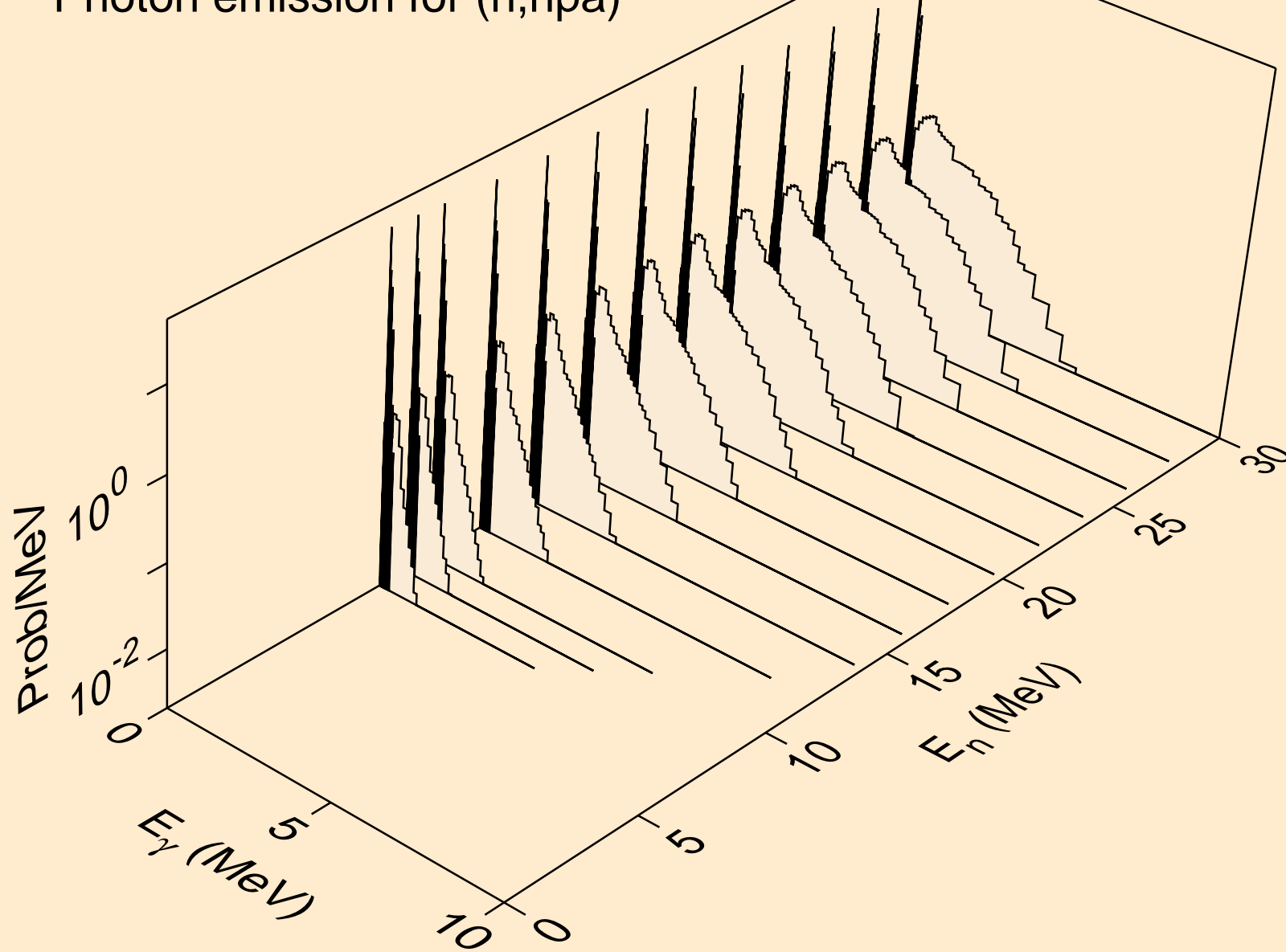



W172 TRITON ACER TENDL-2021 LIBRARY; T=0.K  
Photon emission for (n,gma)

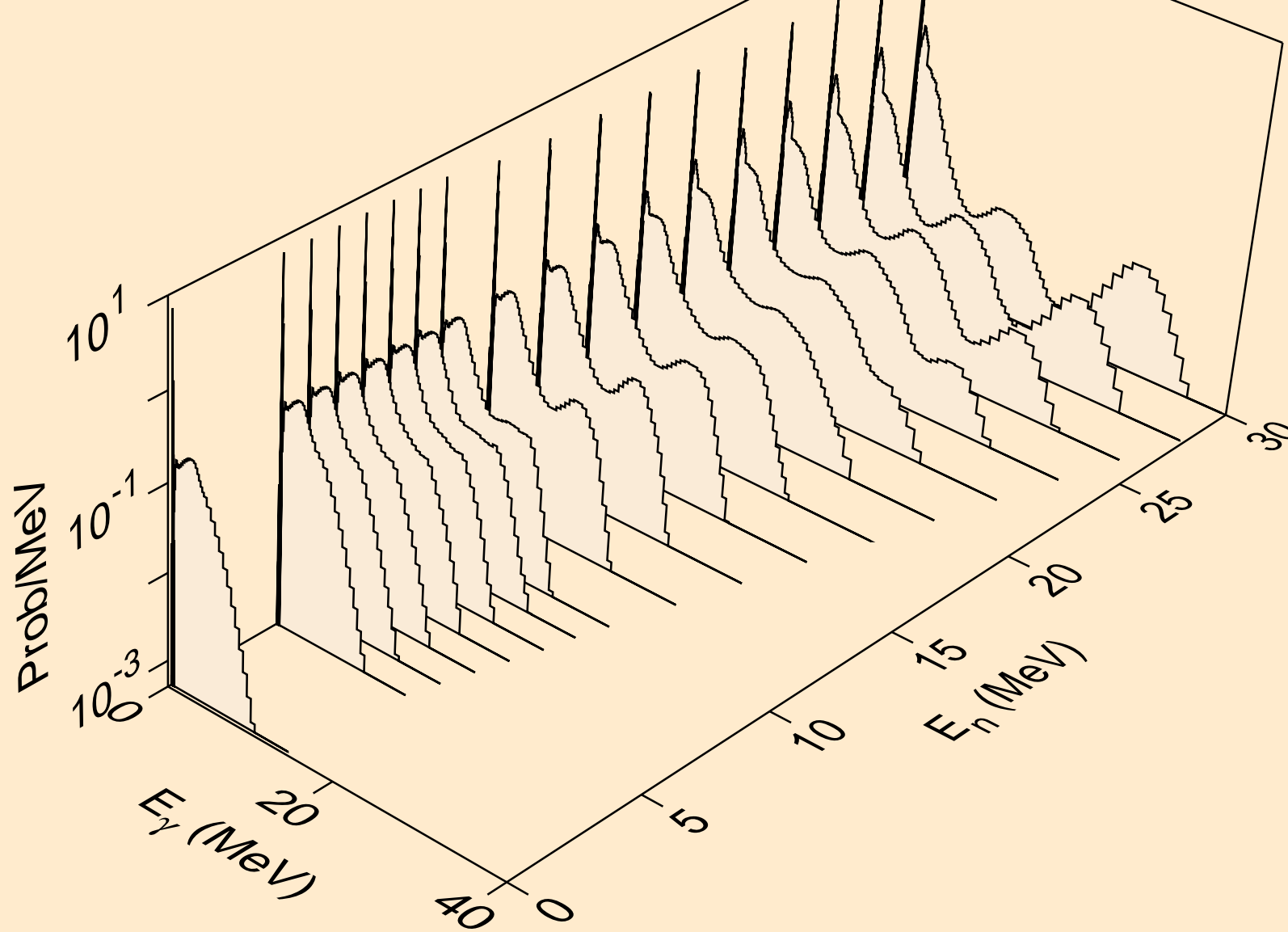

W172 TRITON ACER TENDL-2021 LIBRARY; T=0.K  
Photon emission for (n,p)

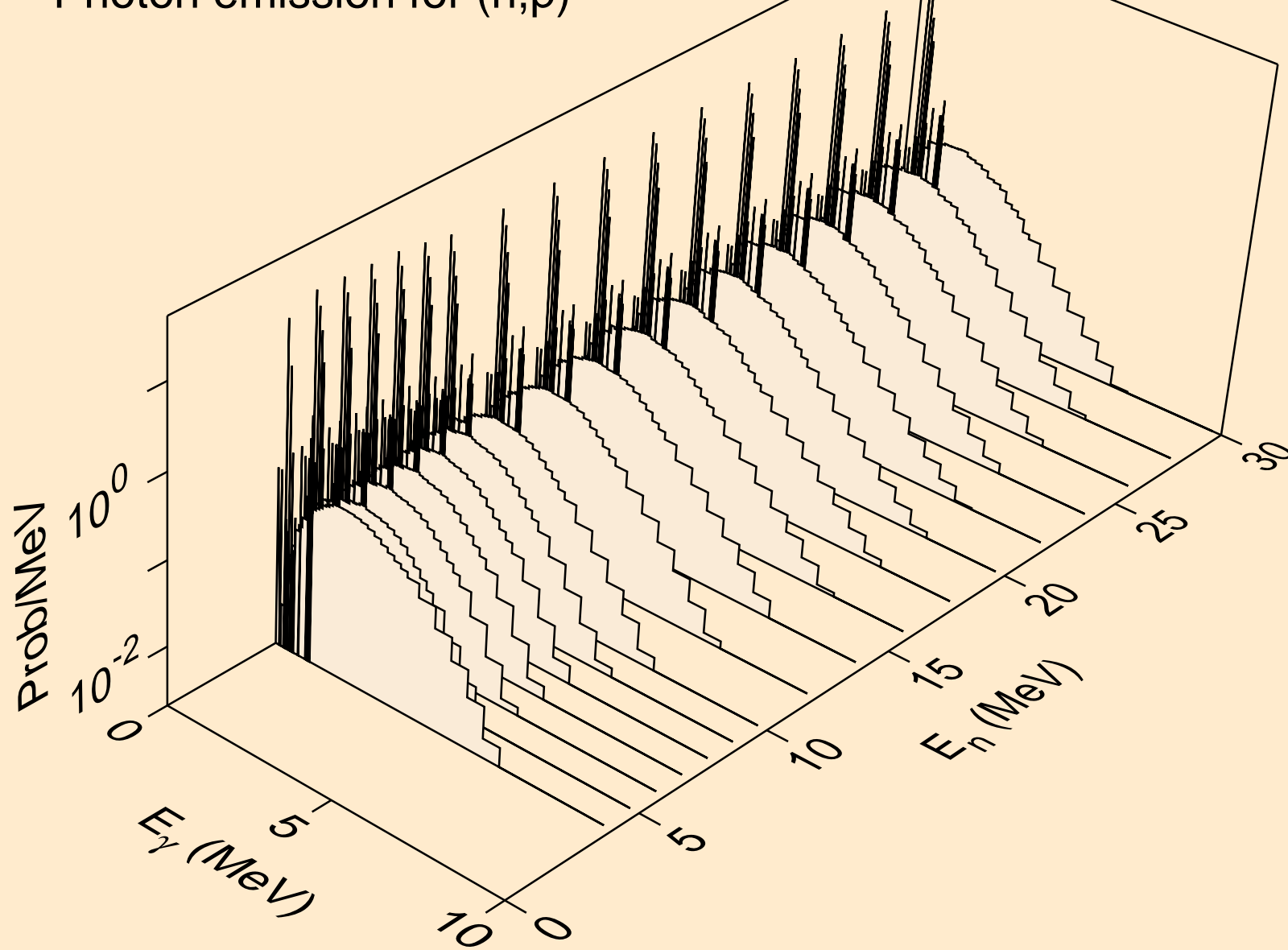

W172 TRITON ACER TENDL-2021 LIBRARY; T=0.K  
Photon emission for (n,d)

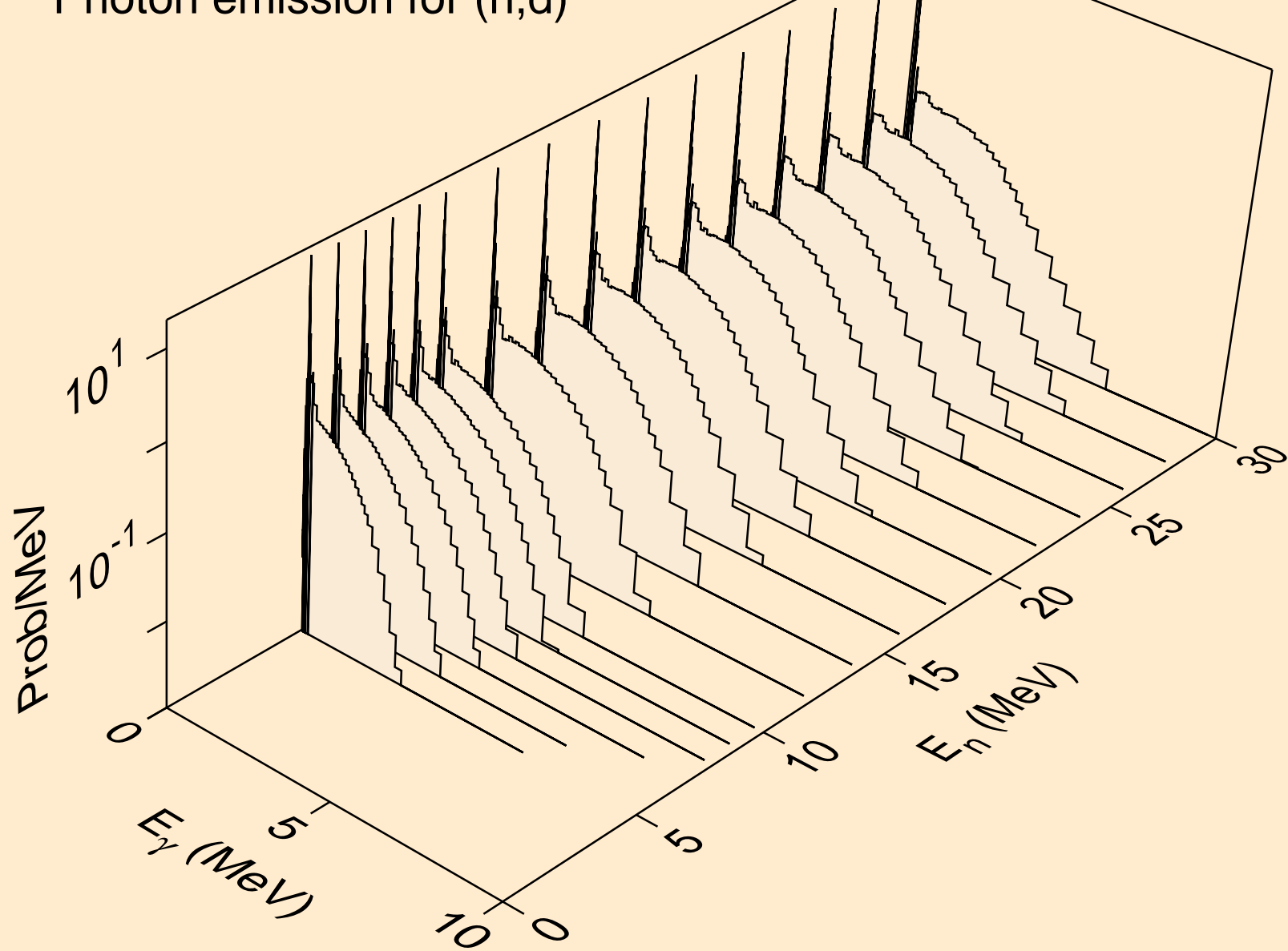

W172 TRITON ACER TENDL-2021 LIBRARY; T=0.K  
Photon emission for inelastic

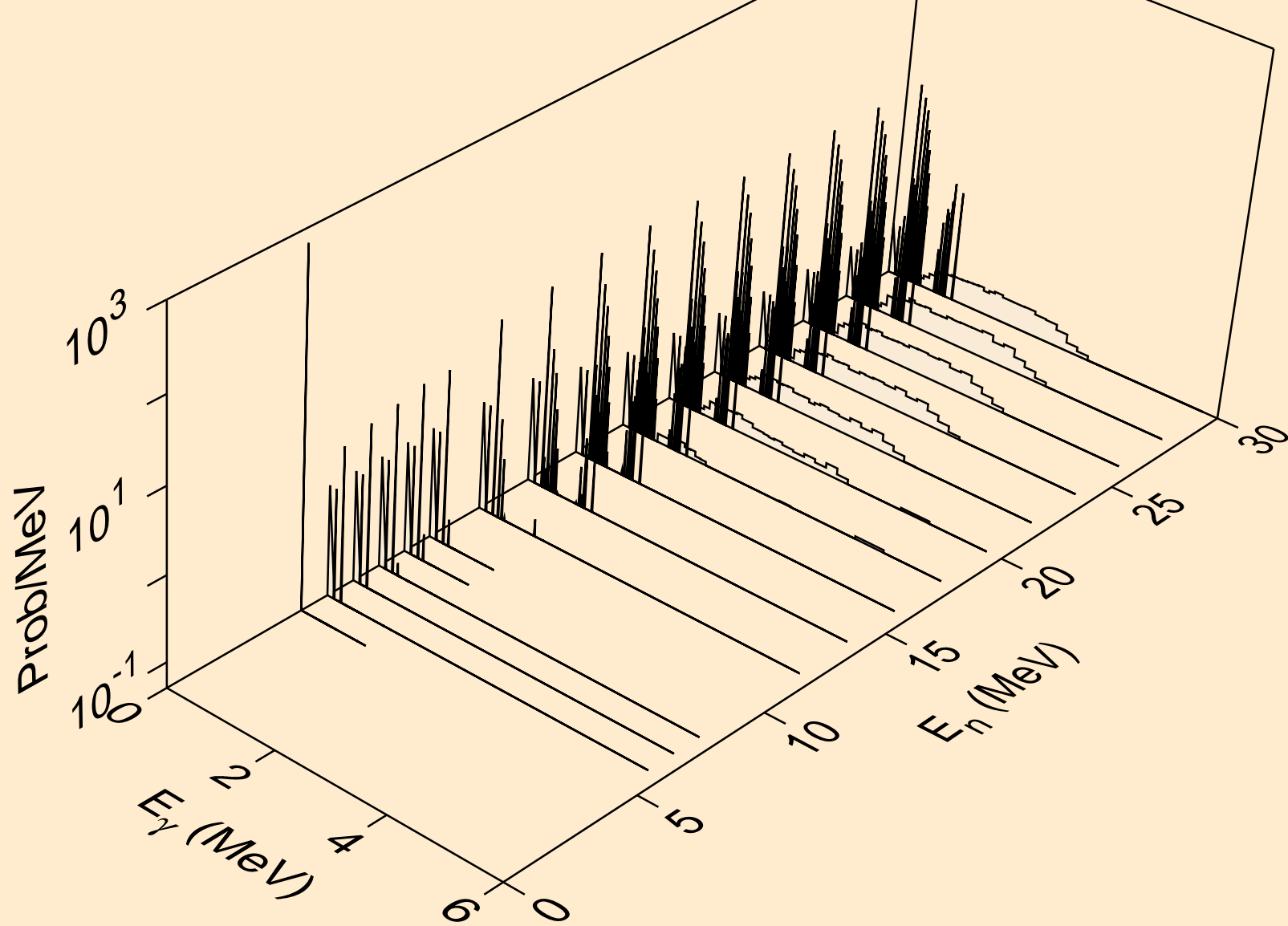

W172 TRITON ACER TENDL-2021 LIBRARY; T=0.K  
Photon emission for (n,he3)

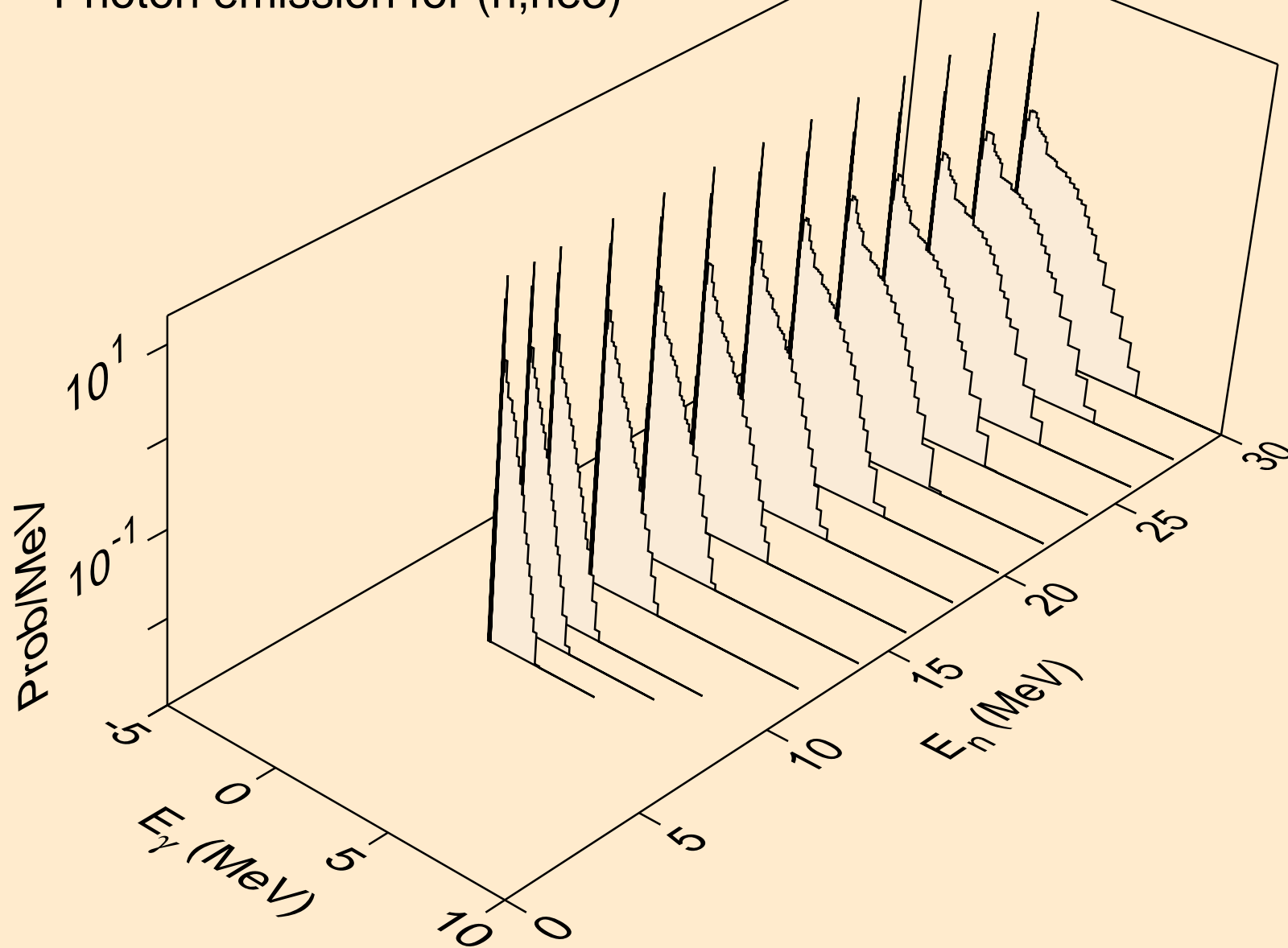

W172 TRITON ACER TENDL-2021 LIBRARY; T=0.K  
Photon emission for (n,a)

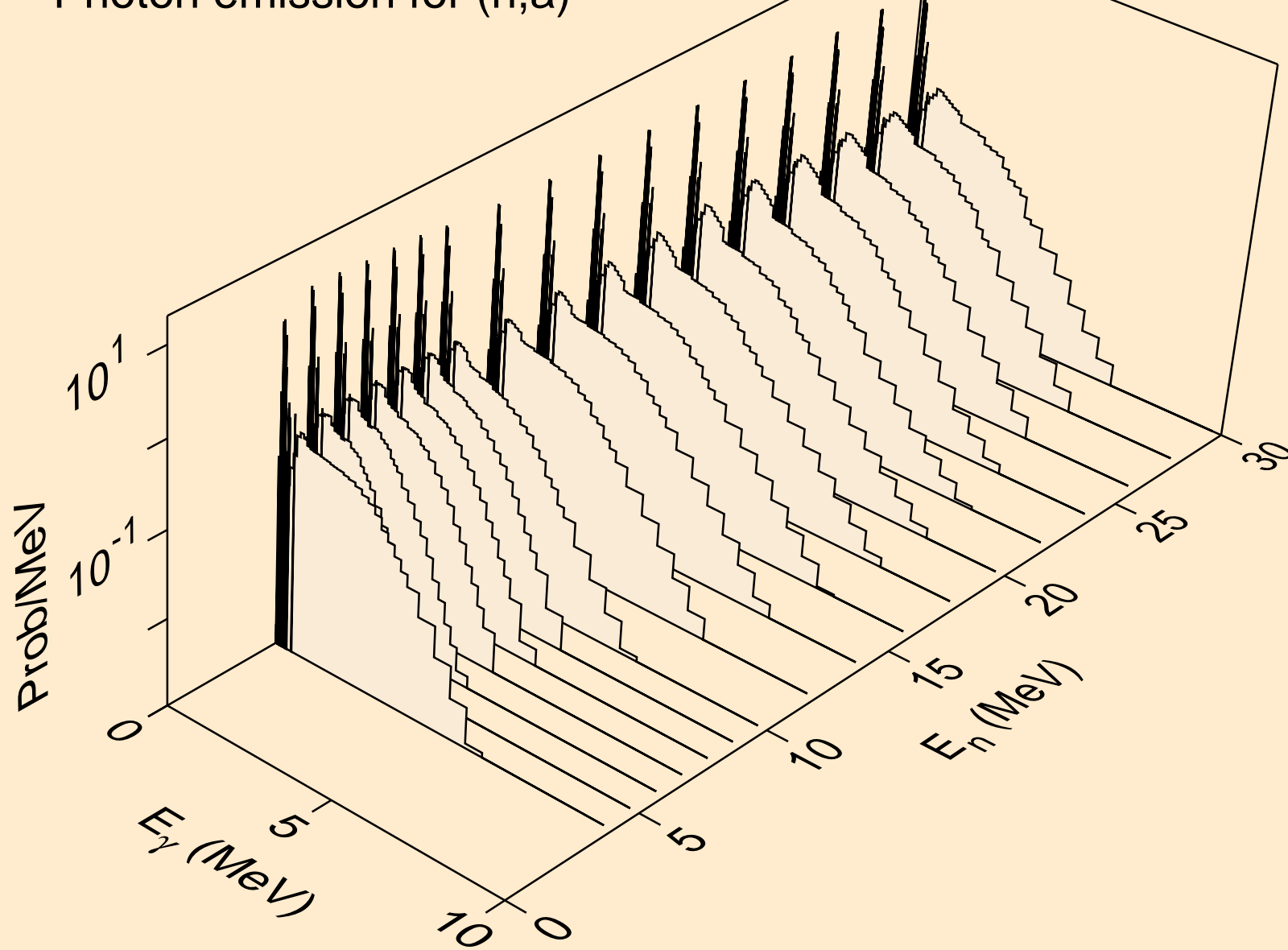

W172 TRITON ACER TENDL-2021 LIBRARY; T=0.K  
Photon emission for (n,2a)

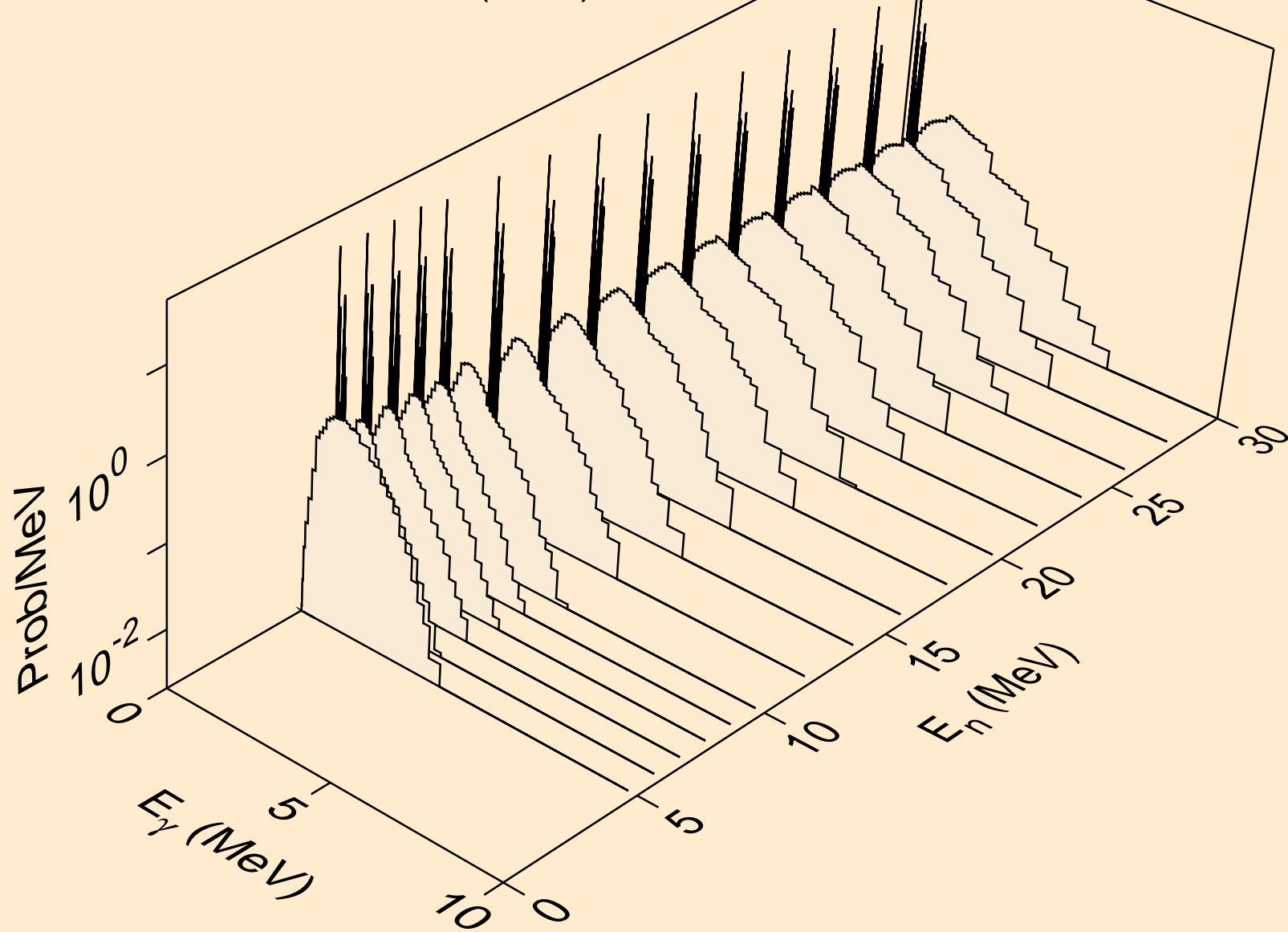

W172 TRITON ACER TENDL-2021 LIBRARY; T=0.K  
Photon emission for (n,2p)

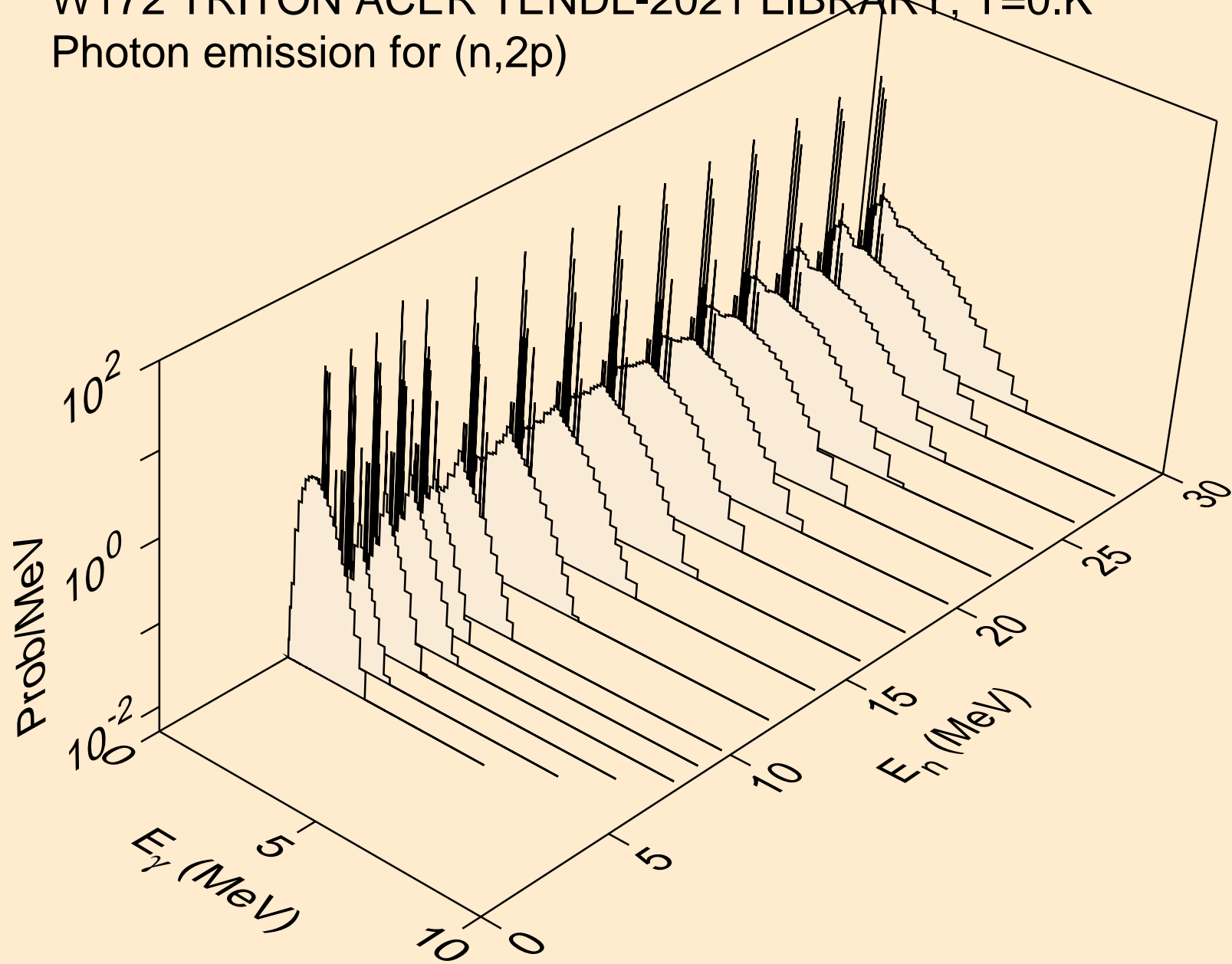



W172 TRITON ACER TENDL-2021 LIBRARY; T=0.K  
Photon emission for (n,pa)

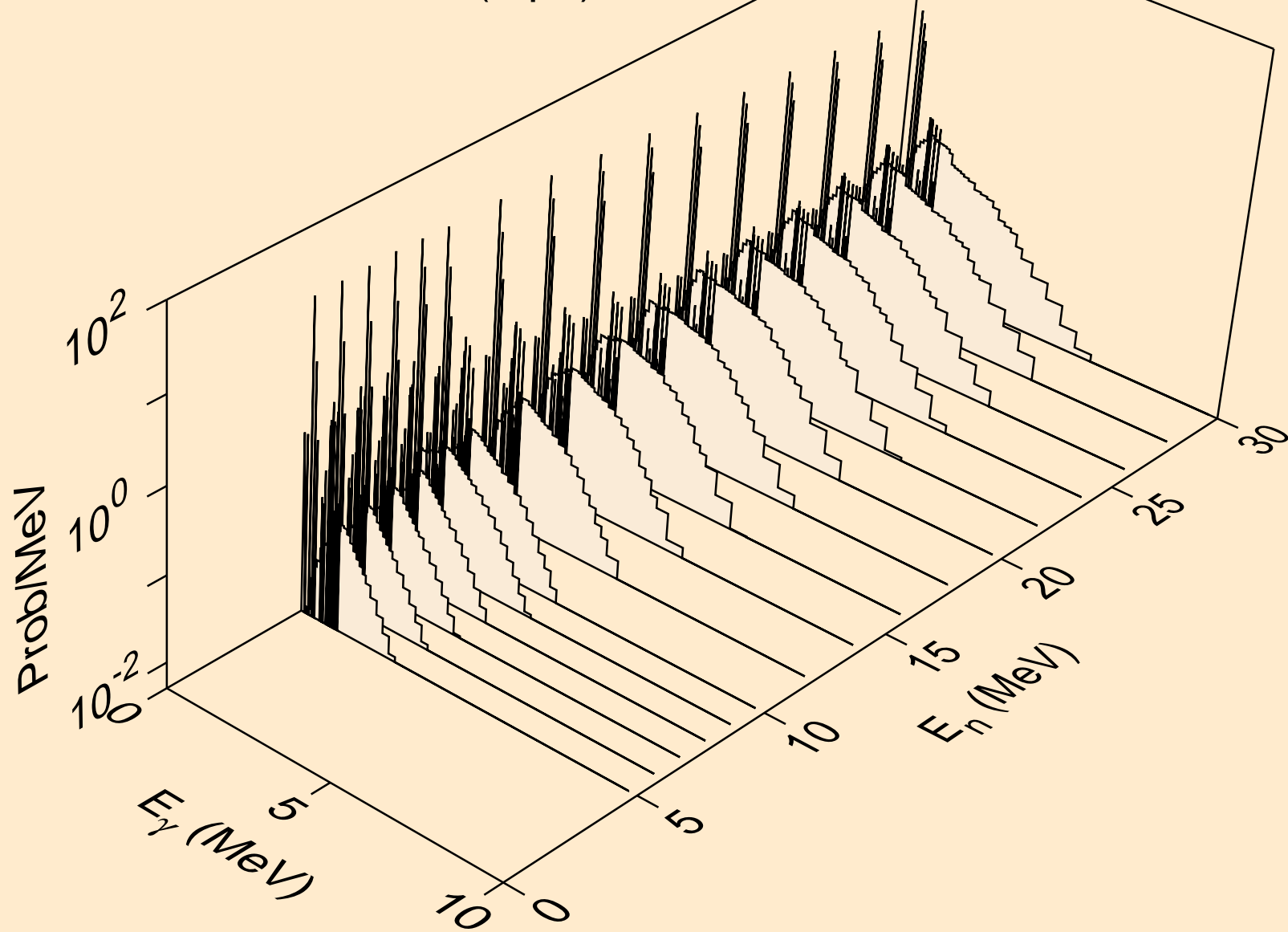

W172 TRITON ACER TENDL-2021 LIBRARY; T=0.K  
Photon emission for (n,pd)

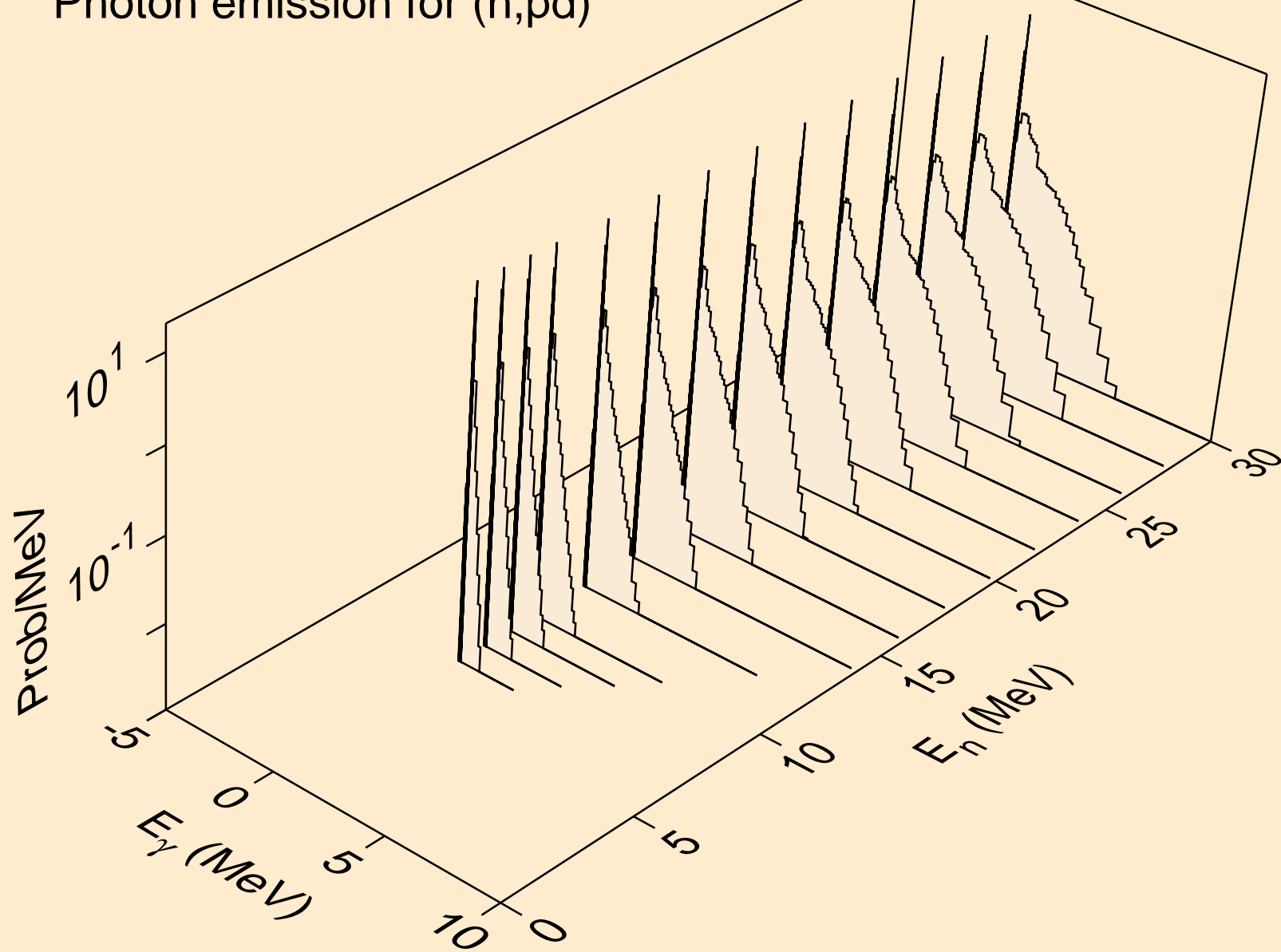

W172 TRITON ACER TENDL-2021 LIBRARY; T=0.K

Photon emission for (n,pt)

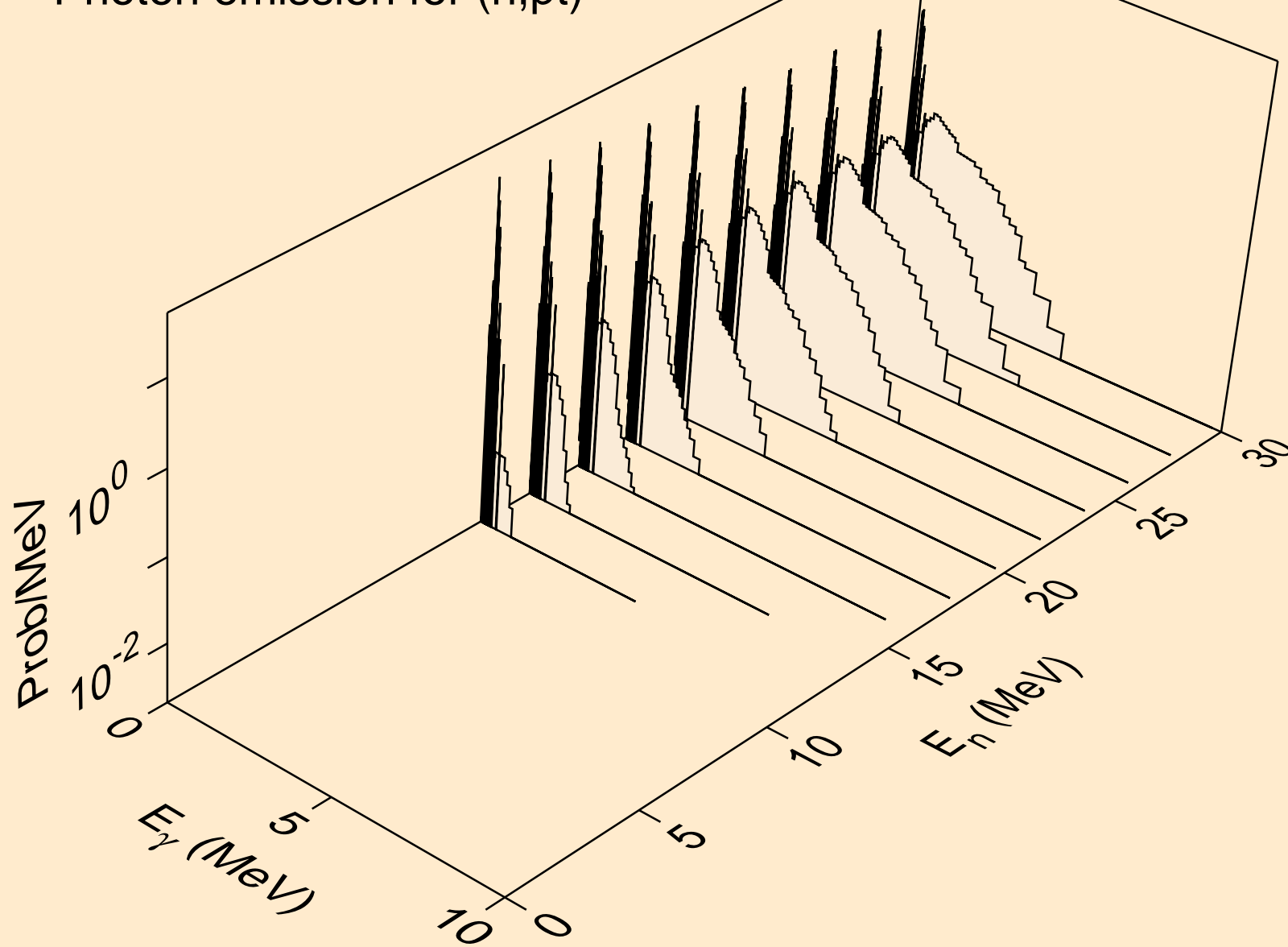

W172 TRITON ACER TENDL-2021 LIBRARY; T=0.K  
Photon emission for (n,da)

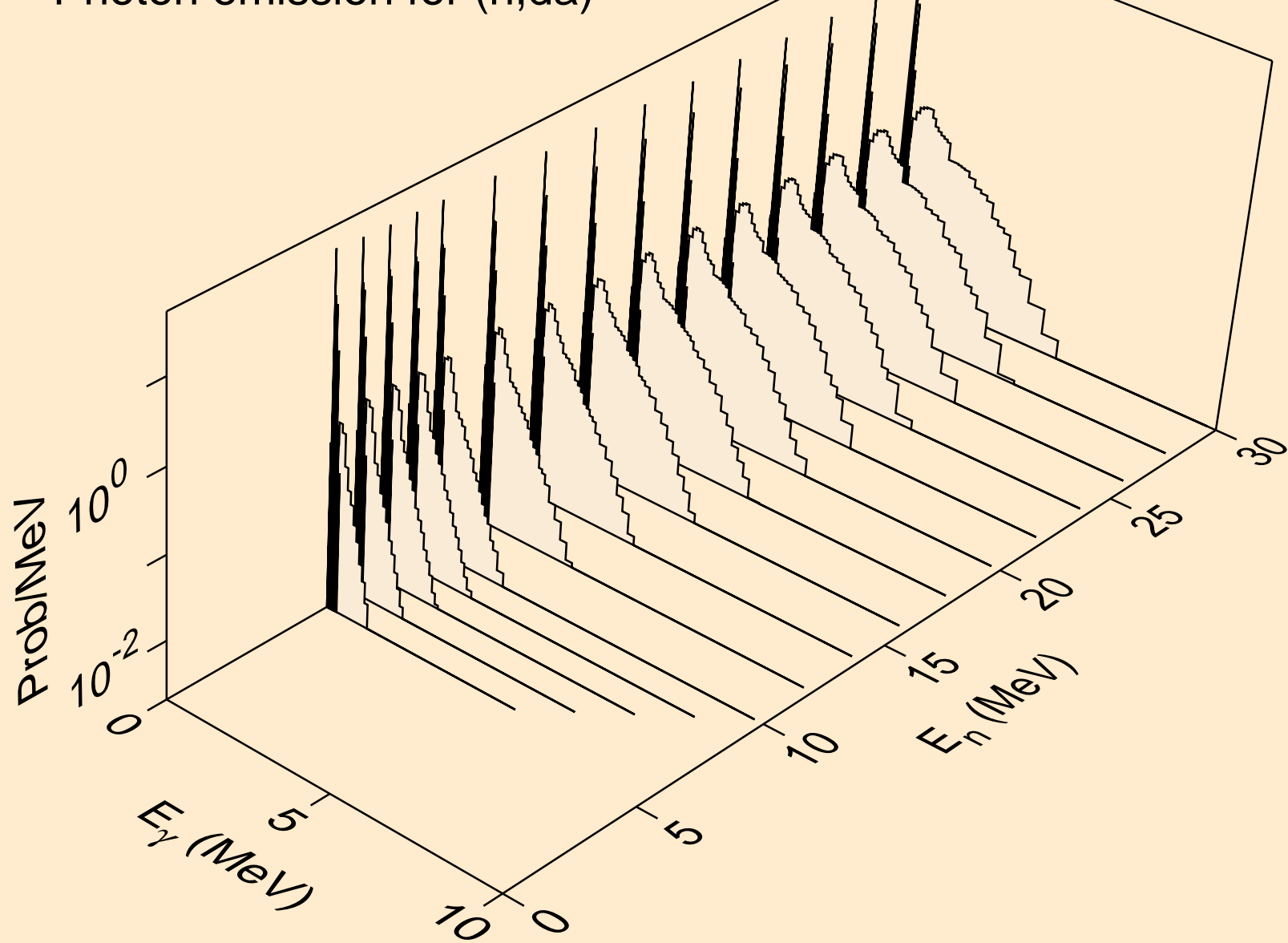

# W172 TRITON ACER TENDL-2021 LIBRARY; T=0.K

## Particle heating contributions

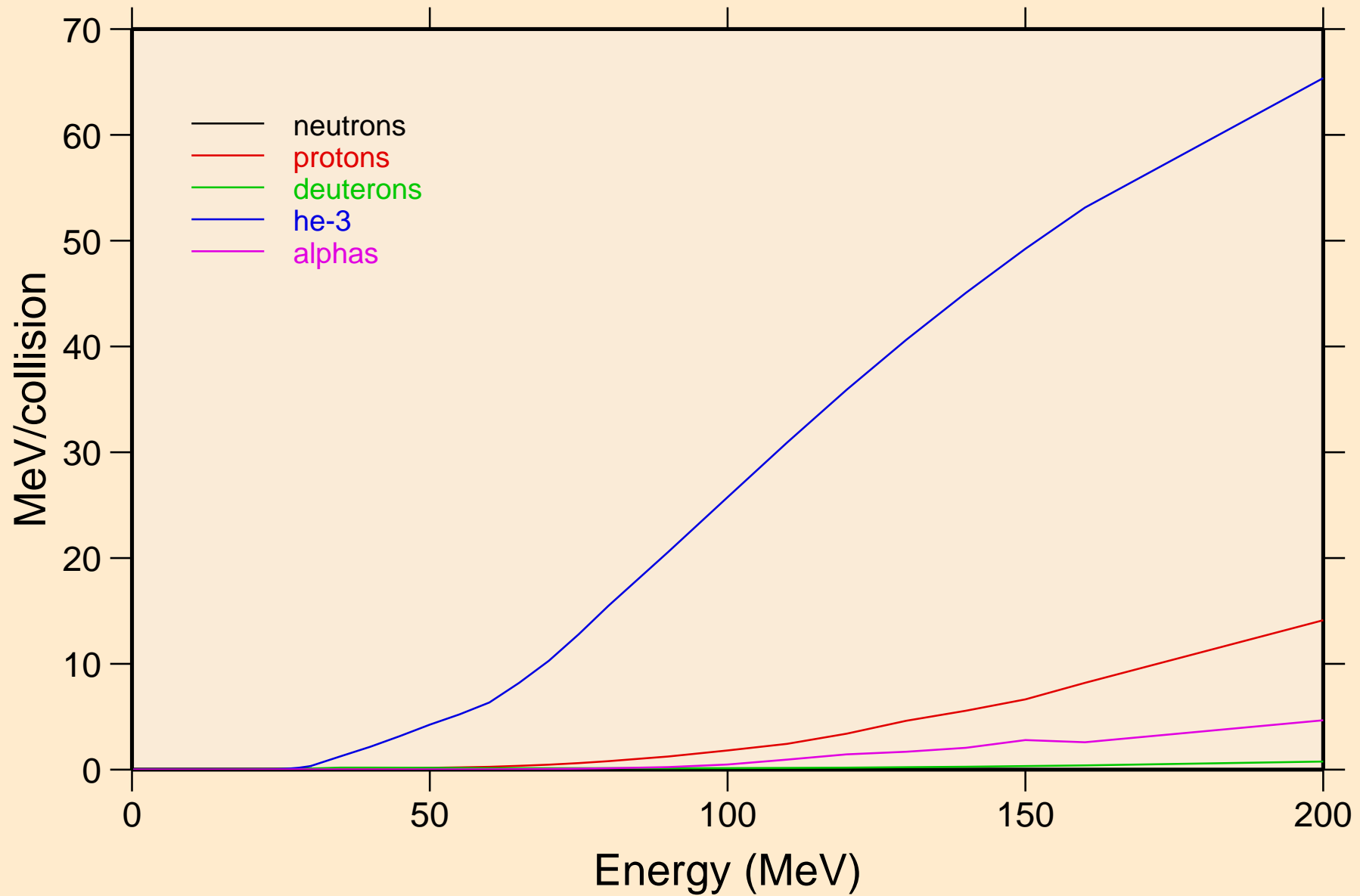

W172 TRITON ACER TENDL-2021 LIBRARY; T=0.K  
Recoil Heating

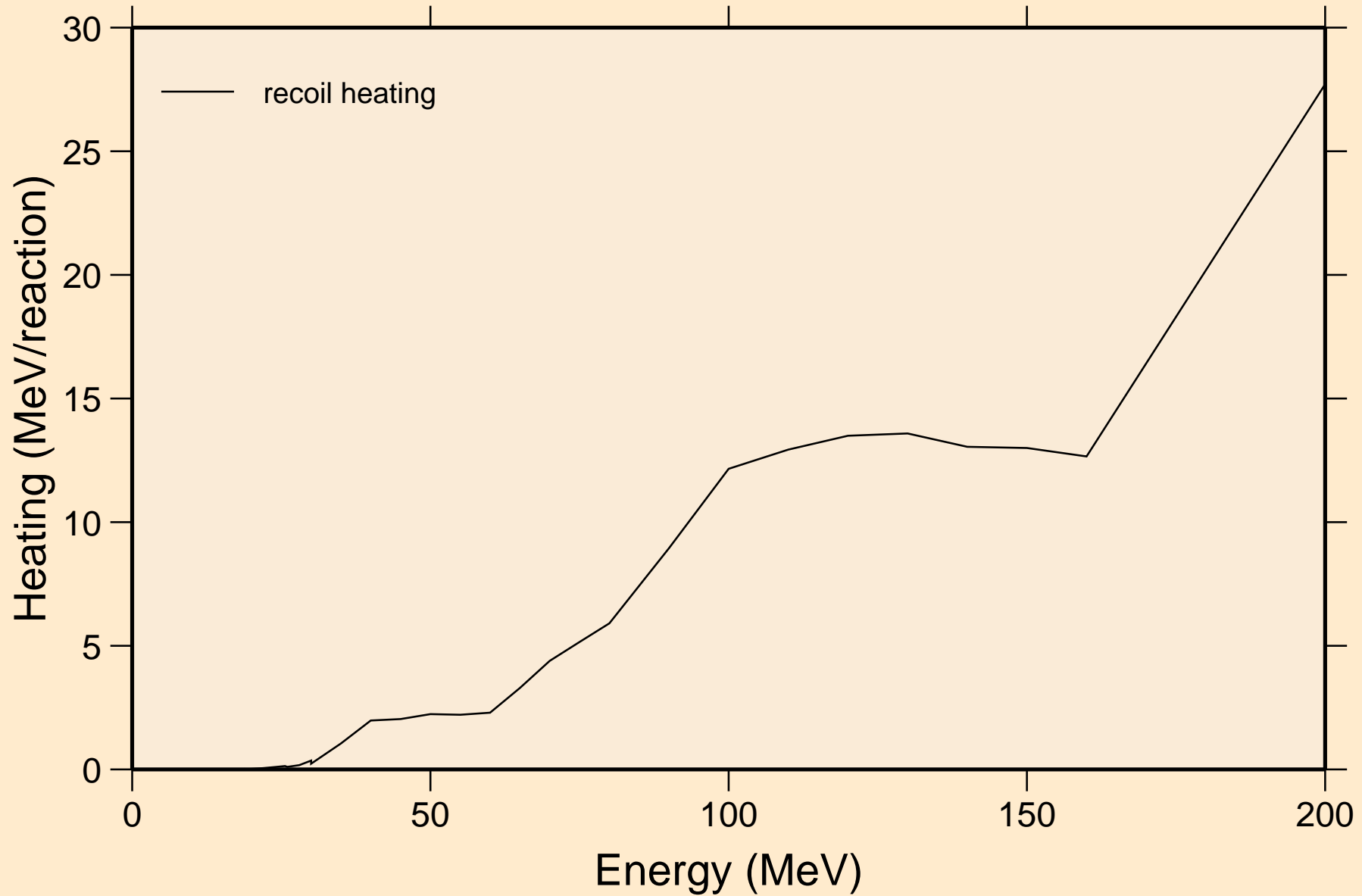

W172 TRITON ACER TENDL-2021 LIBRARY; T=0.K  
Particle production cross sections

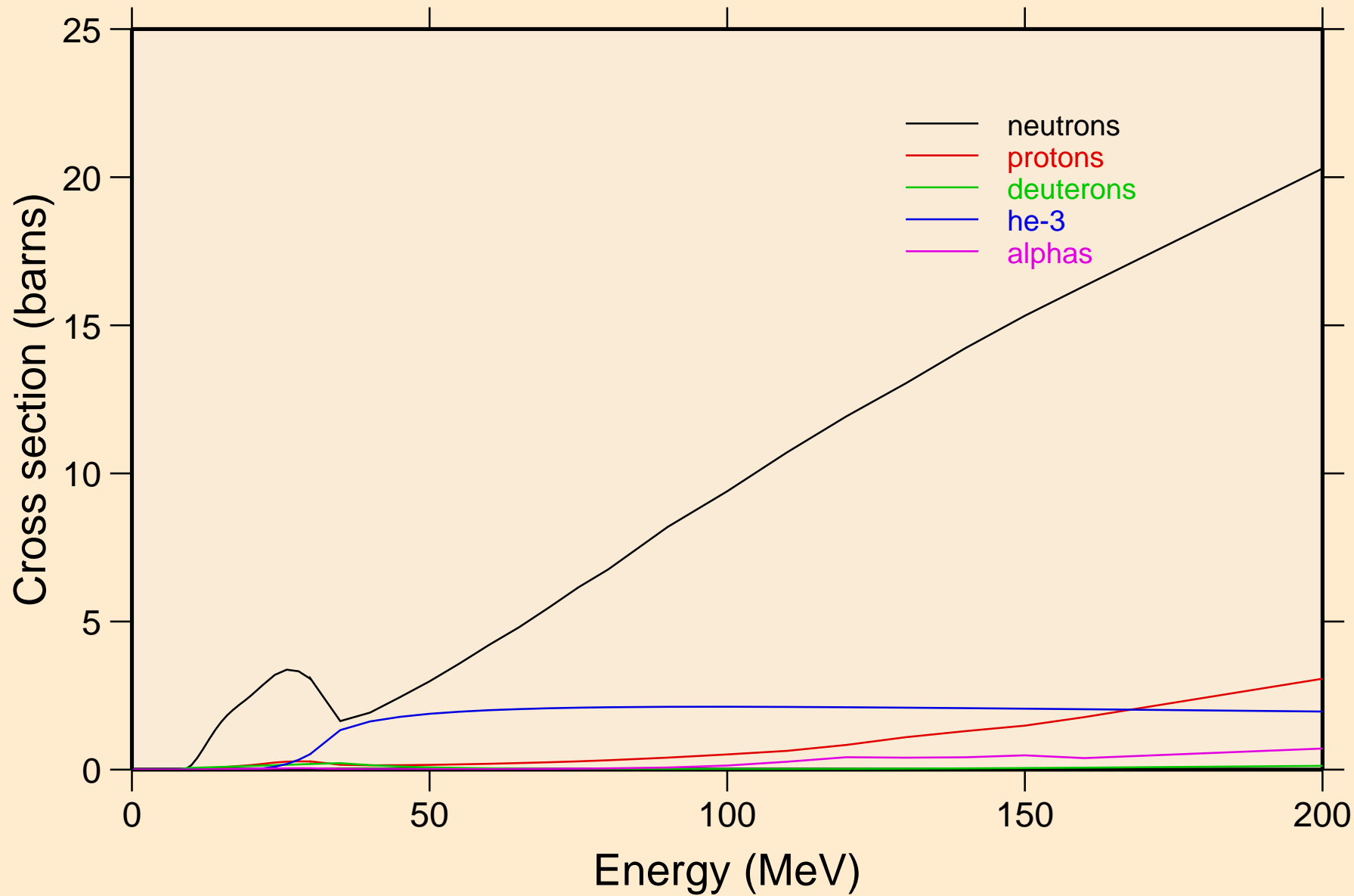

W172 TRITON ACER TENDL-2021 LIBRARY; T=0.K  
neutrons from (t,n)

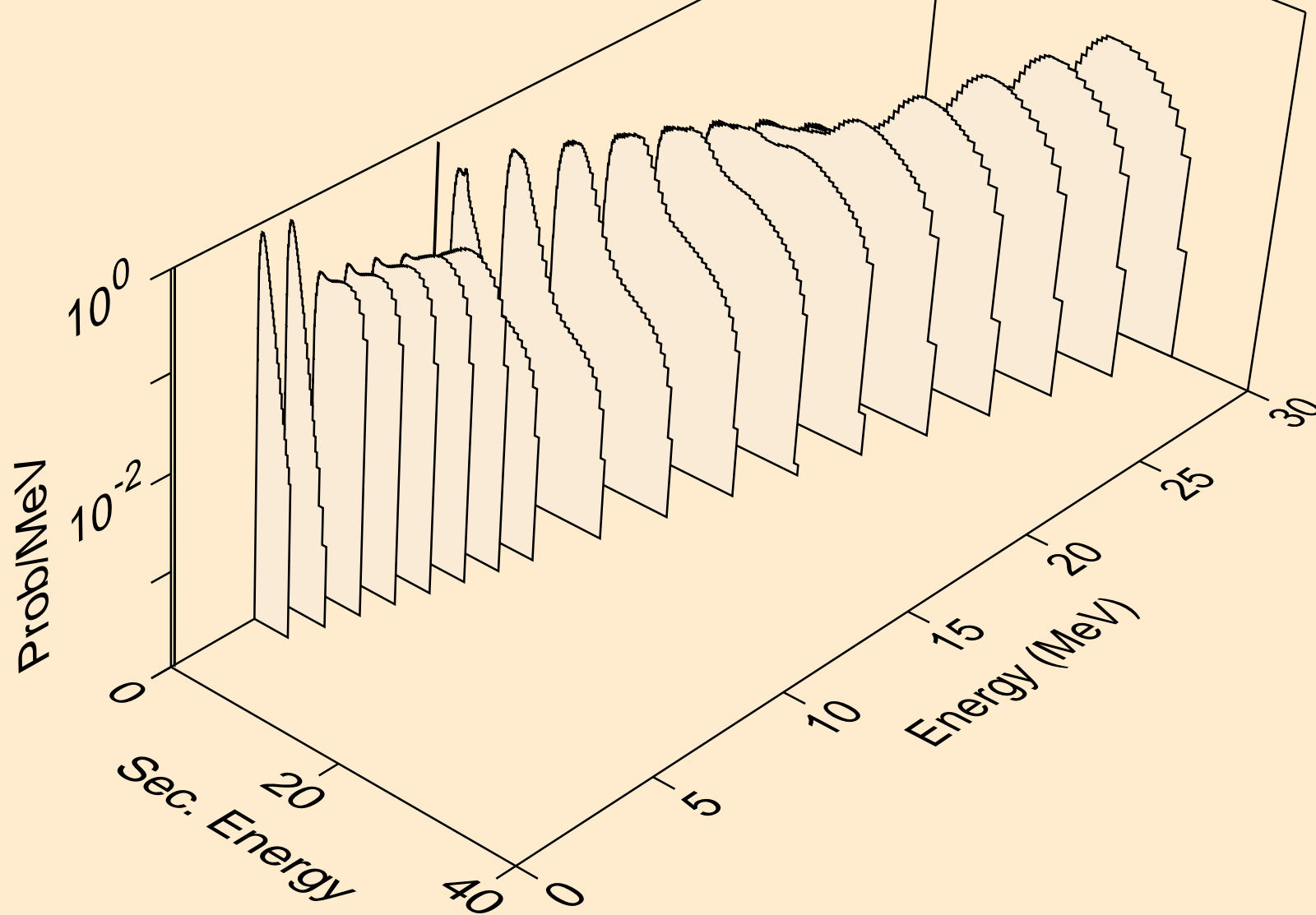



W172 TRITON ACER TENDL-2021 LIBRARY; T=0.K  
neutrons from (t,x)

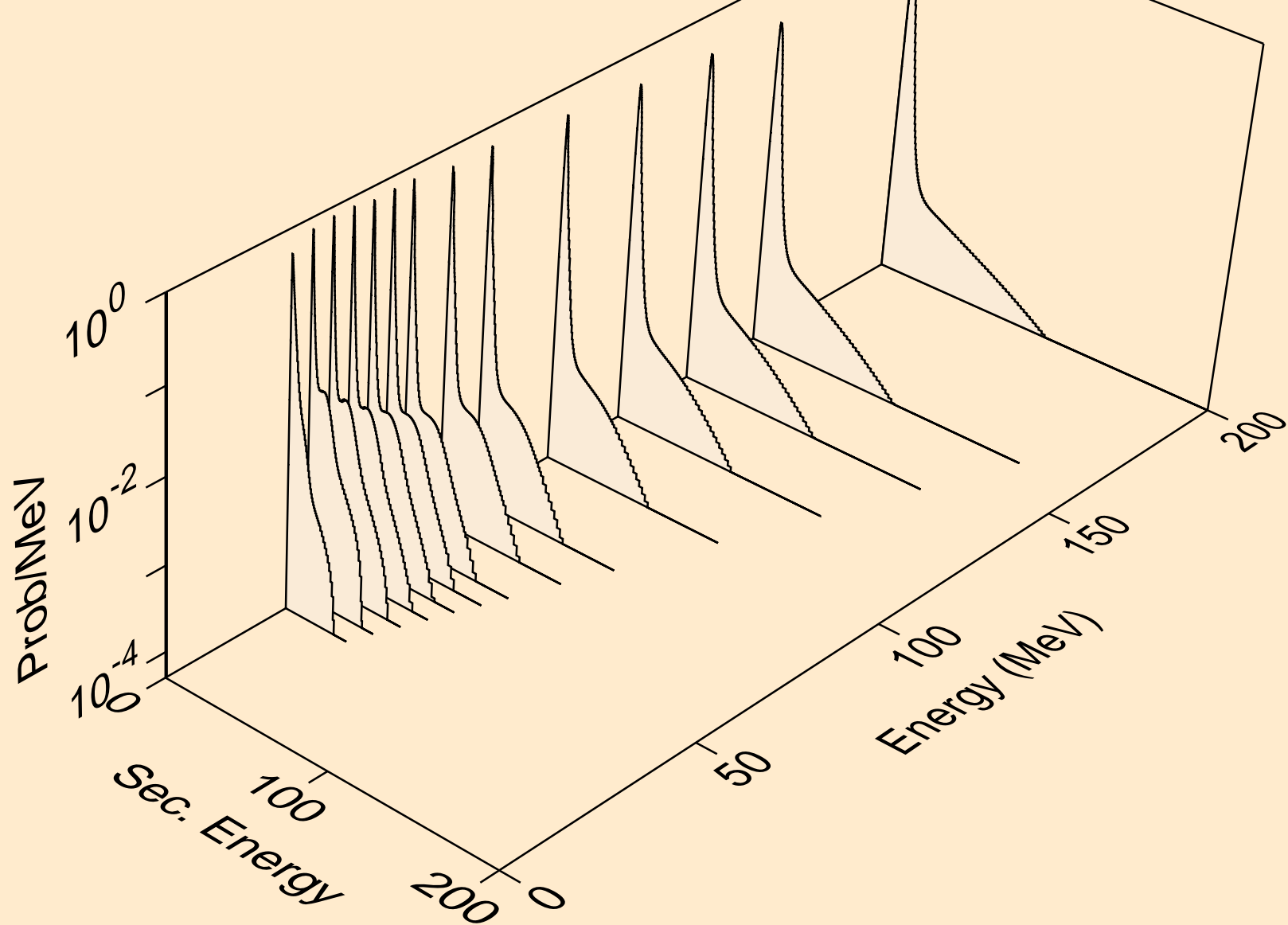

W172 TRITON ACER TENDL-2021 LIBRARY; T=0.K  
neutrons from (t,2nd)

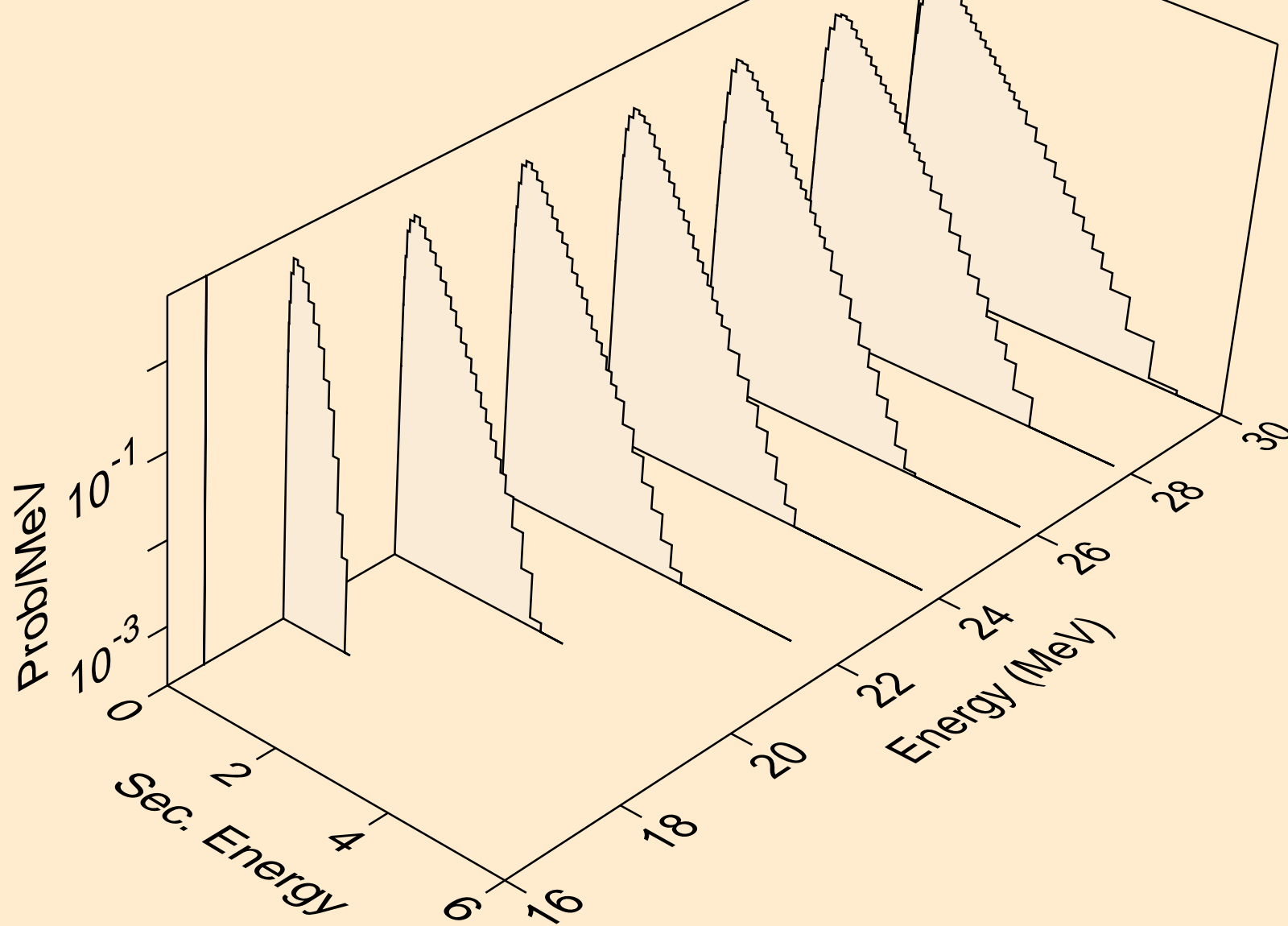

W172 TRITON ACER TENDL-2021 LIBRARY; T=0.K  
neutrons from (t,2n)

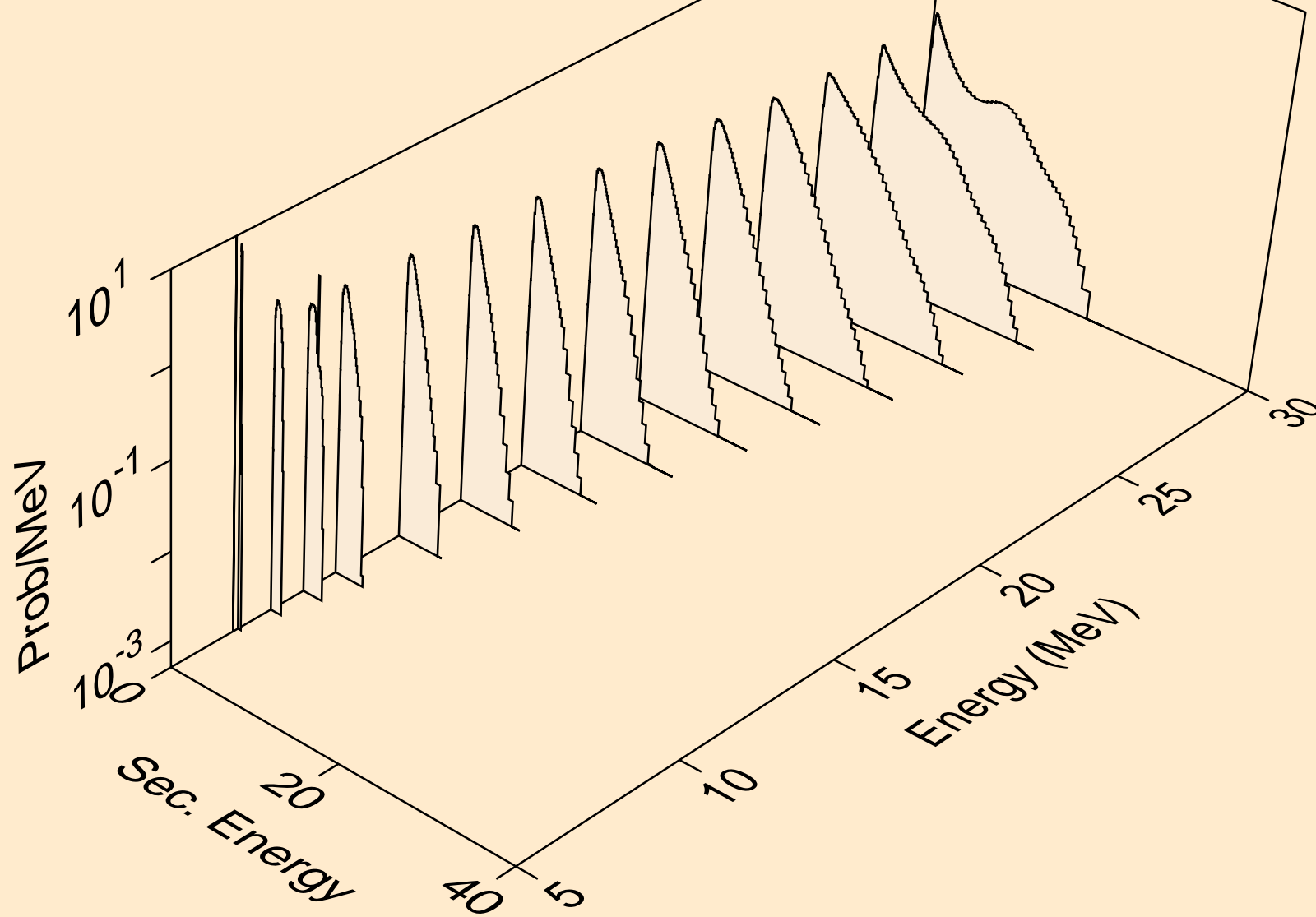

W172 TRITON ACER TENDL-2021 LIBRARY; T=0.K  
neutrons from (t,3n)

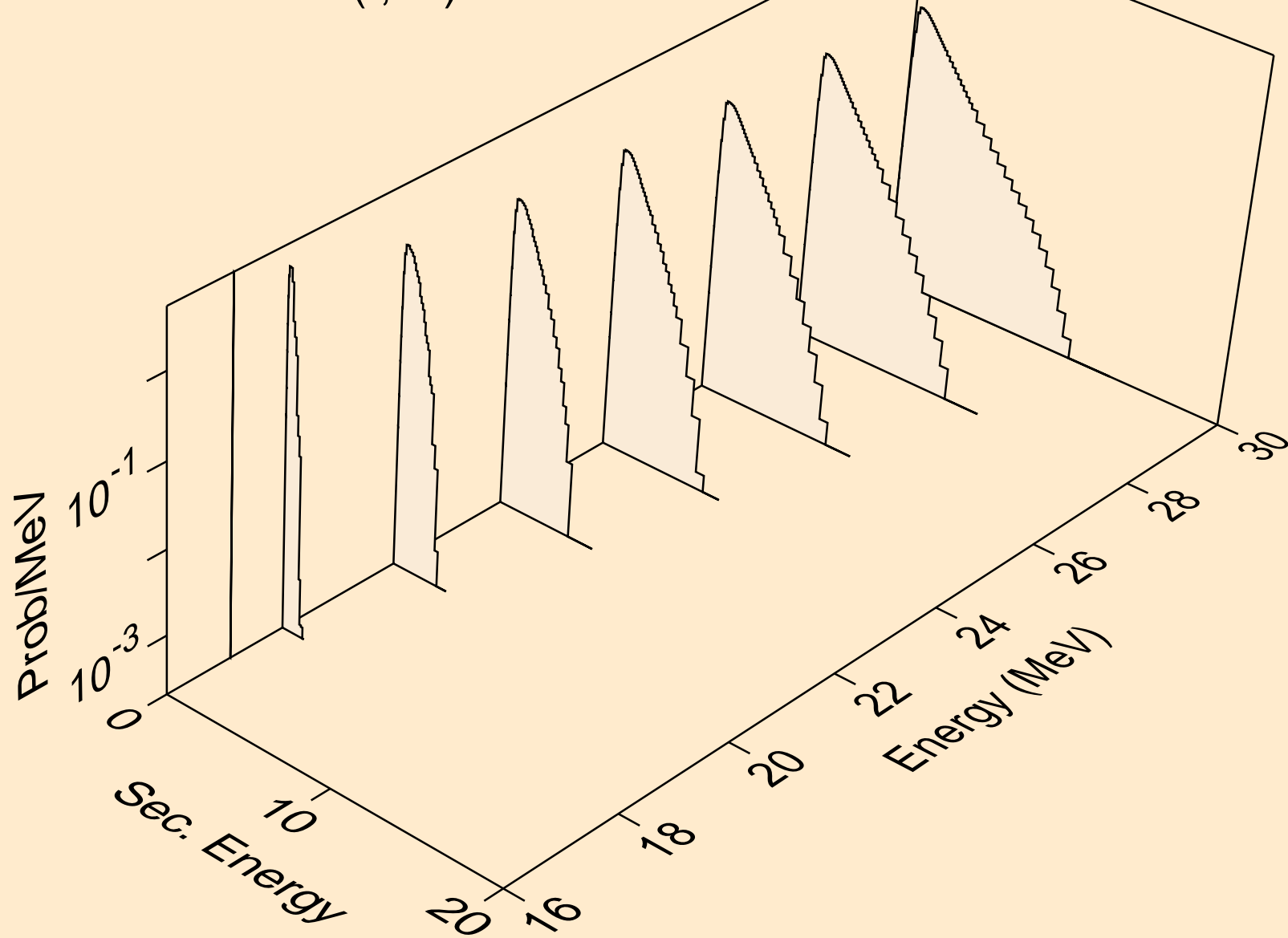

W172 TRITON ACER TENDL-2021 LIBRARY; T=0.K  
neutrons from (t,n\*)a

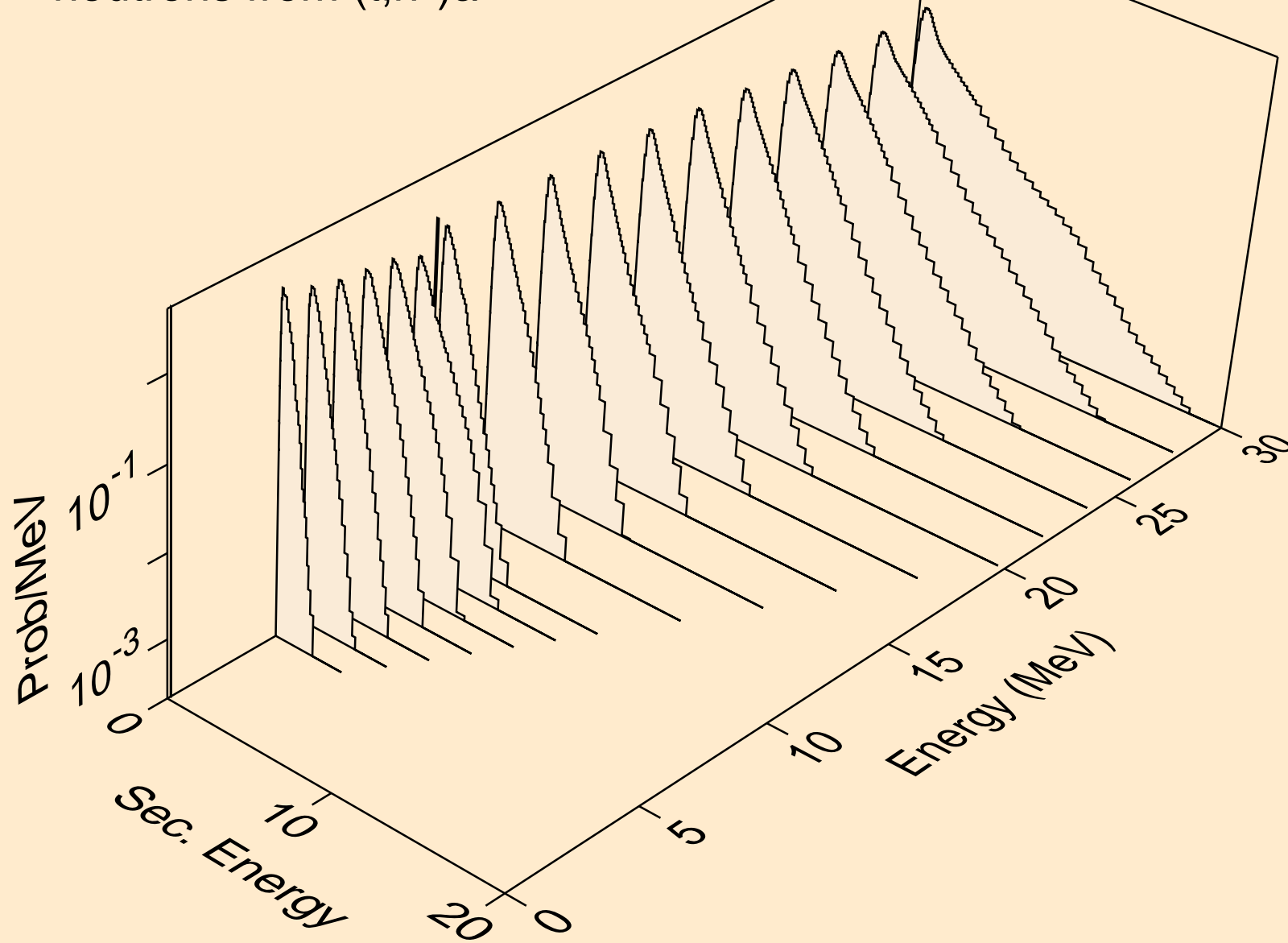

W172 TRITON ACER TENDL-2021 LIBRARY; T=0.K  
neutrons from (t,2n)a

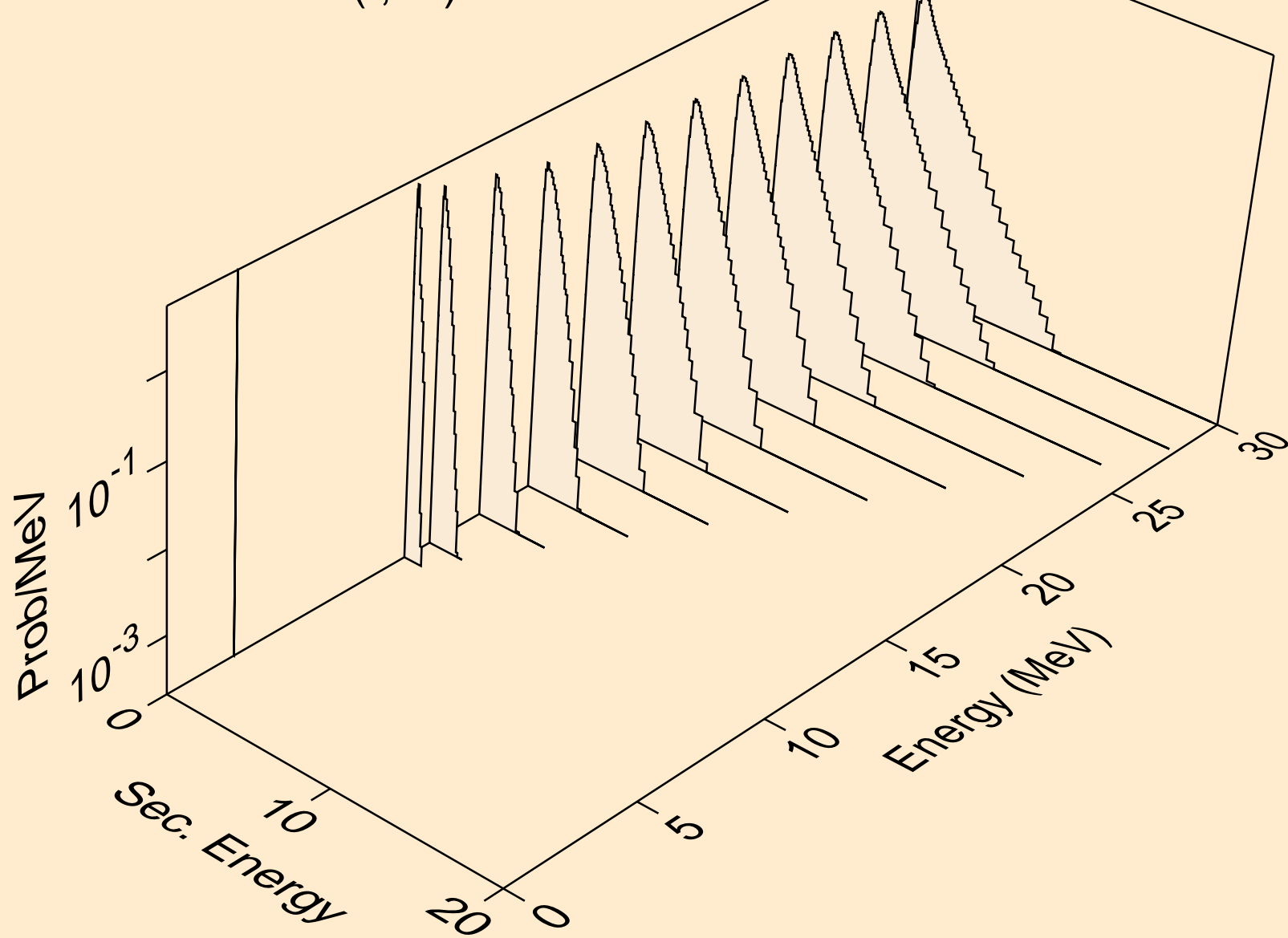

W172 TRITON ACER TENDL-2021 LIBRARY; T=0.K  
neutrons from (t,3n)a

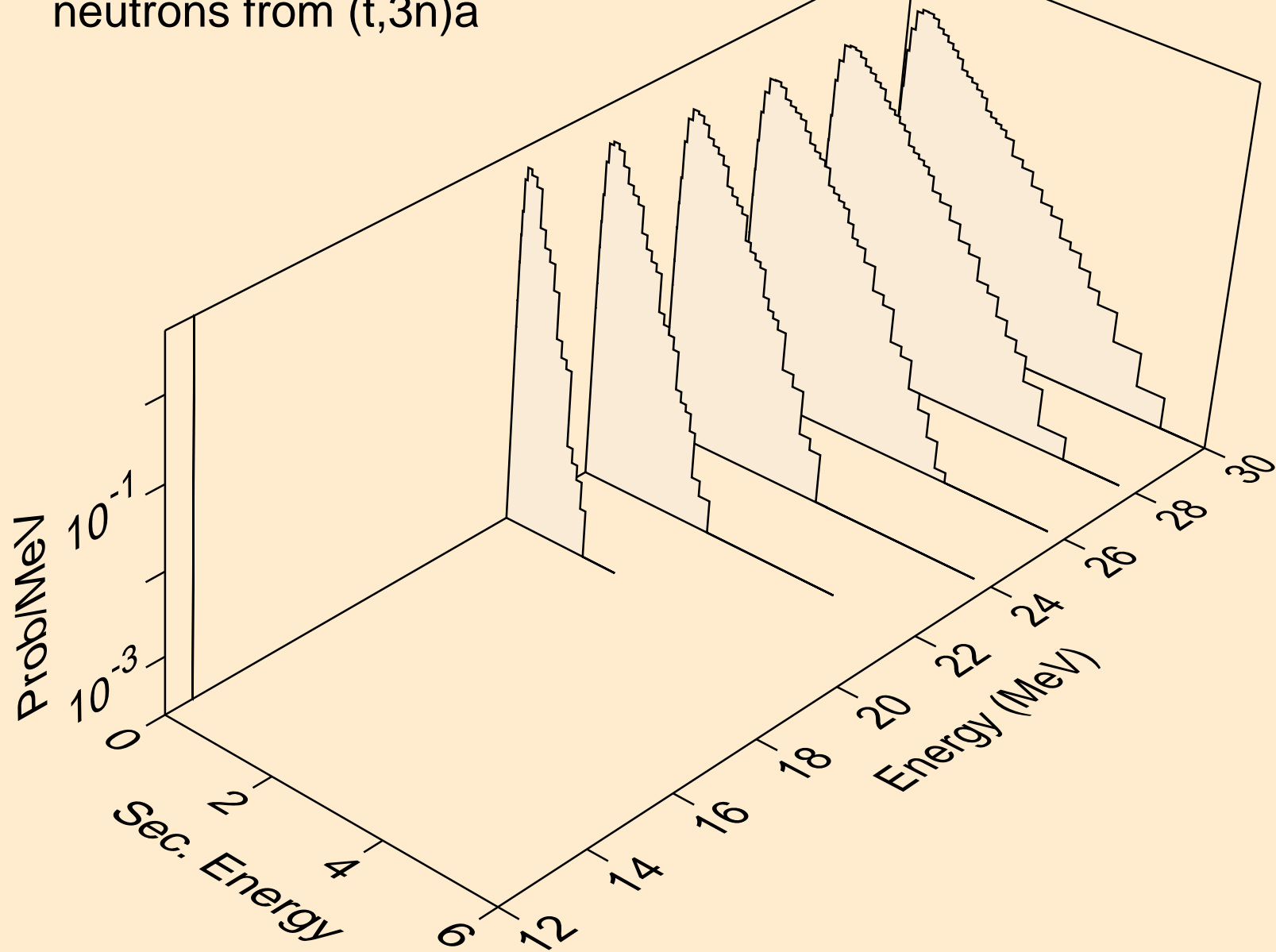

W172 TRITON ACER TENDL-2021 LIBRARY; T=0.K  
neutrons from (t,n\*)p

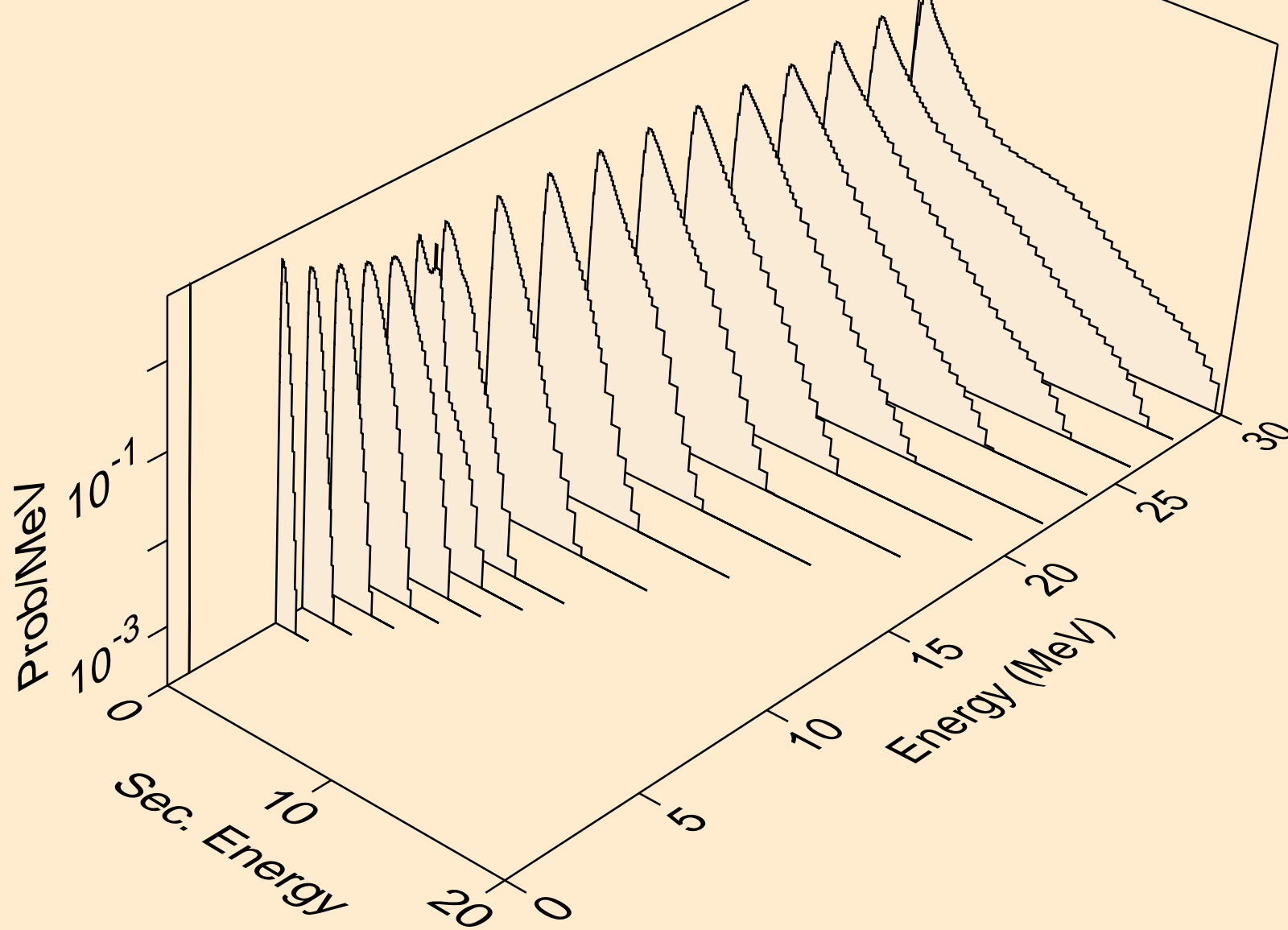



W172 TRITON ACER TENDL-2021 LIBRARY; T=0.K  
neutrons from (t,n\*)2a

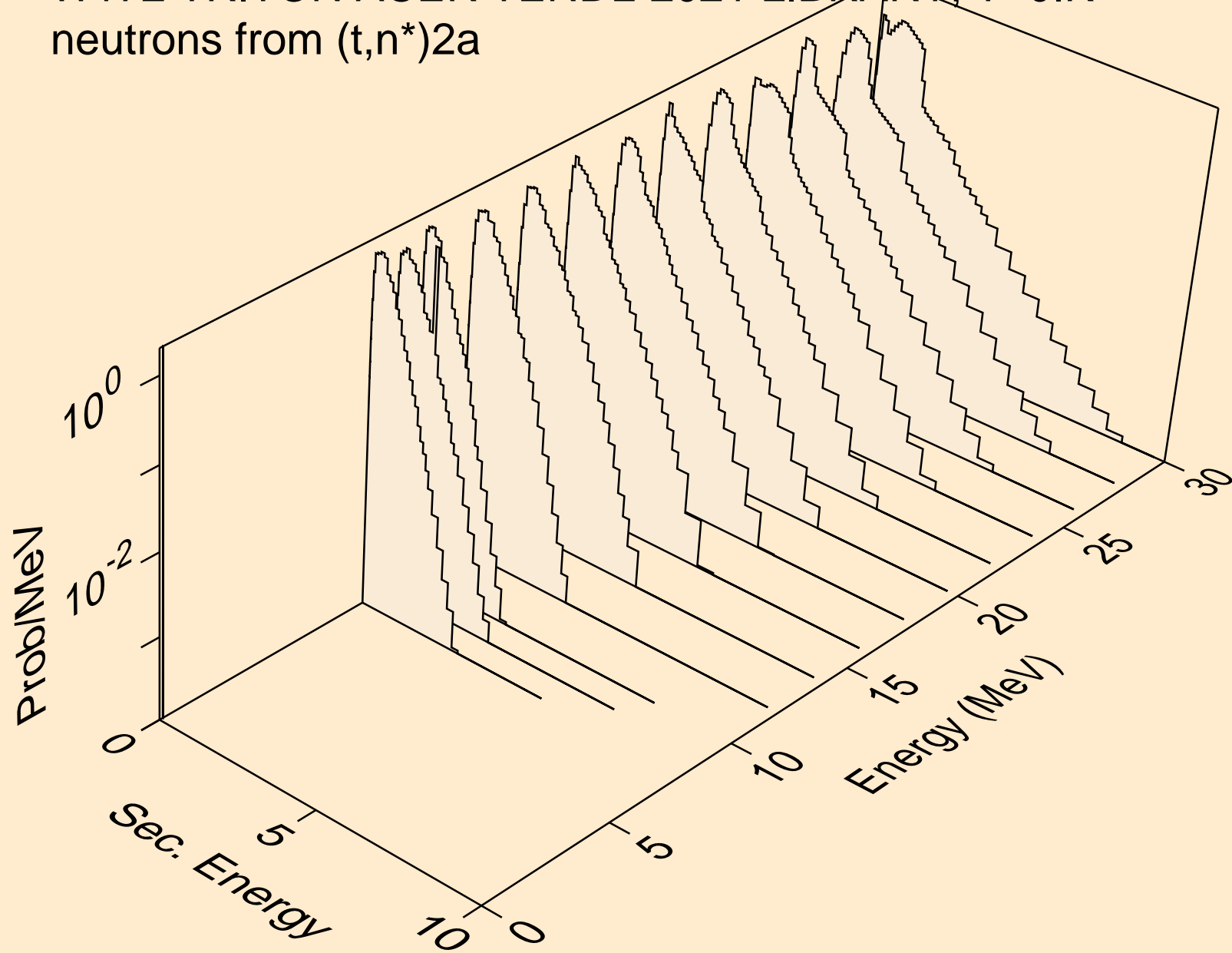

W172 TRITON ACER TENDL-2021 LIBRARY; T=0.K  
neutrons from (t,2n)2a

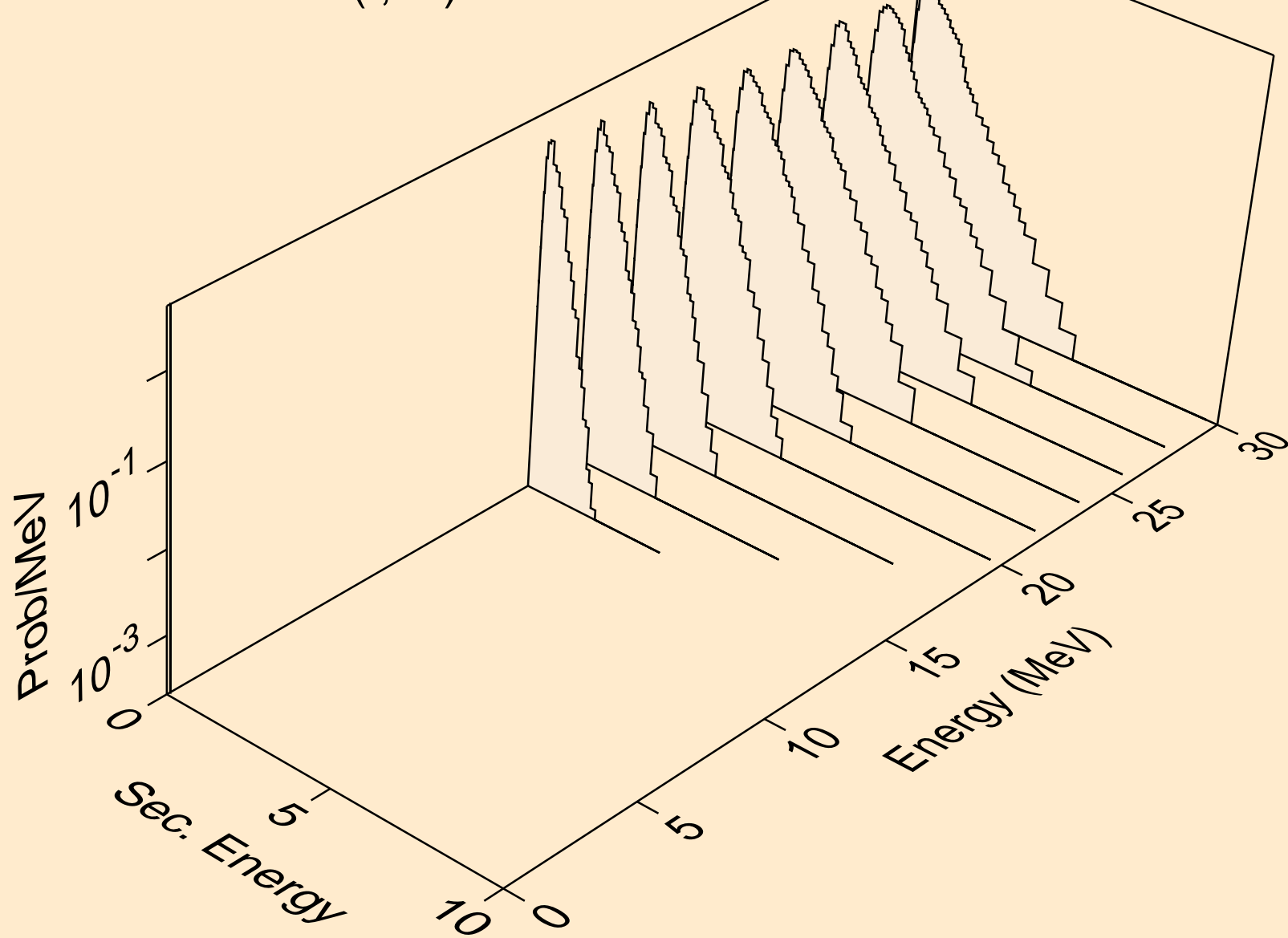

W172 TRITON ACER TENDL-2021 LIBRARY; T=0.K  
neutrons from (t,n\*)d

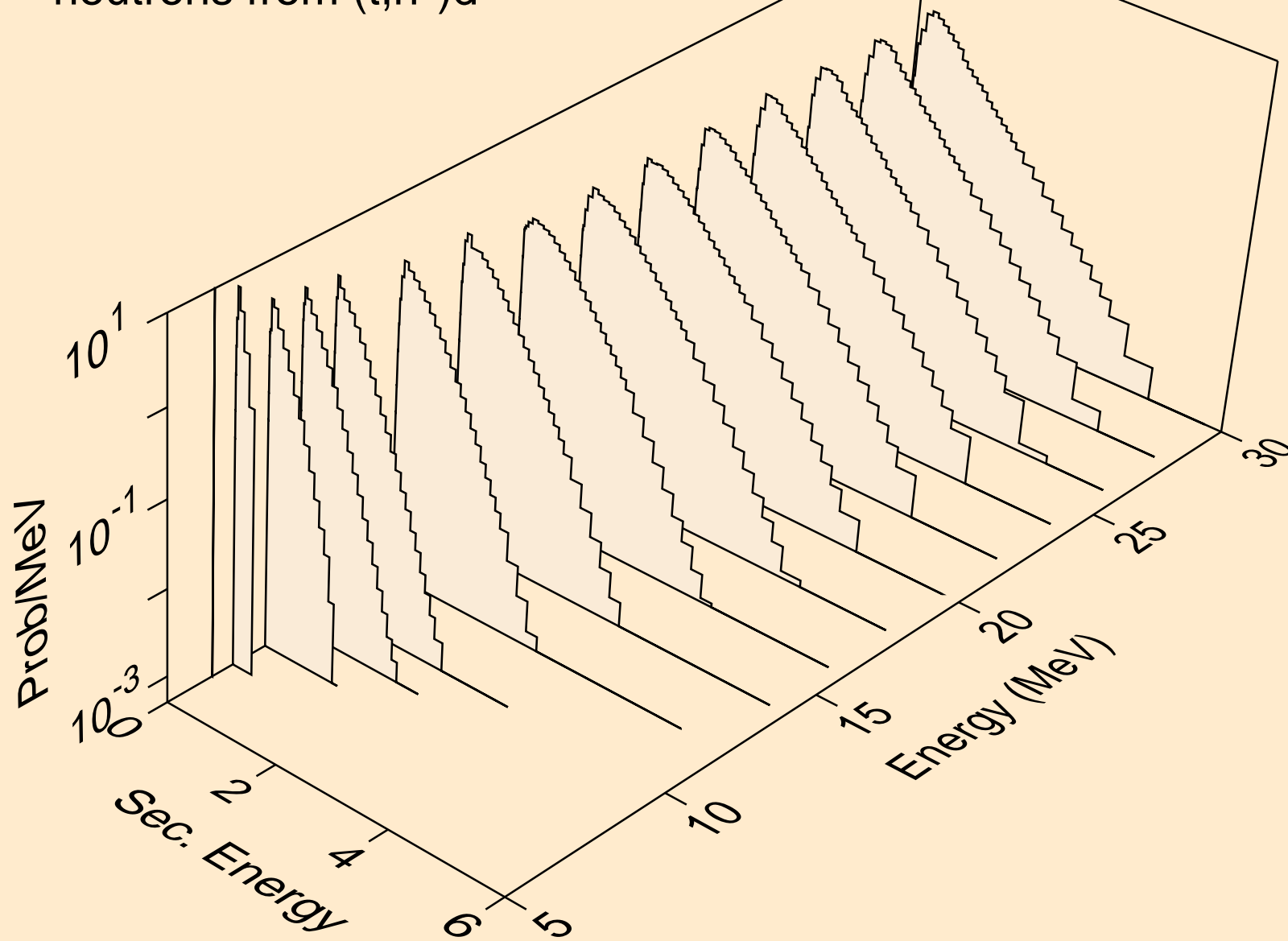

W172 TRITON ACER TENDL-2021 LIBRARY; T=0.K  
neutrons from (t,n\*)t

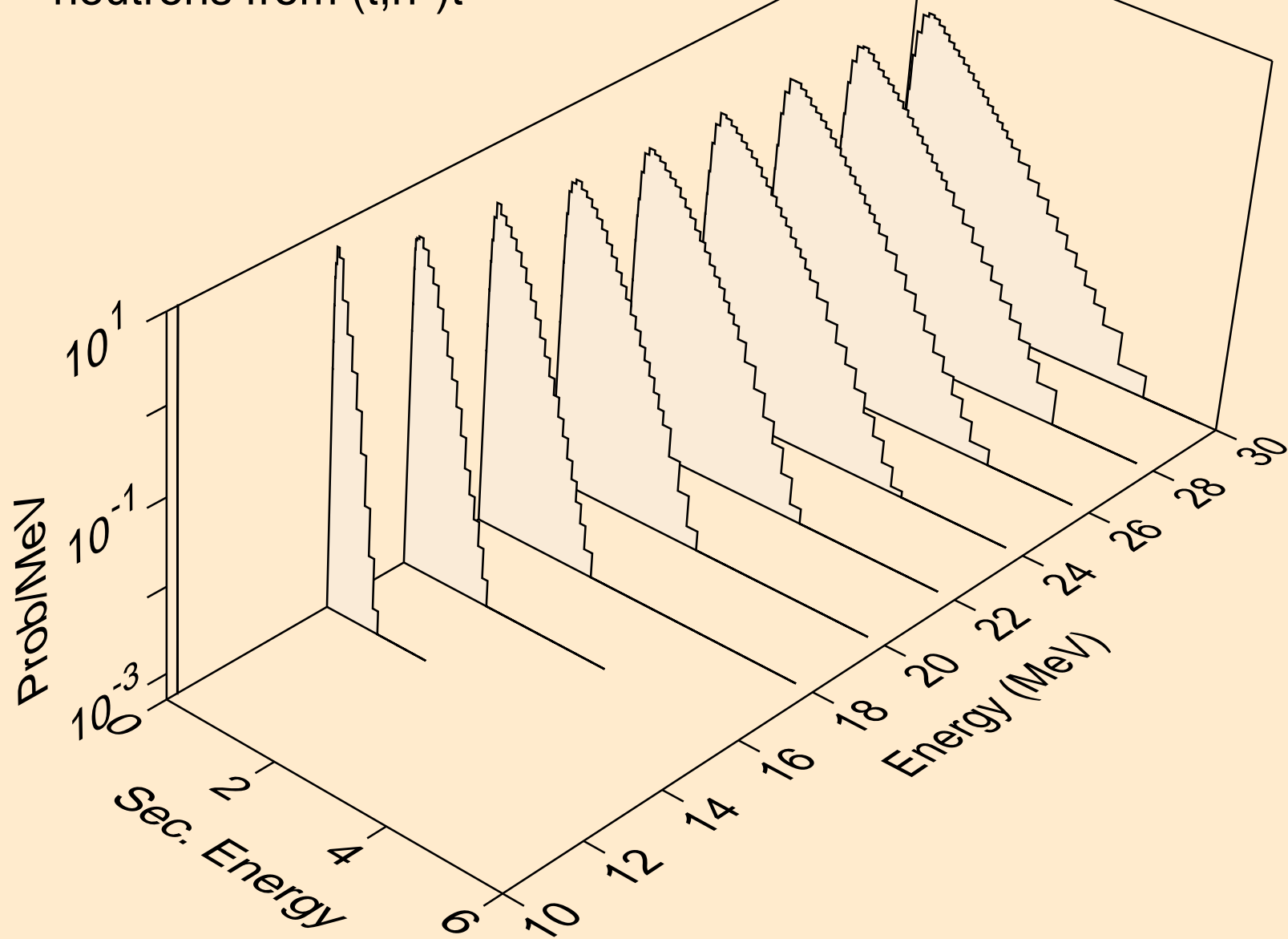

W172 TRITON ACER TENDL-2021 LIBRARY; T=0.K  
neutrons from (t,n\*)he3

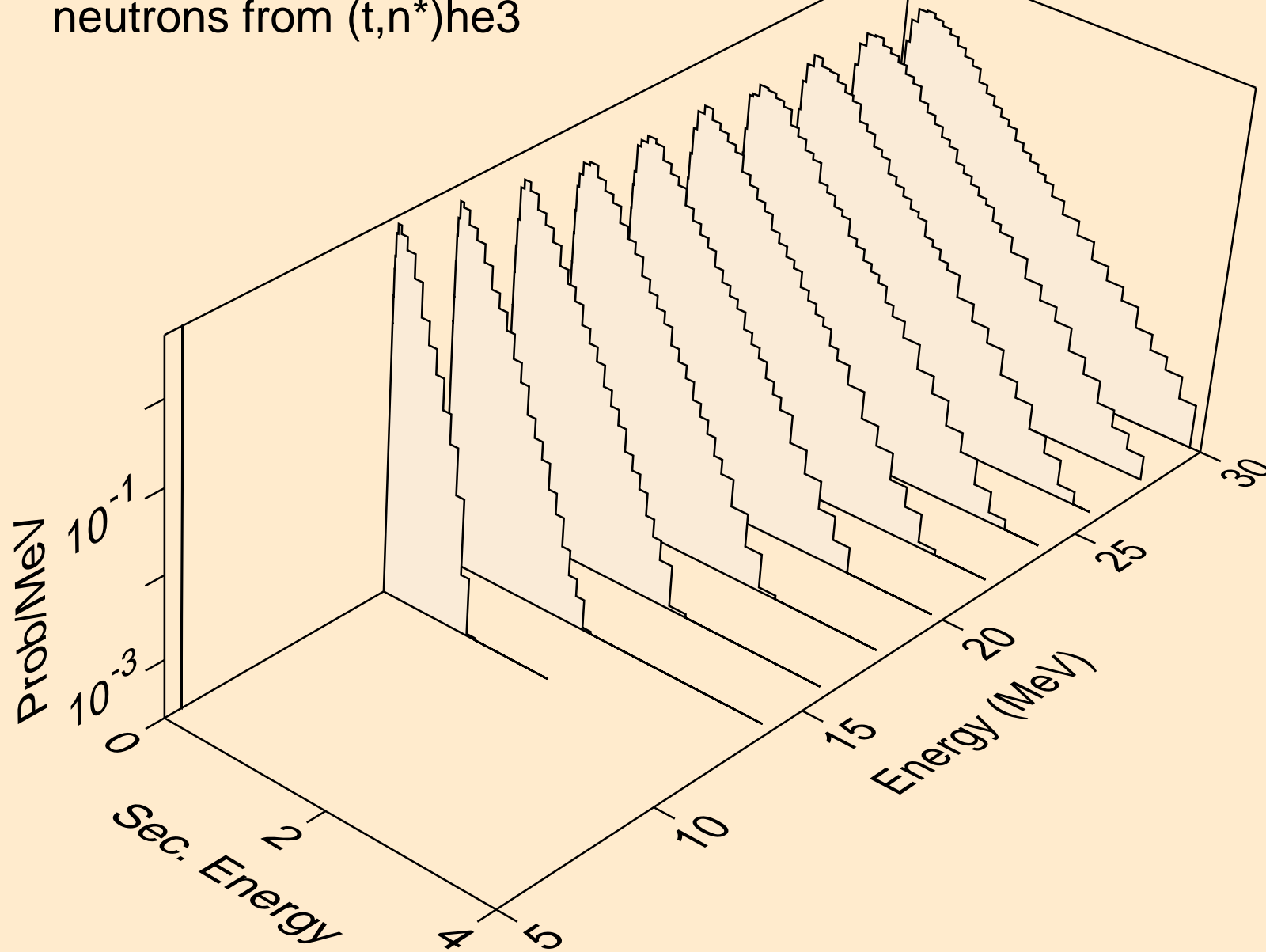

W172 TRITON ACER TENDL-2021 LIBRARY; T=0.K  
neutrons from (t,4n)

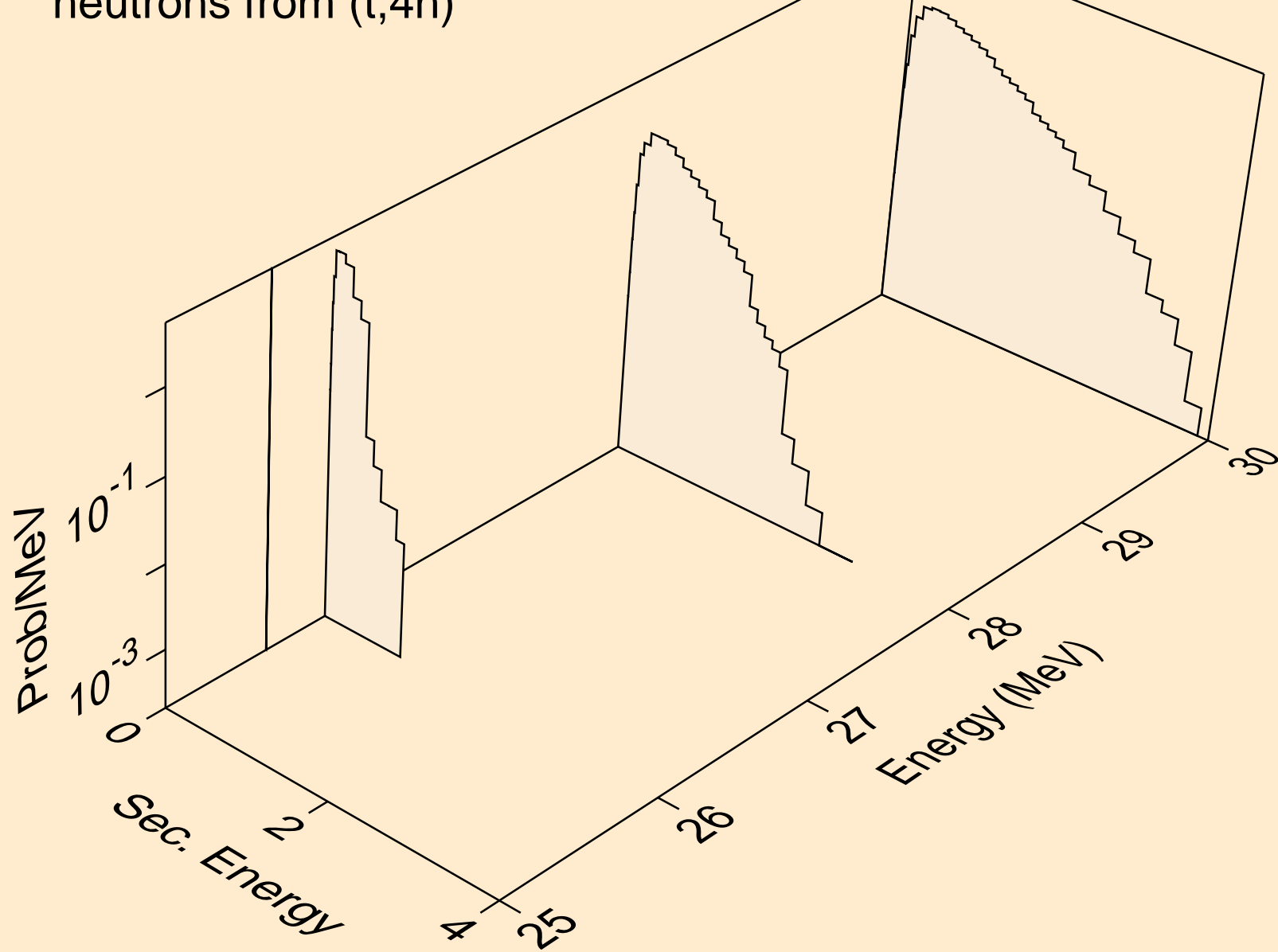

W172 TRITON ACER TENDL-2021 LIBRARY; T=0.K  
neutrons from (t,2np)

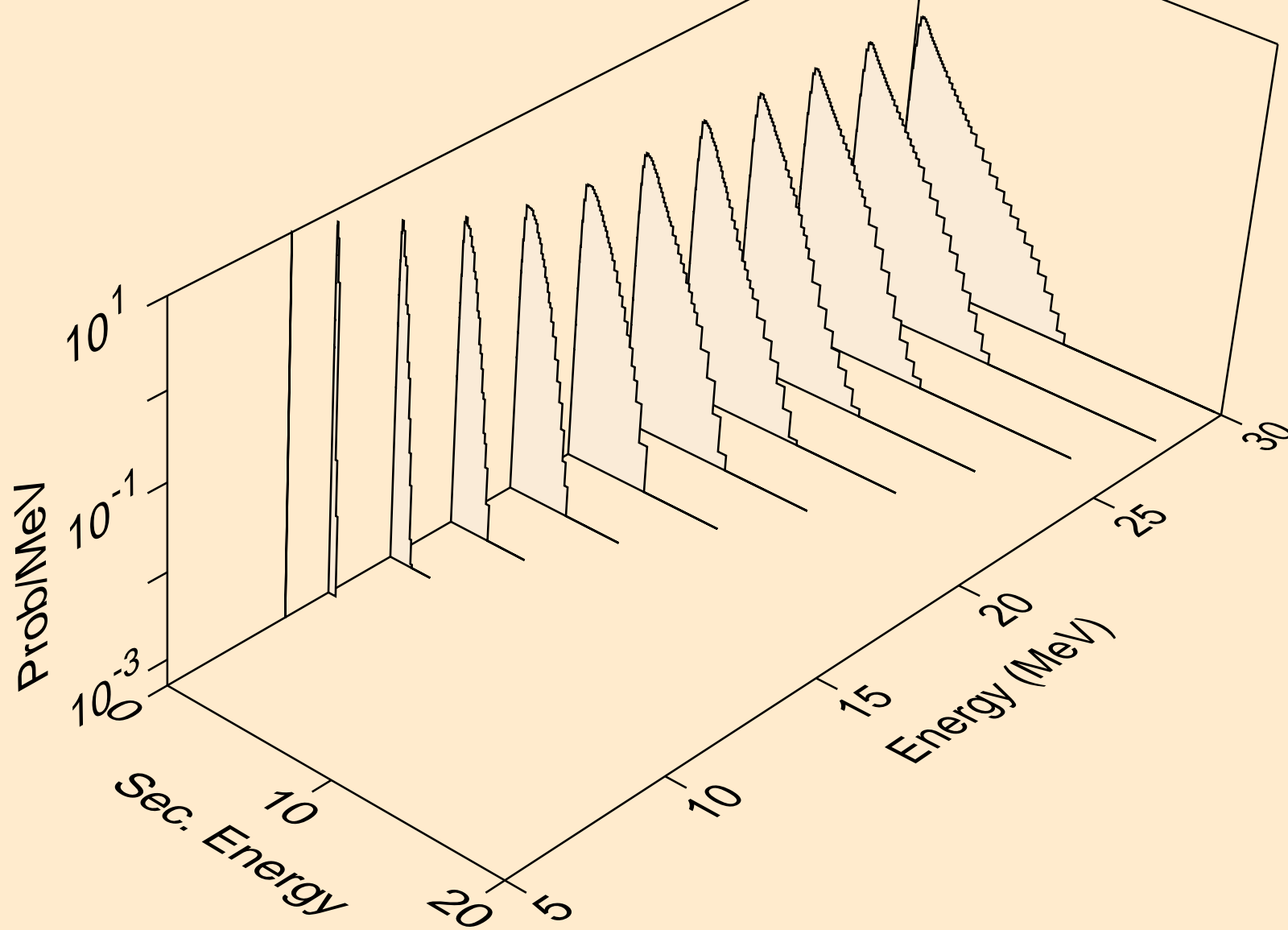

W172 TRITON ACER TENDL-2021 LIBRARY; T=0.K  
neutrons from (t,3np)

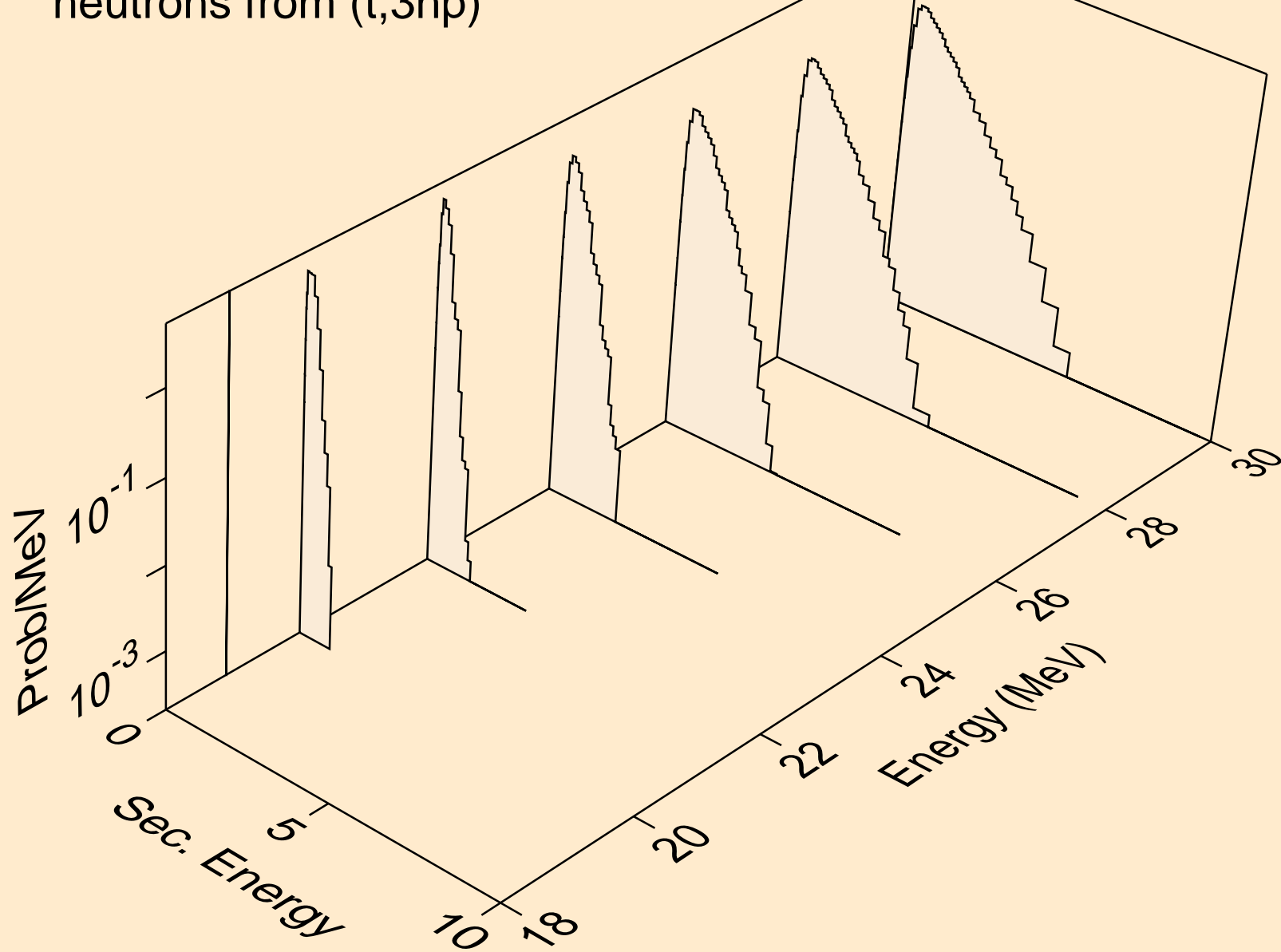



W172 TRITON ACER TENDL-2021 LIBRARY; T=0.K  
neutrons from (t,2np)

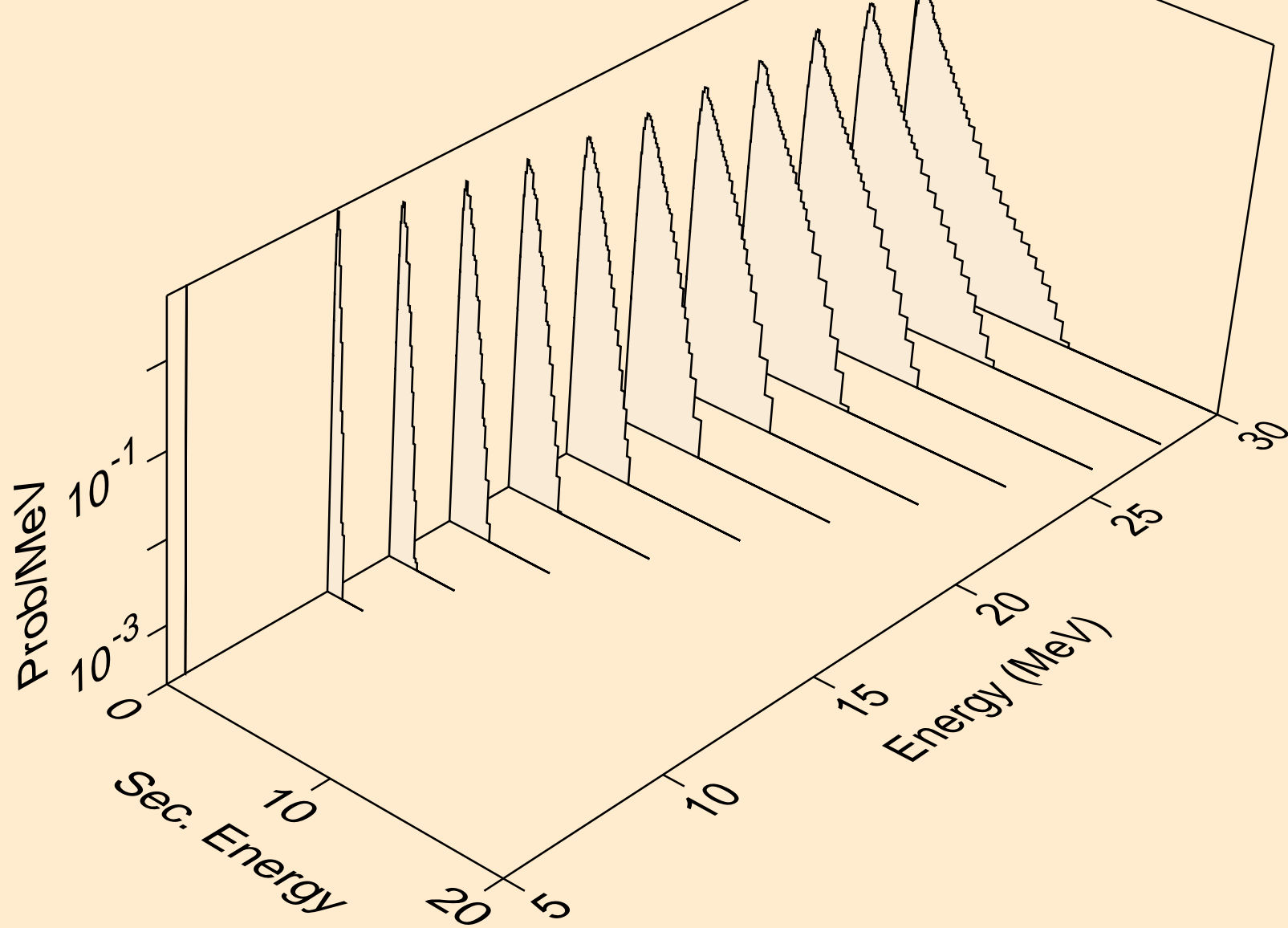

W172 TRITON ACER TENDL-2021 LIBRARY; T=0.K  
neutrons from (t,npa)

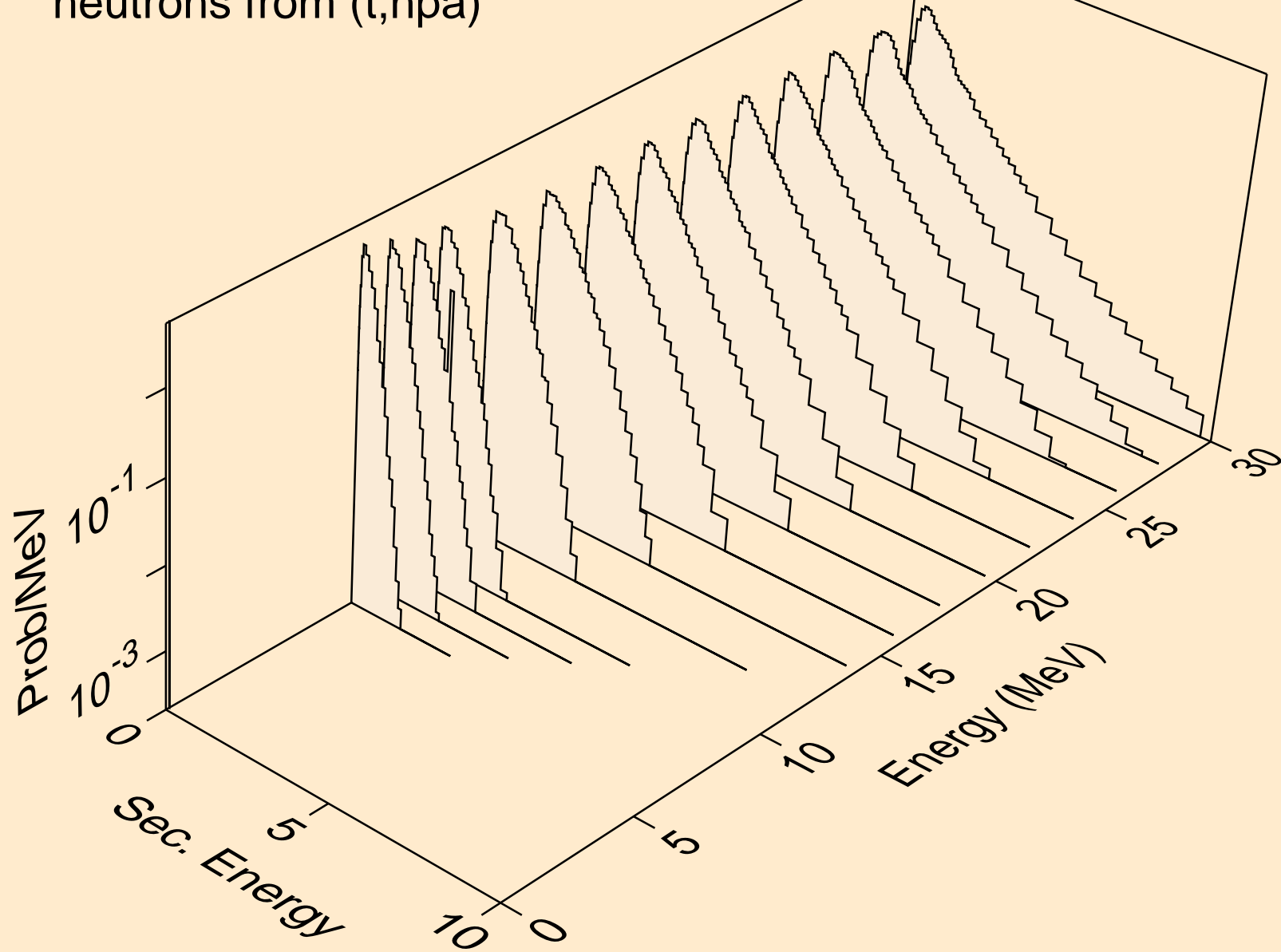

W172 TRITON ACER TENDL-2021 LIBRARY; T=0.K  
protons from (t,x)

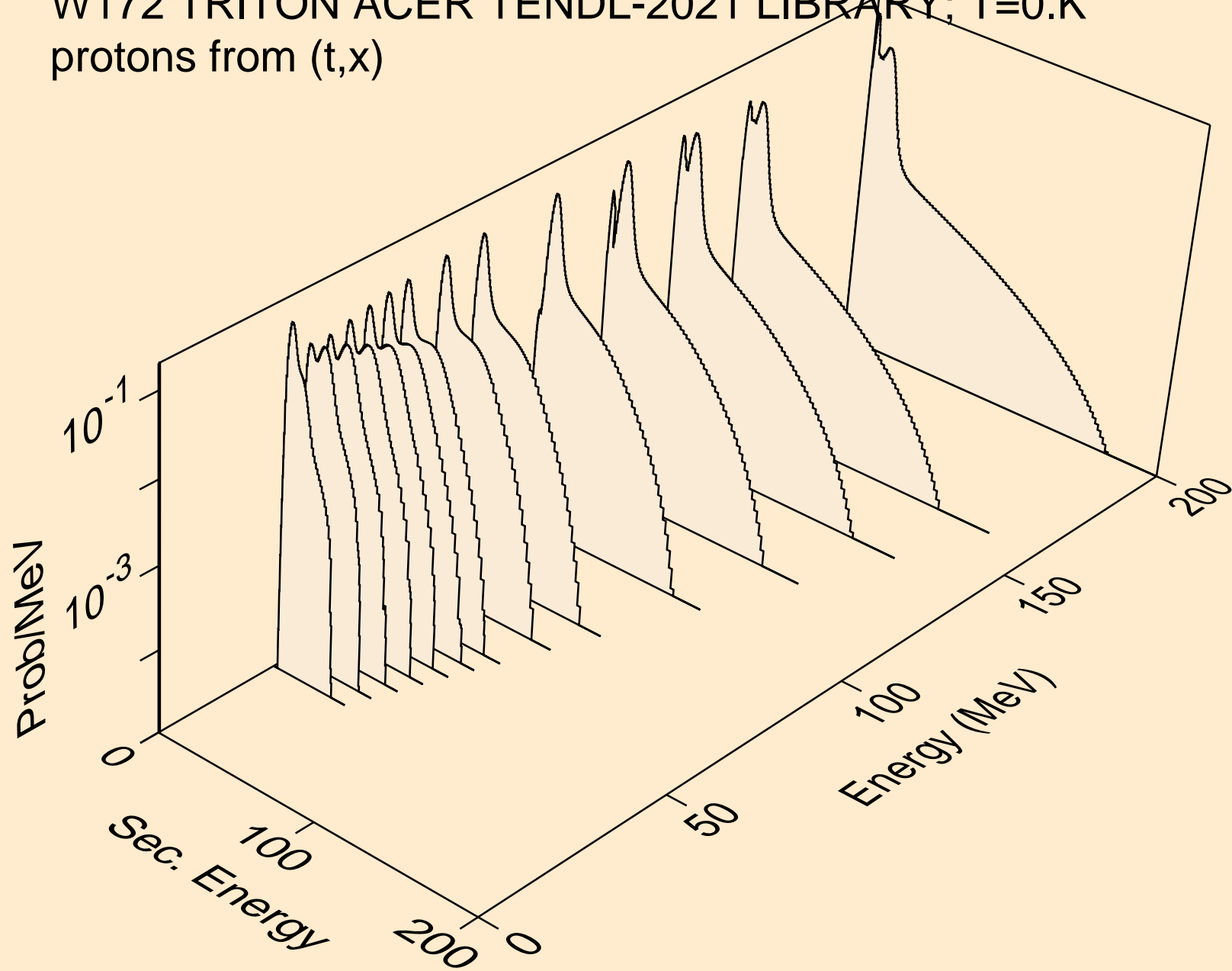

W172 TRITON ACER TENDL-2021 LIBRARY; T=0.K  
protons from (t,n\*)p

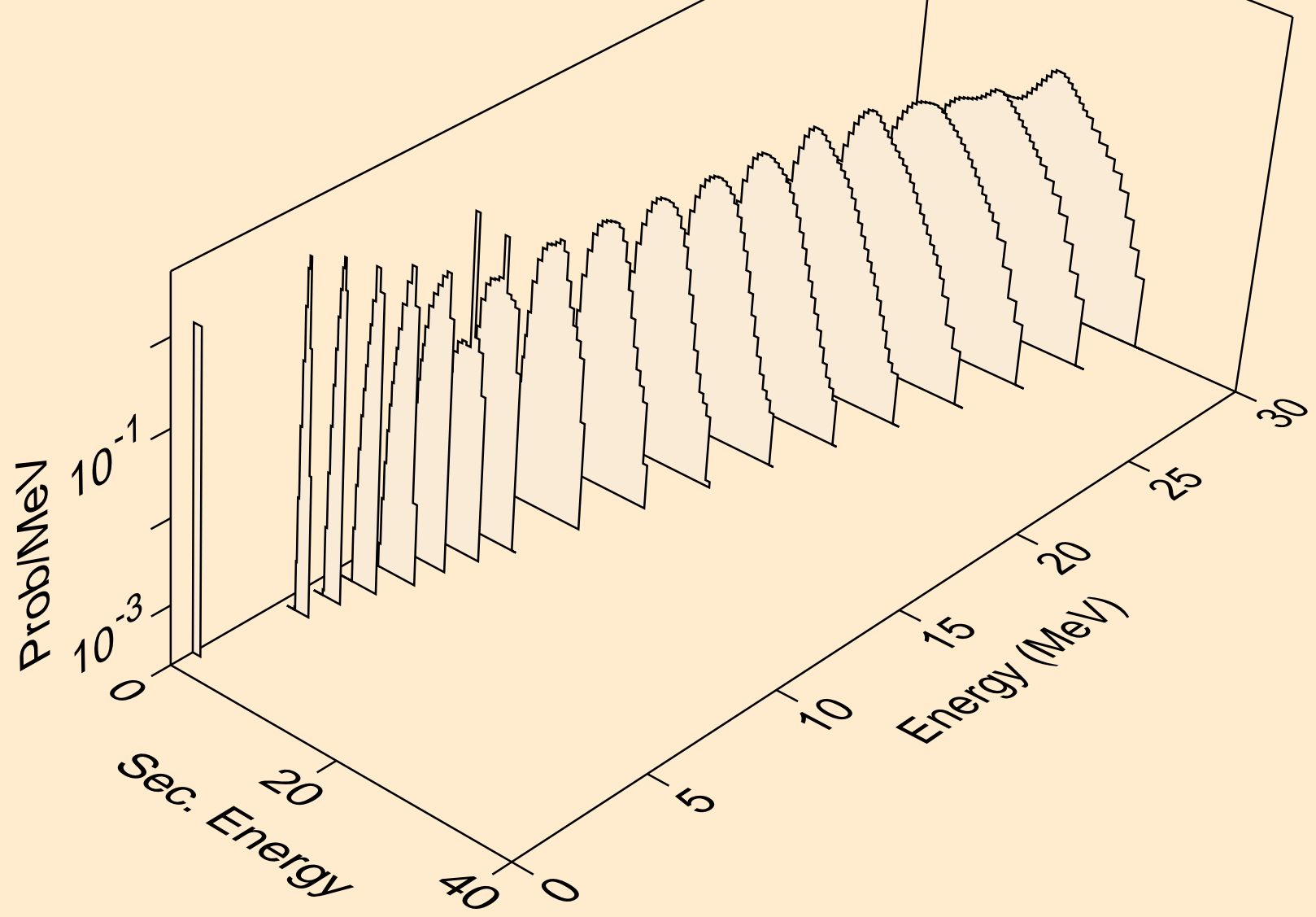

W172 TRITON ACER TENDL-2021 LIBRARY; T=0.K  
protons from (t,2np)

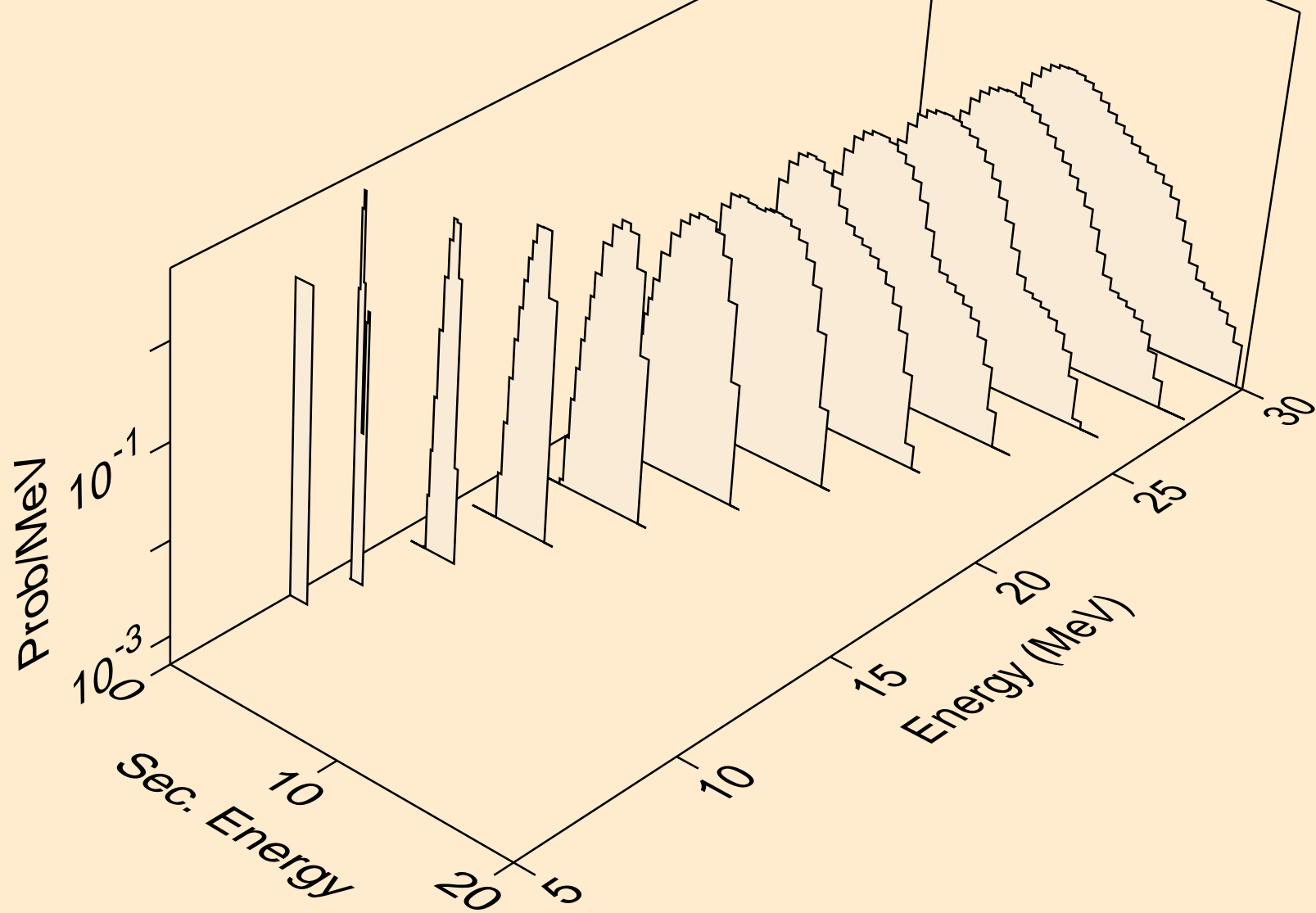

W172 TRITON ACER TENDL-2021 LIBRARY; T=0.K  
protons from (t,3np)

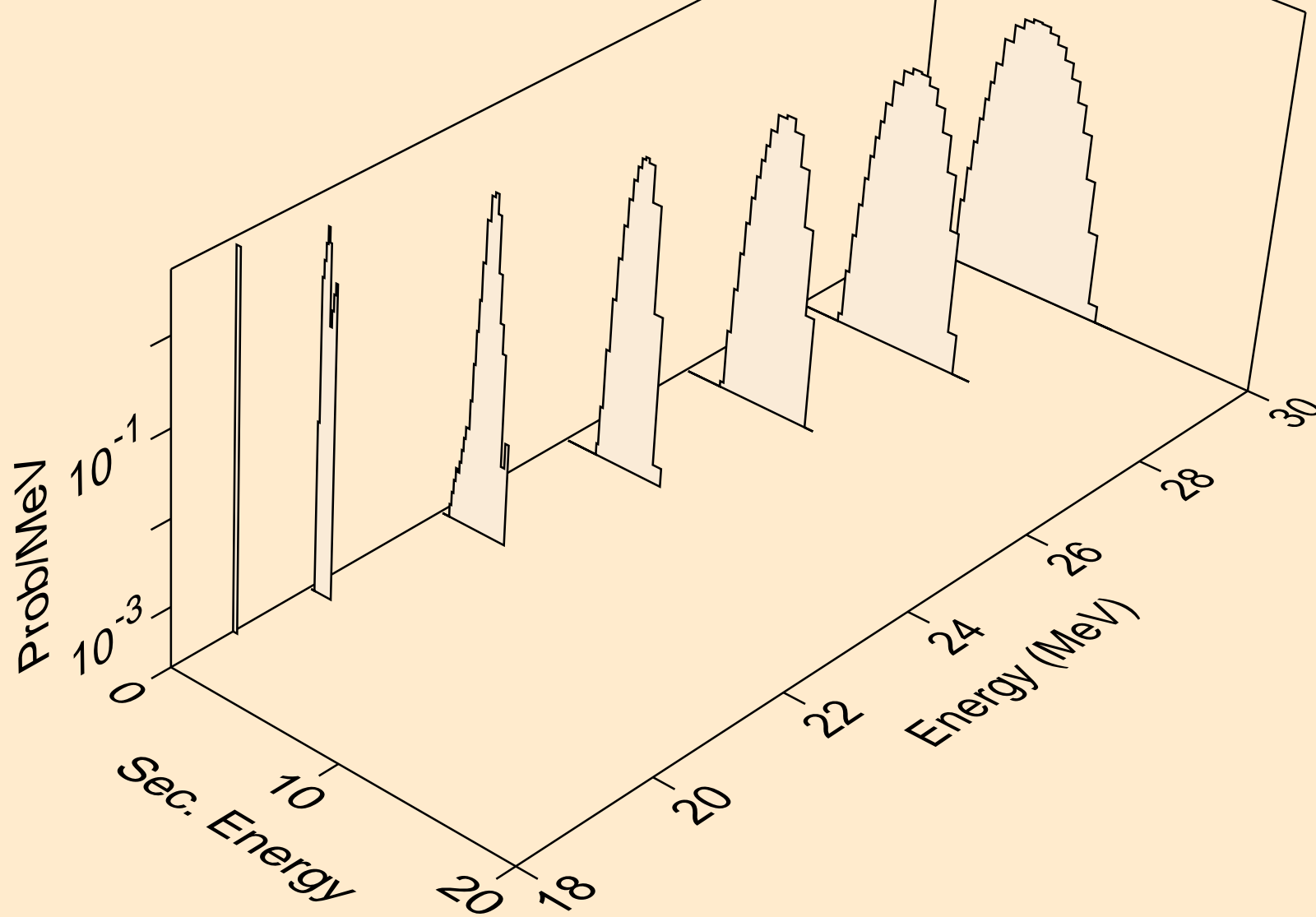

W172 TRITON ACER TENDL-2021 LIBRARY; T=0.K  
protons from (t,2np)

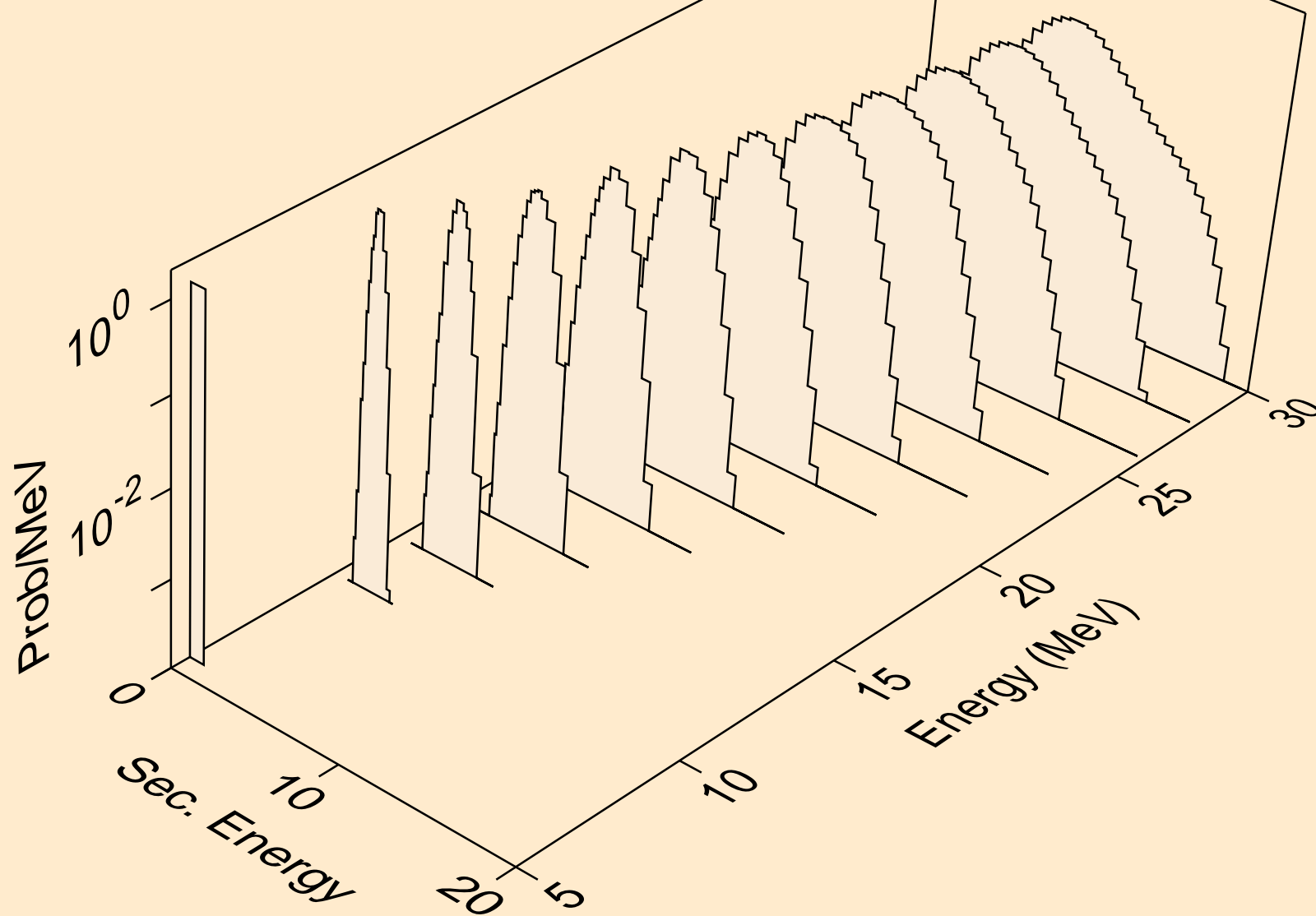

W172 TRITON ACER TENDL-2021 LIBRARY; T=0.K  
protons from (t,npa)

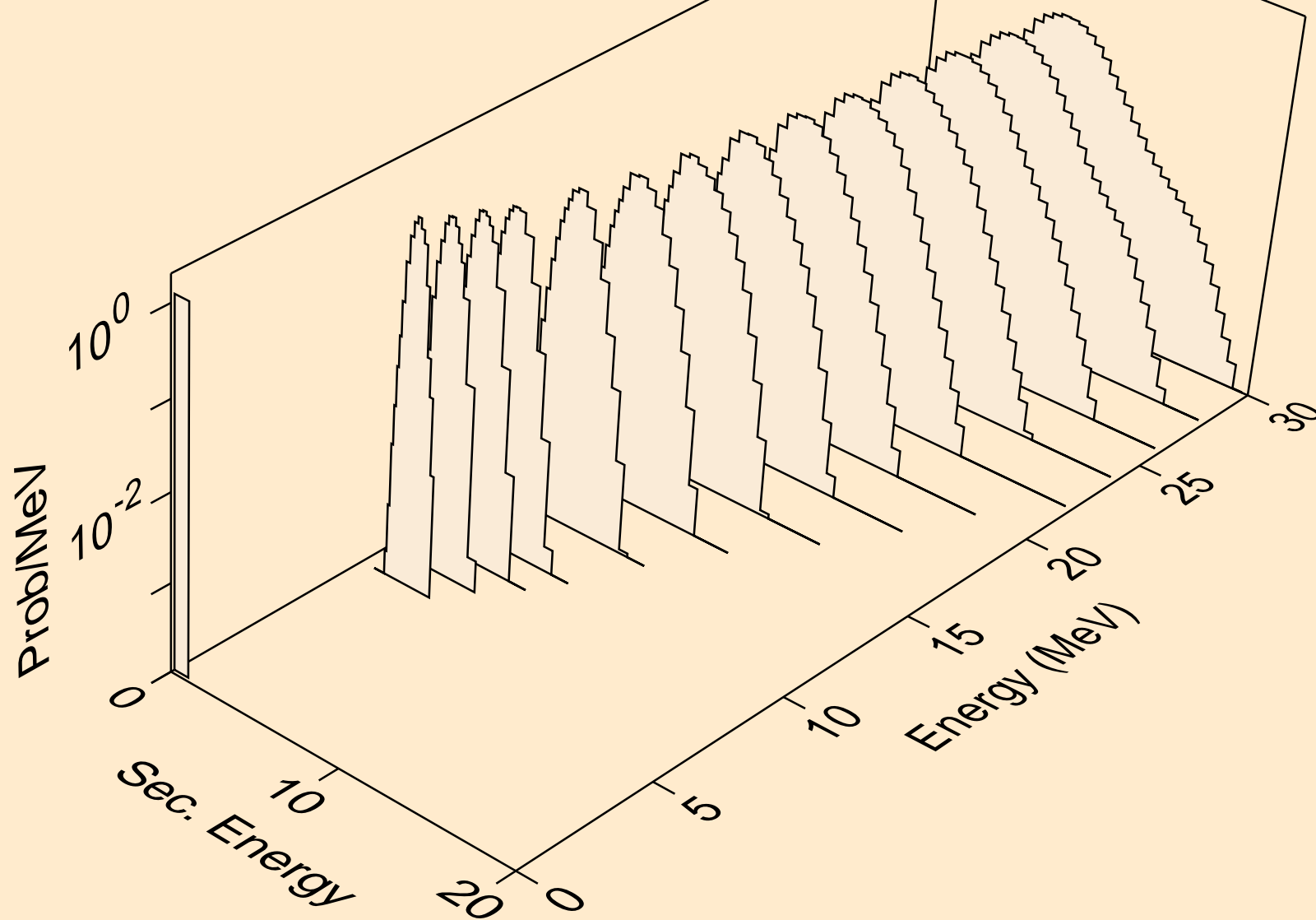



W172 TRITON ACER TENDL-2021 LIBRARY; T=0.K  
protons from (t,p)

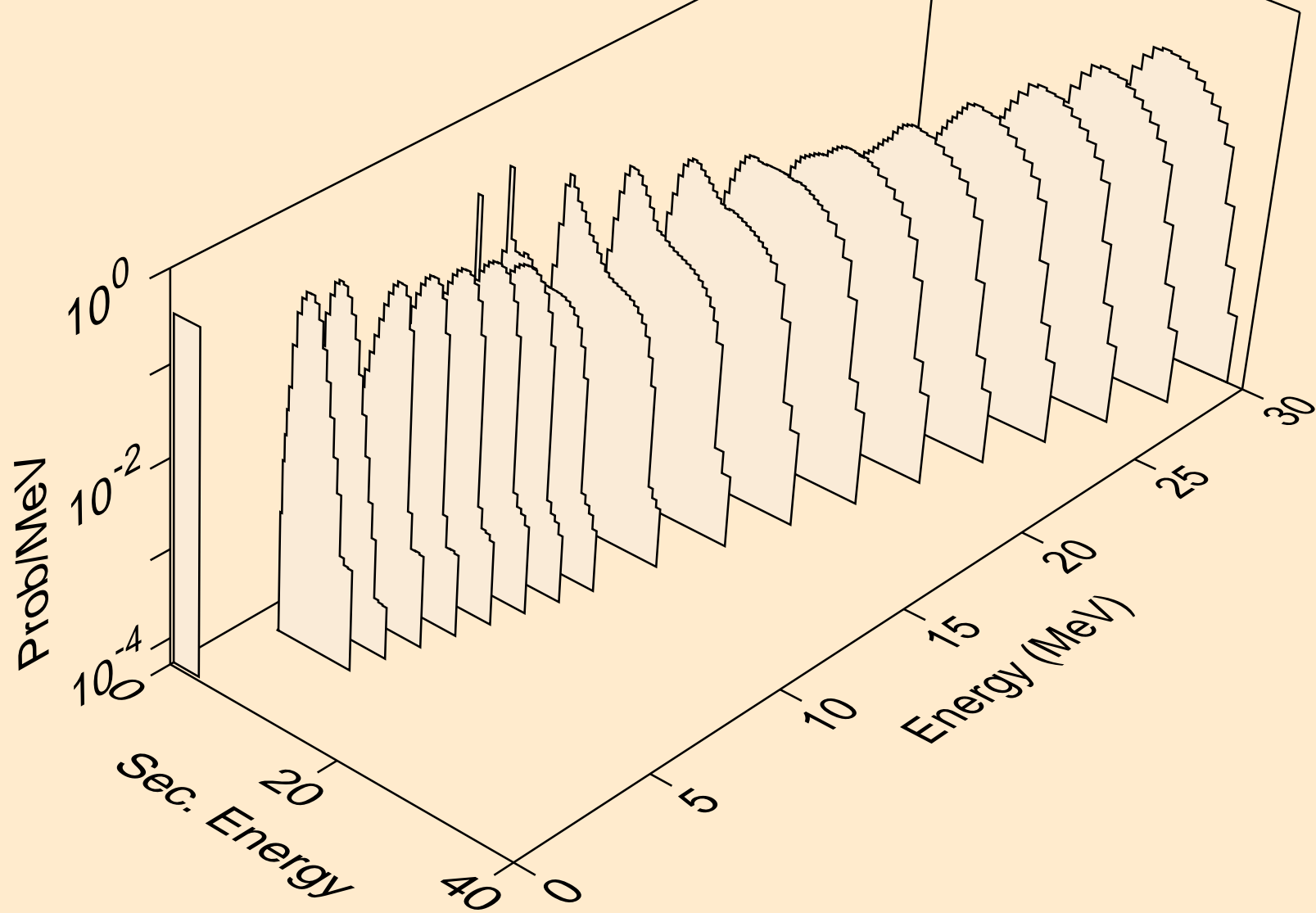

W172 TRITON ACER TENDL-2021 LIBRARY; T=0.K  
protons from (t,2p)

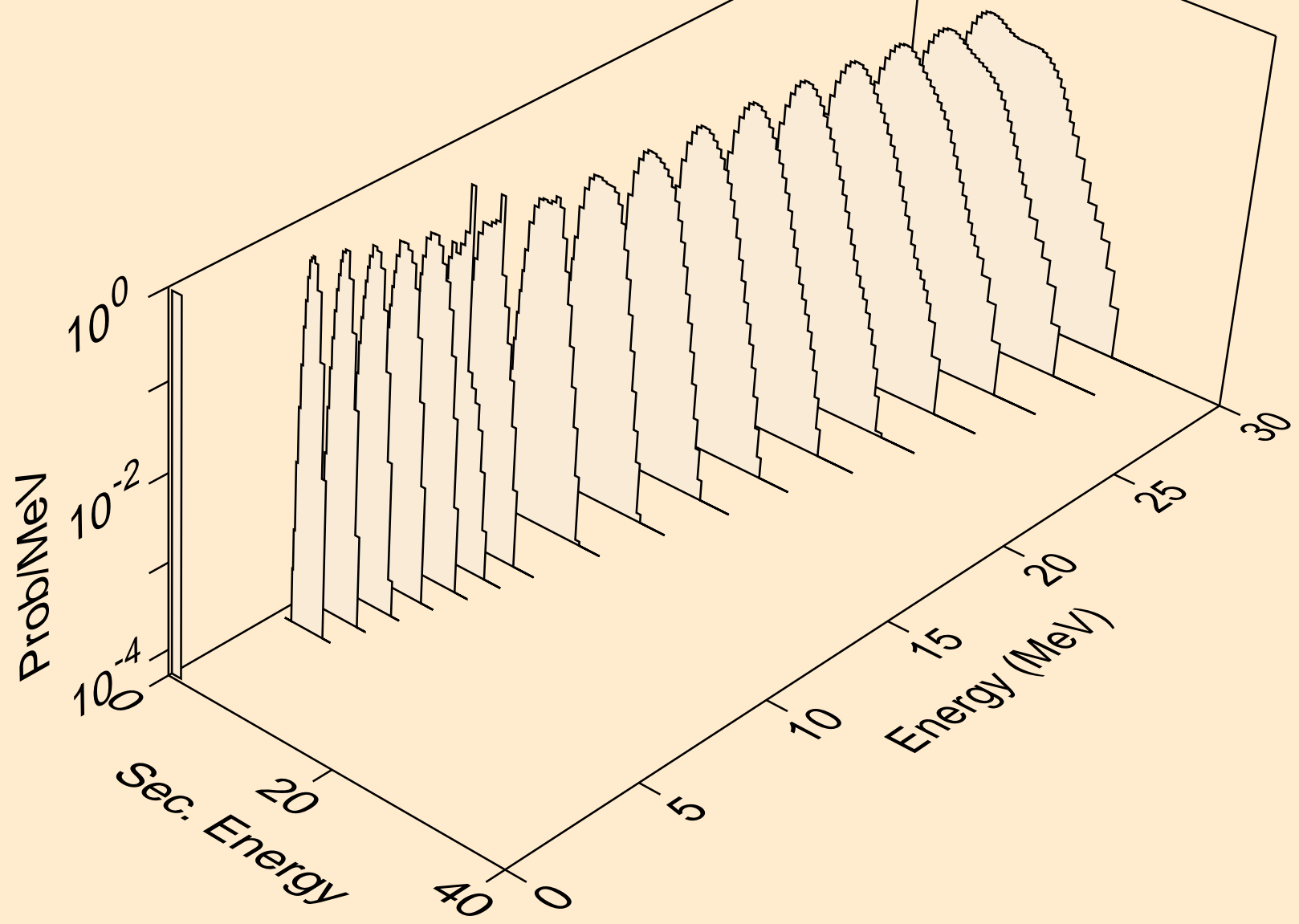

W172 TRITON ACER TENDL-2021 LIBRARY; T=0.K  
protons from (t,pa)

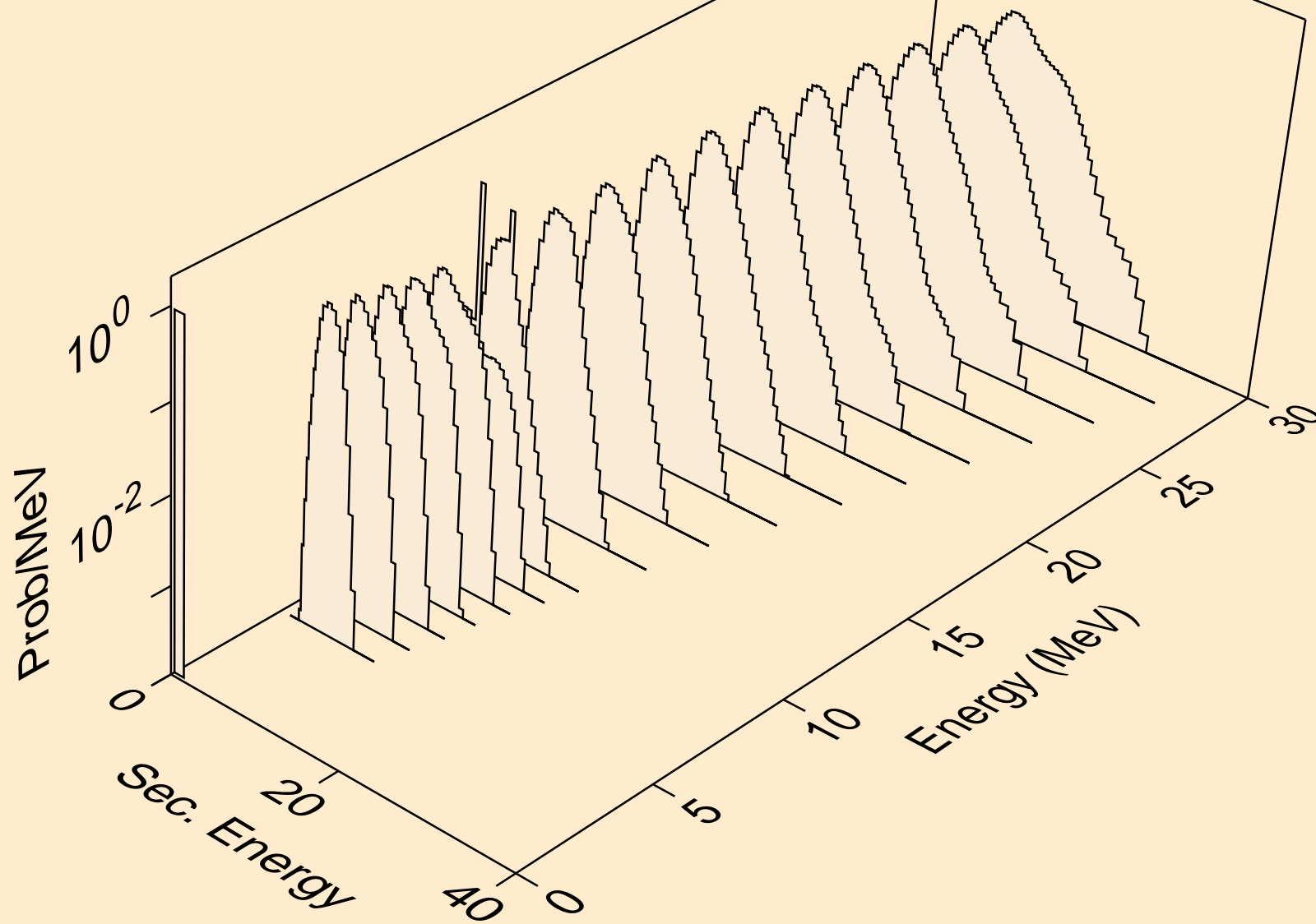

W172 TRITON ACER TENDL-2021 LIBRARY; T=0.K  
protons from (t,pd)

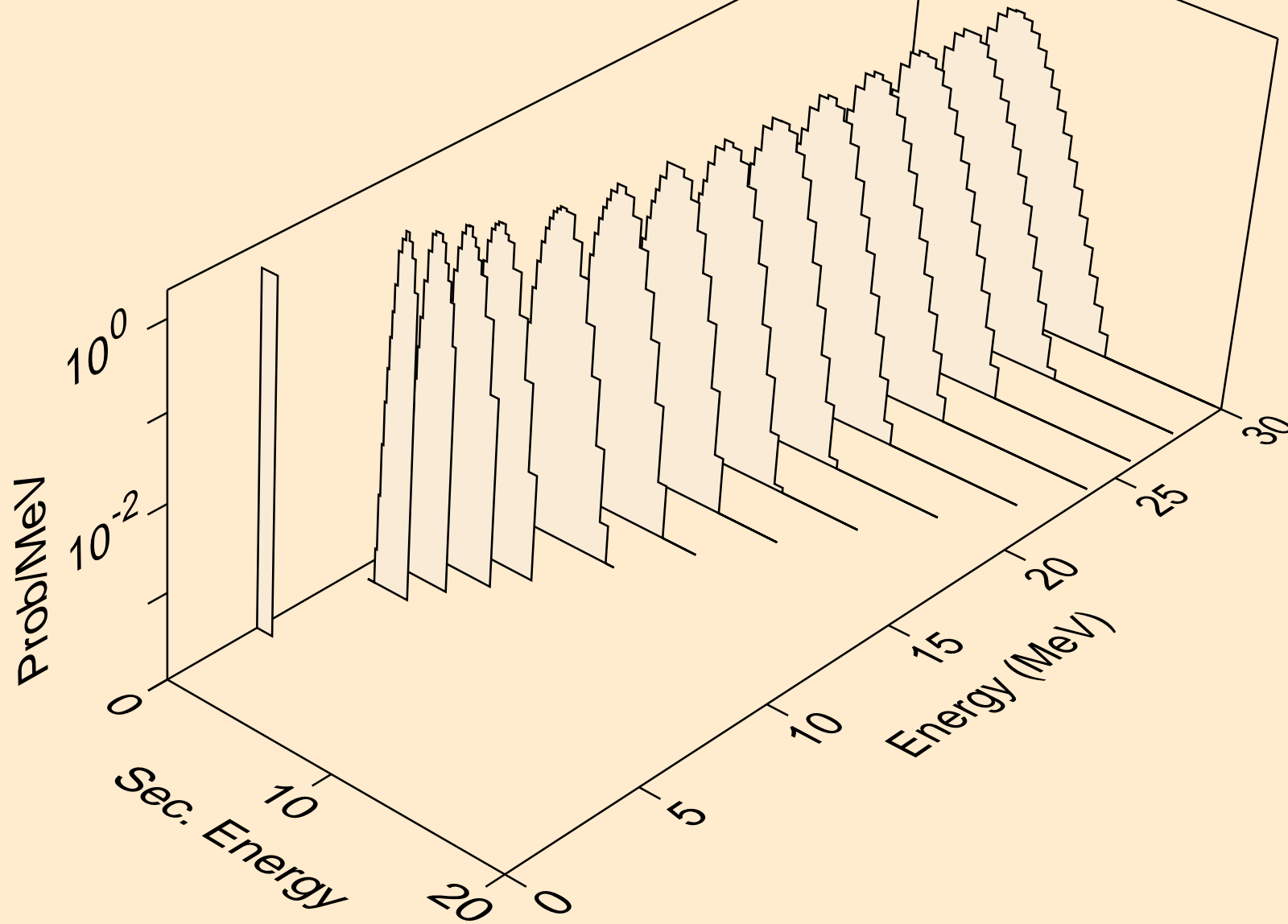

W172 TRITON ACER TENDL-2021 LIBRARY; T=0.K  
protons from (t,pt)

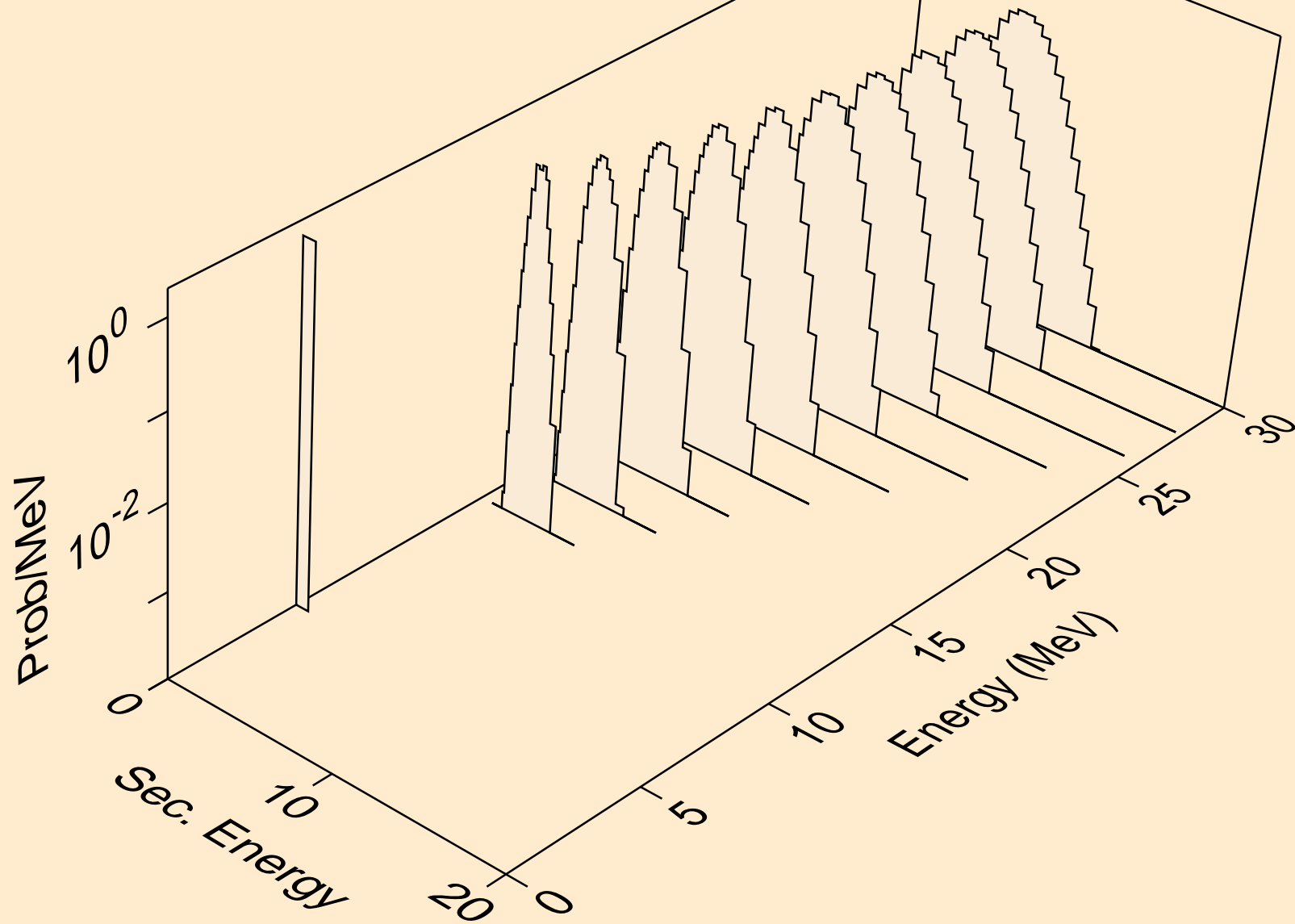

W172 TRITON ACER TENDL-2021 LIBRARY; T=0.K  
deuterons from (t,x)

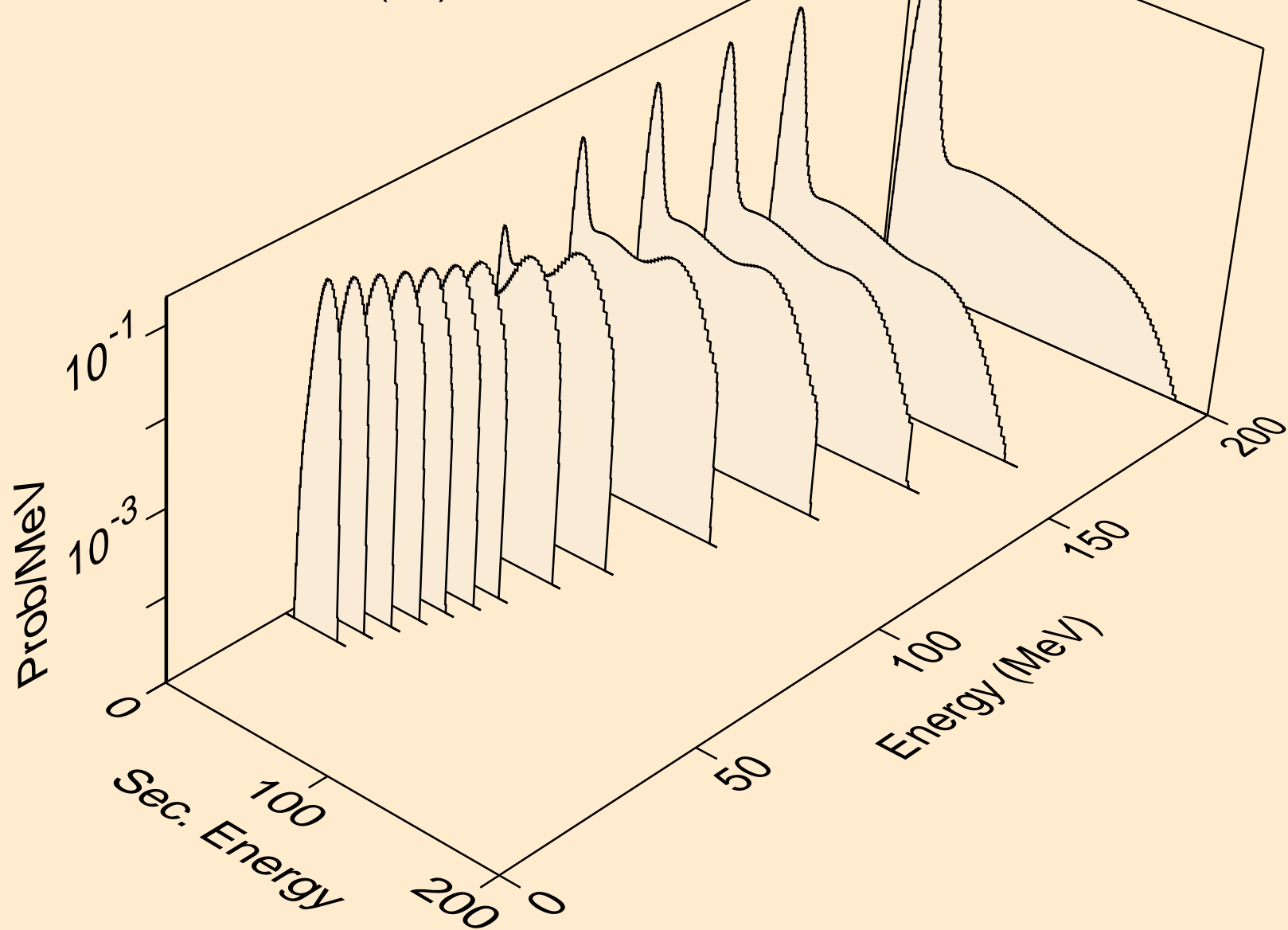

W172 TRITON ACER TENDL-2021 LIBRARY; T=0.K  
deuterons from (t,2nd)

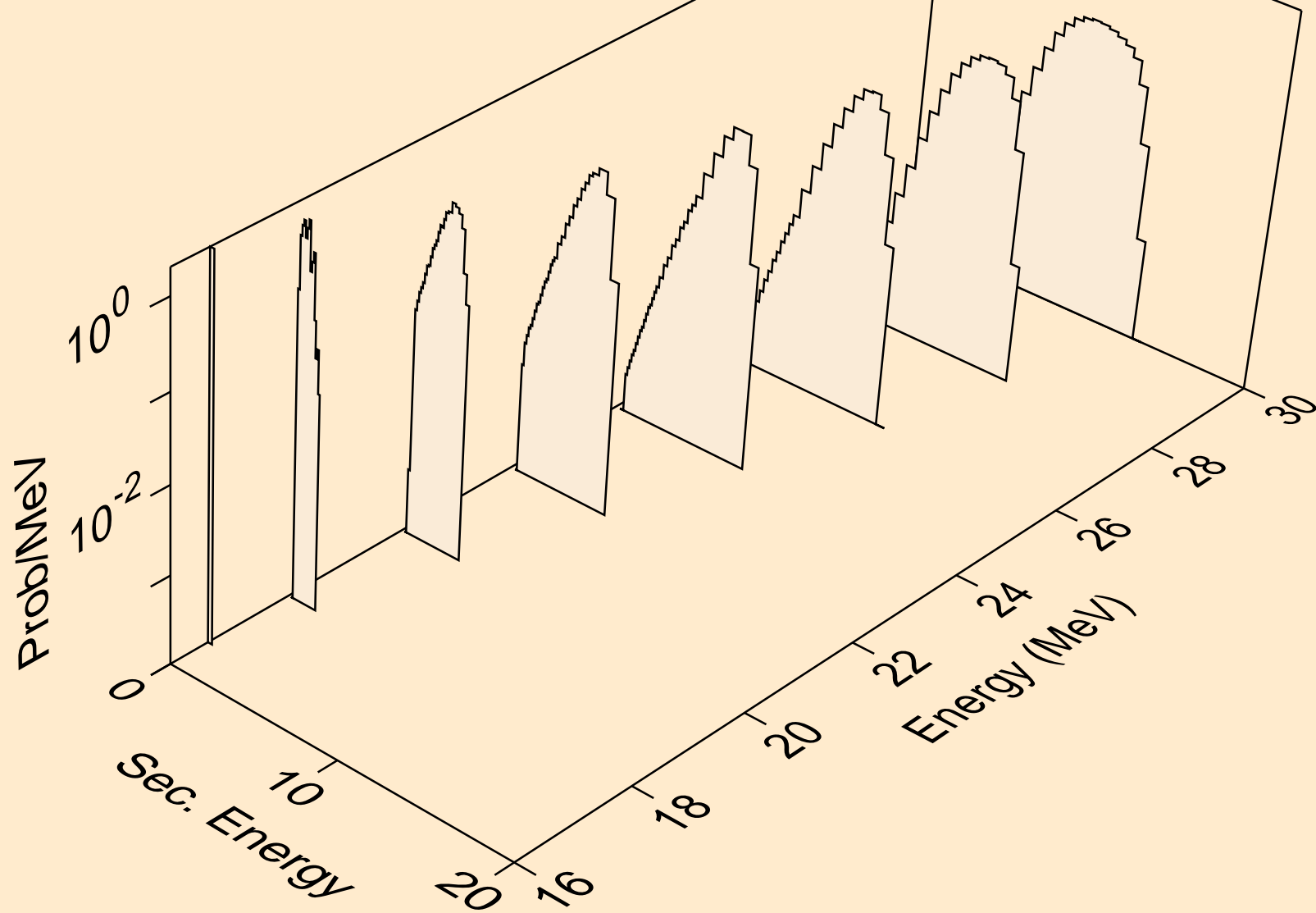

W172 TRITON ACER TENDL-2021 LIBRARY; T=0.K  
deuterons from (t,n\*)d

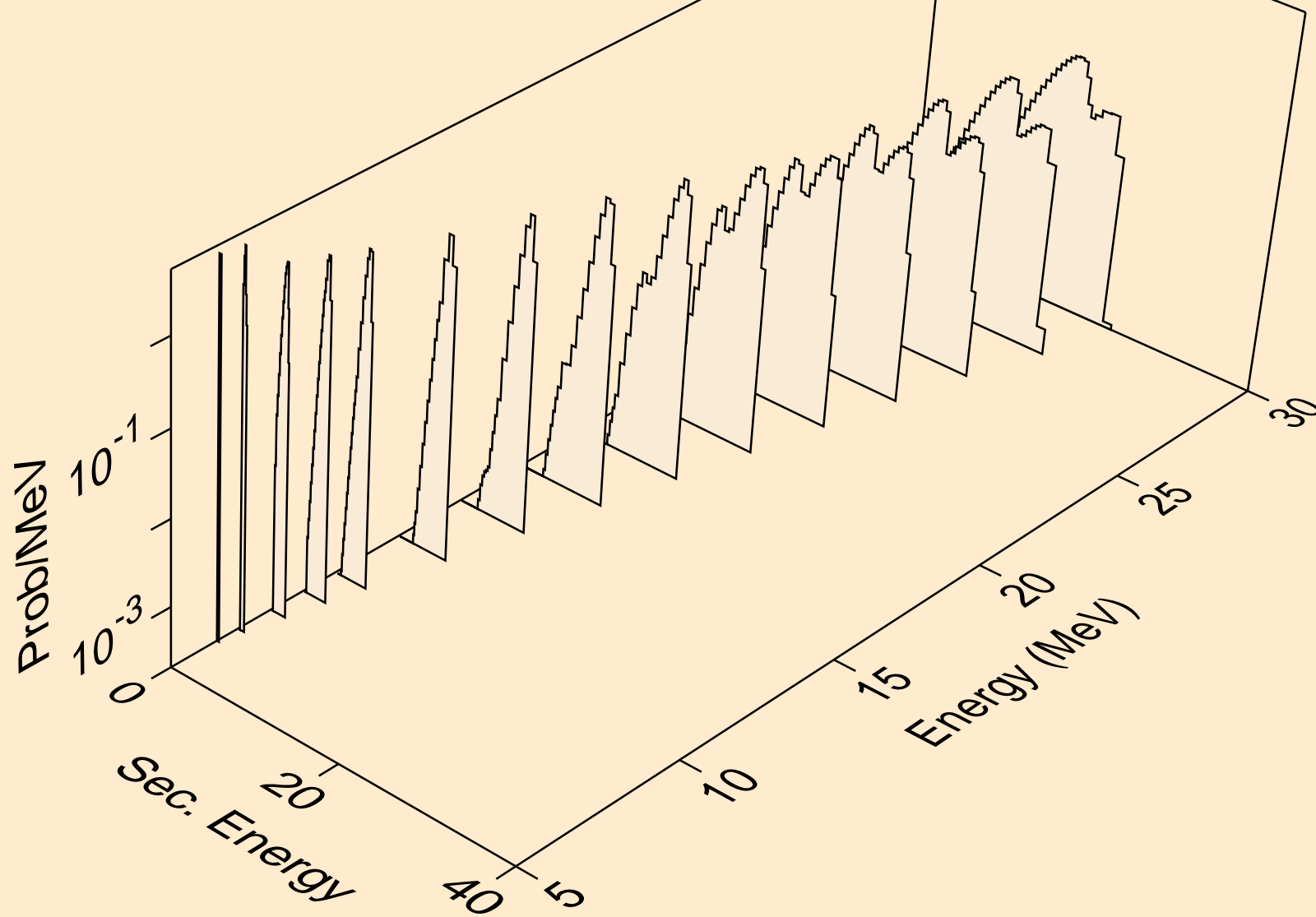



W172 TRITON ACER TENDL-2021 LIBRARY; T=0.K  
deuterons from (t,d)

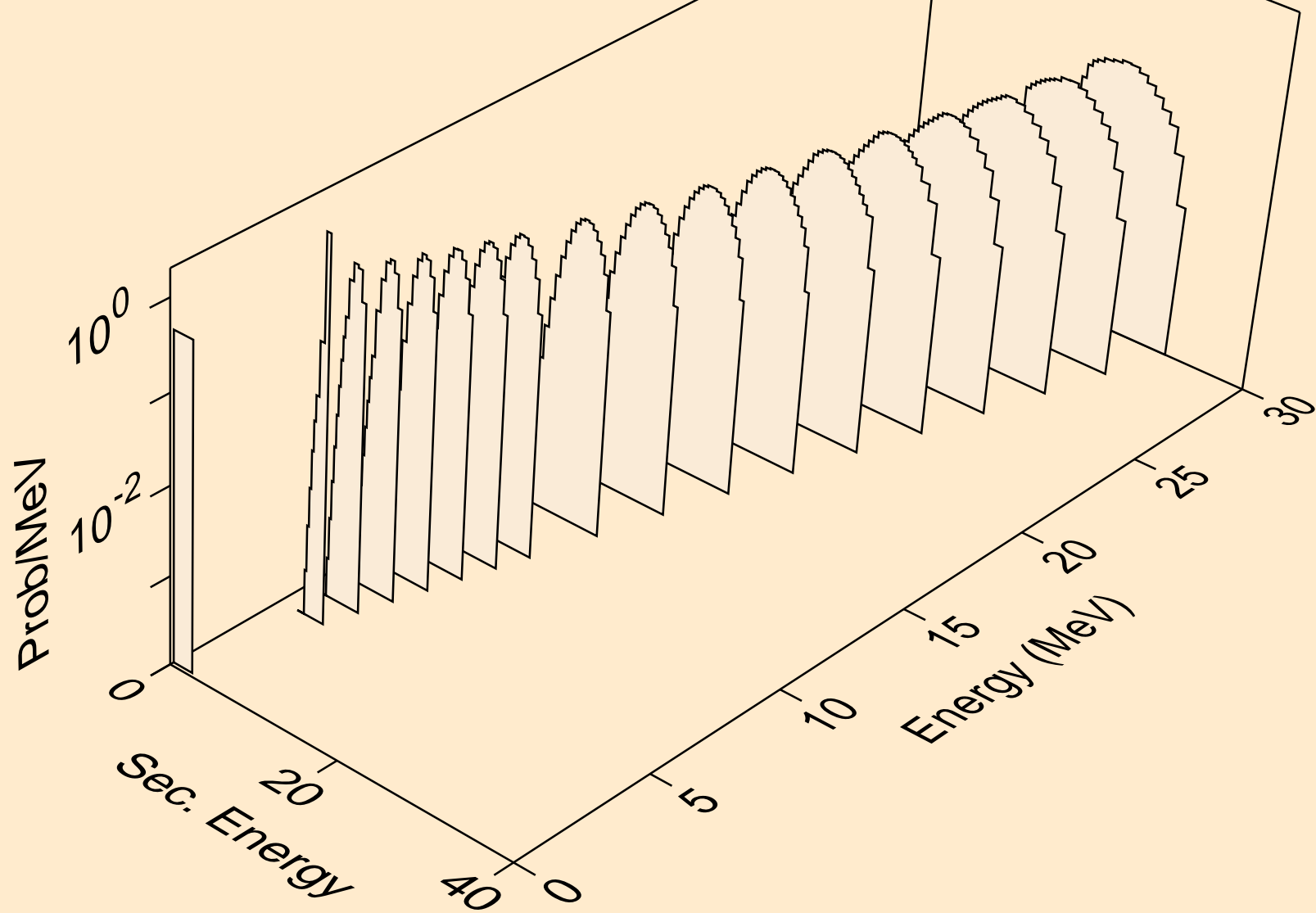

W172 TRITON ACER TENDL-2021 LIBRARY; T=0.K  
deuterons from (t,pd)

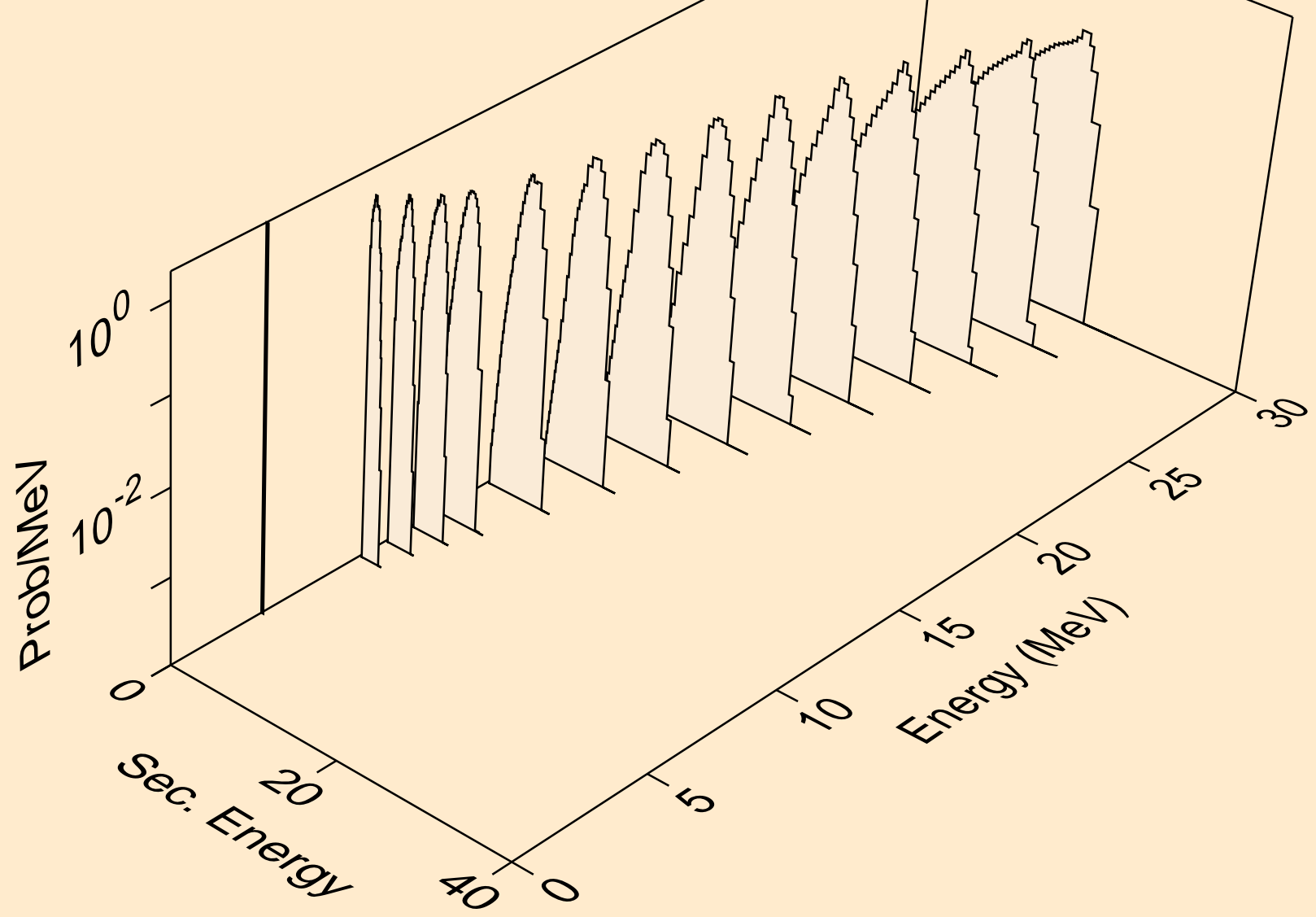

W172 TRITON ACER TENDL-2021 LIBRARY; T=0.K  
deuterons from (t,da)

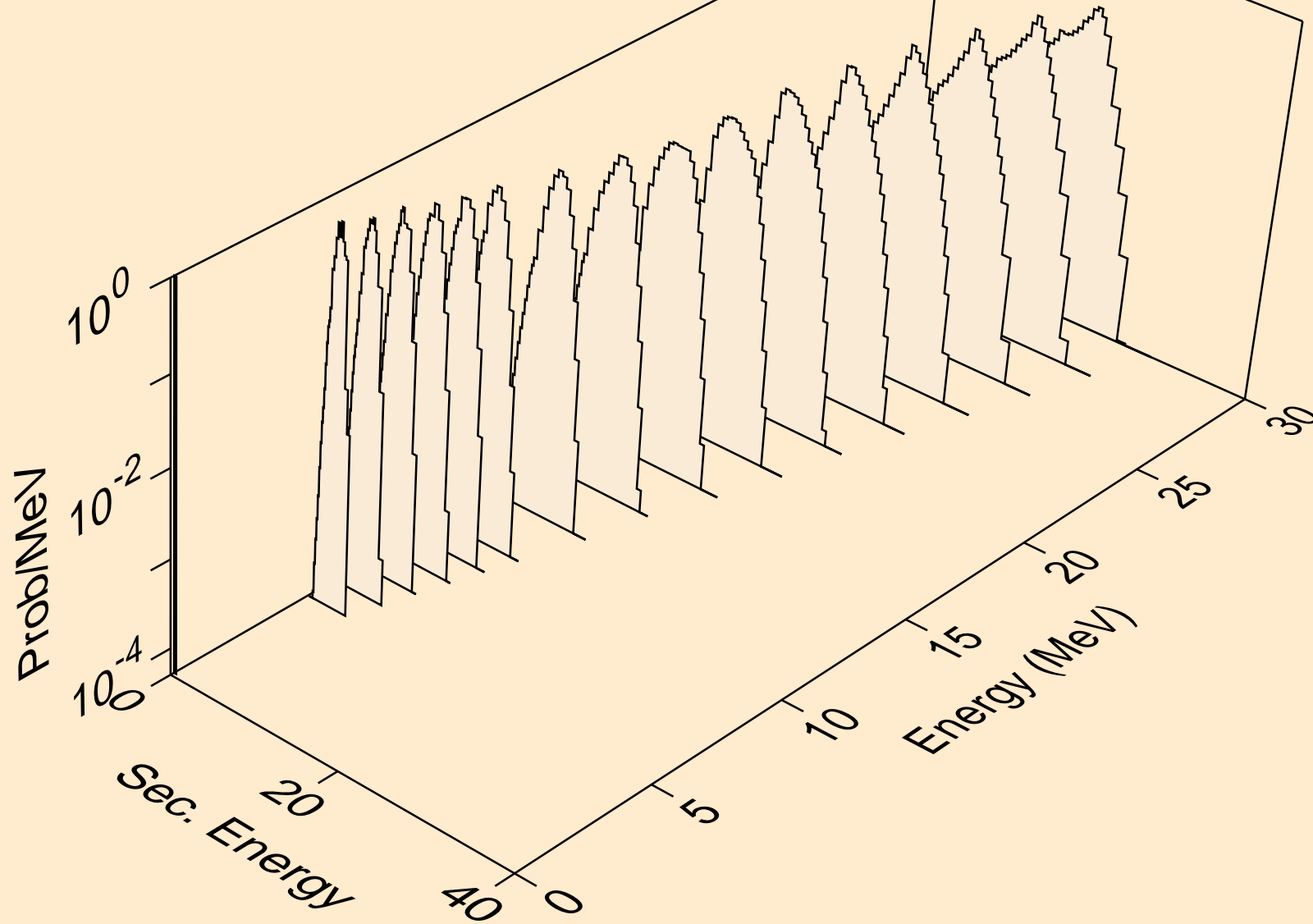

W172 TRITON ACER TENDL-2021 LIBRARY; T=0.K  
he3s from (t,x)

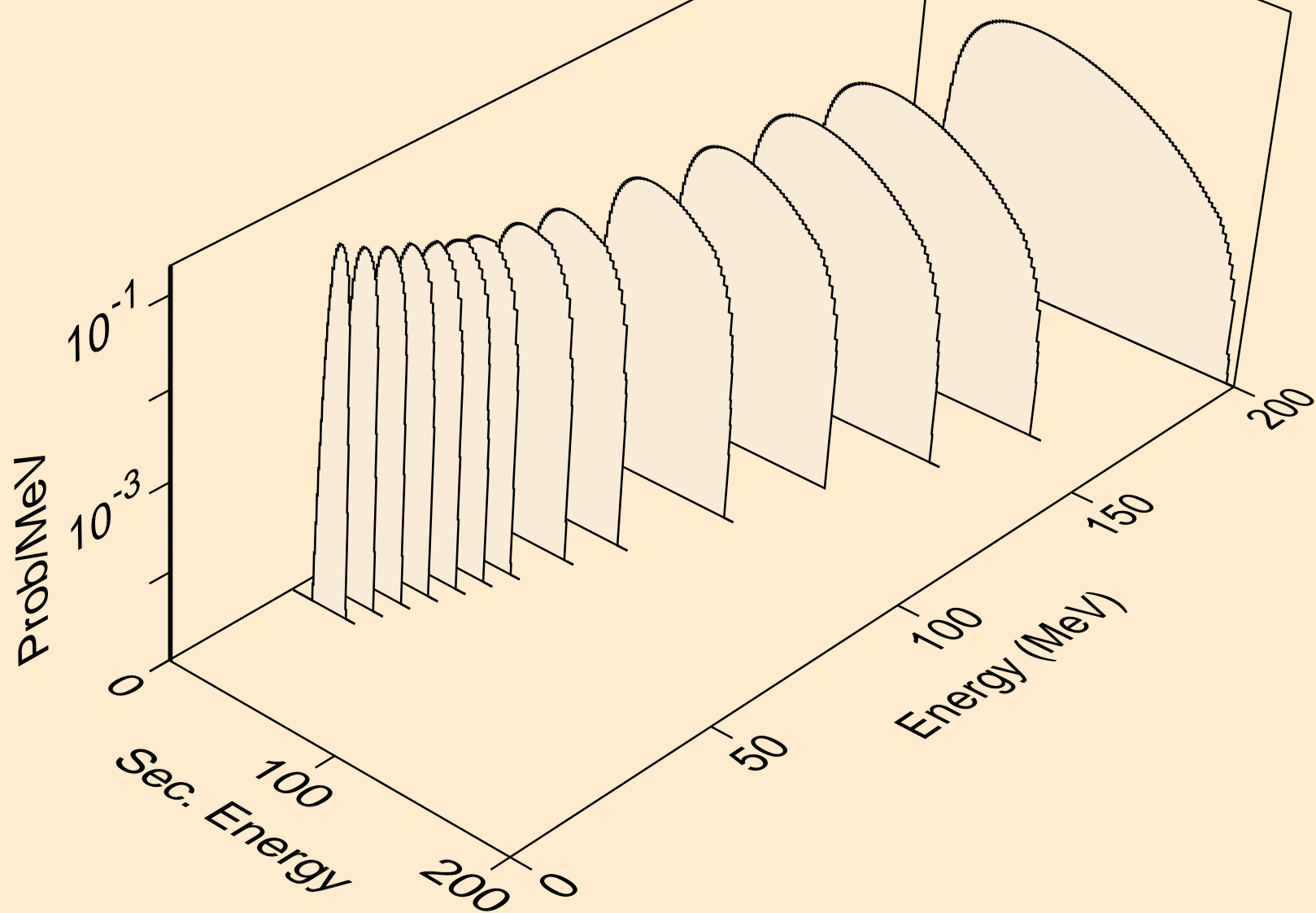

W172 TRITON ACER TENDL-2021 LIBRARY; T=0.K  
he3s from (t,n\*)he3

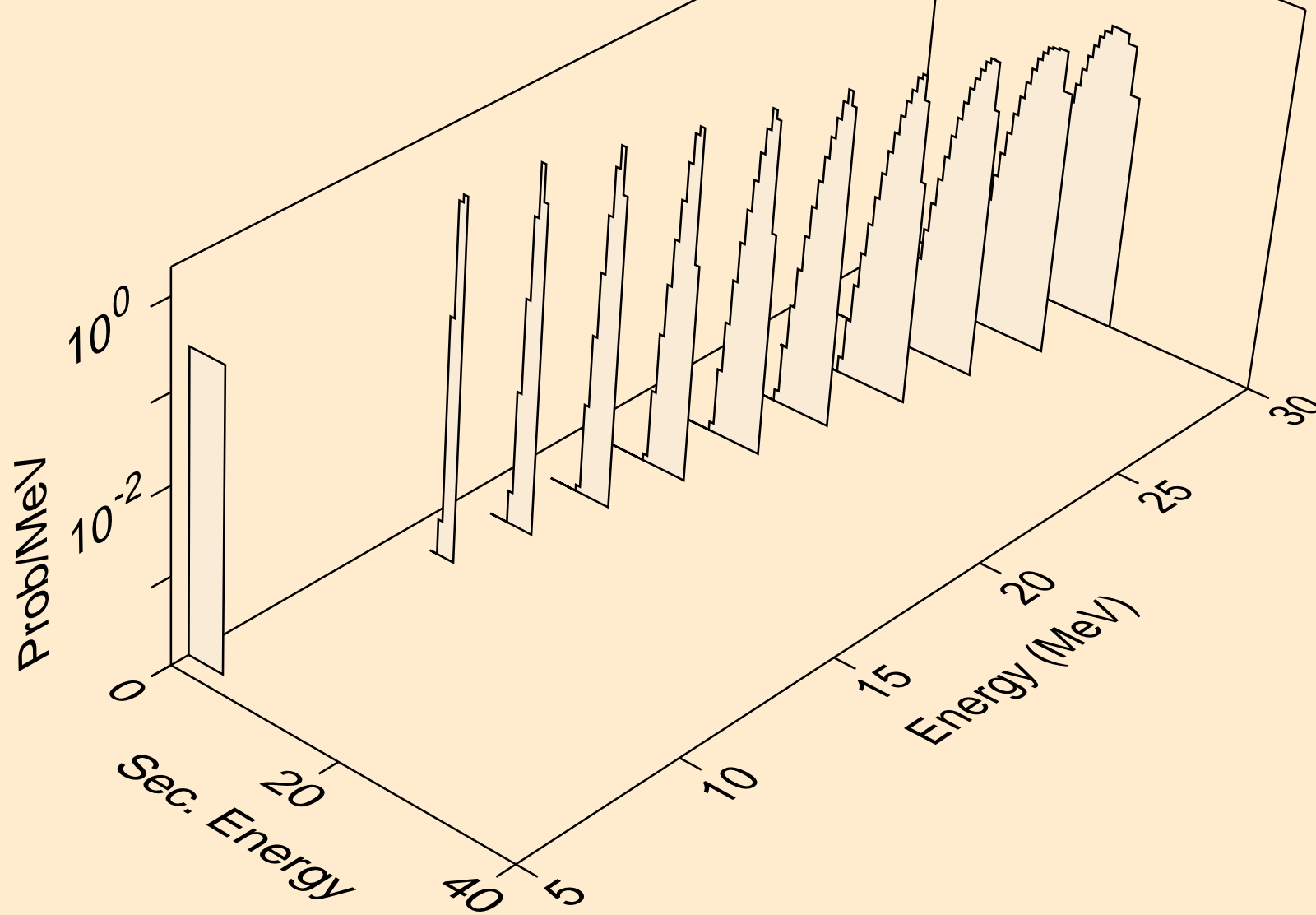

W172 TRITON ACER TENDL-2021 LIBRARY; T=0.K  
he3s from (t,he3)

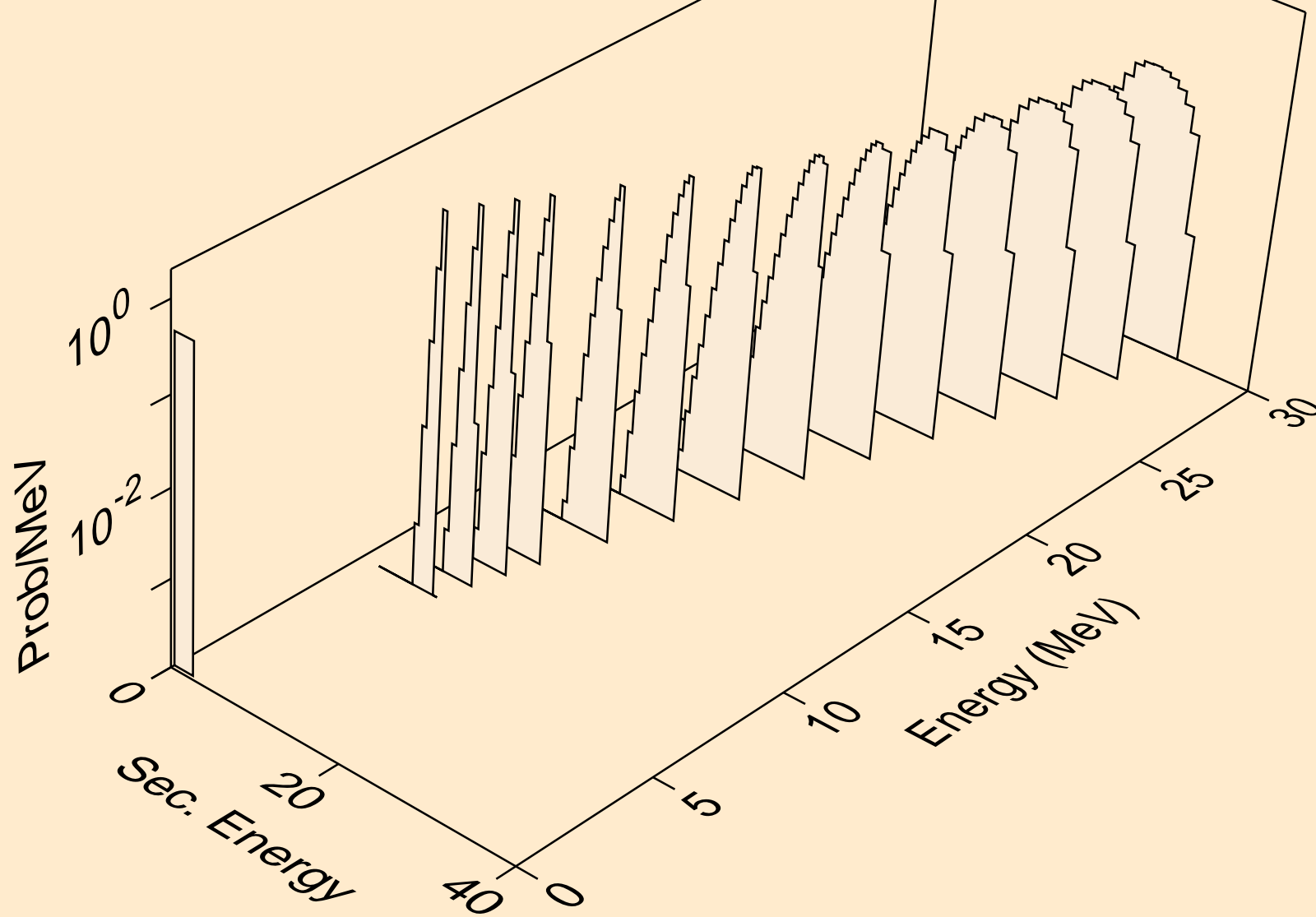

W172 TRITON ACER TENDL-2021 LIBRARY; T=0.K  
alphas from (t,x)

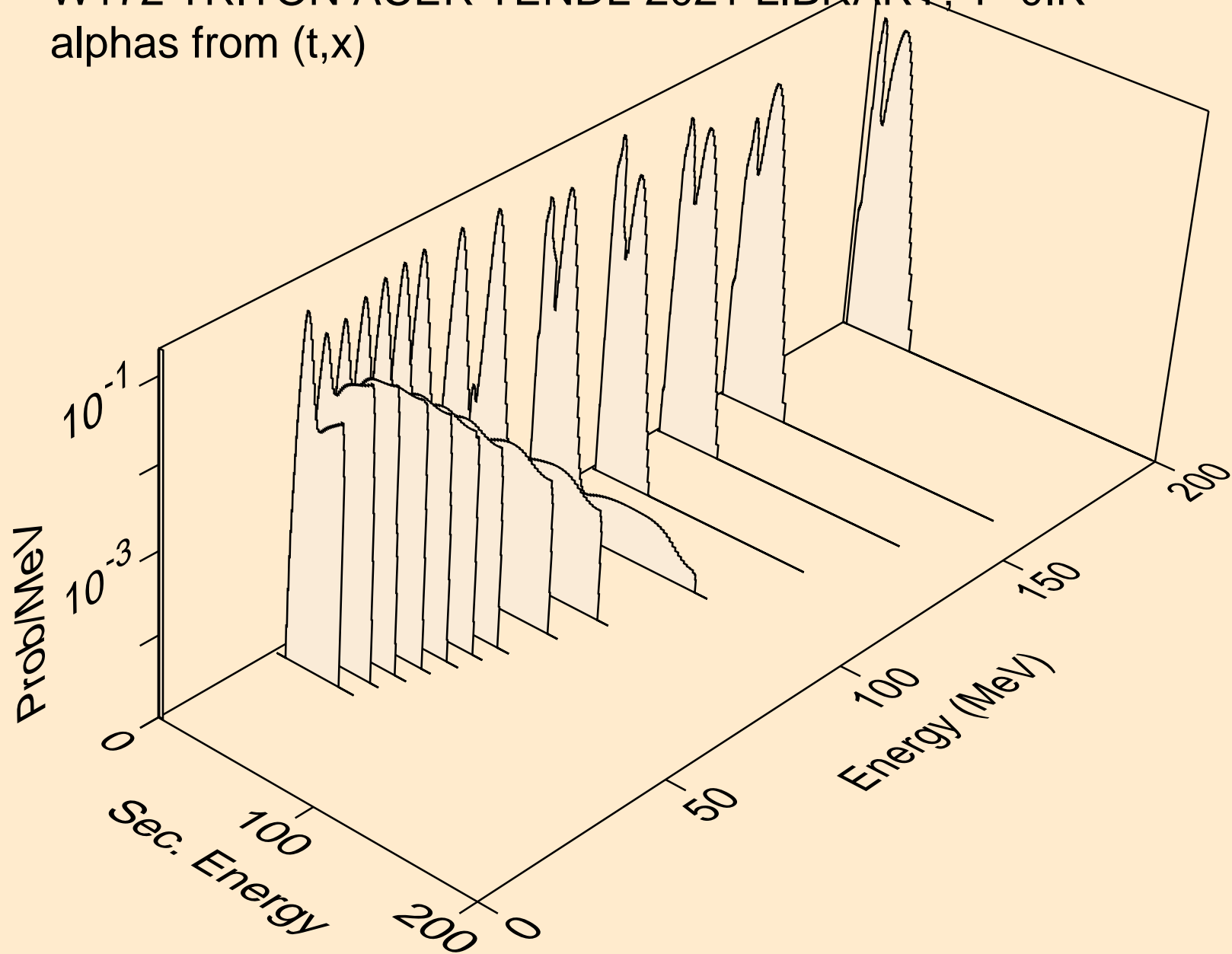

W172 TRITON ACER TENDL-2021 LIBRARY; T=0.K  
alphas from (t,n\*)a

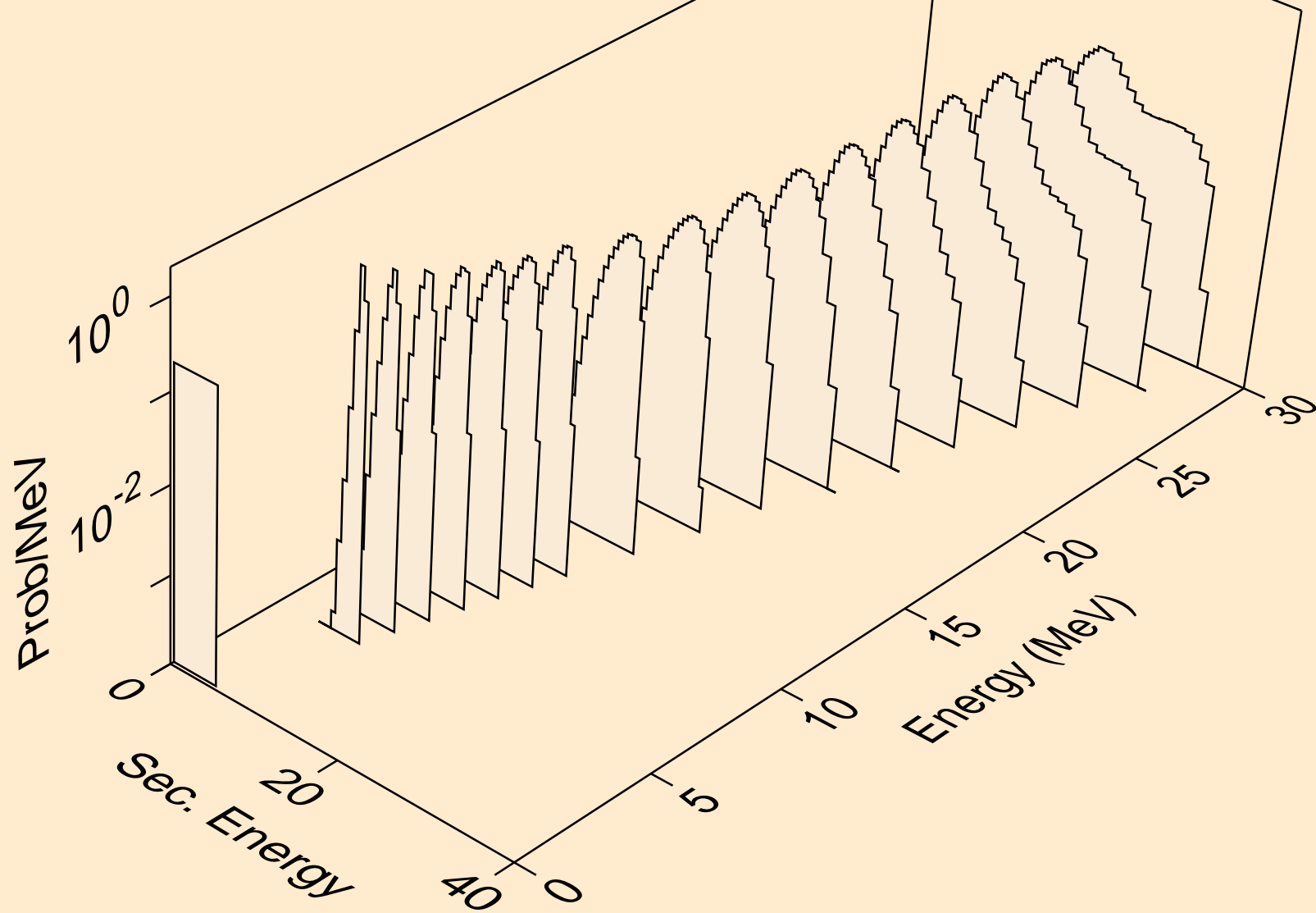



W172 TRITON ACER TENDL-2021 LIBRARY; T=0.K  
alphas from (t,2n)a

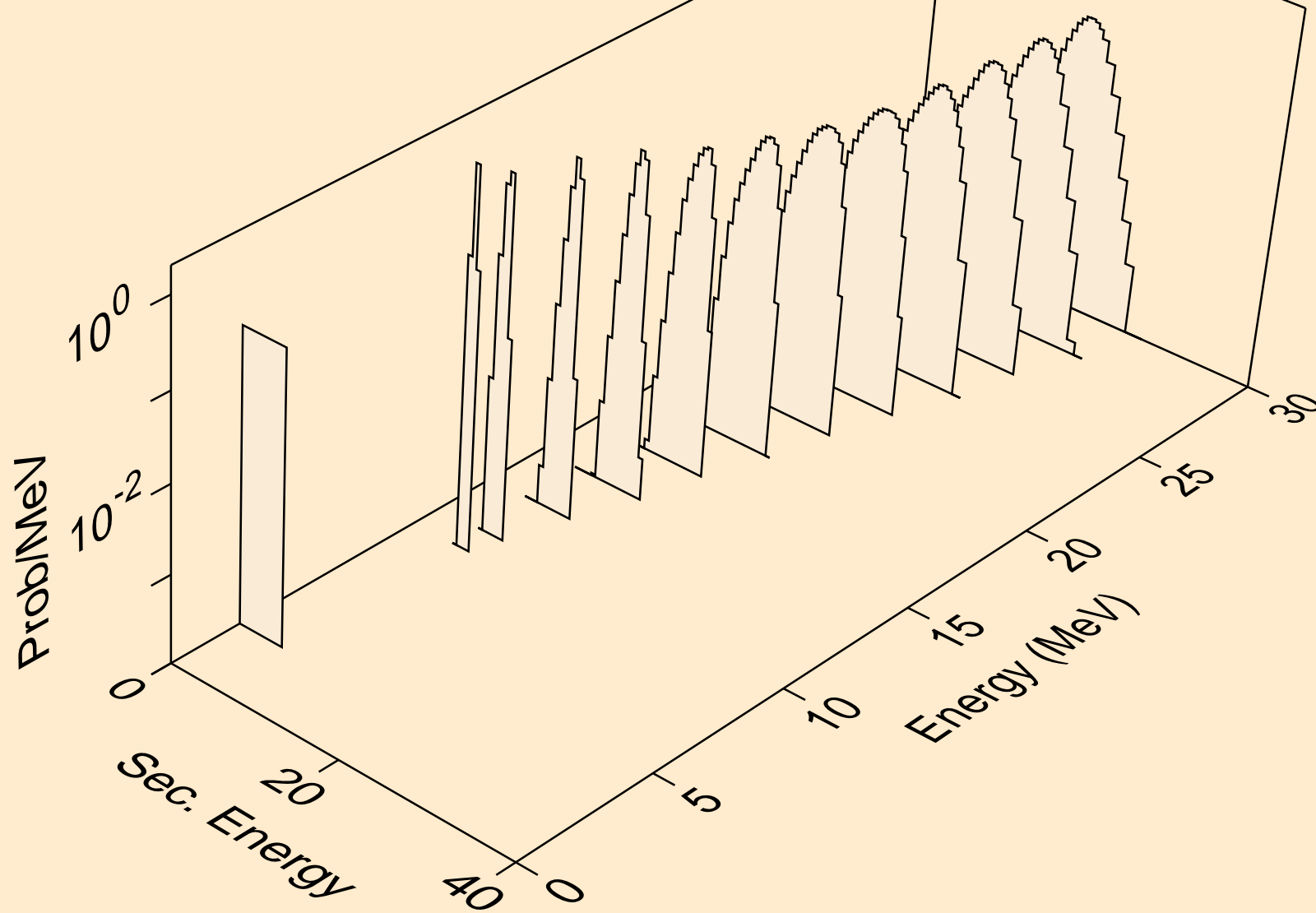

W172 TRITON ACER TENDL-2021 LIBRARY; T=0.K  
alphas from (t,3n)a

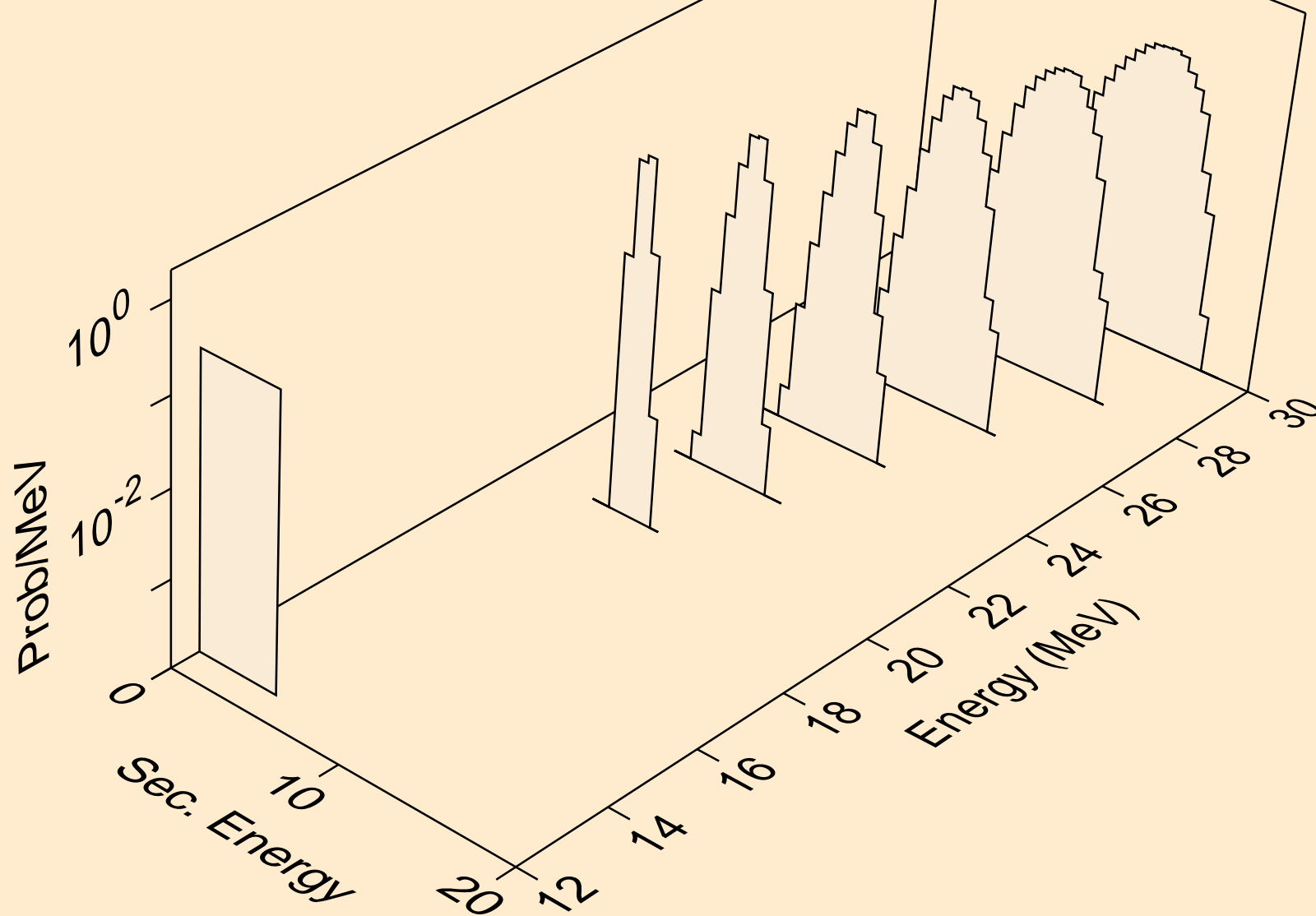

W172 TRITON ACER TENDL-2021 LIBRARY; T=0.K  
alphas from (t,n\*)2a

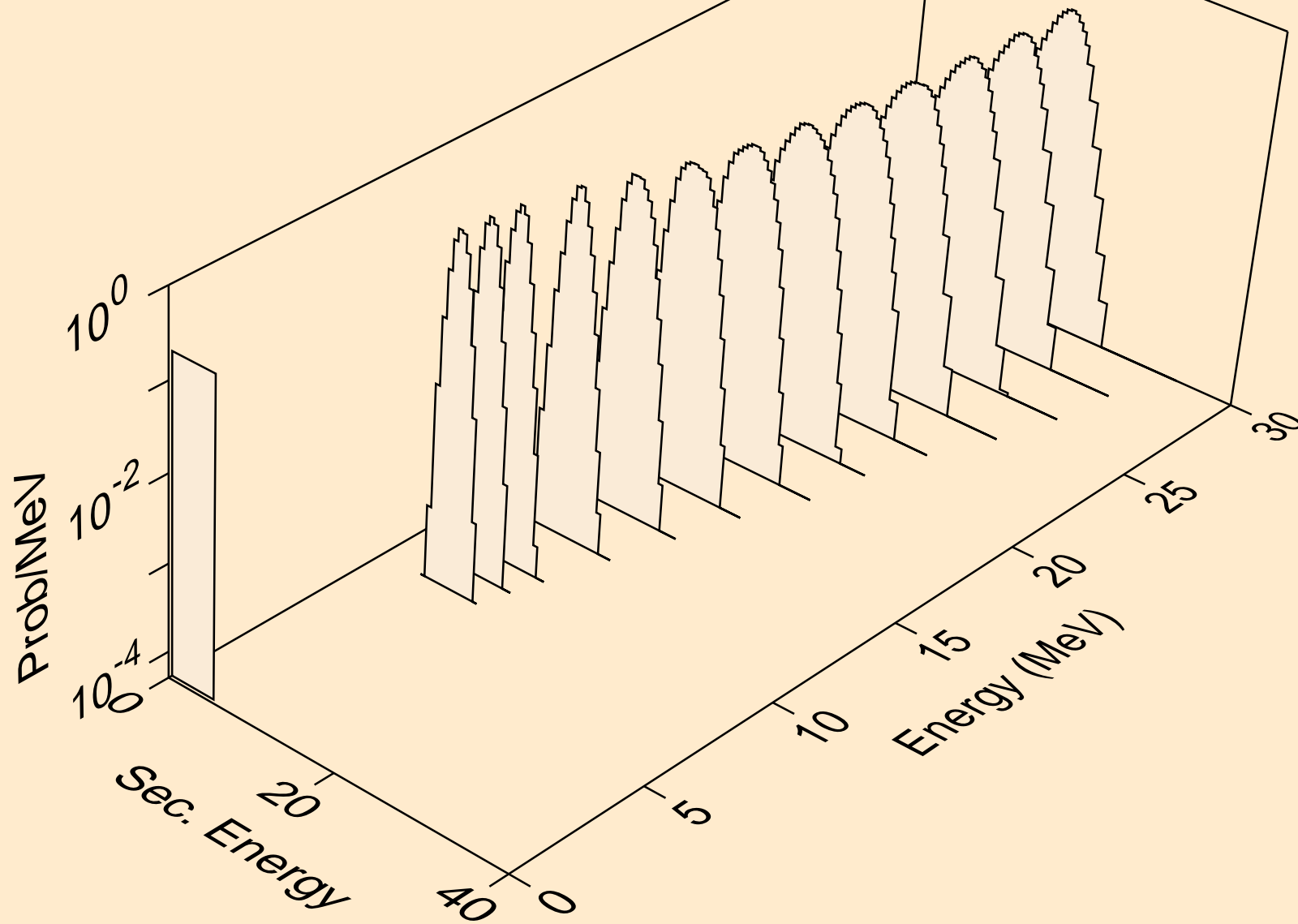

W172 TRITON ACER TENDL-2021 LIBRARY; T=0.K  
alphas from (t,2n)2a

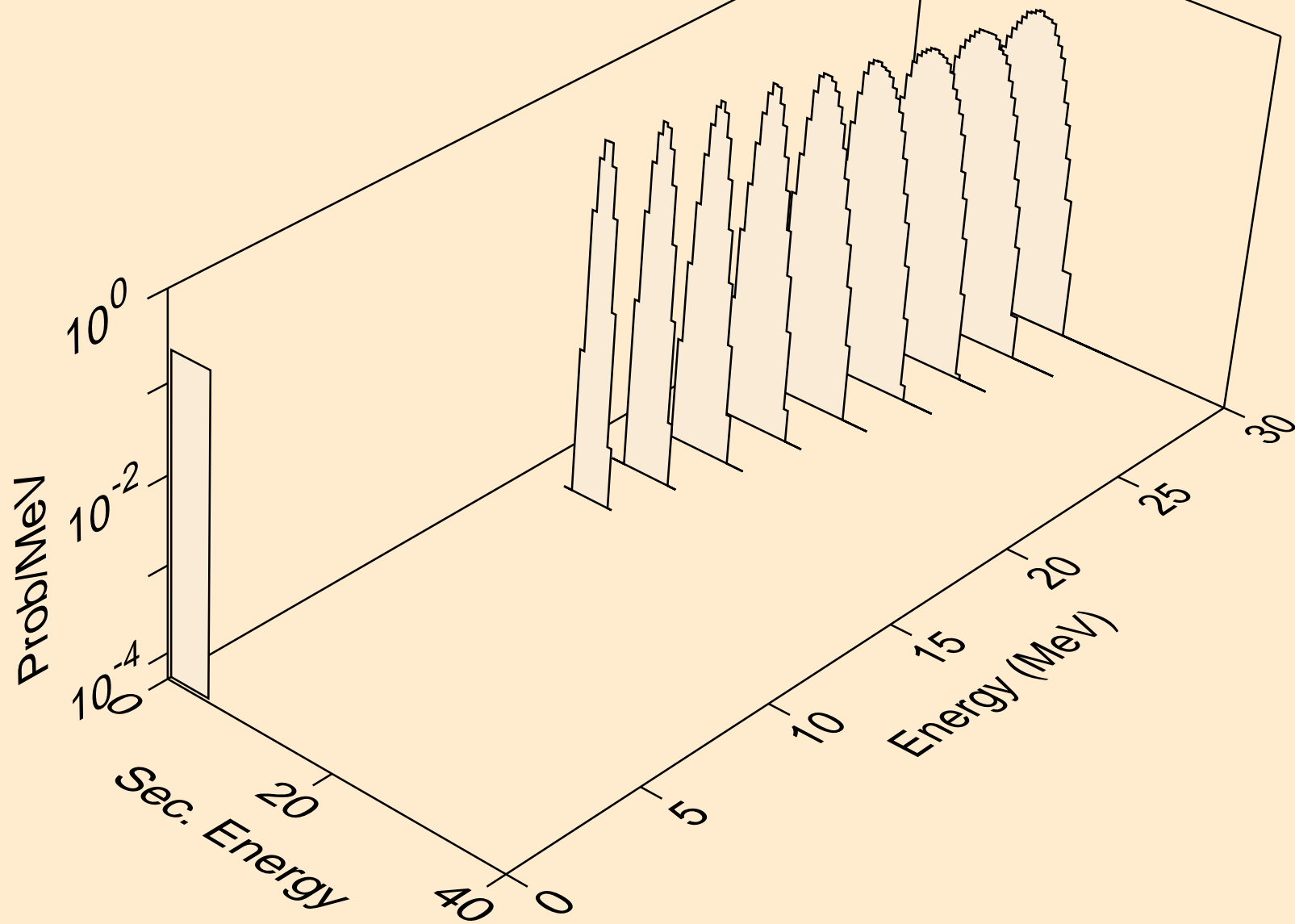

W172 TRITON ACER TENDL-2021 LIBRARY; T=0.K  
alphas from (t,npa)

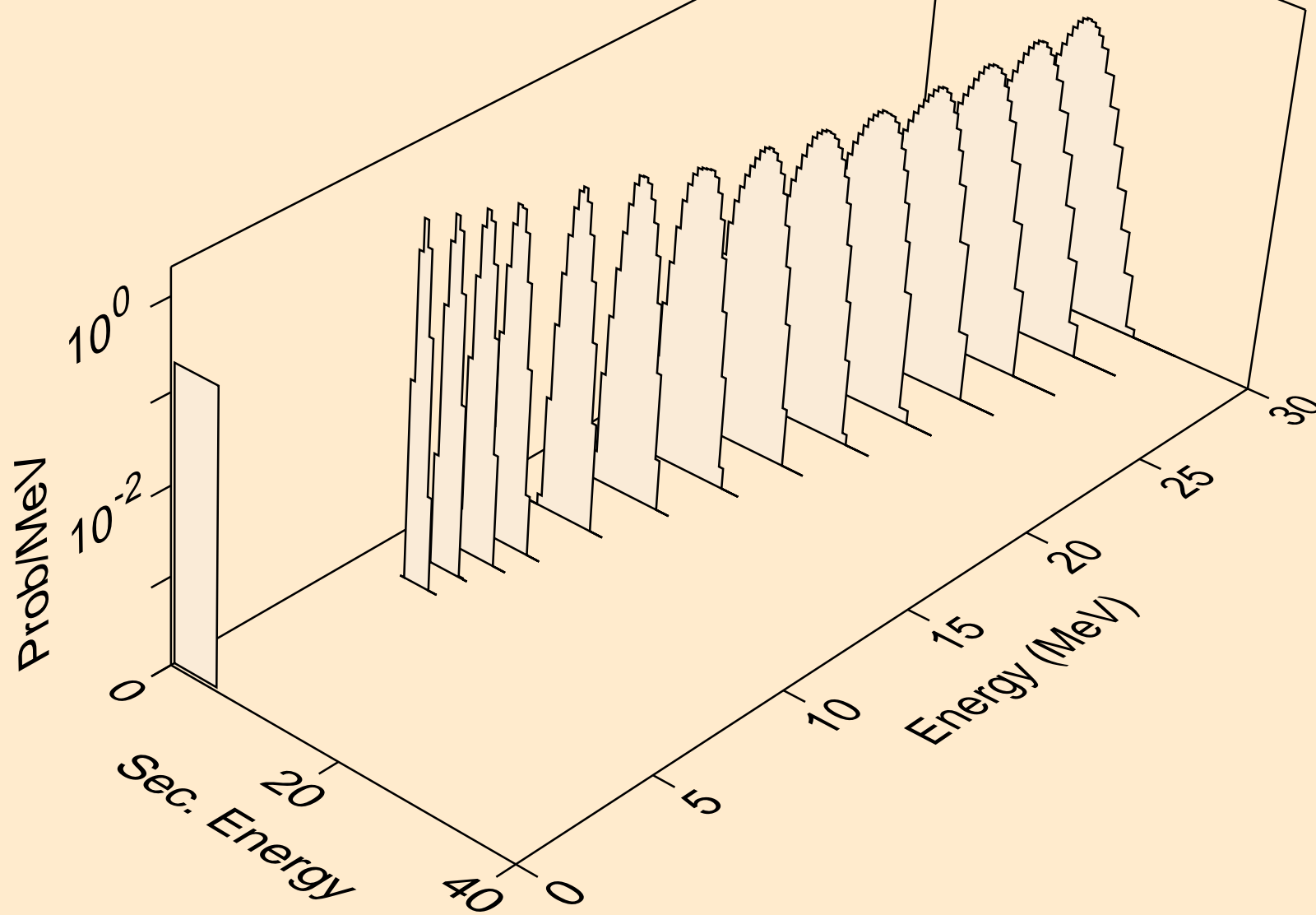

W172 TRITON ACER TENDL-2021 LIBRARY; T=0.K  
alphas from (t,a)

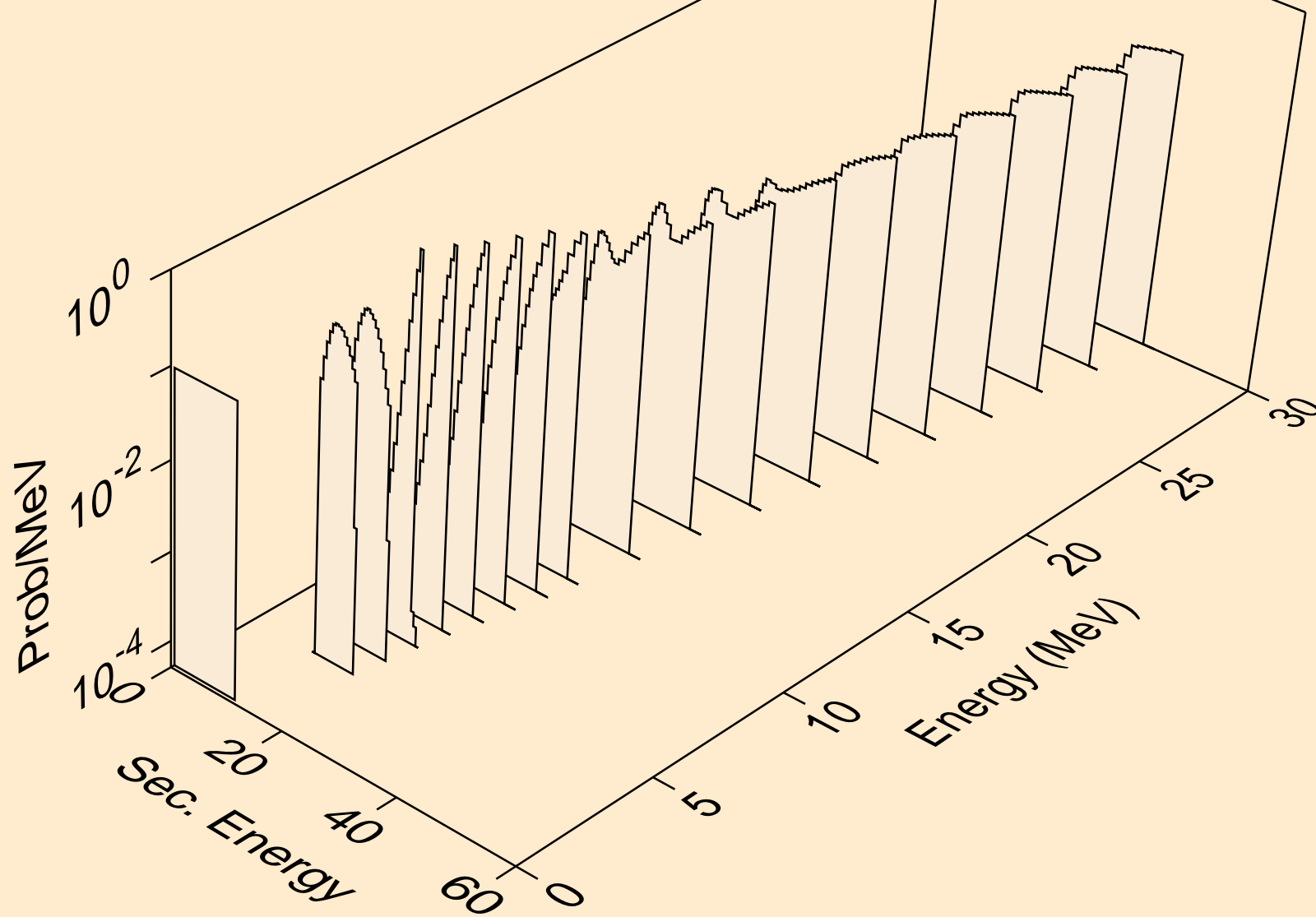

W172 TRITON ACER TENDL-2021 LIBRARY; T=0.K  
alphas from (t,2a)

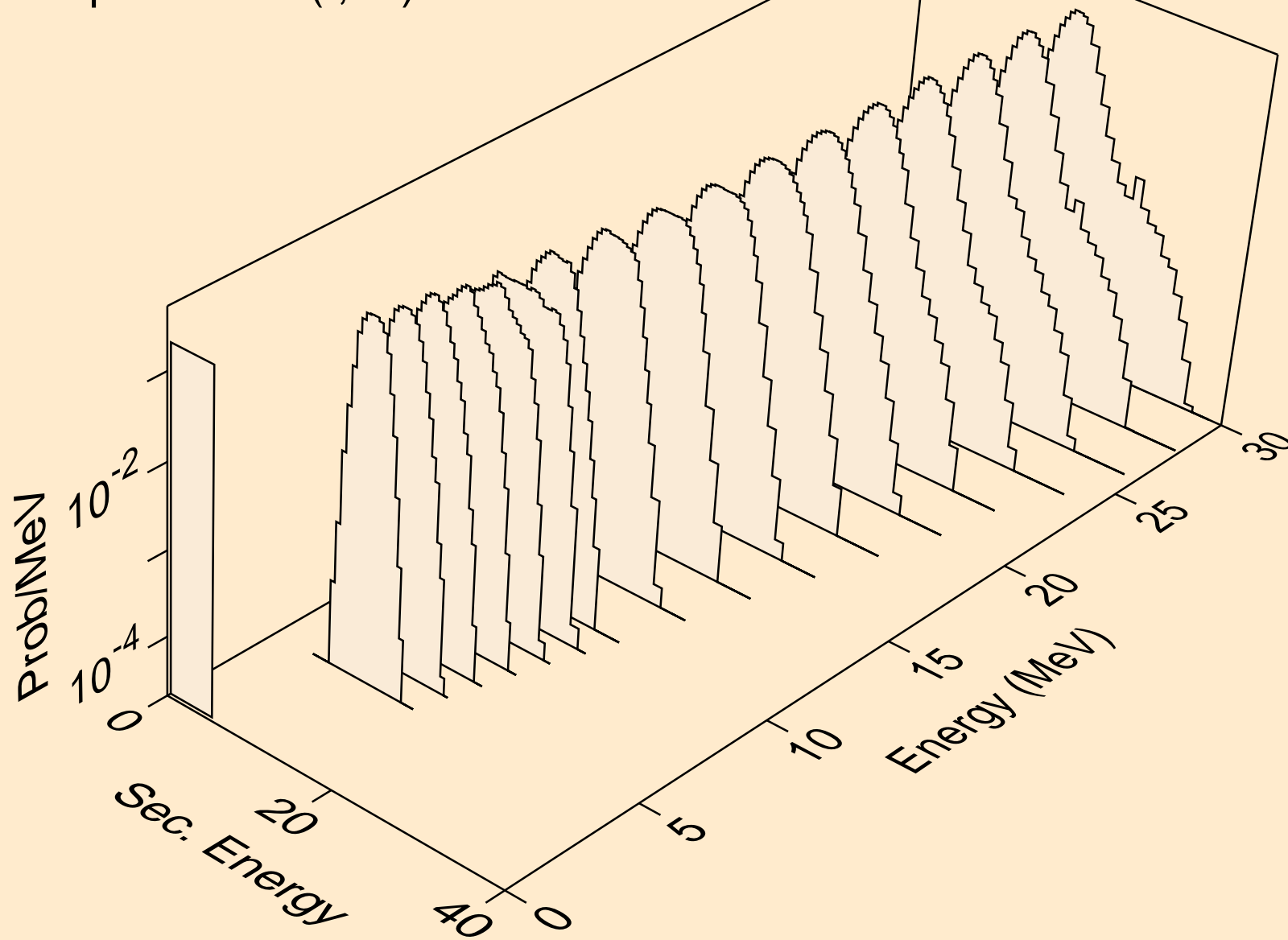

W172 TRITON ACER TENDL-2021 LIBRARY; T=0.K  
alphas from (t,pa)

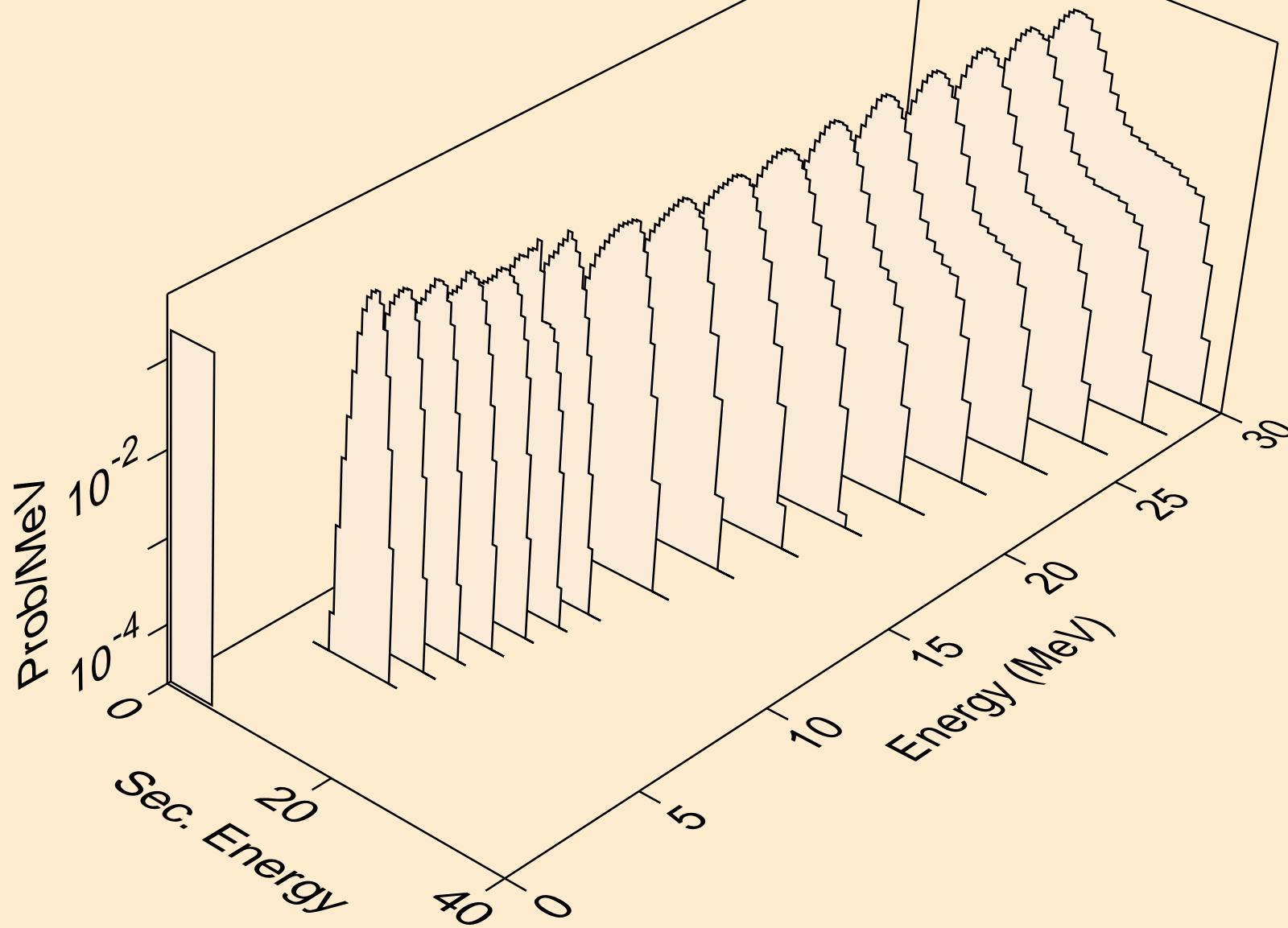



W172 TRITON ACER TENDL-2021 LIBRARY; T=0.K  
alphas from (t,da)

